

Manufacturer	Shenzhen Jinwei Electronics Co., LTD
Address	Room 312, Building 9, No. 399, Guangming Street, Dongzhou Community, Guangming Sub-district, Guangming District, Shenzhen City
Model	TLB-2410-4.6B
Antenna type	external antenna
Antenna Gain	2.00dBi for 2.4G

1. Test equipment and conditions:

1.1. Network Analyzer

Agilent 8753D Agilent 5071B

1.2. Communication test equipment

Agilent E5515C R&S CMW500

1.3. Test system

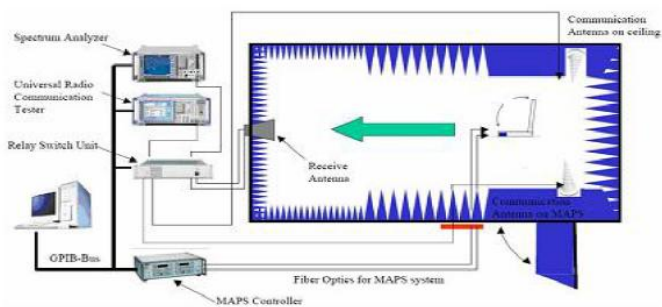

(Testing by 3D anechoic chamber)

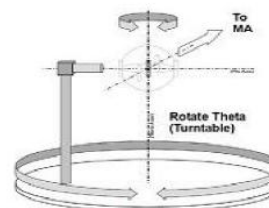
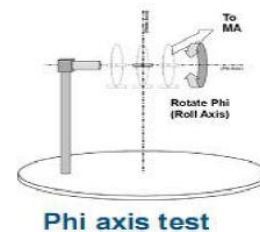

Theta axis test

1.4. Matching circuit

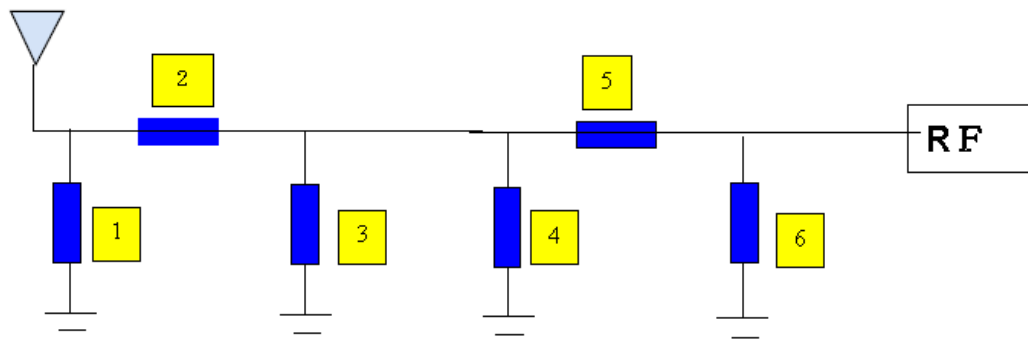

2. Test Data:

2.1. Standing wave ratio

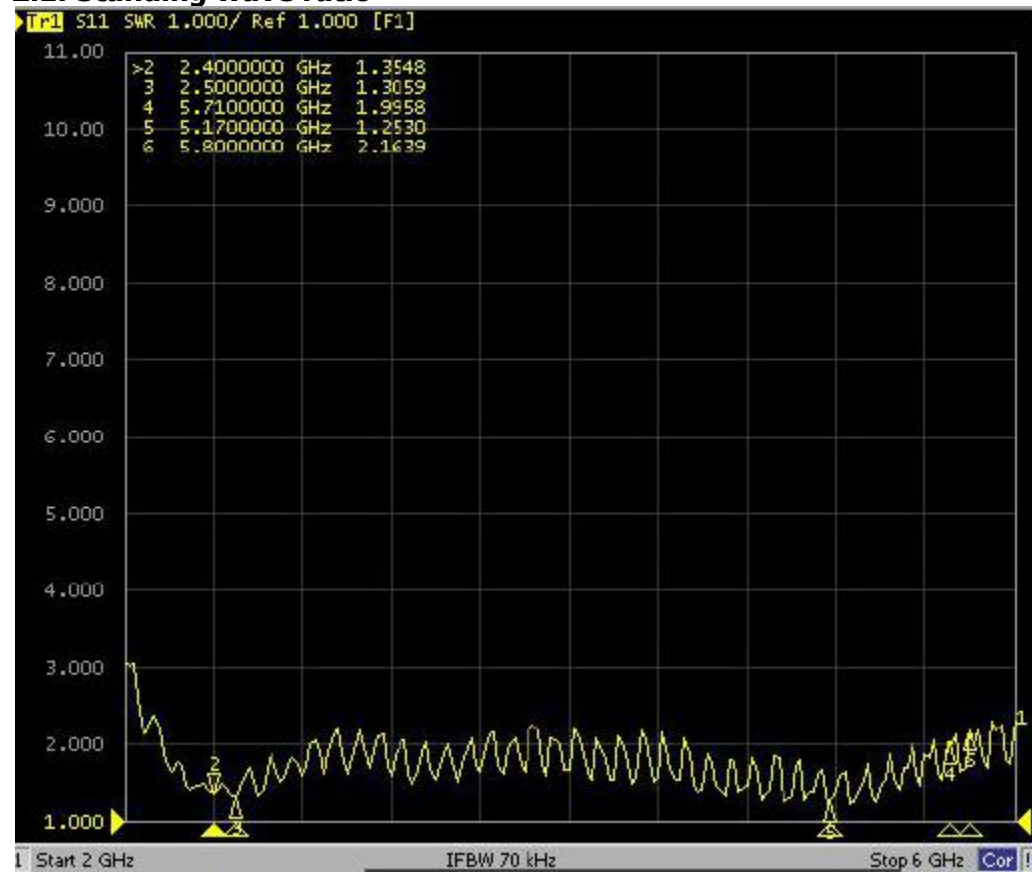

2.2.Efficiency

Fred (MHz)	Effi (%)	Effi (%)	Gain (dBi)
2400	41.07	-2.09	1.63
2410	41.62	-2.50	1.59
2420	41.98	-2.69	1.75
2430	41.81	-2.09	1.38
2440	41.54	-2.34	1.75
2450	41.83	-2.42	1.55
2460	41.15	-2.49	1.69
2470	41.26	-2.88	1.89
2480	41.78	-2.87	1.94
2490	41.05	-2.07	2.00
2500	41.07	-2.09	1.71

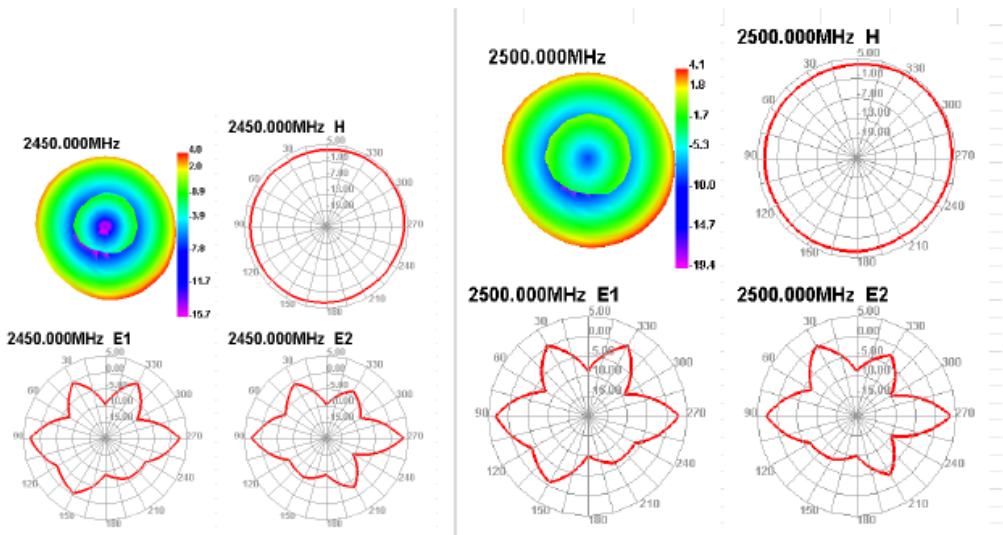
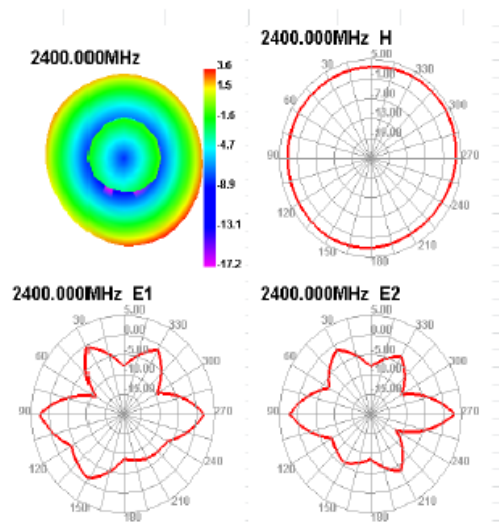

3. Antenna drawing (mm) :

