



FCC TEST REPORT

FCC ID:2BMJ9-JK-B2A24S15P

Report No..... : ZHT-241203139W01

Product..... : Lithium battery protection board

Trademark..... : /

Model(s)..... : JK-B2A24S15P

JK-B2A8S, JK-B2A16S, JK-DZ11B2A24S, JK-DZ08B2A24S, JK-B4A24S, JK-B5A24S, JK-B15A24S, JK-BD4A8S4P, JK-BD4A8S6P, JK-BD4A17S4P, JK-BD4A20S4P, JK-BD4A24S4P, JK-BD4A20S5PG, JK-BD4A20S6PG, JK-BD4A20S6P, JK-BD4A24S6P, JK-BD4A20S8P, JK-BD4A24S8P, JK-BD4A20S10P, JK-BD4A24S10P, JK-BD4A24S10P, JK-BD6A17S6P, JK-BD6A20S6P, JK-BD6A24S6P, JK-BD6A17S8P, JK-BD6A20S8P, JK-BD6A24S8P, JK-BD6A20S10P, JK-BD6A24S10P, JK-BD6A20S12P, JK-BD6A24S12P, JK-BD6A20S15P, JK-BD6A24S15P, JK-BD6A20S20P, JK-BD6A24S20P, JK-B1A20S15P, JK-B1A24S15P, JK-B2A24S15P, JK-B2A20S20P, JK-B2A24S20P, JK-B2A24S30P, JK-B1A8S10P, JK-B1A8S20P, JK-B2A8S20P, JK-QB2A8S20P, JK-B2A8S30P, JK-B2A25SRP, JK-PB1A16S10P, JK-PB1A16S15P, JK-PB2A16S15P, JK-PB2A16S20P

Model Difference..... : JK-B2A24S15P is tested model, other models are derivative models .The models are identical in circuit, only different on the model names. So the test data of JK-B2A24S15P can represent the remaining models.

Applicant..... : Huizhou Qike Technology Co., Ltd.

Address..... : Room 102, 1st Floor, Zhongjin Nanhai Building, No. 13 Danshui Renmin 6th Road, Huiyang District, Huizhou City, Guangdong, 516200, China

Manufacturer..... : Chengdu Jikong Technology Co., Ltd.

Address..... : Room 504, 505, 5th Floor, Building 3, No. 99 Wuke West 4th Road, Wuhou District, Chengdu City, Sichuan, China

Prepared by..... : Guangdong Zhonghan Testing Technology Co., Ltd.

Address..... : Room 104, Building 1, Yibaolai Industrial Park, Qiaotou Community, Fuhai Street, Bao'an District, Shenzhen, Guangdong, China

Date of Receipt..... : Dec. 3, 2024

Date of Test(s)..... : Dec. 3, 2024 to Dec. 4, 2024

Date of Issue..... : Dec. 4, 2024

Standard..... : FCC CFR Title 47 Part 15 Subpart C Section 15.247

Test procedure..... : KDB558074 D01 15.247 Meas Guidance v05r02
ANSI C63.10:2013



In the configuration tested, the EUT complied with the standards specified above.

Tested by:

Reviewed by:

Approved by:

Leon Li

Baret Wu

Levi Lee

Leon Li/ Engineer

Baret Wu/ Director

Levi Lee/ Manager

Note: This device described above has been tested by ZHT, and the test results show that the equipment under test (EUT) is in compliance with the FCC requirements. And it is applicable only to the tested sample identified in the report. This report shall not be reproduced except in full, without the written approval of ZHT, this document may be altered or revised by ZHT, personal only, and shall be noted in the revision of the document.



Table of Contents

Page

1. VERSION 5

2. SUMMARY OF TEST RESULTS 6

3. GENERAL INFORMATION 7

 3.1 GENERAL DESCRIPTION OF EUT 7

 3.2 DESCRIPTION OF TEST MODES 8

 3.3 TEST SETUP CONFIGURATION 8

 3.4 DESCRIPTION OF SUPPORT UNITS(CONDUCTED MODE) 9

4. TEST FACILITY AND TEST INSTRUMENT USED 10

 4.1 TEST FACILITY 10

 4.2 INSTRUMENT LIST FOR ALL TEST ITEMS 10

 4.3 TESTING SOFTWARE 12

5. CHANNEL BANDWIDTH 13

 5.1 CONDUCTED EMISSION MEASUREMENT 13

 5.1.1 POWER LINE CONDUCTED EMISSION Limits 13

 5.1.2 TEST PROCEDURE 13

 5.1.3 DEVIATION FROM TEST STANDARD 13

 5.1.4 TEST SETUP 14

 5.1.5 EUT OPERATING CONDITIONS 14

 5.1.6 TEST RESULTS 14

 5.2 RADIATED EMISSION MEASUREMENT 15

 5.2.1 RADIATED EMISSION LIMITS 15

 5.2.2 TEST PROCEDURE 16

 5.2.3 DEVIATION FROM TEST STANDARD 16

 5.2.4 TEST SETUP 16

 5.2.5 EUT OPERATING CONDITIONS 17

6.RADIATED BAND EMISSION MEASUREMENT 22

 6.1 TEST REQUIREMENT: 22

 6.2 TEST PROCEDURE 22

 6.3 DEVIATION FROM TEST STANDARD 22

 6.4 TEST SETUP 23

 6.5 EUT OPERATING CONDITIONS 23

 6.6 TEST RESULT 24

7.POWER SPECTRAL DENSITY TEST 25

 7.1 APPLIED PROCEDURES / LIMIT 25



Table of Contents

Page

7.2 TEST PROCEDURE	25
7.3 DEVIATION FROM STANDARD	25
7.4 TEST SETUP	25
7.5 EUT OPERATION CONDITIONS	25
7.6 TEST RESULTS	26
8.CHANNEL BANDWIDTH	29
8.1 APPLIED PROCEDURES / LIMIT	29
8.2 TEST PROCEDURE	29
8.3 DEVIATION FROM STANDARD	29
8.4 TEST SETUP	29
8.5 EUT OPERATION CONDITIONS	29
8.6 TEST RESULTS	30
9.PEAK OUTPUT POWER TEST	33
9.1 APPLIED PROCEDURES / LIMIT	33
9.2 TEST PROCEDURE	33
9.3 DEVIATION FROM STANDARD	33
9.4 TEST SETUP	33
8.5 EUT OPERATION CONDITIONS	33
9.6 TEST RESULTS	34
10. CONDUCTED BAND EDGE AND SPURIOUS EMISSION	37
10.1 APPLICABLE STANDARD	37
10.2 TEST PROCEDURE	37
10.3 DEVIATION FROM STANDARD	37
10.4 TEST SETUP	37
10.5 EUT OPERATION CONDITIONS	37
11.ANTENNA REQUIREMENT	45
12. TEST SETUP PHOTO	46
13. EUT CONSTRUCTIONAL DETAILS	46



1. VERSION

Report No.	Version	Description	Approved
ZHT-241203139W01	Rev.01	Initial issue of report	Dec. 4, 2024



2. SUMMARY OF TEST RESULTS

Test procedures according to the technical standards:

FCC Part15 (15.247) , Subpart C			
Standard Section	Test Item	Judgment	Remark
FCC part 15.203/15.247 (b)(4)	Antenna requirement	PASS	
FCC part 15.207	AC Power Line Conducted Emission	N/A	
FCC part 15.247 (b)(3)	Conducted Peak Output Power	PASS	
FCC part 15.247 (a)(2)	Channel Bandwidth	PASS	
FCC part 15.247 (e)	Power Spectral Density	PASS	
FCC part 15.247(d)	Band Edge	PASS	
FCC part 15.205/15.209	Spurious Emission	PASS	

NOTE:

(1) "N/A" denotes test is not applicable in this Test Report



3. GENERAL INFORMATION

3.1 GENERAL DESCRIPTION OF EUT

Product Name:	Lithium battery protection board
Test Model No.:	JK-B2A24S15P
Hardware Version:	V1.0
Software Version:	V1.0
Sample(s) Status:	Engineer sample
Operation Frequency:	2402MHz~2480MHz
Channel Numbers:	40
Channel Separation:	2MHz
Modulation Type:	GFSK
Antenna Type:	PCB antenna
Antenna gain:	1.33dBi
Power supply:	Input: DC 24-100V
Sample Number:	241203139YP-001
Remark: The antenna gain is provided by the customer, if the data provided by the customer is not accurate, Guangdong Zhonghan Testing Technology Co., Ltd. does not assume any responsibility.	

Operation Frequency each of channel							
Channel	Frequency	Channel	Frequency	Channel	Frequency	Channel	Frequency
1	2402 MHz	11	2422 MHz	21	2442 MHz	31	2462 MHz
2	2404 MHz	12	2424 MHz	22	2444 MHz	32	2464 MHz
3	2406 MHz	13	2426 MHz	23	2446 MHz	33	2466 MHz
4	2408 MHz	14	2428 MHz	24	2448 MHz	34	2468 MHz
5	2410 MHz	15	2430 MHz	25	2450 MHz	35	2470 MHz
6	2412 MHz	16	2432 MHz	26	2452 MHz	36	2472 MHz
7	2414 MHz	17	2434 MHz	27	2454 MHz	37	2474 MHz
8	2416 MHz	18	2436 MHz	28	2456 MHz	38	2476 MHz
9	2418 MHz	19	2438 MHz	29	2458 MHz	39	2478 MHz
10	2420 MHz	20	2440 MHz	30	2460 MHz	40	2480 MHz

Note:

In section 15.31(m), regards to the operating frequency range over 10 MHz, the Lowest frequency, the middle frequency, and the highest frequency of channel were selected to perform the test, and the selected channel see below:

Channel	Frequency
The lowest channel	2402MHz
The middle channel	2440MHz
The Highest channel	2480MHz

3.2 DESCRIPTION OF TEST MODES

Transmitting mode	Keep the EUT in continuously transmitting mode
Remark: EUT use new battery during the test, the test voltage was tuned from 85% to 115% of the nominal rated supply voltage, and found that the worst case was under the nominal rated supply condition. So the report just shows that condition's data.	

3.3 TEST SETUP CONFIGURATION

Radiated Emission





3.4 DESCRIPTION OF SUPPORT UNITS(CONDUCTED MODE)

The EUT has been tested as an independent unit together with other necessary accessories or support units. The following support units or accessories were used to form a representative test configuration during the tests.

Item	Equipment	Mfr/Brand	Model/Type No.	Series No.	Note
E-1	DC POWER SUPPLY	Sophpower Electronics Co., Ltd.	DSP100-100	/	AE
E-2	Rechargrgeale Battery	LINQING SHEN GHUANG POWER CO., LTD	6-FM-7	/	AE

Item	Shielded Type	Ferrite Core	Length	Note

Note:

- (1) The support equipment was authorized by Declaration of Confirmation.
- (2) For detachable type I/O cable should be specified the length in cm in 『Length』 column.

**4. TEST FACILITY AND TEST INSTRUMENT USED****4.1 TEST FACILITY**

Guangdong Zhonghan Testing Technology Co., Ltd.
 Add.: Room 104, Building 1, Yibaolai Industrial Park, Qiaotou Community, Fuhai Street, Bao'an District,
 Shenzhen, Guangdong, China

FCC Registration Number:255941
 Designation Number: CN0325
 IC Registered No.: 29832
 CAB identifier: CN0143

4.2 INSTRUMENT LIST FOR ALL TEST ITEMS

Radiation Test Instrument

Item	Equipment	Manufacturer	Model	Serial No.	Last Cal.	Next Cal.
1	Receiver	R&S	ESCI	100874	May 10, 2024	May 09, 2025
2	Loop antenna	EMCI	LAP600	272	May 10, 2024	May 09, 2025
3	Amplifier	Schwarzbeck	BBV 9743 B	00378	May 10, 2024	May 09, 2025
4	Amplifier	Schwarzbeck	BBV 9718 B	00040	May 10, 2024	May 09, 2025
5	Bilog Antenna	Schwarzbeck	VULB9162	00498	May 28, 2024	May 27, 2025
6	Horn Antenna	Schwarzbeck	BBHA9120D	02623	May 16, 2024	May 15, 2025
7	Horn Antenna	A.H.SYSTEMS	SAS574	588	May 10, 2024	May 09, 2025
8	Amplifier	AEROFLEX	100KHz-40GHz	097	May 10, 2024	May 09, 2025
9	Spectrum Analyzer	R&S	FSV40	101413	May 16, 2024	May 15, 2025
10	Spectrum Analyzer	KEYSIGHT	N9020A	MY53420208	May 10, 2024	May 09, 2025
11	WIDBAND RADIO COMMUNICATION TESTER	R&S	CMW500	109863	May 10, 2024	May 09, 2025
12	Single Generator	Agilent	N5182A	MY48180575	May 10, 2024	May 09, 2025
13	Power Sensor	MWRftest	MW100-RFCB	/	May 10, 2024	May 09, 2025
14	CABLE	EMToni	DA800-NM-NM-11000MM	/	May 10, 2024	May 09, 2025



Conduction Test Instrument

Equipment	Manufacturer	Model	Serial No.	Last Cal.	Next Cal.
Receiver	R&S	ESCI	100874	May 10, 2024	May 09, 2025
LISN	R&S	ENV216	102794	May 10, 2024	May 09, 2025
ISN CAT 6	Schwarzbeck	NTFM 8158	00318	May 10, 2024	May 09, 2025
ISN CAT 5	Schwarzbeck	CAT5 8158	00343	May 10, 2024	May 09, 2025
Capacitive Voltage Probe	Schwarzbeck	CVP 9222 C	00101	May 10, 2024	May 09, 2025
Current Transformer Clamp	Schwarzbeck	SW 9605	SW9605 #209	May 10, 2024	May 09, 2025
CABLE	EMToni	G223-NM-BNCM -2000MM	/	May 10, 2024	May 09, 2025

Conducted Test Instrument

Item	Equipment	Manufacturer	Model	Serial No.	Last Cal.	Next Cal.
1	Spectrum Analyzer	R&S	FSV40	101413	May 10, 2024	May 09, 2025
2	Spectrum Analyzer	KEYSIGHT	N9020A	MY53420208	May 10, 2024	May 09, 2025
3	Power Sensor	MWRFTest	MW100-RFCB	/	May 10, 2024	May 09, 2025



4.3 TESTING SOFTWARE

Project	Software name	Edition
Radiated Emission	EZ-EMC	FA-03A2 RE+
RF Test	MTS 8310	2.0.0.0

4.3 MEASUREMENT UNCERTAINTY

The reported uncertainty of measurement $y \pm U$, where expanded uncertainty U is based on a standard uncertainty multiplied by a coverage factor of $k=2$, providing a level of confidence of approximately 95 % .

No.	Item	Uncertainty
1	Conducted Emission Test	$\pm 1.38\text{dB}$
2	RF conducted power	$\pm 0.16\text{dB}$
3	Spurious emissions conducted	$\pm 0.21\text{dB}$
4	All radiated emissions (9k-30MHz)	$\pm 4.68\text{dB}$
5	All radiated emissions (<1G)	$\pm 4.68\text{dB}$
6	All radiated emissions (>1G)	$\pm 4.89\text{dB}$
7	Temperature	$\pm 0.5^\circ\text{C}$
8	Humidity	$\pm 2\%$
9	Occupied Bandwidth	$\pm 4.96\%$

Decision Rule

- Uncertainty is not included
- Uncertainty is included

5. CHANNEL BANDWIDTH

5.1 CONDUCTED EMISSION MEASUREMENT

Test Requirement:	FCC Part15 C Section 15.207
Test Method:	ANSI C63.10:2013
Test Frequency Range:	150KHz to 30MHz
Receiver setup:	RBW=9KHz, VBW=30KHz, Sweep time=auto

5.1.1 POWER LINE CONDUCTED EMISSION Limits

FREQUENCY (MHz)	Limit (dBuV)		Standard
	QP	AVG	
0.15 -0.5	66 - 56 *	56 - 46 *	FCC
0.50 -5.0	56.00	46.00	FCC
5.0 -30.0	60.00	50.00	FCC

Note:

(1) *Decreases with the logarithm of the frequency.

5.1.2 TEST PROCEDURE

- The EUT was placed 0.8 meters from the horizontal ground plane with EUT being connected to the power mains through a line impedance stabilization network (LISN). All other support equipments powered from additional LISN(s). The LISN provide 50 Ohm/ 50uH of coupling impedance for the measuring instrument.
- Interconnecting cables that hang closer than 40 cm to the ground plane shall be folded back and forth in the center forming a bundle 30 to 40 cm long.
- I/O cables that are not connected to a peripheral shall be bundled in the center. The end of the cable may be terminated, if required, using the correct terminating impedance. The overall length shall not exceed 1 m.
- LISN at least 80 cm from nearest part of EUT chassis.
- For the actual test configuration, please refer to the related Item –EUT Test Photos.

5.1.3 DEVIATION FROM TEST STANDARD

No deviation

5.1.4 TEST SETUP

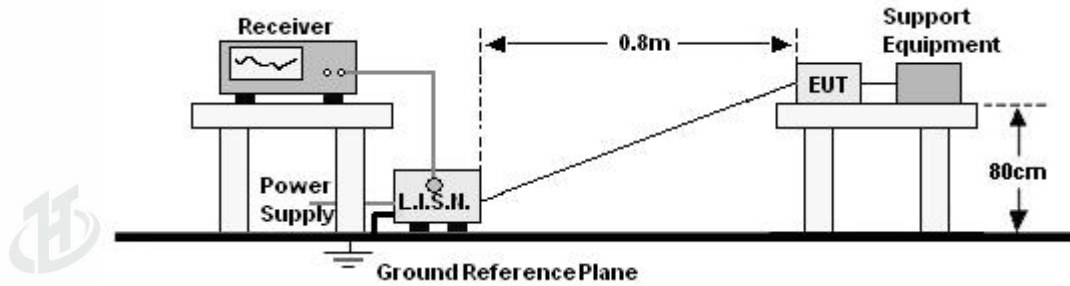

5.1.5 EUT OPERATING CONDITIONS

The EUT was configured for testing in a typical fashion (as a customer would normally use it). The EUT has been programmed to continuously transmit during test. This operating condition was tested and used to collect the included data.

5.1.6 TEST RESULTS

N/A

The EUT is powered by the DC only, the test item is not applicable.



5.2 RADIATED EMISSION MEASUREMENT

Test Requirement:	FCC Part15 C Section 15.209				
Test Method:	ANSI C63.10:2013				
Test Frequency Range:	9kHz to 25GHz				
Test site:	Measurement Distance: 3m				
Receiver setup:	Frequency	Detector	RBW	VBW	Value
	9KHz-150KHz	Quasi-peak	200Hz	600Hz	Quasi-peak
	150KHz-30MHz	Quasi-peak	9KHz	30KHz	Quasi-peak
	30MHz-1GHz	Quasi-peak	100KHz	300KHz	Quasi-peak
	Above 1GHz	Peak	1MHz	3MHz	Peak
Peak		1MHz	10Hz	Average	

5.2.1 RADIATED EMISSION LIMITS

Frequencies (MHz)	Field Strength (micровolts/meter)	Measurement Distance (meters)
0.009~0.490	2400/F(KHz)	300
0.490~1.705	24000/F(KHz)	30
1.705~30.0	30	30
30~88	100	3
88~216	150	3
216~960	200	3
Above 960	500	3

LIMITS OF RADIATED EMISSION MEASUREMENT

FREQUENCY (MHz)	Limit (dBuV/m) (at 3M)	
	PEAK	AVERAGE
Above 1000	74	54

Notes:

- (1) The limit for radiated test was performed according to FCC PART 15C.
- (2) The tighter limit applies at the band edges.
- (3) Emission level (dBuV/m)=20log Emission level (uV/m).

5.2.2 TEST PROCEDURE

- a. The measuring distance of at 3 m shall be used for measurements at frequency up to 25GHz. For frequencies above 1GHz, any suitable measuring distance may be used.
- b. The EUT was placed on the top of a rotating table 0.8 meters above the ground at a 3 meter semi-chamber test. The table was rotated 360 degrees to determine the position of the highest radiation.
- c. The height of the equipment or of the substitution antenna shall be 0.8m; above 1GHz, the height was 1.5m, the height of the test antenna shall vary between 1 m to 4 m. Both horizontal and vertical polarizations of the antenna are set to make the measurement.
- d. The initial step in collecting conducted emission data is a spectrum analyzer peak detector mode pre-scanning the measurement frequency range. Significant peaks are then marked and then Quasi Peak detector mode re-measured.
- e. If the Peak Mode measured value compliance with and lower than Quasi Peak Mode Limit, the EUT shall be deemed to meet QP Limits and then no additional QP Mode measurement performed.
- f. For the actual test configuration, please refer to the related Item –EUT Test Photos.
- g. For the radiated emission test above 1GHz:
Place the measurement antenna away from each area of the EUT determined to be a source of emissions at the specified measurement distance, while keeping the measurement antenna aimed at the source of emissions at each frequency of significant emissions, with polarization oriented for maximum response.

The measurement antenna may have to be higher or lower than the EUT, depending on the radiation pattern of the emission and staying aimed at the emission source for receiving the maximum signal. The final measurement antenna elevation shall be that which maximizes the emissions. The measurement antenna elevation for maximum emissions shall be restricted to a range of heights of from 1 m to 4 m above the ground or reference ground plane.

Note:

Both horizontal and vertical antenna polarities were tested and performed pretest to three orthogonal axis. The worst case emissions were reported

5.2.3 DEVIATION FROM TEST STANDARD

No deviation

5.2.4 TEST SETUP

(A) Radiated Emission Test-Up Frequency Below 30MHz

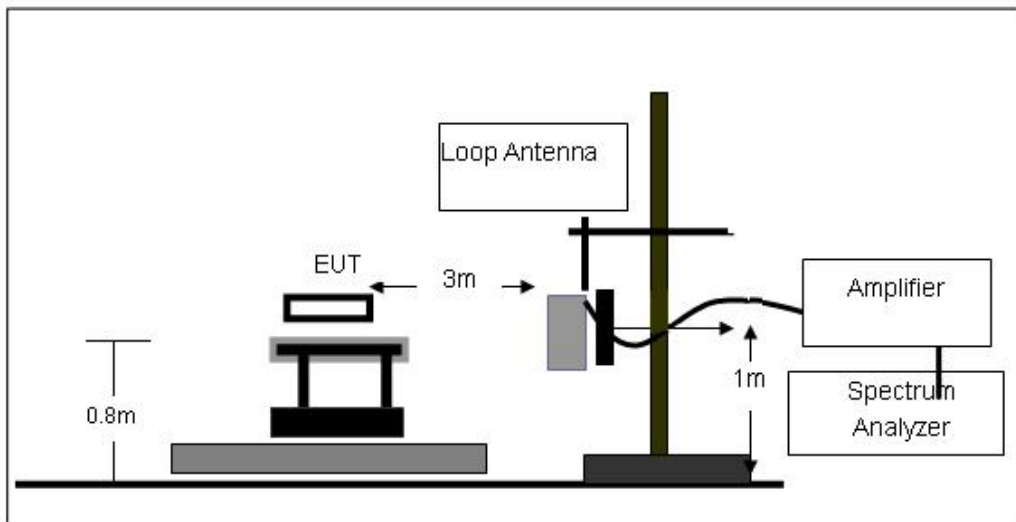

(B) Radiated Emission Test-Up Frequency 30MHz~1GHz

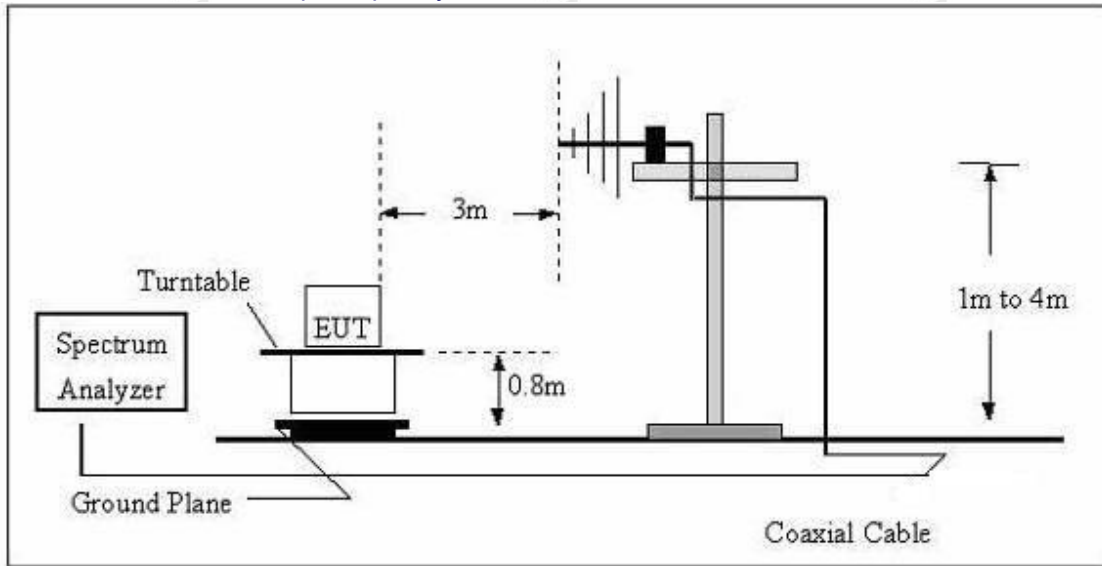

(C) Radiated Emission Test-Up Frequency Above 1GHz

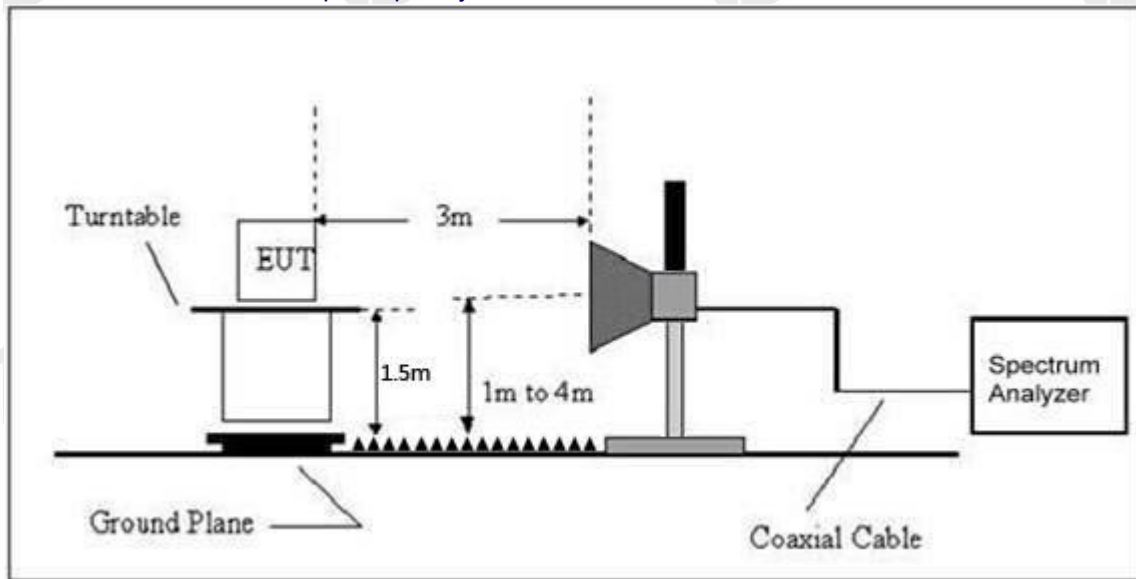

5.2.5 EUT OPERATING CONDITIONS

The EUT was configured for testing in a typical fashion (as a customer would normally use it). The EUT has been programmed to continuously transmit during test. This operating condition was tested and used to collect the included data.

5.2.6 TEST RESULTS (Between 9KHz – 30 MHz)

The emission from 9 kHz to 30MHz was pre-tested and found the result was 20dB lower than the limit, and according to 15.31(o) & RSS-Gen 6.13, the test result no need to reported.



Between 30MHz – 1GHz

Temperature:	25.2°C	Relative Humidity:	50%
Pressure:	1010kPa	Polarization:	Horizontal
Test Voltage:	DC 24V		

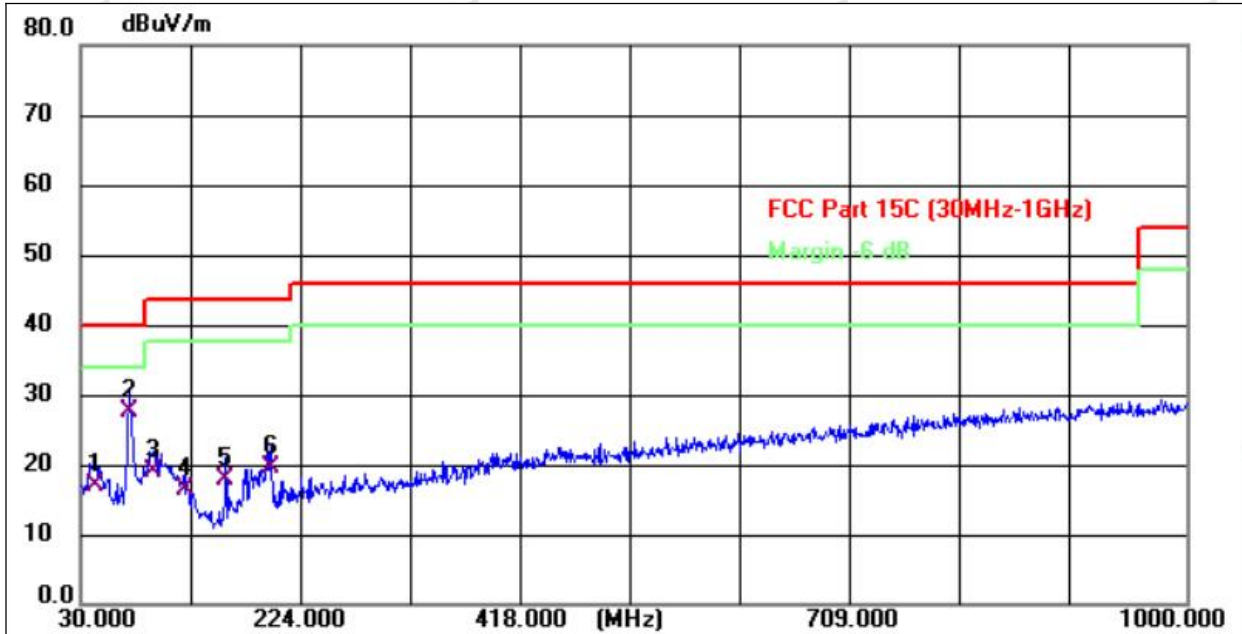

No.	Frequency (MHz)	Reading (dBuV)	Factor (dB/m)	Level (dBuV/m)	Limit (dBuV/m)	Margin (dB)	Detector
1	43.580	25.97	-8.84	17.13	40.00	-22.87	QP
2 *	73.650	41.18	-13.71	27.47	40.00	-12.53	QP
3	94.020	31.16	-12.19	18.97	43.50	-24.53	QP
4	121.180	29.43	-12.96	16.47	43.50	-27.03	QP
5	157.070	31.67	-13.76	17.91	43.50	-25.59	QP
6	196.840	31.06	-11.37	19.69	43.50	-23.81	QP



Temperature:	25.2°C	Relative Humidity:	50%
Pressure:	1010kPa	Polarization:	Vertical
Test Voltage:	DC 24V		

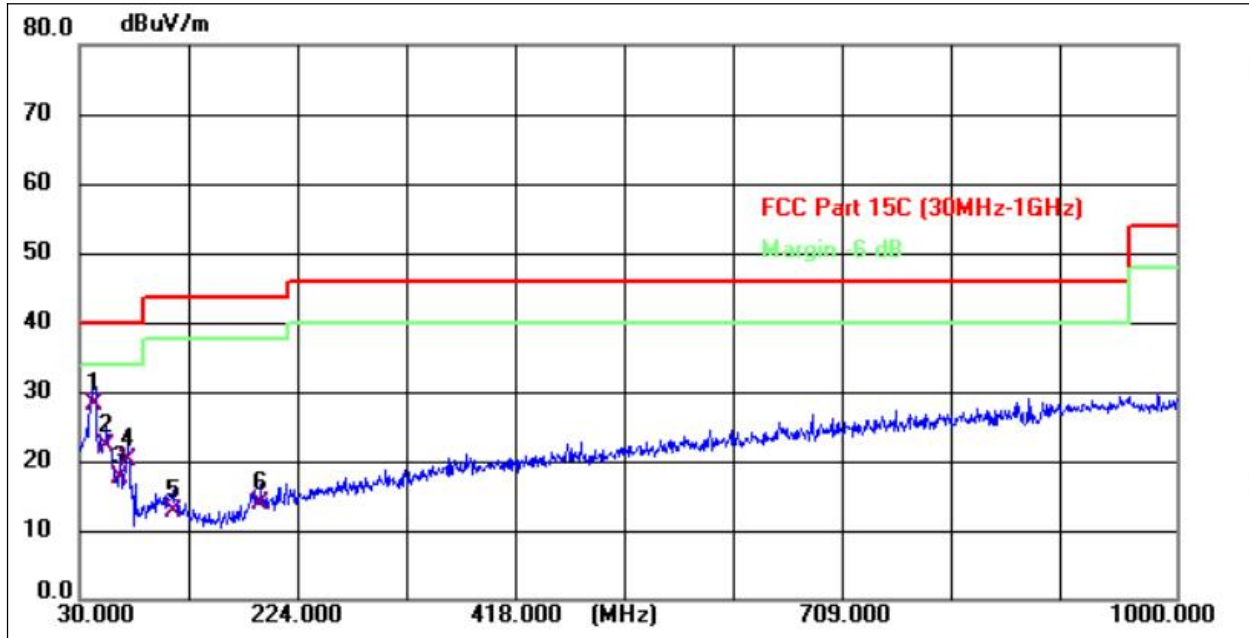

No.	Frequency (MHz)	Reading (dBuV)	Factor (dB/m)	Level (dBuV/m)	Limit (dBuV/m)	Margin (dB)	Detector
1 *	43.580	37.12	-8.84	28.28	40.00	-11.72	QP
2	54.250	32.02	-9.92	22.10	40.00	-17.90	QP
3	65.890	29.89	-12.24	17.65	40.00	-22.35	QP
4	73.650	33.97	-13.71	20.26	40.00	-19.74	QP
5	112.450	25.02	-12.29	12.73	43.50	-30.77	QP
6	191.020	25.57	-11.75	13.82	43.50	-29.68	QP

Remarks:

1. Final Level = Receiver Read level + Antenna Factor + Cable Loss
2. The emission levels of other frequencies are very lower than the limit and not show in test report.
3. The test data shows only the worst case GFSK mode (Middle Channel: 2440MHz).



1GHz~25GHz

Polar (H/V)	Frequency	Meter Reading	Pre-amplifier	Cable Loss	Antenna Factor	Emission Level	Limits	Margin	Detector Type
	(MHz)	(dBuV)	(dB)	(dB)	(dB/m)	(dBuV/m)	(dBuV/m)	(dB)	
GFSK									
Low Channel:2402MHz									
V	4804.00	55.97	30.55	5.77	24.66	55.85	74	-18.15	Pk
V	4804.00	41.29	30.55	5.77	24.66	41.17	54	-12.83	AV
V	7206.00	57.3	30.33	6.32	24.55	57.84	74	-16.16	Pk
V	7206.00	41.78	30.33	6.32	24.55	42.32	54	-11.68	AV
V	9608.00	58	30.55	5.77	24.66	57.88	74	-16.12	Pk
V	9608.00	41.85	30.55	5.77	24.66	41.73	54	-12.27	AV
V	12010.00	58.43	30.33	6.32	24.55	58.97	74	-15.03	Pk
V	12010.00	42.4	30.33	6.32	24.55	42.94	54	-11.06	AV
H	4804.00	58.62	30.55	5.77	24.66	58.5	74	-15.5	Pk
H	4804.00	41.2	30.55	5.77	24.66	41.08	54	-12.92	AV
H	7206.00	56.98	30.33	6.32	24.55	57.52	74	-16.48	Pk
H	7206.00	41.26	30.33	6.32	24.55	41.8	54	-12.2	AV
H	9608.00	57.37	30.55	5.77	24.66	57.25	74	-16.75	Pk
H	9608.00	41.1	30.55	5.77	24.66	40.98	54	-13.02	AV
H	12010.00	59.33	30.33	6.32	24.55	59.87	74	-14.13	Pk
H	12010.00	41.14	30.33	6.32	24.55	41.68	54	-12.32	AV

Polar (H/V)	Frequency	Meter Reading	Pre-amplifier	Cable Loss	Antenna Factor	Emission Level	Limits	Margin	Detector Type
	(MHz)	(dBuV)	(dB)	(dB)	(dB/m)	(dBuV/m)	(dBuV/m)	(dB)	
GFSK									
Middle Channel:2440MHz									
V	4880.00	55.63	30.55	5.77	24.66	55.51	74	-18.49	Pk
V	4880.00	41.99	30.55	5.77	24.66	41.87	54	-12.13	AV
V	7320.00	56.46	30.33	6.32	24.55	57	74	-17	Pk
V	7320.00	43.72	30.33	6.32	24.55	44.26	54	-9.74	AV
V	9760.00	55.6	30.55	5.77	24.66	55.48	74	-18.52	Pk
V	9760.00	43.57	30.55	5.77	24.66	43.45	54	-10.55	AV
V	12200.00	59.33	30.33	6.32	24.55	59.87	74	-14.13	Pk
V	12200.00	41.49	30.33	6.32	24.55	42.03	54	-11.97	AV
H	4880.00	56.89	30.55	5.77	24.66	56.77	74	-17.23	Pk
H	4880.00	42.83	30.55	5.77	24.66	42.71	54	-11.29	AV
H	7320.00	56.08	30.33	6.32	24.55	56.62	74	-17.38	Pk
H	7320.00	44.93	30.33	6.32	24.55	45.47	54	-8.53	AV
H	9760.00	57.72	30.55	5.77	24.66	57.6	74	-16.4	Pk
H	976000	41.42	30.55	5.77	24.66	41.3	54	-12.7	AV
H	12200.00	57.39	30.33	6.32	24.55	57.93	74	-16.07	Pk
H	12200.00	44.71	30.33	6.32	24.55	45.25	54	-8.75	AV



Polar (H/V)	Frequency	Meter Reading	Pre-amplifier	Cable Loss	Antenna Factor	Emission Level	Limits	Margin	Detector Type
	(MHz)	(dBuV)	(dB)	(dB)	(dB/m)	(dBuV/m)	(dBuV/m)	(dB)	
GFSK									
High Channel:2480MHz									
V	4960.00	56.25	30.55	5.77	24.66	56.13	74	-17.87	Pk
V	4960.00	41.81	30.55	5.77	24.66	41.69	54	-12.31	AV
V	7440.00	57.3	30.33	6.32	24.55	57.84	74	-16.16	Pk
V	7440.00	41.85	30.33	6.32	24.55	42.39	54	-11.61	AV
V	9920.00	57.06	30.55	5.77	24.66	56.94	74	-17.06	Pk
V	9920.00	41.84	30.55	5.77	24.66	41.72	54	-12.28	AV
V	12400.00	56.69	30.33	6.32	24.55	57.23	74	-16.77	Pk
V	12400.00	41.34	30.33	6.32	24.55	41.88	54	-12.12	AV
H	4960.00	55.1	30.55	5.77	24.66	54.98	74	-19.02	Pk
H	4960.00	41.64	30.55	5.77	24.66	41.52	54	-12.48	AV
H	7440.00	56.32	30.33	6.32	24.55	56.86	74	-17.14	Pk
H	7440.00	42.81	30.33	6.32	24.55	43.35	54	-10.65	AV
H	9920.00	55.96	30.55	5.77	24.66	55.84	74	-18.16	Pk
H	9920.00	41.66	30.55	5.77	24.66	41.54	54	-12.46	AV
H	12400.00	55.5	30.33	6.32	24.55	56.04	74	-17.96	Pk
H	12400.00	44.57	30.33	6.32	24.55	45.11	54	-8.89	AV

Remark:

1. Emission Level = Meter Reading + Antenna Factor + Cable Loss – Pre-amplifier, Margin= Emission Level - Limit
2. If peak below the average limit, the average emission was no test.
3. The amplitude of spurious emissions which are attenuated by more than 20dB below the permissible value has no need to be reported.



6.RADIATED BAND EMISSION MEASUREMENT

6.1 TEST REQUIREMENT:

Test Requirement:	FCC Part15 C Section 15.209 and 15.205				
Test Method:	ANSI C63.10: 2013				
Test Frequency Range:	All of the restrict bands were tested, only the worst band's (2310MHz to 2500MHz) data was showed.				
Test site:	Measurement Distance: 3m				
Receiver setup:	Frequency	Detector	RBW	VBW	Value
	Above 1GHz	Peak	1MHz	3MHz	Peak
		Average	1MHz	3MHz	Average

LIMITS OF RADIATED EMISSION MEASUREMENT (Above 1000MHz)

FREQUENCY (MHz)	Limit (dBuV/m) (at 3M)	
	PEAK	AVERAGE
Above 1000	74	54

Notes:

- (1) The limit for radiated test was performed according to FCC PART 15C.
- (2) The tighter limit applies at the band edges.
- (3) Emission level (dBuV/m)=20log Emission level (uV/m).

6.2 TEST PROCEDURE

Above 1GHz test procedure as below:

- a. 1. The EUT was placed on the top of a rotating table 1.5 meters above the ground at a 3 meter camber. The table was rotated 360 degrees to determine the position of the highest radiation.
- b. The EUT was set 3 meters away from the interference-receiving antenna, which was mounted on the top of a variable-height antenna tower.
- c. The antenna height is varied from one meter to four meters above the ground to determine the maximum value of the field strength. Both horizontal and vertical polarizations of the antenna are set to make the measurement.
- d. For each suspected emission, the EUT was arranged to its worst case and then the antenna was tuned to heights from 1 meter to 4 meters and the rota table was turned from 0 degrees to 360 degrees to find the maximum reading.
- e. The test-receiver system was set to Peak Detect Function and Specified Bandwidth with Maximum Hold Mode.
- f. If the emission level of the EUT in peak mode was 10dB lower than the limit specified, then testing could be stopped and the peak values of the EUT would be reported. Otherwise the emissions that did not have 10dB margin would be re-tested one by one using peak, quasi-peak or average method as specified and then reported in a data sheet.
- g. Test the EUT in the lowest channel,the Highest channel

Note:

Both horizontal and vertical antenna polarities were tested and performed pretest to three orthogonal axis. The worst case emissions were reported

6.3 DEVIATION FROM TEST STANDARD

No deviation

6.4 TEST SETUP

Radiated Emission Test-Up Frequency Above 1GHz

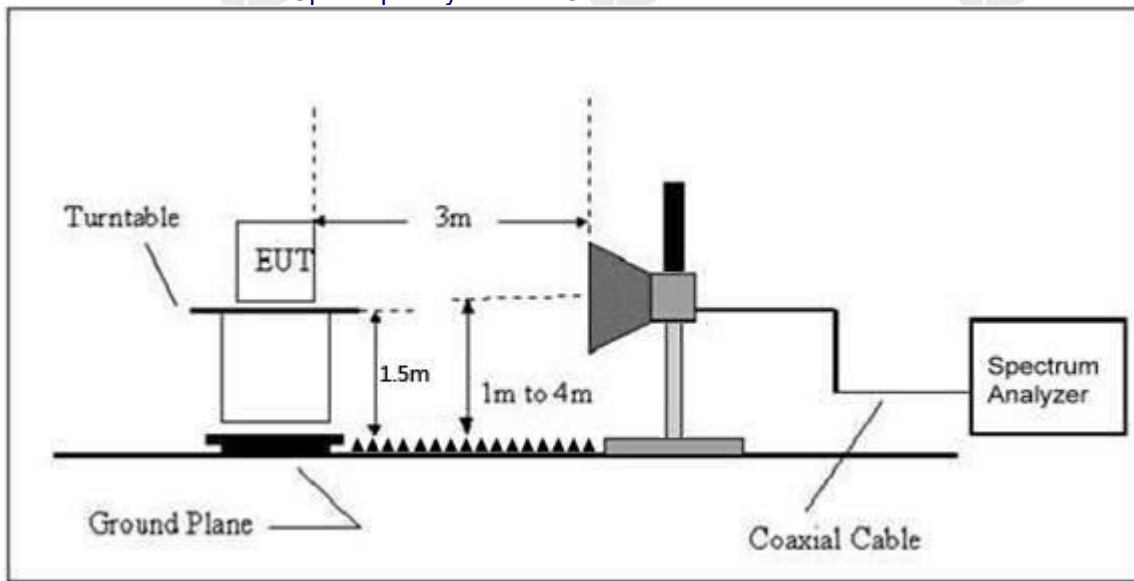

6.5 EUT OPERATING CONDITIONS

The EUT tested system was configured as the statements of 2.3 Unless otherwise a special operating condition is specified in the follows during the testing.



6.6 TEST RESULT

	Polar (H/V)	Frequency (MHz)	Meter Reading (dBuV)	Pre-amplifier (dB)	Cable Loss (dB)	Antenna Factor (dB/m)	Emission level (dBuV/m)	Limit (dBuV/m)	Margin (dB)	Detector Type	Result
GFSK	Low Channel: 2402MHz										
	H	2390.00	60.49	30.22	4.85	23.98	59.10	74.00	-14.90	PK	PASS
	H	2390.00	46.83	30.22	4.85	23.98	45.44	54.00	-8.56	AV	PASS
	H	2400.00	61.74	30.22	4.85	23.98	60.35	74.00	-13.65	PK	PASS
	H	2400.00	46.87	30.22	4.85	23.98	45.48	54.00	-8.52	AV	PASS
	V	2390.00	60.37	30.22	4.85	23.98	58.98	74.00	-15.02	PK	PASS
	V	2390.00	47.77	30.22	4.85	23.98	46.38	54.00	-7.62	AV	PASS
	V	2400.00	61.76	30.22	4.85	23.98	60.37	74.00	-13.63	PK	PASS
	V	2400.00	47.91	30.22	4.85	23.98	46.52	54.00	-7.48	AV	PASS
	High Channel: 2480MHz										
	H	2483.50	59.71	30.22	4.85	23.98	58.32	74.00	-15.68	PK	PASS
	H	2483.50	46.95	30.22	4.85	23.98	45.56	54.00	-8.44	AV	PASS
	H	2500.00	61.64	30.22	4.85	23.98	60.25	74.00	-13.75	PK	PASS
	H	2500.00	46.32	30.22	4.85	23.98	44.93	54.00	-9.07	AV	PASS
	V	2483.50	61.69	30.22	4.85	23.98	60.30	74.00	-13.70	PK	PASS
	V	2483.50	47.12	30.22	4.85	23.98	45.73	54.00	-8.27	AV	PASS
	V	2500.00	61.27	30.22	4.85	23.98	59.88	74.00	-14.12	PK	PASS
	V	2500.00	48.74	30.22	4.85	23.98	47.35	54.00	-6.65	AV	PASS
Remark:											
1. Emission Level = Meter Reading + Antenna Factor + Cable Loss – Pre-amplifier, Margin= Emission Level - Limit											



7.POWER SPECTRAL DENSITY TEST

Test Requirement:	FCC Part15 C Section 15.247 (e)
Test Method:	KDB558074 D0115.247 Meas Guidance v05r02

7.1 APPLIED PROCEDURES / LIMIT

FCC Part15 (15.247) , Subpart C				
Section	Test Item	Limit	Frequency Range (MHz)	Result
15.247	Power Spectral Density	8dBm/3kHz	2400-2483.5	PASS

7.2 TEST PROCEDURE

1. Set analyzer center frequency to DTS channel center frequency.
2. Set the span to 1.5 times the DTS bandwidth.
3. Set the RBW to: $3\text{ kHz} \leq \text{RBW} \leq 100\text{ kHz}$.
4. Set the VBW $\geq 3 \times \text{RBW}$.
5. Detector = peak.
6. Sweep time = auto couple.
7. Trace mode = max hold.
8. Allow trace to fully stabilize.
9. Use the peak marker function to determine the maximum amplitude level within the RBW.
10. If measured value exceeds limit, reduce RBW (no less than 3 kHz) and repeat.

7.3 DEVIATION FROM STANDARD

No deviation.

7.4 TEST SETUP



7.5 EUT OPERATION CONDITIONS

The EUT tested system was configured as the statements of 2.1 Unless otherwise a special operating condition is specified in the follows during the testing.



7.6 TEST RESULTS

Temperature :	25.6°C	Relative Humidity :	51%
Test Mode :	GFSK	Test Voltage :	DC 24V

Modulation	Frequency	Power Spectral Density (dBm/3kHz)	Limit (8dBm/3kHz)	Result
GFSK	2402 MHz	-15.39	8	PASS
	2440 MHz	-15.24	8	PASS
	2480 MHz	-15.56	8	PASS

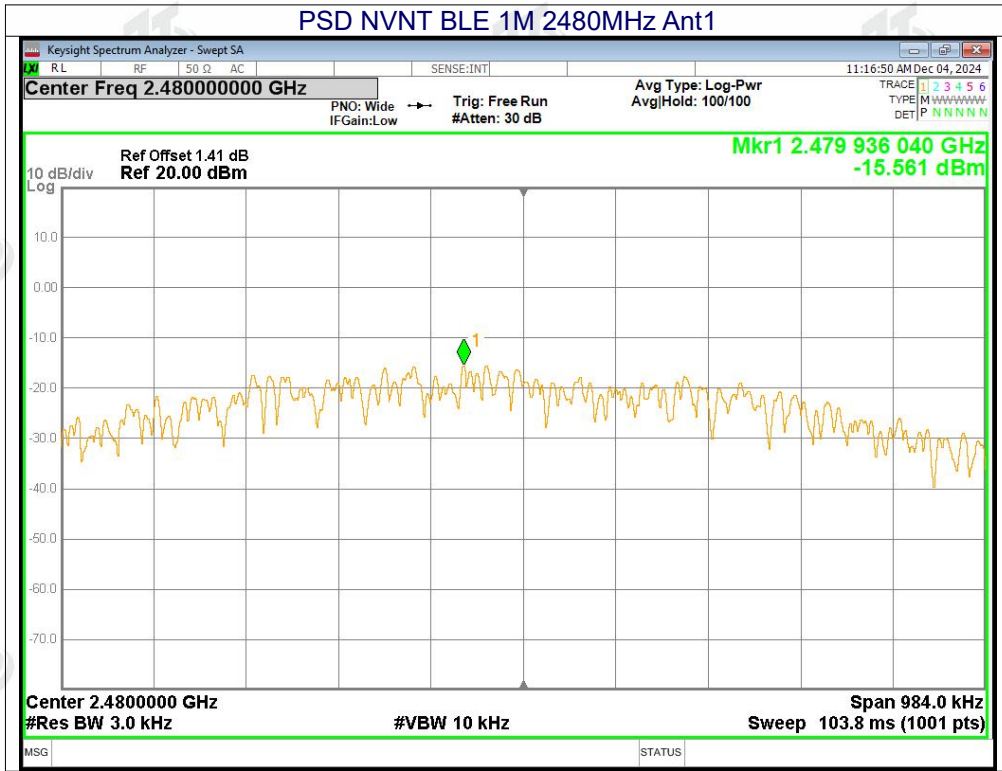



8.CHANNEL BANDWIDTH

Test Requirement:	FCC Part15 C Section 15.247 (a)(2)
Test Method:	KDB558074 D0115.247 Meas Guidance v05r02

8.1 APPLIED PROCEDURES / LIMIT

FCC Part15 (15.247) , Subpart C				
Section	Test Item	Limit	Frequency Range (MHz)	Result
15.247(a)(2)	Bandwidth	>= 500KHz (6dB bandwidth)	2400-2483.5	PASS

8.2 TEST PROCEDURE

1. Set RBW = 100 kHz.
2. Set the video bandwidth (VBW) ≥ 3 x RBW.
3. Detector = Peak.
4. Trace mode = max hold.
5. Sweep = auto couple.
6. Allow the trace to stabilize.
7. Measure the maximum width of the emission that is constrained by the frequencies associated with the two outermost amplitude points (upper and lower frequencies) that are attenuated by 6 dB relative to the maximum level measured in the fundamental emission.

8.3 DEVIATION FROM STANDARD

No deviation.

8.4 TEST SETUP

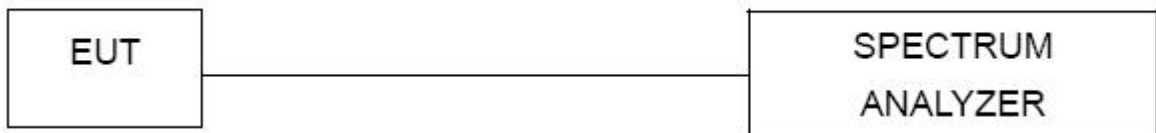

8.5 EUT OPERATION CONDITIONS

The EUT tested system was configured as the statements of 2.4 Unless otherwise a special operating condition is specified in the follows during the testing.



8.6 TEST RESULTS

Temperature :	25.6°C	Relative Humidity :	51%
Test Mode :	GFSK	Test Voltage :	DC 24V

Modulation	Test channel	Channel Bandwidth (MHz)	Limit(KHz)	Result
GFSK	Lowest	0.655	>= 500	Pass
	Middle	0.653		
	Highest	0.656		



Test Graphs

-6dB Bandwidth NVNT BLE 1M 2402MHz Ant1

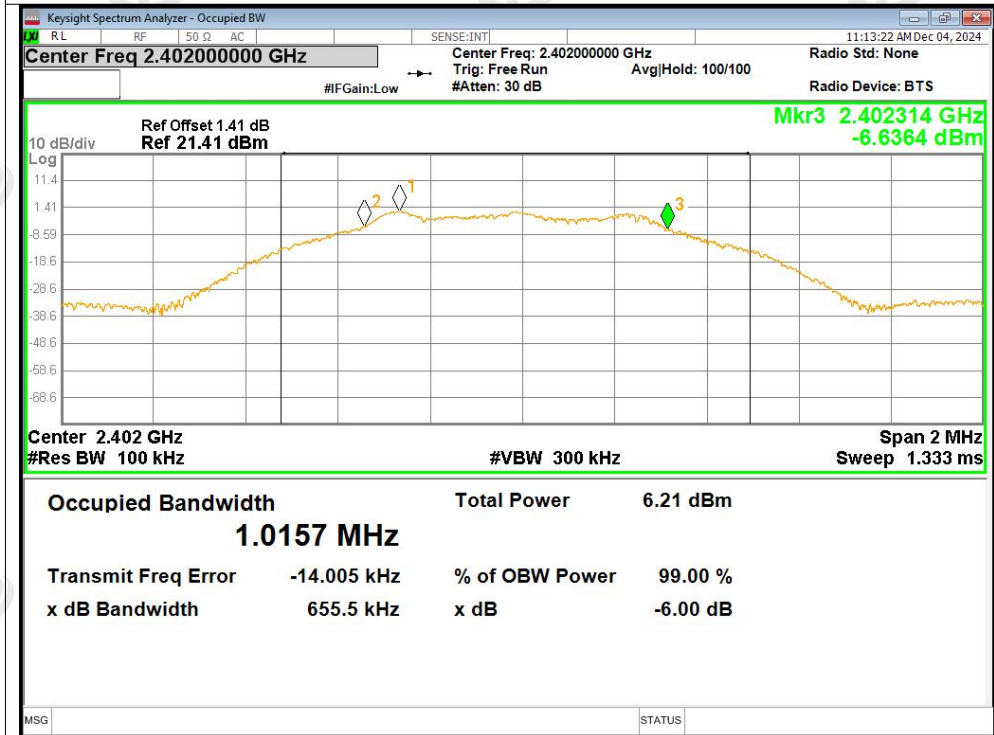

-6dB Bandwidth NVNT BLE 1M 2440MHz Ant1



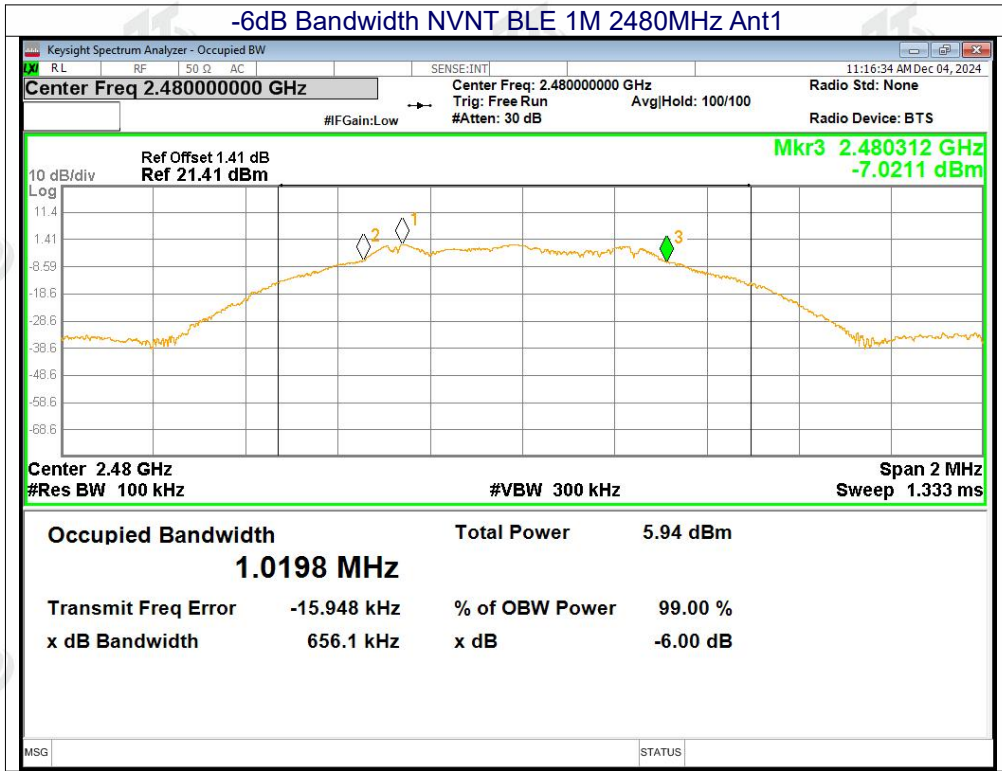

9. PEAK OUTPUT POWER TEST

Test Requirement:	FCC Part15 C Section 15.247 (b)(3)
Test Method:	KDB558074 D0115.247 Meas Guidance v05r02

9.1 APPLIED PROCEDURES / LIMIT

FCC Part15 (15.247) , Subpart C				
Section	Test Item	Limit	Frequency Range (MHz)	Result
15.247(b)(3)	Peak Output Power	1 watt or 30dBm	2400-2483.5	PASS

9.2 TEST PROCEDURE

- a. 1. Remove the antenna from the EUT and then connect a low RF cable from the antenna port to the spectrum.
2. Set the spectrum analyzer: RBW = 2MHz. VBW =6MHz. Sweep = auto; Detector Function = Peak.
3. Keep the EUT in transmitting at lowest, medium and highest channel individually. Record the max value.

9.3 DEVIATION FROM STANDARD

No deviation.

9.4 TEST SETUP



8.5 EUT OPERATION CONDITIONS

The EUT tested system was configured as the statements of 2.4 Unless otherwise a special operating condition is specified in the follows during the testing.



9.6 TEST RESULTS

Temperature :	25.6°C	Relative Humidity :	51%
Test Mode :	GFSK	Test Voltage :	DC 24V

Modulation	Test channel	Peak Output Power (dBm)	Limit(dBm)	Result
GFSK	Lowest	0.58	30.00	Pass
	Middle	0.65		
	Highest	0.34		

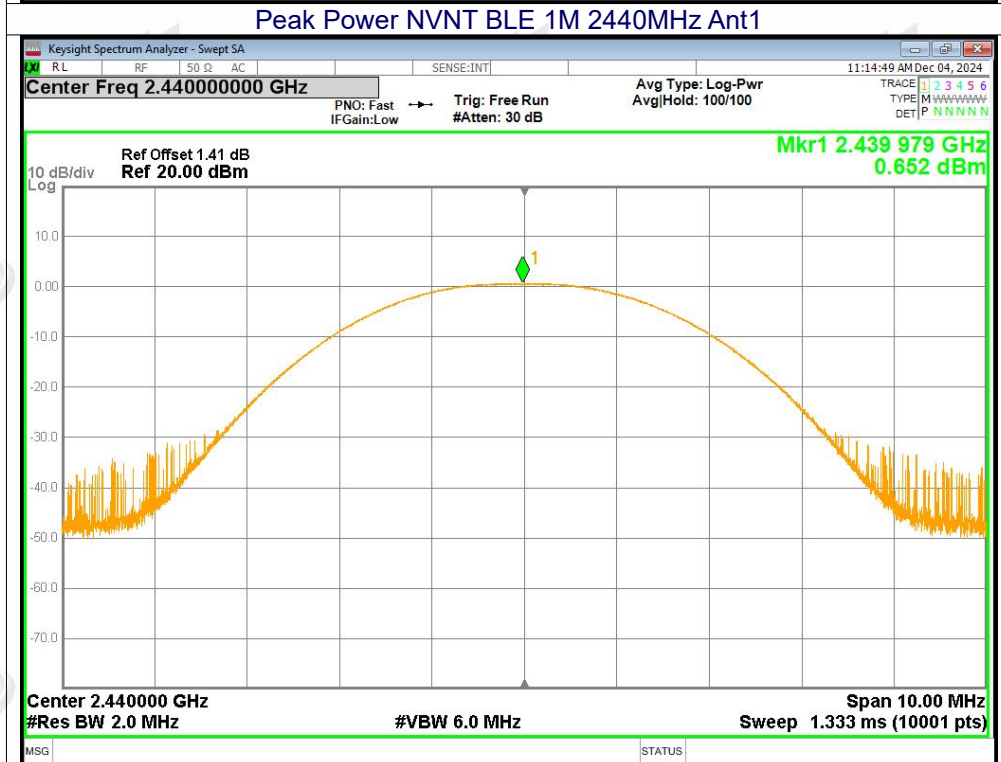
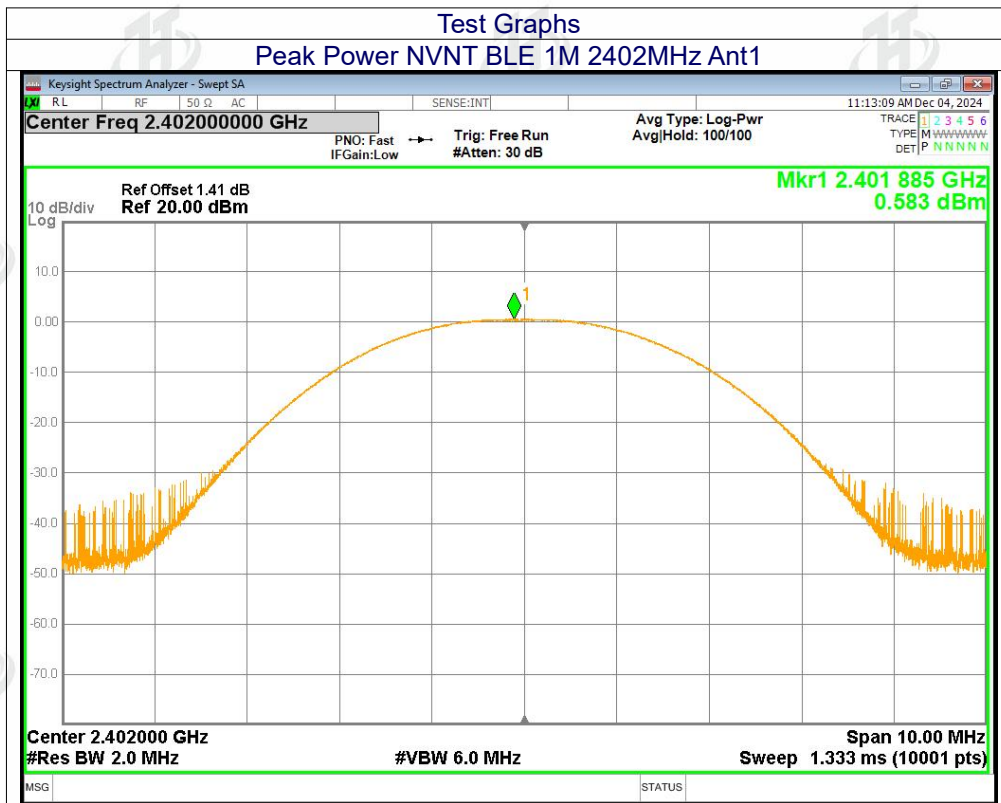

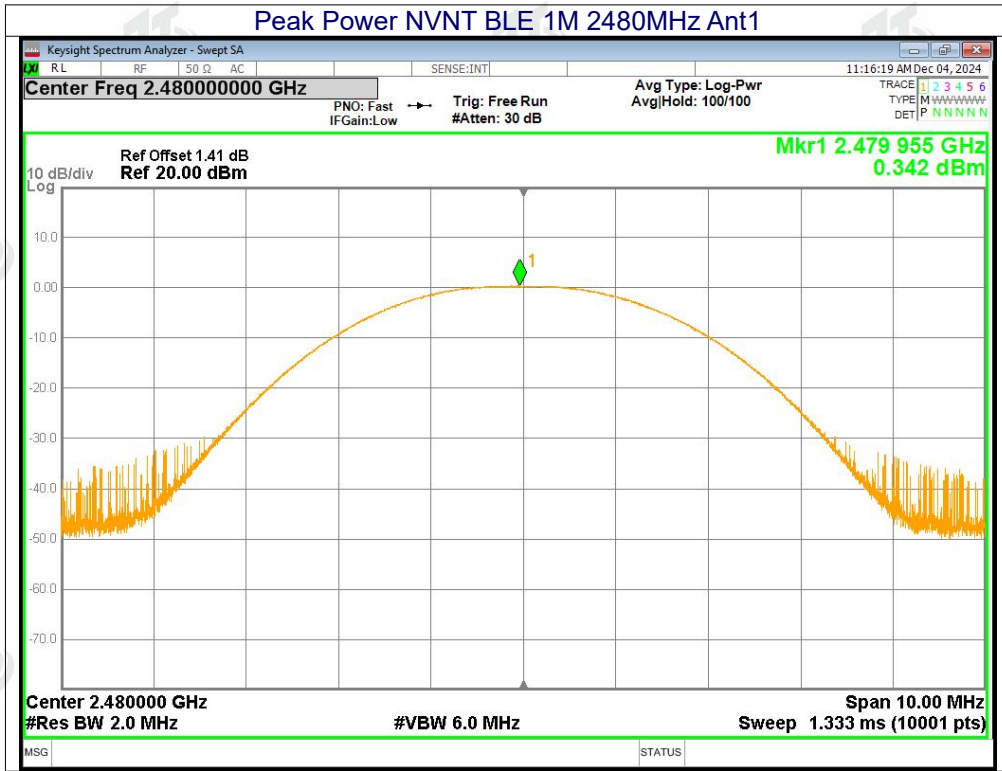



10. CONDUCTED BAND EDGE AND SPURIOUS EMISSION

Test Requirement:	FCC Part15 C Section 15.247 (d)
Test Method:	KDB558074 D0115.247 Meas Guidance v05r02

10.1 APPLICABLE STANDARD

In any 100 kHz bandwidth outside the frequency band in which the spread spectrum intentional radiator is operating, the radio frequency power that is produced by the intentional radiator shall be at least 20 dB below that in the 100 kHz bandwidth within the band that contains the highest level of the desired power, based on either an RF conducted or a radiated measurement.

10.2 TEST PROCEDURE

Using the following spectrum analyzer setting:

- A) Set the RBW = 100KHz.
- B) Set the VBW = 300KHz.
- C) Sweep time = auto couple.
- D) Detector function = peak.
- E) Trace mode = max hold.
- F) Allow trace to fully stabilize.

10.3 DEVIATION FROM STANDARD

No deviation.

10.4 TEST SETUP



10.5 EUT OPERATION CONDITIONS

The EUT tested system was configured as the statements of 2.4 Unless otherwise a special operating condition is specified in the follows during the testing.



10.6 TEST RESULTS

Band Edge

Condition	Mode	Frequency (MHz)	Antenna	Max Value (dBc)	Limit (dBc)	Verdict
NVNT	BLE 1M	2402	Ant1	-48.98	-20	Pass
NVNT	BLE 1M	2480	Ant1	-55.48	-20	Pass

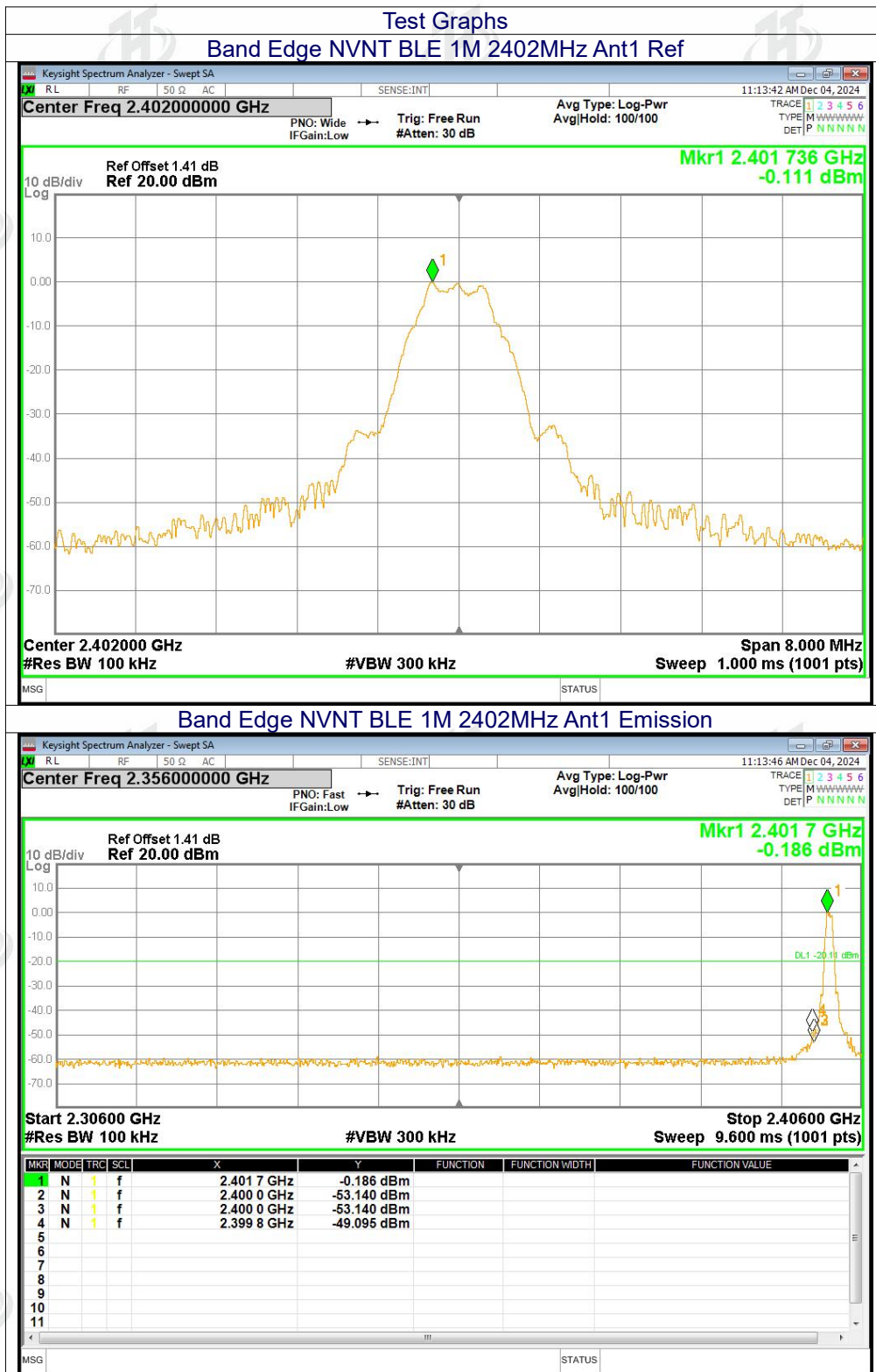

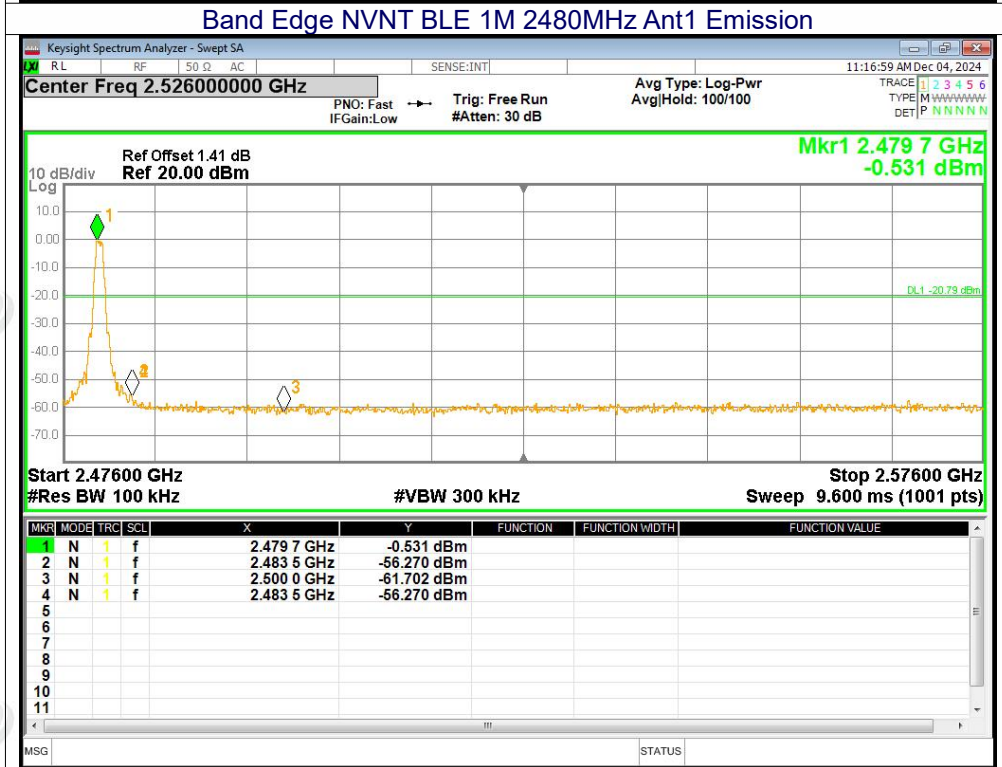
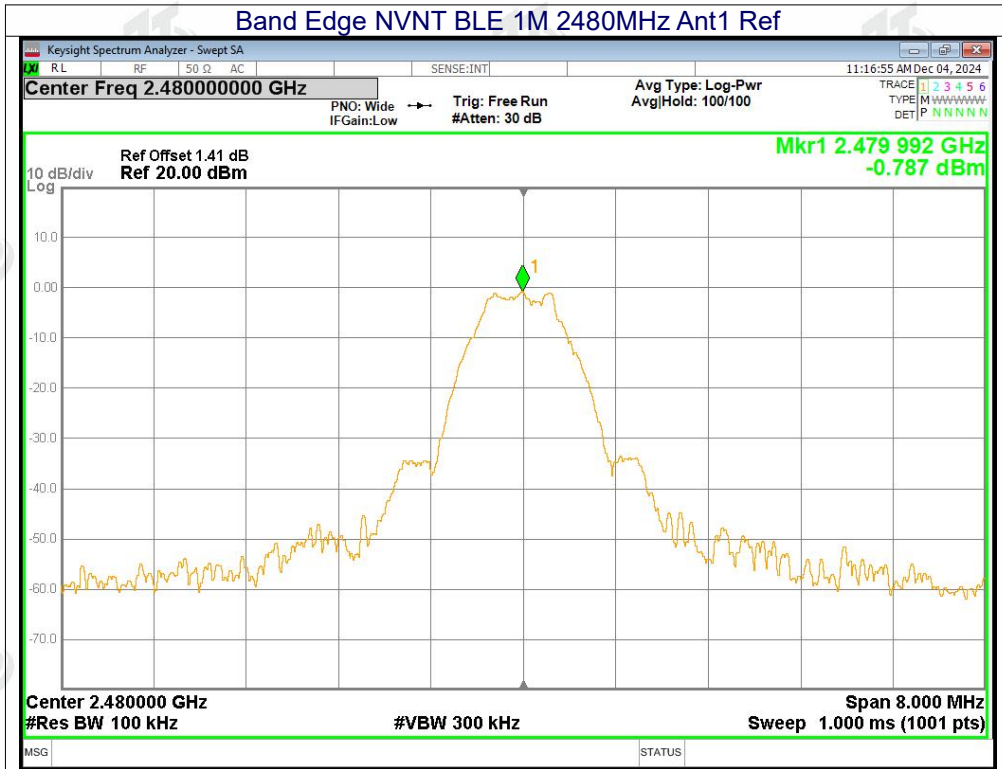



Conducted RF Spurious Emission

Condition	Mode	Frequency (MHz)	Antenna	Max Value (dBc)	Limit (dBc)	Verdict
NVNT	BLE 1M	2402	Ant1	-31.93	-20	Pass
NVNT	BLE 1M	2440	Ant1	-32.48	-20	Pass
NVNT	BLE 1M	2480	Ant1	-33.32	-20	Pass

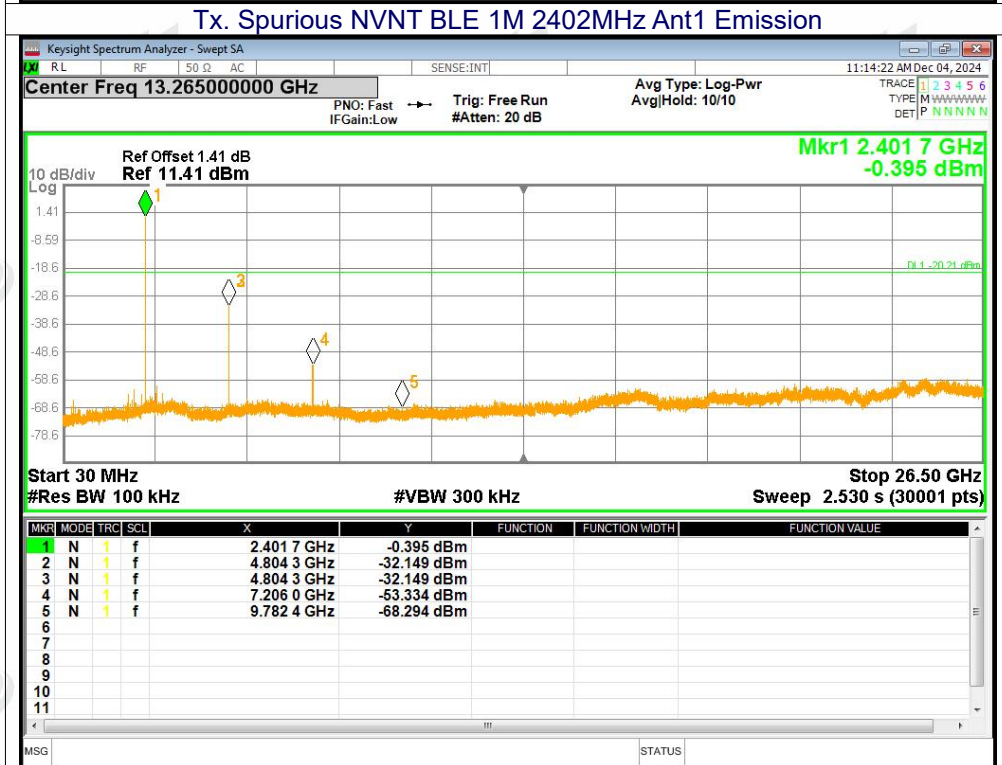
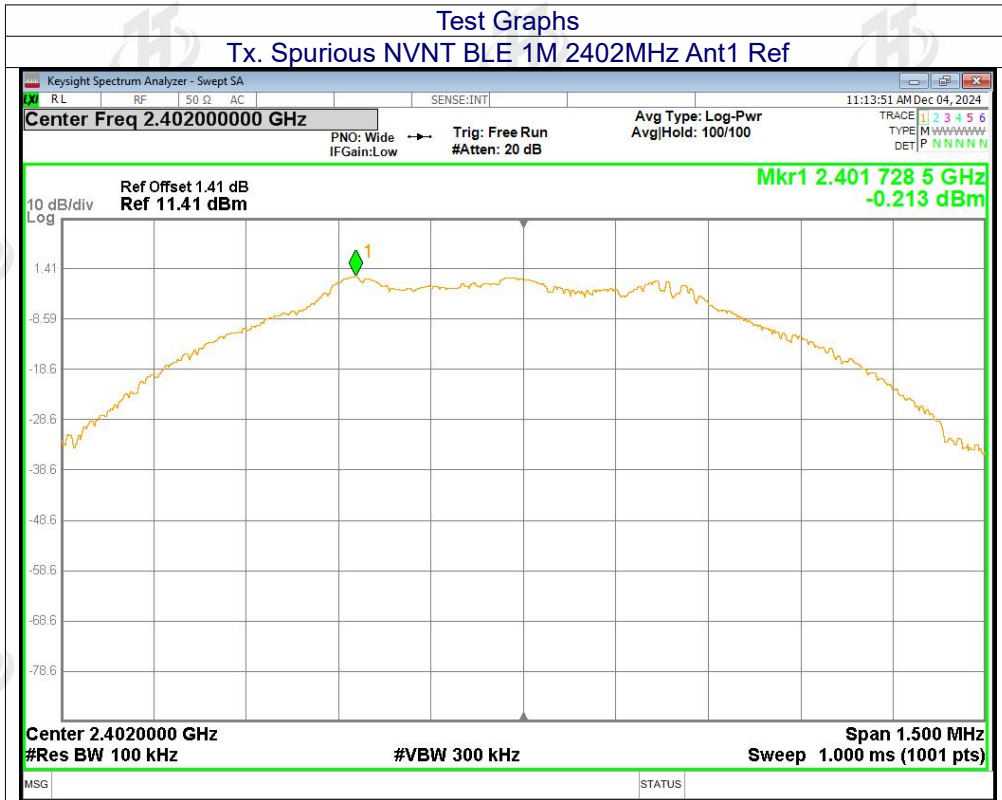

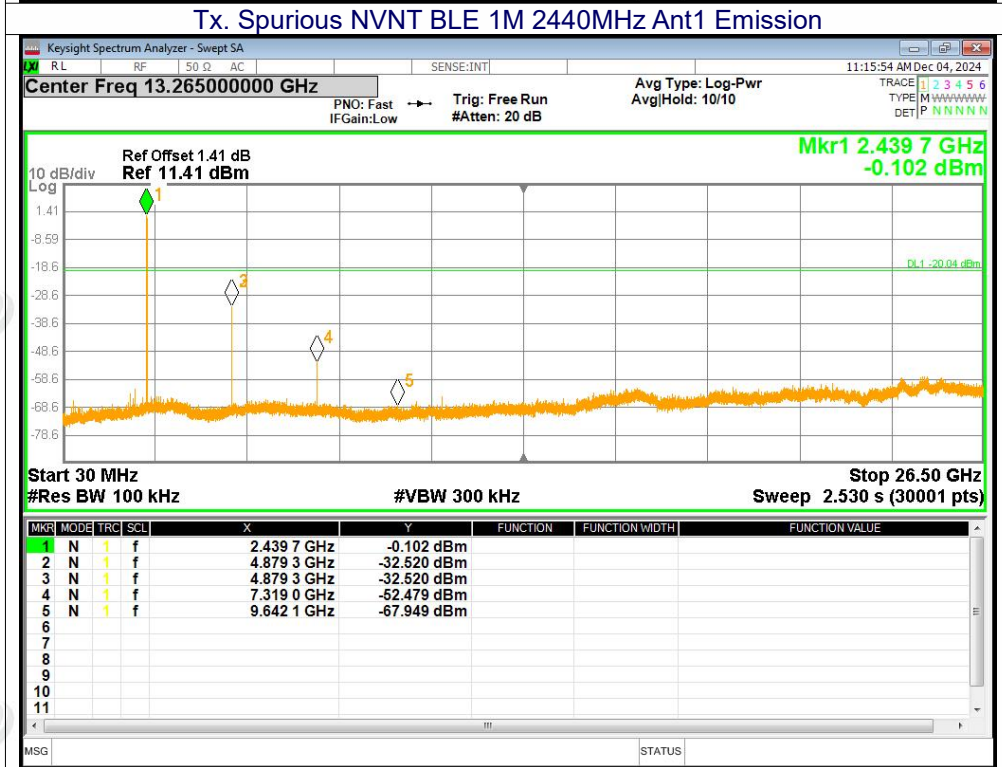
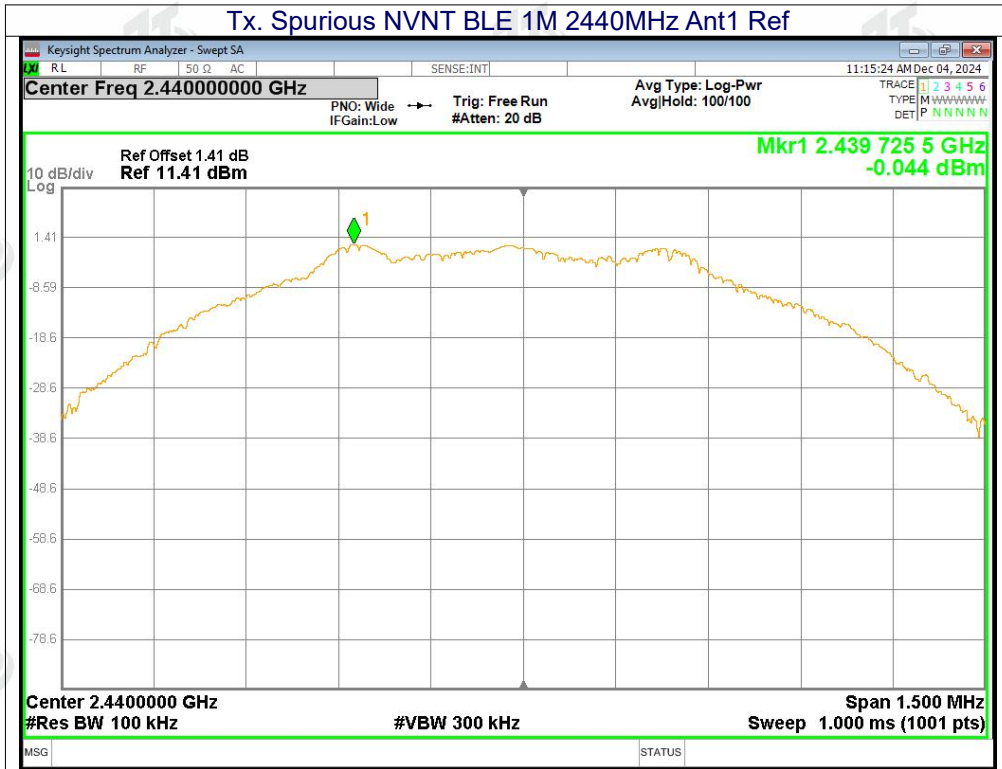

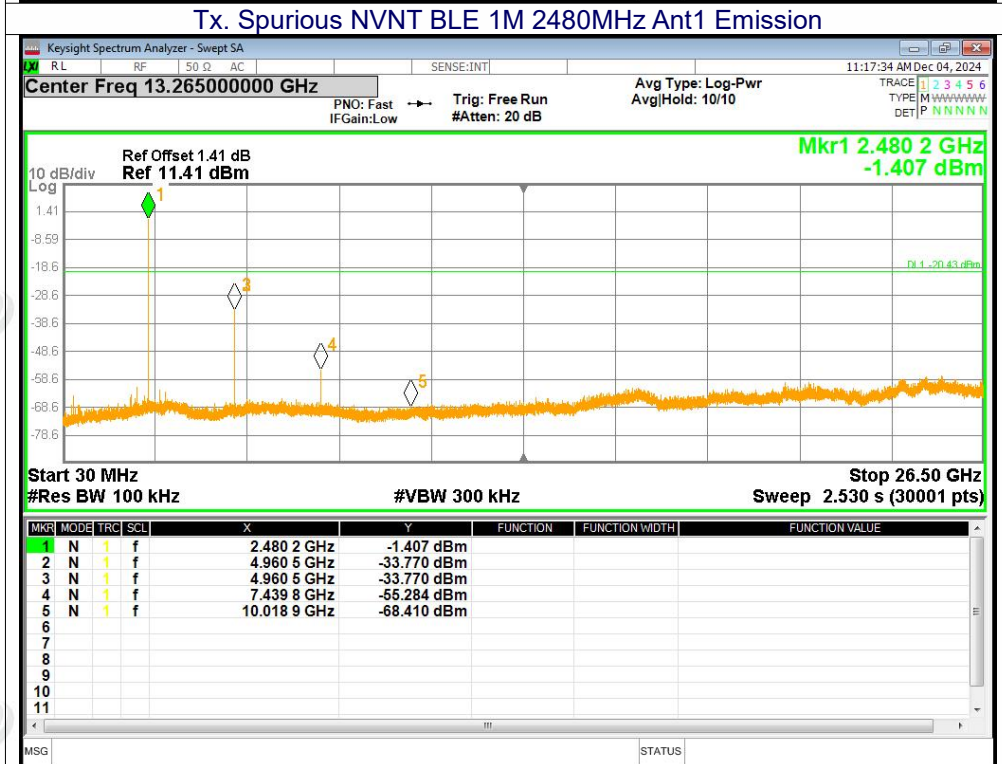
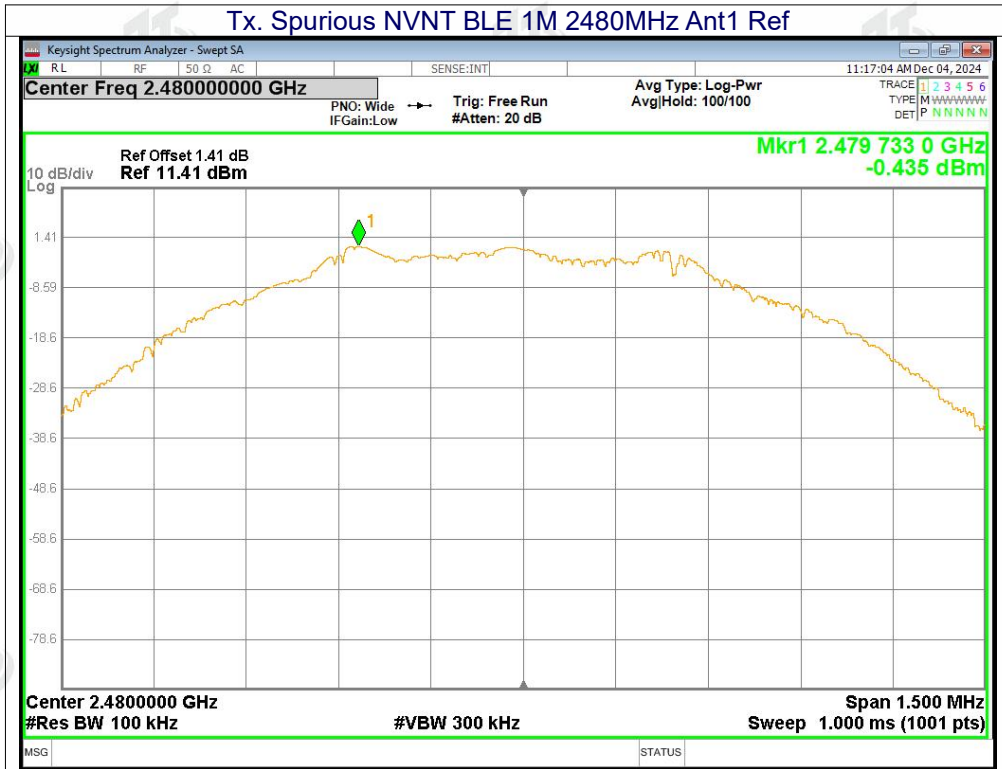

11.ANTENNA REQUIREMENT

Standard requirement:	FCC Part15 C Section 15.203 /247(b)(4)
15.203 requirement: An intentional radiator shall be designed to ensure that no antenna other than that furnished by the responsible party shall be used with the device. The use of a permanently attached antenna or of an antenna that uses a unique coupling to the intentional radiator, the manufacturer may design the unit so that a broken antenna can be replaced by the user, but the use of a standard antenna jack or electrical connector is prohibited.	
15.247(b) (4) requirement: (4) The conducted output power limit specified in paragraph (b) of this section is based on the use of antennas with directional gains that do not exceed 6 dBi. Except as shown in paragraph (c) of this section, if transmitting antennas of directional gain greater than 6 dBi are used, the conducted output power from the intentional radiator shall be reduced below the stated values in paragraphs (b)(1), (b)(2), and (b)(3) of this section, as appropriate, by the amount in dB that the directional gain of the antenna exceeds 6 dBi.	
EUT Antenna:	
The antenna is PCB antenna, the best case gain of the antennas is 1.33dBi, reference to the appendix II for details	



12. TEST SETUP PHOTO

Reference to the appendix I for details.

13. EUT CONSTRUCTIONAL DETAILS

Reference to the appendix II for details.

******* END OF REPORT *******