



FCC PART 15 SUBPART C TEST REPORT
FCC PART 15.407

Report Reference No..... : GRCTR250802012-02
FCC ID..... : 2BLJV-R-W52508
Compiled by
(position+printed name+signature).. : Testing Engineer Jimmy Wang

Supervised by
(position+printed name+signature).. : Project Engineer Kelley Zhang

Approved by
(position+printed name+signature).. : Manager Sam Wang



Date of issue..... : Sep. 03, 2025

Testing Laboratory Name..... : Shenzhen GUOREN Certification Technology Service Co., Ltd.
Address..... : 101#, Building K & Building T, The Second Industrial Zone, Jiazitang Community, Fenghuang Street, Guangming District, Shenzhen, China

Applicant's name..... : Shenzhen Dbit Network Equipment Co., Ltd
Address..... : 4002, Phase II, Qianhai Shimao Financial Center, No. 3040 Xinghai Avenue, Nanshan Street, Qianhai Shenzhen-Hong Kong Cooperation Zone, Shenzhen, China

Test specification..... :
Standard..... : FCC Part 15.407: UNLICENSED NATIONAL INFORMATION INFRASTRUCTURE DEVICES

Shenzhen GUOREN Certification Technology Service Co., Ltd. All rights reserved.
This publication may be reproduced in whole or in part for non-commercial purposes as long as the Shenzhen GUOREN Certification Technology Service Co., Ltd. is acknowledged as copyright owner and source of the material. Shenzhen GUOREN Certification Technology Service Co., Ltd. takes no responsibility for and will not assume liability for damages resulting from the reader's interpretation of the reproduced material due to its placement and context.

Test item description..... : AC1200 Dual Band Gigabit Wi-Fi Router
Trade Mark..... : /
Manufacturer..... : Shenzhen Dbit Network Equipment Co., Ltd
Model/Type reference..... : T18-21K Pro
Listed Models ..... : /
Firmware Version..... : V1.0
Hardware Version..... : V1.0
Modulation Type..... : DSSS,OFDM,OFDMA
Operation Frequency..... : From 5180MHz to 5240MHz,5260MHz to 5320MHz, 5500MHz to 5700MHz, 5745MHz to 5825MHz
Rating..... : DC 12V From External Circuit
Result..... : PASS

## TEST REPORT

Equipment under Test : AC1200 Dual Band Gigabit Wi-Fi Router

Model /Type : T18-21K Pro

Listed Models : /

Applicant : **Shenzhen Dbit Network Equipment Co., Ltd**

Address : 4002, Phase II, Qianhai Shimao Financial Center, No. 3040 Xinghai Avenue, Nanshan Street, Qianhai Shenzhen-Hong Kong Cooperation Zone, Shenzhen, China

Manufacturer : **Shenzhen Dbit Network Equipment Co., Ltd**

Address : 4002, Phase II, Qianhai Shimao Financial Center, No. 3040 Xinghai Avenue, Nanshan Street, Qianhai Shenzhen-Hong Kong Cooperation Zone, Shenzhen, China

<b>Test Result:</b>	<b>PASS</b>
---------------------	-------------

The test report merely corresponds to the test sample.  
It is not permitted to copy extracts of these test result without the written permission of the test laboratory.

## Contents

<b>1. TEST STANDARDS .....</b>	<b>4</b>
<b>2. SUMMARY .....</b>	<b>5</b>
2.1. General Remarks .....	5
2.2. Product Description .....	5
2.3. Equipment Under Test .....	6
2.4. Short description of the Equipment under Test (EUT) .....	6
2.5. EUT operation mode .....	6
2.6. EUT configuration .....	7
2.7. Block Diagram of Test Setup .....	7
2.8. Related Submittal(s) / Grant (s) .....	7
2.9. Modifications .....	7
<b>3. TEST ENVIRONMENT .....</b>	<b>8</b>
3.1. Address of the test laboratory .....	8
3.2. Test Facility .....	8
3.3. Environmental conditions .....	8
3.4. Test Description .....	8
3.5. Statement of the measurement uncertainty .....	9
3.6. Equipments Used during the Test .....	10
<b>4. TEST CONDITIONS AND RESULTS .....</b>	<b>12</b>
4.1. AC Power Conducted Emission .....	12
4.2. Radiated Emission .....	15
4.3. Duty Cycle .....	24
4.4. Maximum Average Output Power .....	25
4.5. Power Spectral Density .....	26
4.6. 6dB Bandwidth .....	27
4.7. 26dB Bandwidth .....	28
4.8. Frequency Stability .....	29
4.9. Antenna Requirement .....	30
<b>5. TEST SETUP PHOTOS OF THE EUT .....</b>	<b>31</b>
<b>6. EXTERNAL AND INTERNAL PHOTOS OF THE EUT .....</b>	<b>32</b>

## **1. TEST STANDARDS**

The tests were performed according to following standards:

[FCC Rules Part 15.407](#): UNLICENSED NATIONAL INFORMATION INFRASTRUCTURE DEVICES.

[ANSI C63.10-2020](#): American National Standard for Testing Unlicensed Wireless Devices

[KDB 789033 D02](#): GUIDELINES FOR COMPLIANCE TESTING OF UNLICENSED NATIONAL INFORMATION INFRASTRUCTURE (U-NII) DEVICES PART 15, SUBPART E

[KDB 662911 D01 Multiple Transmitter Output](#): Emissions Testing of Transmitters with Multiple Outputs in the Same Band

## 2. SUMMARY

### 2.1. General Remarks

Date of receipt of test sample	:	Aug. 08, 2025
Testing commenced on	:	Aug. 08, 2025
Testing concluded on	:	Sep. 03, 2025

### 2.2. Product Description

Product Name:	AC1200 Dual Band Gigabit Wi-Fi Router
Model/Type reference:	T18-21K Pro
Listed Models:	/
Power supply:	DC 12V From External Circuit
Adapter information:	M/N:RD1201000-225MG Input:AC 100-240V 50/60Hz 0.6A Output:12V---1.0A
Testing sample ID:	GRCTR250802012-1# (Engineer sample), GRCTR250802012-2# (Normal sample)
<b>WIFI</b>	
WLAN	Supported 802.11 a/n/ac
Modulation Type	IEEE 802.11a: OFDM(64QAM, 16QAM, QPSK, BPSK) IEEE 802.11n HT20: OFDM (64QAM, 16QAM, QPSK,BPSK) IEEE 802.11n HT40: OFDM (64QAM, 16QAM, QPSK,BPSK) IEEE 802.11acVHT20/VHT40/VHT80: OFDM(256QAM, 64QAM, 16QAM, QPSK, BPSK)
Operation frequency	IEEE 802.11a:5180-5240MHz,5260-5320MHz,5500-5700MHz,5745-5825MHz IEEE 802.11n HT20: 5180-5240MHz,5260-5320MHz,5500-5700MHz,5745-5825MHz IEEE 802.11n HT40: 5190-5230MHz,5270-5310MHz,5510-5670MHz,5755-5795MHz IEEE 802.11acVHT20: 5180-5240MHz,5260-5320MHz,5500-5700MHz,5745-5825MHz IEEE 802.11acVHT40: 5190-5230MHz,5270-5310MHz,5510-5670MHz,5755-5795MHz IEEE 802.11acVHT80:5210MHz,5290MHz,5530MHz,5610MHz,5775MHz
Channel number	4 Channels for 20MHz bandwidth(5180-5240MHz) 4 Channels for 20MHz bandwidth(5260-5320MHz) 11 Channels for 20MHz bandwidth(5500-5700MHz) 5 channels for 20MHz bandwidth(5745-5825MHz) 2 channels for 40MHz bandwidth(5190~5230MHz) 2 channels for 40MHz bandwidth(5270~5310MHz) 5 Channels for 40MHz bandwidth(5510-5670MHz) 2 channels for 40MHz bandwidth(5755~5795MHz) 1 channel for 80MHz bandwidth(5210MHz) 1 channel for 80MHz bandwidth(5290MHz) 1 Channel for 80MHz bandwidth(5530Hz) 1 Channel for 80MHz bandwidth(5610Hz) 1 channel for 80MHz bandwidth(5775MHz)
Antenna type:	External antenna

Antenna gain*(Supplied by the customer):	Ant 1: 5.17 dBi Ant 2: 5.17 dBi Directional gain:8.18
Remark:*When the information provided by the customer was used to calculate test results, if the information provided by the customer is not accurate, shenzhen GUOREN Certification Technology Service Co., Ltd. does not assume any responsibility. The product has two kinds of appearance,appearance 1 had been tested all items.	

According to KDB 662911 D01 Multiple Transmitter Output,Directional Gain Calculations for In-Band Measurements:

If transmit signals are correlated, then

Directional gain =  $10 \log[(10^{G_1/20} + 10^{G_2/20} + \dots + 10^{G_N/20})^2 / N_{ANT}]$  dBi [Note the "20"s in the denominator of each exponent and the square of the sum of terms; the object is to combine the signal levels coherently.]

## 2.3. Equipment Under Test

### Power supply system utilised

Power supply voltage	:	<input type="radio"/> 230V / 50 Hz	<input type="radio"/> 120V / 60Hz
		<input type="radio"/> 12 V DC	<input type="radio"/> 24 V DC
		<input checked="" type="radio"/> Other (specified in blank below)	

DC 12V From External Circuit

## 2.4. Short description of the Equipment under Test (EUT)

This is a AC1200 Dual Band Gigabit Wi-Fi Router.  
For more details, refer to the user's manual of the EUT.

## 2.5. EUT operation mode

The application provider specific test software to control sample in continuous TX and RX.

IEEE 802.11a/nHT20/nHT40/acVHT20/acVHT40/acVHT80:

U-NI-1		U-NI-1		U-NI-1	
Channel	Frequency (MHz)	Channel	Frequency (MHz)	Channel	Frequency (MHz)
36	5180	38	5190	42	5210
40	5200	46	5230		
44	5220				
48	5240				

U-NI-2A		U-NI-2A		U-NI-2A	
Channel	Frequency (MHz)	Channel	Frequency (MHz)	Channel	Frequency (MHz)
52	5260	54	5270	58	5290
56	5280	62	5310		
60	5300				
64	5320				

U-NI-2C		U-NI-2C		U-NI-2C	
Channel	Frequency (MHz)	Channel	Frequency (MHz)	Channel	Frequency (MHz)
100	5500	102	5510	106	5530
104	5520	110	5550	122	5610
108	5540	118	5590		
112	5560	126	5630		
116	5580	134	5670		
120	5600				
124	5620				

128	5640				
132	5660				
136	5680				
140	5700				

U-NI-3		U-NI-3		U-NI-3	
Channel	Frequency (MHz)	Channel	Frequency (MHz)	Channel	Frequency (MHz)
149	5745	151	5755	155	5775
153	5765	159	5795		
157	5785				
161	5805				
165	5825				

**2.6. EUT configuration**

The following peripheral devices and interface cables were connected during the measurement:

Item	Manufacturer	Description	Model	Certificate	Note
1 <sup>Note1</sup>	Hewlett-Packard	Notebook	HP ProBook 445 G10	/	/
2 <sup>Note1</sup>	/	/	/	/	/

Note1: This Auxiliary used during the test is provided by the test laboratory.

**2.7. Block Diagram of Test Setup**

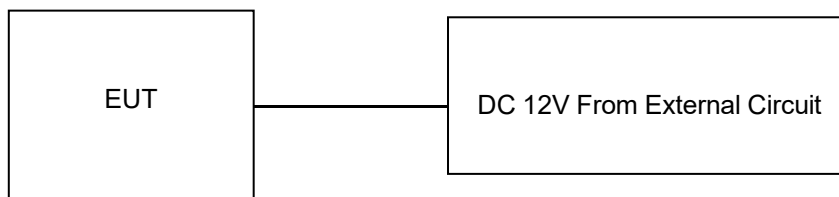

**2.8. Related Submittal(s) / Grant (s)**

This submittal(s) (test report) is intended for filing to comply with Section 15.407 of the FCC Part 15, Subpart E Rules.

**2.9. Modifications**

No modifications were implemented to meet testing criteria.

### 3. TEST ENVIRONMENT

#### 3.1. Address of the test laboratory

**Shenzhen GUOREN Certification Technology Service Co., Ltd.**

101#, Building K & Building T, The Second Industrial Zone, Jiazitang Community, Fenghuang Street, Guangming District, Shenzhen, China

#### 3.2. Test Facility

The test facility is recognized, certified, or accredited by the following organizations:

**FCC-Registration No.: 920798 Designation Number: CN1304**

Shenzhen GUOREN Certification Technology Service Co., Ltd. has been listed on the US Federal Communications Commission list of test facilities recognized to perform electromagnetic emissions measurements.

**A2LA-Lab Cert. No.: 6202.01**

Shenzhen GUOREN Certification Technology Service Co., Ltd. has been listed by American Association for Laboratory Accreditation to perform electromagnetic emission measurement.

**ISED#: 27264 CAB identifier: CN0115**

Shenzhen GUOREN Certification Technology Service Co., Ltd. has been listed by Innovation, Science and Economic Development Canada to perform electromagnetic emission measurement.

**CNAS-Lab Code: L15631**

Shenzhen GUOREN Certification Technology Service Co., Ltd. has been assessed and proved to be in compliance with CNAS-CL01 Accreditation Criteria for Testing and Calibration Laboratories for the Competence of Testing and Calibration Laboratories.

The 3m-Semi anechoic test site fulfils CISPR 16-1-4 according to ANSI C63.10 and CISPR 16-1-4:2010.

#### 3.3. Environmental conditions

During the measurement the environmental conditions were within the listed ranges:

Temperature:	15-35 ° C
Humidity:	30-60 %
Atmospheric pressure:	950-1050mbar

#### 3.4. Test Description

Test Specification clause	Test case	Test Mode	Test Channel	Recorded In Report	Pass	Fail	NA	NP	Remark	
§15.203	Antenna gain	802.11ac	<input checked="" type="checkbox"/> Lowest <input checked="" type="checkbox"/> Middle <input checked="" type="checkbox"/> Highest	802.11ac	<input checked="" type="checkbox"/> Lowest <input checked="" type="checkbox"/> Middle <input checked="" type="checkbox"/> Highest	<input checked="" type="checkbox"/>	<input type="checkbox"/>	<input type="checkbox"/>	<input type="checkbox"/>	complies
§15.407(a)	Power spectral density	802.11a/ac20/ac40/ac80/n20/n40	<input checked="" type="checkbox"/> Lowest <input checked="" type="checkbox"/> Middle <input checked="" type="checkbox"/> Highest	802.11a/ac20/ac40/ac80/n20/n40	<input checked="" type="checkbox"/> Lowest <input checked="" type="checkbox"/> Middle <input checked="" type="checkbox"/> Highest	<input checked="" type="checkbox"/>	<input type="checkbox"/>	<input type="checkbox"/>	<input type="checkbox"/>	complies
§15.407(a)	Spectrum bandwidth – 26 dB bandwidth	802.11a/ac20/ac40/ac80/n20/n40	<input checked="" type="checkbox"/> Lowest <input checked="" type="checkbox"/> Middle <input checked="" type="checkbox"/> Highest	802.11a/ac20/ac40/ac80/n20/n40	<input checked="" type="checkbox"/> Lowest <input checked="" type="checkbox"/> Middle <input checked="" type="checkbox"/> Highest	<input checked="" type="checkbox"/>	<input type="checkbox"/>	<input type="checkbox"/>	<input type="checkbox"/>	complies



§15.407(e)	Spectrum bandwidth – 6 dB bandwidth	802.11a/ac20/ac40/ac80/n20/n40	<input checked="" type="checkbox"/> Lowest <input checked="" type="checkbox"/> Middle <input checked="" type="checkbox"/> Highest	802.11a/ac20/ac40/ac80/n20/n40	<input checked="" type="checkbox"/> Lowest <input checked="" type="checkbox"/> Middle <input checked="" type="checkbox"/> Highest	<input checked="" type="checkbox"/> <input checked="" type="checkbox"/>	<input type="checkbox"/>	<input type="checkbox"/>	<input type="checkbox"/>	complies
§15.407(a)	Maximum output power	802.11a/ac20/ac40/ac80/n20/n40	<input checked="" type="checkbox"/> Lowest <input checked="" type="checkbox"/> Middle <input checked="" type="checkbox"/> Highest	802.11a/ac20/ac40/ac80/n20/n40	<input checked="" type="checkbox"/> Lowest <input checked="" type="checkbox"/> Middle <input checked="" type="checkbox"/> Highest	<input checked="" type="checkbox"/> <input checked="" type="checkbox"/> <input checked="" type="checkbox"/>	<input type="checkbox"/>	<input type="checkbox"/>	<input type="checkbox"/>	complies
§15.407(b)	Band edge compliance conducted	802.11a/ac20/ac40/ac80/n20/n40	<input checked="" type="checkbox"/> Lowest <input checked="" type="checkbox"/> Highest	802.11a/ac20/ac40/ac80/n20/n40	<input checked="" type="checkbox"/> Lowest <input checked="" type="checkbox"/> Highest	<input checked="" type="checkbox"/> <input checked="" type="checkbox"/>	<input type="checkbox"/>	<input type="checkbox"/>	<input type="checkbox"/>	complies
§15.407(b)	Band edge compliance radiated	802.11a/ac20/ac40/ac80/n20/n40	<input checked="" type="checkbox"/> Lowest <input checked="" type="checkbox"/> Highest	802.11ac	<input checked="" type="checkbox"/> Lowest <input checked="" type="checkbox"/> Highest	<input checked="" type="checkbox"/>	<input type="checkbox"/>	<input type="checkbox"/>	<input type="checkbox"/>	complies
§15.407(a)	TX spurious emissions conducted	-/-	-/-	-/-	-/-	<input type="checkbox"/>	<input type="checkbox"/>	<input checked="" type="checkbox"/>	<input type="checkbox"/>	complies
§15.407(a)	TX spurious emissions radiated	802.11a/ac20/ac40/ac80/n20/n40	<input checked="" type="checkbox"/> Lowest <input checked="" type="checkbox"/> Middle <input checked="" type="checkbox"/> Highest	802.11ac	<input checked="" type="checkbox"/> Lowest <input checked="" type="checkbox"/> Middle <input checked="" type="checkbox"/> Highest	<input checked="" type="checkbox"/>	<input type="checkbox"/>	<input type="checkbox"/>	<input type="checkbox"/>	complies
§15.407(g)	Frequency Stability	-/-	-/-	-/-	-/-	<input checked="" type="checkbox"/>	<input type="checkbox"/>	<input type="checkbox"/>	<input type="checkbox"/>	complies
§15.109	RX spurious emissions radiated	-/-	-/-	-/-	-/-	<input type="checkbox"/>	<input type="checkbox"/>	<input checked="" type="checkbox"/>	<input type="checkbox"/>	complies
§15.209(a)	TX spurious Emissions radiated < 30 MHz	802.11a/ac20/ac40/ac80/n20/n40	-/-	802.11ac	-/-	<input checked="" type="checkbox"/>	<input type="checkbox"/>	<input type="checkbox"/>	<input type="checkbox"/>	complies
§15.107(a) §15.207	Conducted Emissions < 30 MHz	802.11a/ac20/ac40/ac80/n20/n40	-/-	802.11ac	-/-	<input checked="" type="checkbox"/>	<input type="checkbox"/>	<input type="checkbox"/>	<input type="checkbox"/>	complies

## Remark:

1. The measurement uncertainty is not included in the test result.
2. NA = Not Applicable; NP = Not Performed

Preliminary tests were performed in different data rate to find the worst radiated emission. The data rate shown in the table below is the worst-case rate with respect to the specific test item. Investigation has been done on all the possible configurations for searching the worst cases. The following table is a list of the test modes shown in this test report.

### 3.5. Statement of the measurement uncertainty

Tdata and results referenced in this document are true and accurate. The reader is cautioned that there may be errors within the calibration limits of the equipment and facilities. The measurement uncertainty was calculated for all measurements listed in this test report acc. to TR-100028-01" Electromagnetic compatibility and Radio spectrum Matters (ERM);Uncertainties in the measurement of mobile radio equipment characteristics; Part 1" and TR-100028-02 "Electromagnetic compatibility and Radio spectrum Matters (ERM);Uncertainties in the measurement of mobile radio equipment characteristics; Part 2 " and is documented in the Shenzhen GUOREN Certification Technology Service Co., Ltd.quality system acc. to DIN EN ISO/IEC 17025. Furthermore, component and process variability of devices similar to that tested may result in additional deviation. The manufacturer has the sole responsibility of continued compliance of the device.

Hereafter the best measurement capability for Shenzhen GUOREN Certification Technology Service Co., Ltd.:

Test	Range	Measurement Uncertainty	Notes
Radiated Emission	30~1000MHz	4.06 dB	(1)
Radiated Emission	1~18GHz	5.14 dB	(1)
Radiated Emission	18-40GHz	5.38 dB	(1)
Conducted Disturbance	0.15~30MHz	2.14 dB	(1)
Max output power	30MHz~18GHz	0.54 dB	(1)
Power spectral density	/	0.56 dB	(1)
Spectrum bandwidth	/	1.2%	(1)

(1) This uncertainty represents an expanded uncertainty expressed at approximately the 95% confidence level using a coverage factor of k=2.

### 3.6. Equipments Used during the Test

Test Equipment	Manufacturer	Model No.	Equipment No.	Calibration Date	Calibration Due Date
LISN	R&S	ENV216	GRCTEE009	2024/09/19	2025/09/18
LISN	R&S	ENV216	GRCTEE010	2024/09/19	2025/09/18
EMI Test Receiver	R&S	ESPI	GRCTEE017	2024/09/19	2025/09/18
EMI Test Receiver	R&S	ESCI	GRCTEE008	2024/09/19	2025/09/18
Spectrum Analyzer	Agilent	N9020A	GRCTEE002	2024/09/19	2025/09/18
Spectrum Analyzer	R&S	FSP	GRCTEE003	2024/09/20	2025/09/19
Vector Signal generator	Agilent	N5181A	GRCTEE007	2024/09/19	2025/09/18
Analog Signal Generator	R&S	SML03	GRCTEE006	2024/09/19	2025/09/18
Climate Chamber	QIYA	LCD-9530	GRCTES016	2024/09/19	2025/09/18
Ultra-Broadband Antenna	Schwarzbeck	VULB9163	GRCTEE018	2023/09/28	2026/09/27
Horn Antenna	Schwarzbeck	BBHA 9120D	GRCTEE019	2023/09/28	2026/09/27
Loop Antenna	Zhinan	ZN30900C	GRCTEE020	2023/10/15	2026/10/14
Horn Antenna	Beijing Hangwei Dayang	OBH100400	GRCTEE049	2023/09/28	2026/09/27
Amplifier	Schwarzbeck	BBV 9745	GRCTEE021	2024/09/19	2025/09/18
Amplifier	Taiwan chengyi	EMC051845B	GRCTEE022	2024/09/19	2025/09/18
Temperature/Humidity Meter	Huaguan	HG-308	GRCTES037	2024/09/19	2025/09/18
Directional coupler	NARDA	4226-10	GRCTEE004	2024/09/19	2025/09/18
High-Pass Filter	XingBo	XBLBQ-GTA18	GRCTEE053	2024/09/19	2025/09/18
High-Pass Filter	XingBo	XBLBQ-GTA27	GRCTEE054	2024/09/19	2025/09/18

Automated filter bank	Tonscend	JS0806-F	GRCTEE055	2024/09/19	2025/09/18
Power Sensor	Agilent	U2021XA	GRCTEE070	2024/09/19	2025/09/18
Cable	Times	Cable-CE	GRCTEE086	2024/09/19	2025/09/18
Cable	Times	Cable-RE-1	GRCTEE087	2024/09/19	2025/09/18
Cable	Times	Cable-RE-2	GRCTEE088	2024/09/19	2025/09/18
EMI Test Software	ROHDE & SCHWARZ	ESK1-V1.71	GRCTEE060	N/A	N/A
EMI Test Software	Fera	EZ-EMC	GRCTEE061	N/A	N/A

## 4. TEST CONDITIONS AND RESULTS

### 4.1. AC Power Conducted Emission

#### TEST CONFIGURATION

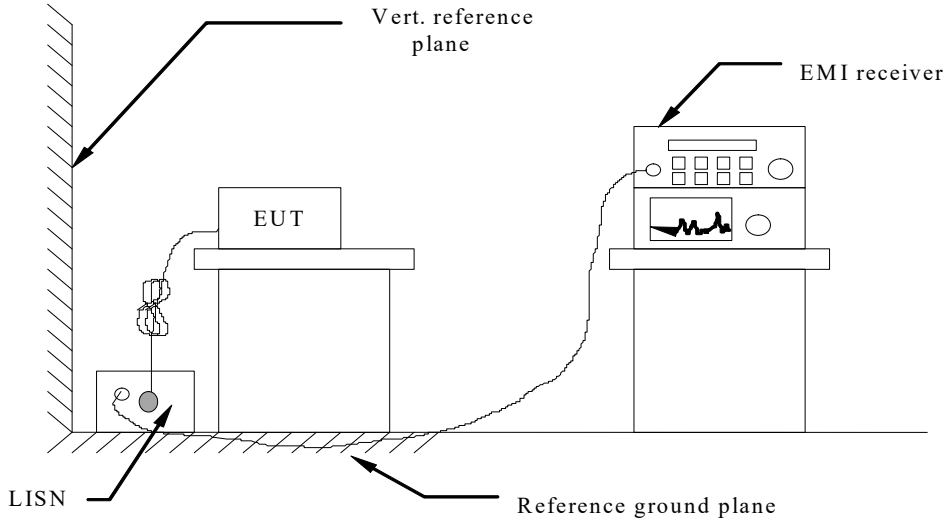

#### TEST PROCEDURE

- 1 The equipment was set up as per the test configuration to simulate typical actual usage per the user’s manual. The EUT is a tabletop system, a wooden table with a height of 0.8 meters is used and is placed on the ground plane as per ANSI C63.10-2020.
- 2 Support equipment, if needed, was placed as per ANSI C63.10-2020
- 3 All I/O cables were positioned to simulate typical actual usage as per ANSI C63.10-2020
- 4 The EUT received DC 12V power from adapter, the adapter received AC120V/60Hz and AC 240V/60Hz power through a Line Impedance Stabilization Network (LISN) which supplied power source and was grounded to the ground plane.
- 5 All support equipments received AC power from a second LISN, if any.
- 6 The EUT test program was started. Emissions were measured on each current carrying line of the EUT using a spectrum Analyzer / Receiver connected to the LISN powering the EUT. The LISN has two monitoring points: Line 1 (Hot Side) and Line 2 (Neutral Side). Two scans were taken: one with Line 1 connected to Analyzer / Receiver and Line 2 connected to a 50 ohm load; the second scan had Line 1 connected to a 50 ohm load and Line 2 connected to the Analyzer / Receiver.
- 7 Analyzer / Receiver scanned from 150 KHz to 30MHz for emissions in each of the test modes.
- 8 During the above scans, the emissions were maximized by cable manipulation.

#### AC Power Conducted Emission Limit

For intentional device, according to § 15.207(a) AC Power Conducted Emission Limits is as following :

Frequency range (MHz)	Limit (dBuV)	
	Quasi-peak	Average
0.15-0.5	66 to 56*	56 to 46*
0.5-5	56	46
5-30	60	50

\* Decreases with the logarithm of the frequency.

#### TEST RESULTS

Remark:

1. All modes were tested at Low, Middle, and High channel; only the worst result of 802.11 ac CH36 for antenna 1 was reported as below:

2. Both 120 VAC, 50/60 Hz and 240 VAC, 50/60 Hz power supply have been tested, only the worst result of 120 VAC, 60 Hz was reported as below:

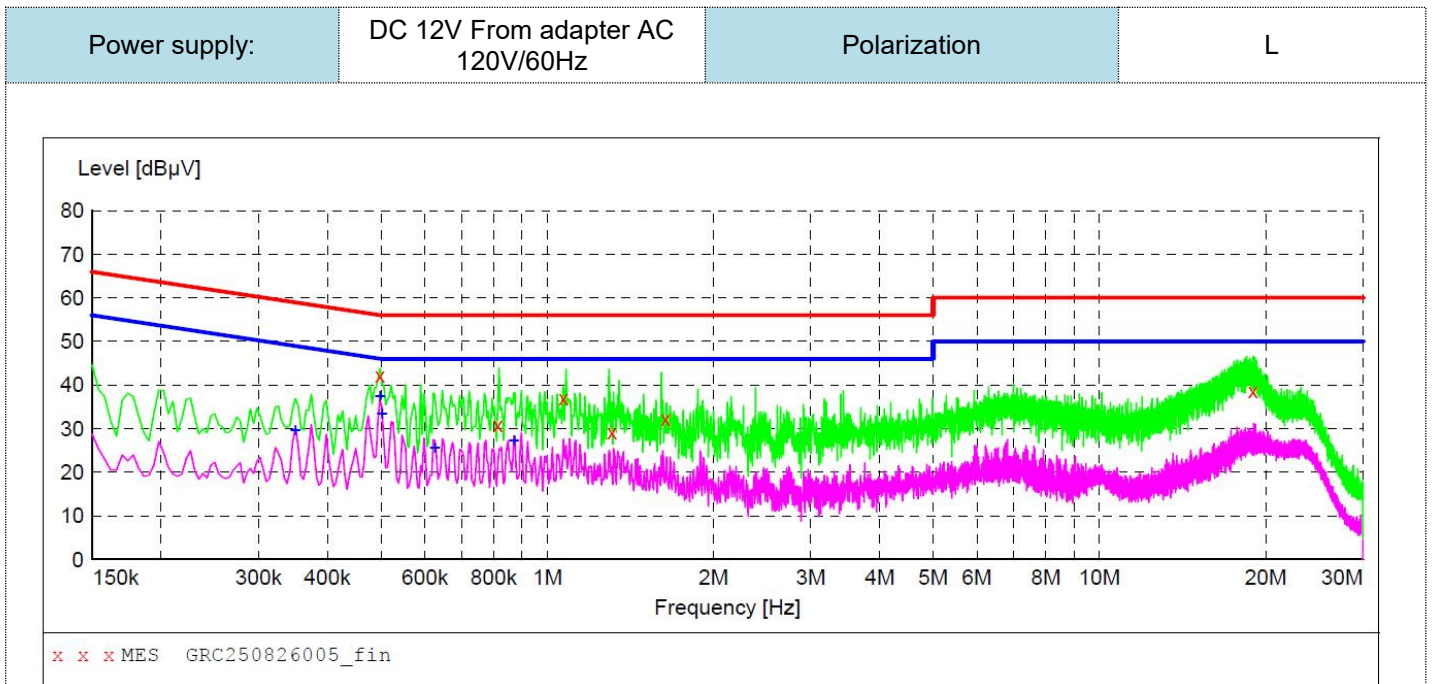

**MEASUREMENT RESULT: "GRC250826005\_fin"**

8/26/2025 10:45AM

Frequency MHz	Level dBµV	Transd dB	Limit dBµV	Margin dB	Detector	Line	PE
0.498000	42.20	10.2	56	13.8	QP	L1	GND
0.814000	31.00	10.3	56	25.0	QP	L1	GND
1.070000	37.10	10.3	56	18.9	QP	L1	GND
1.310000	29.30	10.4	56	26.7	QP	L1	GND
1.638000	32.40	10.4	56	23.6	QP	L1	GND
18.986000	38.60	10.5	60	21.4	QP	L1	GND

**MEASUREMENT RESULT: "GRC250826005\_fin2"**

8/26/2025 10:45AM

Frequency MHz	Level dBµV	Transd dB	Limit dBµV	Margin dB	Detector	Line	PE
0.350000	29.60	10.4	49	19.4	AV	L1	GND
0.498000	37.60	10.2	46	8.4	AV	L1	GND
0.502000	33.50	10.2	46	12.5	AV	L1	GND
0.626000	25.60	10.5	46	20.4	AV	L1	GND
0.870000	27.40	10.3	46	18.6	AV	L1	GND

- Note: 1). Level (dBµV) = Reading (dBµV) + Transducer (dB)  
 2). Transducer (dB) = insertion loss of LISN (dB) + Cable loss (dB)  
 3). Margin (dB) = Limit (dBµV) - Level (dBµV)

Power supply:	DC 12V From adapter AC 120V/60Hz	Polarization	N
---------------	-------------------------------------	--------------	---

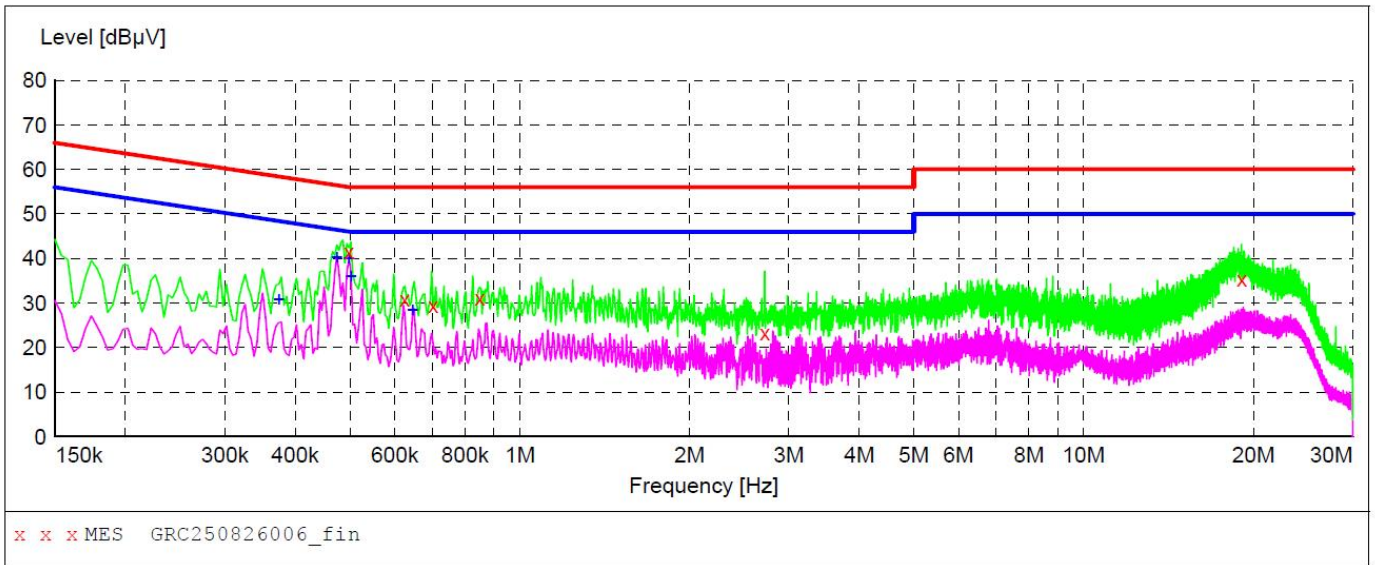

**MEASUREMENT RESULT: "GRC250826006\_fin"**

8/26/2025 10:49AM

Frequency MHz	Level dBµV	Transd dB	Limit dBµV	Margin dB	Detector	Line	PE
0.498000	41.50	10.2	56	14.5	QP	N	GND
0.626000	31.00	10.5	56	25.0	QP	N	GND
0.702000	29.40	10.5	56	26.6	QP	N	GND
0.850000	31.10	10.3	56	24.9	QP	N	GND
2.722000	23.30	10.6	56	32.7	QP	N	GND
19.102000	35.30	10.5	60	24.7	QP	N	GND

**MEASUREMENT RESULT: "GRC250826006\_fin2"**

8/26/2025 10:49AM

Frequency MHz	Level dBµV	Transd dB	Limit dBµV	Margin dB	Detector	Line	PE
0.374000	30.90	10.4	48	17.5	AV	N	GND
0.474000	40.30	10.2	46	6.1	AV	N	GND
0.498000	40.10	10.2	46	5.9	AV	N	GND
0.502000	36.20	10.2	46	9.8	AV	N	GND
0.646000	28.60	10.5	46	17.4	AV	N	GND

- Note: 1). Level (dBµV) = Reading (dBµV) + Transducer (dB)  
 2). Transducer (dB) = insertion loss of LISN (dB) + Cable loss (dB)  
 3). Margin (dB) = Limit (dBµV) - Level (dBµV)

## 4.2. Radiated Emission

### Limit

The maximum emissions outside of the frequency bands of operation shall be attenuated in accordance with the following limits:

- (1) For transmitters operating in the 5.15-5.25 GHz band: All emissions outside of the 5.15-5.35 GHz band shall not exceed an e.i.r.p. of -27 dBm/MHz.
- (2) For transmitters operating in the 5.25-5.35 GHz band: All emissions outside of the 5.15-5.35 GHz band shall not exceed an e.i.r.p. of -27 dBm/MHz.
- (3) For transmitters operating in the 5.47-5.725 GHz band: All emissions outside of the 5.47-5.725 GHz band shall not exceed an e.i.r.p. of -27 dBm/MHz.
- (4) For transmitters operating in the 5.725-5.85 GHz band: All emissions shall be limited to a level of -27 dBm/MHz at 75 MHz or more above or below the band edge increasing linearly to 10 dBm/MHz at 25 MHz above or below the band edge, and from 25 MHz above or below the band edge increasing linearly to a level of 15.6 dBm/MHz at 5 MHz above or below the band edge, and from 5 MHz above or below the band edge increasing linearly to a level of 27 dBm/MHz at the band edge.

### Undesirable emission limits

Requirement	Limit(EIRP)	Limit (Field strength at 3m) <small>Note1</small>
15.407(b)(1)	PK:-27(dBm/MHz)	PK:68.2(dBµV/m)
15.407(b)(2)		
15.407(b)(3)		
15.407(b)(4)		

Note1: The following formula is used to convert the equipment isotropic radiated power (eirp) to field strength:

$$E = \frac{1000000\sqrt{30P}}{3} \mu\text{V/m, where P is the eirp (Watts)}$$

- (5) Unwanted emissions below 1 GHz must comply with the general field strength limits set forth in §15.209
- (6) In addition, radiated emissions which fall in the restricted bands, as defined in §15.205(a), must also comply with the radiated emission limits specified in §15.209(a)

### Radiated emission limits

Frequency (MHz)	Distance (Meters)	Radiated (dBµV/m)	Radiated (µV/m)
0.009-0.49	3	20log(2400/F(KHz))+40log(300/3)	2400/F(KHz)
0.49-1.705	3	20log(24000/F(KHz))+ 40log(30/3)	24000/F(KHz)
1.705-30	3	20log(30)+ 40log(30/3)	30
30-88	3	40.0	100
88-216	3	43.5	150
216-960	3	46.0	200
Above 960	3	54.0	500

**TEST CONFIGURATION**

(A) Radiated Emission Test Set-Up, Frequency Below 30MHz

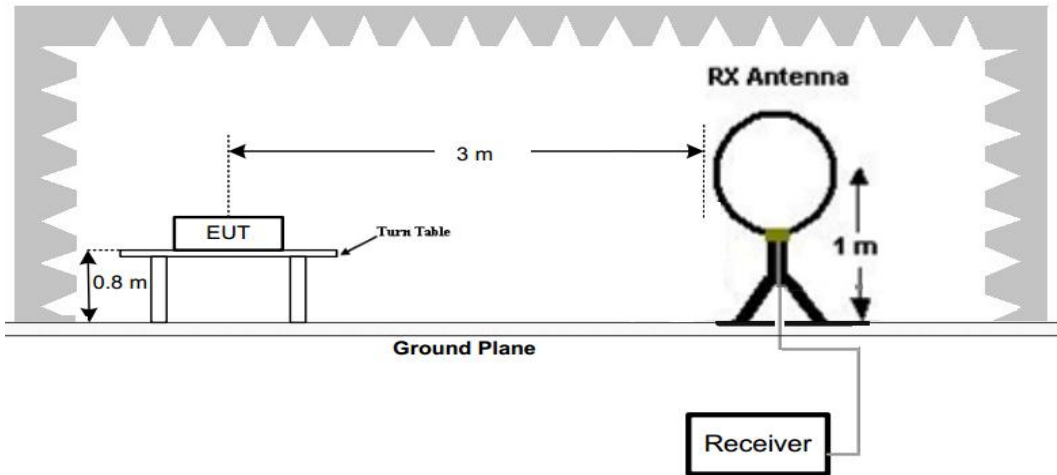

(B) Radiated Emission Test Set-Up, Frequency below 1000MHz

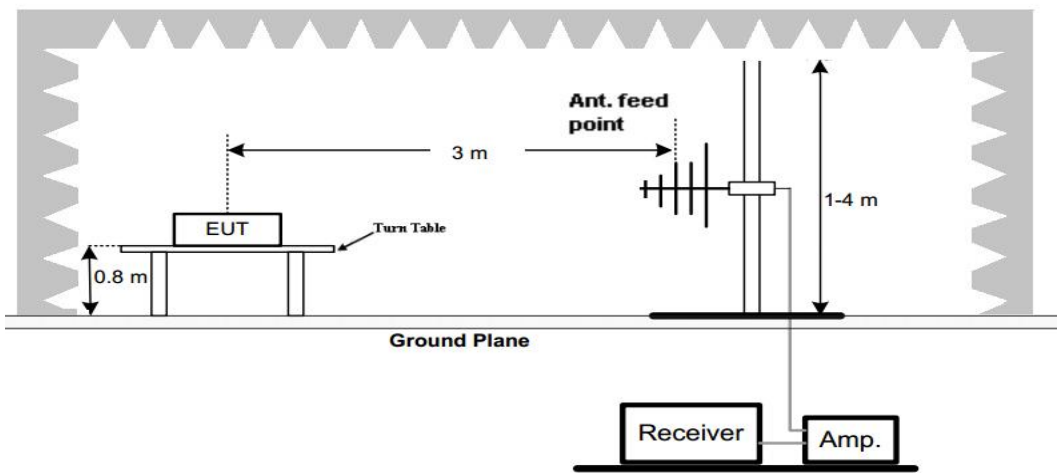

(C) Radiated Emission Test Set-Up, Frequency above 1000MHz

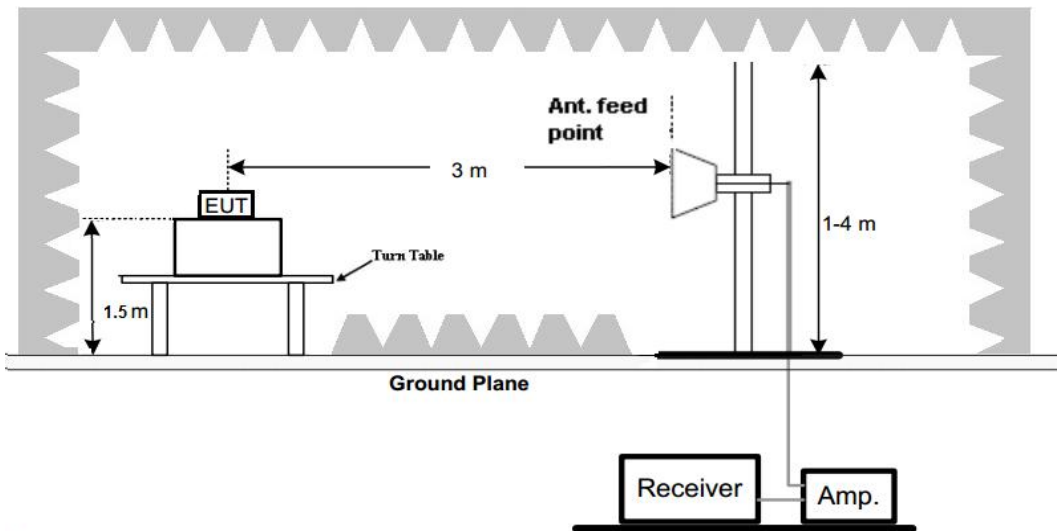



**Test Procedure**

1. Below 1GHz measurement the EUT is placed on a turntable which is 0.8m above ground plane, and above 1GHz measurement EUT was placed on a low permittivity and low loss tangent turn table which is 1.5m above ground plane.
2. Maximum procedure was performed by raising the receiving antenna from 1m to 4m and rotating the turn table from 0° to 360° to acquire the highest emissions from EUT
3. And also, each emission was to be maximized by changing the polarization of receiving antenna both horizontal and vertical.
4. Repeat above procedures until all frequency measurements have been completed.
5. Radiated emission test frequency band from 9KHz to 40GHz.
6. The distance between test antenna and EUT as following table states:

Test Frequency range	Test Antenna Type	Test Distance
9KHz-30MHz	Active Loop Antenna	3
30MHz-1GHz	Bilog Antenna	3
1GHz-18GHz	Horn Antenna	3
18GHz-25GHz	Horn Antenna	1

7. Setting test receiver/spectrum as following table states:

Test Frequency range	Test Receiver/Spectrum Setting	Detector
9KHz-150KHz	RBW=200Hz/VBW=3KHz, Sweep time=Auto	QP
150KHz-30MHz	RBW=9KHz/VBW=100KHz, Sweep time=Auto	QP
30MHz-1GHz	RBW=120KHz/VBW=1000KHz, Sweep time=Auto	QP
1GHz-40GHz	Peak Value: RBW=1MHz/VBW=3MHz, Sweep time=Auto Average Value: RBW=1MHz/VBW=10Hz, Sweep time=Auto	Peak

**TEST RESULTS**

Remark:

1. This test was performed with EUT in X, Y, Z position and the worse case was found when EUT in X position.
2. All modes were tested at Low, Middle, and High channel for above 1GHz test, only the worst case 802.11a CH 36 for antenna 1 was recorded.
3. Radiated emission test from 9 KHz to 10th harmonic of fundamental was verified, and no emission found except system noise floor in 9 KHz to 30MHz and not recorded in this report.

For 30MHz-1GHz

Horizontal

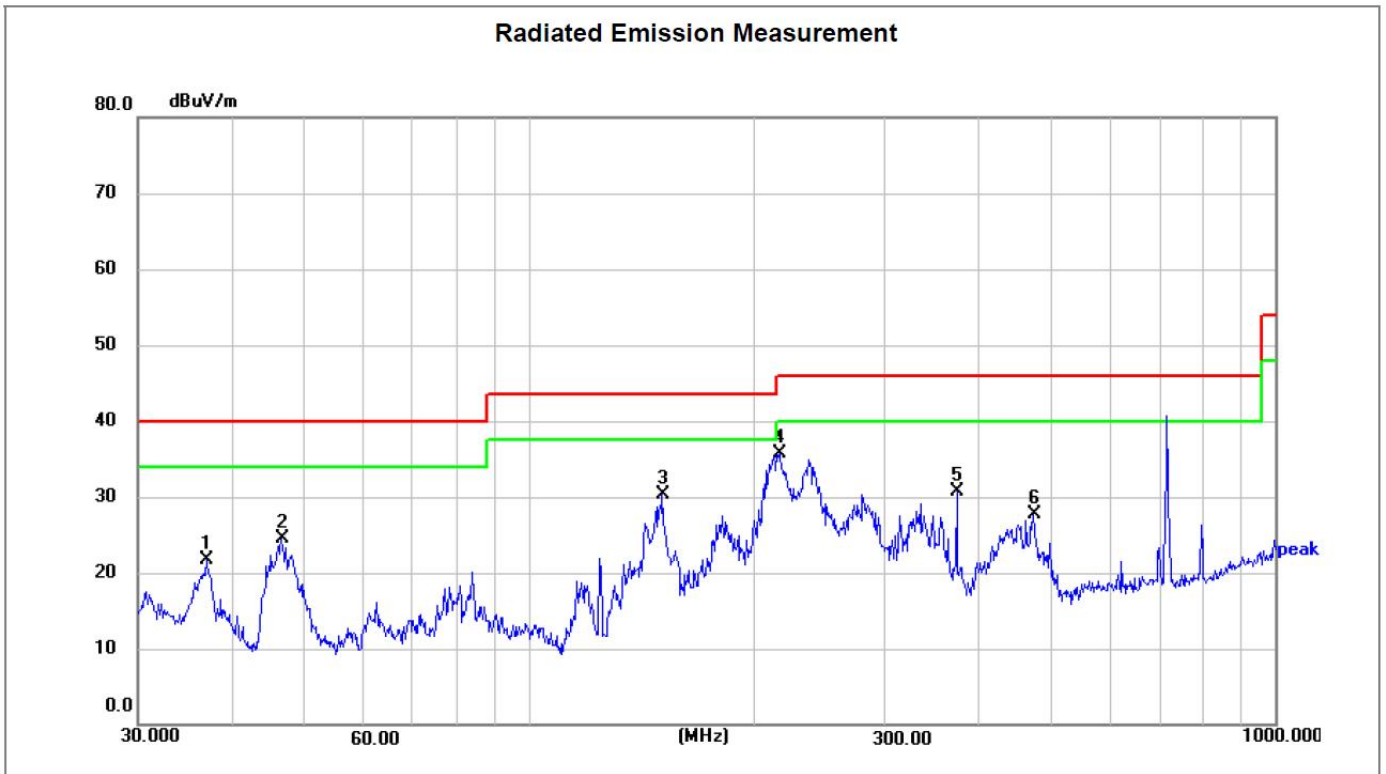

Site LAB Polarization: *Horizontal* Temperature: 24.5(C)  
 Limit: FCC Part15 RE-Class B\_30-1000MHz Power: AC120V/60Hz Humidity: 52 %  
 EUT: Distance: 3m  
 M/N:  
 Mode:  
 Note:

No.	Frequency (MHz)	Reading (dBuV)	Factor (dB/m)	Level (dBuV/m)	Limit (dBuV/m)	Margin (dB)	Detector	Height (cm)	Azimuth (deg.)	P/F	Remark
1	37.0248	40.63	-18.89	21.74	40.00	-18.26	peak	100	34	P	
2	46.6664	41.96	-17.53	24.43	40.00	-15.57	peak	200	275	P	
3	151.0666	51.92	-21.69	30.23	43.50	-13.27	peak	200	8	P	
4 *	216.7828	54.42	-18.78	35.64	46.00	-10.36	peak	100	34	P	
5	374.6225	46.83	-16.13	30.70	46.00	-15.30	peak	100	52	P	
6	473.8347	42.52	-14.77	27.75	46.00	-18.25	peak	200	78	P	

- Note: 1). Level (dBuV/m) = Reading (dBuV) + Factor (dB/m)  
 2). Factor (dB/m) = Antenna Factor (dB/m) + Cable loss (dB) - Pre Amplifier gain (dB)  
 3). Margin (dB) = Level (dBuV/m) - Limit (dBuV/m)

Vertical

Radiated Emission Measurement



Site LAB  
 Limit: FCC Part15 RE-Class B\_30-1000MHz  
 EUT:  
 M/N:  
 Mode:  
 Note:

Polarization: **Vertical**  
 Power: AC120V/60Hz  
 Distance: 3m

Temperature: 24.5(C)  
 Humidity: 52 %

No.	Frequency (MHz)	Reading (dBuV)	Factor (dB/m)	Level (dBuV/m)	Limit (dBuV/m)	Margin (dB)	Detector	Height (cm)	Azimuth (deg.)	P/F	Remark
1 *	36.6408	56.00	-19.03	36.97	40.00	-3.03	QP	100	25	P	
2	62.6507	47.90	-19.46	28.44	40.00	-11.56	peak	100	243	P	
3	139.3613	53.66	-21.99	31.67	43.50	-11.83	peak	100	324	P	
4	210.7860	54.80	-18.86	35.94	43.50	-7.56	peak	100	252	P	
5	265.6757	46.34	-17.88	28.46	46.00	-17.54	peak	100	154	P	
6	468.8762	44.44	-14.85	29.59	46.00	-16.41	peak	100	180	P	

- Note:1). Level (dBμV/m)= Reading (dBμV)+ Factor (dB/m)  
 2). Factor(dB/m)=Antenna Factor (dB/m) + Cable loss (dB) - Pre Amplifier gain (dB)  
 3). Margin(dB) = Level (dBμV/m) - Limit (dBμV/m)

For 1GHz to 40GHz

Note: All modes have been tested for above 1GHz test, only the worst case 802.11ac for antenna 1 was recorded.

**5150-5250MHz:**

***U-NII 1 & 802.11ac Mode (above 1GHz)***

Tested Channel	Frequency (MHz)	Emission Level (dBuV/m)	Detector Mode	ANT Pol	Limit (dBuV/m)	Margin (dB)	Raw Value (dBuV)	Antenna Factor (dB/m)	Cable Factor (dB)	Pre amplifier (dB)	Correction Factor (dB/m)
36.00 (5180MHz)	5150.00	50.72	PK	H	68.20	17.48	69.62	29.91	5.87	54.68	-18.90
	5150.00	35.46	AV	H	54.00	18.54	54.36	29.91	5.87	54.68	-18.90
	10360.00	50.23	PK	H	68.20	17.97	57.15	37.62	10.02	54.56	-6.92
	--	--	--	--	--	--	--	--	--	--	--
40.00 (5200MHz)	10400.00	50.68	PK	H	68.20	17.52	57.10	37.81	10.14	54.37	-6.42
	--	--	--	--	--	--	--	--	--	--	--
48.00 (5240MHz)	5350.50	50.05	PK	H	68.20	18.15	68.62	30.24	5.93	54.74	-18.57
	10480.00	50.49	PK	H	68.20	17.71	57.01	37.95	10.17	54.64	-6.52
	--	--	--	--	--	--	--	--	--	--	--

Tested Channel	Frequency (MHz)	Emission Level (dBuV/m)	Detector Mode	ANT Pol	Limit (dBuV/m)	Margin (dB)	Raw Value (dBuV)	Antenna Factor (dB/m)	Cable Factor (dB)	Pre amplifier (dB)	Correction Factor (dB/m)
36.00 (5180MHz)	5150.00	50.62	PK	V	68.20	17.58	69.52	29.91	5.87	54.68	-18.90
	5150.00	37.28	AV	V	54.00	16.72	56.18	29.91	5.87	54.68	-18.90
	10360.00	50.43	PK	V	68.20	17.77	57.35	37.62	10.02	54.56	-6.92
	--	--	--	--	--	--	--	--	--	--	--
40.00 (5200MHz)	10400.00	50.27	PK	V	68.20	17.93	56.69	37.81	10.14	54.37	-6.42
	--	--	--	--	--	--	--	--	--	--	--
48.00 (5240MHz)	5350.50	50.84	PK	V	68.20	17.36	69.41	30.24	5.93	54.74	-18.57
	10480.00	50.36	PK	V	68.20	17.84	56.88	37.95	10.17	54.64	-6.52
	--	--	--	--	--	--	--	--	--	--	--

**5260-5320MHz:**

***U-NII 1 & 802.11ac Mode (above 1GHz)***

Tested Channel	Frequency (MHz)	Emission Level (dBuV/m)	Detector Mode	ANT Pol	Limit (dBuV/m)	Margin (dB)	Raw Value (dBuV)	Antenna Factor (dB/m)	Cable Factor (dB)	Pre amplifier (dB)	Correction Factor (dB/m)
52.00 5260MHz	5150.00	50.42	PK	H	68.20	17.78	69.32	29.91	5.87	54.68	-18.90
	5150.00	36.34	AV	H	54.00	17.66	55.24	29.91	5.87	54.68	-18.90
	10520.00	50.78	PK	H	68.20	17.42	38.83	38.07	10.21	54.58	-6.30
	--	--	--	--	--	--	--	--	--	--	--
56.00 5280MHz	10560.00	51.04	PK	H	68.20	17.16	56.83	38.43	10.23	54.45	-5.79
	--	--	--	--	--	--	--	--	--	--	--
64.00 5320MHz	5350.50	51.58	PK	H	68.20	16.62	70.15	30.24	5.93	54.74	-18.57
	5350.50	36.44	AV	H	54.00	17.56	55.01	30.24	5.93	54.74	-18.57
	10480.00	50.81	PK	H	68.20	17.39	55.54	39.05	10.78	54.56	-4.73

Tested Channel	Frequency (MHz)	Emission Level (dBuV/m)	Detector Mode	ANT Pol	Limit (dBuV/m)	Margin (dB)	Raw Value (dBuV)	Antenna Factor (dB/m)	Cable Factor (dB)	Pre amplifier (dB)	Correction Factor (dB/m)
52.00 5260MHz	5150.00	50.74	PK	V	68.20	17.46	69.64	29.91	5.87	54.68	-18.90
	5150.00	36.58	AV	V	54.00	17.42	55.48	29.91	5.87	54.68	-18.90
	10520.00	50.91	PK	V	68.20	17.29	38.83	38.07	10.21	54.58	-6.30
	--	--	--	--	--	--	--	--	--	--	--
56.00 5280MHz	10560.00	50.87	PK	V	68.20	17.33	56.66	38.43	10.23	54.45	-5.79
	--	--	--	--	--	--	--	--	--	--	--
64.00 5320MHz	5350.50	50.68	PK	V	68.20	17.52	69.25	30.24	5.93	54.74	-18.57
	5350.50	37.23	AV	V	54.00	16.77	55.80	30.24	5.93	54.74	-18.57
	10480.00	50.48	PK	V	68.20	17.72	55.21	39.05	10.78	54.56	-4.73



REMARKS:

1. Emission level (dBuV/m) =Raw Value (dBuV)+Correction Factor (dB/m)
2. Correction Factor (dB/m) = Antenna Factor (dB/m)+Cable Factor (dB)-Pre-amplifier Factor
3. Margin value = Limit value- Emission level.
4. -- Mean the other emission levels were very low against the limit.
5. RBW1MHz VBW3MHz Peak detector is for PK value; RBW 1MHz VBW10Hz Peak detector is for AV value.
6. Worst case data at 6Mbps at IEEE 802.11a; MCS0 at IEEE 802.11n HT20, IEEE 802.11n HT40, IEEE 802.11ac VHT20 ,IEEE 802.11ac VHT40,IEEE 802.11ac VHT80.

**For Conducted Band edge Measurement  
The test results have included the antenna gain**

*Please refer to Appendix E.*

### 4.3. Duty Cycle

#### TEST CONFIGURATION



#### TEST PROCEDURE

According to KDB789033 D02 General UNII Test Procedures New Rules v01 B Duty Cycle (x), Transmission Duration (T):

- a. A diode detector and an oscilloscope that together have sufficiently short response time to permit accurate measurements of the on and off times of the transmitted signal
- b. The zero-span mode on a spectrum analyzer or EMI receiver, if the response time and spacing between bins on the sweep are sufficient to permit accurate measurements of the on and off times of the transmitted signal. Set the center frequency of the instrument to the center frequency of the transmission. Set  $RBW \geq EBW$  if possible; otherwise, set RBW to the largest available value. Set  $VBW \geq RBW$ . Set detector = peak or average. The zerospan measurement method shall not be used unless both RBW and VBW are  $> 50/T$ , where T is defined in section II.B.1.a), and the number of sweep points across duration T exceeds 100. (For example, if VBW and/or RBW are limited to 3 MHz, then the zero-span method of measuring duty cycle shall not be used if  $T \leq 16.7$  microseconds.)

#### TEST RESULTS

For reporting purpose only.

**Please refer to Appendix B.**



#### 4.4. Maximum Average Output Power

##### TEST CONFIGURATION



##### TEST PROCEDURE

According to KDB789033 D02 General UNII Test Procedures New Rules v01 Section E3 Measurement using a Power Meter (PM):

- a. Measurements may be performed using a wideband RF power meter with a thermocouple detector or equivalent if all of the conditions listed below are satisfied
  - 1. The EUT is configured to transmit continuously or to transmit with a constant duty cycle
  - 2. At all times when the EUT is transmitting, it must be transmitting at its maximum power control level.
  - 3. The integration period of the power meter exceeds the repetition period of the transmitted signal by at least a factor of five.
- b. If the transmitter does not transmit continuously, measure the duty cycle, x, of the transmitter output signal as described in section II.B
- c. Measure the average power of the transmitter. This measurement is an average over both the on and off periods of the transmitter.

Adjust the measurement in dBm by adding  $10 \log(1/x)$  where x is the duty cycle (e.g.,  $10 \log(1/0.25)$  if the duty cycle is 25 percent).

##### LIMIT

According to §15.407(a): The maximum output power should be not exceed follow:

Frequency Range (MHz)	Limit
5150-5250	Fixed: 1 Watt (30dBm) Mobile and portable: 250mW (23.98dBm)
5250-5350	250mW (23.98dBm)
5470-5725	250mW (23.98dBm)
5725-5850	1 Watt (30dBm)

Note: The maximum e.i.r.p at any elevation angle above 30 degrees as measured from the horizon must not exceed 125mW(21dBm)

##### TEST RESULTS

Please refer to Appendix C

### 4.5. Power Spectral Density

#### TEST CONFIGURATION



#### TEST PROCEDURE

According to KDB 789033 D02 General UNII Test Procedures New Rules v01 F: The rules requires “maximum power spectral density” measurements where the intent is to measure the maximum value of the time average of the power spectral density measured during a period of continuous transmission

- a. Create an average power spectrum for the EUT operating mode being tested by following the instructions in section II.E.2. for measuring maximum conducted output power using a spectrum analyzer or EMI receiver: select the appropriate test method (SA-1, SA-2, SA-3, or alternatives to each) and apply it up to, but not including, the step labeled, “Compute power...”. (This procedure is required even if the maximum conducted output power measurement was performed using a power meter, method PM.)
- b. Use the peak search function on the instrument to find the peak of the spectrum and record its value.
- c. Make the following adjustments to the peak value of the spectrum, if applicable:
  1. If Method SA-2 or SA-2 Alternative was used, add  $10 \log(1/x)$ , where x is the duty cycle, to the peak of the spectrum.
  2. ) If Method SA-3 Alternative was used and the linear mode was used in step II.E.2.g)(viii), add 1 dB to the final result to compensate for the difference between linear averaging and power averaging.
- d. The result is the Maximum PSD over 1 MHz reference bandwidth.
- e. For devices operating in the bands 5.15-5.25 GHz, 5.25-5.35 GHz, and 5.47-5.725 GHz, the above procedures make use of 1 MHz RBW to satisfy directly the 1 MHz reference bandwidth specified in § 15.407(a)(5). For devices operating in the band 5.725-5.85 GHz, the rules specify a measurement bandwidth of 500 kHz. Many spectrum analyzers do not have 500 kHz RBW, thus a narrower RBW may need to be used. The rules permit the use of a RBWs less than 1 MHz, or 500 kHz, “provided that the measured power is integrated over the full reference bandwidth” to show the total power over the specified measurement bandwidth (i.e., 1 MHz, or 500 kHz). If measurements are performed using a reduced resolution bandwidth (< 1 MHz, or < 500 kHz) and integrated over 1 MHz, or 500 KHz bandwidth, the following adjustments to the procedures apply:
  1. Set  $RBW \geq 1/T$ , where T is defined in section II.B.1.a).
  2. Set  $VBW \geq 3 RBW$ .
  3. If measurement bandwidth of Maximum PSD is specified in 500 kHz, add  $10\log(500kHz/RBW)$  to the measured result, whereas  $RBW (< 500 KHz)$  is the reduced resolution bandwidth of the spectrum analyzer set during measurement.
  4. If measurement bandwidth of Maximum PSD is specified in 1 MHz, add  $10\log(1MHz/RBW)$  to the measured result, whereas  $RBW (< 1 MHz)$  is the reduced resolution bandwidth of spectrum analyzer set during measurement.
  5. Care must be taken to ensure that the measurements are performed during a period of continuous transmission or are corrected upward for duty cycle.

Note: As a practical matter, it is recommended to use reduced RBW of 100 KHz for the sections 5.c) and 5.d) above, since  $RBW=100 KHz$  is available on nearly all spectrum analyzers.
- f. Adjust the measurement in dBm by adding  $10 \log(1/x)$  where x is the duty cycle (e.g.,  $10 \log(1/0.25)$  if the duty cycle is 25 percent).

#### LIMIT

According to §15.407(a): The maximum output power should be not exceed follow:

Frequency Range (MHz)	Limit
5150-5250	Other then Mobile and portable:17dBm/MHz Mobile and portable:11dBm/MHz
5250-5350	11dBm/MHz
5470-5725	11dBm/MHz
5725-5850	30dBm/500kHz

#### TEST RESULTS

Please refer to Appendix D.

## 4.6. 6dB Bandwidth

### TEST CONFIGURATION



### TEST PROCEDURE

According to KDB789033 D02 General UNII Test Procedures New Rules v01 for one of the following procedures may be used for section 15.407(e) specifies the minimum 6 dB emission bandwidth of at least 500 KHz for the band 5.715-5.85 GHz. The following procedure shall be used for measuring this bandwidth:

- a. Set RBW = shall be in the range of 1% to 5% of the emission bandwidth.
- b. Set the video bandwidth (VBW)  $\geq 3 \times$  RBW
- c. Detector = Peak.
- d. Trace mode = max hold.
- e. Sweep = auto couple.
- f. Allow the trace to stabilize
- g. Measure the maximum width of the emission that is constrained by the frequencies associated with the two outermost amplitude points (upper and lower frequencies) that are attenuated by 6 dB relative to the maximum level measured in the fundamental emission.

Note: The automatic bandwidth measurement capability of a spectrum analyzer or EMI receiver may be employed if it implements the functionality described above.

### LIMIT

For Section 15.407(e) specifies the minimum 6 dB emission bandwidth of at least 500 KHz for the band 5.715-5.85 GHz

### TEST RESULTS

*Please refer to Appendix A2.*

## 4.7. 26dB Bandwidth

### TEST CONFIGURATION



### TEST PROCEDURE

According to KDB789033 D02 General UNII Test Procedures New Rules v01 for one of the following procedures may be used for Emission Bandwidth (EBW) measurement:

- a. Set RBW = shall be in the range of 1% to 5% of the emission bandwidth..
- b. Set the video bandwidth (VBW)  $\geq 3 \times$  RBW
- c. Detector = Peak.
- d. Trace mode = max hold.
- e. Sweep = auto couple.
- f. Allow the trace to stabilize
- g. Measure the maximum width of the emission that is 26 dB down from the maximum of the emission. Compare this with the RBW setting of the analyzer. Readjust RBW and repeat measurement as needed until the RBW/EBW ratio is approximately 1%.

Note: The automatic bandwidth measurement capability of a spectrum analyzer or EMI receiver may be employed if it implements the functionality described above.

### LIMIT

No Limits for 26dBc Bandwidth

### TEST RESULTS

*Please refer to Appendix A1.*

## 4.8. Frequency Stability

### LIMIT

Manufacturers of U-NII devices are responsible for ensuring frequency stability such that an emission is maintained within the band of operation under all conditions of normal operation as specified in the users manual.

### TEST CONFIGURATION

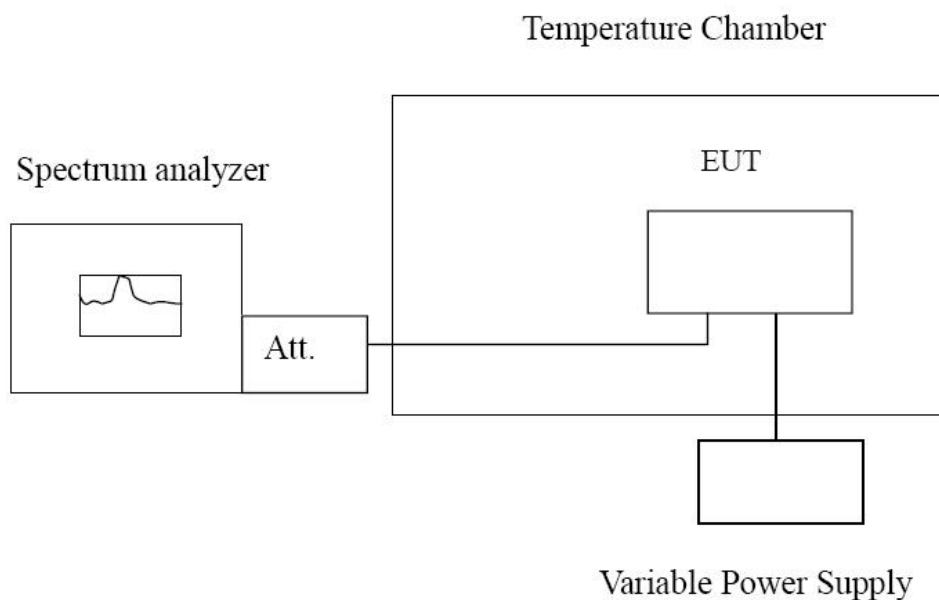

### TEST PROCEDURE

#### **Frequency Stability under Temperature Variations:**

The equipment under test was connected to an external AC or DC power supply and input rated voltage. RF output was connected to a frequency counter or spectrum analyzer via feed through attenuators. The EUT was placed inside the temperature chamber. Set the spectrum analyzer RBW low enough to obtain the desired frequency resolution and measure EUT 20°C operating frequency as reference frequency. Turn EUT off and set the chamber temperature to -30°C. After the temperature stabilized for approximately 30 minutes recorded the frequency. Repeat step measure with 10°C increased per stage until the highest temperature of +50°C reached.

#### **Frequency Stability under Voltage Variations:**

Set chamber temperature to 20°C. Use a variable AC power supply / DC power source to power the EUT and set the voltage to rated voltage. Set the spectrum analyzer RBW low enough to obtain the desired frequency resolution and recorded the frequency.

Reduce the input voltage to specify extreme voltage variation ( $\pm 15\%$ ) and endpoint, record the maximum frequency change.

### TEST RESULTS

*Please refer to Appendix F.*

## 4.9. Antenna Requirement

### Standard Applicable

For intentional device, according to FCC 47 CFR Section 15.203, an intentional radiator shall be designed to ensure that no antenna other than that furnished by the responsible party shall be used with the device.

And according to FCC 47 CFR Section 15.407 (a), if transmitting antennas of directional gain greater than 6dBi are used, the power shall be reduced by the amount in dB that the directional gain of the antenna exceeds 6dBi.

### **Antenna Information**

The maximum gain of antenna was 5.17 dBi for 5GHz WIFI Ant 1, the maximum gain of antenna was 5.17 dBi for 5GHz WIFI Ant 2.

Remark: The antenna gain is provided by the customer, if the data provided by the customer is not accurate, Shenzhen GUOREN Certification Technology Service Co., Ltd. does not assume any responsibility.

## 5. Test Setup Photos of the EUT

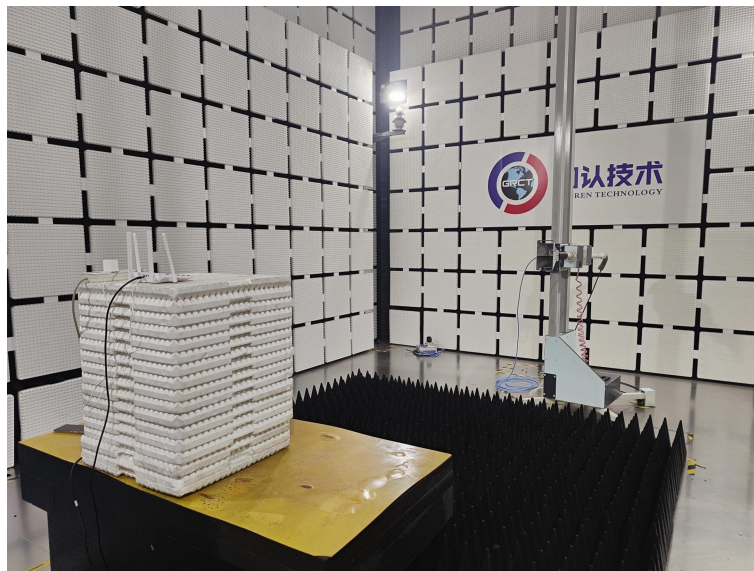
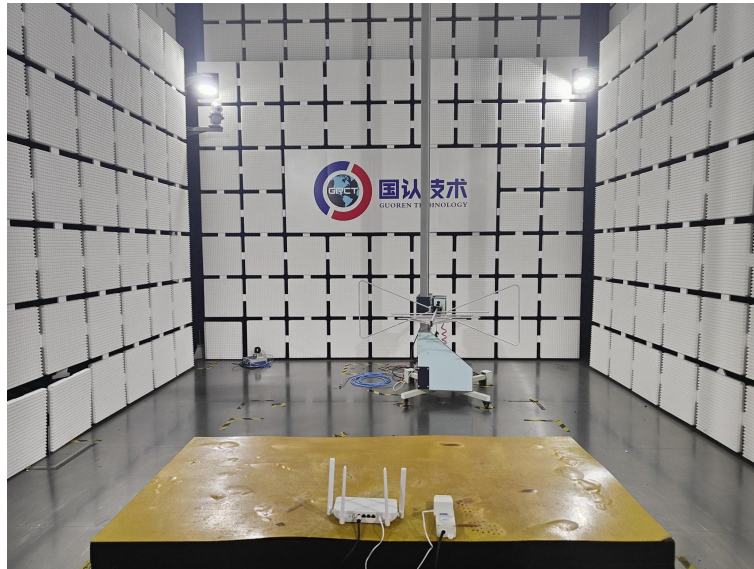

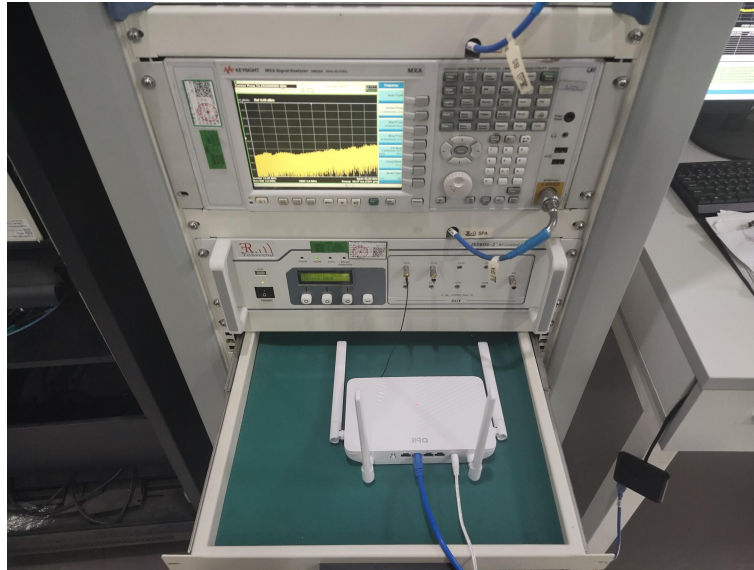

## **6. External and Internal Photos of the EUT**

Reference to the test report No. GRCTR250802012-01

.....**End of Report**.....