

CFR 47 FCC PART 15 SUBPART E

TEST REPORT

For

LTE Smart Phone

MODEL NUMBER: S5506L, GoMo N11, N11

REPORT NUMBER: 4791394016-1-RF-2

ISSUE DATE: September 3, 2024

FCC ID: 2BLEFS5506L

Prepared for

**Maverick Mobile LLC
8101 Ridgpoint Drive, Ste 107, Irving TX USA**

Prepared by

**UL Verification Services (Guangzhou) Co., Ltd, Song Shan Lake Branch
Building 10, Innovation Technology Park, No. 1, Li Bin Road, Song Shan Lake Hi-Tech Development Zone Dongguan, 523808, People's Republic of China**

Tel: +86 769 22038881

Fax: +86 769 33244054

Website: www.ul.com

Revision History

<u>Rev.</u>	<u>Issue Date</u>	<u>Revisions</u>	<u>Revised By</u>
<u>V0</u>	<u>September 3, 2024</u>	<u>Initial Issue</u>	<u></u>

Summary of Test Results

Test Item	Clause	Limit/Requirement	Result
ON TIME AND DUTY CYCLE	ANSI C63.10-2013, Clause 12.2	None; for reporting purposes only.	Pass
6dB AND 26dB EMISSION BANDWIDTH AND 99% OCCUPIED BANDWIDTH	KDB 789033 D02 v02r01 Section C.1	FCC Part 15.407 (a)/(e),	Pass
CONDUCTED OUTPUT POWER	KDB 789033 D02 v02r01 Section E.3.a (Method PM)/KDB 789033 D02 v02r01 Section E.3.a (Method PM) Section E.2.d (Method SA-2)	FCC 15.407 (a)	Pass
POWER SPECTRAL DENSITY	KDB 789033 D02 v02r01 Section F	FCC 15.407 (a)	Pass
AC Power Line Conducted Emission	ANSI C63.10-2013, Clause 6.2.	FCC 15.207	Pass
Radiated Emissions and Band Edge Measurement	KDB 789033 D02 v02r01 Section G.3, G.4, G.5, and G.6	FCC 15.407 (b) FCC 15.209 FCC 15.205	Pass
FREQUENCY STABILITY	ANSI C63.10-2013, Clause 6.8	FCC 15.407 (g)	Pass
Antenna Requirement	N/A	FCC 47 CFR Part 15.203/ 15.407(a)(1) (2),	Pass

*This test report is only published to and used by the applicant, and it is not for evidence purpose in China.

*The measurement result for the sample received is <Pass> according to <CFR 47 FCC PART 15 SUBPART E> when <Simple Acceptance> decision rule is applied.

CONTENTS

1. ATTESTATION OF TEST RESULTS.....	6
2. TEST METHODOLOGY.....	7
3. FACILITIES AND ACCREDITATION.....	7
4. CALIBRATION AND UNCERTAINTY	8
4.1. <i>MEASURING INSTRUMENT CALIBRATION</i>	<i>8</i>
4.2. <i>MEASUREMENT UNCERTAINTY.....</i>	<i>8</i>
5. EQUIPMENT UNDER TEST	9
5.1. <i>DESCRIPTION OF EUT</i>	<i>9</i>
5.2. <i>CHANNEL LIST</i>	<i>10</i>
5.3. <i>MAXIMUM POWER.....</i>	<i>10</i>
5.4. <i>TEST CHANNEL CONFIGURATION.....</i>	<i>10</i>
5.5. <i>THE WORSE CASE POWER SETTING PARAMETER.....</i>	<i>11</i>
5.6. <i>WORSE CASE CONFIGURATIONS.....</i>	<i>12</i>
5.7. <i>DESCRIPTION OF AVAILABLE ANTENNAS</i>	<i>12</i>
5.8. <i>SUPPORT UNITS FOR SYSTEM TEST</i>	<i>13</i>
5.9. <i>SETUP DIAGRAM</i>	<i>13</i>
6. MEASURING EQUIPMENT AND SOFTWARE USED.....	14
7. ANTENNA PORT TEST RESULTS	17
7.1. <i>ON TIME AND DUTY CYCLE.....</i>	<i>17</i>
7.2. <i>6DB AND 26DB EMISSION BANDWIDTH AND 99% OCCUPIED BANDWIDTH ...</i>	<i>18</i>
7.3. <i>CONDUCTED OUTPUT POWER.....</i>	<i>20</i>
7.4. <i>POWER SPECTRAL DENSITY</i>	<i>22</i>
7.5. <i>FREQUENCY STABILITY.....</i>	<i>24</i>
8. RADIATED TEST RESULTS.....	26
8.1. <i>RESTRICTED BANDEDGE</i>	<i>34</i>
8.2. <i>SPURIOUS EMISSIONS(1 GHZ~7 GHZ)</i>	<i>48</i>
8.3. <i>SPURIOUS EMISSIONS(7 GHZ~18 GHZ)</i>	<i>54</i>
8.4. <i>SPURIOUS EMISSIONS(9 KHZ~30 MHZ)</i>	<i>70</i>
8.5. <i>SPURIOUS EMISSIONS(18 GHZ~26 GHZ)</i>	<i>73</i>
8.6. <i>SPURIOUS EMISSIONS(26 GHZ~40 GHZ)</i>	<i>75</i>
8.7. <i>SPURIOUS EMISSIONS(30 MHZ~1 GHZ).....</i>	<i>77</i>

9.	AC POWER LINE CONDUCTED EMISSION	79
10.	ANTENNA REQUIREMENT	83
11.	TEST DATA.....	84
11.1.	<i>APPENDIX A: EMISSION BANDWIDTH.....</i>	<i>84</i>
11.1.1.	Test Result.....	84
11.1.2.	Test Graphs	85
11.2.	<i>APPENDIX B: OCCUPIED CHANNEL BANDWIDTH.....</i>	<i>88</i>
11.2.1.	Test Result.....	88
11.2.2.	Test Graphs	89
11.3.	<i>APPENDIX D: MAXIMUM CONDUCTED OUTPUT POWER.....</i>	<i>92</i>
11.3.1.	Test Result.....	92
11.4.	<i>APPENDIX E: MAXIMUM POWER SPECTRAL DENSITY</i>	<i>93</i>
11.4.1.	Test Result.....	93
11.4.2.	Test Graphs	94
11.5.	<i>APPENDIX F: FREQUENCY STABILITY.....</i>	<i>97</i>
11.5.1.	Test Result.....	97
11.6.	<i>APPENDIX G: DUTY CYCLE.....</i>	<i>98</i>
11.6.1.	Test Result.....	98
11.6.2.	Test Graphs	99
	APPENDIX: PHOTOGRAPHS OF TEST CONFIGURATION	100
	APPENDIX: PHOTOGRAPHS OF THE EUT	100

1. ATTESTATION OF TEST RESULTS

Applicant Information

Company Name: Maverick Mobile LLC
Address: 8101 Ridgepoint Drive, Ste 107, Irving TX USA

Manufacturer Information

Company Name: Maverick Mobile LLC
Address: 8101 Ridgepoint Drive, Ste 107, Irving TX USA

EUT Information

EUT Name: LTE Smart Phone
Model: S5506L
Series Model: GoMo N11, N11
Model Difference: Referred to section 5.1
Brand: GoMo
Sample Received Date: July 4, 2024
Sample Status: Normal
Sample ID: 7398632
Date of Tested: July 19, 2024 to September 3, 2024

APPLICABLE STANDARDS	
STANDARD	TEST RESULTS
CFR 47 FCC PART 15 SUBPART E	Pass

Prepared By:

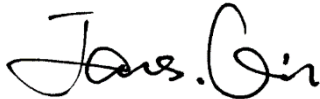

James Qin
Project Engineer

Checked By:

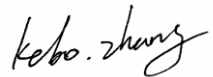

Kebo Zhang
Senior Project Engineer

Approved By:



Stephen Guo
Operations Manager

2. TEST METHODOLOGY

All tests were performed in accordance with the standard CFR 47 FCC PART 15 SUBPART E, ANSI C63.10-2013, CFR 47 FCC Part 2, KDB 789033 D02 v02r01, KDB 414788 D01 Radiated Test Site v01r01, KDB 662911 D01 Multiple Transmitter Output v02r01, KDB 905462 D02 UNII DFS Compliance Procedures New Rules v02, KDB 905462 D03 UNII clients without radar detection New Rules v01r02, KDB 905462 D04 Operational Modes for DFS Testing New Rules v01 and KDB 905462 D06 802 11 Channel Plans New Rules v02.

3. FACILITIES AND ACCREDITATION

Accreditation Certificate	<p>A2LA (Certificate No.: 4102.01) UL Verification Services (Guangzhou) Co., Ltd. Song Shan Lake Branch. has been assessed and proved to be in compliance with A2LA.</p> <p>FCC (FCC Designation No.: CN1187) UL Verification Services (Guangzhou) Co., Ltd. Song Shan Lake Branch. Has been recognized to perform compliance testing on equipment subject to the Commission's Declaration of Conformity (DoC) and Certification rules</p> <p>ISED (Company No.: 21320) UL Verification Services (Guangzhou) Co., Ltd. Song Shan Lake Branch. has been registered and fully described in a report filed with ISED. The Company Number is 21320 and the test lab Conformity Assessment Body Identifier (CABID) is CN0046.</p> <p>VCCI (Registration No.: G-20192, C-20153, T-20155 and R-20202) UL Verification Services (Guangzhou) Co., Ltd. Song Shan Lake Branch. has been assessed and proved to be in compliance with VCCI, the Membership No. is 3793. Facility Name: Chamber D, the VCCI registration No. is G-20192 and R-20202 Shielding Room B, the VCCI registration No. is C-20153 and T-20155</p>
---------------------------	---

Note 1:

All tests measurement facilities use to collect the measurement data are located at Building 10, Innovation Technology Park, No. 1, Li Bin Road, Song Shan Lake Hi-Tech Development Zone Dongguan, 523808, People's Republic of China.

Note 2:

The test anechoic chamber in UL Verification Services (Guangzhou) Co., Ltd. Song Shan Lake Branch had been calibrated and compared to the open field sites and the test anechoic chamber is shown to be equivalent to or worst case from the open field site.

Note 3:

For below 30 MHz, lab had performed measurements at test anechoic chamber and comparing to measurements obtained on an open field site. And these measurements below 30 MHz had been correlated to measurements performed on an OFS.

4. CALIBRATION AND UNCERTAINTY

4.1. MEASURING INSTRUMENT CALIBRATION

The measuring equipment utilized to perform the tests documented in this report has been calibrated in accordance with the manufacturer's recommendations and is traceable to recognized national standards.

4.2. MEASUREMENT UNCERTAINTY

Where relevant, the following measurement uncertainty levels have been estimated for tests performed on the apparatus:

Test Item	Uncertainty
Conduction emission	3.62 dB
Radiated Emission (Included Fundamental Emission) (9 kHz ~ 30 MHz)	2.2 dB
Radiated Emission (Included Fundamental Emission) (30 MHz ~ 1 GHz)	4.00 dB
Radiated Emission (Included Fundamental Emission) (1 GHz to 40 GHz)	5.78 dB (1 GHz ~ 18 GHz)
	5.23 dB (18 GHz ~ 26 GHz)
	5.37 dB (26 GHz ~ 40 GHz)
Duty Cycle	±0.028%
Emission Bandwidth and 99% Occupied Bandwidth	±0.0196%
Maximum Conducted Output Power	±0.766 dB
Maximum Power Spectral Density Level	±1.22 dB
Frequency Stability	±2.76%
Dynamic Frequency Selection	±1.01 dB
Conducted Band-edge Compliance	±1.328 dB
Conducted Unwanted Emissions In Non-restricted Frequency Bands	±0.746 dB (9 kHz ~ 1 GHz)
	±1.328dB (1 GHz ~ 26 GHz)
Note: This uncertainty represents an expanded uncertainty expressed at approximately the 95% confidence level using a coverage factor of k=2.	

5. EQUIPMENT UNDER TEST

5.1. DESCRIPTION OF EUT

EUT Name	LTE Smart Phone
Model	S5506L
Series Model	GoMo N11, N11
Model Difference:	GoMo N11, N11 have the same technical construction including circuit diagram, PCB Layout, components and component layout, all electrical construction and mechanical construction with S5506L. The difference lies only the model number. all these changes do not degrade the unwanted emissions of the certified product.

Frequency Band:	5150 MHz to 5250 MHz (U-NII-1)
Frequency Range:	5180 MHz to 5240
Support Standards:	CFR 47 FCC PART 15 SUBPART E
TPC Function:	Support
DFS Operational mode:	Slave without radar detection
Type of Modulation:	IEEE 802.11a: OFDM(64QAM, 16QAM, QPSK, BPSK) IEEE 802.11n: OFDM(64QAM, 16QAM, QPSK, BPSK)
Data Rate:	IEEE 802.11a: Up to 54 Mbps IEEE 802.11n-HT20: Up to MCS15 IEEE 802.11n-HT40: Up to MCS15
Antenna Type:	FPC Antenna
Antenna Gain:	-2.97 dBi
Normal Test Voltage:	Conducted item: DC 3.8 V All other test item: AC 120V_60Hz
EUT Test software:	MTK

5.2. CHANNEL LIST

UNII-1 (For Bandwidth=20MHz)		UNII-1 (For Bandwidth=40MHz)	
Channel	Frequency (MHz)	Channel	Frequency (MHz)
36	5180	38	5190
40	5200	46	5230
44	5220		
48	5240		

5.3. MAXIMUM POWER

UNII-1 BAND

IEEE Std. 802.11	Frequency (MHz)	Maximum Average Conducted Power (dBm)
a	5150 ~ 5250	12.90
n HT20		12.82
n HT40		12.94

5.4. TEST CHANNEL CONFIGURATION

UNII-1 Test Channel Configuration		
IEEE Std.	Test Channel Number	Frequency
802.11a	CH 36(Low Channel), CH 40(MID Channel), CH 48(High Channel)	5180 MHz, 5200 MHz, 5240 MHz
802.11n HT20	CH 36(Low Channel), CH 40(MID Channel), CH 48(High Channel)	5180 MHz, 5200 MHz, 5240 MHz
802.11n HT40	CH 38(Low Channel), CH 46(High Channel)	5190 MHz, 5230 MHz

5.5. THE WORSE CASE POWER SETTING PARAMETER

The Worse Case Power Setting Parameter		
Test Software	MTK	
Mode	Freq(MHz)	Power setting
802.11a	5180	15.0
	5200	15.0
	5240	15.0
802.11n 20M	5180	15.0
	5200	15.0
	5240	15.0
802.11n 40M	5190	15.0
	5230	15.0

5.6. WORSE CASE CONFIGURATIONS

The EUT was tested in the following configuration(s):

Controlled in test mode using a software application on the EUT supplied by customer. The application was used to enable a continuous transmission and to select the mode, test channels, bandwidth, data rates as required.

Test channels referring to section 5.4.

Maximum power setting referring to section 5.5.

Worst case Data Rates declared by the customer:

802.11a 20 mode: 6 Mbps
802.11n HT20 mode: MCS0
802.11n HT40 mode: MCS0

802.11a/n HT20/HT40 only support SISO mode.

The measured additional path loss was included in any path loss calculations for all RF cable used during tested.

5.7. DESCRIPTION OF AVAILABLE ANTENNAS

Antenna No.	Frequency Band	Antenna Type	Max Antenna Gain (dBi)
1	5150-5850	FPC antenna	-2.97

IEE Std. 802.11	Transmit and Receive Mode	Description
802.11a	☒1TX, 1RX	ANT 1 can be used as transmitting/receiving antenna.
802.11n HT20	☒1TX, 1RX	ANT 1 can be used as transmitting/receiving antenna.
802.11n HT40	☒1TX, 1RX	ANT 1 can be used as transmitting/receiving antenna.
802.11ac VHT20	☒1TX, 1RX	ANT 1 can be used as transmitting/receiving antenna.
802.11ac VHT40	☒1TX, 1RX	ANT 1 can be used as transmitting/receiving antenna.

5.8. SUPPORT UNITS FOR SYSTEM TEST

The EUT has been tested as an independent unit

5.9. SETUP DIAGRAM

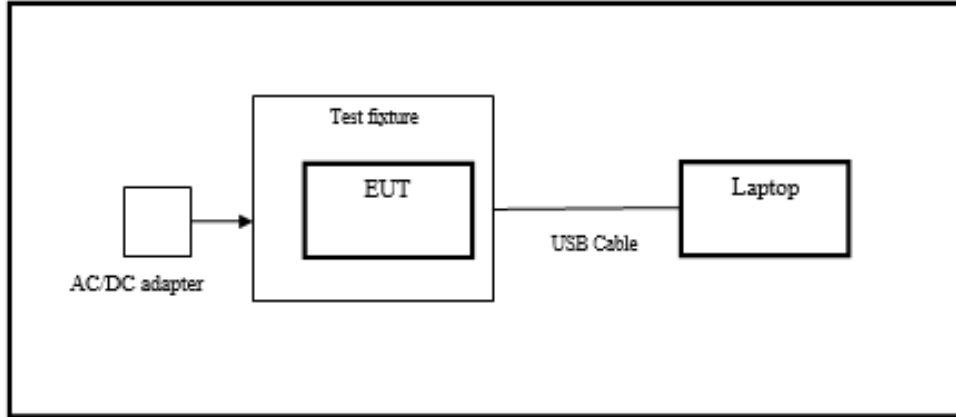

6. MEASURING EQUIPMENT AND SOFTWARE USED

R&S TS 8997 Test System					
Equipment	Manufacturer	Model No.	Serial No.	Last Cal.	Due. Date
Power sensor, Power Meter	R&S	OSP120	100921	Mar.25,2024	Mar.24,2025
Vector Signal Generator	R&S	SMBV100A	261637	Oct.12, 2023	Oct.11, 2024
Signal Generator	R&S	SMB100A	178553	Oct.12, 2023	Oct.11, 2024
Signal Analyzer	R&S	FSV40	101118	Oct.12, 2023	Oct.11, 2024
Software					
Description	Manufacturer	Name		Version	
For R&S TS 8997 Test System	Rohde & Schwarz	EMC 32		10.60.10	
Tonsend RF Test System					
Equipment	Manufacturer	Model No.	Serial No.	Last Cal.	Due. Date
Wideband Radio Communication Tester	R&S	CMW500	155523	Oct.12, 2023	Oct.11, 2024
Wireless Connectivity Tester	R&S	CMW270	1201.0002N75-102	Sep.25, 2023	Sep.24, 2024
PXA Signal Analyzer	Keysight	N9030A	MY55410512	Oct.12, 2023	Oct.11, 2024
MXG Vector Signal Generator	Keysight	N5182B	MY56200284	Oct.12, 2023	Oct.11, 2024
MXG Vector Signal Generator	Keysight	N5172B	MY56200301	Oct.12, 2023	Oct.11, 2024
DC power supply	Keysight	E3642A	MY55159130	Oct.12, 2023	Oct.11, 2024
Temperature & Humidity Chamber	SANMOOD	SG-80-CC-2	2088	Oct.12, 2023	Oct.11, 2024
Attenuator	Aglient	8495B	2814a12853	Oct.12, 2023	Oct.11, 2024
RF Control Unit	Tonscend	JS0806-2	23B80620666	Mar.25,2024	Mar.24,2025
Software					
Description	Manufacturer	Name		Version	
Tonsend SRD Test System	Tonsend	JS1120-3 RF Test System		V3.2.22	

Conducted Emissions					
Equipment	Manufacturer	Model No.	Serial No.	Last Cal.	Due Date
EMI Test Receiver	R&S	ESR3	101961	Oct.13, 2023	Oct.12, 2024
Two-Line V-Network	R&S	ENV216	101983	Oct.13, 2023	Oct.12, 2024
Artificial Mains Networks	Schwarzbeck	NSLK 8126	8126465	Oct.13, 2023	Oct.12, 2024
Software					
Description			Manufacturer	Name	Version
Test Software for Conducted Emissions			Farad	EZ-EMC	Ver. UL-3A1

Radiated Emissions					
Equipment	Manufacturer	Model No.	Serial No.	Last Cal.	Due Date
MXE EMI Receiver	KESIGHT	N9038A	MY56400036	Oct.12, 2023	Oct.11, 2024
Hybrid Log Periodic Antenna	TDK	HLP-3003C	130960	Jun. 28, 2024	Jun. 27, 2027
Preamplifier	HP	8447D	2944A09099	Oct.12, 2023	Oct.11, 2024
EMI Measurement Receiver	R&S	ESR26	101377	Oct.12, 2023	Oct.11, 2024
Horn Antenna	TDK	HRN-0118	130939	April 29, 2022	April 30, 2025
Preamplifier	TDK	PA-02-0118	TRS-305-00067	Oct.12, 2023	Oct.11, 2024
Horn Antenna	Schwarzbeck	BBHA9170	856	Feb 28, 2022	Feb 28, 2025
Preamplifier	TDK	PA-02-2	TRS-307-00003	Oct.12, 2023	Oct.11, 2024
Preamplifier	TDK	PA-02-3	TRS-308-00002	Oct.12, 2023	Oct.11, 2024
Loop antenna	Schwarzbeck	1519B	00008	Dec.14, 2021	Dec.13, 2024
Preamplifier	TDK	PA-02-001-3000	TRS-302-00050	Oct.12, 2023	Oct.11, 2024
Highpass Filter	Wainwright	WHKX10-5850-6500-1800-40SS	4	Oct.12, 2023	Oct.11, 2024
Band Reject Filter	Wainwright	WRCJV20-5120-5150-5350-5380-60SS	2	Oct.12, 2023	Oct.11, 2024
Software					
Description			Manufacturer	Name	Version
Test Software for Radiated Emissions			Farad	EZ-EMC	Ver. UL-3A1

Other Instrument					
Equipment	Manufacturer	Model No.	Serial No.	Last Cal.	Due Date
Temperature humidity probe	OMEGA	ITHX-SD-5	18470007	Oct.21, 2023	Oct.20, 2024
Barometer	Yiyi	Baro	N/A	Oct.19, 2023	Oct.18, 2024
Attenuator	Agilent	8495B	2814a12853	Oct.12, 2023	Oct.11, 2024

7. ANTENNA PORT TEST RESULTS

7.1. ON TIME AND DUTY CYCLE

LIMITS

None; for reporting purposes only.

TEST PROCEDURE

Refer to KDB 789033 D02 General U-NII Test Procedures New Rules v02r01 section II.B.

The zero-span mode on a spectrum analyzer or EMI receiver, if the response time and spacing between bins on the sweep are sufficient to permit accurate measurements of the on and off times of the transmitted signal. Set the center frequency of the instrument to the center frequency of the transmission. Set $RBW \geq EBW$ if possible; otherwise, set RBW to the largest available value. Set $VBW \geq RBW$. Set detector = peak or average. The zero-span measurement method shall not be used unless both RBW and VBW are $> 50/T$, where T is defined in II.B.1.a), and the number of sweep points across duration T exceeds 100. (For example, if VBW and/or RBW are limited to 3 MHz, then the zero-span method of measuring duty cycle shall not be used if $T \leq 16.7$ microseconds.)

TEST SETUP

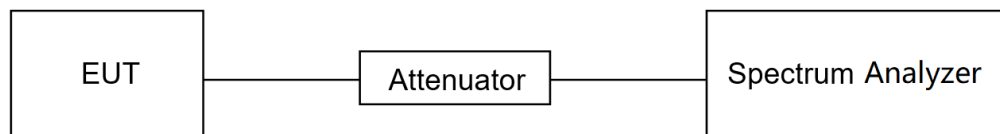

TEST ENVIRONMENT

Temperature	25.8°C	Relative Humidity	61.8%
Atmosphere Pressure	101kPa	Test Voltage	DC 3.8 V

TEST DATE / ENGINEER

Test Date	July 26, 2024	Test By	Bairong Liu
-----------	---------------	---------	-------------

TEST RESULTS

Please refer to section "Test Data" - Appendix G

7.2. 6DB AND 26DB EMISSION BANDWIDTH AND 99% OCCUPIED BANDWIDTH

LIMITS

CFR 47 FCC Part15, Subpart E		
Test Item	Limit	Frequency Range (MHz)
26 dB Emission Bandwidth	For reporting purposes only.	5150 ~ 5250

TEST PROCEDURE

Refer to KDB 789033 D02 General U-NII Test Procedures New Rules v02r01 section II.C1. for 26 dB Emission Bandwidth; section II.C2. for 6 dB Emission Bandwidth; section II.D. for 99 % Occupied Bandwidth.

Connect the EUT to the spectrum analyser and use the following settings:

Center Frequency	The center frequency of the channel under test
Detector	Peak
RBW	For 6 dB Emission Bandwidth: RBW=100 kHz For 26 dB Emission bandwidth: approximately 1 % of the EBW. For 99 % Occupied Bandwidth: approximately 1 % ~ 5 % of the OBW.
VBW	For 6 dB Bandwidth: $\geq 3 \times \text{RBW}$ For 26 dB Bandwidth: $> 3 \times \text{RBW}$ For 99 % Bandwidth: $> 3 \times \text{RBW}$
Trace	Max hold
Sweep	Auto couple

a) Use the 99 % power bandwidth function of the instrument, allow the trace to stabilize and report the measured bandwidth.

b) Allow the trace to stabilize and measure the maximum width of the emission that is constrained by the frequencies associated with the two outermost amplitude points (upper and lower frequencies) that are attenuated by 6/26 dB relative to the maximum level measured in the fundamental emission.

TEST SETUP

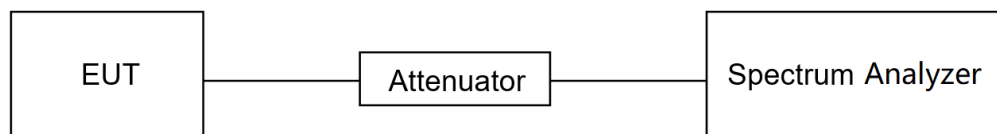

TEST ENVIRONMENT

Temperature	25.8°C	Relative Humidity	61.8%
Atmosphere Pressure	101kPa	Test Voltage	DC 3.8 V

TEST DATE / ENGINEER

Test Date	July 26, 2024	Test By	Bairong Liu
-----------	---------------	---------	-------------

TEST RESULTS

Please refer to section "Test Data" - Appendix A&B

7.3. CONDUCTED OUTPUT POWER

LIMITS

CFR 47 FCC Part15, Subpart E		
Test Item	Limit	Frequency Range (MHz)
Conducted Output Power	<input type="checkbox"/> Outdoor Access Point: 1 W (30 dBm) <input type="checkbox"/> Indoor Access Point: 1 W (30 dBm) <input type="checkbox"/> Fixed Point-To-Point Access Points: 1 W (30 dBm) <input checked="" type="checkbox"/> Client Devices: 250 mW (24 dBm)	5150 ~ 5250

Note:

The above limits are based upon the maximum antenna gain does not exceed 6 dBi. If transmitting antennas of directional gain greater than 6 dBi are used, the maximum conducted output power shall be reduced by the amount in dB that the directional gain of the antenna exceeds 6 dBi.

TEST PROCEDURE

Refer to KDB 789033 D02 General U-NII Test Procedures New Rules v02r01 section II.E.

Method PM (Measurement using an RF average power meter):

(i) Measurements may be performed using a wideband RF power meter with a thermocouple detector or equivalent if all of the following conditions are satisfied:

- a. The EUT is configured to transmit continuously or to transmit with a constant duty cycle.
- b. At all times when the EUT is transmitting, it must be transmitting at its maximum power control level.
- c. The integration period of the power meter exceeds the repetition period of the transmitted signal by at least a factor of five.

(ii) If the transmitter does not transmit continuously, measure the duty cycle, x, of the transmitter output signal as described in II.B.

(iii) Measure the average power of the transmitter. This measurement is an average over both the on and off periods of the transmitter.

(iv) Adjust the measurement in dBm by adding $10 \log (1/x)$ where x is the duty cycle (e.g., $10 \log (1/0.25)$ if the duty cycle is 25 %).

TEST SETUP

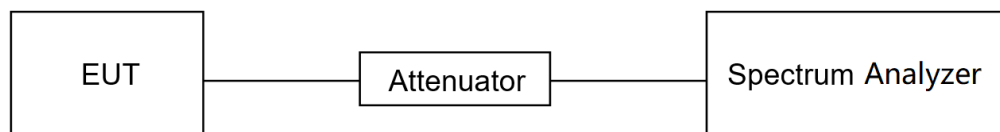

TEST ENVIRONMENT

Temperature	25.8°C	Relative Humidity	61.8%
Atmosphere Pressure	101kPa	Test Voltage	DC 3.8 V

TEST DATE / ENGINEER

Test Date	July 26, 2024	Test By	Bairong Liu
-----------	---------------	---------	-------------

TEST RESULTS

Please refer to section "Test Data" - Appendix D

7.4. POWER SPECTRAL DENSITY

LIMITS

CFR 47 FCC Part15, Subpart E		
Test Item	Limit	Frequency Range (MHz)
Power Spectral Density	<input type="checkbox"/> Outdoor Access Point: 17 dBm/MHz <input type="checkbox"/> Indoor Access Point: 17 dBm/MHz <input type="checkbox"/> Fixed Point-To-Point Access Points: 17 dBm/MHz <input checked="" type="checkbox"/> Client Devices: 11 dBm/MHz	5150 ~ 5250

Note:

The above limits are based upon the maximum antenna gain does not exceed 6 dBi. If transmitting antennas of directional gain greater than 6 dBi are used, maximum power spectral density shall be reduced by the amount in dB that the directional gain of the antenna exceeds 6 dBi.

TEST PROCEDURE

Refer to KDB 789033 D02 General U-NII Test Procedures New Rules v02r01 section II.F.

Connect the EUT to the spectrum analyzer and use the following settings:

For U-NII-1 band:

Center Frequency	The center frequency of the channel under test
Detector	RMS
RBW	1 MHz
VBW	$\geq 3 \times \text{RBW}$
Span	Encompass the entire emissions bandwidth (EBW) of the signal
Trace	Average
Sweep time	Auto

Allow trace to fully stabilize and use the peak search function on the instrument to find the peak of the spectrum and record its value.

Add $10 \log(1/x)$, where x is the duty cycle, to the peak of the spectrum, the result is the Maximum PSD over 1 MHz / 500 kHz reference bandwidth.

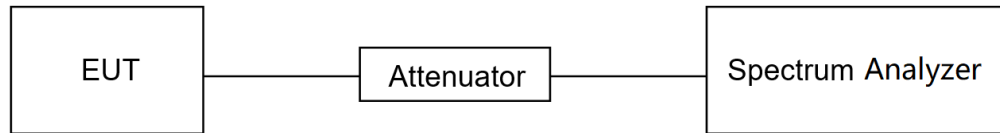
TEST SETUP**TEST ENVIRONMENT**

Temperature	25.8°C	Relative Humidity	61.8%
Atmosphere Pressure	101kPa	Test Voltage	DC 3.8 V

TEST DATE / ENGINEER

Test Date	July 26, 2024	Test By	Bairong Liu
-----------	---------------	---------	-------------

TEST RESULTS

Please refer to section "Test Data" - Appendix E

7.5. FREQUENCY STABILITY

LIMITS

The frequency of the carrier signal shall be maintained within band of operation.

TEST PROCEDURE

1. The EUT was placed inside an environmental chamber as the temperature in the chamber was varied between 0 °C ~ 35 °C (declared by customer).
2. The temperature was incremented by 10 °C intervals and the unit allowed to stabilize at each temperature before each measurement. The center frequency of the transmitting channel was evaluated at each temperature and the frequency deviation from the channel's center frequency was recorded.
3. The primary supply voltage is varied from 85 % to 115 % of the nominal value for non hand-carried battery and AC powered equipment. For hand-carried, battery-powered equipment, primary supply voltage is reduced to the battery operating end point which shall be specified by the manufacturer.

Connect the EUT to the spectrum analyzer and use the following settings:

Center Frequency	The center frequency of the channel under test
Detector	Peak
RBW	10 kHz
VBW	$\geq 3 \times \text{RBW}$
Span	Encompass the entire emissions bandwidth (EBW) of the signal
Trace	Max hold
Sweep time	Auto

4. While maintaining a constant temperature inside the environmental chamber, turn the EUT on and record the operating frequency at startup, and at 2 minutes, 5 minutes, and 10 minutes after the EUT is energized.
5. Allow the trace to stabilize, find the peak value of the power envelope and record the frequency, then calculated the frequency drift.

TEST ENVIRONMENT

	Normal Test Conditions	Extreme Test Conditions
Relative Humidity	20 % ~ 75 %	/
Atmospheric Pressure	100 kPa ~ 102 kPa	/
Temperature	T _N (Normal Temperature): 25.1 °C	T _L (Low Temperature): 0 °C
		T _H (High Temperature): 35 °C
Supply Voltage	V _N (Normal Voltage): DC 3.8 V	V _L (Low Voltage): DC 3,23 V
		V _H (High Voltage): DC 4.37 V

TEST SETUP

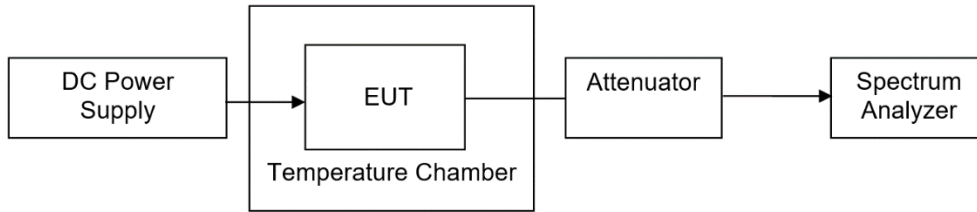

TEST ENVIRONMENT

Temperature	25.8°C	Relative Humidity	61.8%
Atmosphere Pressure	101kPa	Test Voltage	DC 3.8 V

TEST DATE / ENGINEER

Test Date	July 26, 2024	Test By	Bairong Liu
-----------	---------------	---------	-------------

TEST RESULTS

Please refer to section "Test Data" - Appendix F

8. RADIATED TEST RESULTS

LIMITS

Refer to CFR 47 FCC §15.205, §15.209 and §15.407 (b).

Radiation Disturbance Test Limit for FCC (Class B) (9 kHz ~ 1 GHz)

Emissions radiated outside of the specified frequency bands above 30 MHz			
Frequency Range (MHz)	Field Strength Limit (uV/m) at 3 m	Field Strength Limit (dBuV/m) at 3 m	
		Quasi-Peak	
30 - 88	100	40	
88 - 216	150	43.5	
216 - 960	200	46	
Above 960	500	54	
Above 1000	500	Peak	Average
		74	54

FCC Emissions radiated outside of the specified frequency bands below 30 MHz		
Frequency (MHz)	Field strength (microvolts/meter)	Measurement distance (meters)
0.009-0.490	2400/F(kHz)	300
0.490-1.705	24000/F(kHz)	30
1.705-30.0	30	30

FCC Restricted bands of operation refer to FCC §15.205 (a):

MHz	MHz	MHz	GHz
0.090-0.110	16.42-16.423	399.9-410	4.5-5.15
¹ 0.495-0.505	16.69475-16.69525	608-614	5.35-5.46
2.1735-2.1905	16.80425-16.80475	960-1240	7.25-7.75
4.125-4.128	25.5-25.67	1300-1427	8.025-8.5
4.17725-4.17775	37.5-38.25	1435-1626.5	9.0-9.2
4.20725-4.20775	73-74.6	1645.5-1646.5	9.3-9.5
6.215-6.218	74.8-75.2	1660-1710	10.6-12.7
6.26775-6.26825	108-121.94	1718.8-1722.2	13.25-13.4
6.31175-6.31225	123-138	2200-2300	14.47-14.5
8.291-8.294	149.9-150.05	2310-2390	15.35-16.2
8.362-8.366	156.52475-156.52525	2483.5-2500	17.7-21.4
8.37625-8.38675	156.7-156.9	2690-2900	22.01-23.12
8.41425-8.41475	162.0125-167.17	3260-3267	23.6-24.0
12.29-12.293	167.72-173.2	3332-3339	31.2-31.8
12.51975-12.52025	240-285	3345.8-3358	36.43-36.5
12.57675-12.57725	322-335.4	3600-4400	(²)
13.36-13.41			

Note: ¹Until February 1, 1999, this restricted band shall be 0.490-0.510 MHz.

²Above 38.6c

Limits of unwanted/undesirable emission out of the restricted bands refer to CFR 47 FCC §15.407 (b).

LIMITS OF RADIATED EMISSION MEASUREMENT (Above 1GHz)		
Frequency Range (MHz)	EIRP Limit	Field Strength Limit (dBuV/m) at 3 m
5150~5250 MHz	PK: -27 (dBm/MHz)	PK:68.2(dBμV/m)
Note: *1 beyond 75 MHz or more above of the band edge. *2 below the band edge increasing linearly to 10 dBm/MHz at 25 MHz above. *3 below the band edge increasing linearly to a level of 15.6 dBm/MHz at 5 MHz above. *4 from 5 MHz above or below the band edge increasing linearly to a level of 27 dBm/MHz at the band edge.		

TEST PROCEDURE

Below 30 MHz

The setting of the spectrum analyzer

RBW	200 Hz (From 9 kHz to 0.15 MHz)/ 9 kHz (From 0.15 MHz to 30 MHz)
VBW	200 Hz (From 9 kHz to 0.15 MHz)/ 9 kHz (From 0.15 MHz to 30 MHz)
Sweep	Auto

1. The testing follows the guidelines in ANSI C63.10-2013 clause 6.4.
2. The EUT was arranged to its worst case and then turntable (from 0 degree to 360 degrees) to find the maximum reading. A pre-amp and a high pass filter are used for the test in order to get better signal level. Both Horizontal, Face-on and Face-off polarizations of the antenna are set to make the measurement.

3. The EUT was placed on a turntable with 80 cm above ground.
4. The EUT was set 3 meters from the interference receiving antenna, which was mounted on the top of a 1 m height antenna tower.
5. The radiated emission limits are based on measurements employing a CISPR quasi-peak detector except for the frequency bands 9-90 kHz, 110-490 kHz and above 1000 MHz Radiated emission limits in these three bands are based on measurements employing an average detector.
6. For measurement below 1 GHz, the initial step in collecting conducted emission data is a spectrum analyzer peak detector mode pre-scanning the measurement frequency range. Significant peaks are then marked and then Quasi Peak and average detector mode re-measured. If the emission level of the EUT measured by the peak detector is 3 dB lower than the applicable limit, the peak emission level will be reported. Otherwise, the emission measurement will be repeated using the quasi-peak and average detector and reported.
7. Although these tests were performed other than open field site, adequate comparison measurements were confirmed against 30m open field site. Therefore sufficient tests were made to demonstrate that the alternative site produces results that correlate with the ones of tests made in an open field site based on KDB 414788.
8. The limits in CFR 47, Part 15, Subpart C, paragraph 15.209 (a), are identical to those in RSS-GEN Section 8.9, Table 6, since the measurements are performed in terms of magnetic field strength and converted to electric field strength levels (as reported in the table) using the free space impedance of 377Ω . For example, the measurement frequency X kHz resulted in a level of Y dBuV/m, which is equivalent to $Y-51.5 = Z$ dBuA/m, which has the same margin, W dB, to the corresponding RSS-GEN Table 6 limit as it has to be 15.209(a) limit.

Below 1 GHz and above 30 MHz

The setting of the spectrum analyzer

RBW	120 kHz
VBW	300 kHz
Sweep	Auto
Detector	Peak/QP
Trace	Max hold

1. The testing follows the guidelines in ANSI C63.10-2013 clause 6.5.
2. The EUT was arranged to its worst case and then tune the antenna tower (from 1 m to 4 m) and turntable (from 0 degree to 360 degrees) to find the maximum reading. A pre-amp and a high pass filter are used for the test in order to get better signal level. Both horizontal and vertical polarizations of the antenna are set to make the measurement.
3. The EUT was placed on a turntable with 80 cm above ground.
4. The EUT was set 3 meters from the interference receiving antenna, which was mounted on the top of a variable height antenna tower.
5. For measurement below 1 GHz, the initial step in collecting conducted emission data is a spectrum analyzer peak detector mode pre-scanning the measurement frequency range. Significant peaks are then marked and then Quasi Peak detector mode re-measured. If the emission level of the EUT measured by the peak detector is 3 dB lower than the applicable limit, the peak emission level will be reported. Otherwise, the emission measurement will be repeated using the quasi-peak detector and reported.

Above 1 GHz

The setting of the spectrum analyzer

RBW	1 MHz
VBW	PEAK: 3 MHz AVG: see note 6
Sweep	Auto
Detector	Peak
Trace	Max hold

1. The testing follows the guidelines in KDB 789033 D02 General U-NII Test Procedures New Rules v02r01 section II.G.3 ~ II.G.6.
2. The EUT was arranged to its worst case and then tune the antenna tower (from 1 m to 4 m) and turntable (from 0 degree to 360 degrees) to find the maximum reading. A pre-amp and a high pass filter are used for the test in order to get better signal level. Both horizontal and vertical polarizations of the antenna are set to make the measurement.
3. The EUT was placed on a turntable with 1.5 m above ground.
4. The EUT was set 3 meters from the interference receiving antenna, which was mounted on the top of a variable height antenna tower.
5. For measurement above 1 GHz, the emission measurement will be measured by the peak detector. This peak level, once corrected, must comply with the limit specified in Section 15.209.
6. For measurements above 1 GHz the resolution bandwidth is set to 1 MHz, then the video bandwidth is set to 3 MHz for peak measurements and 1 MHz resolution bandwidth with 1/T video bandwidth with peak detector for average measurements. For the Duty Cycle please refer to clause 7.1. ON TIME AND DUTY CYCLE.

X axis, Y axis, Z axis positions:

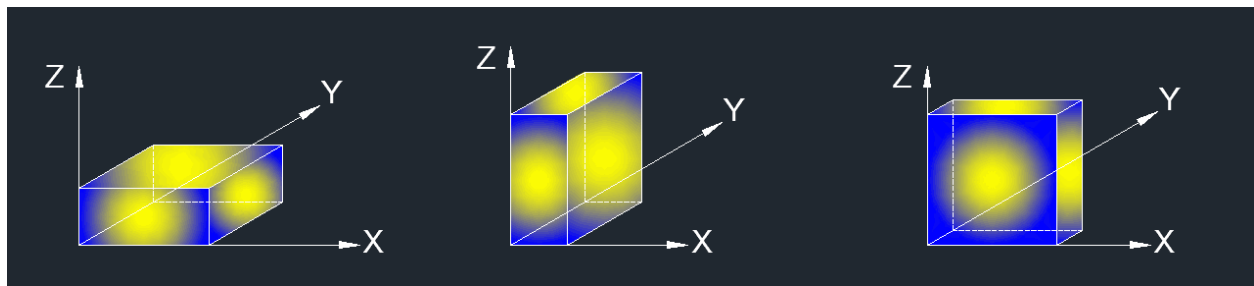

Note 1: For all radiated test, EUT in each of three orthogonal axis emissions had been tested, but only the worst case (X axis) data recorded in the report.

Note 2: The EUT was fully exercised with external accessories during the test. In the case of multiple accessory external ports, an external accessory shall be connected to one of each type of port.

For Restricted Bandedge:

Note:

1. Measurement = Reading Level + Correct Factor.
2. If the peak values are less than the average limit of 54 dBuV/m, the average result is deemed to comply with average limit.
3. PK=Peak: Peak detector.
4. AV=Average: VBW=1/Ton, where: Ton is the transmitting duration.
5. For the transmitting duration, please refer to clause 7.1.
6. Only the worst data was recorded, if it complies with the limit, the other emissions deemed to comply with the limit.
7. Both horizontal and vertical have been tested, only the worst data was recorded in the report.
8. All modes have been tested, but only the worst data was recorded in the report.

For Radiate Spurious emission (9 kHz ~ 30 MHz):**Note:**

1. Measurement = Reading Level + Correct Factor.
2. If the peak values are less than the QP limit, the QP result is deemed to comply with QP limit.
3. All 3 polarizations (Horizontal, Face-on and Face-off) of the loop antenna had been tested, but only the worst data recorded in the report.
4. All modes have been tested, but only the worst data was recorded in the report.
5. dBuA/m= dBuV/m- 20Log10[120π] = dBuV/m- 51.5

For Radiate Spurious Emission (30 MHz ~ 1 GHz):**Note:**

1. Result Level = Read Level + Correct Factor.
2. If the peak values are less than the QP limit, the QP result is deemed to comply with QP limit.
3. All modes have been tested, but only the worst data was recorded in the report.

For Radiate Spurious Emission (1 GHz ~ 7 GHz):

1. Measurement = Reading Level + Correct Factor.
2. If the peak values are less than the average limit of 54 dBuV/m, the average result is deemed to comply with average limit.
3. Peak: Peak detector.
4. AVG: VBW=1/Ton, where: Ton is the transmitting duration.
5. For the transmitting duration, please refer to clause 7.1.
6. Filter losses were only considered in the spurious frequency bands and the authorized band was not corrected for Band reject filter losses.
7. Proper operation of the transmitter prior to adding the filter to the measurement chain.
8. Since non-restricted band peak emissions are less than the average limit, they also comply with the -27 dBm/MHz (68.2 dBuV/m) limit.
9. All modes have been tested, but only the worst data was recorded in the report.

For Radiate Spurious Emission (7 GHz ~ 18 GHz):

Note:

1. Peak Result = Reading Level + Correct Factor.
2. If the peak values are less than the average limit of 54 dBuV/m, the average result is deemed to comply with average limit.
3. Peak: Peak detector.
4. AVG: $VBW=1/T_{on}$, where: T_{on} is the transmitting duration.
5. For the transmitting duration, please refer to clause 7.1.
6. Filter losses were only considered in the spurious frequency bands and the authorized band was not corrected for High Pass Filter losses.
7. Proper operation of the transmitter prior to adding the filter to the measurement chain.
8. Since non-restricted band peak emissions are less than the average limit, they also comply with the -27 dBm/MHz (68.2 dBuV/m) limit.
9. All modes have been tested, but only the worst data was recorded in the report.

For Radiate Spurious emission (18 GHz ~ 26 GHz):

Note:

1. Measurement = Reading Level + Correct Factor.
2. If the peak values are less than the average limit of 54 dBuV/m, the average result is deemed to comply with average limit.
3. Peak: Peak detector.
4. All modes have been tested, but only the worst data was recorded in the report.

For Radiate Spurious emission (26 GHz ~ 40 GHz):

Note:

1. Measurement = Reading Level + Correct Factor.
2. If the peak values are less than the average limit of 54 dBuV/m, the average result is deemed to comply with average limit.
3. Peak: Peak detector.
4. All modes have been tested, but only the worst data was recorded in the report.

TEST SETUP

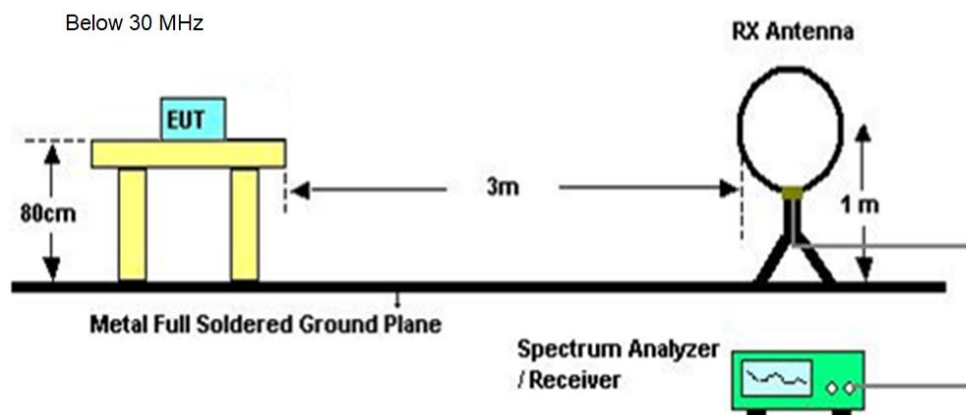

Below 1 GHz and above 30 MHz

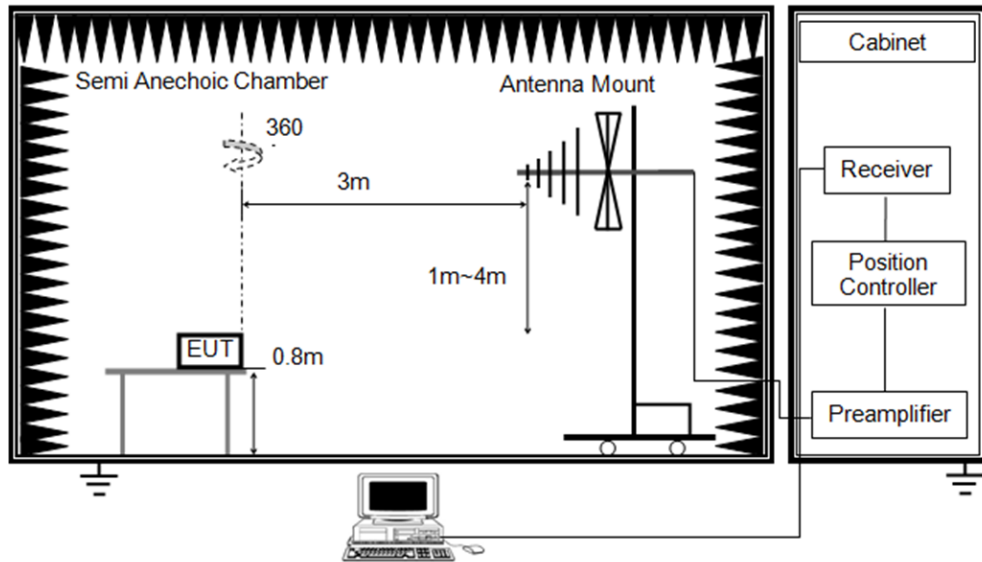

Above 1GHz

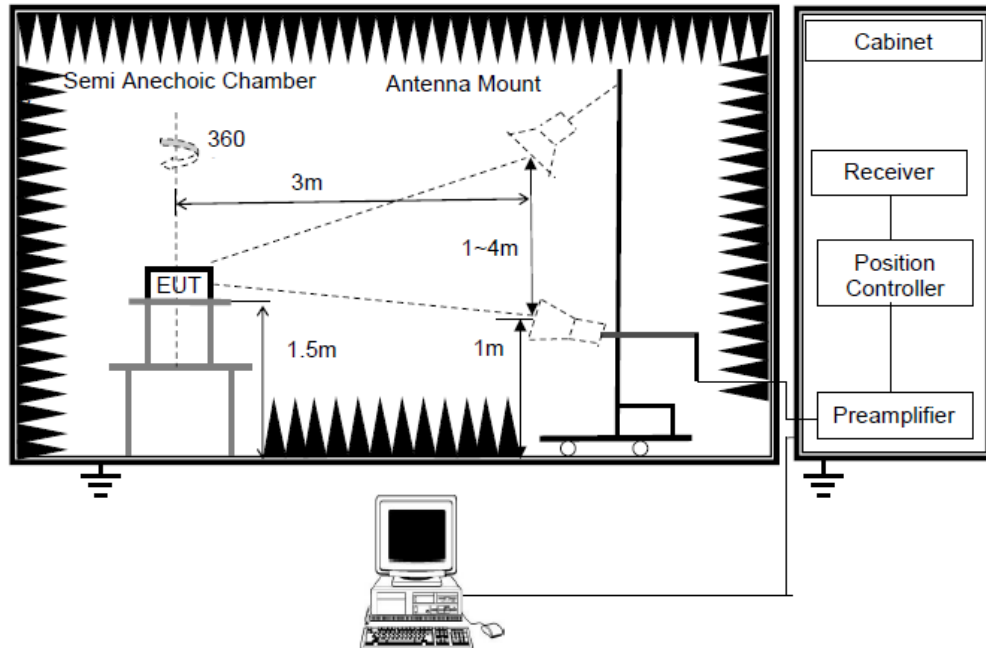

TEST ENVIRONMENT

Temperature	23.1°C	Relative Humidity	63.4%
Atmosphere Pressure	101kPa	Test Voltage	

TEST DATE / ENGINEER

Test Date	August 14, 2024	Test By	Mason Wang
-----------	-----------------	---------	------------

TEST RESULTS

8.1. RESTRICTED BANDEDGE

Test Mode:	802.11a 20 PK	Frequency(MHz):	5180
Polarity:	Horizontal	Test Voltage:	AC 120V_60HZ

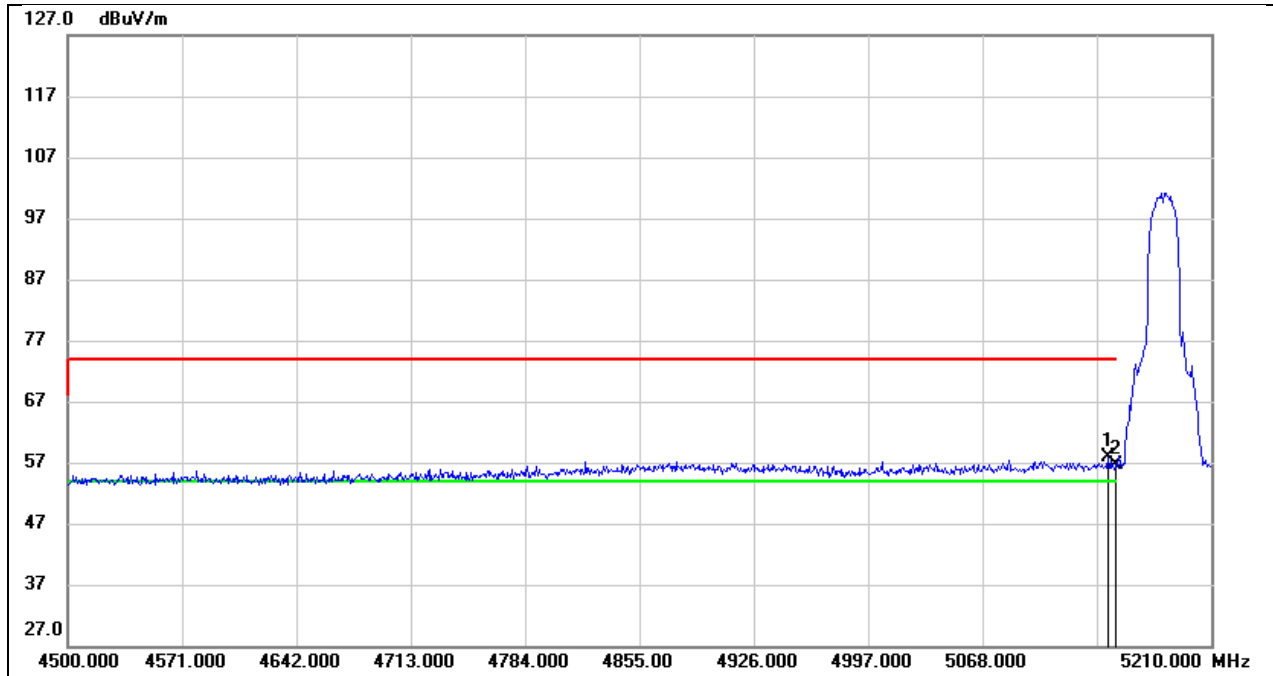

No.	Frequency (MHz)	Reading (dBuV)	Correct (dB/m)	Result (dBuV/m)	Limit (dBuV/m)	Margin (dB)	Remark
1	5146.100	17.61	40.28	57.89	74.00	-16.11	peak
2	5150.000	16.31	40.29	56.60	74.00	-17.40	peak

Test Mode:	802.11a 20 AV	Frequency(MHz):	5180
Polarity:	Horizontal	Test Voltage:	AC 120V_60HZ

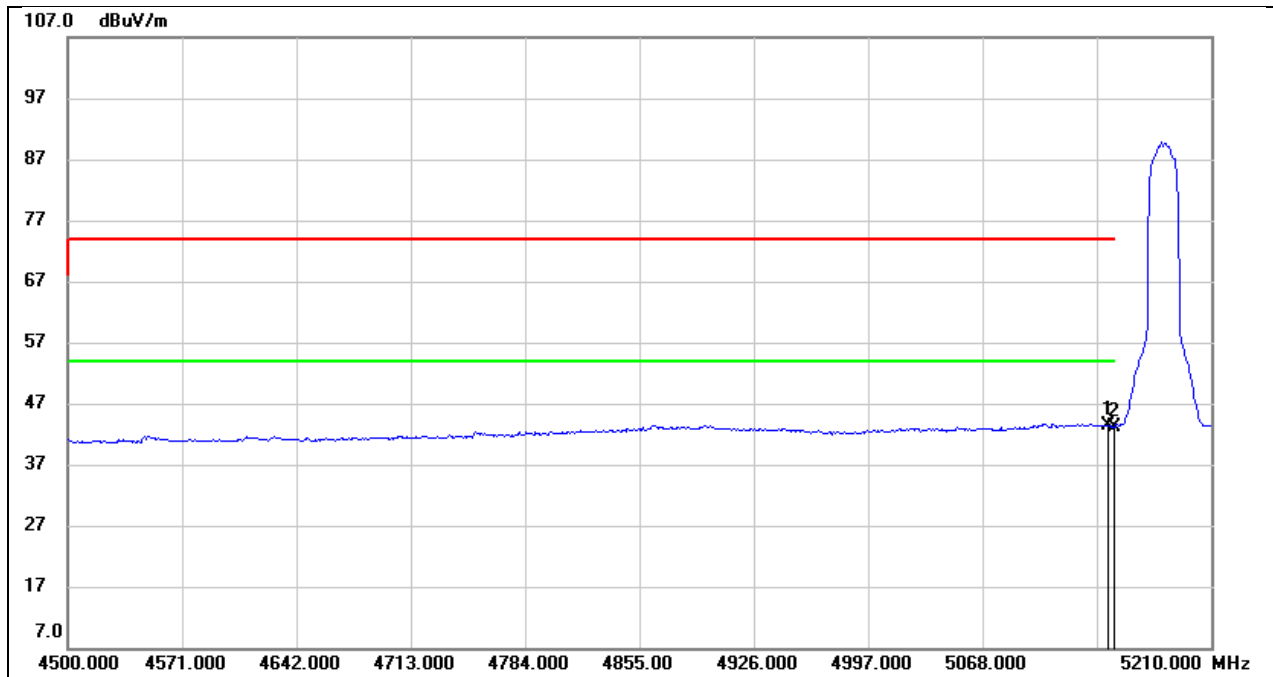

No.	Frequency (MHz)	Reading (dBuV)	Correct (dB/m)	Result (dBuV/m)	Limit (dBuV/m)	Margin (dB)	Remark
1	5146.100	3.10	40.28	43.38	54.00	-10.62	AVG
2	5150.000	2.92	40.29	43.21	54.00	-10.79	AVG

Test Mode:	802.11a 20 PK	Frequency(MHz):	5180
Polarity:	Vertical	Test Voltage:	AC 120V_60HZ

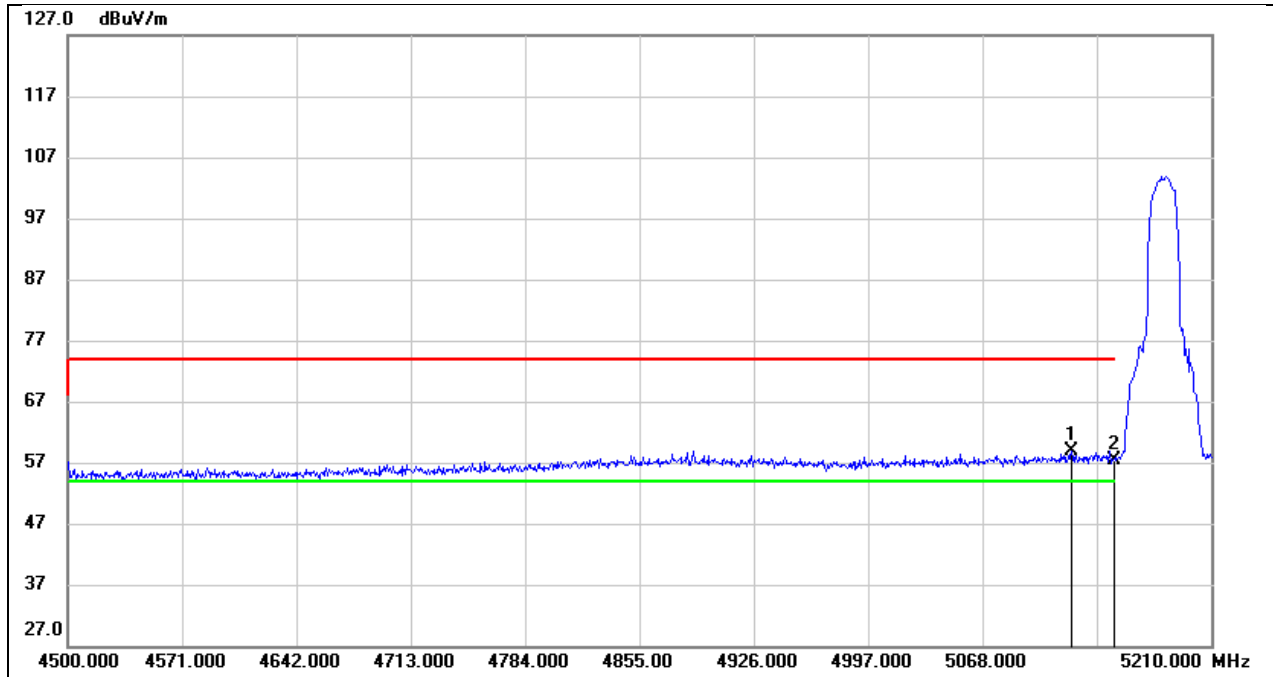

No.	Frequency (MHz)	Reading (dBuV)	Correct (dB/m)	Result (dBuV/m)	Limit (dBuV/m)	Margin (dB)	Remark
1	5123.380	17.57	41.42	58.99	74.00	-15.01	peak
2	5150.000	15.99	41.49	57.48	74.00	-16.52	peak

Test Mode:	802.11a 20 AV	Frequency(MHz):	5180
Polarity:	Vertical	Test Voltage:	AC 120V_60HZ

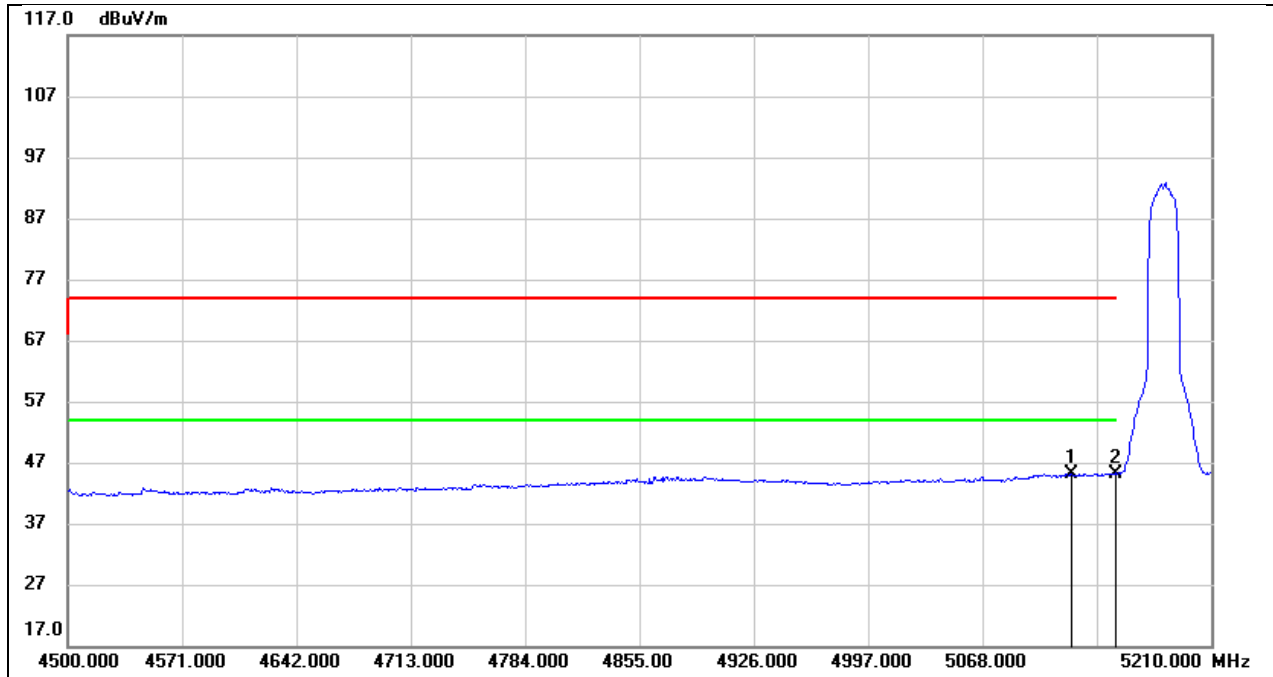

No.	Frequency (MHz)	Reading (dBuV)	Correct (dB/m)	Result (dBuV/m)	Limit (dBuV/m)	Margin (dB)	Remark
1	5123.380	3.70	41.42	45.12	54.00	-8.88	AVG
2	5150.000	3.66	41.49	45.15	54.00	-8.85	AVG

Test Mode:	802.11a 20 PK	Frequency(MHz):	5240
Polarity:	Vertical	Test Voltage:	AC 120V_60HZ

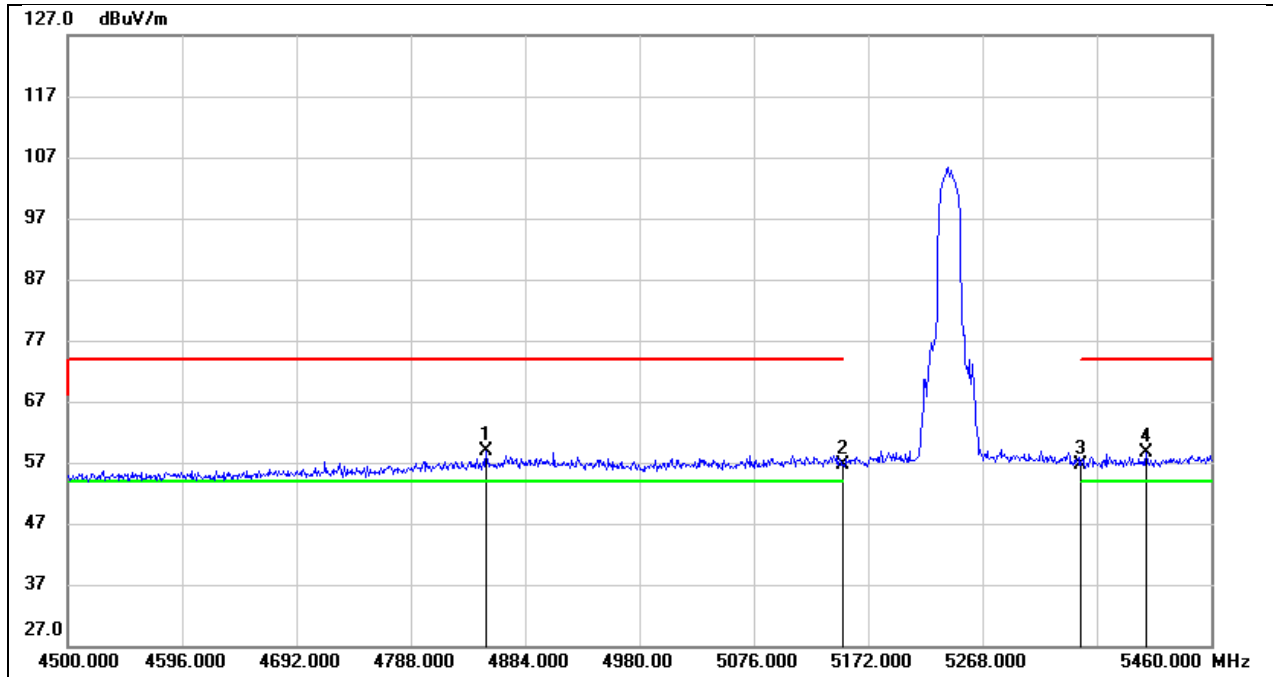

No.	Frequency (MHz)	Reading (dBuV)	Correct (dB/m)	Result (dBuV/m)	Limit (dBuV/m)	Margin (dB)	Remark
1	4851.360	18.37	40.61	58.98	74.00	-15.02	peak
2	5150.000	15.15	41.49	56.64	74.00	-17.36	peak
3	5350.000	15.10	41.58	56.68	74.00	-17.32	peak
4	5405.280	17.13	41.60	58.73	74.00	-15.27	peak

Test Mode:	802.11a 20 AV	Frequency(MHz):	5240
Polarity:	Vertical	Test Voltage:	AC 120V_60HZ

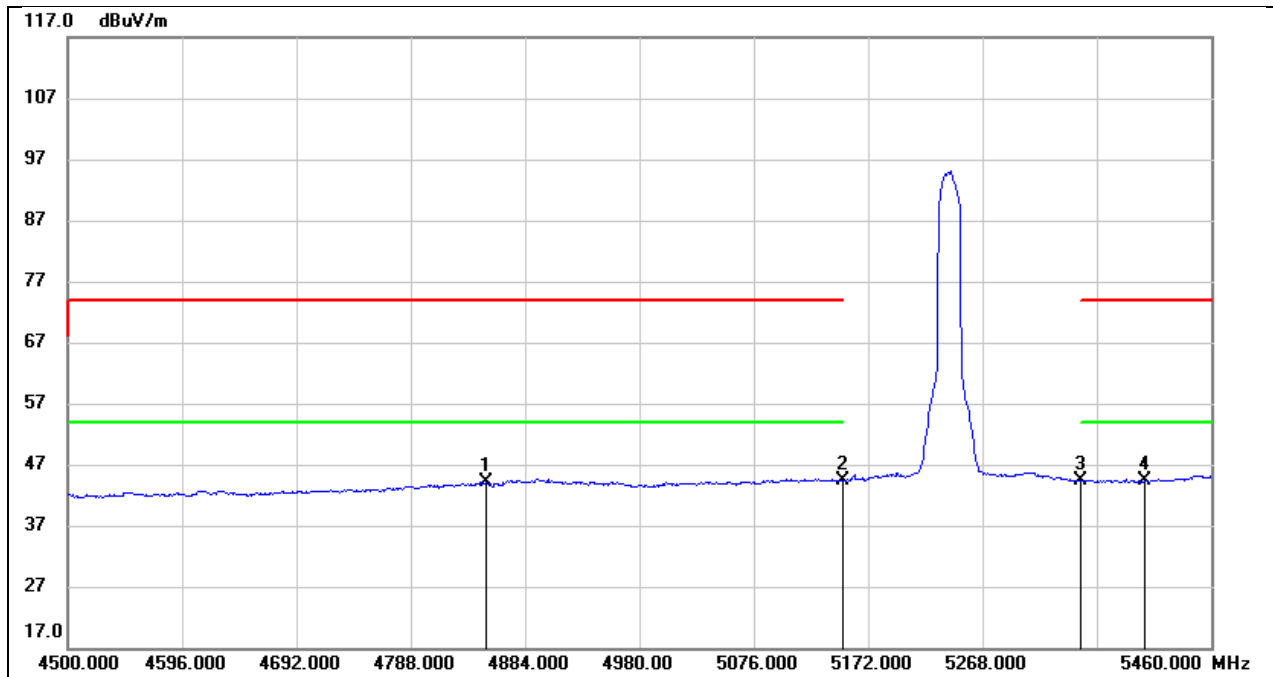

No.	Frequency (MHz)	Reading (dBuV)	Correct (dB/m)	Result (dBuV/m)	Limit (dBuV/m)	Margin (dB)	Remark
1	4851.360	3.51	40.61	44.12	54.00	-9.88	AVG
2	5150.000	2.87	41.49	44.36	54.00	-9.64	AVG
3	5350.000	2.83	41.58	44.41	54.00	-9.59	AVG
4	5405.280	2.78	41.60	44.38	54.00	-9.62	AVG

Test Mode:	802.11n HT20 PK	Frequency(MHz):	5180
Polarity:	Vertical	Test Voltage:	AC 120V_60HZ

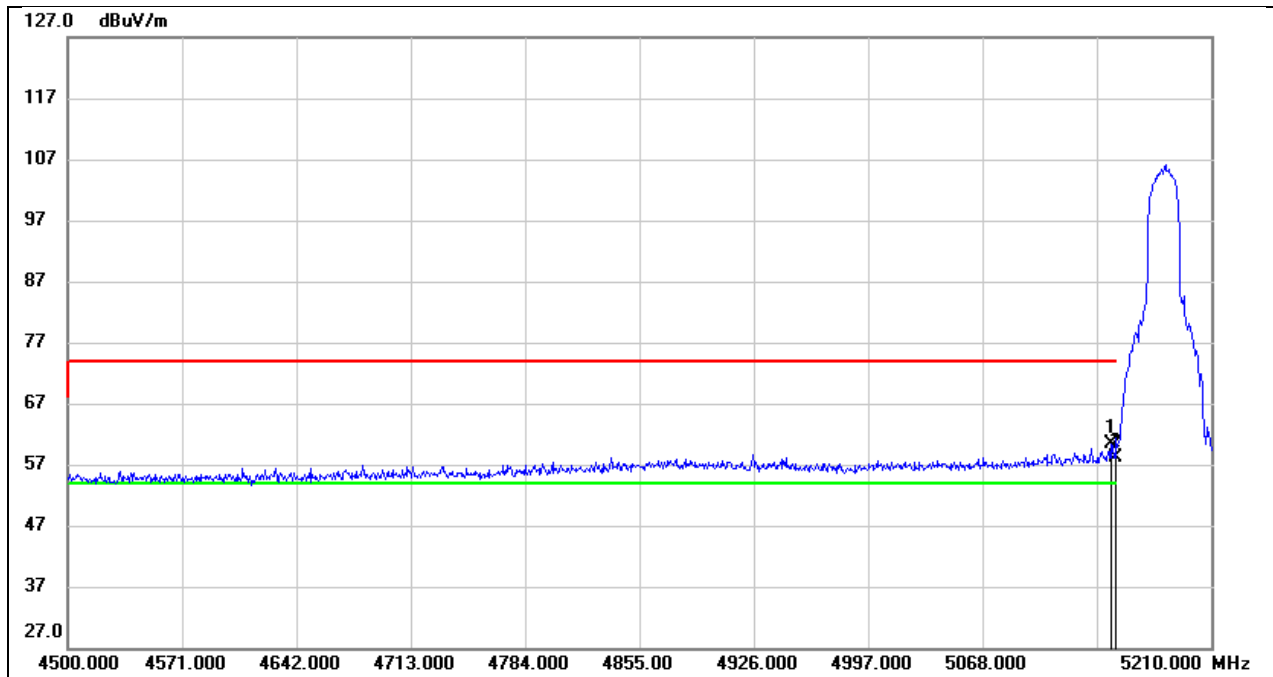

No.	Frequency (MHz)	Reading (dBuV)	Correct (dB/m)	Result (dBuV/m)	Limit (dBuV/m)	Margin (dB)	Remark
1	5147.520	18.80	41.49	60.29	74.00	-13.71	peak
2	5150.000	16.68	41.49	58.17	74.00	-15.83	peak

Test Mode:	802.11n HT20 AV	Frequency(MHz):	5180
Polarity:	Vertical	Test Voltage:	AC 120V_60HZ

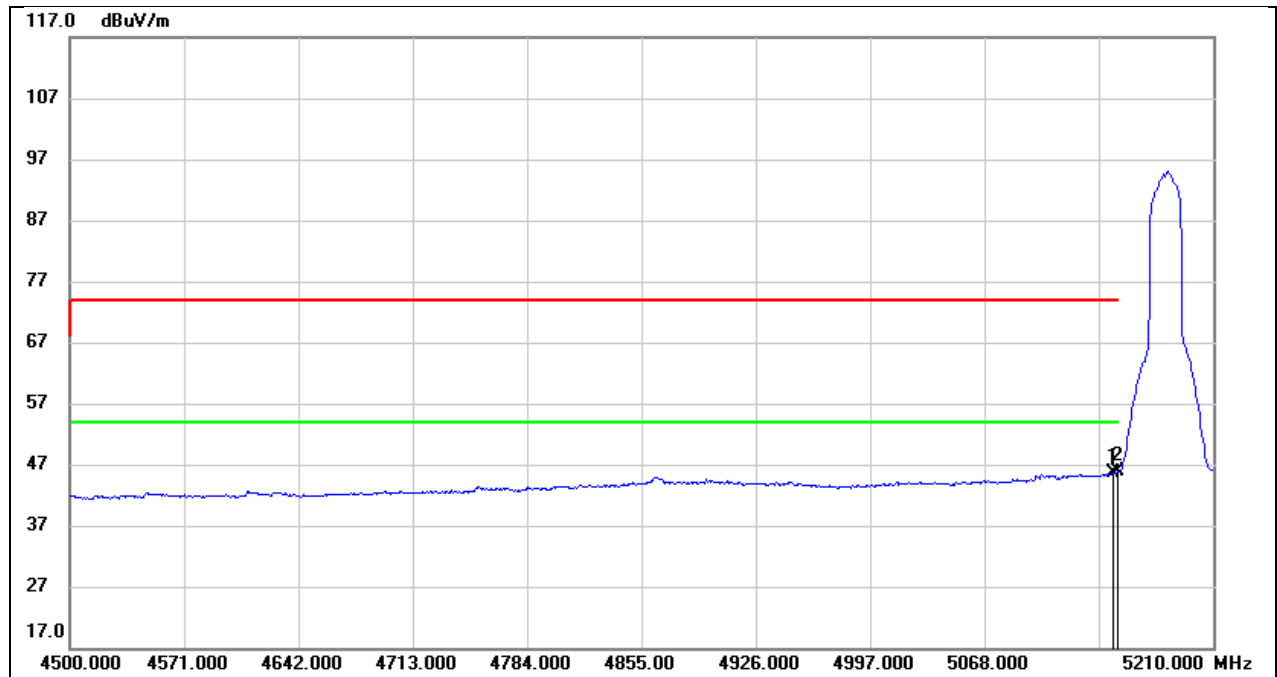

No.	Frequency (MHz)	Reading (dBuV)	Correct (dB/m)	Result (dBuV/m)	Limit (dBuV/m)	Margin (dB)	Remark
1	5147.520	4.16	41.49	45.65	54.00	-8.35	AVG
2	5150.000	4.27	41.49	45.76	54.00	-8.24	AVG

Test Mode:	802.11n HT20 PK	Frequency(MHz):	5240
Polarity:	Vertical	Test Voltage:	AC 120V_60HZ

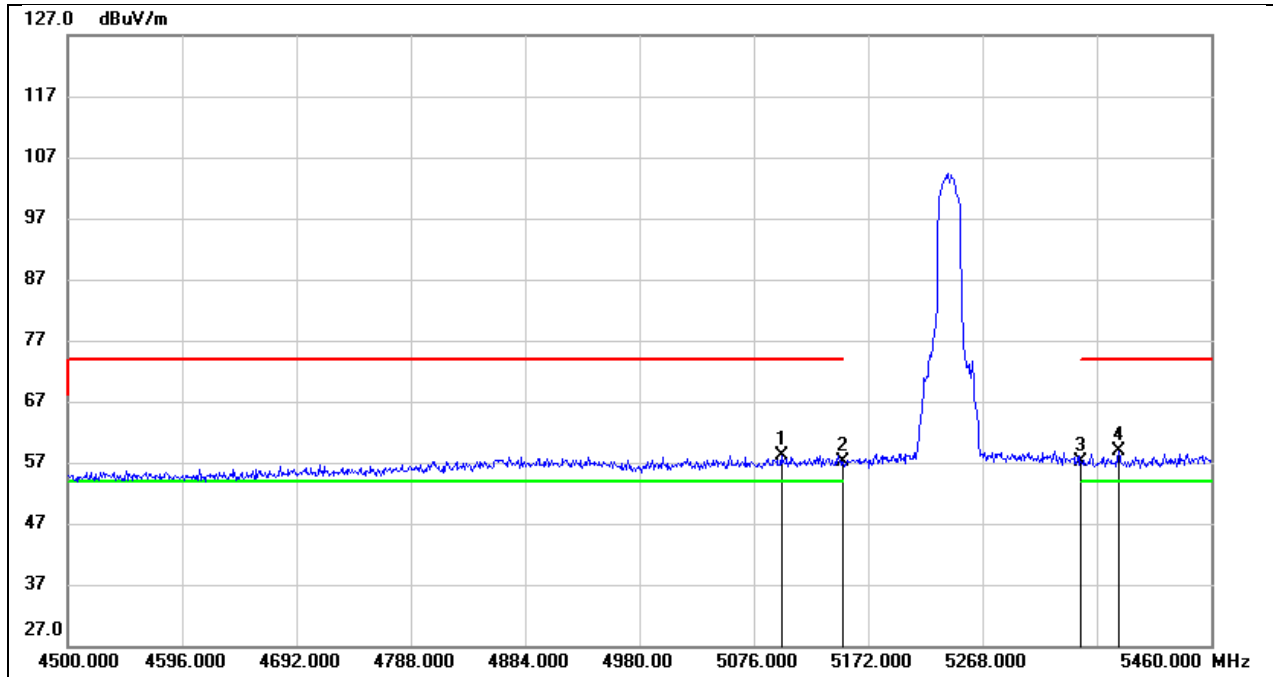

No.	Frequency (MHz)	Reading (dBuV)	Correct (dB/m)	Result (dBuV/m)	Limit (dBuV/m)	Margin (dB)	Remark
1	5099.040	16.86	41.36	58.22	74.00	-15.78	peak
2	5150.000	15.63	41.49	57.12	74.00	-16.88	peak
3	5350.000	15.52	41.58	57.10	74.00	-16.90	peak
4	5382.240	17.38	41.58	58.96	74.00	-15.04	peak

Test Mode:	802.11n HT20 AV	Frequency(MHz):	5240
Polarity:	Vertical	Test Voltage:	AC 120V_60HZ

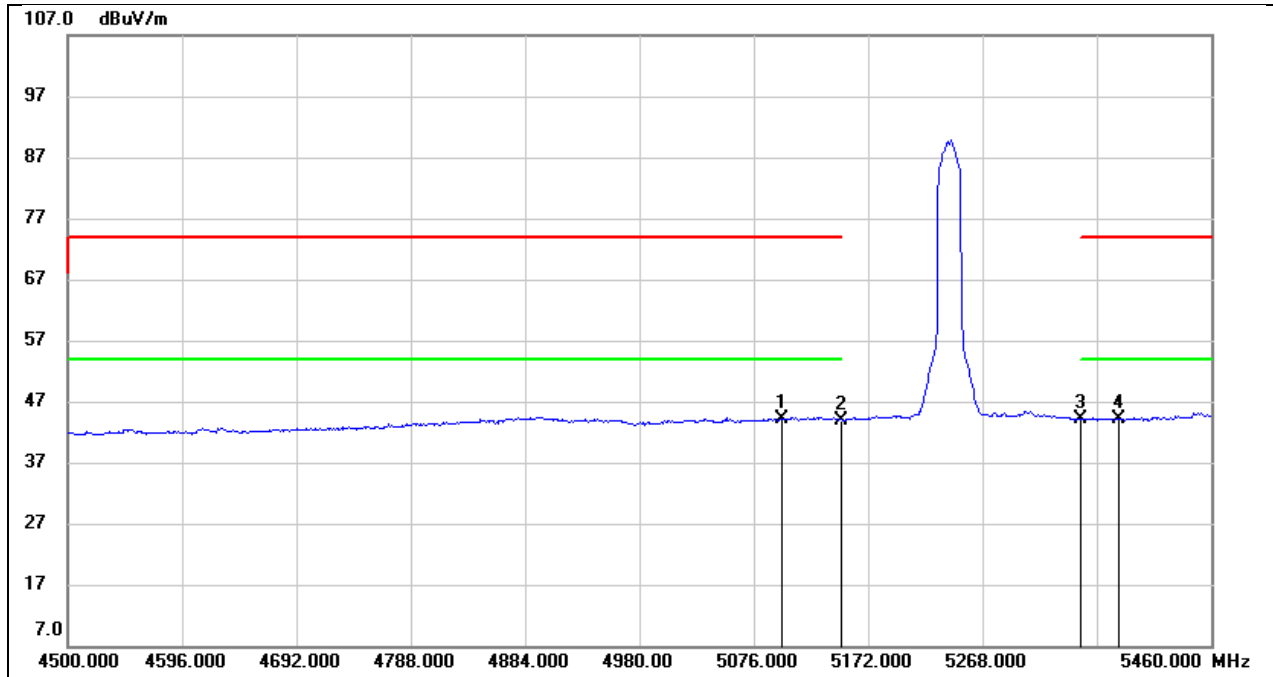

No.	Frequency (MHz)	Reading (dBuV)	Correct (dB/m)	Result (dBuV/m)	Limit (dBuV/m)	Margin (dB)	Remark
1	5099.040	2.78	41.36	44.14	54.00	-9.86	AVG
2	5150.000	2.44	41.49	43.93	54.00	-10.07	AVG
3	5350.000	2.58	41.58	44.16	54.00	-9.84	AVG
4	5382.240	2.56	41.58	44.14	54.00	-9.86	AVG

Test Mode:	802.11n HT40 PK	Frequency(MHz):	5190
Polarity:	Vertical	Test Voltage:	AC 120V_60HZ

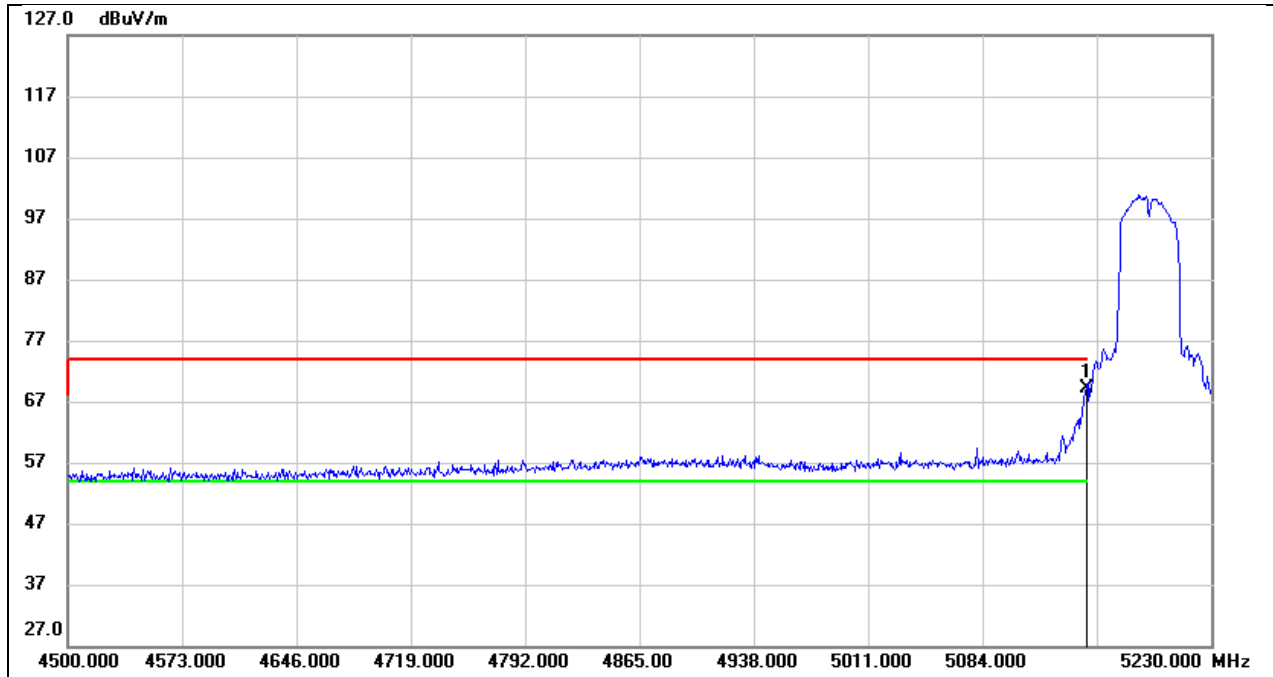

No.	Frequency (MHz)	Reading (dBuV)	Correct (dB/m)	Result (dBuV/m)	Limit (dBuV/m)	Margin (dB)	Remark
1	5150.000	27.73	41.49	69.22	74.00	-4.78	peak

Test Mode:	802.11n HT40 AV	Frequency(MHz):	5190
Polarity:	Vertical	Test Voltage:	AC 120V_60HZ

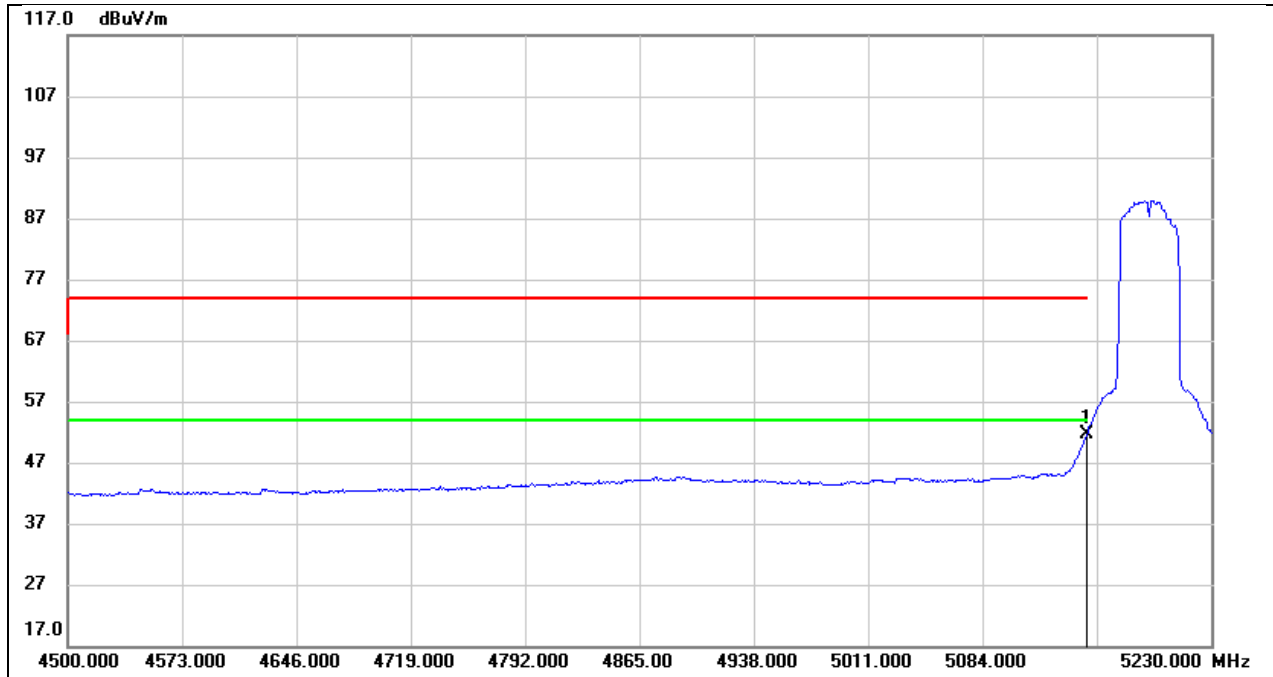

No.	Frequency (MHz)	Reading (dBuV)	Correct (dB/m)	Result (dBuV/m)	Limit (dBuV/m)	Margin (dB)	Remark
1	5150.000	10.18	41.49	51.67	54.00	-2.33	AVG

Test Mode:	802.11n HT40 PK	Frequency(MHz):	5230
Polarity:	Vertical	Test Voltage:	AC 120V_60HZ

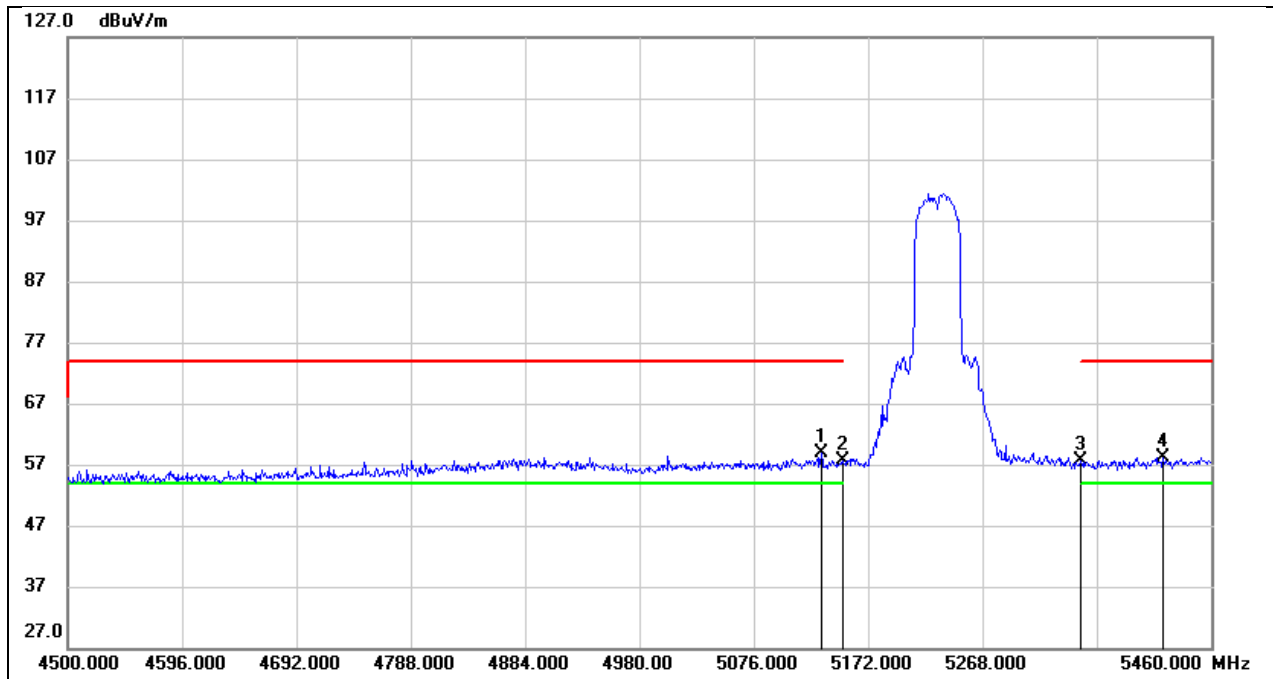

No.	Frequency (MHz)	Reading (dBuV)	Correct (dB/m)	Result (dBuV/m)	Limit (dBuV/m)	Margin (dB)	Remark
1	5132.640	17.32	41.45	58.77	74.00	-15.23	peak
2	5150.000	16.07	41.49	57.56	74.00	-16.44	peak
3	5350.000	16.16	41.58	57.74	74.00	-16.26	peak
4	5419.680	16.53	41.65	58.18	74.00	-15.82	peak

Test Mode:	802.11n HT40 AV	Frequency(MHz):	5230
Polarity:	Vertical	Test Voltage:	AC 120V_60HZ

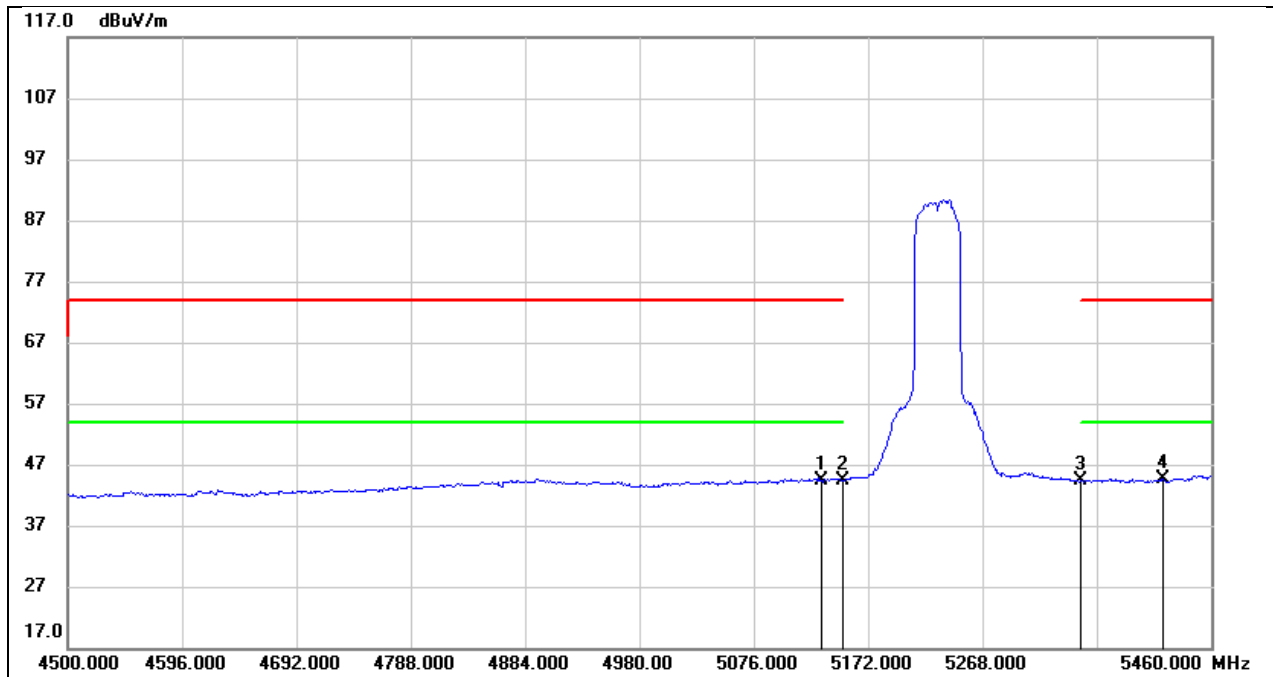

No.	Frequency (MHz)	Reading (dBuV)	Correct (dB/m)	Result (dBuV/m)	Limit (dBuV/m)	Margin (dB)	Remark
1	5132.640	2.92	41.45	44.37	54.00	-9.63	AVG
2	5150.000	3.01	41.49	44.50	54.00	-9.50	AVG
3	5350.000	2.84	41.58	44.42	54.00	-9.58	AVG
4	5419.680	2.89	41.65	44.54	54.00	-9.46	AVG

8.2. SPURIOUS EMISSIONS(1 GHZ~7 GHZ)

Test Mode:	802.11a 20	Frequency(MHz):	5180
Polarity:	Horizontal	Test Voltage:	AC 120V_60HZ

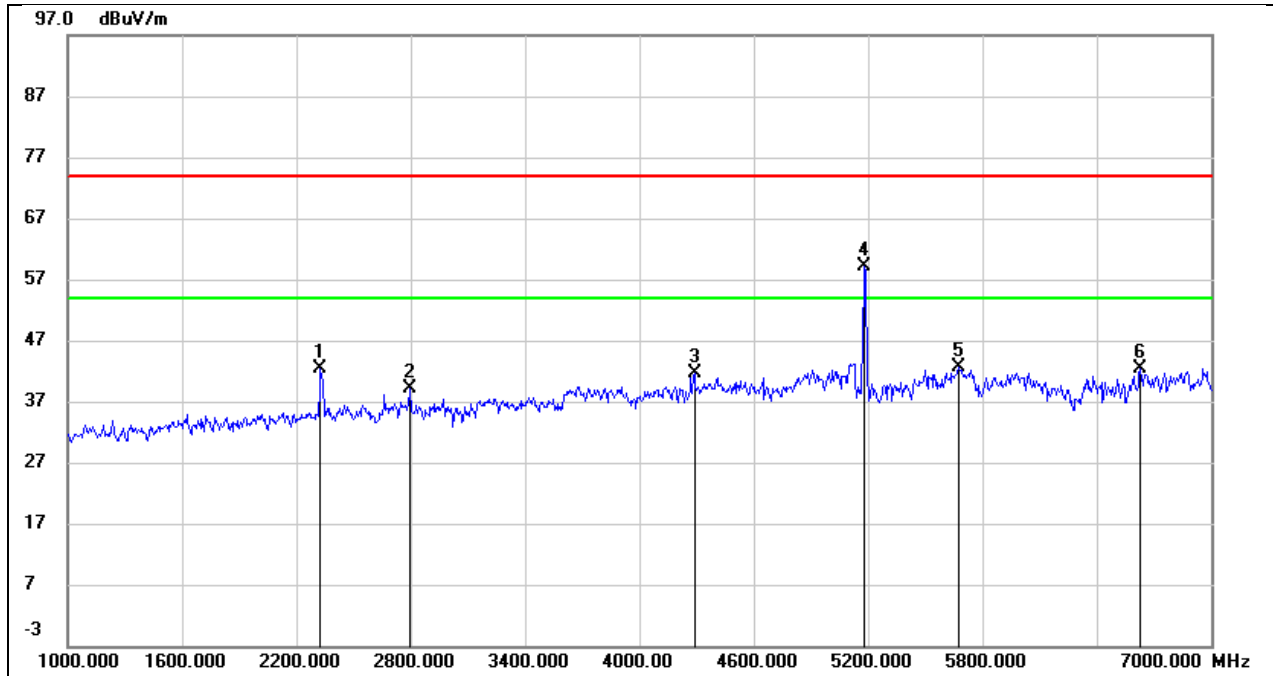

No.	Frequency (MHz)	Reading (dBuV)	Correct (dB/m)	Result (dBuV/m)	Limit (dBuV/m)	Margin (dB)	Remark
1	2326.000	50.54	-8.04	42.50	74.00	-31.50	peak
2	2794.000	45.96	-6.79	39.17	74.00	-34.83	peak
3	4288.000	42.95	-1.41	41.54	74.00	-32.46	peak
4	5180.000	57.81	1.37	59.18	\	\	fundamental
5	5674.000	39.92	2.78	42.70	74.00	-31.30	peak
6	6628.000	37.60	4.85	42.45	74.00	-31.55	peak

Test Mode:	802.11a 20	Frequency(MHz):	5180
Polarity:	Vertical	Test Voltage:	AC 120V_60HZ

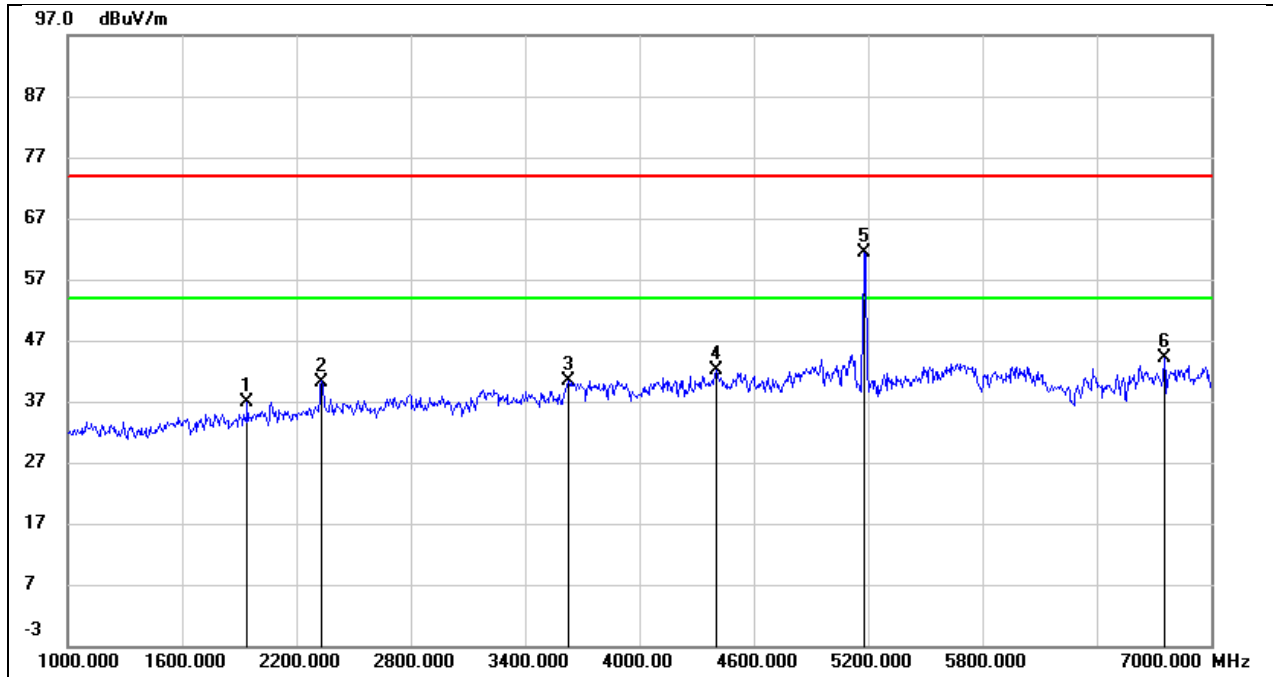

No.	Frequency (MHz)	Reading (dBuV)	Correct (dB/m)	Result (dBuV/m)	Limit (dBuV/m)	Margin (dB)	Remark
1	1942.000	46.19	-9.23	36.96	74.00	-37.04	peak
2	2332.000	47.42	-7.17	40.25	74.00	-33.75	peak
3	3628.000	42.93	-2.52	40.41	74.00	-33.59	peak
4	4402.000	42.48	-0.47	42.01	74.00	-31.99	peak
5	5180.000	58.85	2.57	61.42	\	\	fundamental
6	6754.000	38.10	6.02	44.12	74.00	-29.88	peak

Test Mode:	802.11a 20	Frequency(MHz):	5200
Polarity:	Horizontal	Test Voltage:	AC 120V_60HZ

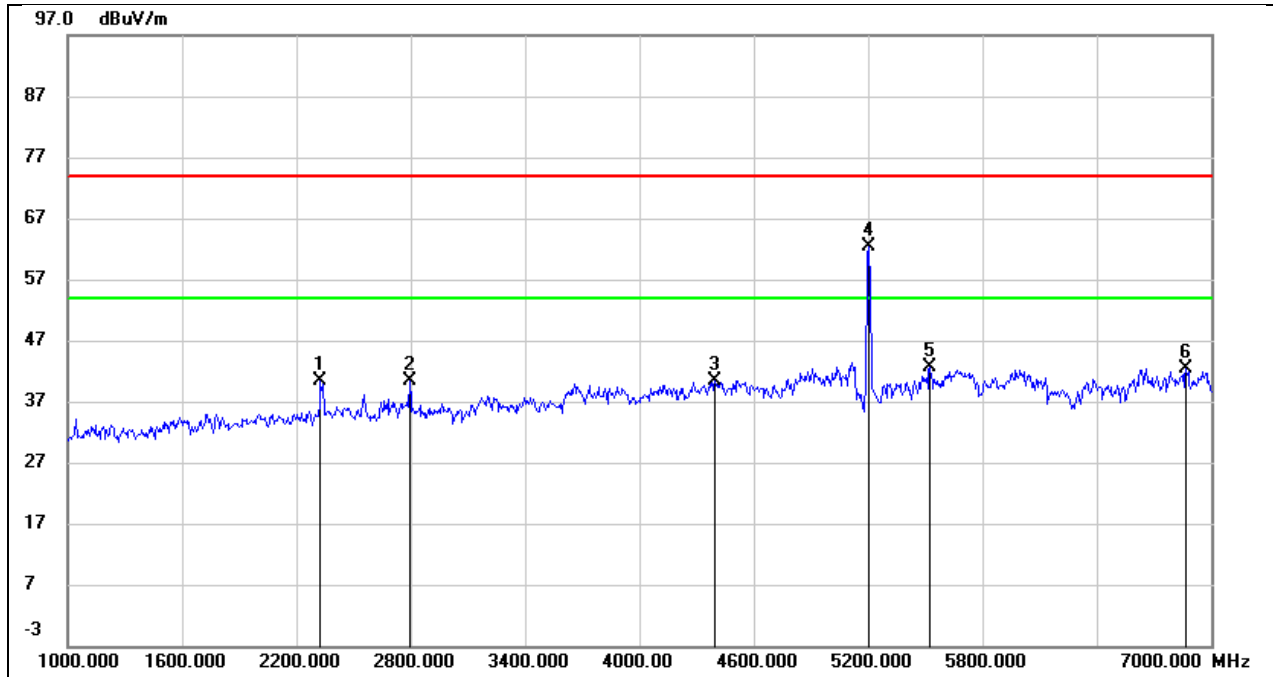

No.	Frequency (MHz)	Reading (dBuV)	Correct (dB/m)	Result (dBuV/m)	Limit (dBuV/m)	Margin (dB)	Remark
1	2326.000	48.32	-8.04	40.28	74.00	-33.72	peak
2	2794.000	47.28	-6.79	40.49	74.00	-33.51	peak
3	4396.000	41.69	-1.41	40.28	74.00	-33.72	peak
4	5200.000	60.95	1.40	62.35	\	\	fundamental
5	5524.000	40.14	2.50	42.64	74.00	-31.36	peak
6	6868.000	36.54	5.91	42.45	74.00	-31.55	peak

Test Mode:	802.11a 20	Frequency(MHz):	5200
Polarity:	Vertical	Test Voltage:	AC 120V_60HZ

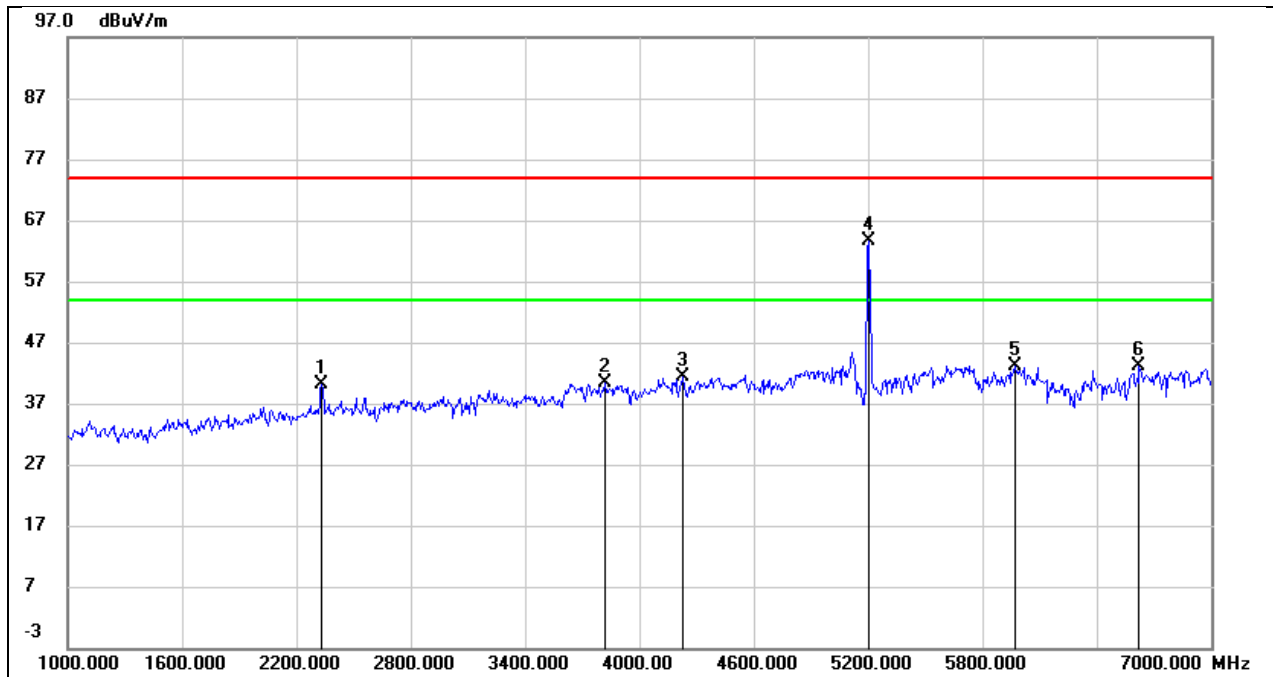

No.	Frequency (MHz)	Reading (dBuV)	Correct (dB/m)	Result (dBuV/m)	Limit (dBuV/m)	Margin (dB)	Remark
1	2332.000	47.27	-7.17	40.10	74.00	-33.90	peak
2	3820.000	41.98	-1.72	40.26	74.00	-33.74	peak
3	4228.000	41.67	-0.40	41.27	74.00	-32.73	peak
4	5200.000	61.09	2.60	63.69	\	\	fundamental
5	5968.000	39.00	4.22	43.22	74.00	-30.78	peak
6	6622.000	37.44	5.66	43.10	74.00	-30.90	peak

Test Mode:	802.11a 20	Frequency(MHz):	5240
Polarity:	Horizontal	Test Voltage:	AC 120V_60HZ

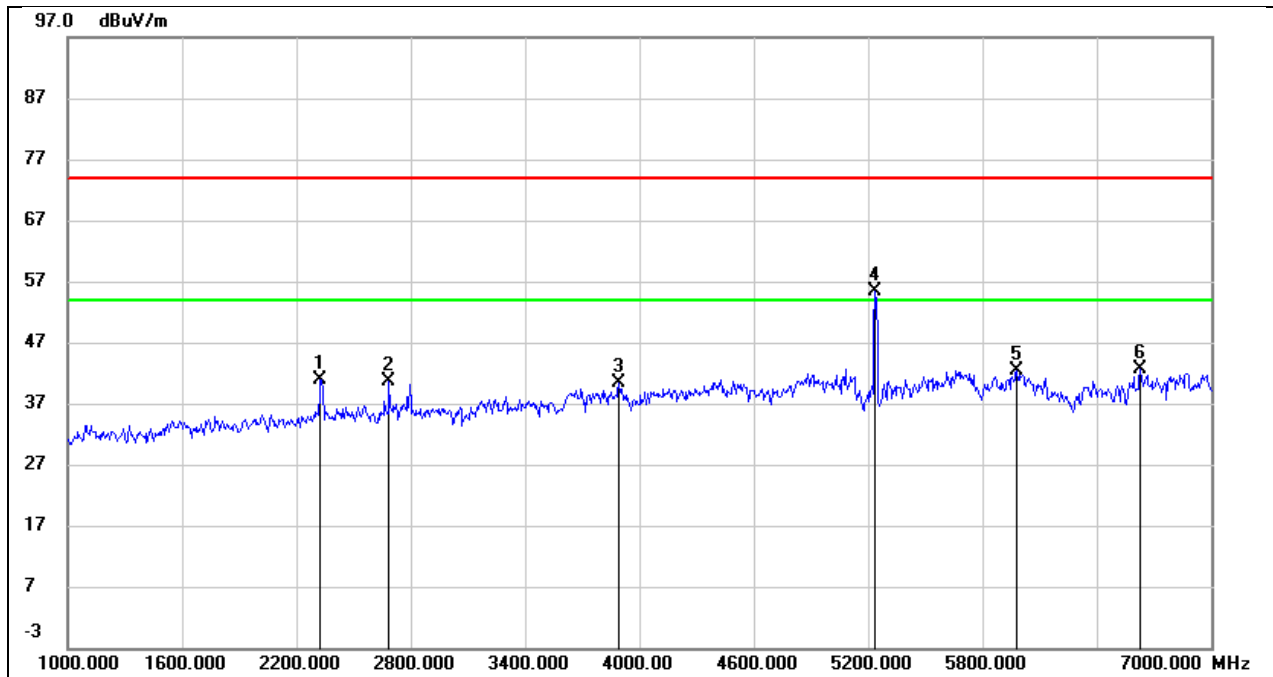

No.	Frequency (MHz)	Reading (dBuV)	Correct (dB/m)	Result (dBuV/m)	Limit (dBuV/m)	Margin (dB)	Remark
1	2326.000	48.91	-8.04	40.87	74.00	-33.13	peak
2	2686.000	48.02	-7.36	40.66	74.00	-33.34	peak
3	3892.000	43.29	-2.90	40.39	74.00	-33.61	peak
4	5240.000	53.87	1.44	55.31	\	\	fundamental
5	5980.000	39.11	3.28	42.39	74.00	-31.61	peak
6	6628.000	37.75	4.85	42.60	74.00	-31.40	peak

Test Mode:	802.11a 20	Frequency(MHz):	5240
Polarity:	Vertical	Test Voltage:	AC 120V_60HZ

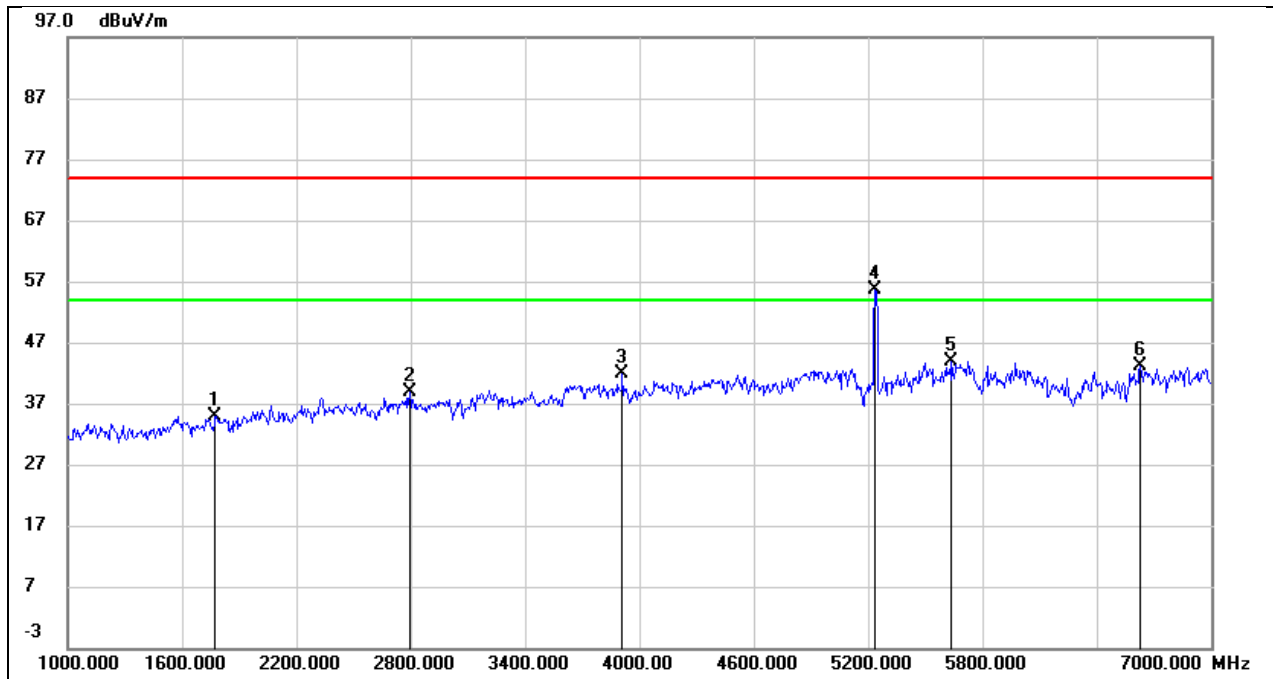

No.	Frequency (MHz)	Reading (dBuV)	Correct (dB/m)	Result (dBuV/m)	Limit (dBuV/m)	Margin (dB)	Remark
1	1774.000	44.59	-9.68	34.91	74.00	-39.09	peak
2	2794.000	44.67	-5.69	38.98	74.00	-35.02	peak
3	3910.000	43.66	-1.85	41.81	74.00	-32.19	peak
4	5240.000	53.09	2.64	55.73	\	\	fundamental
5	5638.000	39.94	4.05	43.99	74.00	-30.01	peak
6	6628.000	37.48	5.68	43.16	74.00	-30.84	peak

8.3. SPURIOUS EMISSIONS(7 GHZ~18 GHZ)

Test Mode:	802.11a 20	Frequency(MHz):	5180
Polarity:	Horizontal	Test Voltage:	AC 120V_60HZ

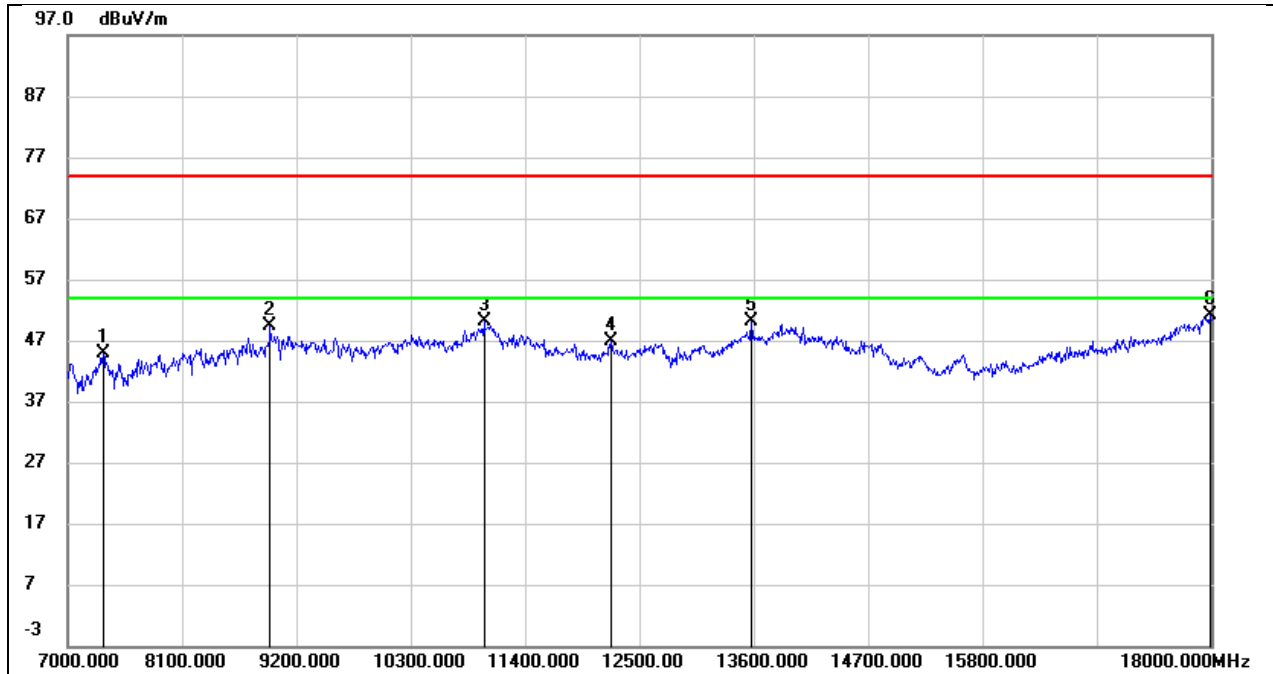

No.	Frequency (MHz)	Reading (dBuV)	Correct (dB/m)	Result (dBuV/m)	Limit (dBuV/m)	Margin (dB)	Remark
1	7341.000	36.65	8.17	44.82	74.00	-29.18	peak
2	8947.000	38.08	11.18	49.26	74.00	-24.74	peak
3	11004.000	35.33	14.80	50.13	74.00	-23.87	peak
4	12225.000	28.69	18.12	46.81	74.00	-27.19	peak
5	13578.000	29.07	21.15	50.22	74.00	-23.78	peak
6	17989.000	22.83	28.41	51.24	74.00	-22.76	peak

Test Mode:	802.11a 20	Frequency(MHz):	5180
Polarity:	Vertical	Test Voltage:	AC 120V_60HZ

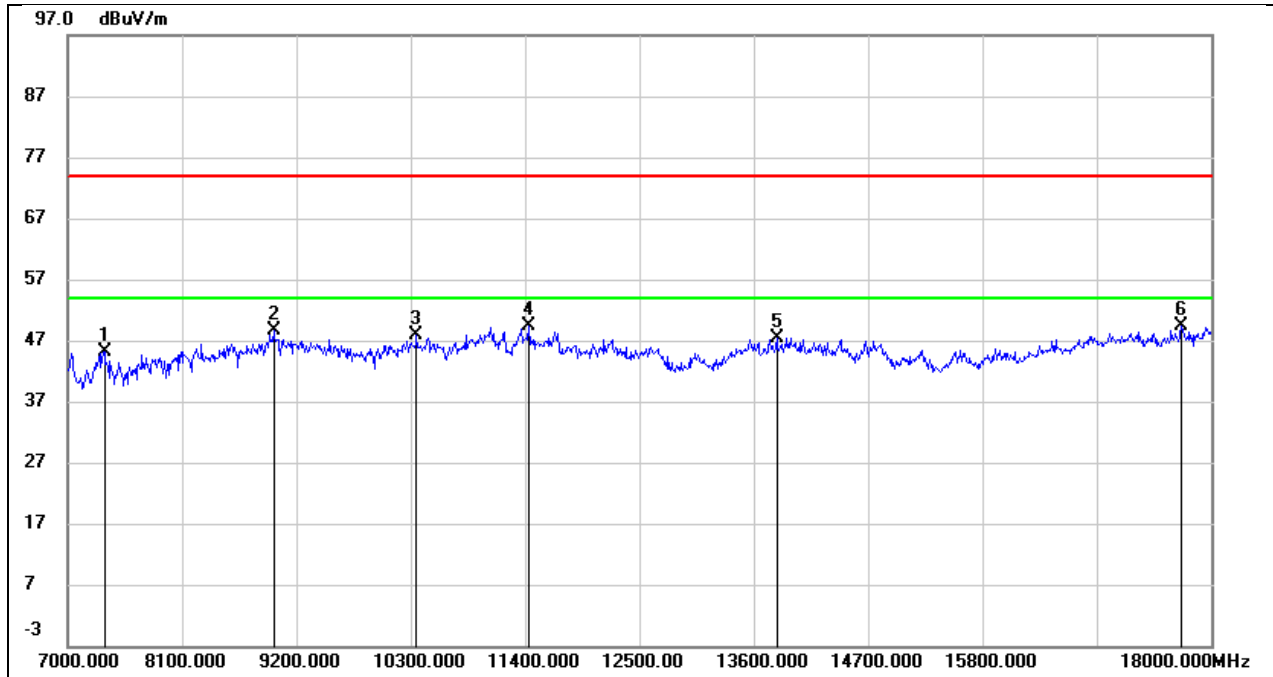

No.	Frequency (MHz)	Reading (dBuV)	Correct (dB/m)	Result (dBuV/m)	Limit (dBuV/m)	Margin (dB)	Remark
1	7352.000	36.36	8.86	45.22	74.00	-28.78	peak
2	8980.000	36.53	12.07	48.60	74.00	-25.40	peak
3	10355.000	35.38	12.50	47.88	74.00	-26.12	peak
4	11433.000	34.34	15.00	49.34	74.00	-24.66	peak
5	13820.000	26.74	20.62	47.36	74.00	-26.64	peak
6	17714.000	24.05	25.24	49.29	74.00	-24.71	peak

Test Mode:	802.11a 20	Frequency(MHz):	5200
Polarity:	Horizontal	Test Voltage:	AC 120V_60HZ

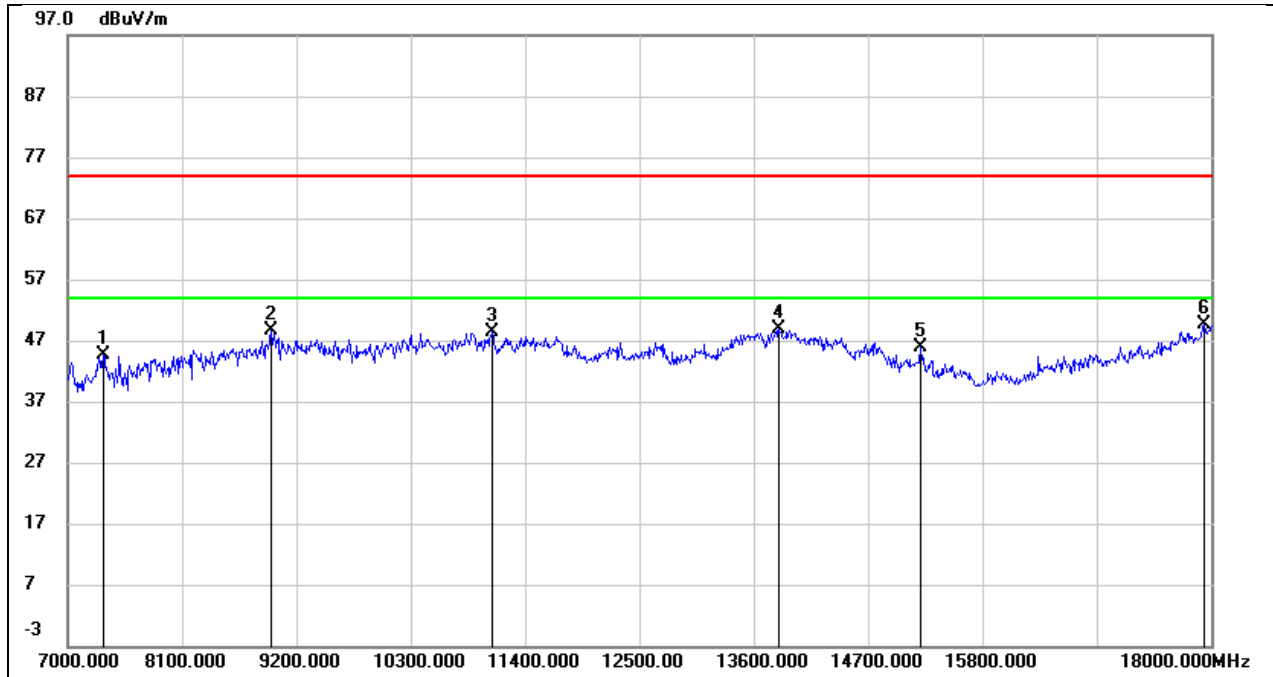

No.	Frequency (MHz)	Reading (dBuV)	Correct (dB/m)	Result (dBuV/m)	Limit (dBuV/m)	Margin (dB)	Remark
1	7341.000	36.52	8.17	44.69	74.00	-29.31	peak
2	8958.000	37.34	11.34	48.68	74.00	-25.32	peak
3	11081.000	33.36	14.95	48.31	74.00	-25.69	peak
4	13842.000	26.71	22.28	48.99	74.00	-25.01	peak
5	15206.000	27.98	18.00	45.98	74.00	-28.02	peak
6	17934.000	21.51	28.09	49.60	74.00	-24.40	peak

Test Mode:	802.11a 20	Frequency(MHz):	5200
Polarity:	Vertical	Test Voltage:	AC 120V_60HZ

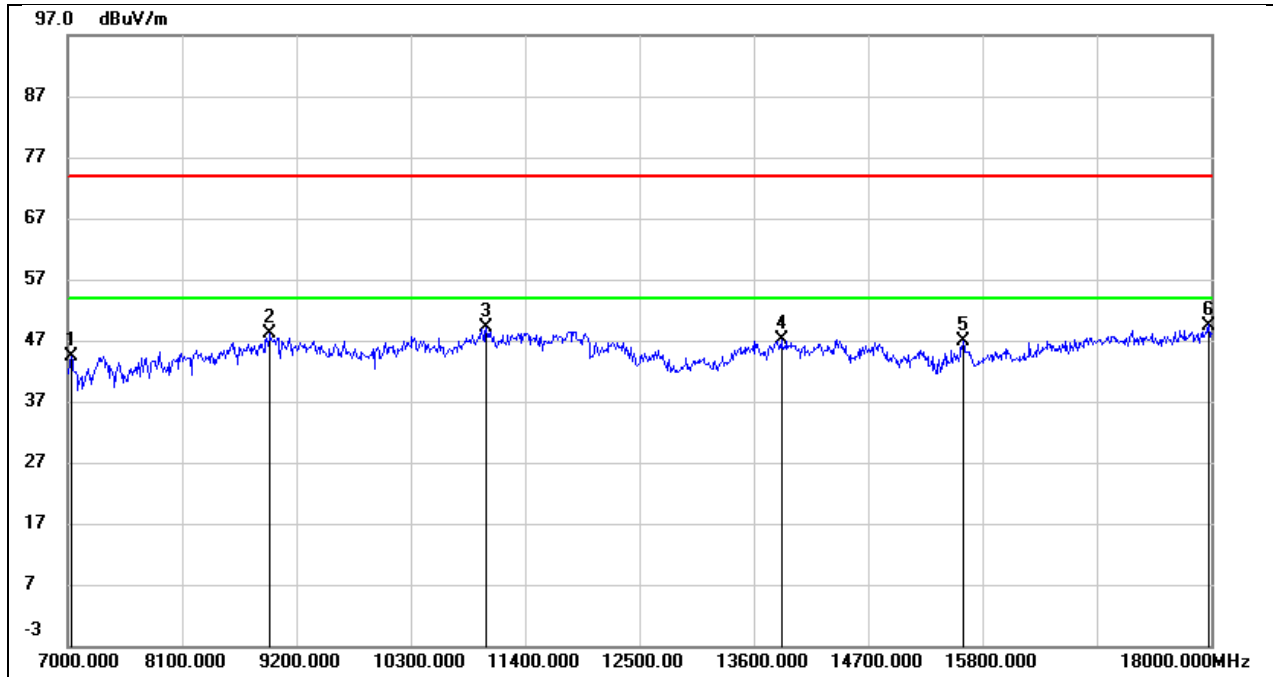

No.	Frequency (MHz)	Reading (dBuV)	Correct (dB/m)	Result (dBuV/m)	Limit (dBuV/m)	Margin (dB)	Remark
1	7033.000	35.94	8.56	44.50	74.00	-29.50	peak
2	8947.000	36.45	11.60	48.05	74.00	-25.95	peak
3	11026.000	35.06	14.00	49.06	74.00	-24.94	peak
4	13864.000	26.40	20.67	47.07	74.00	-26.93	peak
5	15613.000	26.98	19.92	46.90	74.00	-27.10	peak
6	17978.000	23.26	26.24	49.50	74.00	-24.50	peak

Test Mode:	802.11a 20	Frequency(MHz):	5240
Polarity:	Horizontal	Test Voltage:	AC 120V_60HZ

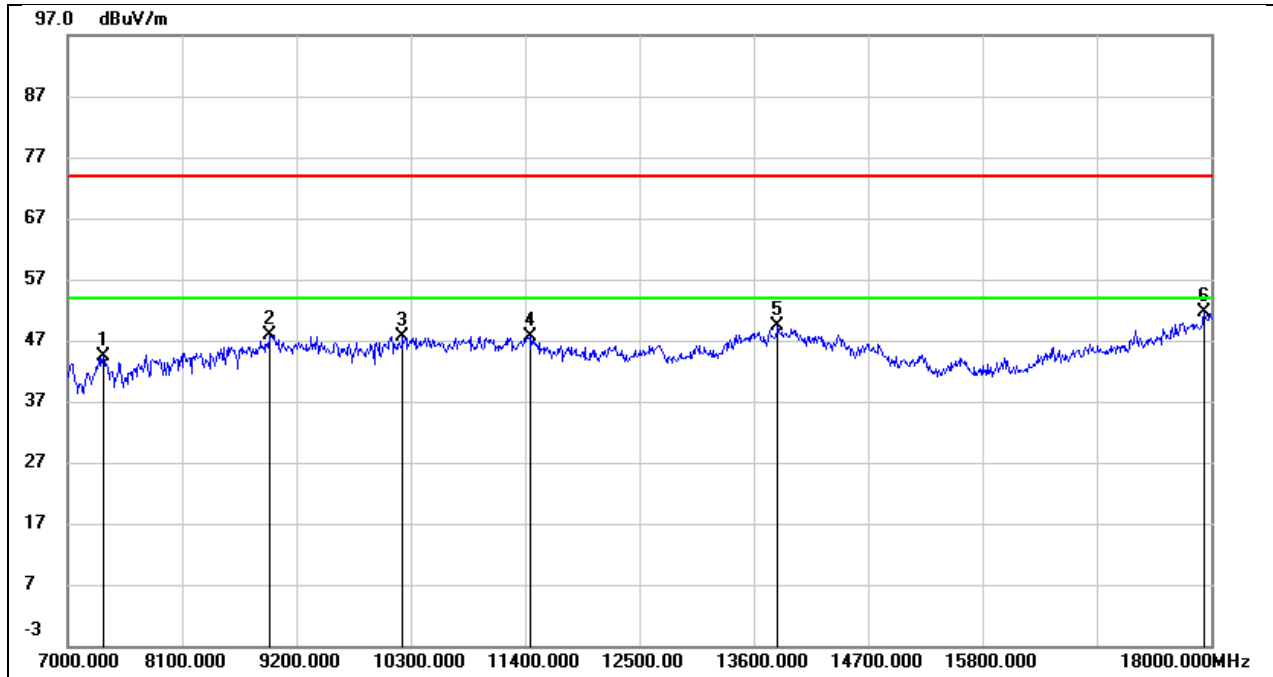

No.	Frequency (MHz)	Reading (dBuV)	Correct (dB/m)	Result (dBuV/m)	Limit (dBuV/m)	Margin (dB)	Remark
1	7341.000	36.16	8.17	44.33	74.00	-29.67	peak
2	8947.000	36.63	11.18	47.81	74.00	-26.19	peak
3	10223.000	35.38	12.36	47.74	74.00	-26.26	peak
4	11444.000	31.12	16.44	47.56	74.00	-26.44	peak
5	13831.000	27.09	22.27	49.36	74.00	-24.64	peak
6	17934.000	23.50	28.09	51.59	74.00	-22.41	peak

Test Mode:	802.11a 20	Frequency(MHz):	5240
Polarity:	Vertical	Test Voltage:	AC 120V_60HZ

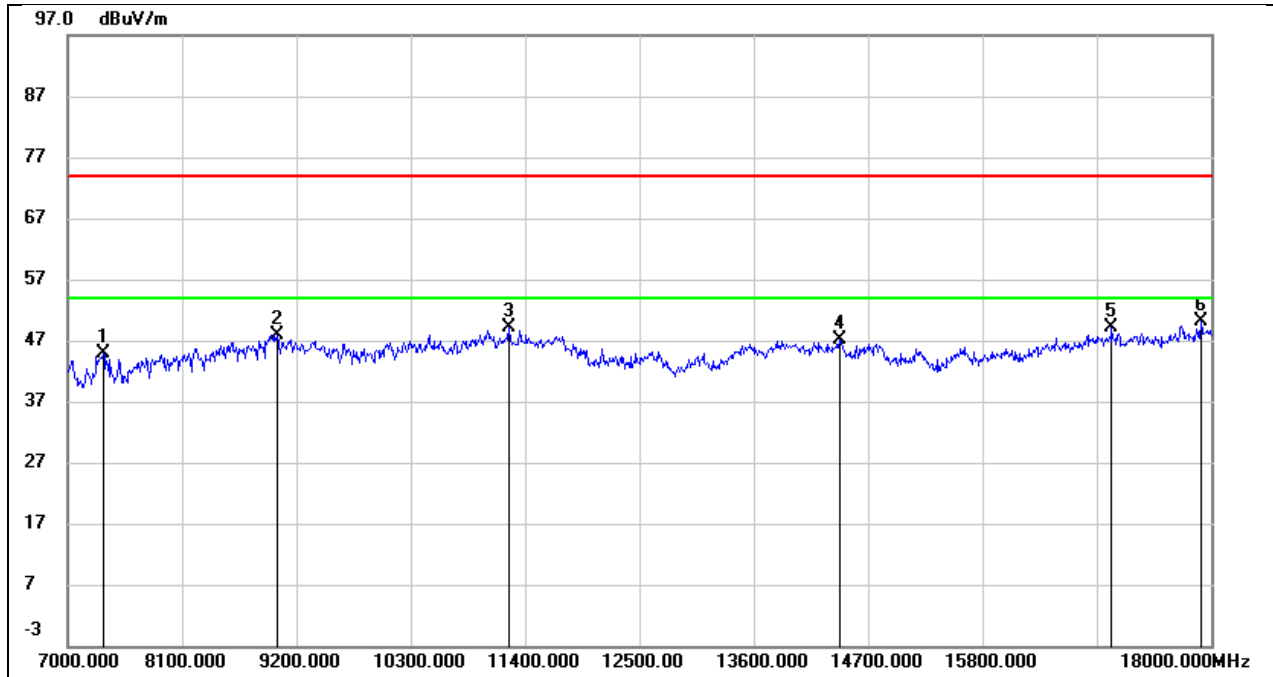

No.	Frequency (MHz)	Reading (dBuV)	Correct (dB/m)	Result (dBuV/m)	Limit (dBuV/m)	Margin (dB)	Remark
1	7341.000	36.15	8.79	44.94	74.00	-29.06	peak
2	9013.000	35.64	12.24	47.88	74.00	-26.12	peak
3	11246.000	34.81	14.28	49.09	74.00	-24.91	peak
4	14425.000	26.90	20.16	47.06	74.00	-26.94	peak
5	17043.000	25.63	23.48	49.11	74.00	-24.89	peak
6	17901.000	23.92	26.12	50.04	74.00	-23.96	peak

Test Mode:	802.11n HT20	Frequency(MHz):	5180
Polarity:	Horizontal	Test Voltage:	AC 120V_60HZ

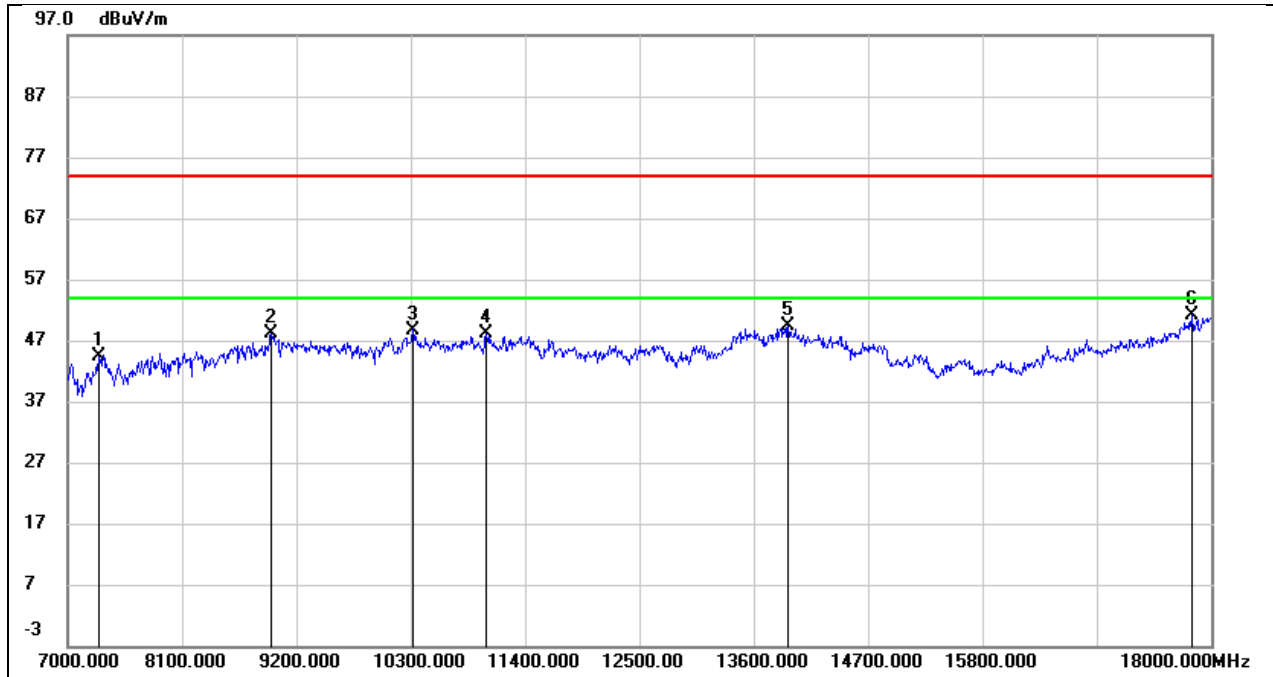

No.	Frequency (MHz)	Reading (dBuV)	Correct (dB/m)	Result (dBuV/m)	Limit (dBuV/m)	Margin (dB)	Remark
1	7297.000	36.46	7.81	44.27	74.00	-29.73	peak
2	8958.000	36.74	11.34	48.08	74.00	-25.92	peak
3	10322.000	36.03	12.72	48.75	74.00	-25.25	peak
4	11026.000	33.18	14.84	48.02	74.00	-25.98	peak
5	13930.000	27.11	22.37	49.48	74.00	-24.52	peak
6	17813.000	23.82	27.38	51.20	74.00	-22.80	peak

Test Mode:	802.11n HT20	Frequency(MHz):	5180
Polarity:	Vertical	Test Voltage:	AC 120V_60HZ

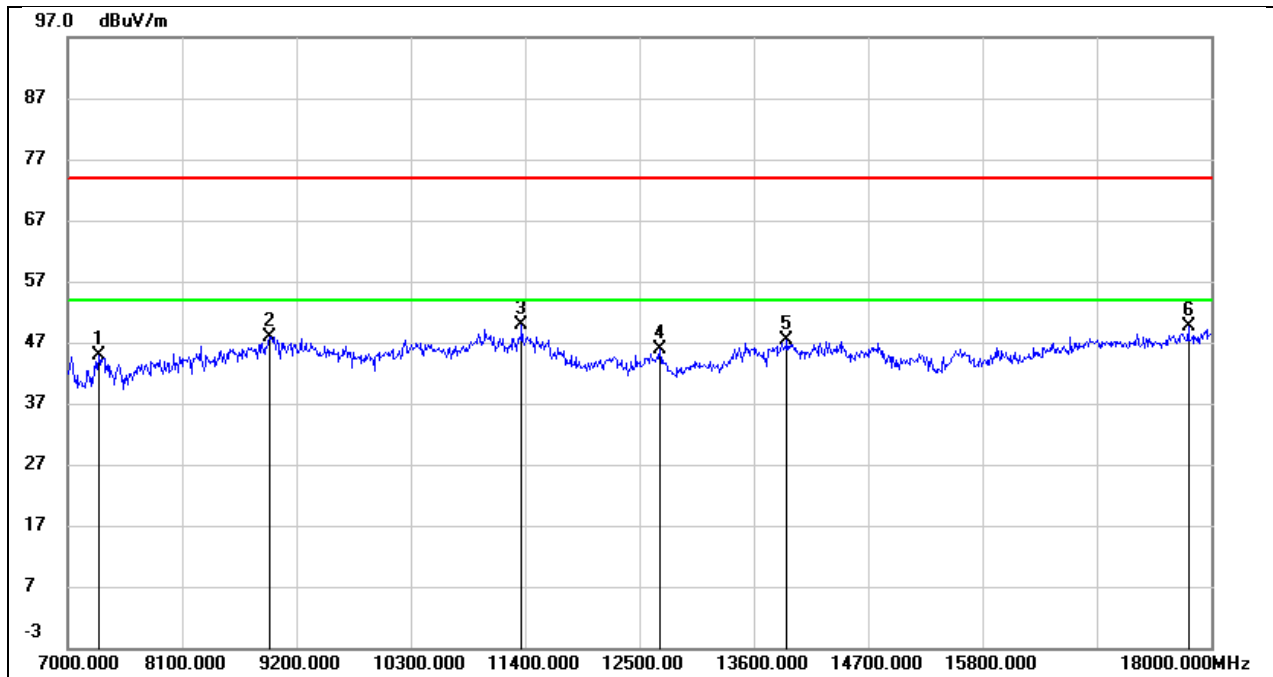

No.	Frequency (MHz)	Reading (dBuV)	Correct (dB/m)	Result (dBuV/m)	Limit (dBuV/m)	Margin (dB)	Remark
1	7297.000	36.33	8.47	44.80	74.00	-29.20	peak
2	8936.000	36.47	11.44	47.91	74.00	-26.09	peak
3	11367.000	34.97	14.81	49.78	74.00	-24.22	peak
4	12698.000	28.68	17.18	45.86	74.00	-28.14	peak
5	13919.000	26.54	20.74	47.28	74.00	-26.72	peak
6	17780.000	23.78	25.81	49.59	74.00	-24.41	peak

Test Mode:	802.11n HT20	Frequency(MHz):	5200
Polarity:	Horizontal	Test Voltage:	AC 120V_60HZ

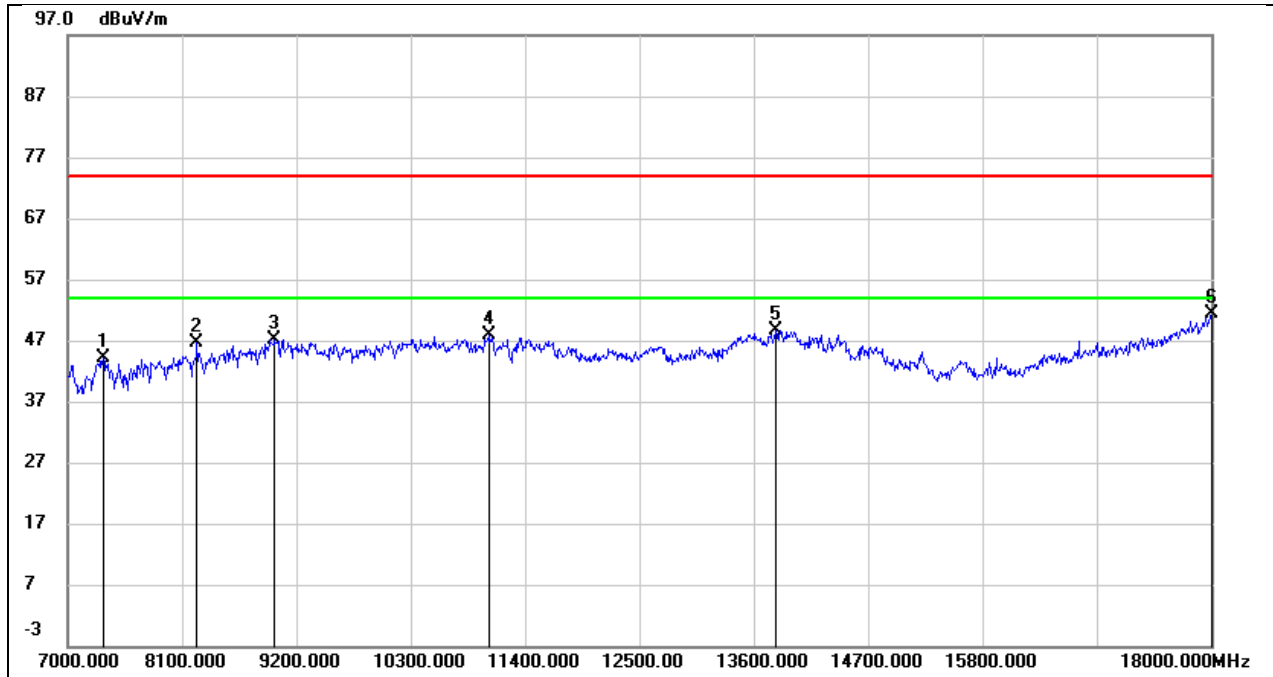

No.	Frequency (MHz)	Reading (dBuV)	Correct (dB/m)	Result (dBuV/m)	Limit (dBuV/m)	Margin (dB)	Remark
1	7341.000	36.00	8.17	44.17	74.00	-29.83	peak
2	8243.000	38.15	8.54	46.69	74.00	-27.31	peak
3	8991.000	35.36	11.83	47.19	74.00	-26.81	peak
4	11048.000	32.98	14.88	47.86	74.00	-26.14	peak
5	13809.000	26.41	22.25	48.66	74.00	-25.34	peak
6	18000.000	22.96	28.47	51.43	74.00	-22.57	peak

Test Mode:	802.11n HT20	Frequency(MHz):	5200
Polarity:	Vertical	Test Voltage:	AC 120V_60HZ

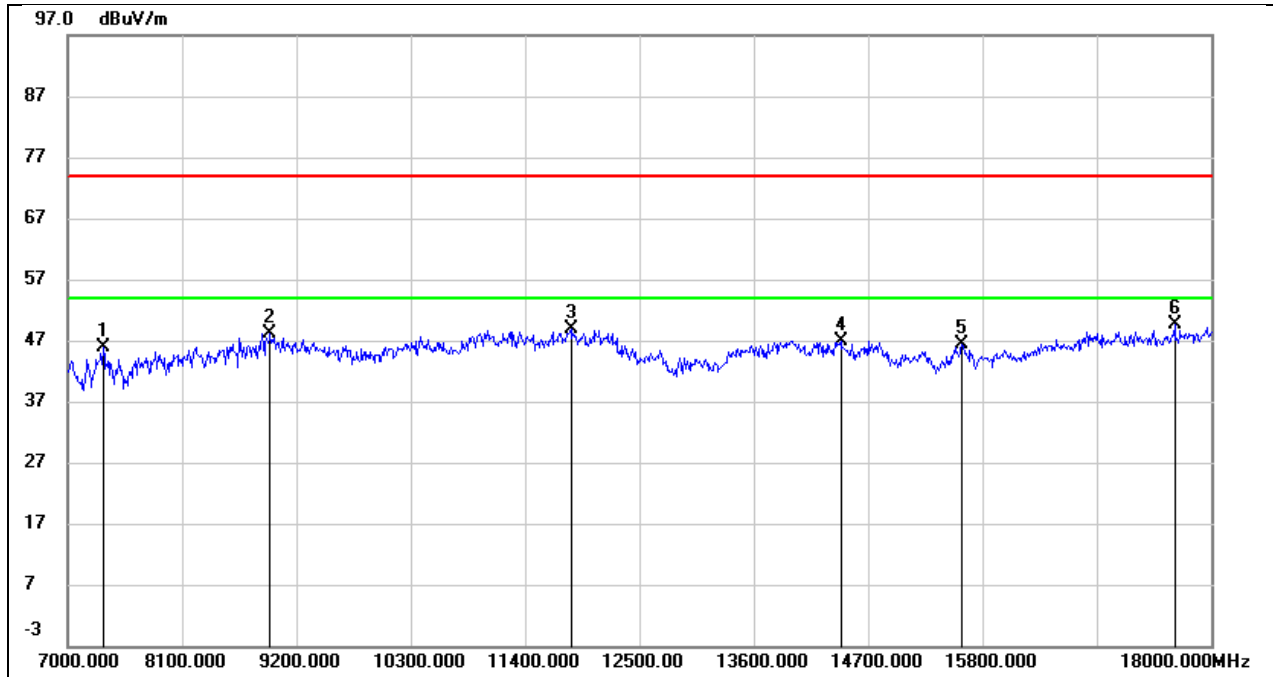

No.	Frequency (MHz)	Reading (dBuV)	Correct (dB/m)	Result (dBuV/m)	Limit (dBuV/m)	Margin (dB)	Remark
1	7341.000	36.98	8.79	45.77	74.00	-28.23	peak
2	8947.000	36.64	11.60	48.24	74.00	-25.76	peak
3	11840.000	32.78	16.03	48.81	74.00	-25.19	peak
4	14436.000	26.82	20.15	46.97	74.00	-27.03	peak
5	15602.000	26.43	19.90	46.33	74.00	-27.67	peak
6	17648.000	25.06	24.67	49.73	74.00	-24.27	peak

Test Mode:	802.11n HT20	Frequency(MHz):	5240
Polarity:	Horizontal	Test Voltage:	AC 120V_60HZ

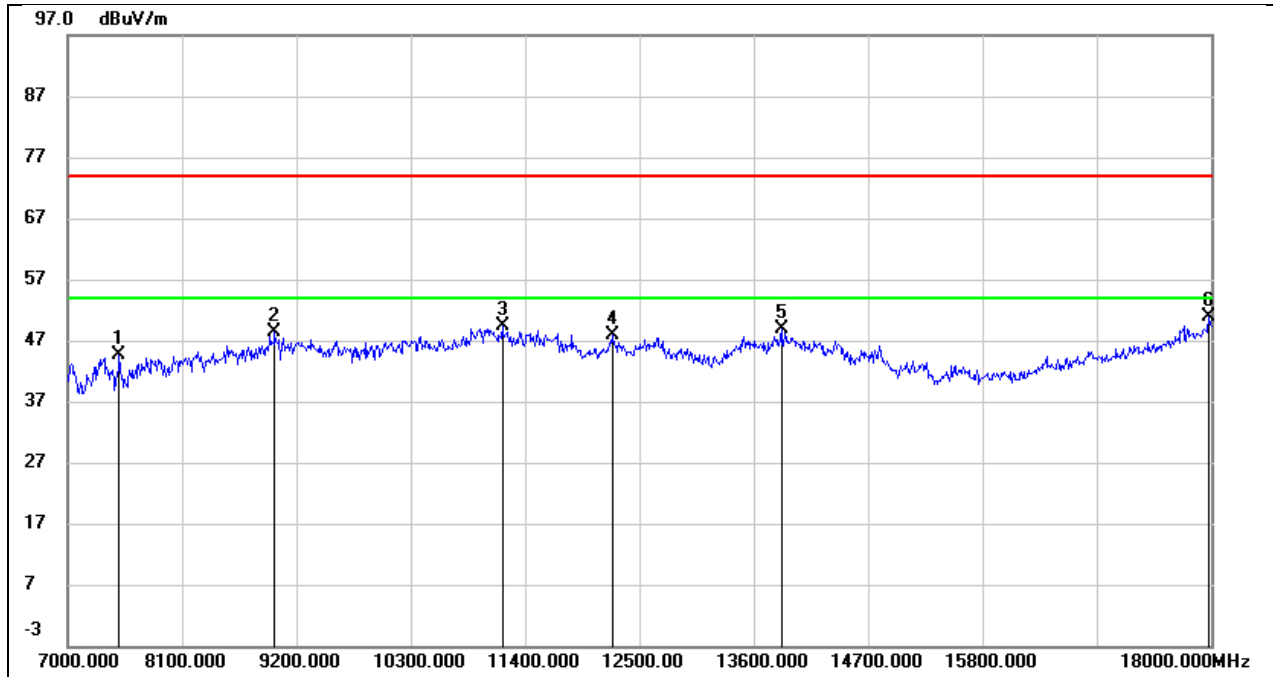

No.	Frequency (MHz)	Reading (dBuV)	Correct (dB/m)	Result (dBuV/m)	Limit (dBuV/m)	Margin (dB)	Remark
1	7495.000	36.71	7.81	44.52	74.00	-29.48	peak
2	8991.000	36.46	11.83	48.29	74.00	-25.71	peak
3	11180.000	34.15	15.12	49.27	74.00	-24.73	peak
4	12236.000	29.61	18.15	47.76	74.00	-26.24	peak
5	13864.000	26.60	22.30	48.90	74.00	-25.10	peak
6	17978.000	22.45	28.34	50.79	74.00	-23.21	peak

Test Mode:	802.11n HT20	Frequency(MHz):	5240
Polarity:	Vertical	Test Voltage:	AC 120V_60HZ

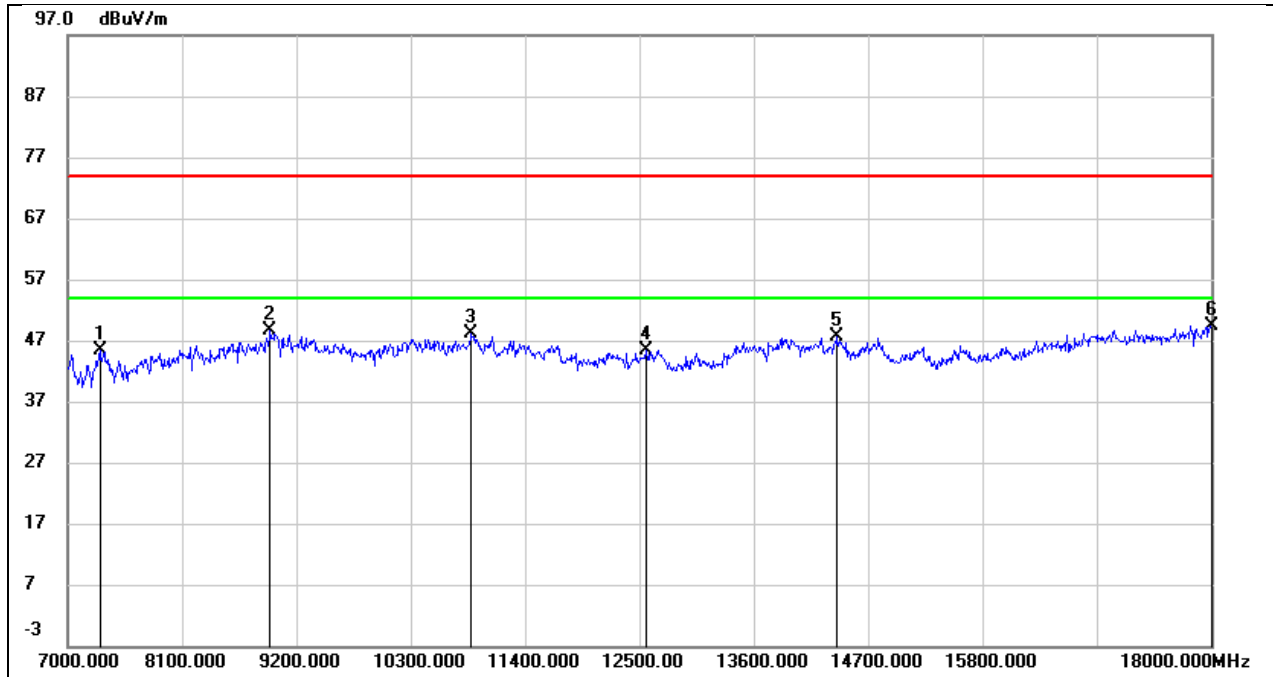

No.	Frequency (MHz)	Reading (dBuV)	Correct (dB/m)	Result (dBuV/m)	Limit (dBuV/m)	Margin (dB)	Remark
1	7308.000	36.76	8.54	45.30	74.00	-28.70	peak
2	8947.000	36.97	11.60	48.57	74.00	-25.43	peak
3	10883.000	34.61	13.47	48.08	74.00	-25.92	peak
4	12566.000	28.36	17.07	45.43	74.00	-28.57	peak
5	14403.000	27.51	20.20	47.71	74.00	-26.29	peak
6	18000.000	23.17	26.27	49.44	74.00	-24.56	peak

Test Mode:	802.11n HT40	Frequency(MHz):	5190
Polarity:	Horizontal	Test Voltage:	AC 120V_60HZ

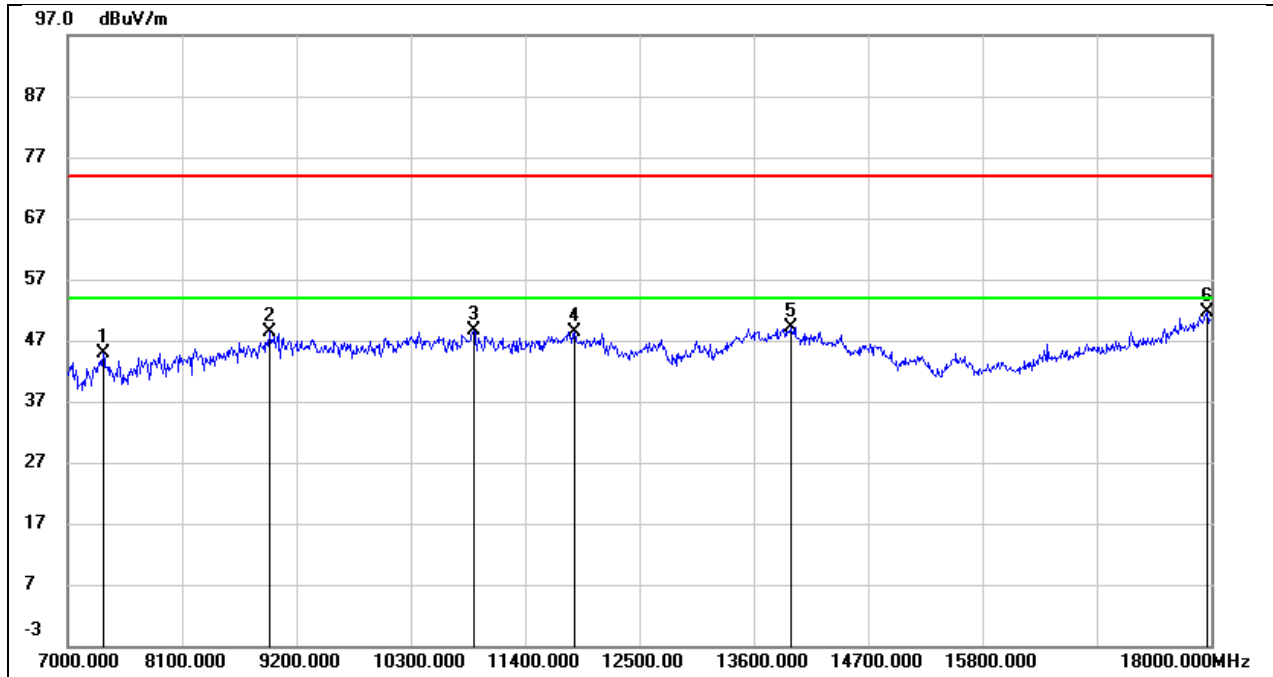

No.	Frequency (MHz)	Reading (dBuV)	Correct (dB/m)	Result (dBuV/m)	Limit (dBuV/m)	Margin (dB)	Remark
1	7341.000	36.76	8.17	44.93	74.00	-29.07	peak
2	8936.000	37.32	11.01	48.33	74.00	-25.67	peak
3	10905.000	34.27	14.25	48.52	74.00	-25.48	peak
4	11873.000	31.00	17.41	48.41	74.00	-25.59	peak
5	13963.000	26.81	22.40	49.21	74.00	-24.79	peak
6	17967.000	23.30	28.28	51.58	74.00	-22.42	peak

Test Mode:	802.11n HT40	Frequency(MHz):	5190
Polarity:	Vertical	Test Voltage:	AC 120V_60HZ

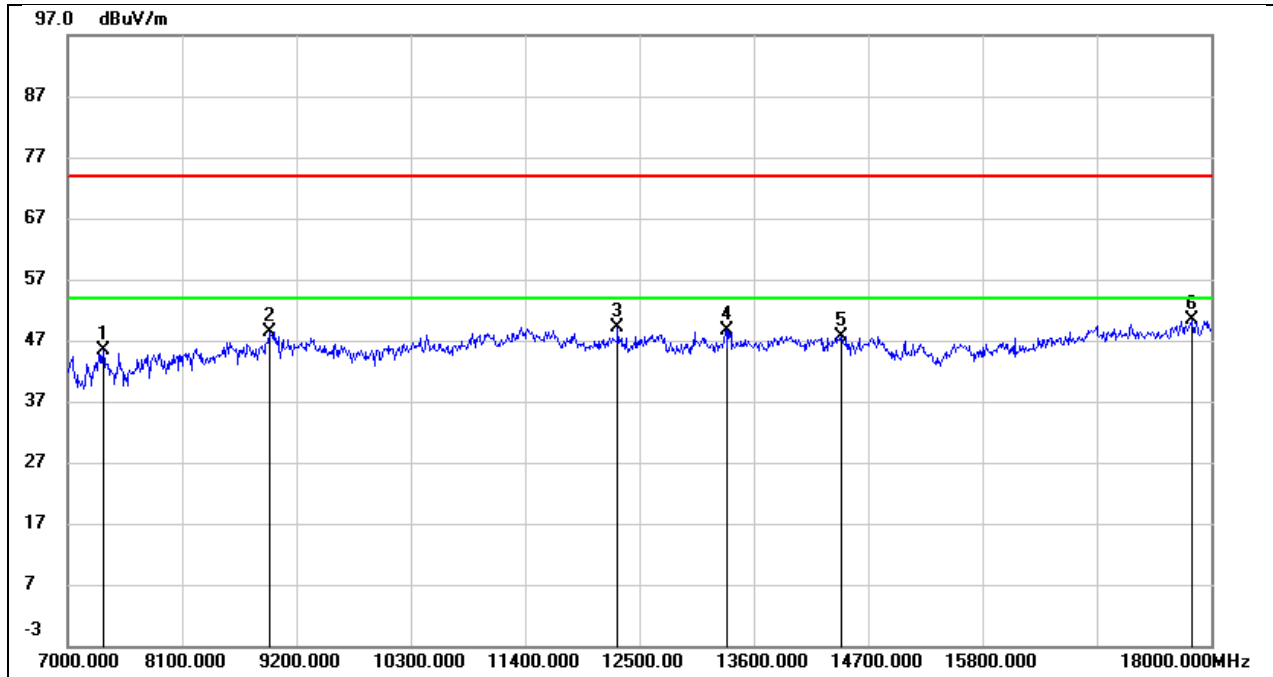

No.	Frequency (MHz)	Reading (dBuV)	Correct (dB/m)	Result (dBuV/m)	Limit (dBuV/m)	Margin (dB)	Remark
1	7341.000	36.66	8.79	45.45	74.00	-28.55	peak
2	8936.000	36.95	11.44	48.39	74.00	-25.61	peak
3	12291.000	31.71	17.30	49.01	74.00	-24.99	peak
4	13336.000	29.68	18.93	48.61	74.00	-25.39	peak
5	14447.000	27.55	20.13	47.68	74.00	-26.32	peak
6	17813.000	24.27	26.00	50.27	74.00	-23.73	peak

Test Mode:	802.11n HT40	Frequency(MHz):	5230
Polarity:	Horizontal	Test Voltage:	AC 120V_60HZ

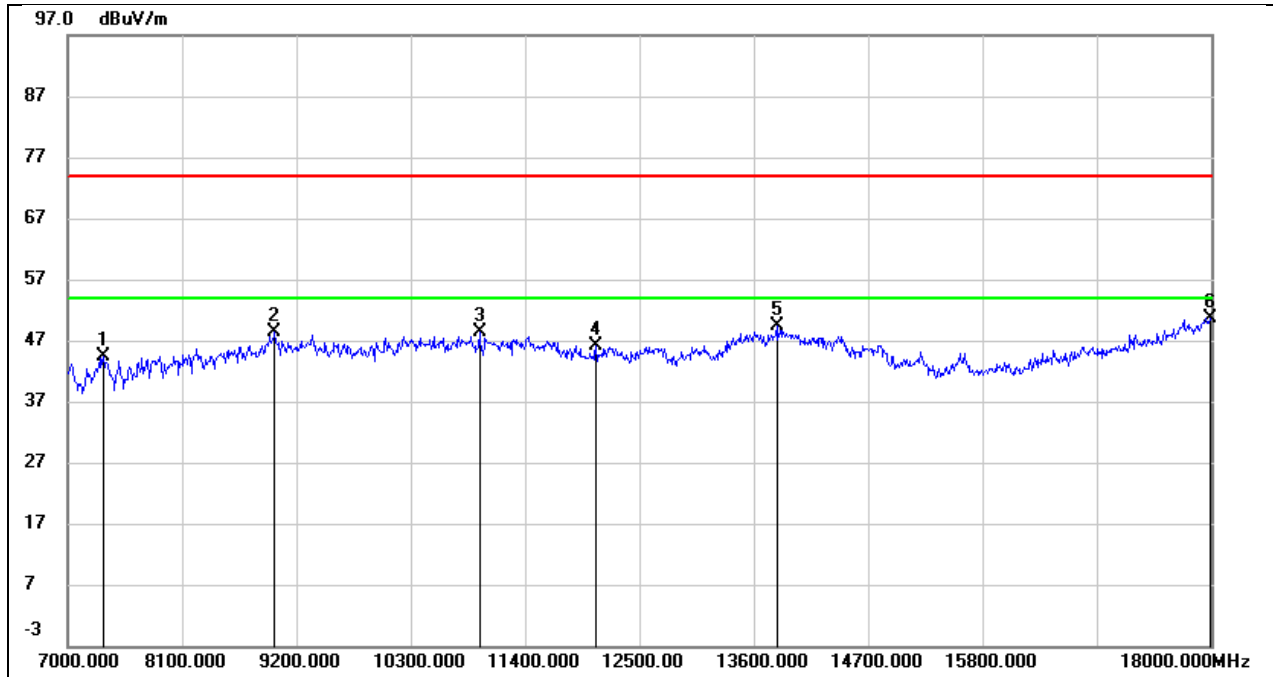

No.	Frequency (MHz)	Reading (dBuV)	Correct (dB/m)	Result (dBuV/m)	Limit (dBuV/m)	Margin (dB)	Remark
1	7341.000	36.30	8.17	44.47	74.00	-29.53	peak
2	8991.000	36.60	11.83	48.43	74.00	-25.57	peak
3	10960.000	33.75	14.56	48.31	74.00	-25.69	peak
4	12082.000	28.02	18.02	46.04	74.00	-27.96	peak
5	13820.000	27.17	22.26	49.43	74.00	-24.57	peak
6	17989.000	22.27	28.41	50.68	74.00	-23.32	peak

Test Mode:	802.11n HT40	Frequency(MHz):	5230
Polarity:	Vertical	Test Voltage:	AC 120V_60HZ

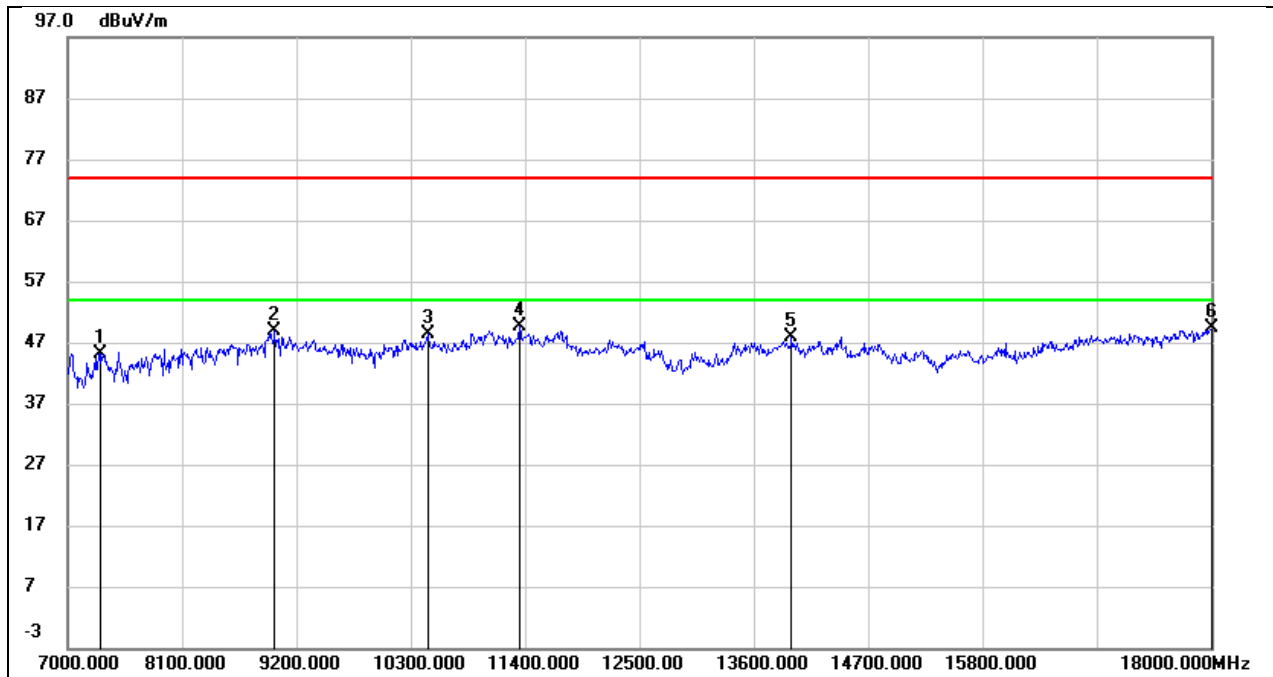

No.	Frequency (MHz)	Reading (dBuV)	Correct (dB/m)	Result (dBuV/m)	Limit (dBuV/m)	Margin (dB)	Remark
1	7308.000	36.62	8.54	45.16	74.00	-28.84	peak
2	8991.000	36.53	12.23	48.76	74.00	-25.24	peak
3	10465.000	35.40	12.90	48.30	74.00	-25.70	peak
4	11345.000	34.97	14.72	49.69	74.00	-24.31	peak
5	13963.000	27.15	20.79	47.94	74.00	-26.06	peak
6	18000.000	23.12	26.27	49.39	74.00	-24.61	peak

8.4. SPURIOUS EMISSIONS(9 KHZ~30 MHZ)

Test Mode:	802.11a20	Frequency(MHz):	5180
Polarity:	Horizontal	Test Voltage:	AC 120V_60HZ

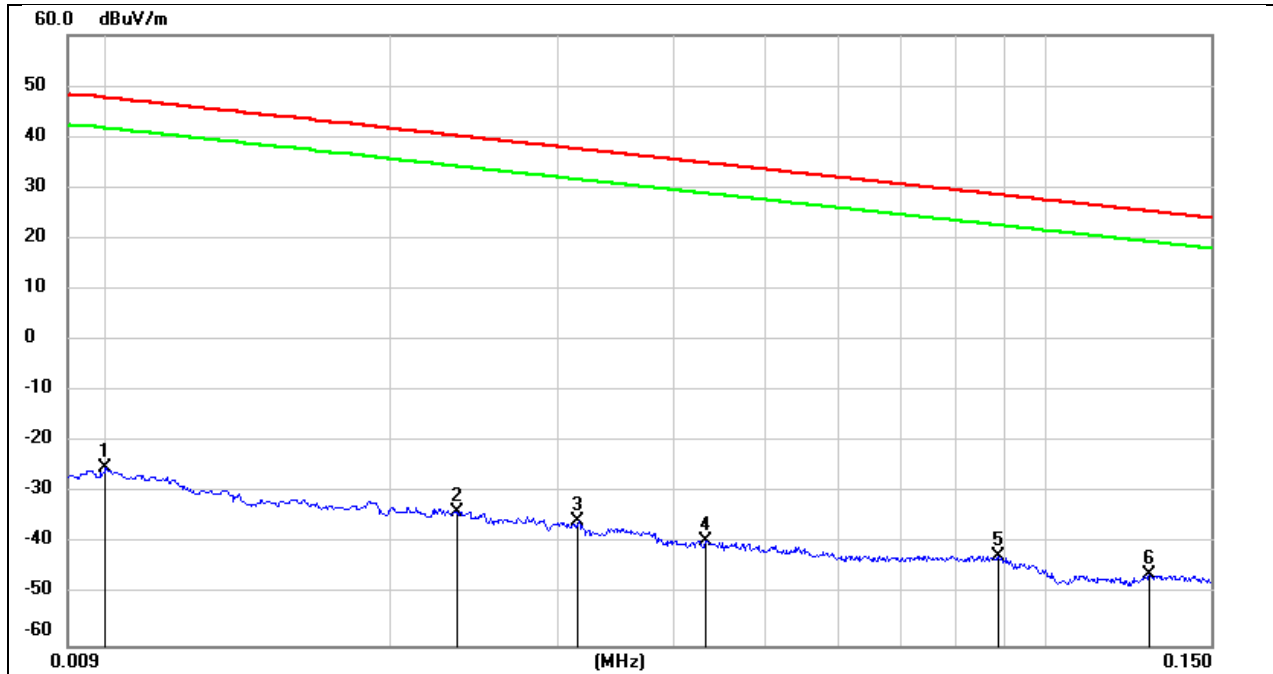

No.	Frequency (MHz)	Reading (dBuV)	Correct (dB/m)	Result (dBuV/m)	Limit (dBuV/m)	Margin (dB)	Remark
1	0.0100	76.22	-101.40	-25.18	47.60	-72.78	peak
2	0.0235	67.61	-101.36	-33.75	40.18	-73.93	peak
3	0.0316	65.74	-101.40	-35.66	37.61	-73.27	peak
4	0.0432	62.07	-101.45	-39.38	34.89	-74.27	peak
5	0.0889	59.27	-101.71	-42.44	28.63	-71.07	peak
6	0.1290	55.58	-101.70	-46.12	25.40	-71.52	peak

Test Mode:	802.11a20	Frequency(MHz):	5180
Polarity:	Horizontal	Test Voltage:	AC 120V_60HZ

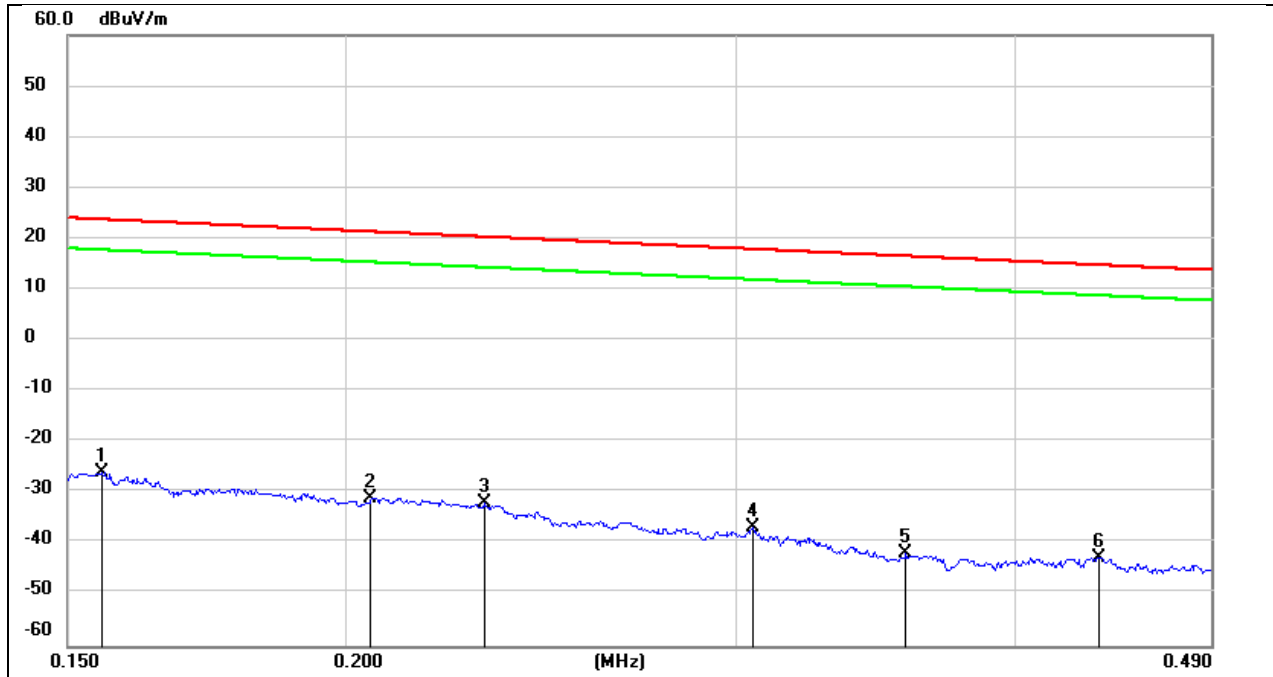

No.	Frequency (MHz)	Reading (dBuV)	Correct (dB/m)	Result (dBuV/m)	Limit (dBuV/m)	Margin (dB)	Remark
1	0.1554	75.77	-101.65	-25.88	23.77	-49.65	peak
2	0.2053	70.79	-101.73	-30.94	21.35	-52.29	peak
3	0.2308	69.83	-101.77	-31.94	20.34	-52.28	peak
4	0.3048	65.04	-101.86	-36.82	17.92	-54.74	peak
5	0.3573	60.08	-101.91	-41.83	16.54	-58.37	peak
6	0.4364	59.36	-101.99	-42.63	14.80	-57.43	peak

Test Mode:	802.11a20	Frequency(MHz):	5180
Polarity:	Horizontal	Test Voltage:	AC 120V_60HZ

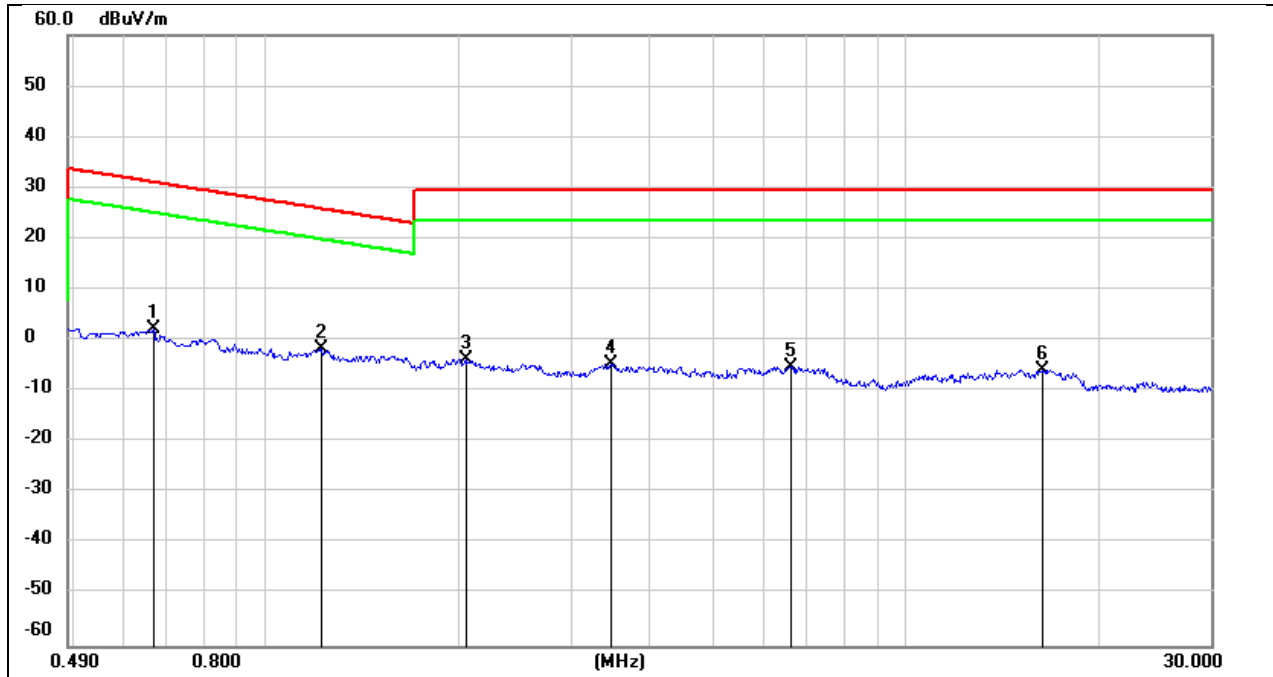

No.	Frequency (MHz)	Reading (dBuV)	Correct (dB/m)	Result (dBuV/m)	Limit (dBuV/m)	Margin (dB)	Remark
1	0.6671	64.25	-62.10	2.15	31.12	-28.97	peak
2	1.2214	60.62	-62.16	-1.54	25.87	-27.41	peak
3	2.0539	58.20	-61.81	-3.61	29.54	-33.15	peak
4	3.4704	56.85	-61.46	-4.61	29.54	-34.15	peak
5	6.5998	56.12	-61.27	-5.15	29.54	-34.69	peak
6	16.3959	55.17	-60.96	-5.79	29.54	-35.33	peak

8.5. SPURIOUS EMISSIONS(18 GHZ~26 GHZ)

Test Mode:	802.11a 20	Frequency(MHz):	5180
Polarity:	Horizontal	Test Voltage:	AC 120V_60HZ

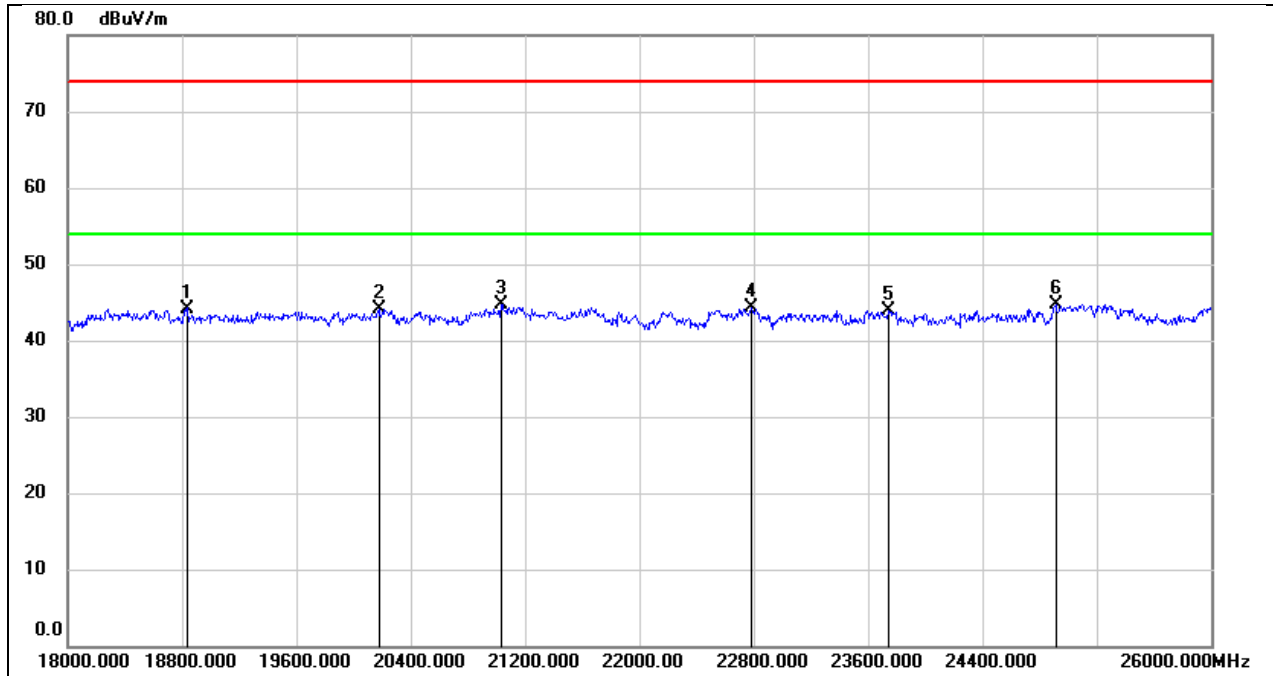

No.	Frequency (MHz)	Reading (dBuV)	Correct (dB/m)	Result (dBuV/m)	Limit (dBuV/m)	Margin (dB)	Remark
1	18832.000	49.55	-5.35	44.20	74.00	-29.80	peak
2	20176.000	49.64	-5.56	44.08	74.00	-29.92	peak
3	21032.000	49.65	-4.87	44.78	74.00	-29.22	peak
4	22784.000	47.98	-3.65	44.33	74.00	-29.67	peak
5	23744.000	47.15	-3.20	43.95	74.00	-30.05	peak
6	24912.000	46.92	-2.18	44.74	74.00	-29.26	peak

Test Mode:	802.11a 20	Frequency(MHz):	5180
Polarity:	Vertical	Test Voltage:	AC 120V_60HZ

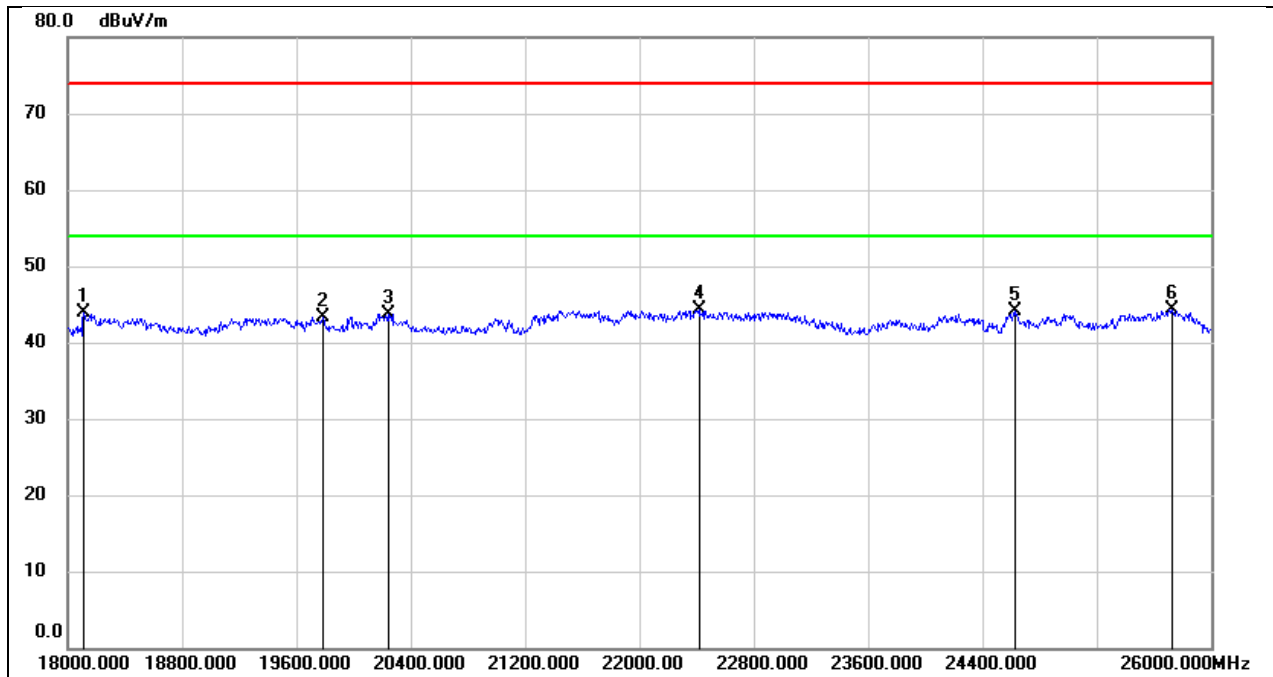

No.	Frequency (MHz)	Reading (dBuV)	Correct (dB/m)	Result (dBuV/m)	Limit (dBuV/m)	Margin (dB)	Remark
1	18112.000	49.46	-5.47	43.99	74.00	-30.01	peak
2	19784.000	48.57	-5.28	43.29	74.00	-30.71	peak
3	20240.000	49.32	-5.61	43.71	74.00	-30.29	peak
4	22416.000	48.23	-4.00	44.23	74.00	-29.77	peak
5	24624.000	46.49	-2.33	44.16	74.00	-29.84	peak
6	25728.000	45.11	-0.72	44.39	74.00	-29.61	peak

8.6. SPURIOUS EMISSIONS(26 GHZ~40 GHZ)

Test Mode:	802.11a 20	Frequency(MHz):	5180
Polarity:	Horizontal	Test Voltage:	AC 120V_60HZ

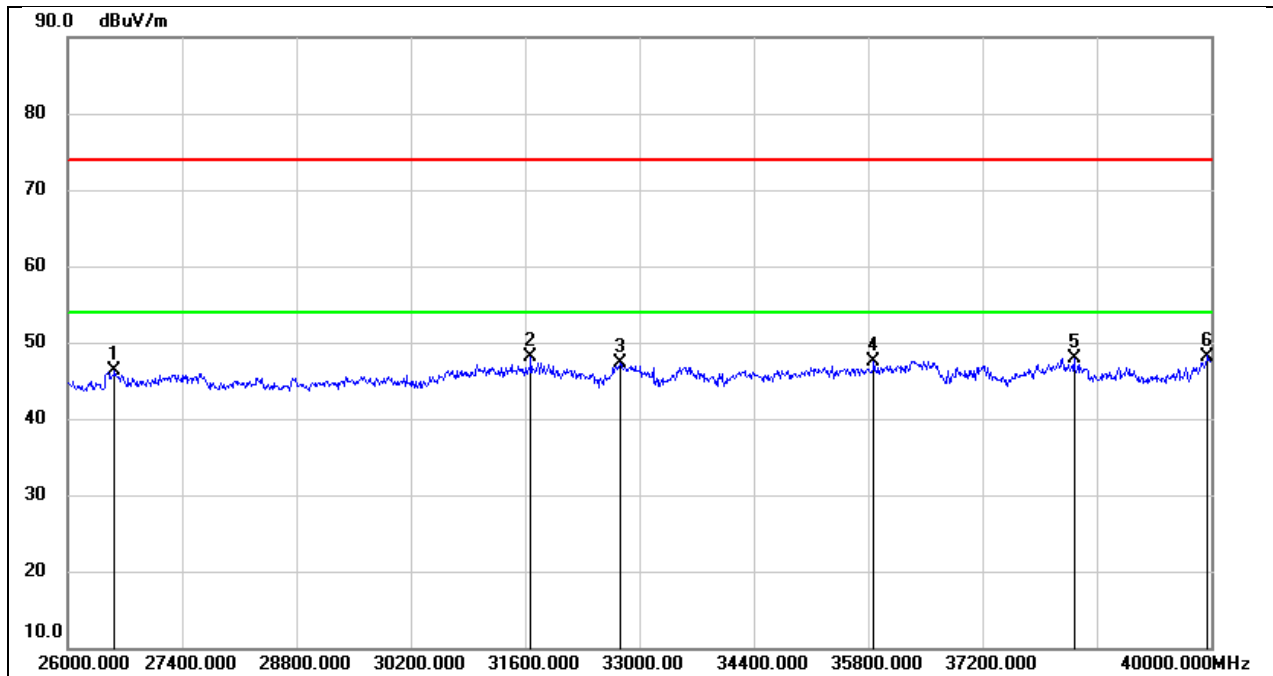

No.	Frequency (MHz)	Reading (dBuV)	Correct (dB/m)	Result (dBuV/m)	Limit (dBuV/m)	Margin (dB)	Remark
1	26574.000	51.04	-4.78	46.26	74.00	-27.74	peak
2	31670.000	49.36	-1.21	48.15	74.00	-25.85	peak
3	32762.000	48.45	-1.21	47.24	74.00	-26.76	peak
4	35870.000	43.83	3.75	47.58	74.00	-26.42	peak
5	38320.000	44.06	3.77	47.83	74.00	-26.17	peak
6	39958.000	43.08	5.12	48.20	74.00	-25.80	peak

Test Mode:	802.11a 20	Frequency(MHz):	5180
Polarity:	Vertical	Test Voltage:	AC 120V_60HZ

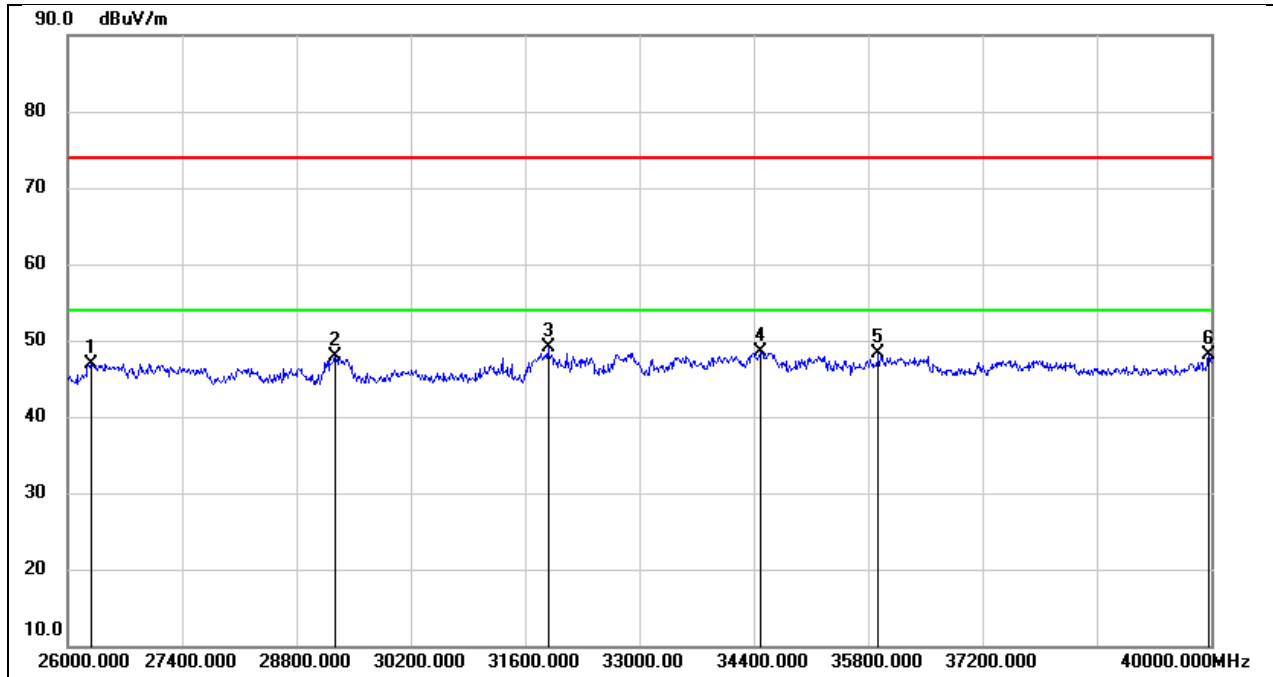

No.	Frequency (MHz)	Reading (dBuV)	Correct (dB/m)	Result (dBuV/m)	Limit (dBuV/m)	Margin (dB)	Remark
1	26280.000	52.23	-5.29	46.94	74.00	-27.06	peak
2	29276.000	49.01	-1.01	48.00	74.00	-26.00	peak
3	31880.000	50.78	-1.71	49.07	74.00	-24.93	peak
4	34484.000	47.55	0.94	48.49	74.00	-25.51	peak
5	35926.000	44.44	3.88	48.32	74.00	-25.68	peak
6	39972.000	42.95	5.13	48.08	74.00	-25.92	peak

8.7. SPURIOUS EMISSIONS(30 MHZ~1 GHZ)

Test Mode:	802.11a 20	Frequency(MHz):	5180
Polarity:	Horizontal	Test Voltage:	AC120V_60Hz

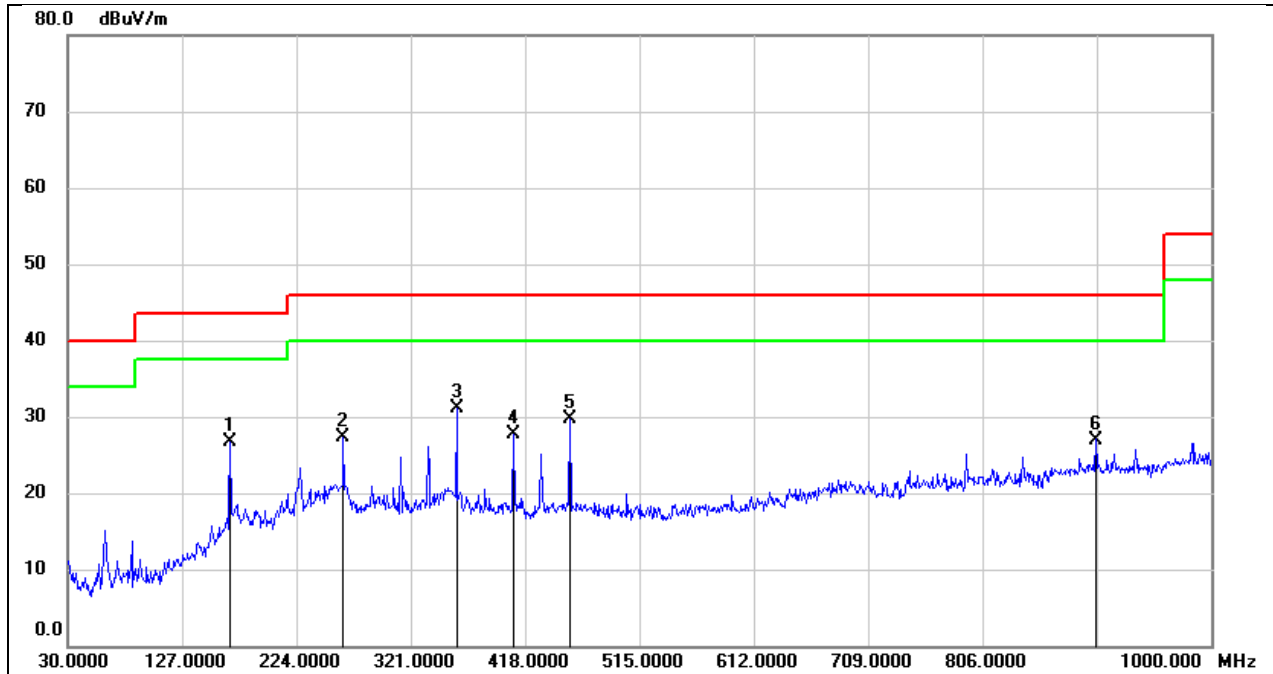

No.	Frequency (MHz)	Reading (dBuV)	Correct (dB/m)	Result (dBuV/m)	Limit (dBuV/m)	Margin (dB)	Remark
1	167.7400	38.33	-11.71	26.62	43.50	-16.88	QP
2	263.7700	40.88	-13.59	27.29	46.00	-18.71	QP
3	359.8000	40.19	-9.16	31.03	46.00	-14.97	QP
4	408.3000	36.83	-9.13	27.70	46.00	-18.30	QP
5	455.8300	37.79	-8.02	29.77	46.00	-16.23	QP
6	902.0300	27.86	-0.86	27.00	46.00	-19.00	QP

Test Mode:	802.11a 20	Frequency(MHz):	5180
Polarity:	Vertical	Test Voltage:	AC120V_60Hz

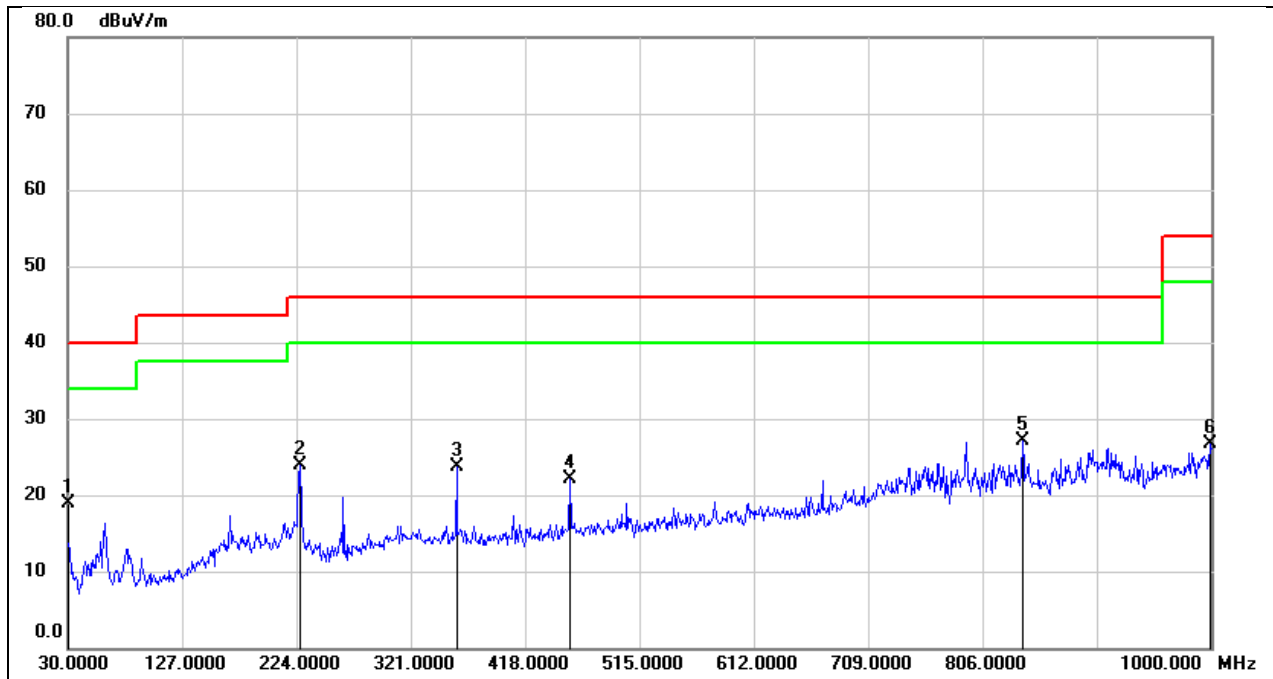

No.	Frequency (MHz)	Reading (dBuV)	Correct (dB/m)	Result (dBuV/m)	Limit (dBuV/m)	Margin (dB)	Remark
1	30.0000	33.27	-14.34	18.93	40.00	-21.07	QP
2	226.9100	36.85	-12.98	23.87	46.00	-22.13	QP
3	359.8000	32.83	-9.16	23.67	46.00	-22.33	QP
4	455.8300	30.21	-8.02	22.19	46.00	-23.81	QP
5	839.9500	29.10	-1.93	27.17	46.00	-18.83	QP
6	999.0300	27.64	-0.85	26.79	54.00	-27.21	QP

9. AC POWER LINE CONDUCTED EMISSION

LIMITS

Please refer to CFR 47 FCC §15.207 (a)

FREQUENCY (MHz)	Quasi-peak	Average
0.15 -0.5	66 - 56 *	56 - 46 *
0.50 -5.0	56.00	46.00
5.0 -30.0	60.00	50.00

TEST PROCEDURE

Refer to ANSI C63.10-2013 clause 6.2.

The EUT is put on a table of non-conducting material that is 80 cm high. The vertical conducting wall of shielding is located 40 cm to the rear of the EUT. The power line of the EUT is connected to the AC mains through a Artificial Mains Network (A.M.N.). A EMI Measurement Receiver (R&S Test Receiver ESR3) is used to test the emissions from both sides of AC line. According to the requirements in Section 6.2 of ANSI C63.10-2013. Conducted emissions from the EUT measured in the frequency range between 0.15 MHz and 30 MHz using CISPR Quasi-Peak and average detector mode. The bandwidth of EMI test receiver is set at 9 kHz.

The arrangement of the equipment is installed to meet the standards and operating in a manner, which tends to maximize its emission characteristics in a normal application.

TEST SETUP

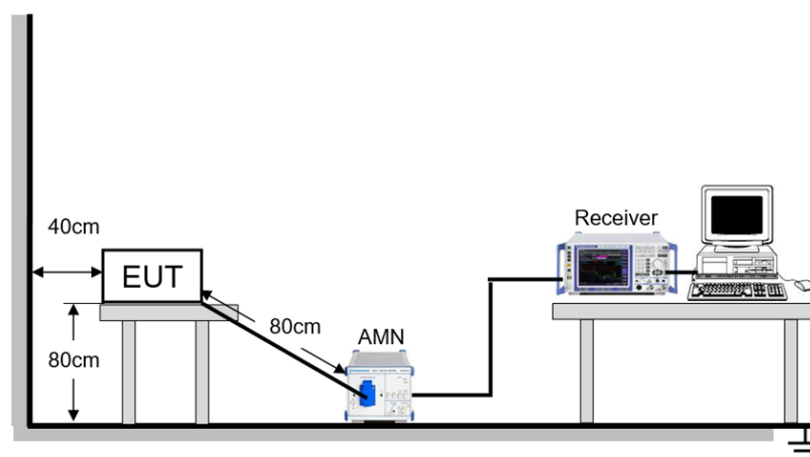

TEST ENVIRONMENT

Temperature	22.8°C	Relative Humidity	53%
Atmosphere Pressure	101kPa	Test Voltage	AC 120V_60Hz

TEST DATE / ENGINEER

Test Date	August 2, 2024	Test By	James Qin
-----------	----------------	---------	-----------

TEST RESULTS

Test Mode:	802.11a	Frequency(MHz):	5180
Line:	Line		

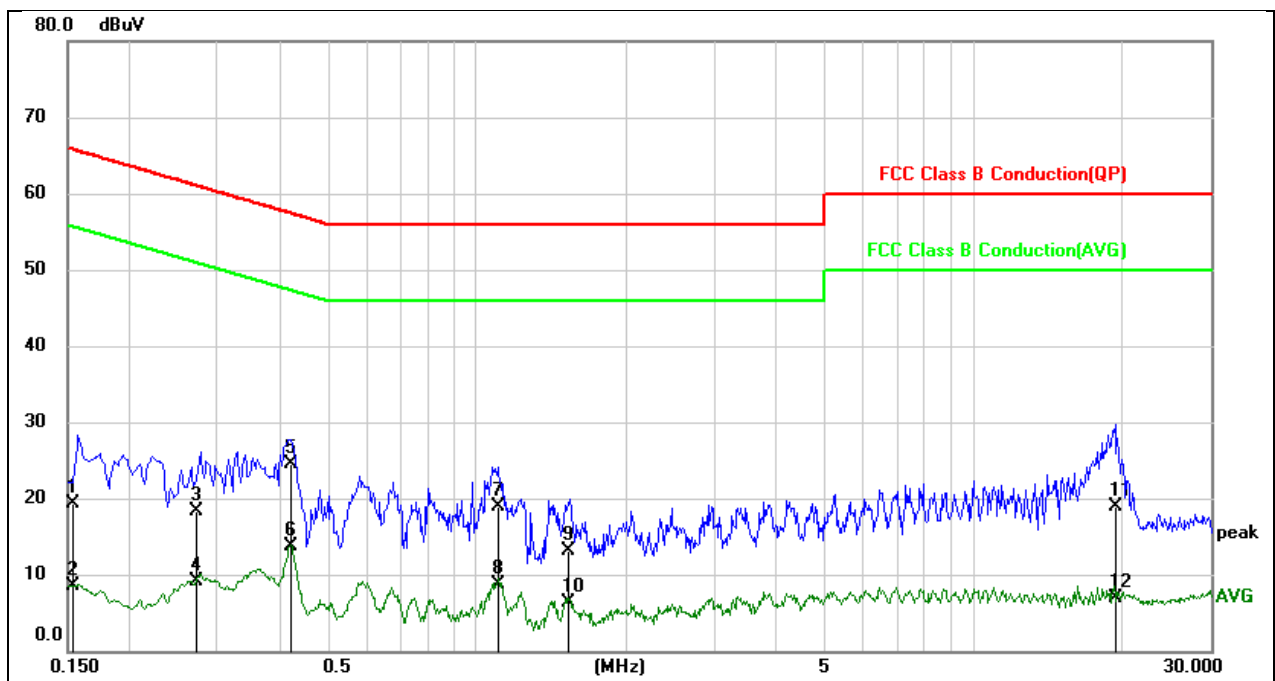

No.	Frequency (MHz)	Reading (dBuV)	Correct (dB)	Result (dBuV)	Limit (dBuV)	Margin (dB)	Remark
1	0.1533	8.96	10.33	19.29	65.82	-46.53	QP
2	0.1533	-1.75	10.33	8.58	55.82	-47.24	AVG
3	0.2738	8.11	10.24	18.35	61.00	-42.65	QP
4	0.2738	-1.05	10.24	9.19	51.00	-41.81	AVG
5	0.4217	14.36	10.24	24.60	57.41	-32.81	QP
6	0.4217	3.50	10.24	13.74	47.41	-33.67	AVG
7	1.1052	8.82	10.02	18.84	56.00	-37.16	QP
8	1.1052	-1.31	10.02	8.71	46.00	-37.29	AVG
9	1.5323	3.10	9.99	13.09	56.00	-42.91	QP
10	1.5323	-3.64	9.99	6.35	46.00	-39.65	AVG
11	19.1582	8.19	10.79	18.98	60.00	-41.02	QP
12	19.1582	-3.79	10.79	7.00	50.00	-43.00	AVG

Note:

1. Result = Reading + Correct Factor.

2. If QP Result complies with AV limit, AV Result is deemed to comply with AV limit.
3. Test setup: RBW: 200 Hz (9 kHz ~ 150 kHz), 9 kHz (150 kHz ~ 30 MHz).
4. Step size: 80 Hz (0.009 MHz ~ 0.15 MHz), 4 kHz (0.15 MHz ~ 30 MHz), Scan time: auto.

Note: All the modes have been tested, only the worst data was recorded in the report.

Test Mode:	802.11a	Frequency(MHz):	5180
Line:	Neutral		

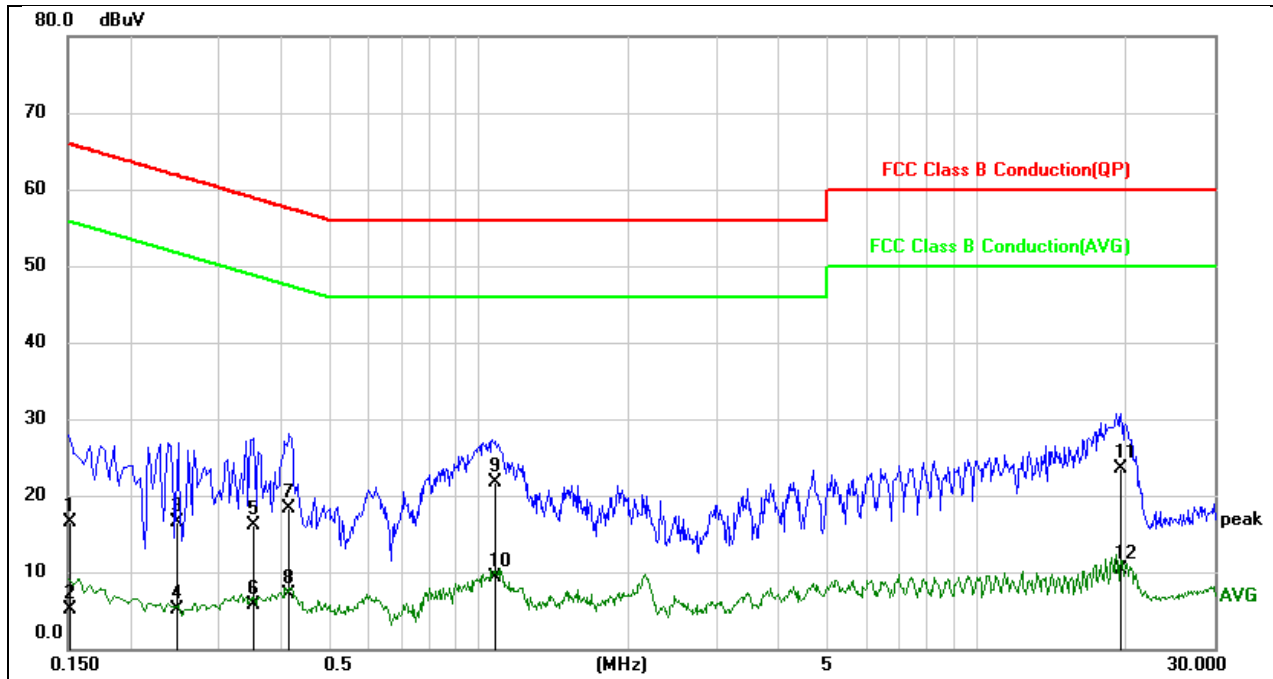

No.	Frequency (MHz)	Reading (dBuV)	Correct (dB)	Result (dBuV)	Limit (dBuV)	Margin (dB)	Remark
1	0.1516	6.28	10.24	16.52	65.91	-49.39	QP
2	0.1516	-5.23	10.24	5.01	55.91	-50.90	AVG
3	0.2468	6.44	10.12	16.56	61.86	-45.30	QP
4	0.2468	-4.99	10.12	5.13	51.86	-46.73	AVG
5	0.3557	6.05	10.09	16.14	58.83	-42.69	QP
6	0.3557	-4.29	10.09	5.80	48.83	-43.03	AVG
7	0.4186	8.27	10.07	18.34	57.48	-39.14	QP
8	0.4186	-2.97	10.07	7.10	47.48	-40.38	AVG
9	1.0839	11.85	9.85	21.70	56.00	-34.30	QP
10	1.0839	-0.50	9.85	9.35	46.00	-36.65	AVG
11	19.4658	12.60	10.91	23.51	60.00	-36.49	QP
12	19.4658	-0.65	10.91	10.26	50.00	-39.74	AVG

Note:

1. Result = Reading + Correct Factor.
2. If QP Result complies with AV limit, AV Result is deemed to comply with AV limit.
3. Test setup: RBW: 200 Hz (9 kHz ~ 150 kHz), 9 kHz (150 kHz ~ 30 MHz).
4. Step size: 80 Hz (0.009 MHz ~ 0.15 MHz), 4 kHz (0.15 MHz ~ 30 MHz), Scan time: auto.

Note: All the modes have been tested, only the worst data was recorded in the report.

10. ANTENNA REQUIREMENT

REQUIREMENT

Please refer to FCC part 15.203

An intentional radiator shall be designed to ensure that no antenna other than that furnished by the responsible party shall be used with the device. The use of a permanently attached antenna or of an antenna that uses a unique coupling to the intentional radiator shall be considered sufficient to comply with the provisions of this section. The manufacturer may design the unit so that a broken antenna can be replaced by the user, but the use of a standard antenna jack or electrical connector is prohibited.

Please refer to FCC part 15.407(a)

For an indoor access point operating in the band 5.15-5.25 GHz, the maximum conducted output power over the frequency band of operation shall not exceed 1 W provided the maximum antenna gain does not exceed 6 dBi. In addition, the maximum power spectral density shall not exceed 17 dBm in any 1 megahertz band. If transmitting antennas of directional gain greater than 6 dBi are used, both the maximum conducted output power and the maximum power spectral density shall be reduced by the amount in dB that the directional gain of the antenna exceeds 6 dBi.

DESCRIPTION

Pass

11. TEST DATA

11.1. APPENDIX A: EMISSION BANDWIDTH

11.1.1. Test Result

Test Mode	Antenna	Frequency[MHz]	26db EBW [MHz]	FL[MHz]	FH[MHz]
11A	Ant1	5180	19.52	5170.20	5189.72
		5200	19.16	5190.40	5209.56
		5240	19.40	5230.28	5249.68
11N20SISO	Ant1	5180	19.76	5170.12	5189.88
		5200	19.48	5190.28	5209.76
		5240	19.96	5229.96	5249.92
11N40SISO	Ant1	5190	40.16	5170.00	5210.16
		5230	40.32	5210.00	5250.32

11.1.2. Test Graphs

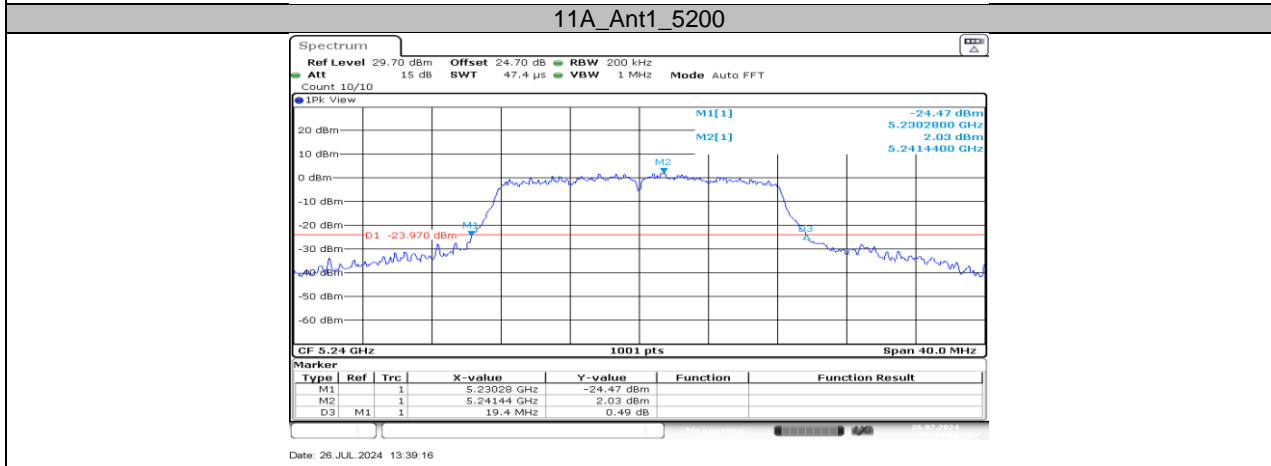
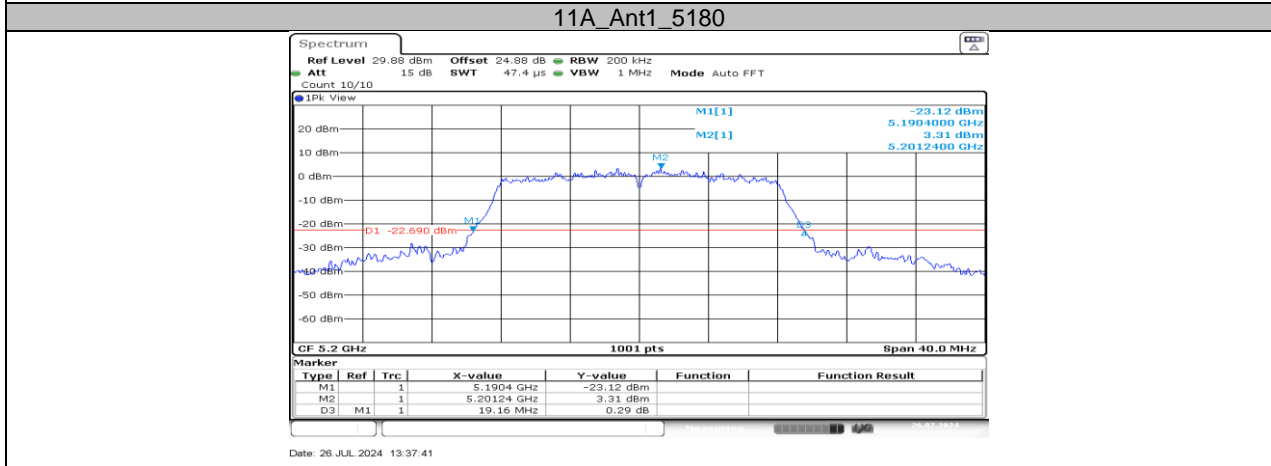
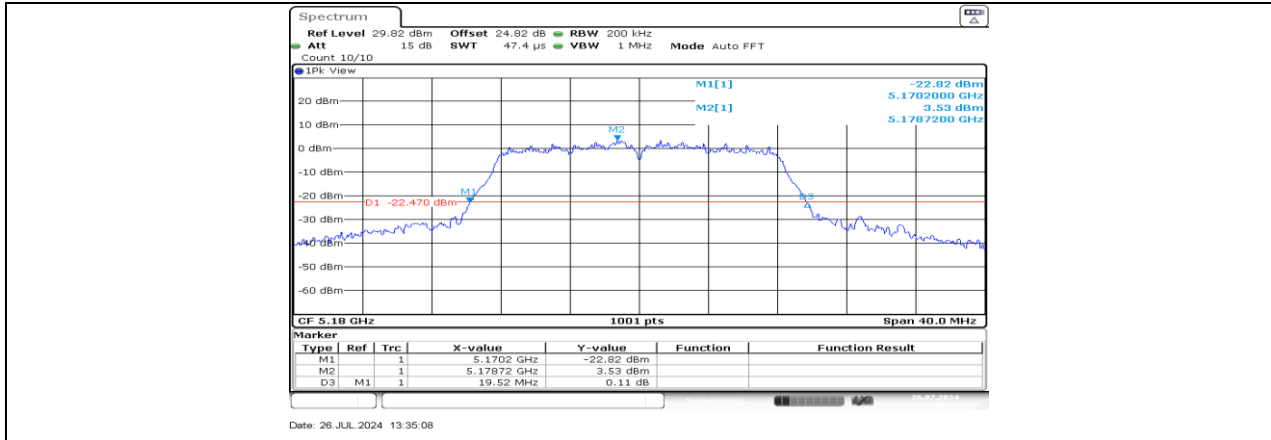

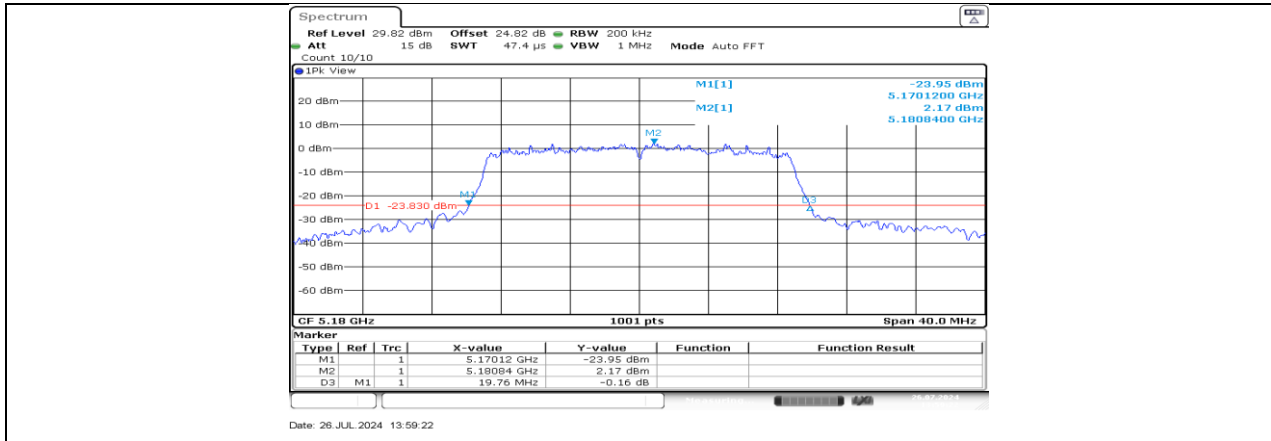

11N20SISO_Ant1_5180

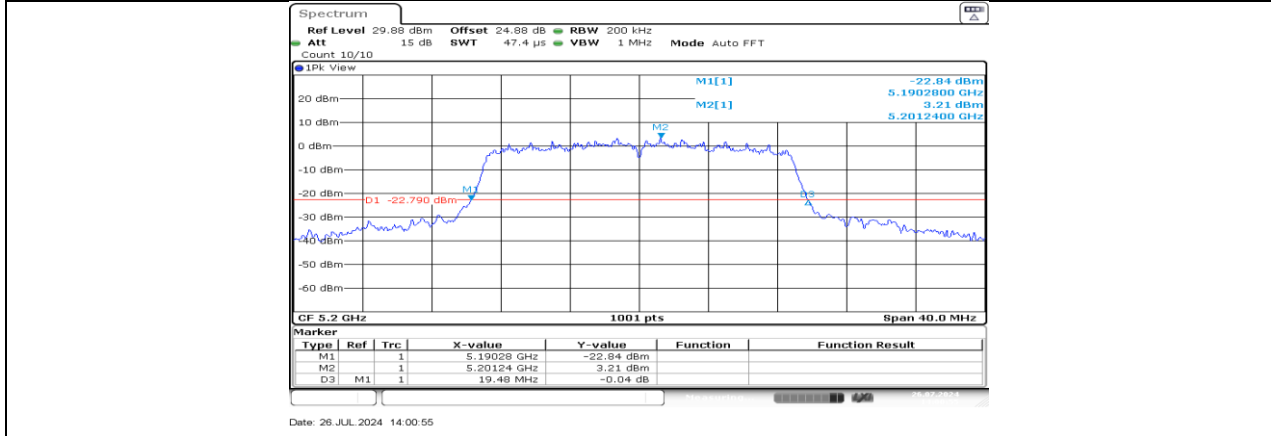

11N20SISO_Ant1_5200

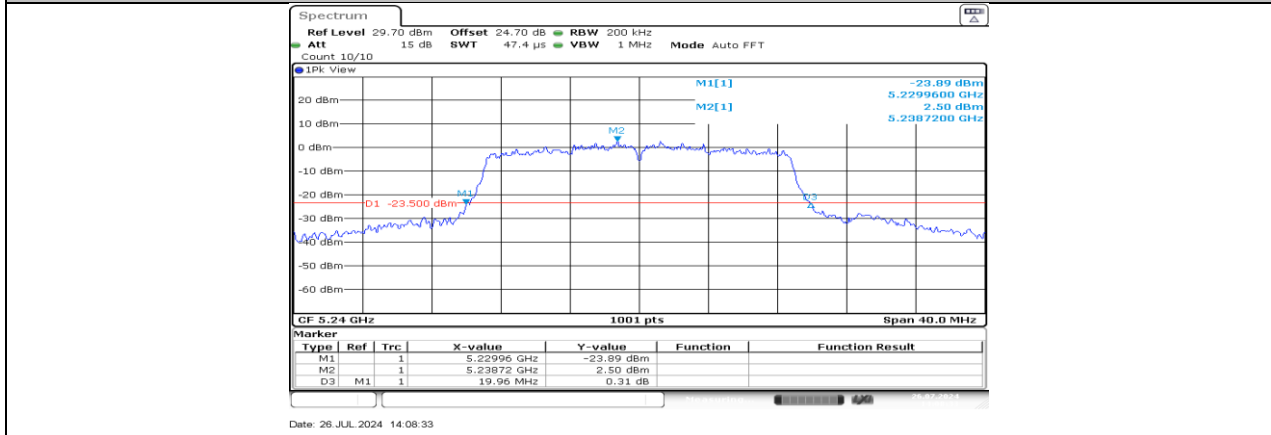

11N20SISO_Ant1_5240

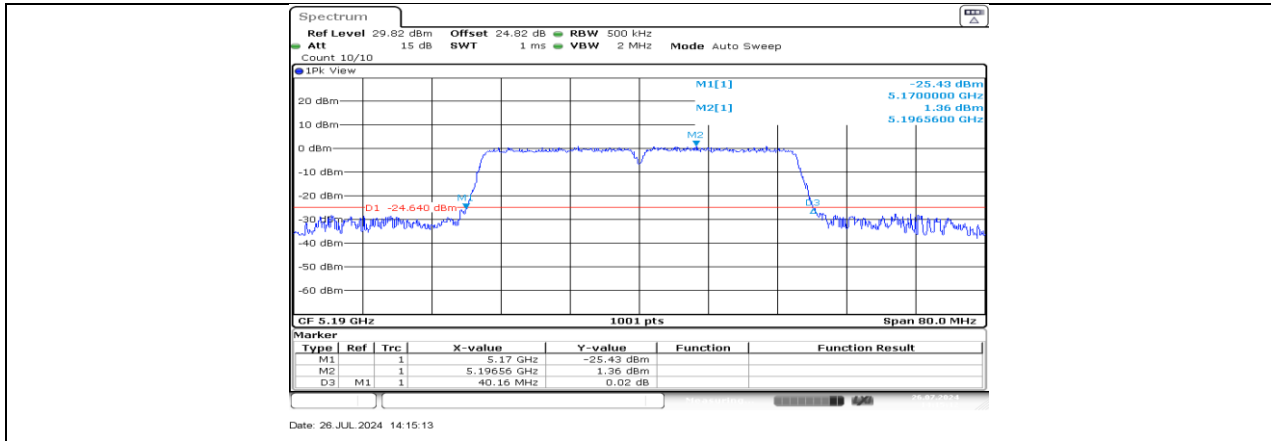

11N40SISO_Ant1_5190

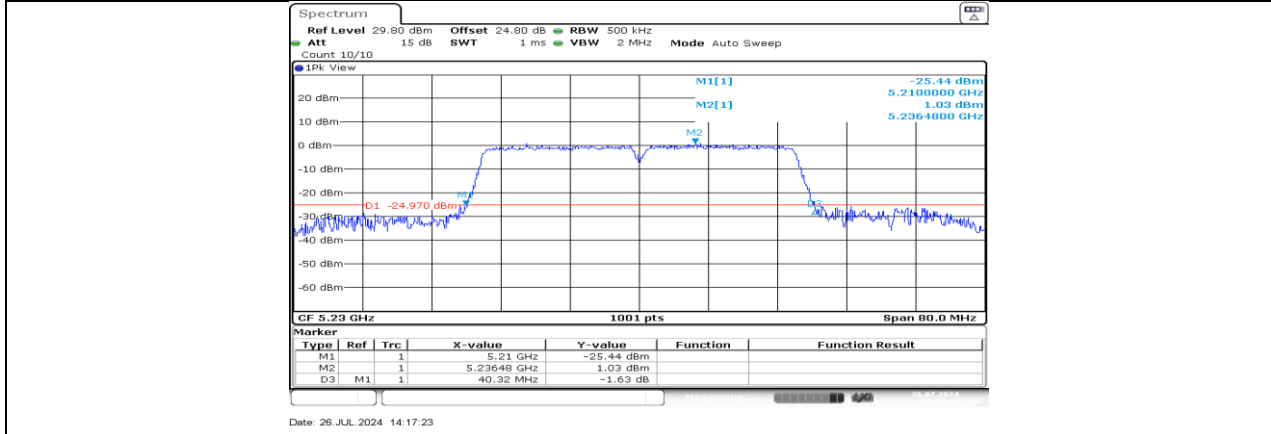

11N40SISO_Ant1_5230

11.2. APPENDIX B: OCCUPIED CHANNEL BANDWIDTH

11.2.1. Test Result

Test Mode	Antenna	Frequency[MHz]	OCB [MHz]	FL[MHz]	FH[MHz]
11A	Ant1	5180	17.143	5171.4086	5188.5514
		5200	17.223	5191.4086	5208.6314
		5240	17.343	5231.3686	5248.7113
11N20SISO	Ant1	5180	18.022	5171.0090	5189.0310
		5200	18.062	5190.9690	5209.0310
		5240	18.102	5230.9690	5249.0709
11N40SISO	Ant1	5190	36.444	5171.7782	5208.2218
		5230	36.763	5211.6983	5248.4615

11.2.2. Test Graphs

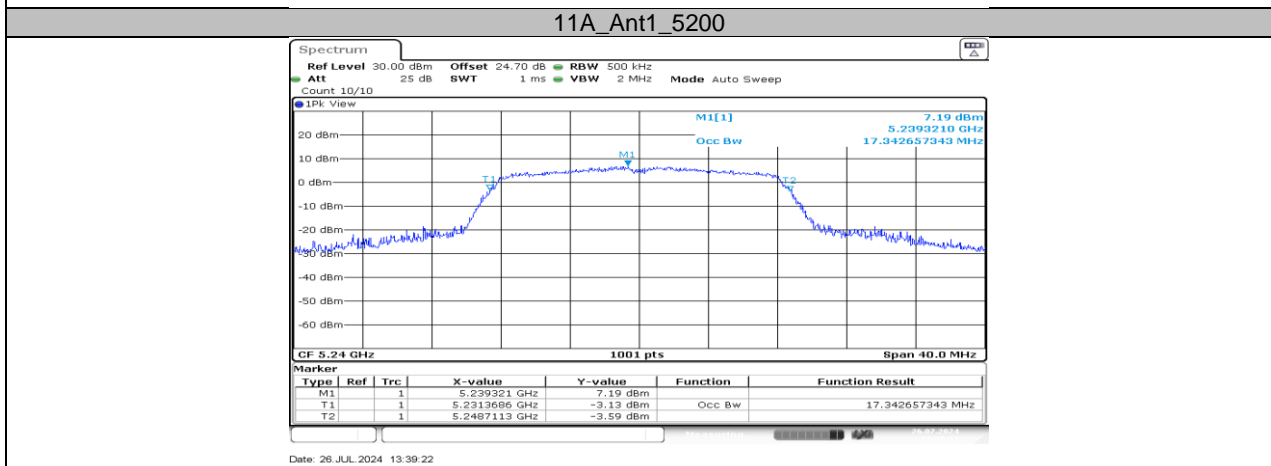
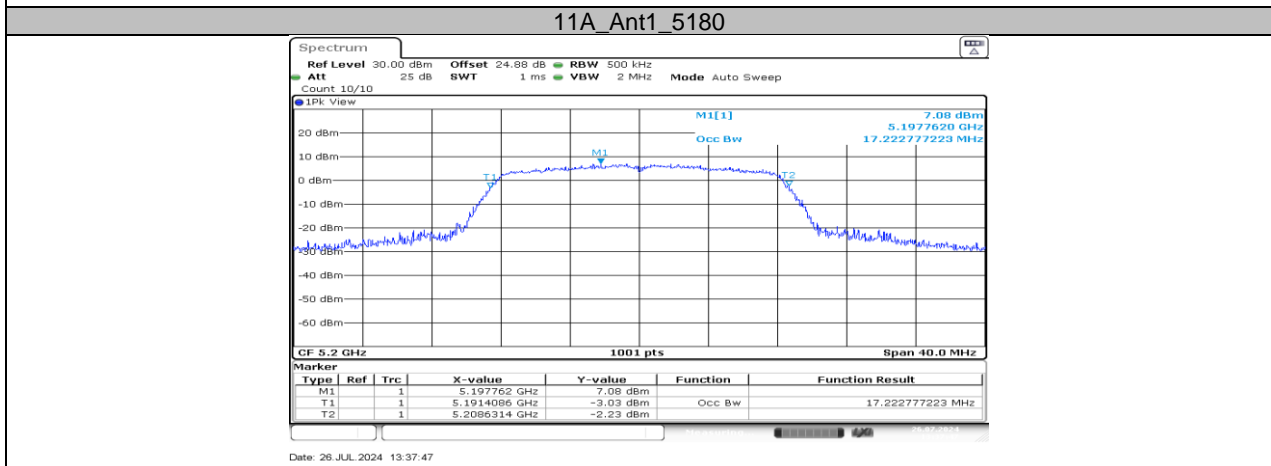
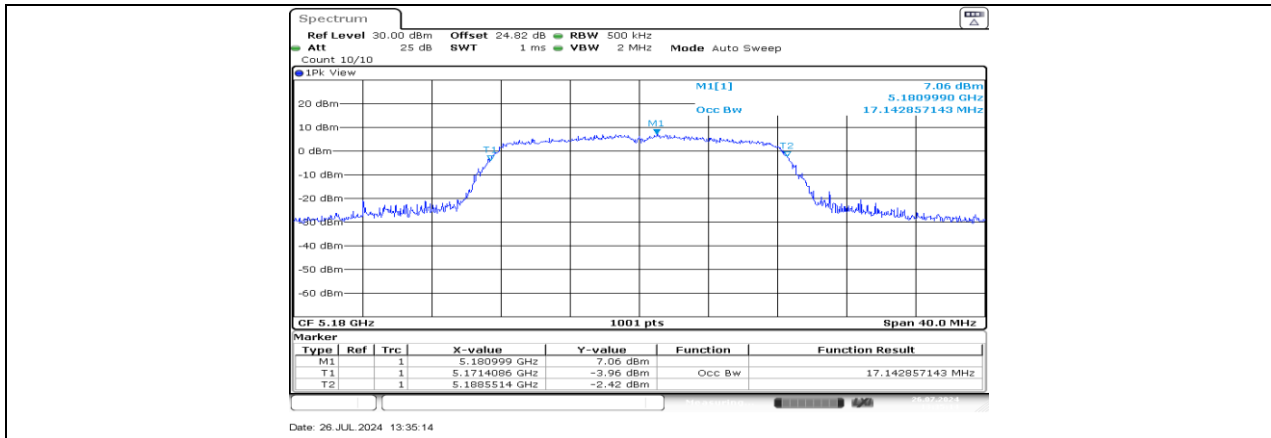

11A_Ant1_5240

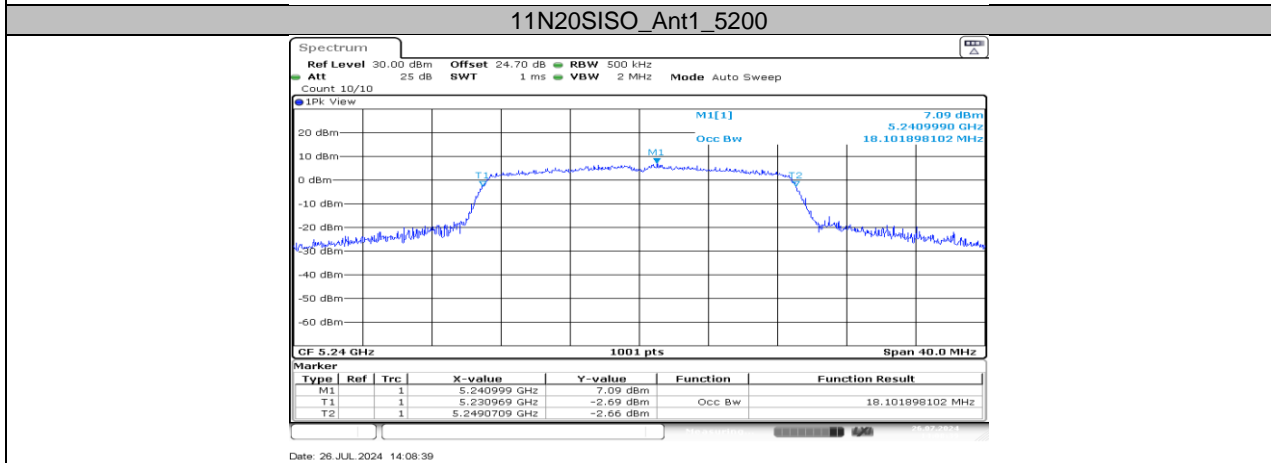
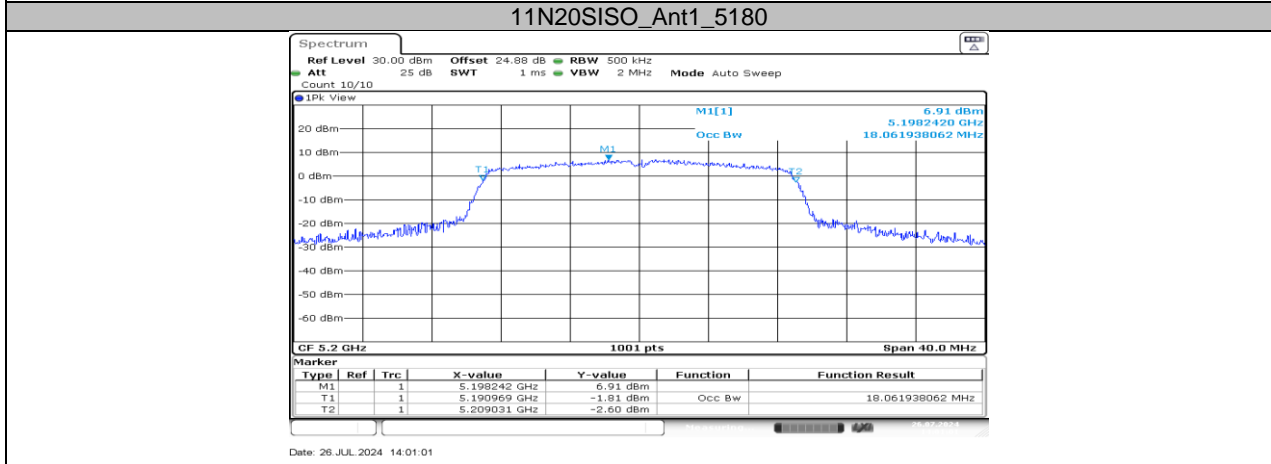
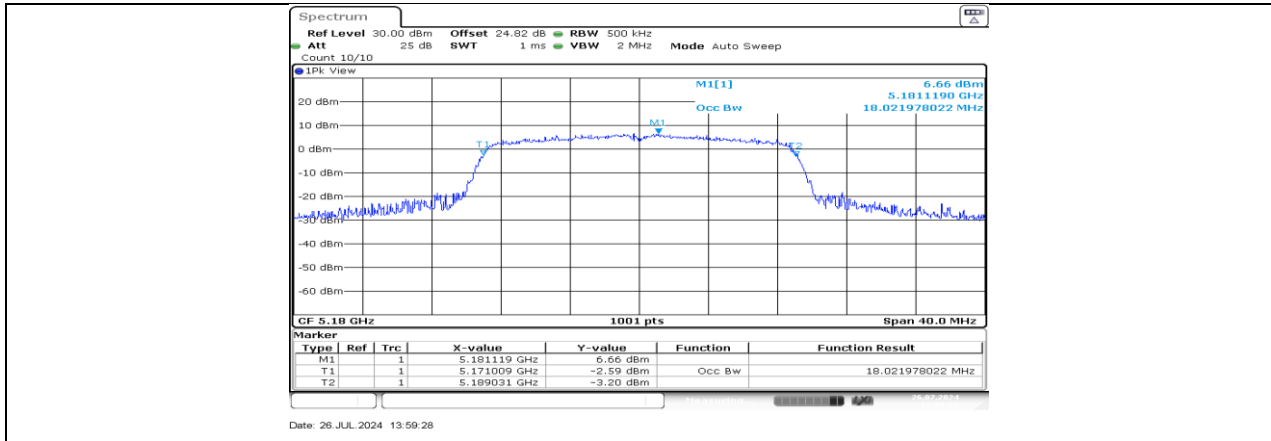

11N20SISO_Ant1_5240

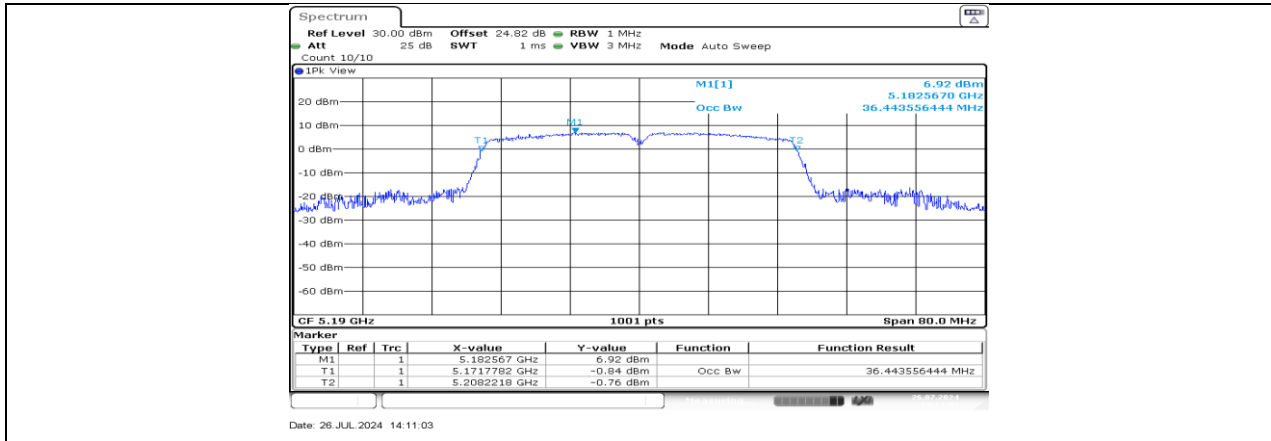

11N40SISO_Ant1_5190

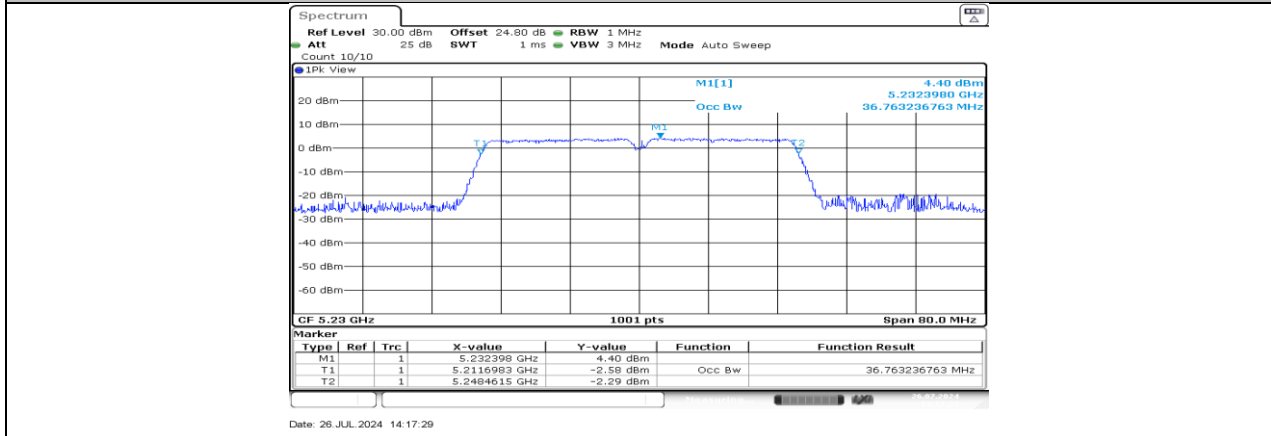

11N40SISO_Ant1_5230

11.3. APPENDIX D: MAXIMUM CONDUCTED OUTPUT POWER

11.3.1. Test Result

Test Mode	Antenna	Frequency[MHz]	Power [dBm]	FCC Limit [dBm]	Verdict
11A	Ant1	5180	12.90	≤23.98	PASS
		5200	12.69	≤23.98	PASS
		5240	12.35	≤23.98	PASS
11N20SISO	Ant1	5180	12.82	≤23.98	PASS
		5200	12.78	≤23.98	PASS
		5240	12.44	≤23.98	PASS
11N40SISO	Ant1	5190	12.94	≤23.98	PASS
		5230	12.54	≤23.98	PASS

Note: 1. Conducted Power=Meas. Level+ Correction Factor

2. The Duty Cycle Factor (refer to section 7.1) had already compensated to the test data.

11.4. APPENDIX E: MAXIMUM POWER SPECTRAL DENSITY

11.4.1. Test Result

Test Mode	Antenna	Frequency[MHz]	Power [dBm/MHz]	Limit [dBm/MHz]	EIRP [dBm/MHz]	Limit [dBm/MHz]	Verdict
11A	Ant1	5180	2.53	≤11.00	-0.44	≤10.00	PASS
		5200	2.32	≤11.00	-0.65	≤10.00	PASS
		5240	1.89	≤11.00	-1.08	≤10.00	PASS
11N20SISO	Ant1	5180	2.26	≤11.00	-0.71	≤10.00	PASS
		5200	2.19	≤11.00	-0.78	≤10.00	PASS
		5240	1.85	≤11.00	-1.12	≤10.00	PASS
11N40SISO	Ant1	5190	-1.17	≤11.00	-4.14	≤10.00	PASS
		5230	-1.62	≤11.00	-4.59	≤10.00	PASS

Note: The Duty Cycle Factor and RBW Factor is compensated in the graph.

11.4.2. Test Graphs

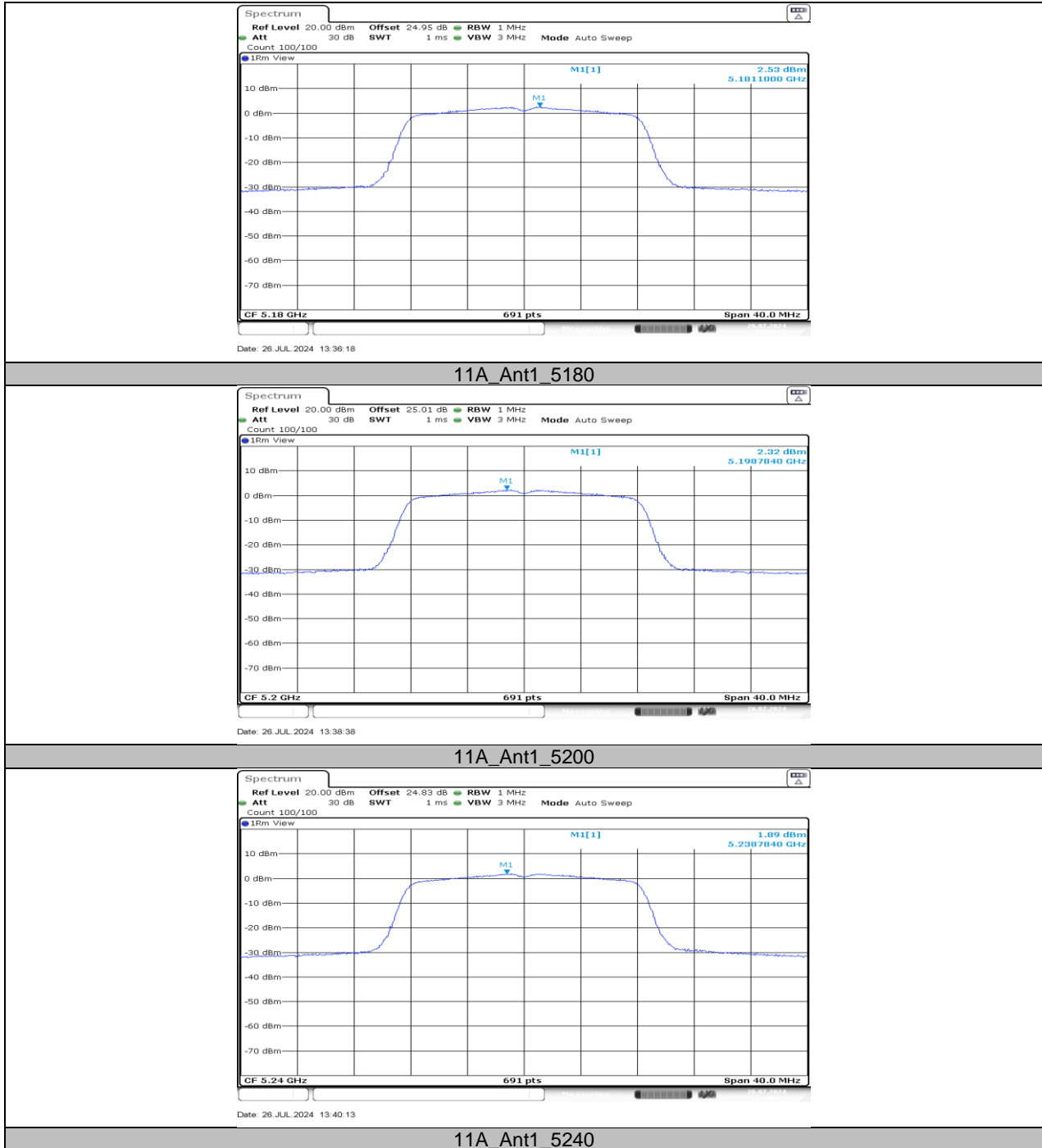

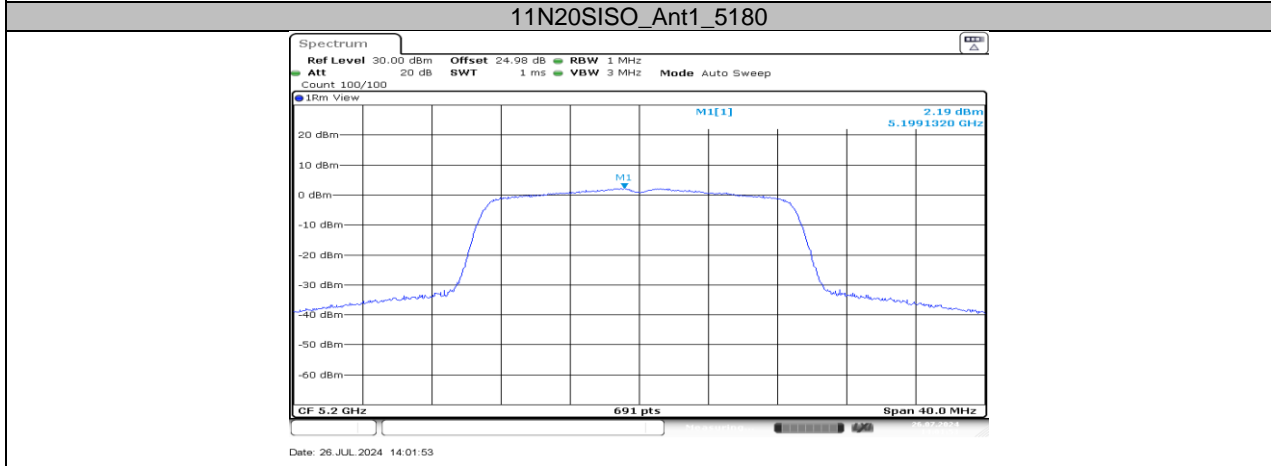
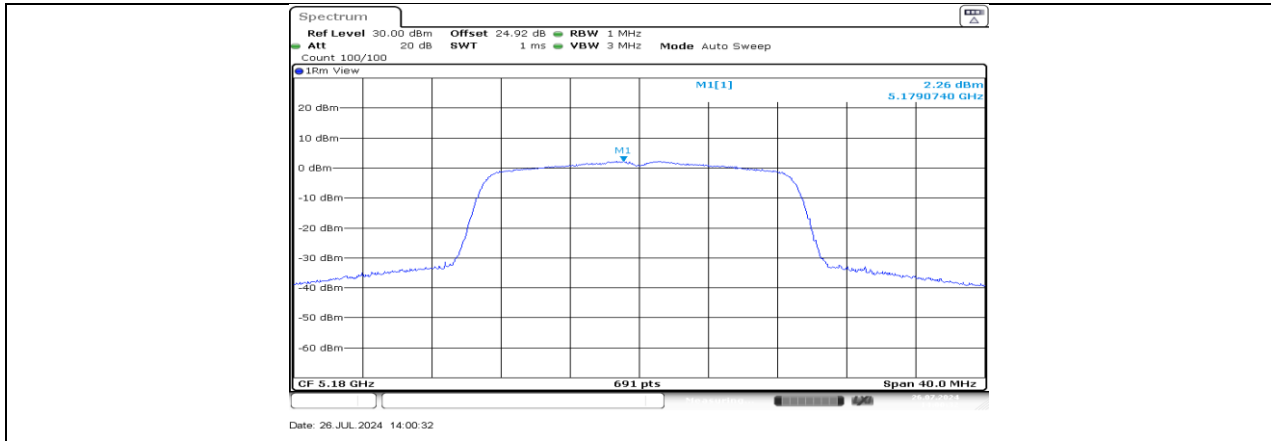

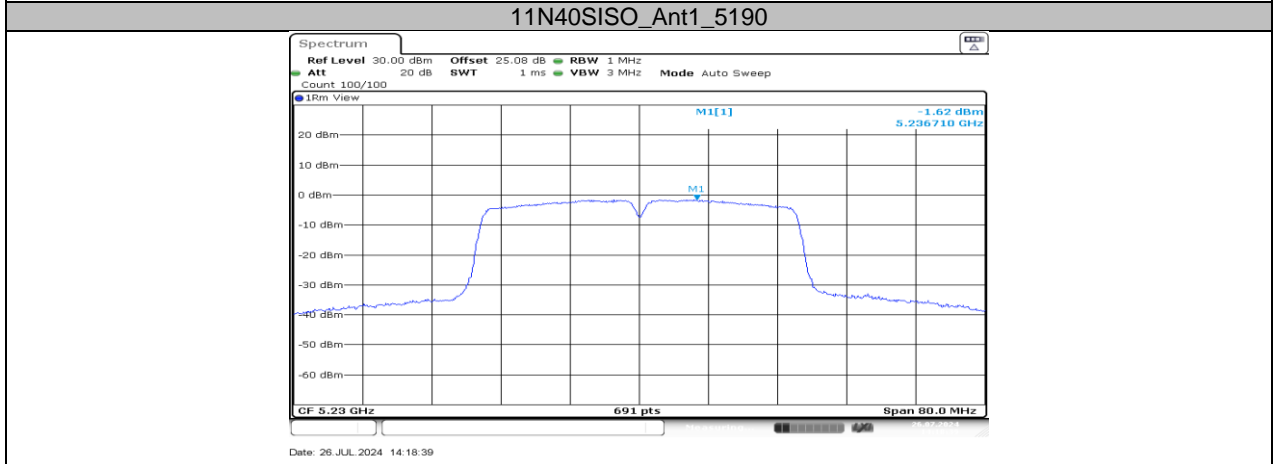
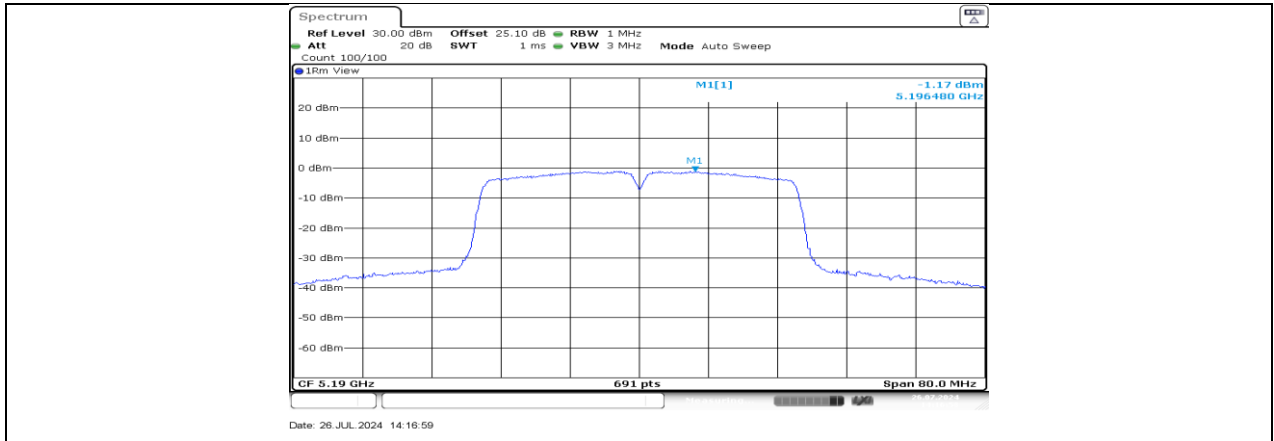

11.5. APPENDIX F: FREQUENCY STABILITY

11.5.1. Test Result

Frequency Error vs. Voltage									
802.11a:5200MHz									
Temp.	Volt.	0 Minute		2 Minute		5 Minute		10 Minute	
		Freq.Error (MHz)	Tolerance (ppm)	Freq.Error (MHz)	Tolerance (ppm)	Freq.Error (MHz)	Tolerance (ppm)	Freq.Error (MHz)	Tolerance (ppm)
TN	VL	5199.9994	-0.12	5199.9989	-0.21	5199.9770	-4.42	5199.9900	-1.92
TN	VN	5199.9900	-1.92	5200.0052	1.00	5200.0184	3.55	5200.0054	1.05
TN	VH	5199.9846	-2.97	5200.0146	2.80	5199.9921	-1.52	5199.9811	-3.64

Frequency Error vs. Temperature									
802.11a:5200MHz									
Temp.	Volt.	0 Minute		2 Minute		5 Minute		10 Minute	
		Freq.Error (MHz)	Tolerance (ppm)	Freq.Error (MHz)	Tolerance (ppm)	Freq.Error (MHz)	Tolerance (ppm)	Freq.Error (MHz)	Tolerance (ppm)
35	VN	5200.0153	2.94	5200.0044	0.85	5200.0138	2.64	5199.9988	-0.23
30	VN	5199.9959	-0.80	5199.9916	-1.62	5199.9937	-1.20	5200.0132	2.55
20	VN	5199.9772	-4.38	5199.9982	-0.34	5200.0050	0.96	5199.9839	-3.10
10	VN	5200.0147	2.83	5200.0163	3.14	5199.9977	-0.43	5199.9959	-0.80
0	VN	5200.0074	1.42	5200.0213	4.10	5199.9999	-0.02	5200.0041	0.79

Note:

1. All antennas, test modes and test channels have been tested, only the worst data record in the report.
2. For the detail Test Conditions, please refer to section 7.5 TEST ENVIRONMENT.

11.6. APPENDIX G: DUTY CYCLE

11.6.1. Test Result

Test Mode	On Time (msec)	Period (msec)	Duty Cycle x (Linear)	Duty Cycle (%)	Duty Cycle Correction Factor (dB)	1/T Minimum VBW (kHz)	Final setting For VBW (kHz)
11A	1.37	1.41	0.9716	97.16	0.12	0.73	1
11N20SISO	1.29	1.32	0.9773	97.73	0.10	0.78	1
11N40SISO	0.64	0.68	0.9412	94.12	0.26	1.56	2

Note:

Duty Cycle Correction Factor=10log (1/x).

Where: x is Duty Cycle (Linear)

Where: T is On Time

If that calculated VBW is not available on the analyzer then the next higher value should be used.

11.6.2. Test Graphs

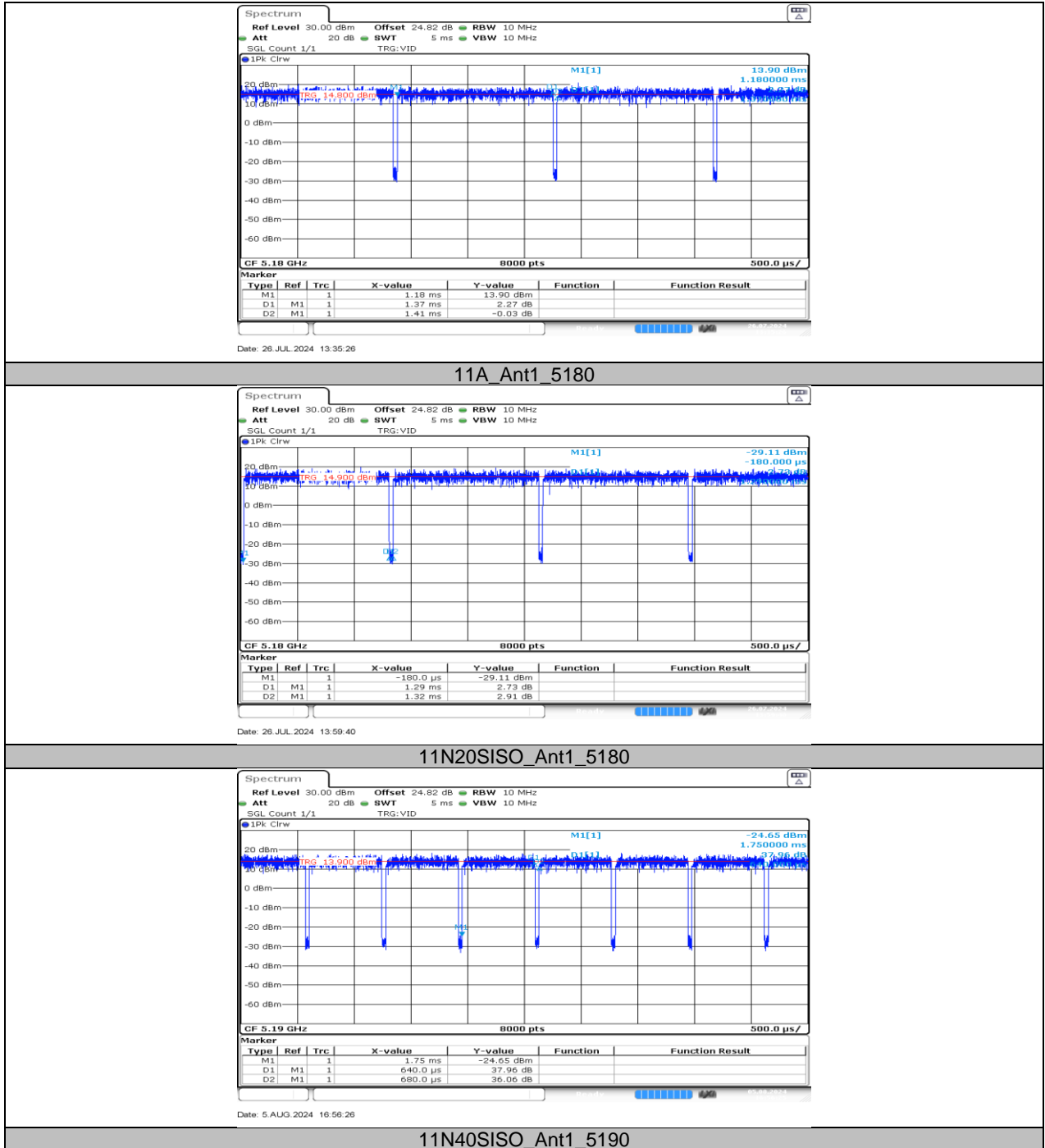

APPENDIX: PHOTOGRAPHS OF TEST CONFIGURATION

Referred to 4791394016-1_Appendix_SetupPhoto

APPENDIX: PHOTOGRAPHS OF THE EUT

Referred to 4791394016-1_Appendix_EUTPhoto_External

Referred to 4791394016-1_Appendix_EUTPhoto_Internal