

Test Report

Product: WIFI Camera

Trade Mark: N/A

Model Number: A3

FCC ID: 2BKBX-A3

Prepared for

Shenzhen Weilin Huachuang Technology Co.,Ltd
4 / F, Building D, Youth Pioneer Park, Jianshe East Road, Qinghua
Community, Longhua District, Shenzhen

Prepared by

Shenzhen HongBiao Certification& Testing Co., Ltd
Room 102, 201, Building 2, Yuanwanggu RFID Industrial Park, Tongguan
Road, Tianliao Community, Yutang Street, Guangming District, Shenzhen,
China
Tel.: +86-755-2998 9321 Fax.: +86-755-2998 5110
Website: <http://www.sz-hongbiao.com>

Table of Contents

1	GENERAL DESCRIPTION	6
1.1	DESCRIPTION OF EUT	6
1.2	TEST MODE.....	7
1.3	OPERATION CHANNEL LIST.....	7
1.4	TEST SETUP	8
1.5	ANCILLARY EQUIPMENT	8
2	SUMMARY OF TEST RESULT	8
3	TEST FACILITIES AND ACCREDITATIONS	10
3.1	TEST LABORATORY	10
3.2	ENVIRONMENTAL CONDITIONS	10
3.3	MEASUREMENT UNCERTAINTY	10
3.4	TEST SOFTWARE	11
4	LIST OF TEST EQUIPMENT	11
5	TEST ITEM AND RESULTS.....	14
5.1	ANTENNA REQUIREMENT	14
5.1.1	<i>Standard Requirement</i>	14
5.1.2	<i>Test Result</i>	14
5.2	CONDUCTED EMISSION.....	15
5.2.1	<i>Limits</i>	15
5.2.2	<i>Test Procedures</i>	15
5.2.3	<i>Test Setup</i>	16
5.2.4	<i>Test Result</i>	16
5.3	RADIATED EMISSION	19
5.3.1	<i>Limits</i>	19
5.3.2	<i>Test Procedures</i>	19
5.3.3	<i>Test Setup</i>	19
5.3.4	<i>Test Result</i>	20
5.3.5	<i>Radiated Band Edge</i>	25
5.4	PEAK OUTPUT POWER	27
5.4.1	<i>Limit</i>	27
5.4.2	<i>Test Procedure</i>	27
5.4.3	<i>Test Setup</i>	27
5.4.4	<i>Test Results</i>	27
5.5	POWER SPECTRAL DENSITY.....	29
5.5.1	<i>Limit</i>	29
5.5.2	<i>Test Procedure</i>	29
5.5.3	<i>Test Setup</i>	29
5.5.4	<i>Test Results</i>	29
5.6	6dB BANDWIDTH.....	34
5.6.1	<i>Limit</i>	34
5.6.2	<i>Test Procedure</i>	34
5.6.3	<i>Test Setup</i>	34
5.6.4	<i>Test Results</i>	34
5.7	DUTY CYCLE	39
5.7.1	<i>Limit</i>	39
5.7.2	<i>Test Procedure</i>	39
5.7.3	<i>Test Setup</i>	39

5.7.4	Test Results	40
5.8	CONDUCTED BAND EDGE	41
5.8.1	Limit	41
5.8.2	Test Procedure	41
5.8.3	Test Setup	41
5.8.4	Test Results	41
5.9	SPURIOUS RF CONDUCTED EMISSIONS	45
5.9.1	Limit	45
5.9.2	Measuring Instruments	45
5.9.3	Test Procedure	45
5.9.4	Test Setup	45
5.9.5	Test Results	45
6	PHOTOGRAPHS OF THE TEST SETUP.....	47
7	PHOTOGRAPHS OF THE EUT.....	49

1 General Description

1.1 Description of EUT

Product name:	WIFI Camera
Model name:	A3
Series Model:	N/A
Different of series model:	N/A
Operation frequency:	IEEE 802.11b/g/n20: 2412~2462 MHz IEEE 802.11n40: 2422~2452 MHz
Modulation type::	IEEE for 802.11b:DSSS(CCK,DQPSK,DBPSK) IEEE for 802.11g:OFDM(64QAM, 16QAM, QPSK, BPSK) IEEE for 802.11n(HT20 and HT40): OFDM (64QAM, 16QAM,QPSK,BPSK)
Bit Rate of transmitter:	802.11b: 1M/2M/5.5M/11M bps 802.11g: 6M/9M/12M/18M/24M/36M/48M/54M bps 802.11n(HT20): 6.5M/13M/19.5M/26M/39M/52M/58.5M/ 64M bps 802.11n(HT40):13.5M/27M/40.5M/54M/81M/108M/121.5M/ 135M bps
Antenna type:	Chip antenna
Antenna gain:	1.24dBi
Max. output power:	15.53dBm
Hardware version:	V1.0
Software version:	V1.0
Battery:	N/A
Power supply:	DC 5V from adapter AC 120V/60Hz
Adapter information:	N/A

1.2 Test Mode

Channel List for 802.11b/g/n(20)

Channel	Channel	Frequency (MHz)
Low	01	2412
Middle	06	2437
High	11	2462

Channel List for 802.11n(40)

Channel	Channel	Frequency (MHz)
Low	03	2422
Middle	06	2437
High	09	2452

Note: 802.11ax mode only support full resource unit size.

1.3 Operation Channel list

Channel List for 802.11b/g/n(20)

Channel	Frequency (MHz)	Channel	Frequency (MHz)
01	2412	07	2442
02	2417	08	2447
03	2422	09	2452
04	2427	10	2457
05	2432	11	2462
06	2437	\	\

Channel List for 802.11n(40)

Channel	Frequency (MHz)	Channel	Frequency (MHz)
03	2422	07	2442
04	2427	08	2447
05	2432	09	2452

06	2437	\	\
----	------	---	---

1.4 Test Setup

See photographs of the test setup in the report for the actual setup and connections between EUT and support equipment.

1.5 Ancillary Equipment

Equipment	Model	S/N	Manufacturer
Laptop	NbDE-WFH9	/	HUAWEI

Note: The laptop is used to assist the RF test. In order to prevent the laptop from causing unnecessary impact on the test, the laptop will be removed from the test environment after the EUT successfully transmits at a fixed frequency using the laptop.

2 Summary of Test Result

No.	Standard Section	Test Item	Result	Remark
1	15.203	Antenna Requirement	Pass	
2	15.247 (b)	Peak Output Power	Pass	
3	15.207	Conducted Emission	Pass	
4	15.247 (d) & 15.209	Radiated Spurious Emission	Pass	
5	15.247 (e)	Power Spectral Density	Pass	
6	15.247 (a)(2)	6dB Bandwidth	Pass	
7	558074 D01 15.247 Meas Guidance v05r02 Chapter 6	Duty Cycle	Pass	
8	15.205	Band Edge Emission	Pass	
9	15.247(d)	Spurious RF Conducted Emissions	Pass	

3 Test Facilities and Accreditations

3.1 Test Laboratory

Test Site	Shenzhen HongBiao Certification& Testing Co., Ltd
Test Site Location	Room 102, 201, Building 2, Yuanwanggu RFID Industrial Park, Tongguan Road, Tianliao Community, Yutang Street, Guangming District, Shenzhen, China
Telephone:	(86-755) 2998 9321
Fax:	(86-755) 2998 5110
FCC Registration No.:	CN1341
A2LA Certificate No.:	6765.01

3.2 Environmental Conditions

During the measurement the environmental conditions were within the listed ranges:

Temperature:	15°C~35°C
Relative Humidity:	20%~75%
Air Pressure:	98kPa~101kPa

3.3 Measurement Uncertainty

The reported uncertainty of measurement $y \pm U$, where expanded uncertainty U is based on a standard uncertainty multiplied by a coverage factor of $k=2$, providing a level of confidence of approximately 95 %.

The data and results quoted in this document are true and accurate values, and uncertainties are not involved in the calculations.

In addition, components and mass production processes that are similar to testing equipment may introduce additional deviations, and the manufacturer is solely responsible for the continued compliance of the equipment

Measurement Frequency Range	U, (dB)	Note
RF frequency	2×10^{-5}	
RF power, conducted	± 0.57 dB	
Conducted emission(150kHz~30MHz)	± 2.5 dB	
Radiated emission(9kHz-30MHz)	± 2.5 dB	
Radiated emission(30MHz~1GHz)	± 4.2 dB	
Radiated emission (above 1GHz)	± 4.7 dB	
Occupied Bandwidth	$\pm 3\%$	
Temperature	± 1 degree	
Humidity	$\pm 5 \%$	

3.4 Test Software

Software name	Manufacturer	Model	Version
Conducted Emission test Software	Farad	EZ-EMC	EMC-CON 3A1.1+
Radiated Emission test Software	Farad	EZ-EMC	FA-03A2
RF Test System	MWRF	MTS 8310	2.0.0.0

4 List of Test Equipment

Radiation emission							
Item	Equipment No.	Equipment name	Manufacturer	Model	Serial No.	Calibration date	Due date
1	HB-E001	Horn Antenna	Schwarzbeck	BBHA 9120D	02592	2024-05-18	2026-05-17
2	HB-E002	Biconical log-periodic composite antenna	Schwarzbeck	VULB 9168	01340	2024-05-18	2026-05-17
3	HB-E003	SHF-EHF Horn	Schwarzbeck	BBHA 91270	01193	2024-05-18	2026-05-17
4	HB-E005	Preamplifier	Noyetec	LAN-01 18	NYCM1420 102	2024-05-17	2025-05-16
5	HB-E006	Preamplifier	Noyetec	LAN-18 40	NYCM1420 103	2024-05-17	2025-05-16
6	HB-E007	EMI TEST RECEIVER	R&S	ESR7	102520	2024-05-17	2025-05-16
7	HB-E009	POSITINAL COTROLLE R	Noyetec	N/A	N/A	/	/
8	HB-E013	RF switch	Noyetec	NY-RF4	NY0CM142 0204	/	/
9	HB-E066	Illuminance Tester	TASI	TA8121	N/A	2024-05-21	2025-05-20
10	HB-E075	Active loop antenna	Schwarzbeck	FMZB 1519B	1519B-245	2024-05-18	2026-05-17
11	HB-E076	Preamplifier	Hewlett Packard	8447D	1937A0227 8	2024-05-17	2025-05-16
Conduction emission							
Item	Equipment No.	Equipment name	Manufacturer	Model	Serial No.	Calibration date	Due date
1	HB-E014	4 Path V-LISN	Schwarzbeck	NNLK 8121	00770	2024-05-17	2025-05-16
2	HB-E015	Pulse Limiter	Schwarzbeck	VTSD 9561-F	00949	2024-05-17	2025-05-16
3	HB-E016	ZN23201	Noyetec	ZN23201	N/A	2024-05-21	2025-05-20
4	HB-E059	Attenuator	Xianghua	TS2-6-1	220215166	2024-05-17	2025-05-16
5	HB-E069	EMI TEST RECEIVER	R&S	ESCI	N/A	2024-05-17	2025-05-16

RF							
Item	Equipment No.	Equipment name	Manufacturer	Model	Serial No.	Calibration date	Due date
1	HB-E041	MXG Anaio Signal Generator	Agilent	N5181A	MY47070421	2024-05-17	2025-05-16
2	HB-E042	WIDEBAND RADIO COMMUNICA TION TESTER	R&S	CMW500	132108	2024-05-17	2025-05-16
3	HB-E043	MXG Anaio Signal Generator	Agilent	N5182A	US46240335	2024-05-17	2025-05-16
4	HB-E044	Signal & spectrum Analyzer	R&S	FSV3044	101264	2024-05-17	2025-05-16
5	HB-E045	RF Control Box	Noyetec	NY100-R FCB	N/A	2023-08-22 2024-08-19	2024-08-21 2025-08-18
6	HB-E058	Thermometer Clock Humidity Monitor	N/A	HTC-1	N/A	/	/

Note: the calibration interval of the above test instruments is 12&24 months and the calibrations are traceable to international system unit (SI).

5 Test Item And Results

5.1 Antenna Requirement

5.1.1 Standard Requirement

15.203 requirement: For intentional device, according to 15.203: an intentional radiator shall be designed to ensure that no antenna other than that furnished by the responsible party shall be used with the device

5.1.2 Test Result

The EUT antenna is Chip Antenna. It comply with the standard requirement. In case of replacement of broken antenna the same antenna type must be used.

5.2 Conducted Emission

5.2.1 Limits

Limits – Class B		
Frequency (MHz)	Limit (dBµV)	
	Quasi-Peak	Average
0.15 to 0.5	66 to 56*	56 to 46*
0.5 to 5	56	46
5 to 30	60	50

Note:

- the tighter limit applies at the band edges.
- the limit of " * " marked band means the limitation decreases linearly with the logarithm of the frequency in the range.

5.2.2 Test Procedures

a) EUT Operating Conditions

The EUT was configured for testing in a typical fashion (as a customer would normally use it). The EUT has been programmed to continuously transmit during test. This operating condition was tested and used to collect the included data.

b) The following table is the setting of the receiver

Receiver Parameters	Setting
Attenuation	10 dB
Start Frequency	0.15 MHz
Stop Frequency	30 MHz
IF Bandwidth	9 kHz

- The EUT was placed 0.8 meters from the horizontal ground plane with EUT being connected to the power mains through a line impedance stabilization network (LISN). All other support equipment powered from additional LISN(s). The LISN provide 50 Ohm/ 50uH of coupling impedance for the measuring instrument.
- Interconnecting cables that hang closer than 40 cm to the ground plane shall be folded back and forth in the center forming a bundle 30 to 40 cm long.
- I/O cables that are not connected to a peripheral shall be bundled in the center. The end of the cable may be terminated, if required, using the correct terminating impedance. The overall length shall not exceed 1 m.
- LISN is at least 80 cm from nearest part of EUT chassis.

- g) For the actual test configuration, please refer to the related Item – photographs of the test setup.

5.2.3 Test Setup

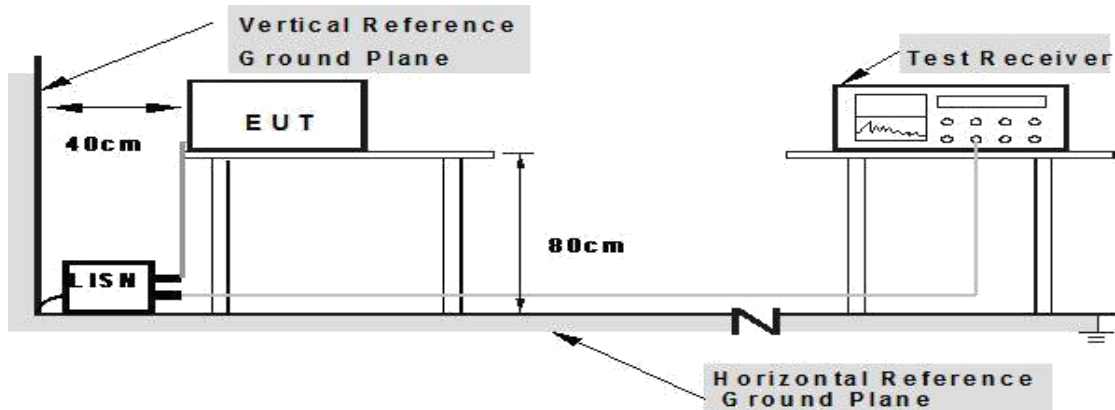

5.2.4 Test Result

EUT:	WIFI Camera	Model Name:	A3
Test Mode:	TX	Phase:	L
Test Voltage:	DC 5V from adapter AC 120V/60Hz		

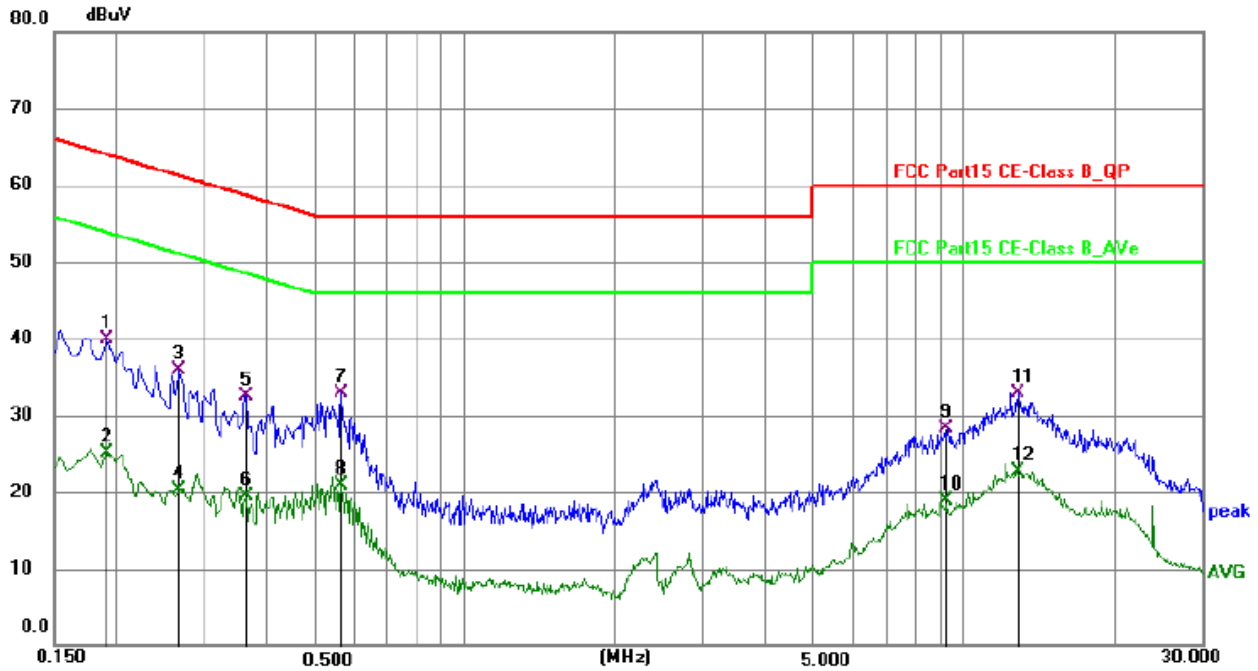

No.	Frequency (MHz)	Reading (dBuV)	Factor (dB)	Level (dBuV)	Limit (dBuV)	Margin (dB)	Detector
1	0.190500	29.41	10.47	39.88	64.01	-24.13	QP
2	0.190500	14.69	10.47	25.16	54.01	-28.85	AVG
3	0.267000	25.37	10.47	35.84	61.21	-25.37	QP
4	0.267000	9.93	10.47	20.40	51.21	-30.81	AVG
5	0.361400	21.93	10.48	32.41	58.70	-26.29	QP
6	0.361400	9.04	10.48	19.52	48.70	-29.18	AVG
7 *	0.563900	22.44	10.51	32.95	56.00	-23.05	QP
8	0.563900	10.31	10.51	20.82	46.00	-25.18	AVG
9	9.253400	17.71	10.57	28.28	60.00	-31.72	QP
10	9.253400	8.39	10.57	18.96	50.00	-31.04	AVG
11	12.808500	21.68	11.15	32.83	60.00	-27.17	QP
12	12.808500	11.65	11.15	22.80	50.00	-27.20	AVG

EUT:	WIFI Camera	Model Name:	A3
Test Mode:	TX	Phase:	N
Test Voltage:	DC 5V from adapter AC 120V/60Hz		

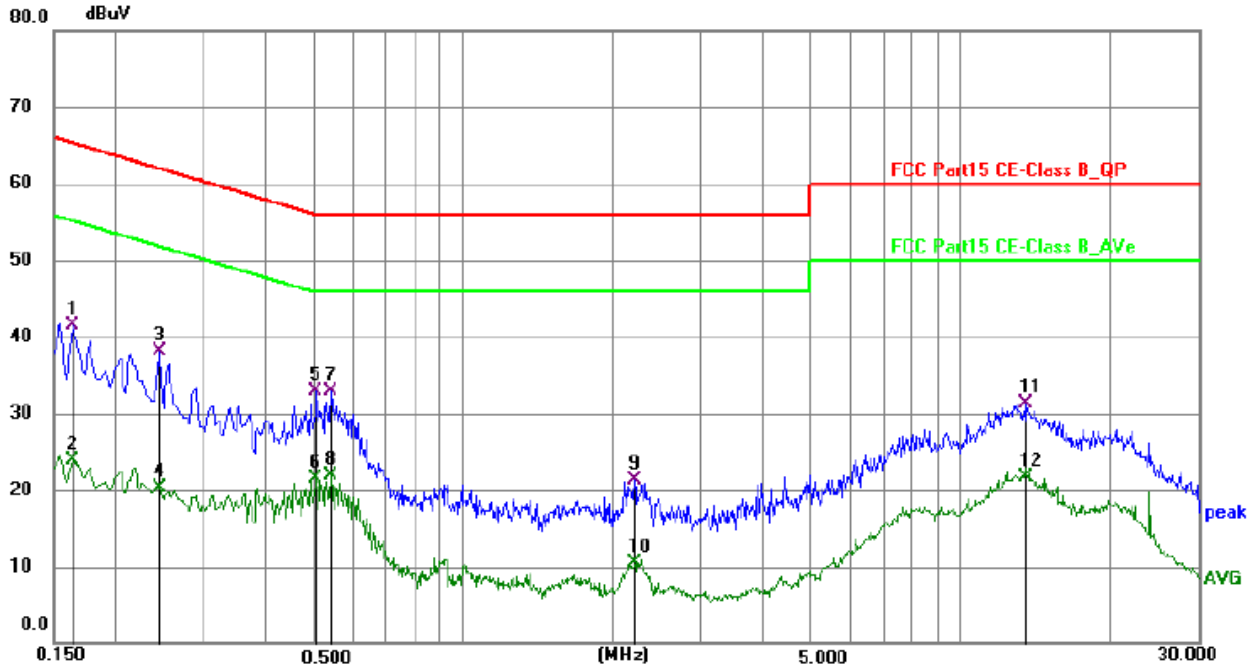

No.	Frequency (MHz)	Reading (dBuV)	Factor (dB)	Level (dBuV)	Limit (dBuV)	Margin (dB)	Detector
1	0.163500	31.11	10.48	41.59	65.28	-23.69	QP
2	0.163500	13.44	10.48	23.92	55.28	-31.36	AVG
3	0.244500	27.60	10.52	38.12	61.94	-23.82	QP
4	0.244500	9.83	10.52	20.35	51.94	-31.59	AVG
5 *	0.505500	22.43	10.40	32.83	56.00	-23.17	QP
6	0.505500	11.04	10.40	21.44	46.00	-24.56	AVG
7	0.541500	22.42	10.40	32.82	56.00	-23.18	QP
8	0.541500	11.45	10.40	21.85	46.00	-24.15	AVG
9	2.211000	10.88	10.37	21.25	56.00	-34.75	QP
10	2.211000	0.16	10.37	10.53	46.00	-35.47	AVG
11	13.524000	20.05	11.28	31.33	60.00	-28.67	QP
12	13.524000	10.44	11.28	21.72	50.00	-28.28	AVG

5.3 Radiated Emission

5.3.1 Limits

Frequencies (MHz)	Field Strength (micровolts/meter)	Measurement Distance (meters)
0.009~0.490	2400/F(KHz)	300
0.490~1.705	24000/F(KHz)	30
1.705~30.0	30	30
30~88	100	3
88~216	150	3
216~960	200	3
Above 960	500	3

Receiver Parameter	Setting
Attenuation	Auto
Start ~ Stop Frequency	9kHz~150kHz / RB 200Hz for QP
Start ~ Stop Frequency	150kHz~30MHz / RB 9kHz for QP
Start ~ Stop Frequency	30MHz~1000MHz / RB 120kHz for QP

5.3.2 Test Procedures

- a) The radiated emission tests were performed in the 3 meters.
- b) The EUT was placed on the top of a rotating table 0.8 meters above the ground. The table was rotated 360 degrees to determine the position of the highest radiation.
- c) The height of the test antenna shall vary between 1m to 4m. Both horizontal and vertical polarizations of the antenna are set to make the measurement.
- d) If the peak mode measured value compliance with and lower than quasi peak mode limit, the EUT shall be deemed to meet QP limits and then no additional QP mode measurement performed.
- e) If the peak mode measured value compliance with and lower than average mode limit, the EUT shall be deemed to meet average limits and then no additional average mode measurement performed.
- f) For the actual test configuration, please refer to the related item – EUT test photos.

5.3.3 Test Setup

Radiated Emission Test-Up Frequency Below 30MHz

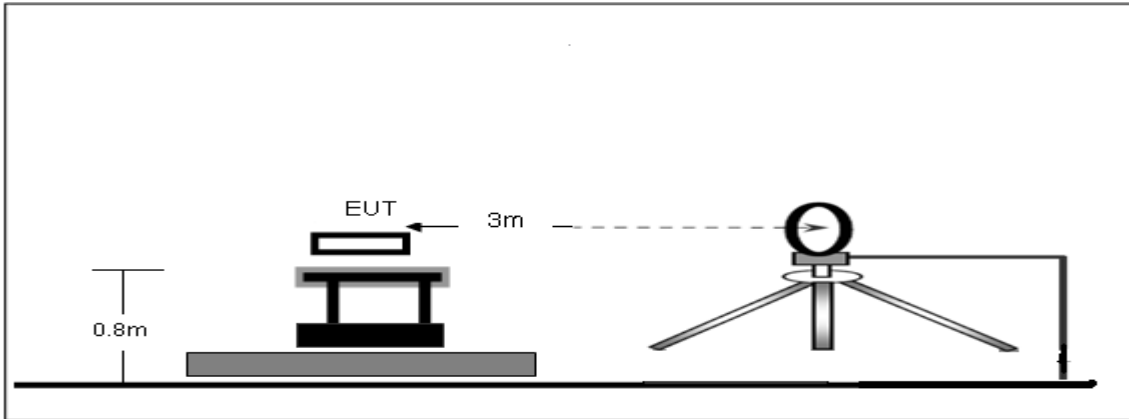

Radiated Emission Test-Up Frequency 30MHz~1GHz

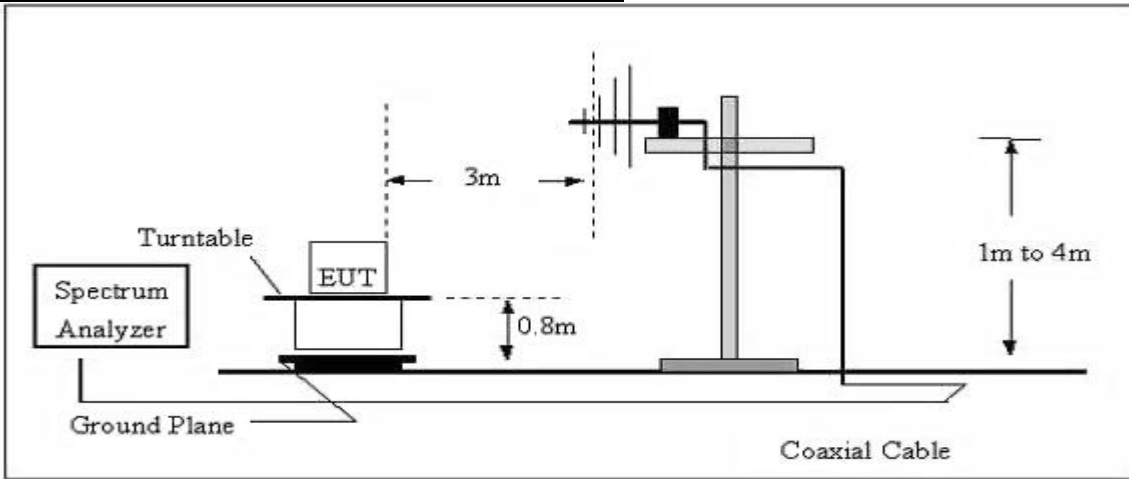

Radiated emission test-up frequency above 1GHz

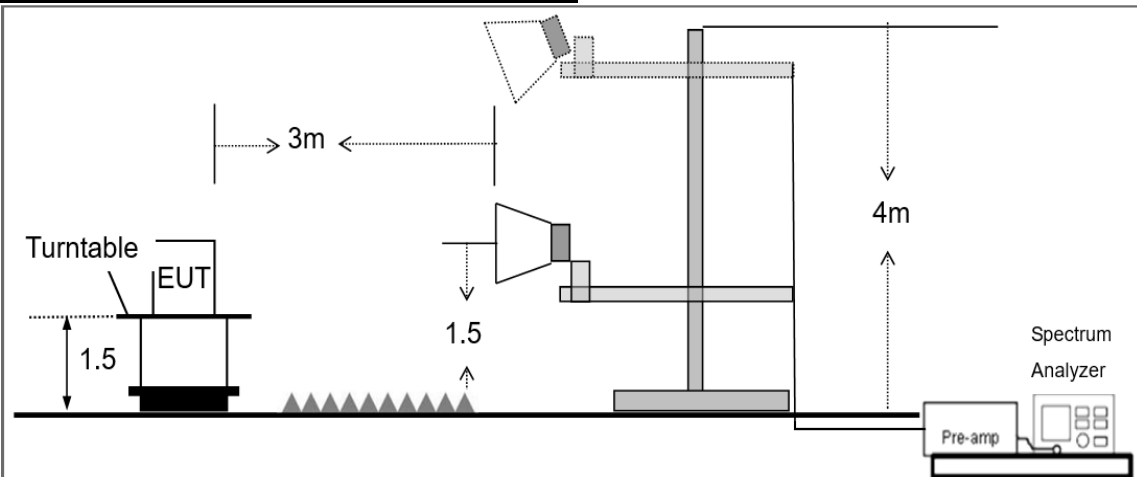

5.3.4 Test Result

Below 30MHz

EUT:	WIFI Camera	Model Name:	A3
Pressure:	1010 hPa	Test Voltage:	DC 5V from adapter AC 120V/60Hz
Test Mode:	TX	Polarization:	--

Freq.	Reading	Limit	Margin	State
(MHz)	(dBuV/m)	(dBuV/m)	(dB)	P/F
--	--	--	--	Pass
--	--	--	--	Pass

Note:

1. For 9kHz-30MHz, the amplitude of spurious emissions which are attenuated by more than 20dB below the permissible value has no need to be reported.
2. Distance extrapolation factor = $40 \log (\text{specific distance}/\text{test distance})$ (dB);
3. Limit line = specific limits (dBuV) + distance extrapolation factor.

Frequency range (30MHz – 1GHz)

EUT:	WIFI Camera	Model Name:	A3
Test Mode:	TX	Phase:	Vertical
Test Voltage:	DC 5V from adapter AC 120V/60Hz		

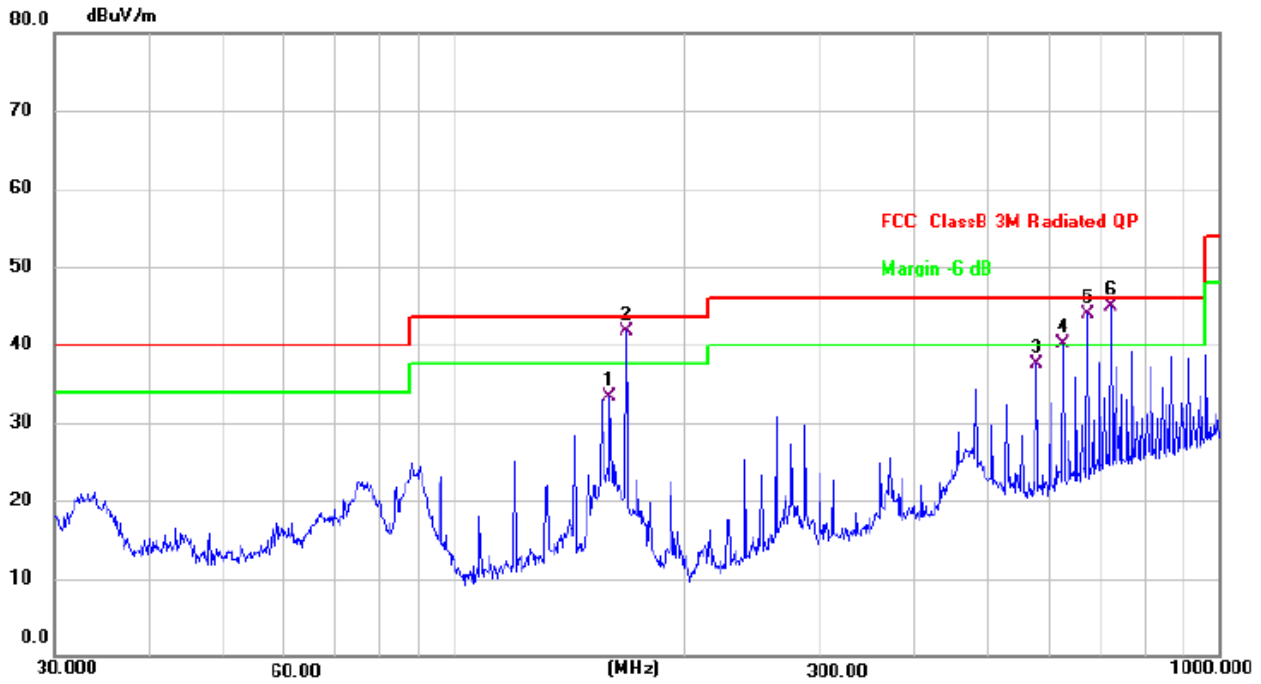

No.	Frequency (MHz)	Reading (dBuV)	Factor (dB/m)	Level (dBuV/m)	Limit (dBuV/m)	Margin (dB)	Detector
1	159.7844	46.76	-13.37	33.39	43.50	-10.11	QP
2 !	167.8242	55.26	-13.50	41.76	43.50	-1.74	QP
3	576.6443	43.14	-5.67	37.47	46.00	-8.53	QP
4 !	625.0780	44.15	-4.02	40.13	46.00	-5.87	QP
5 !	672.8444	46.81	-2.81	44.00	46.00	-2.00	QP
6 *	721.7258	46.76	-1.87	44.89	46.00	-1.11	QP

EUT:	WIFI Camera	Model Name:	A3
Test Mode:	TX	Phase:	Horizontal
Test Voltage:	DC 5V from adapter AC 120V/60Hz		

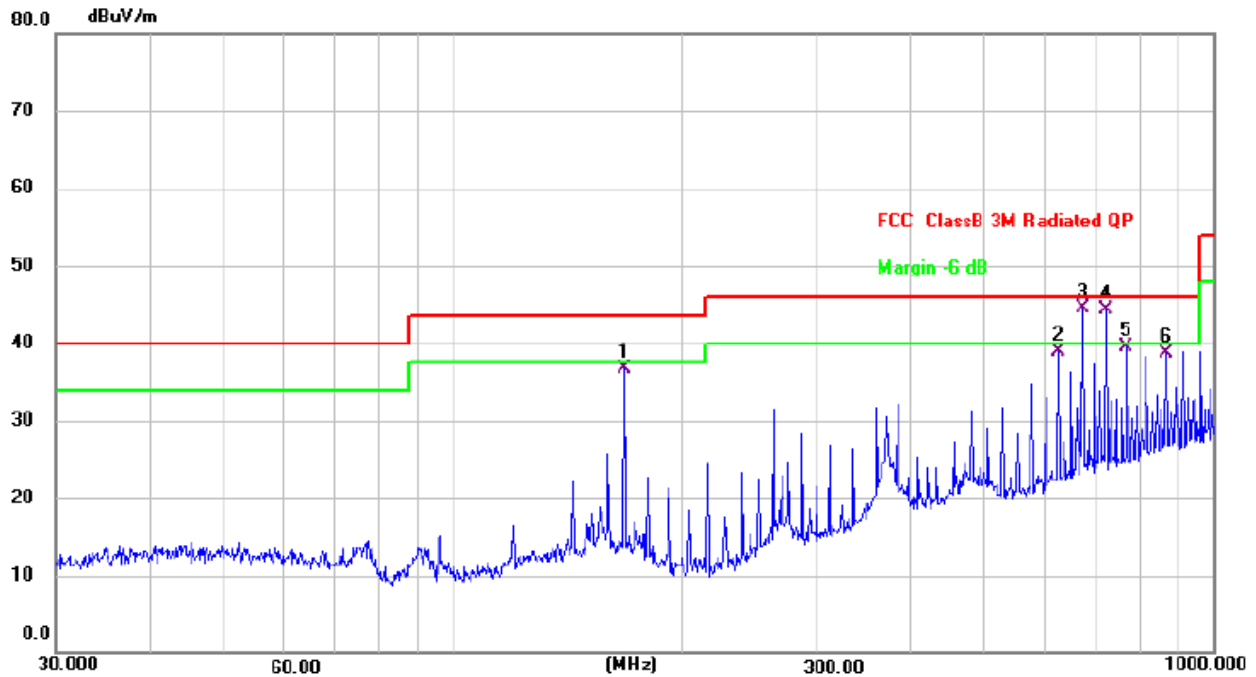

No.	Frequency (MHz)	Reading (dBuV)	Factor (dB/m)	Level (dBuV/m)	Limit (dBuV/m)	Margin (dB)	Detector
1	167.8242	50.19	-13.50	36.69	43.50	-6.81	QP
2	625.0780	42.85	-4.02	38.83	46.00	-7.17	QP
3 *	672.8444	47.40	-2.81	44.59	46.00	-1.41	QP
4 !	721.7258	46.09	-1.87	44.22	46.00	-1.78	QP
5	768.7481	40.34	-0.89	39.45	46.00	-6.55	QP
6	866.0879	38.47	0.33	38.80	46.00	-7.20	QP

Frequency range (1GHz-25GHz)

Frequency (MHz)	Read Level (dB μ V)	Cable loss (dB)	Antenna Factor dB/m	Preamp Factor (dB)	Emission Level (dB μ V/m)	Limits (dB μ V/m)	Margin (dB)	Remark	Comment
Low Channel (2412 MHz)(802.11b)--Above 1G									
4824.161	63.26	4.36	32.92	45.53	55.01	74.00	-18.99	Pk	Vertical
4824.161	43.60	4.36	32.92	45.53	35.35	54.00	-18.65	AV	Vertical
7236.396	59.92	5.02	37.63	45.56	57.01	74.00	-16.99	Pk	Vertical
7236.396	41.22	5.02	37.63	45.56	38.31	54.00	-15.69	AV	Vertical
4824.154	63.16	4.36	32.92	45.53	54.91	74.00	-19.09	Pk	Horizontal
4824.154	42.77	4.36	32.92	45.53	34.52	54.00	-19.48	AV	Horizontal
7236.168	63.47	5.02	37.63	45.56	60.56	74.00	-13.44	Pk	Horizontal
7236.168	42.50	5.02	37.63	45.56	39.59	54.00	-14.41	AV	Horizontal
Middle Channel (2437 MHz)(802.11b)--Above 1G									
4874.112	63.00	4.41	33.01	45.76	54.66	74.00	-19.34	Pk	Vertical
4874.112	43.70	4.41	33.01	45.76	35.36	54.00	-18.64	AV	Vertical
7311.247	60.47	5.02	37.68	45.59	57.58	74.00	-16.42	Pk	Vertical
7311.247	40.75	5.02	37.68	45.59	37.86	54.00	-16.14	AV	Vertical
4874.132	62.95	4.41	33.01	45.76	54.61	74.00	-19.39	Pk	Horizontal
4874.132	44.43	4.41	33.01	45.76	36.09	54.00	-17.91	AV	Horizontal
7311.085	61.31	5.02	37.68	45.59	58.42	74.00	-15.58	Pk	Horizontal
7311.085	42.32	5.02	37.68	45.59	39.43	54.00	-14.57	AV	Horizontal
High Channel (2462 MHz)(802.11b)--Above 1G									
4924.169	63.84	4.50	33.26	46.07	55.53	74.00	-18.47	Pk	Vertical
4924.169	43.68	4.50	33.26	46.07	35.37	54.00	-18.63	AV	Vertical
7386.215	60.55	5.02	37.78	45.77	57.58	74.00	-16.42	Pk	Vertical
7386.215	40.90	5.02	37.78	45.77	37.93	54.00	-16.07	AV	Vertical
4924.045	63.59	4.50	33.26	46.07	55.28	74.00	-18.72	Pk	Horizontal
4924.045	44.61	4.50	33.26	46.07	36.30	54.00	-17.70	AV	Horizontal
7386.132	61.30	5.02	37.78	45.77	58.33	74.00	-15.67	Pk	Horizontal
7386.132	42.40	5.02	37.78	45.77	39.43	54.00	-14.57	AV	Horizontal

Note:

1. Emission Level= Antenna Factor + Cable Loss + Read Level - Preamp Factor
2. All other emissions more than 20dB below the limit.
3. The three modulated high, medium and low channels have been tested. The report only shows the worst mode. The worst mode is 802.11b.

5.3.5 Radiated Band Edge

Frequency	Read Level	Cable loss	Antenna Factor	Preamp Factor	Emission Level	Limits	Margin	Remark	Comment
(MHz)	(dB μ V)	(dB)	dB/m	(dB)	(dB μ V/m)	(dB μ V/m)	(dB)		

802.11b (Channel 01&11)									
2310.00	58.69	2.40	27.70	40.40	48.39	74	-25.61	Pk	Horizontal
2310.00	43.04	2.40	27.70	40.40	32.74	54	-21.26	AV	Horizontal
2310.00	58.49	2.40	27.70	40.40	48.19	74	-25.81	Pk	Vertical
2310.00	41.67	2.40	27.70	40.40	31.37	54	-22.63	AV	Vertical
2390.00	57.43	2.44	28.30	40.10	48.07	74	-25.93	Pk	Vertical
2390.00	42.35	2.44	28.30	40.10	32.99	54	-21.01	AV	Vertical
2390.00	56.30	2.44	28.30	40.10	46.94	74	-27.06	Pk	Horizontal
2390.00	41.69	2.44	28.30	40.10	32.33	54	-21.67	AV	Horizontal
2483.50	57.54	2.48	28.70	39.80	48.92	74	-25.08	Pk	Vertical
2483.50	42.91	2.48	28.70	39.80	34.29	54	-19.71	AV	Vertical
2483.50	59.01	2.48	28.70	39.80	50.39	74	-23.61	Pk	Horizontal
2483.50	41.64	2.48	28.70	39.80	33.02	54	-20.98	AV	Horizontal
802.11g(Channel 01&11)									
2310.00	58.48	2.40	27.70	40.40	48.18	74	-25.82	Pk	Horizontal
2310.00	43.87	2.40	27.70	40.40	33.57	54	-20.43	AV	Horizontal
2310.00	57.35	2.40	27.70	40.40	47.05	74	-26.95	Pk	Vertical
2310.00	43.25	2.40	27.70	40.40	32.95	54	-21.05	AV	Vertical
2390.00	58.18	2.44	28.30	40.10	48.82	74	-25.18	Pk	Vertical
2390.00	41.91	2.44	28.30	40.10	32.55	54	-21.45	AV	Vertical
2390.00	58.00	2.44	28.30	40.10	48.64	74	-25.36	Pk	Horizontal
2390.00	43.70	2.44	28.30	40.10	34.34	54	-19.66	AV	Horizontal
2483.50	59.07	2.48	28.70	39.80	50.45	74	-23.55	Pk	Vertical
2483.50	43.89	2.48	28.70	39.80	35.27	54	-18.73	AV	Vertical
2483.50	59.25	2.48	28.70	39.80	50.63	74	-23.37	Pk	Horizontal
2483.50	42.31	2.48	28.70	39.80	33.69	54	-20.31	AV	Horizontal

802.11n20(Channel 01&11)									
2310.00	58.22	2.40	27.70	40.40	47.92	74	-26.08	Pk	Horizontal
2310.00	43.93	2.40	27.70	40.40	33.63	54	-20.37	AV	Horizontal
2310.00	59.11	2.40	27.70	40.40	48.81	74	-25.19	Pk	Vertical
2310.00	42.32	2.40	27.70	40.40	32.02	54	-21.98	AV	Vertical
2390.00	57.78	2.44	28.30	40.10	48.42	74	-25.58	Pk	Vertical
2390.00	42.48	2.44	28.30	40.10	33.12	54	-20.88	AV	Vertical
2390.00	56.23	2.44	28.30	40.10	46.87	74	-27.13	Pk	Horizontal
2390.00	42.46	2.44	28.30	40.10	33.10	54	-20.90	AV	Horizontal
2483.50	58.11	2.48	28.70	39.80	49.49	74	-24.51	Pk	Vertical
2483.50	42.55	2.48	28.70	39.80	33.93	54	-20.07	AV	Vertical
2483.50	58.62	2.48	28.70	39.80	50.00	74	-24.00	Pk	Horizontal
2483.50	42.49	2.48	28.70	39.80	33.87	54	-20.13	AV	Horizontal
802.11n40(Channel 03&09)									
2310.00	58.98	2.40	27.70	40.40	48.68	74	-25.32	Pk	Horizontal
2310.00	44.92	2.40	27.70	40.40	34.62	54	-19.38	AV	Horizontal
2310.00	56.90	2.40	27.70	40.40	46.60	74	-27.40	Pk	Vertical
2310.00	43.85	2.40	27.70	40.40	33.55	54	-20.45	AV	Vertical
2390.00	58.40	2.44	28.30	40.10	49.04	74	-24.96	Pk	Vertical
2390.00	41.91	2.44	28.30	40.10	32.55	54	-21.45	AV	Vertical
2390.00	58.54	2.44	28.30	40.10	49.18	74	-24.82	Pk	Horizontal
2390.00	43.45	2.44	28.30	40.10	34.09	54	-19.91	AV	Horizontal
2483.50	58.66	2.48	28.70	39.80	50.04	74	-23.96	Pk	Vertical
2483.50	43.99	2.48	28.70	39.80	35.37	54	-18.63	AV	Vertical
2483.50	59.02	2.48	28.70	39.80	50.40	74	-23.60	Pk	Horizontal
2483.50	42.15	2.48	28.70	39.80	33.53	54	-20.47	AV	Horizontal

Note:

1. All Readings are Peak Value (VBW=3MHz) and AV Value (VBW=10Hz).
2. Emission Level= Antenna Factor + Cable Loss + Read Level - Preamp Factor.
3. All the modulation modes have been tested, and only the worst results are reflected in the report.

5.4 Peak Output Power

5.4.1 Limit

FCC Part15 Subpart C			
Section	Test Item	Limit	Frequency Range (MHz)
15.247(b)(3)	Peak output power	1 watt or 30dBm	2400-2483.5

5.4.2 Test Procedure

1. PKPM1 Peak power meter measurement

The maximum peak conducted output power may be measured using a broadband peak RF power meter. The power meter shall have a video bandwidth that is greater than or equal to the DTS bandwidth and shall use a fast-responding diode detector.

5.4.3 Test Setup

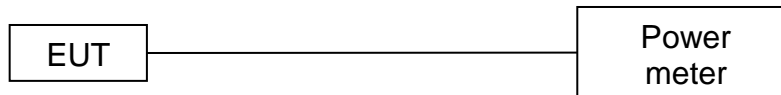

5.4.4 Test Results

EUT:	WIFI Camera	Model Name:	A3
Test Mode:	TX	Test Voltage:	DC 5V from adapter AC 120V/60Hz

802.11b

Test Channel	Frequency (MHz)	Maximum Peak Conducted Output Power(dBm)	Limit (dBm)
CH01	2412	15.53	30
CH06	2437	15	30
CH11	2462	14.31	30

802.11g

Test Channel	Frequency (MHz)	Maximum Peak Conducted Output Power(dBm)	Limit (dBm)
CH01	2412	13.9	30
CH06	2437	14.51	30
CH11	2462	14.33	30

802.11n20

Test Channel	Frequency (MHz)	Maximum Peak Conducted Output Power(dBm)	Limit (dBm)
CH01	2412	13.27	30
CH06	2437	13.92	30
CH11	2462	13.84	30

802.11n40

Test Channel	Frequency (MHz)	Maximum Peak Conducted Output Power(dBm)	Limit (dBm)
CH03	2422	13.41	30
CH06	2437	13.3	30
CH09	2452	13.14	30

5.5 Power Spectral Density

5.5.1 Limit

FCC Part15 (15.247) , Subpart C			
Section	Test Item	Limit	Frequency Range (MHz)
15.247	Power Spectral Density	8 dBm (in any 3kHz)	2400-2483.5

5.5.2 Test Procedure

1. Set analyzer center frequency to DTS channel center frequency.
2. Set the span to 1.5 times the DTS channel bandwidth.
3. Set the RBW \geq 3 kHz.
4. Set the VBW \geq 3 x RBW.
5. Detector = peak.
6. Sweep time = auto couple.
7. Trace mode = max hold.
8. Allow trace to fully stabilize.
9. Use the peak marker function to determine the maximum amplitude level.
10. If measured value exceeds limit, reduce RBW (no less than 3 kHz) and repeat.

5.5.3 Test Setup

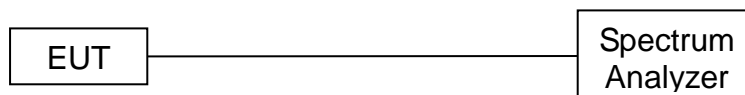

5.5.4 Test Results

802.11b			
Frequency	Power Density (dBm/3kHz)	Limit (dBm/3kHz)	Result
2412 MHz	-10.86	8	Pass
2437 MHz	-11.74	8	Pass
2462 MHz	-12.13	8	Pass

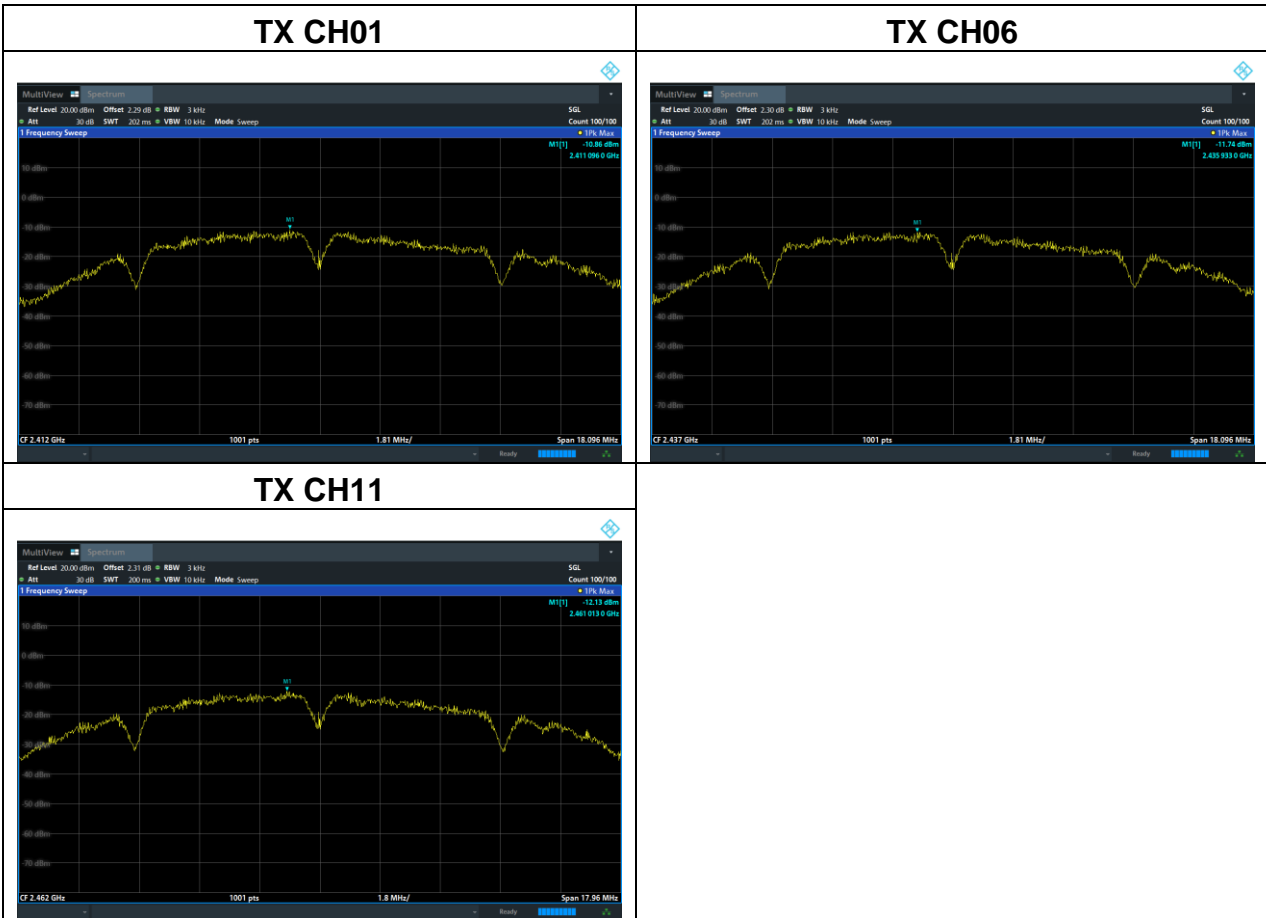

802.11g			
Frequency	Power Density (dBm/3kHz)	Limit (dBm/3kHz)	Result
2412 MHz	-17.97	8	Pass
2437 MHz	-17.79	8	Pass
2462 MHz	-17.65	8	Pass

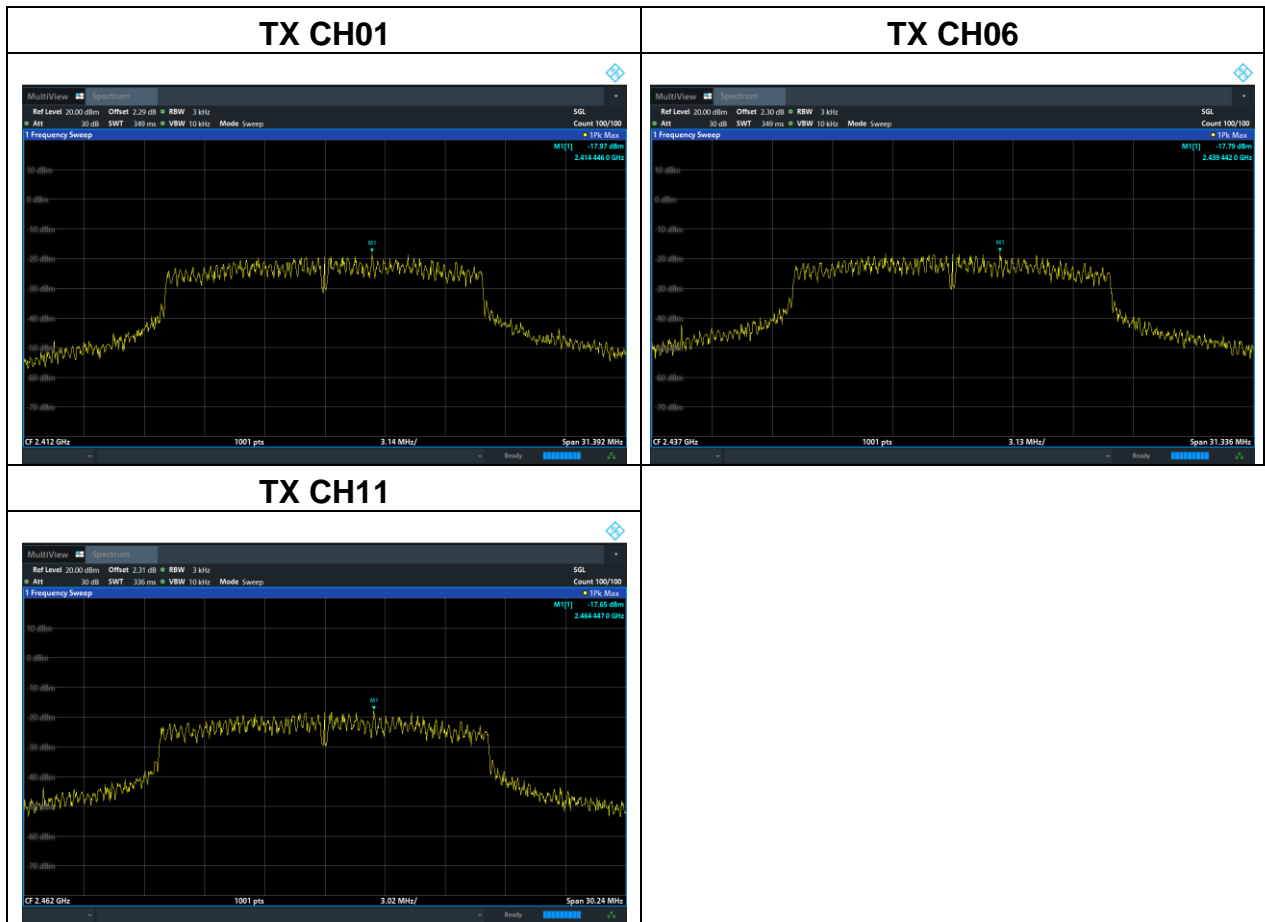

802.11n20			
Frequency	Power Density (dBm/3kHz)	Limit (dBm/3kHz)	Result
2412 MHz	-19.2	8	Pass
2437 MHz	-18.41	8	Pass
2462 MHz	-18.21	8	Pass

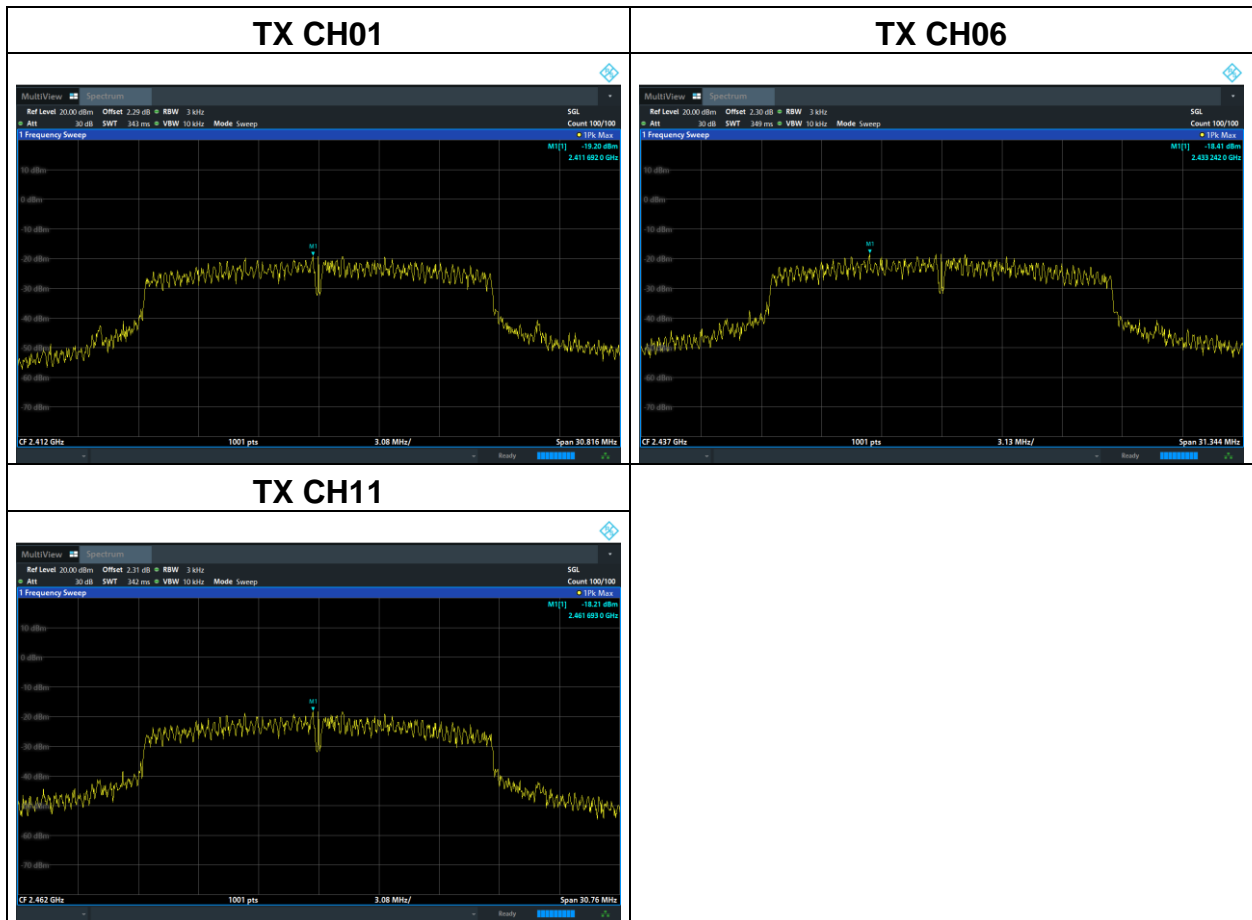

802.11n40			
Frequency	Power Density (dBm/3kHz)	Limit (dBm/3kHz)	Result
2422 MHz	-21.2	8	Pass
2437 MHz	-22.04	8	Pass
2452 MHz	-21.76	8	Pass

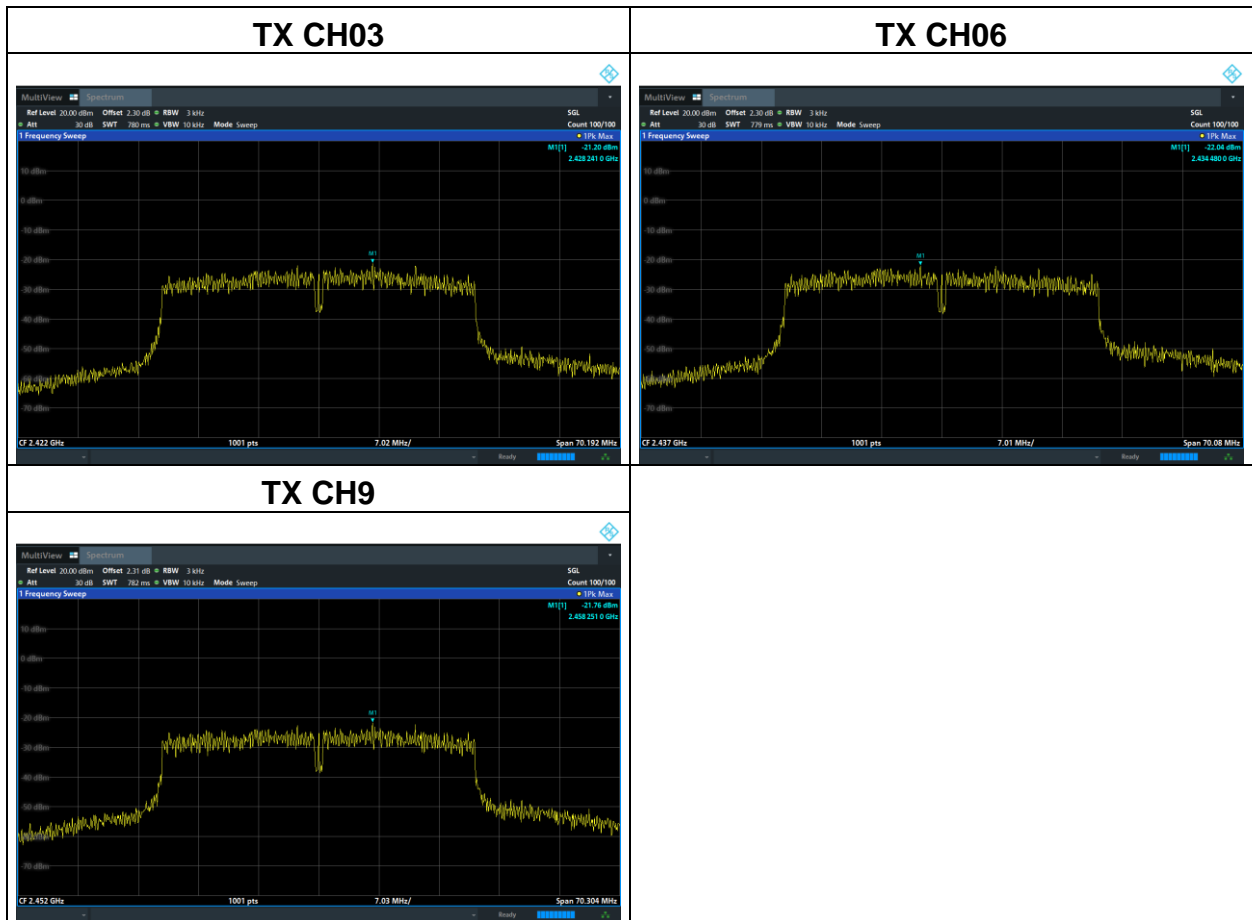

5.6 6dB Bandwidth

5.6.1 Limit

FCC Part15 (15.247) , Subpart C			
Section	Test Item	Limit	Frequency Range (MHz)
15.247(a)(2)	Bandwidth	$\geq 500\text{kHz}$ (6dB bandwidth)	2400-2483.5

5.6.2 Test Procedure

1. Set RBW= 100 kHz.
2. Set the video bandwidth (VBW) $\geq 3 \times$ RBW.
3. Detector = Peak.
4. Trace mode = max hold.
5. Sweep = auto couple.
6. Allow the trace to stabilize.
7. Measure the maximum width of the emission that is constrained by the frequencies associated with the two outermost amplitude points (upper and lower) that are attenuated by 6 dB relative to the maximum level measured in the fundamental emission.

5.6.3 Test Setup

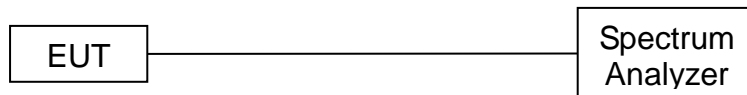

5.6.4 Test Results

EUT:	WIFI Camera	Model Name:	A3
Pressure:	1012 hPa	Test Voltage:	DC 5V from adapter AC 120V/60Hz
Test Mode:	TX b Mode /CH01, CH06, CH11		

Channel	Frequency (MHz)	6dB bandwidth (MHz)	Limit (kHz)	Result
Low	2412	9.048	500	Pass
Middle	2437	9.048	500	Pass
High	2462	8.98	500	Pass

Test plots

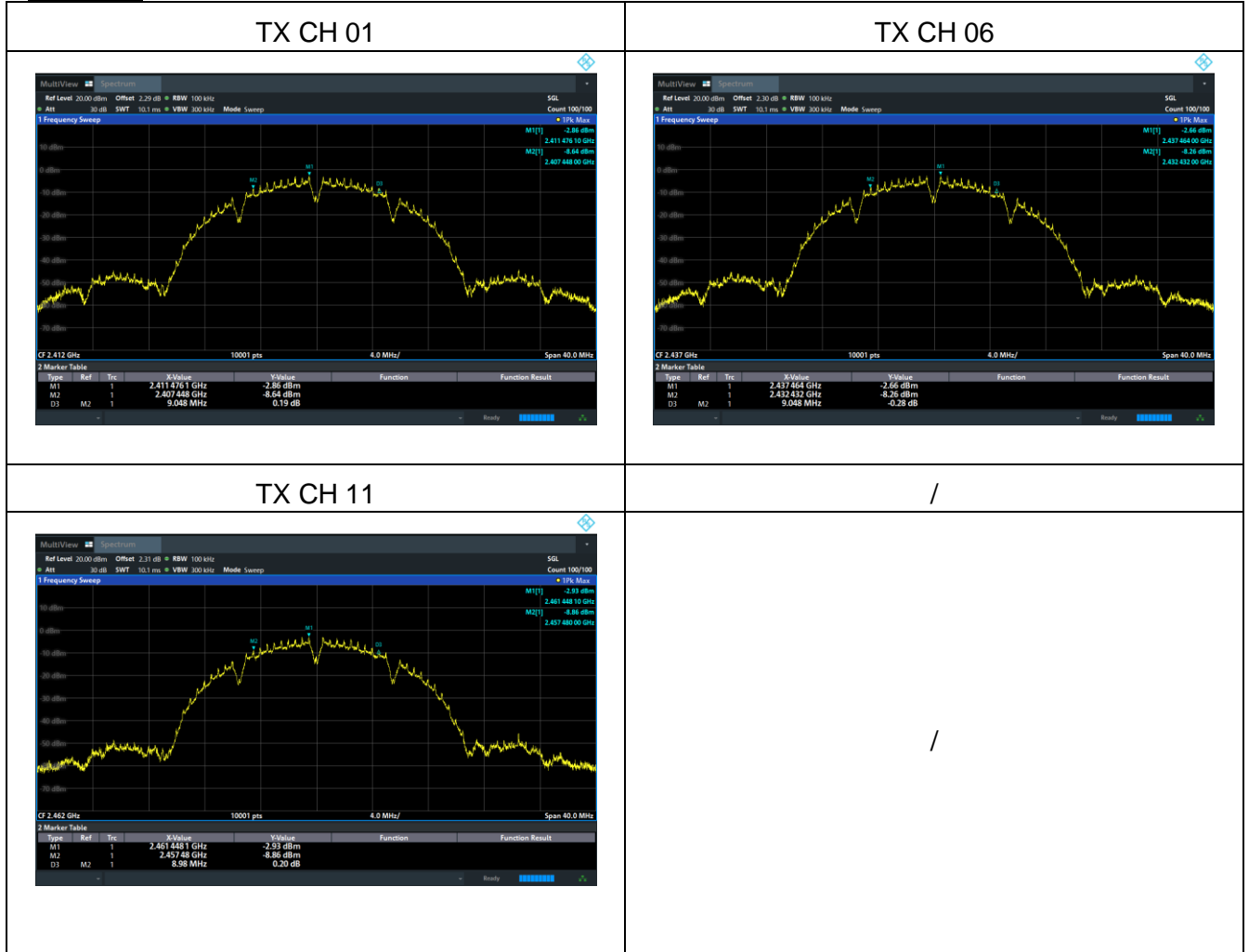

EUT:	WIFI Camera	Model Name:	A3
Pressure:	1012 hPa	Test Voltage:	DC 5V from adapter AC 120V/60Hz
Test Mode:	TX g Mode /CH01, CH06, CH11		

Channel	Frequency (MHz)	6dB bandwidth (MHz)	Limit (kHz)	Result
Low	2412	15.696	500	Pass
Middle	2437	15.668	500	Pass
High	2462	15.12	500	Pass

Test plots

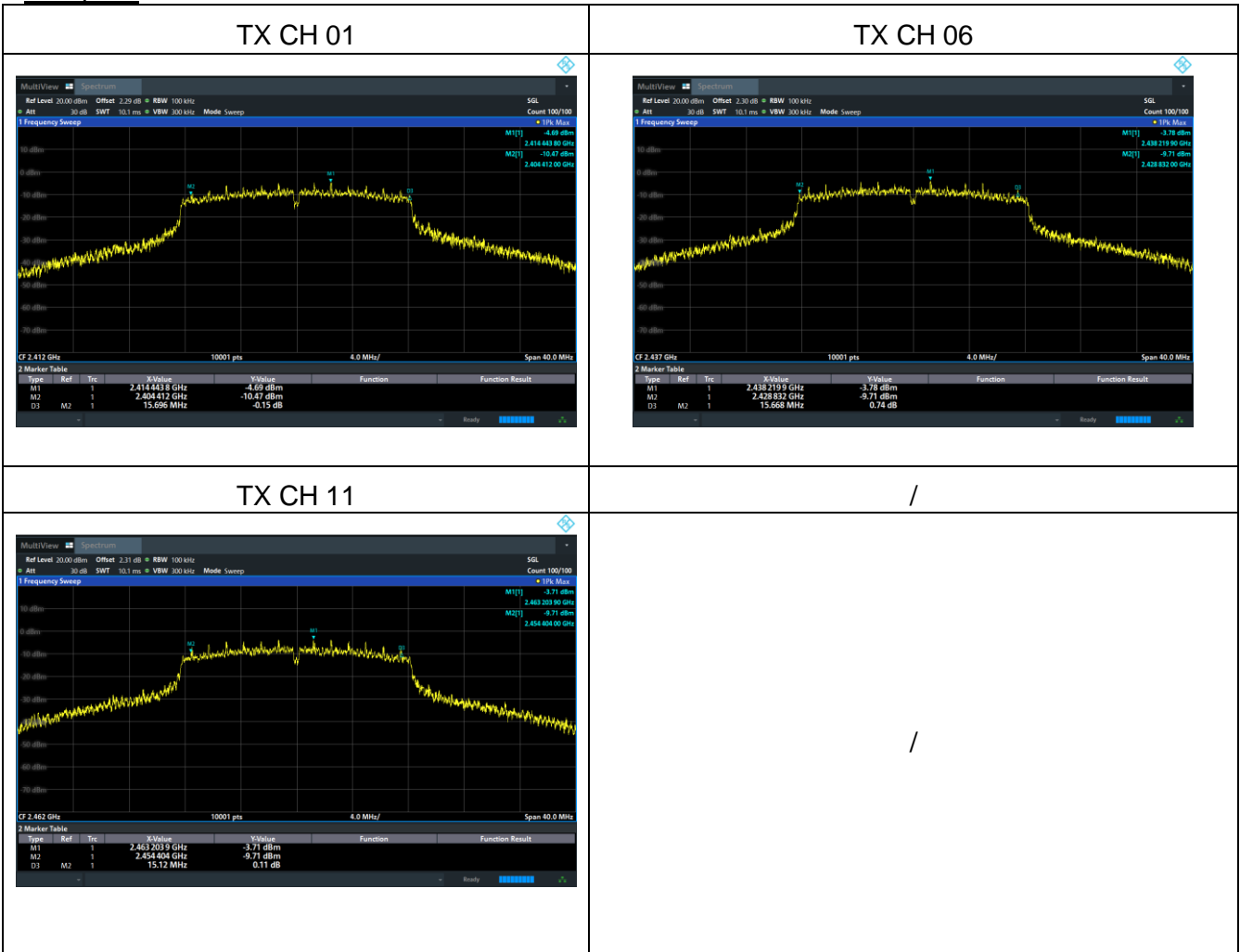

EUT:	WIFI Camera	Model Name:	A3
Pressure:	1012 hPa	Test Voltage:	DC 5V from adapter AC 120V/60Hz
Test Mode:	TX n20 Mode /CH01, CH06, CH11		

Channel	Frequency (MHz)	6dB bandwidth (MHz)	Limit (kHz)	Result
Low	2412	15.408	500	Pass
Middle	2437	15.672	500	Pass
High	2462	15.38	500	Pass

Test plots

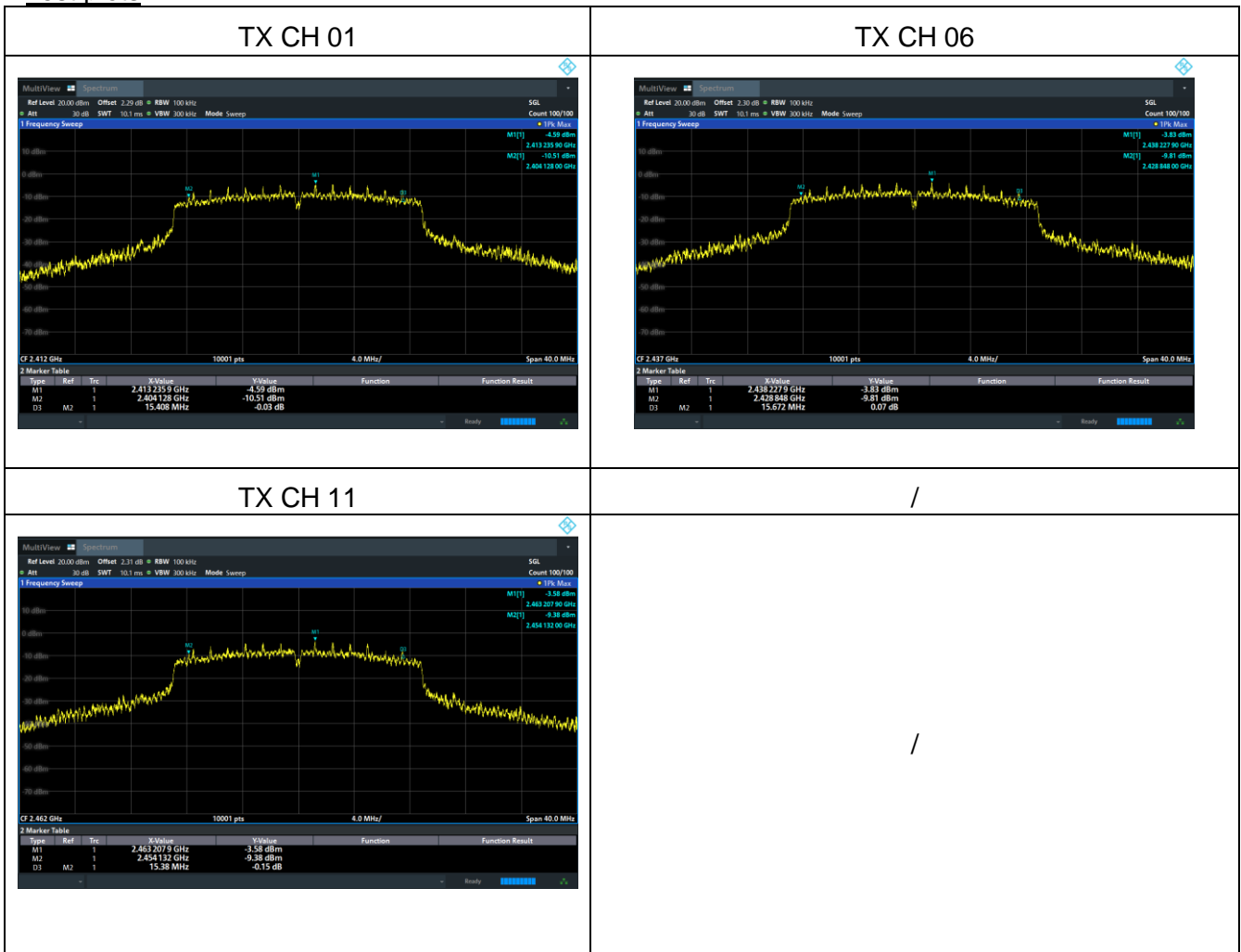

EUT:	WIFI Camera	Model Name:	A3
Pressure:	1012 hPa	Test Voltage:	DC 5V from adapter AC 120V/60Hz
Test Mode:	TX n40 Mode /CH03, CH06, CH09		

Channel	Frequency (MHz)	6dB bandwidth (MHz)	Limit (kHz)	Result
Low	2422	35.096	500	Pass
Middle	2437	35.040	500	Pass
High	2452	35.152	500	Pass

Test plots

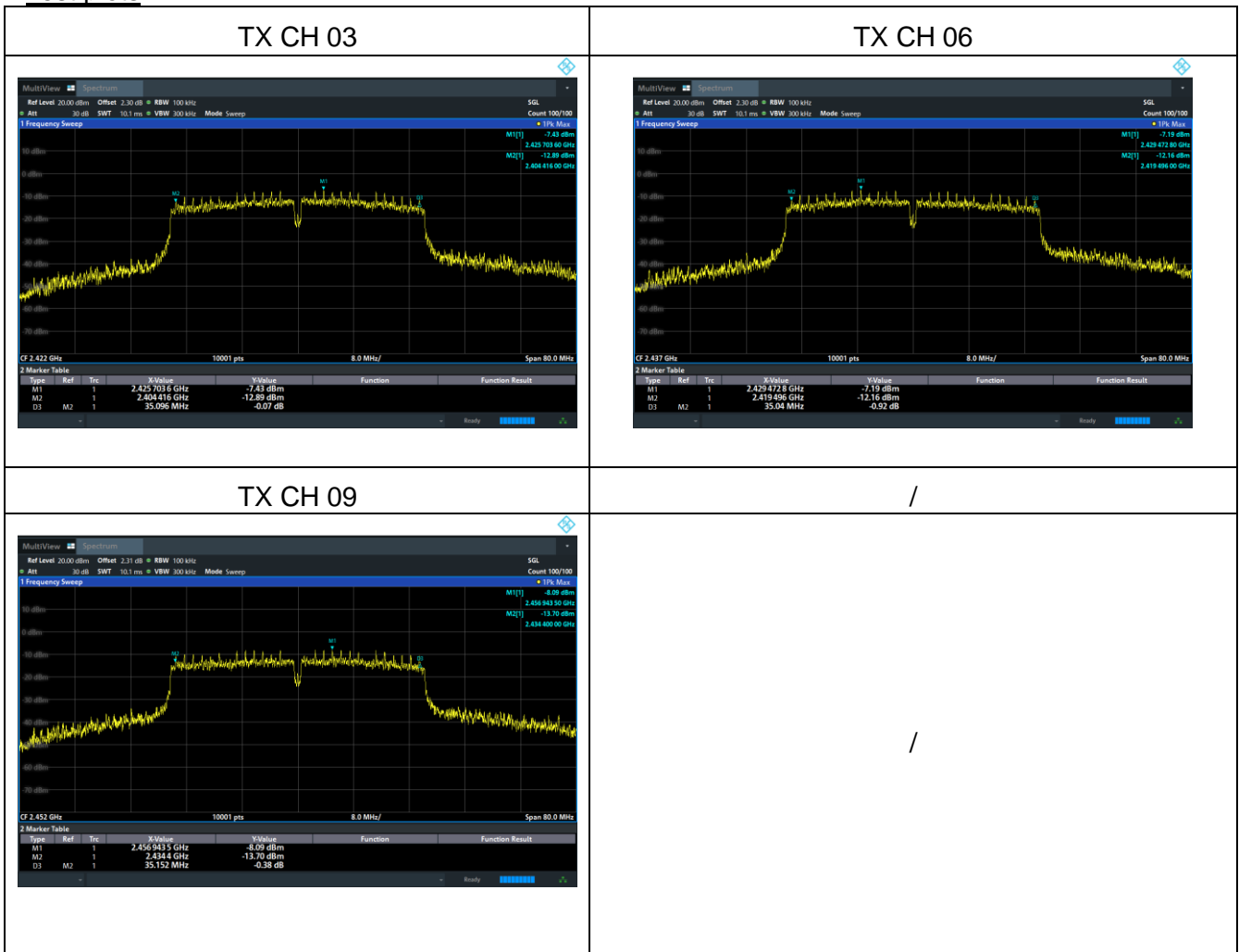

5.7 Duty Cycle

5.7.1 Limit

No limit requirement.

5.7.2 Test Procedure

The zero-span mode on a spectrum analyzer or EMI receiver if the response time and spacing between bins on the sweep are sufficient to permit accurate measurements of the on and off times of the transmitted signal. Set the center frequency of the instrument to the center frequency of the transmission. Set $RBW \geq OBW$ if possible; otherwise, set RBW to the largest available value. Set $VBW \geq RBW$. Set detector = peak or average. The zero-span measurement method shall not be used unless both RBW and VBW are $> 50/T$ and the number of sweep points across duration T exceeds 100. (For example, if VBW and/or RBW are limited to 3 MHz, then the zero-span method of measuring duty cycle shall not be used if $T \leq 16.7$ microseconds.)

The transmitter output is connected to the Spectrum Analyzer. We tested according to the zero-span measurement method, 6.0(b) in KDB 558074 D01 DTS Meas Guidance v05r02.

The largest available value of RBW is 8 MHz and VBW is 50 MHz. The zero-span method of measuring duty cycle shall not be used if $T \leq 6.25$ microseconds. ($50/6.25 = 8$)

The zero-span method was used because all measured T data are > 6.25 microseconds and both RBW and VBW are $> 50/T$.

The RF output of EUT was connected to the spectrum analyzer by RF cable and attenuator.

The path loss was compensated to the results for each measurement.

Set to the maximum power setting and enable the EUT transmit continuously.

The EUT was operating in controlled its channel.

Use the following spectrum analyzer settings:

Span = Zero Span

RBW = 8MHz (the largest available value)

VBW = 8MHz (\geq RBW)

Number of points in Sweep >100

Detector function = peak

Trace = Clear write

Measure Total and Ton

Calculate Duty Cycle = $Ton / Total$

5.7.3 Test Setup

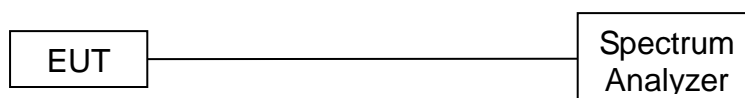

5.7.4 Test Results

EUT:	WIFI Camera	Model Name:	A3
Pressure:	1012 hPa	Test Voltage:	DC 5V from adapter AC 120V/60Hz
Test Mode:	TX b/g/n(20/40) Mode		

Mode	Frequency (MHz)	Duty Cycle (%)	Correction Factor (dB)	1/T (kHz)
b	2412	99.83	0	0.12
b	2437	99.83	0	0.12
b	2462	99.83	0	0.12
g	2412	98.53	0	1.07
g	2437	98.74	0	1.06
g	2462	98.53	0	1.07
n20	2412	98.25	0	1.49
n20	2437	97.95	0.09	1.49
n20	2462	97.95	0.09	1.49
n40	2422	97.74	0.1	2.89
n40	2437	98.31	0	2.87
n40	2452	97.74	0.1	2.89

5.8 Conducted Band Edge

5.8.1 Limit

In any 100 kHz bandwidth outside the frequency band in which the spread spectrum or digitally modulated intentional radiator is operating, the radio frequency power that is produced by the intentional radiator shall be at least 20 dB below that in the 100 kHz bandwidth within the band that contains the highest level of the desired power, based on either an RF conducted or a radiated measurement, provided the transmitter demonstrates compliance with the peak conducted power limits. If the transmitter complies with the conducted power limits based on the use of RMS averaging over a time interval, as permitted under paragraph (b)(3) of this section, the attenuation required under this paragraph shall be 30 dB instead of 20 dB. Attenuation below the general limits specified in §15.209(a) is not required. In addition, radiated emissions which fall in the restricted bands, as defined in §15.205(a), must also comply with the radiated emission limits specified in §15.209(a) (see §15.205(c)).

5.8.2 Test Procedure

- a) Check the calibration of the measuring instrument using either an internal calibrator or a known signal from an external generator.
- b) Position the EUT without connection to measurement instrument. Turn on the EUT and connect its antenna terminal to measurement instrument via a low loss cable. Then set it to any one measured frequency within its operating range, and make sure the instrument is operated in its linear range.
- c) Set RBW to 100 kHz and VBW of spectrum analyzer to 300 kHz with a convenient frequency span including 100 kHz bandwidth from band edge.
- d) Measure the highest amplitude appearing on spectral display and set it as a reference level. Plot the graph with marking the highest point and edge frequency.
- e) Repeat above procedures until all measured frequencies were complete.

5.8.3 Test Setup

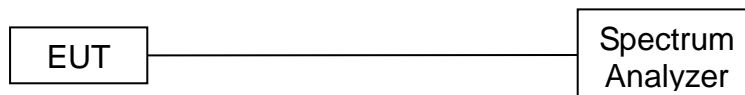

5.8.4 Test Results

802.11b: Band Edge, Left Side

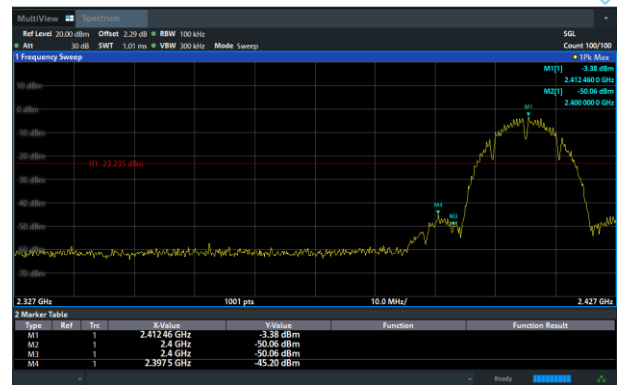
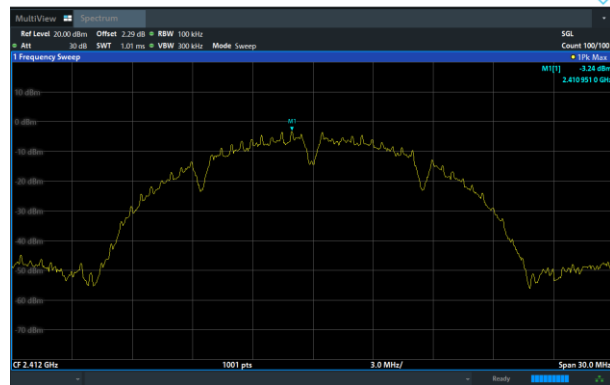

802.11b: Band Edge, Right Side

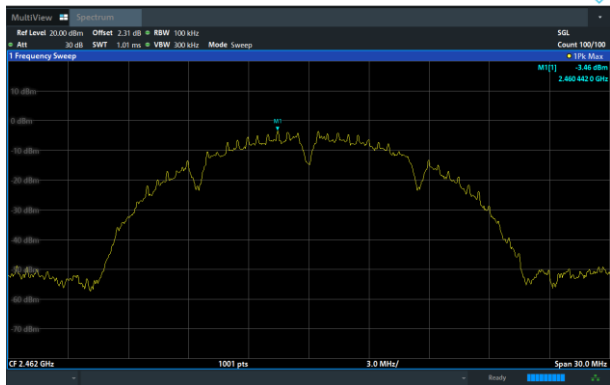

802.11g: Band Edge, Left Side

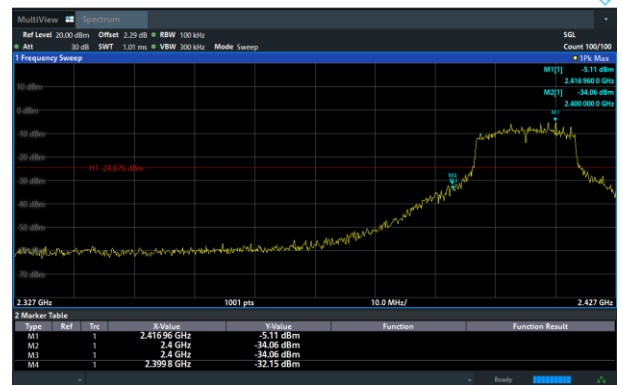
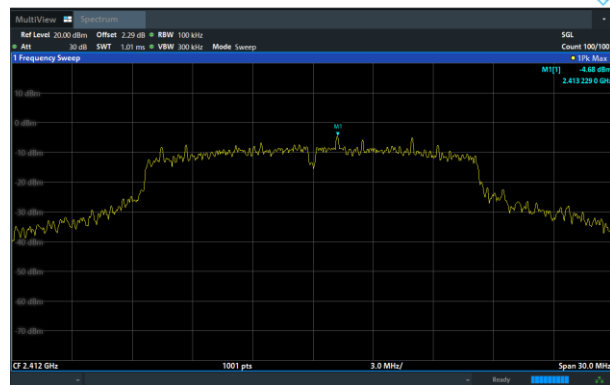

802.11g: Band Edge, Right Side

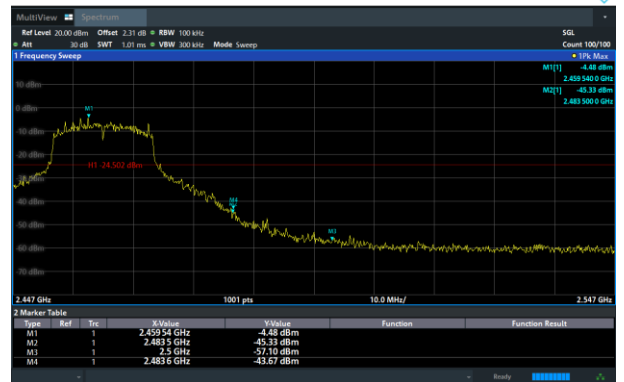
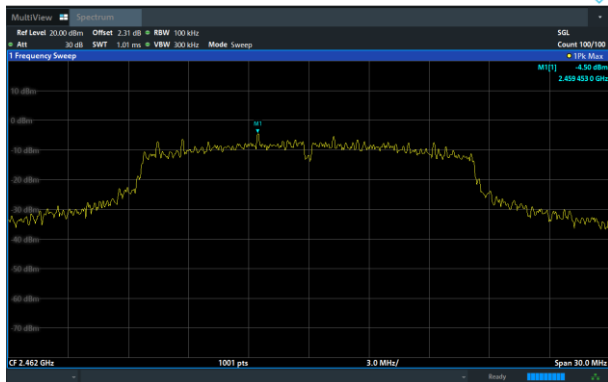

802.11n20: Band Edge, Left Side

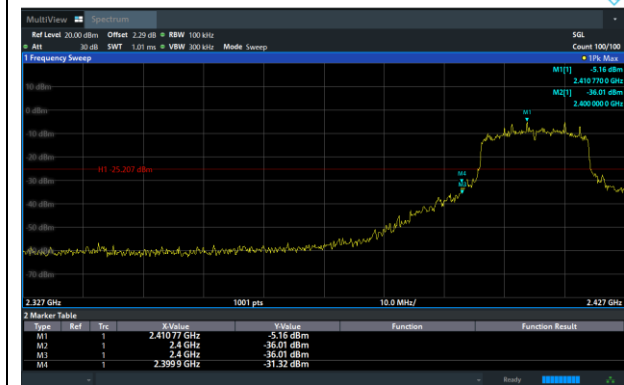
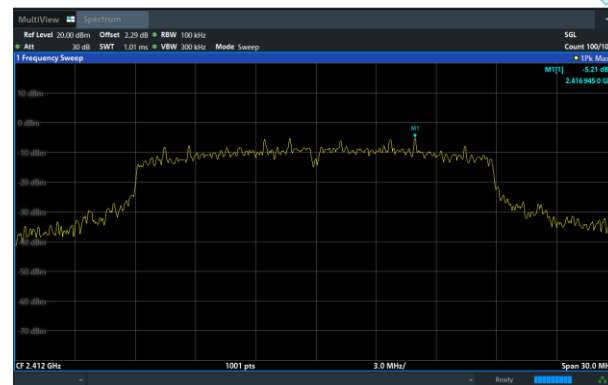

802.11n20: Band Edge, Right Side

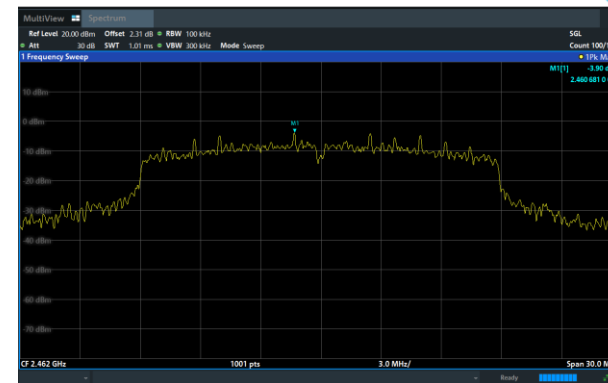

802.11n40: Band Edge, Left Side

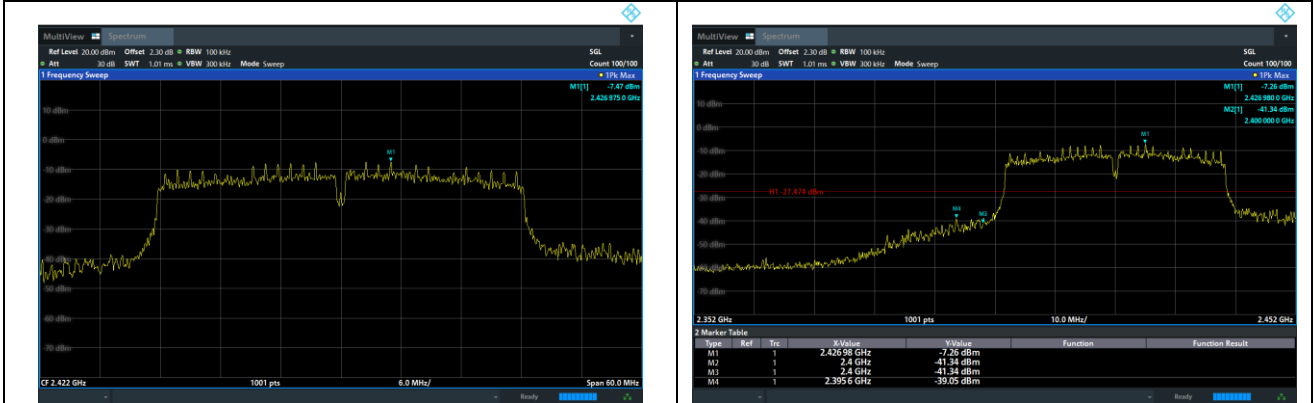

802.11n40: Band Edge, Right Side



5.9 Spurious RF Conducted Emissions

5.9.1 Limit

Below -20dB of the highest emission level in operating band.

5.9.2 Measuring Instruments

The Measuring equipment is listed in the section 4 of this test report.

5.9.3 Test Procedure

The Spurious RF conducted emissions compliance of RF radiated emission should be measured by following the guidance in ANSI C63.10-2020 with respect to maximizing the emission by rotating the EUT, measuring the emission while the EUT is situated in three orthogonal planes (if appropriate), adjusting the measurement antenna height and polarization etc. Set RBW=100kHz and VBW=300kHz to measure the peak field strength, and measure frequency range from 9kHz to 26.5GHz.

5.9.4 Test Setup

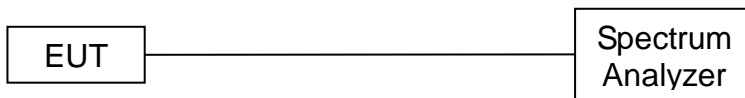

5.9.5 Test Results

Note:

1: The measurement frequency range is from 9kHz to the 10th harmonic of the fundamental frequency; The lowest, middle and highest channels are tested to verify the spurious emissions and band edge measurement data.

2: The three modulated high, medium and low channels have been tested. The report only shows the worst mode. The worst mode is 802.11b CH01/06/11.

802.11b on Channel 01

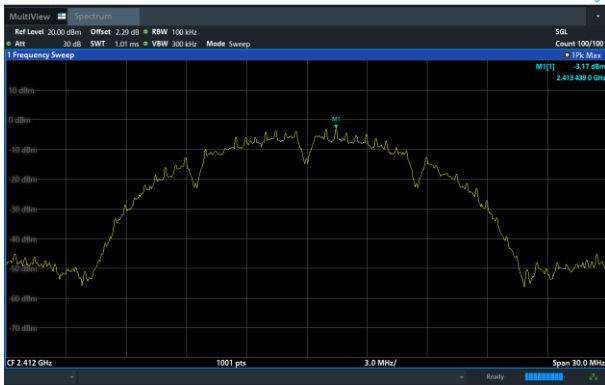

802.11b on Channel 01

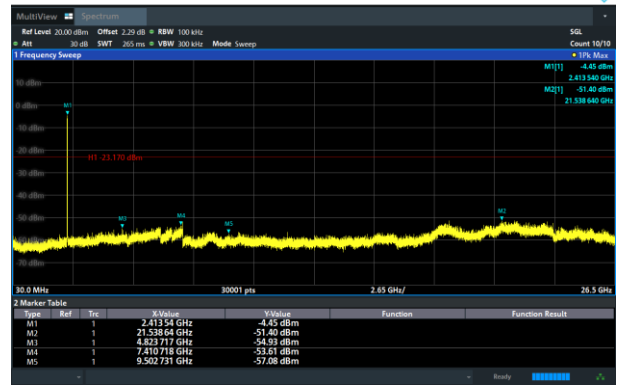

802.11b on Channel 06

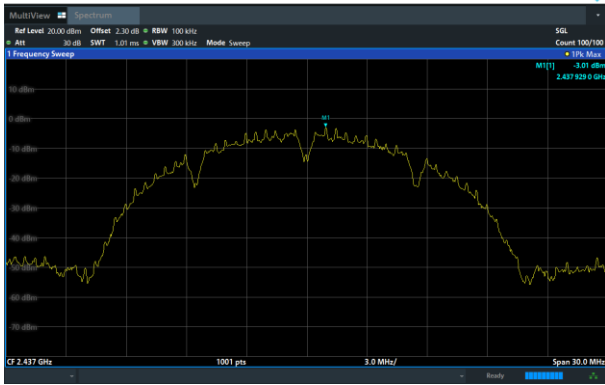

802.11b on Channel 06

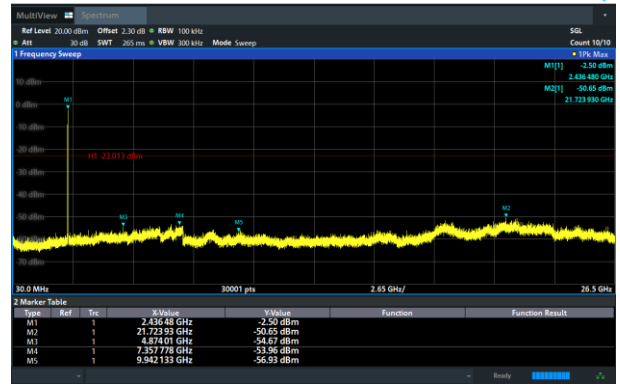

802.11b on Channel 11

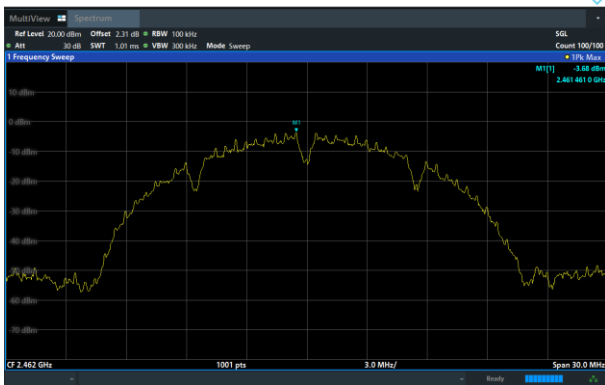

802.11b on Channel 11

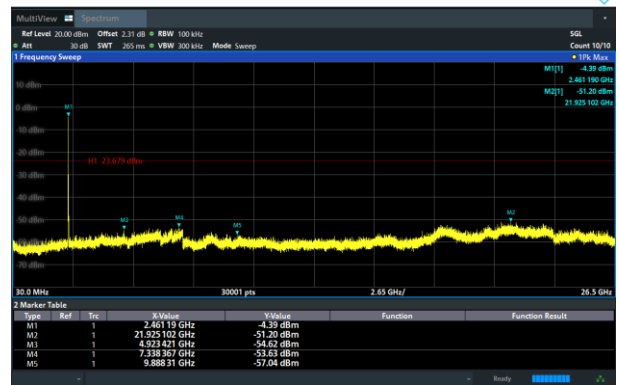

6 Photographs of the Test Setup

Radiated Emission Below 1GHz

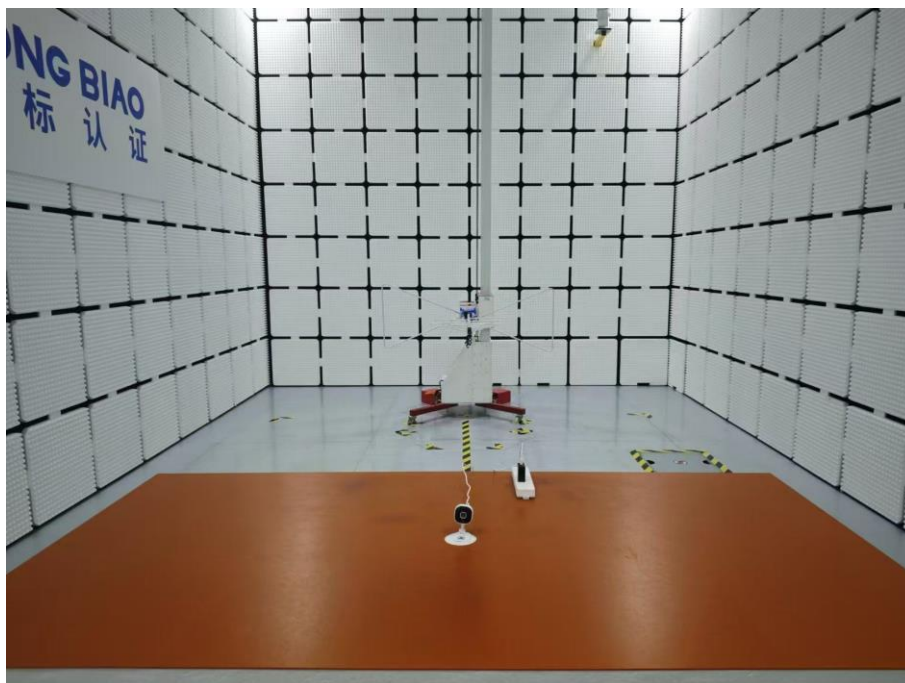

Radiated Emission Above 1GHz



Conducted Emission

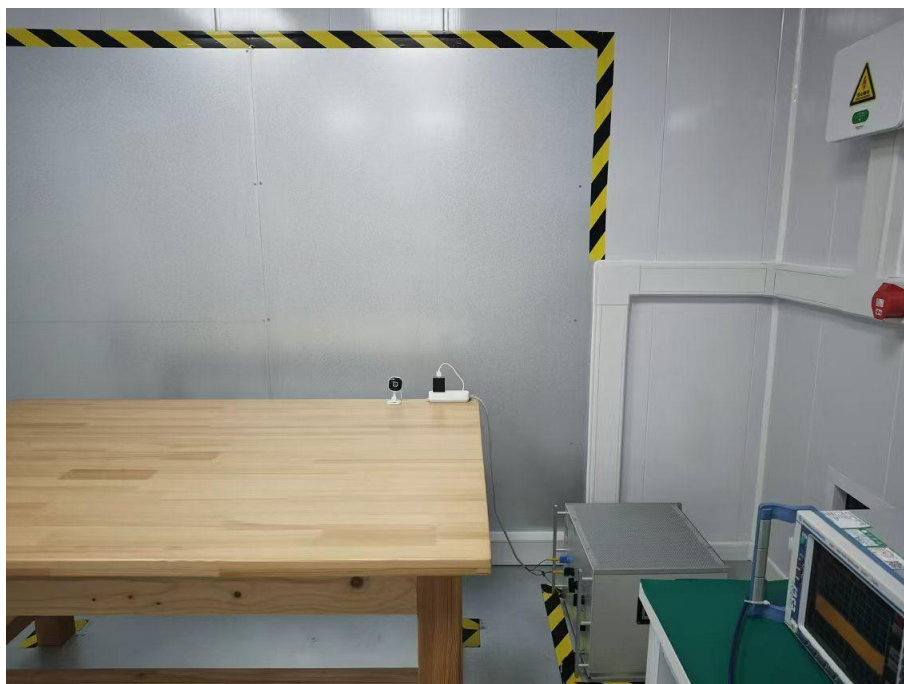

7 Photographs of the EUT

Photo 1



Photo 2

