

User Manual

GRT101R Smart Water Timer

Model: GRT101R + GRG101R

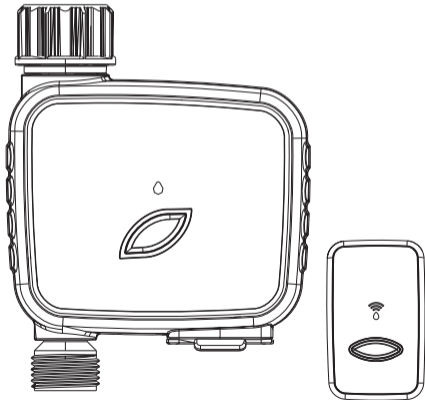

Inlet

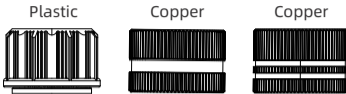

Warranty

Our products come with a one-year warranty, and if there is a quality problem within one year from the date of purchase.

Warning

- Use in clean, cold water.
- When the temperature is below 37°F (3°C), the water in the timer will freeze, squeeze the product shell and cause water leakage to be used normally, the controller should be removed and stored indoors.
- The filter prevents dirt and extends the life of the product. Clean the filter regularly and replace it in time if there is any mushroom damage.
- To ensure a longer service life, please use 4*AA alkaline batteries (not included). Do not mix old and new alkaline, carbon-zinc or rechargeable batteries.
- Before first use or not used for a while, activate the irrigation timer.

Introduction

Contents in the Box



1 x GRG101R



1 x GRT101R



1 x Instruction Manual

FCC STATEMENT:

1. This device complies with Part 15 of the FCC Rules. Operation is subject to the following two conditions:

- (1) This device may not cause harmful interference, and
- (2) This device must accept any interference received, including interference that may cause undesired operation.

2. Changes or modifications not expressly approved by the party responsible for compliance could void the user's authority to operate the equipment.

This equipment has been tested and found to comply with the limits for a Class B digital device, pursuant to part 15 of the FCC Rules. These limits are designed to provide reasonable protection against harmful interference in a residential installation. This equipment generates, uses and can radiate radio frequency energy and, if not installed and used in accordance with the instructions, may cause harmful interference to radio communications. However, there is no guarantee that interference will not occur in a particular installation. If this equipment does cause harmful interference to radio or television reception, which can be determined by turning the equipment off and on, the user is encouraged to try to correct the interference by one or more of the following measures:

- Reorient or relocate the receiving antenna.
- Increase the separation between the equipment and receiver.
- Connect the equipment into an outlet on a circuit different from that to which the receiver is connected.
- Consult the dealer or an experienced radio/ TV technician for help.

FCC Radiation Exposure Statement:

This equipment complies with FCC radiation exposure limits set forth for an uncontrolled environment. In order to avoid the possibility of exceeding the FCC radio frequency exposure limits, Human proximity to the antenna shall not be less than 20cm (8 inches) during normal operation.

01 Introduction to the feature

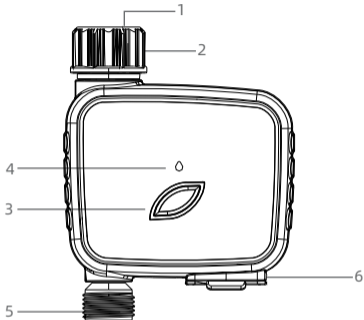

GRT101R Smart Water Timer

(1) Inlet Filter

(2) Water Inlet

(3) Timer Button

(4) LED Indicator

(5) Water Outlet

(6) Battery Compartment

Specification:

Range Between WiFi hub and Timer	160 ft(50m) in the open area without interference
Water pressure	7.25-116PSI(0.5-8Bar)
Operating temperature	3°C-50°C(37.4°F-122°F)
Waterproof rating	IP54
Water inlet	NH(US)For 3/4" screw thread BSP(EU)For 3/4" or 1" screw thread
Water outlet	For 3/4" Standard tube
Battery	4*AA(1.5V) Alkaline batteries (not included)



For outdoor use with cold water only.

Keep away from freezing. In freezing weather, the timer should be placed indoors.

Used up or dead batteries must be removed from the timer and disposed of properly.

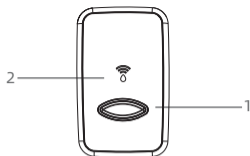

GRG101R Smart Gateway

(1) Control Button

(2) LED Indicator

Specification:

Range Between WiFi hub and Timer	160 ft(50m) in the open area without interference
input	100-240V~50/60Hz
WiFi Frequency	2.4GHz only
Protocol	IEEE 802.11b/g/n
Working Temperature	3°C-40°C(37.4°F-104°F)
Working Humidity	10%-90%(no condensation)
APP	SmartLife



For indoor use only.

Only applicable to 2.4Ghz WiFi. If your router is a dual-band router, please independently enable the 2.4GHz WiFi band and name it differently from the 5GHz WiFi band.

02 Feature Overview

1. **WiFi Remote Control** : Connect with 2.4GHz WiFi , set and check irrigation schedule by APP.
2. **Two Watering mode** : Normal Watering mode and Cycle/Soak Watering mode.
3. **Watering on Schedule** : The timer can set up to 4 separate watering programs for each Normal and Cycle/Soak mode. Each watering program has different start time.
4. **Manual Watering** : Manually turn on/off watering and set watering time.
5. **Rain Delay** : Manual Rain Delay and Automatically Rain Delay.
6. Low Battery Indication.
7. One WiFi hub can pair with maximum 4 WiFi water timers.

*Only applicable to 2.4Ghz WiFi

03 Initial Smartlife App Setup

STEP1. Install App On Your Phone

Search “**Smart Life**” on APP Store or Google Play. Or scan the QR code and download the free Android or IOS app, then install the APP.

Open the Smart life APP, select “**Sign up**” . Follow the prompts to register a smart life account with your email account or mobile number.

If you have already installed the Smart Life App, go to step 2.



Download on the
App Store



GET IT ON
Google Play

STEP2. Connect The Wifi Hub

First Way :

1. Press and hold the button on the WiFi Hub until the LED indicator blink rapidly (2 times per seconds)
2. Turn on the phone's Bluetooth and WiFi, and tap “**Add Device**” or “**+**” , it will scan automatically.

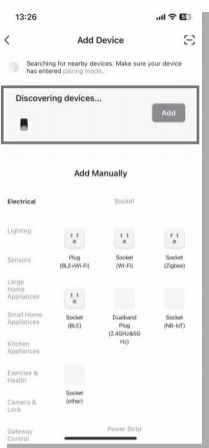
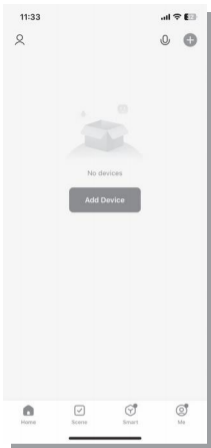

3. Click **"Add"** and enter your WiFi information (Only 2.4GHz WiFi is supported), waiting for connecting to be 100%. Ensure that the **"WiFi Hub"** is added successfully.

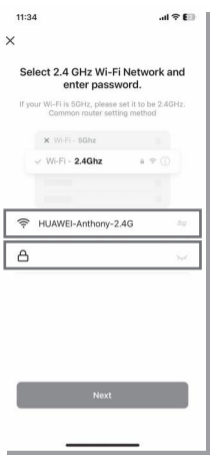

Choose an indoor location for your hub near the router.

Second Way :

- 1.Press and hold the button on the WiFi Timer until the LED indicator blink rapidly (2 times per seconds)
- 2.Turn on the phone's Bluetooth and WiFi, and tap **"Add Device"** or **"+"** to add the smart device to the app.
- 3.Select **"Industry Agriculture"** > add WiFi hub
- 4.Select 2.4Ghz Wifi, enter the password.

Tips:

Only applicable to 2.4Ghz WiFi. If your router is a dual-band router, please independently enable the 2.4GHz WiFi band and name it differently from the 5GHz WiFi band.

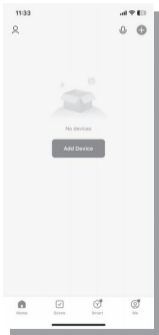

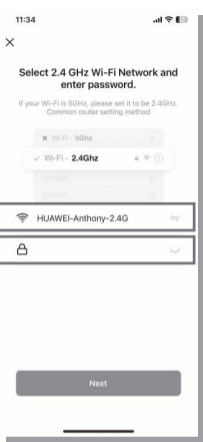

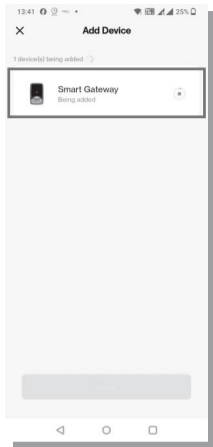

Wifi Hub LED indication

1. Smart pairing status : Green LED flashes rapidly. (2 times per second)
2. WiFi Connecting status : Green LED flashes slowly.
3. WiFi Connected status : Green LED light is always on.
4. No function : No light.

STEP3.Connect The Wifi Timer

1.After the gateway gets connected, then add the WiFi water timer on the gateway.

2.Insert 4 new AA alkaline batteries into the battery tray of the time. Restore the battery tray and make certain it is secured.

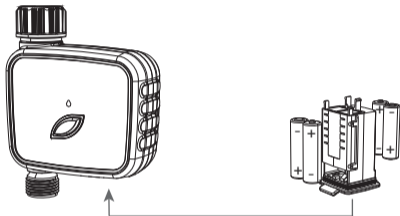

Warning:

- *Please use only alkaline batteries.
- *Do not mix old and new batteries.
- *Batteries are to be inserted with correct polarity.
- *Exhausted batteries are to be removed from the product.
- *Please remove the battery from long-term no use.

3.Return to the APP Home screen, and tap to Gateway you just connected.

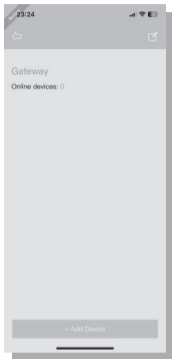

4.Press **“+ Add subdevice”** to pair and connect the WiFi Timer.

5.Press and hold the button on the WiFi Timer until the LED indicator blink rapidly (2 times per seconds). Then, the APP will search and pair your WiFi timer automatically.

6.After the connection is successful, the color icons of WiFi water timer and smart gateway will be displayed on the App home screen.

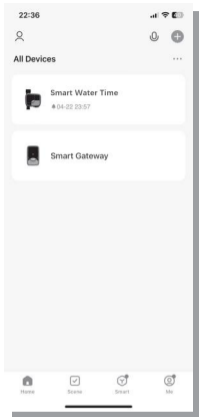
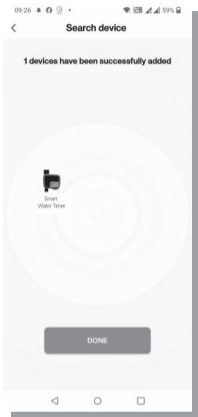

Tips:

If the LED indicator don't blink rapidly (2 times per second). Please remove the batteries for 30 seconds, and then install the batteries. Press and hold the button on the WiFi Timer until the LED indicator blink rapidly (2 times per seconds) again.

STEP4.Install The Wifi Timer

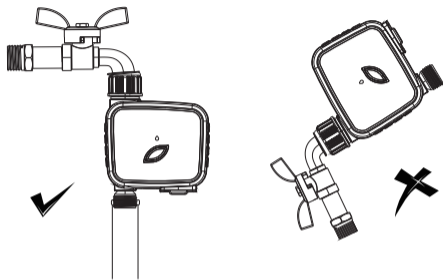

1. Turn off the faucet in the garden.
2. Wrap the **PTFE** tape around the faucet thread.
3. Screwing the timer to the garden faucet and keeping the display perpendicular to the ground prevents rainwater from accumulating and seeping inside.
4. Wrap the **PTFE** tape around the timer outlet.
5. From the timer outlet connect a drip irrigation system or a garden hose.

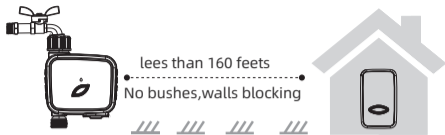

Warning:

- The WiFi timer can only be used for cold water.
- The WiFi timer use 433Mhz RF connection to communicate with WiFi Hub, and must be within a 160ft (50m) range, line in sight, of the WiFi hub. If there are walls, iron gates or brushes blocking, please shorten the distance between them to better receive the signal.
- Do not place the WiFi timer in an underground valve box or anywhere your WiFi and RF signal will e obstructed.
- Under freezing weather, the WiFi water timer should be removed from the tap and placed properly indoor to avoid any danger of freezing.

STEP5. TEST BEFORE USE

After completed the connection and installation of the WiFi water timer. Please test whether the internal valve of your WiFi water timer is normal before using it.

1. Keep the faucet turned off.
2. Press the button of the WiFi water timer with a “click” sound, the valve inside the timer opens for manual watering. After a few seconds, press the button again, the “click” sound will sound again, and the valve will close.
3. Turn on the facet a little bit, press the button of the WiFi water timer to check if the water flow out or shut off as expected. If yes, the valve is normal, please use it with confidence. If not, please repeat the above steps several times.

Note:

When testing, please away from the water outlet of the WiFi water timer to avoid being splashed and wet.

04 Water Timer APP Home Page



Weather Information

Enter the page to display current weather information and 7-day weather forecasting.

Setting

Enter the page for Time format and language setting.

Working Status

Display the battery level of the WiFi water time, the current working mode, and the time of next watering.

Edit

Enter the page for device information and third-party control.

Manual Watering

Enter the manual watering setting page.

Watering Plan

Enter the watering plan page to set up the watering schedules.

Manual Watering

Manual Watering Duration

Tap to set the desired manual watering duration.

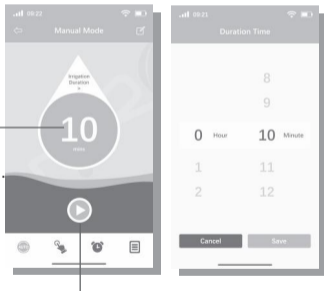

Manual Watering ON/OFF control

Tap  to start manual watering and  to stop.

Watering Plan

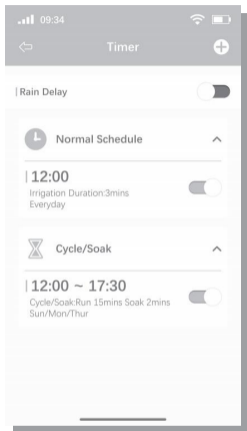

There are two irrigation mode

Normal Schedule: Water for a particular period in a day

Cycle/Soak: Water for a certain period several times a day.

There are total 8 watering schedule can be set. 4 for Normal Schedule, 4 for Cycle/Soak.

Press “+” to add a watering schedule.

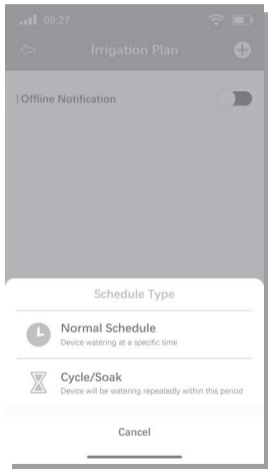

Normal Schedule

The screenshot shows a mobile app interface for setting a timer. At the top, the status bar shows signal strength, the time 09:42, Wi-Fi, and battery icons. Below is a header with a back arrow, the title 'Add Timer', and the subtitle 'Device watering at a specific time'. The main content area is divided into sections: 'Start Time' with a grid of hour and minute options (10:43, 11:44, 8:30, 0:46, 1:47) where '8:30 AM' is selected; 'Irrigation Duration' set to '1 hr 20 min' with a right arrow; 'Weekdays To Water' with a checked checkbox and seven day buttons (Sun, Mon, Tue, Wed, Thur, Fri, Sat) where Mon, Wed, and Fri are selected; and a 'Save' button at the bottom.

Start Time

The time you want the device to start watering.

Irrigation Duration

The duration you want to water.

Watering Day of Week

Days you want to water.

Save

Tap to save your settings.

For example

The picture shows the WiFi water timer 1 hour 20 minutes in normal irrigation mode. The start time is every Monday, Wednesday and Friday at 8:30am.

Cycle/Soak

The screenshot shows the 'Add Cycle Timer' screen in the 'Cycle and Soak' app. At the top, the status bar shows signal strength, the time 09:43, Wi-Fi, and battery icons. Below the title 'Add Cycle Timer' is a subtitle 'Cycle and Soak'. The main settings are organized into sections:

- Start Time & End Time:** A table with two columns, 'Start Time' and 'End Time', each containing a 2x2 grid of time selection options (hours, minutes, AM/PM).
- Watering Day of Week:** A row of seven circular buttons for the days of the week: Sun, Mon, Tue, Wed, Thur, Fri, Sat. The Mon, Wed, and Fri buttons are shaded grey, indicating they are selected.
- Cycle/Soak:** A text block explaining that during the period, the device breaks watering into multiple cycles to allow the soil to soak.
- Cycle Duration:** A setting with a dropdown menu currently showing '1 min' and a right-pointing chevron.
- Pause Duration:** A setting with a dropdown menu currently showing '3 min' and a right-pointing chevron.
- Save:** A large grey button at the bottom center.

Start Time & End Time

The time you want the device to start and stop watering.

Watering Day of Week

Days you want to water.

Cycle Duration

Determine how long to water.

Pause Duration

Set the pause time.

Save

Tap to save your settings.

For example

The picture shows the WiFi water timer 1 minute and then pause for 3 minutes in cycle/soak irrigation mode. The cycle is start from 8:30 am to 10:30am every Monday, Wednesday and Friday.

Turn on/off watering schedules

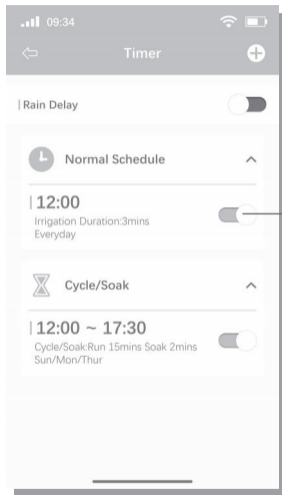

Slide the switch of the watering plan to turn it on or off.

Delete the watering schedules

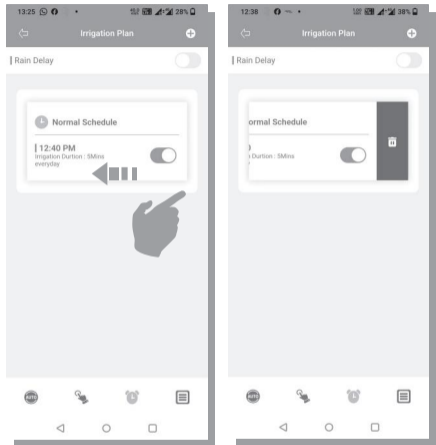

Slide the selected plan from right to left, a red **“Delete”** will show. Tap **“Delete”** to delete this plan.

Slide the plan from left to right to cancel the operation.

Rain Delay

Rain delay applies to rainy days or other weather that causes high soil moisture. During the rain delay the WiFi water timer stops watering. After the rain delay ends, the WiFi water timer will be executed according to next watering plan. The timer can set 24/48/72 hours of rain delay.

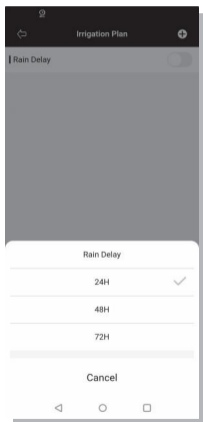
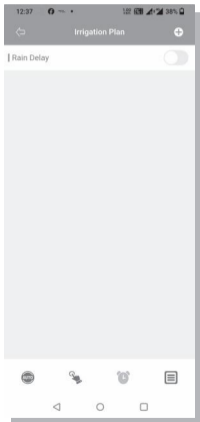

Turn on/off rain delay function

After set the rain delay, it can show the End time of the rain delay function.

Slide the switch to turn the rain delay function off.

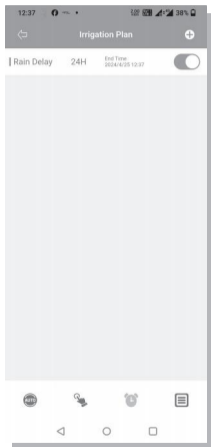

05 Cleaning up water timer

After a period of use, impurities or dirt in the water may accumulate inside the timer. Therefore, the timer should be cleaned regularly to ensure its normal operation.

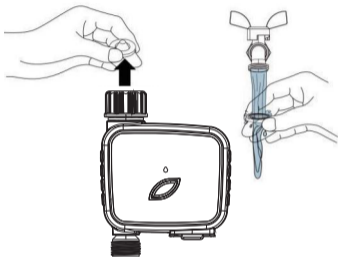

Follow the steps below to clean the timer:

1. Turn off the garden faucet and remove the timer. Check the timing water inlet filter for impurity accumulation.
2. If the filter element is dirty, remove it from the timer and rinse it with running water.
3. Turn on the manual watering mode of the timer, open the valve, and check whether the timer water pipe is blocked. If it is blocked, gently clean it with a small cleaning brush.

06 Troubleshooting

Problem	Possible Cause	Recommended solutions
Cannot turn on/off the valve	<ul style="list-style-type: none">● Low battery● Particles of dirt or debris in the valve.● Unstable network or delayed response.	<ul style="list-style-type: none">● Replace new batteries● Regular clean the filter port of impurities to avoid disruptions in use.● Wait a while and try again.
Plan not executed on time	<ul style="list-style-type: none">● Programming is incorrect.● The water pressure is too low.● Particles of dirt or debris in the valve.● In the low power state, the time will go into a low power protection state, and not execute the plan.● Rain delay function is enabled.	<ul style="list-style-type: none">● Check the plan parameter was set correctly.● Check the water pressure.● Inlet Impurities needed to be clear.● Replace new batteries.● Check whether the rain delay function was set.

<p>Hub cannot connect</p>	<ul style="list-style-type: none"> ● Hub not in pairing state. ● WiFi network is not using 2.4GHz. ● WiFi password is incorrect. 	<ul style="list-style-type: none"> ● Remove the gateway from the APP homepage and pair again. Press and hold the button until LED indicator flashes rapidly. This means that pairing has been entered. ● Make sure the connection with 2.4GHz WiFi network. ● Make sure the WiFi password has been entered correctly.
<p>Timer cannot be connected</p>	<ul style="list-style-type: none"> ● Timer is not in pairing state. ● Long distance from Hub. ● Signal is blocked by Obstacles. (concrete wall, Metal doors....) ● Unstable WiFi network. 	<ul style="list-style-type: none"> ● Remove the timer from the APP homepage and pair again. Press and hold the button until LED indicator flashes rapidly. This means that pairing has been entered. ● Close to hubs and router when connected to WiFi water timer. ● Check that WiFi network environment is working.

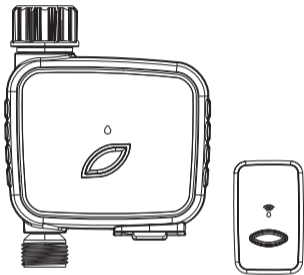

GRT101R + GRG101R