



MEASUREMENT REPORT

FCC ID : 2BH7FBE65POE

APPLICANT : TP-Link Systems Inc.

Application Type : Certification

Product : BE11000 Whole Home Mesh Wi-Fi 7 System with PoE

Model No. : Deco BE65-PoE

Brand Name : tp-link

FCC Classification : Digital Transmission System (DTS)

FCC Rule Part(s) : Part 15.247

Test Procedure(s) : ANSI C63.10-2013

Received Date : June 26, 2025

Test Date : July 1, 2025~ July 10, 2025

Tested By : *Owen Tsai*
(Owen Tsai)

Reviewed By : *Paddy Chen*
(Paddy Chen)

Approved By : *Chenz Ker*
(Chenz Ker)



The test results only relate to the tested sample.

This equipment has been shown to be capable of compliance with the applicable technical standards as indicated in the measurement report and was tested in accordance with the measurement procedures specified in ANSI C63.10. Test results reported herein relate only to the item(s) tested.

The test report shall not be reproduced except in full without the written approval of MRT Technology (Taiwan) Co., Ltd.

Revision History

Report No.	Version	Description	Issue Date	Note
2506TW0114-U2	1.0	Original Report	2025-08-25	

CONTENTS

Description	Page
1. INTRODUCTION	6
1.1. Scope.....	6
1.2. MRT Test Location.....	6
2. PRODUCT INFORMATION	7
2.1. Equipment Description	7
2.2. Product Specification Subjective to this Standard.....	8
2.3. Test Mode.....	8
2.4. Operation Frequency / Channel List.....	9
2.5. Test Configuration.....	10
2.6. Test System Details	11
2.7. Test Software.....	11
2.8. Duty Cycle.....	11
2.9. EMI Suppression Device(s)/Modifications	12
2.10. Labeling Requirements.....	12
3. DESCRIPTION of TEST	13
3.1. Evaluation Procedure.....	13
3.2. AC Line Conducted Emissions	13
3.3. Radiated Emissions	14
4. ANTENNA REQUIREMENTS.....	15
5. TEST EQUIPMENT CALIBRATION DATE.....	16
6. MEASUREMENT UNCERTAINTY.....	17
7. TEST RESULT	18
7.1. Summary.....	18
7.2. 6dB Bandwidth Measurement	19
7.2.1. Test Limit.....	19
7.2.2. Test Procedure used	19
7.2.3. Test Setting	19
7.2.4. Test Setup.....	19
7.2.5. Test Result	20
7.3. Output Power Measurement.....	21
7.3.1. Test Limit.....	21
7.3.2. Test Procedure Used.....	21
7.3.3. Test Setting	21
7.3.4. Test Setup.....	21
7.3.5. Test Result of Output Power.....	22
7.4. Power Spectral Density Measurement	23
7.4.1. Test Limit.....	23
7.4.2. Test Procedure Used.....	23
7.4.3. Test Setting	23
7.4.4. Test Setup.....	24
7.4.5. Test Result	25

7.5.	Out-of-Band Spurious Emissions Emissions Measurement	27
7.5.1.	Test Limit	27
7.5.2.	Test Procedure Used	27
7.5.3.	Test Settiting	27
7.5.4.	Test Setup	27
7.5.5.	Test Result	28
7.6.	Radiated Spurious Emission Measurement.....	30
7.6.1.	Test Limit	30
7.6.2.	Test Procedure Used	30
7.6.3.	Test Setting	30
7.6.4.	Test Setup	32
7.6.5.	Test Result	34
7.7.	Radiated Restricted Band Edge Measurement.....	44
7.7.1.	Test Limit	44
7.7.2.	Test Procedure Used	44
7.7.3.	Test Setting	44
7.7.4.	Test Setup	46
7.7.5.	Test Result	47
7.8.	AC Conducted Emissions Measurement	53
7.8.1.	Test Limit	53
7.8.2.	Test Setup	53
7.8.3.	Test Result	54
8.	CONCLUSION	56
	Appendix A : Test Photograph	57
	Appendix B : External Photograph	57
	Appendix C : Internal Photograph	57

General Information

Applicant	TP-Link Systems Inc.
Applicant Address	10 Mauchly, Irvine, CA 92618
Manufacturer	TP-Link Systems Inc.
Manufacturer Address	10 Mauchly, Irvine, CA 92618
Test Site	MRT Technology (Taiwan) Co., Ltd
Test Site Address	No. 38, Fuxing Second Rd., Guishan Dist., Taoyuan City 333, Taiwan (R.O.C)
MRT FCC Registration No.	291082
FCC Rule Part(s)	Part 15.247

Test Facility / Accreditations

1. MRT facility is a FCC registered (Reg. No. 291082) test facility with the site description report on file and is designated by the FCC as an Accredited Test Firm.
2. MRT facility is an IC registered (MRT Reg. No. 21723) test laboratory with the site description on file at Industry Canada.
3. MRT Lab is accredited to ISO 17025 by the Taiwan Accreditation Foundation (TAF Cert. No. 3261) in EMC, Telecommunications and Radio testing for FCC (Designation Number: TW3261), Industry Canada, EU and TELEC Rules.

1. INTRODUCTION

1.1. Scope

Measurement and determination of electromagnetic emissions (EMC) of radio frequency devices including intentional and/or unintentional radiators for compliance with the technical rules and regulations of the Federal Communications Commission and the Industry Canada Certification and Engineering Bureau.

1.2. MRT Test Location

The map below shows the location of the MRT LABORATORY, its proximity to the Taoyuan City. These measurement tests were conducted at the MRT Technology (Taiwan) Co., Ltd. Facility located at No.38, Fuxing 2nd Rd., Guishan Dist., Taoyuan City 33377, Taiwan (R.O.C).

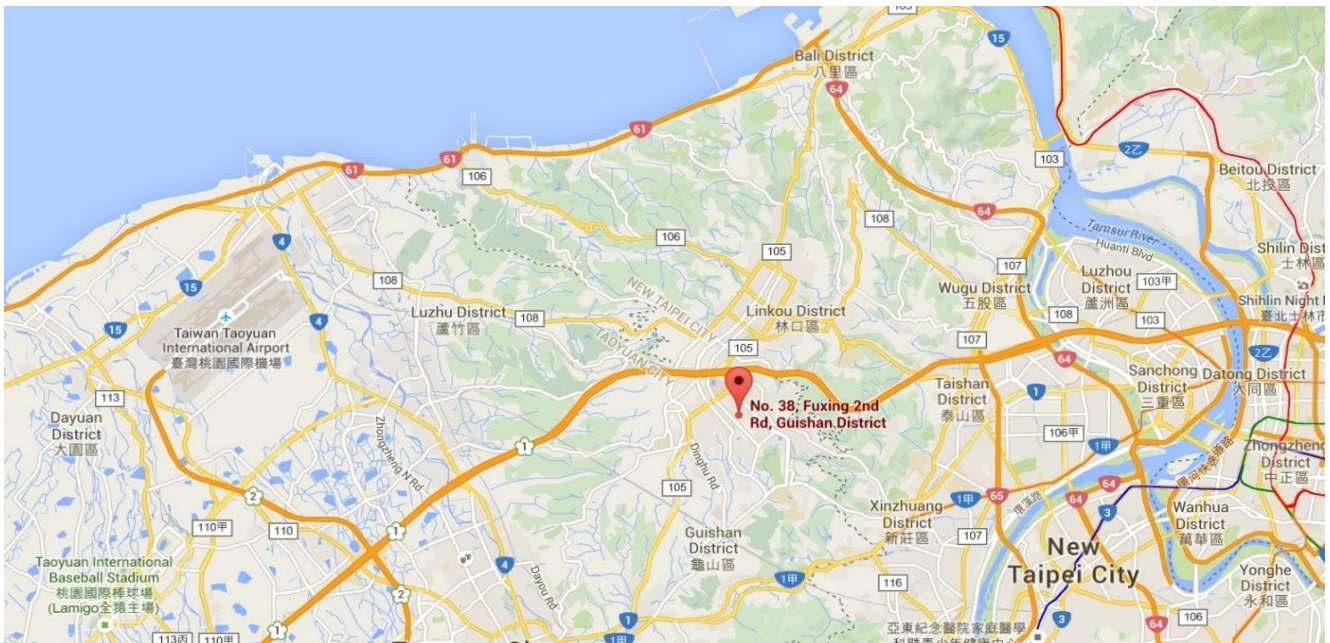

2. PRODUCT INFORMATION

2.1. Equipment Description

Product Name	BE11000 Whole Home Mesh Wi-Fi 7 System with PoE
Model No.	Deco BE65-PoE
Brand Name	tp-link
Specification	WLAN: 802.11a/b/g/n/ac/ax/be WPAN: Bluetooth Single Mode
Power Supply	Power: 12Vdc, 2.0A PoE: 802.3bt PoE
EUT Identification No.:	#1-1 (Conducted) #1-2 (Radiated)
Accessory	
Power Adapter	Brand: tp-link Model No: T120200-2B4 Input: AC 100-240V~50-60Hz, 0.8A Output: 12.0V=2.0A DC Cable Out: Non-Shielded, 1.5m

2.2. Product Specification Subjective to this Standard

Operating Frequency	2402~2480MHz
Type of modulation	GFSK
Data Rate	1Mbps
Antenna Type	IFA Antenna
Antenna Gain	2.00dBi

2.3. Test Mode

Test Mode	Mode 1: Transmit - LE (GFSK)
-----------	------------------------------

Note: Regarding to the operation frequency, the lowest, middle and highest frequency are selected to perform the test.

2.4. Operation Frequency / Channel List

Channel	Frequency	Channel	Frequency	Channel	Frequency
00	2402 MHz	01	2404 MHz	02	2406 MHz
03	2408 MHz	04	2410 MHz	05	2412 MHz
06	2414 MHz	07	2416 MHz	08	2418 MHz
09	2420 MHz	10	2422 MHz	11	2424 MHz
12	2426 MHz	13	2428 MHz	14	2430 MHz
15	2432 MHz	16	2434 MHz	17	2436 MHz
18	2438 MHz	19	2440 MHz	20	2442 MHz
21	2444 MHz	22	2446 MHz	23	2448 MHz
24	2450 MHz	25	2452 MHz	26	2454 MHz
27	2456 MHz	28	2458 MHz	29	2460 MHz
30	2462 MHz	31	2464 MHz	32	2466 MHz
33	2468 MHz	34	2470 MHz	35	2472 MHz
36	2474 MHz	37	2476 MHz	38	2478 MHz
39	2480 MHz	N/A	N/A	N/A	N/A

2.5. Test Configuration

This device was tested per the guidance of ANSI C63.10-2013. ANSI C63.10-2013 was used to reference the appropriate EUT setup for radiated spurious emissions testing and AC line conducted testing.

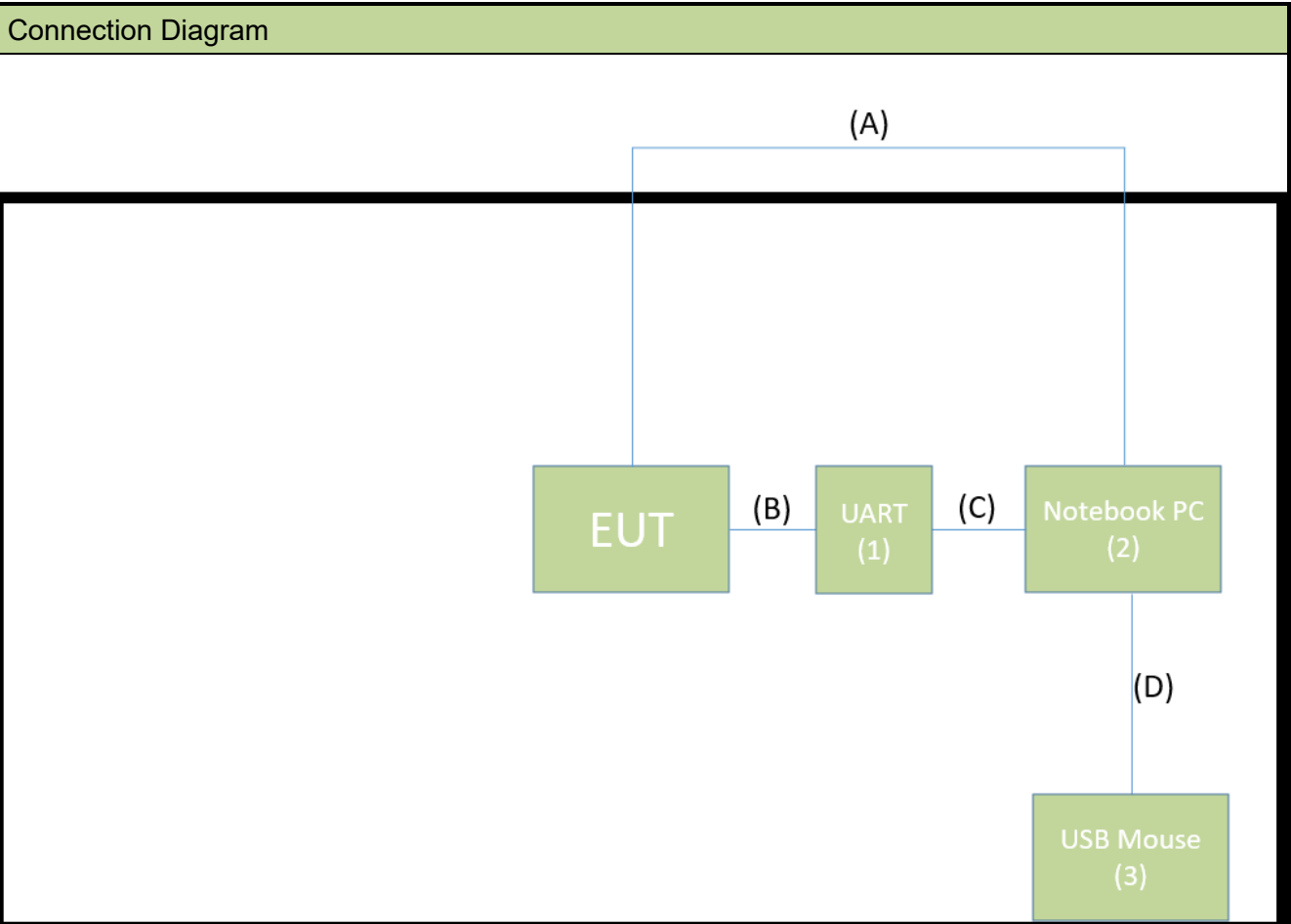

	Signal Cable Type	Signal Cable Description
A	LAN Cable	Non-shielded, 3.0m
B	Signal Cable	Non-shielded, 0.2m
C	USB Cable	Shielded, 1.0m
D	USB Mouse Cable	Shielded, 1.8m

2.6. Test System Details

The types for all equipments, plus descriptions of all cables used in the tested system (including inserted cards) are:

No.	Product	Brand	Model No.	Serial No.	Power Cord
1	UART	WCH	CH340G	N/A	N/A
2	Notebook PC	Lenovo	21H5-S0FG00	N/A	Non-shielded, 0.8m
3	USB Mouse	Logitech	M90	N/A	N/A

2.7. Test Software

The test utility software used during testing was “Tera Term v4.98”.

2.8. Duty Cycle

Test Mode	Duty Cycle
BLE-1Mbps	55%

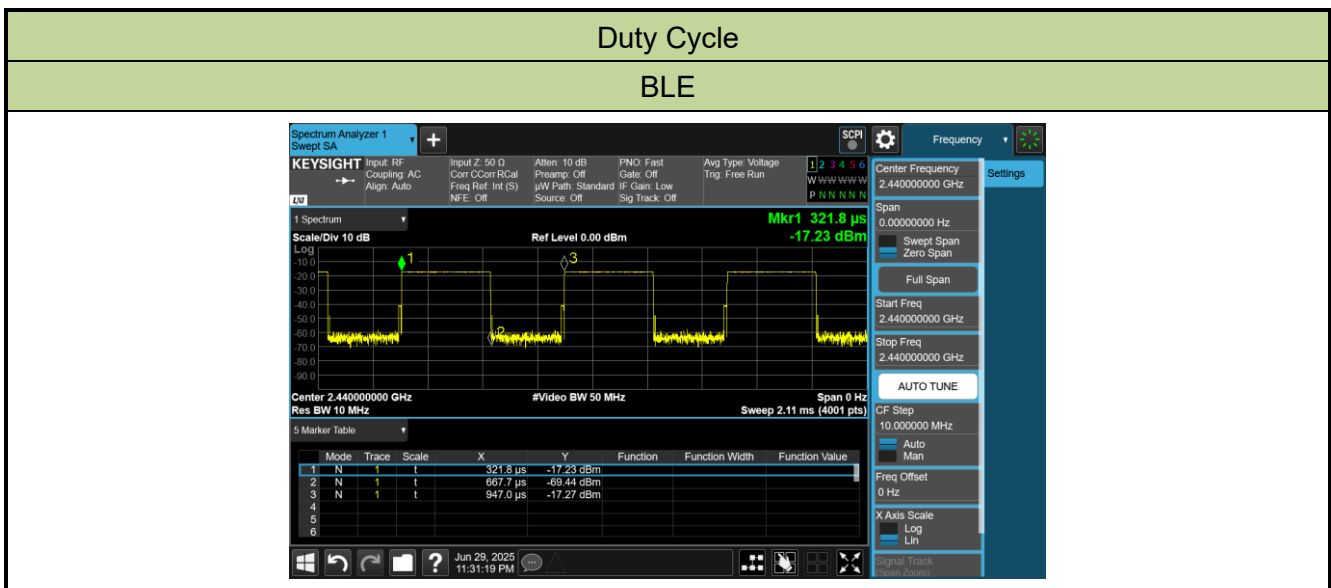

2.9. EMI Suppression Device(s)/Modifications

No EMI suppression device(s) were added and/or no modifications were made during testing.

2.10. Labeling Requirements

Per 2.1074 & 15.19; Docket 95-19

The label shall be permanently affixed at a conspicuous location on the device; instruction manual or pamphlet supplied to the user and be readily visible to the purchaser at the time of purchase.

However, when the device is so small wherein placement of the label with specified statement is not practical, only the FCC ID must be displayed on the device per Section 15.19(a)(5). Please see attachment for FCC ID label and label location.

3. DESCRIPTION of TEST

3.1. Evaluation Procedure

The measurement procedures described in the American National Standard for Testing Unlicensed Wireless Devices (ANSI C63.10-2013) was used in the measurement.

3.2. AC Line Conducted Emissions

The line-conducted facility is located inside an 9'x4'x3' shielded enclosure. A 1m x 2m wooden table 80cm high is placed 40cm away from the vertical wall and 80cm away from the sidewall of the shielded room. Two 10kHz-30MHz, 50Ω/50uH Line-Impedance Stabilization Networks (LISNs) are bonded to the shielded room floor. Power to the LISNs is filtered by external high-current high-insertion loss power line filters. These filters attenuate ambient signal noise from entering the measurement lines. These filters are also bonded to the shielded enclosure.

The EUT is powered from one LISN and the support equipment is powered from the second LISN. All interconnecting cables more than 1 meter were shortened to a 1 meter length by non-inductive bundling (serpentine fashion) and draped over the back edge of the test table. All cables were at least 40cm above the horizontal reference ground-plane. Power cables for support equipment were routed down to the second LISN while ensuring that that cables were not draped over the second LISN.

Sufficient time for the EUT, support equipment, and test equipment was allowed in order for them to warm up to their normal operating condition. The RF output of the LISN was connected to the receiver and exploratory measurements were made to determine the frequencies producing the maximum emission from the EUT. The receiver was scanned from 150kHz to 30MHz. The detector function was set to peak mode for exploratory measurements while the bandwidth of the analyzer was set to 9kHz. The EUT, support equipment, and interconnecting cables were arranged and manipulated to maximize each emission. Each emission was also maximized by varying: power lines, the mode of operation or data exchange speed, or support equipment which determined the worst-case emission. Once the worst case emissions have been identified, the one EUT cable configuration/arrangement and mode of operation that produced these emissions are used for final measurements on the same test site. The analyzer is set to CISPR quasi-peak and average detectors with a 9kHz resolution bandwidth for final measurements.

An extension cord was used to connect to a single LISN which powered by EUT. The extension cord was calibrated with LISN, the impedance and insertion loss are compliance with the requirements as stated in ANSI C63.10-2013.

Line conducted emissions test results are shown in Section 7.8.

3.3. Radiated Emissions

The radiated test facilities consisted of an indoor 3 meter semi-anechoic chamber used for final measurements and exploratory measurements, when necessary. The measurement area is contained within the semi-anechoic chamber which is shielded from any ambient interference. For measurements above 1GHz absorbers are arranged on the floor between the turn table and the antenna mast in such a way so as to maximize the reduction of reflections. For measurements below 1GHz, the absorbers are removed. A MF Model 210SS turntable is used for radiated measurement. It is a continuously rotatable, remote controlled, metallic turntable and 2 meters (6.56 ft.) in diameter. The turn table is flush with the raised floor of the chamber in order to maintain its function as a ground plane. An 80cm high PVC support structure is placed on top of the turntable.

For all measurements, the spectrum was scanned through all EUT azimuths and from 1 to 4 meter receive antenna height using a broadband antenna from 30MHz up to the upper frequency shown in 15.33(b)(1) depending on the highest frequency generated or used in the device or on which the device operates or tunes. For frequencies above 1GHz, linearly polarized double ridge horn antennas were used. For frequencies below 30MHz, a calibrated loop antenna was used. When exploratory measurements were necessary, they were performed at 1 meter test distance inside the semi-anechoic chamber using broadband antennas, broadband amplifiers, and spectrum analyzers to determine the frequencies and modes producing the maximum emissions. Sufficient time for the EUT, support equipment, and test equipment was allowed in order for them to warm up to their normal operating condition. The test set-up for frequencies below 1GHz was placed on top of the 0.8 meter high, 1 x 1.5 meter table; and test set-up for frequencies 1-40GHz was placed on top of the 1.5 meter high, 1 x 1.5 meter table. The EUT, support equipment, and interconnecting cables were arranged and manipulated to maximize each emission. Appropriate precaution was taken to ensure that all emissions from the EUT were maximized and investigated. The system configuration, clock speed, mode of operation or video resolution, if applicable, turntable azimuth, and receive antenna height was noted for each frequency found.

Final measurements were made in the semi-anechoic chamber using calibrated, linearly polarized broadband and horn antennas. The test setup was configured to the setup that produced the worst case emissions. The spectrum analyzer was set to investigate all frequencies required for testing to compare the highest radiated disturbances with respect to the specified limits. The turntable containing the EUT was rotated through 360 degrees and the height of the receive antenna was varied 1 to 4 meters and stopped at the azimuth and height producing the maximum emission. Each emission was maximized by changing the orientation of the EUT through three orthogonal planes and changing the polarity of the receive antenna, which produced the worst-case emissions. According to 3dB Beam-Width of horn antenna, the horn antenna should be always directed to the EUT when rising height.

Radiated emissions test results are shown in Section 7.6 & 7.7 .

4. ANTENNA REQUIREMENTS

Excerpt from §15.203 of the FCC Rules/Regulations:

“An intentional radiator antenna shall be designed to ensure that no antenna other than that furnished by the responsible party can be used with the device. The use of a permanently attached antenna or of an antenna that uses a unique coupling to the intentional radiator shall be considered sufficient to comply with the provisions of this section.”

- The antenna of the **BE11000 Whole Home Mesh Wi-Fi 7 System with PoE**, is permanently attached.
- There are no provisions for connection to an external antenna.

Conclusion:

The EUT unit complies with the requirement of §15.203.

5. TEST EQUIPMENT CALIBRATION DATE

Conducted Emissions – SR2

Instrument	Manufacturer	Type No.	Asset No.	Cali. Interval	Cali. Due Date
Two-Line V-Network	R&S	ENV216	MRTTWA00020	1 year	2026/4/14
Cable	Rosnol	N1C50-RG400-B 1C50-500CM	MRTTWE00013	1 year	2026/6/13
EMI Test Receiver	R&S	ESR3	MRTTWA00009	1 year	2026/3/4

Radiated Emissions – AC2

Instrument	Manufacturer	Type No.	Asset No.	Cali. Interval	Cali. Due Date
Active Loop Antenna	SCHWARZBECK	FMZB 1519B	MRTTWA00002	1 year	2026/4/16
Broadband TRILOG Antenna	SCHWARZBECK	VULB 9162	MRTTWA00086	1 year	2025/11/5
Broadband Hornantenna	SCHWARZBECK	BBHA 9120D	MRTTWA00003	1 year	2026/2/11
Broadband Preamplifier	SCHWARZBECK	BBV 9718	MRTTWA00005	1 year	2026/2/11
Breitband Hornantenna	SCHWARZBECK	BBHA 9170	MRTTWA00004	1 year	2026/3/27
Broadband Amplifier	SCHWARZBECK	BBV 9721	MRTTWA00006	1 year	2026/3/20
EMI Test Receiver	R&S	ESR3	MRTTWA00009	1 year	2026/3/4
Signal Analyzer	R&S	FSV40	MRTTWA00007	1 year	2026/5/20
Antenna Cable	HUBERSUHNER	SF106	MRTTWE00010	1 year	2026/6/13
Cable	Rosnol	K1K50-UP0264- K1K50-4M	MRTTWE00012	1 year	2026/6/13
Temperature/Humidity Meter	TFA	35.1083	MRTTWA00032	1 year	2026/6/5

Conducted Test Equipment – SR5

Instrument	Manufacturer	Type No.	Asset No.	Cali. Interval	Cali. Due Date
EXA Signal Analyzer	KEYSIGHT	N9010A	MRTTWA00012	1 year	2025/9/24
EXA Signal Analyzer	KEYSIGHT	N9010B	MRTTWA00074	1 year	2025/8/12
USB Wideband Power Sensor	KEYSIGHT	U2021XA	MRTTWA00015	1 year	2026/3/11

Test Software

Software	Version	Function
e3	9.160520a	EMI Test Software
EMI	V3	EMI Test Software

6. MEASUREMENT UNCERTAINTY

Where relevant, the following test uncertainty levels have been estimated for tests performed on the EUT as specified in CISPR 16-4-2. This uncertainty represents an expanded uncertainty expressed at approximately the 95% confidence level using a coverage factor of $k = 2$.

Conducted Emission- Power Line
Measuring Uncertainty for a Level of Confidence of 95% ($U=2Uc(y)$): 0.15MHz~30MHz: $\pm 2.53\text{dB}$
Radiated Spurious Emission
Measuring Uncertainty for a Level of Confidence of 95% ($U=2Uc(y)$): 9kHz~30MHz: $\pm 3.92\text{dB}$ 30MHz~1GHz: $\pm 4.25\text{dB}$ 1GHz~18GHz: $\pm 4.40\text{dB}$ 18GHz~40GHz: $\pm 4.45\text{dB}$
Frequency Error
Measuring Uncertainty for a Level of Confidence of 95% ($U=2Uc(y)$): $\pm 78.4\text{Hz}$
Conducted Power
Measuring Uncertainty for a Level of Confidence of 95% ($U=2Uc(y)$): $\pm 0.84\text{dB}$
Conducted Spurious Emission
Measuring Uncertainty for a Level of Confidence of 95% ($U=2Uc(y)$): $\pm 2.65\text{ dB}$
Occupied Bandwidth
Measuring Uncertainty for a Level of Confidence of 95% ($U=2Uc(y)$): $\pm 3.3\%$
Temp. / Humidity
Measuring Uncertainty for a Level of Confidence of 95% ($U=2Uc(y)$): $\pm 0.82^\circ\text{C}/ \pm 3\%$
DC Voltage
Measuring Uncertainty for a Level of Confidence of 95% ($U=2Uc(y)$): $\pm 0.3\%$

7. TEST RESULT

7.1. Summary

Product Name: BE11000 Whole Home Mesh Wi-Fi 7 System with PoE

FCC Classification: (DTS) Digital Transmission System

FCC Part Section(s)	Test Description	Test Limit	Test Condition	Test Result	Reference
15.247(a)(2)	6dB Bandwidth	$\geq 500\text{kHz}$	Conducted	Pass	Section 7.2
15.247(b)(3)	Output Power	$\leq 30.00\text{dBm}$		Pass	Section 7.3
15.247(e)	Power Spectral Density	$\leq 8.00\text{dBm}/3\text{kHz}$		Pass	Section 7.4
15.247(d)	Out-of-Band Emissions	Conducted $\geq 30\text{dBc}$		Pass	Section 7.5
15.205 15.209	Spurious Emission	< FCC 15.209 limits	Radiated	Pass	Section 7.6
15.205 15.209	Band Edge Measurement	$\cong 74\text{dBuV/m(Peak)}$ $\cong 54\text{dBuV/m(Average)}$		Pass	Section 7.7
15.207	AC Conducted Emissions 150kHz - 30MHz	< FCC 15.207 limits	Line Conducted	Pass	Section 7.8

Notes:

- 1) Determining compliance is based on the test results met the regulation limits or requirements declared by clients, and the test results don't take into account the value of measurement uncertainty.
- 2) For radiated emission test, every axis (X, Y, Z) was also verified when applicable. The test results shown in the following sections represent the worst case emissions.
- 3) The analyzer plots shown in this section were all taken with a correction table loaded into the analyzer. The correction table was used to account for the losses of the cables and attenuators used as part of the system to connect the EUT to the analyzer at all frequencies of interest.

7.2. 6dB Bandwidth Measurement

7.2.1. Test Limit

The minimum 6dB bandwidth shall be at least 500 kHz.

7.2.2. Test Procedure used

ANSI C63.10 - 2013 Section 11.8

7.2.3. Test Setting

1. The Spectrum's automatic bandwidth measurement capability was used to perform the 6dB bandwidth measurement. The "X" dB bandwidth parameter was set to $X = 6$. The bandwidth measurement was not influenced by any intermediate power nulls in the fundamental emission.
2. Set RBW = 100 kHz
3. $VBW \geq 3 \times RBW$
4. Detector = Peak
5. Trace mode = max hold
6. Sweep = auto couple
7. Allow the trace was allowed to stabilize

7.2.4. Test Setup

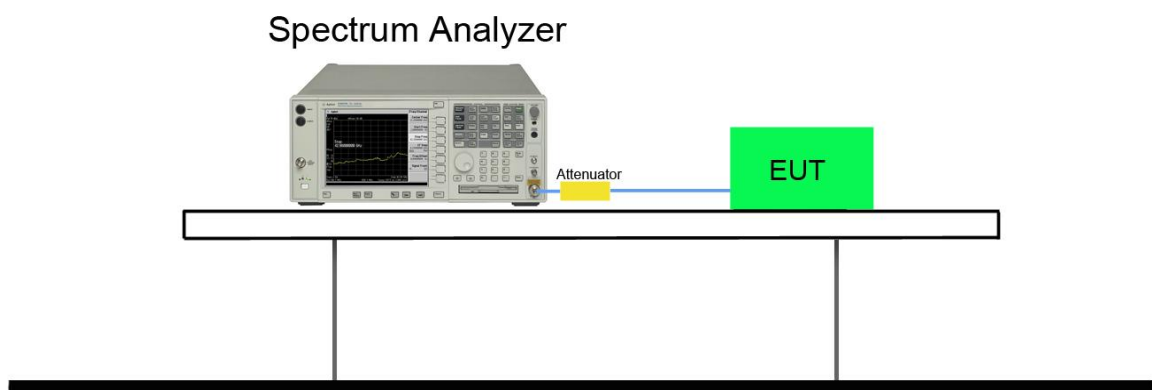

7.2.5. Test Result

Product	BE11000 Whole Home Mesh Wi-Fi 7 System with PoE	Temperature	25°C
Test Engineer	Yang	Relative Humidity	54%
Test Site	SR6	Test Date	2025/7/8

Test Mode	Channel No.	Frequency (MHz)	6dB Bandwidth (MHz)	Limit (MHz)	Result
LE	00	2402	0.6598	≥ 0.5	Pass
LE	19	2440	0.6624	≥ 0.5	Pass
LE	39	2480	0.6526	≥ 0.5	Pass

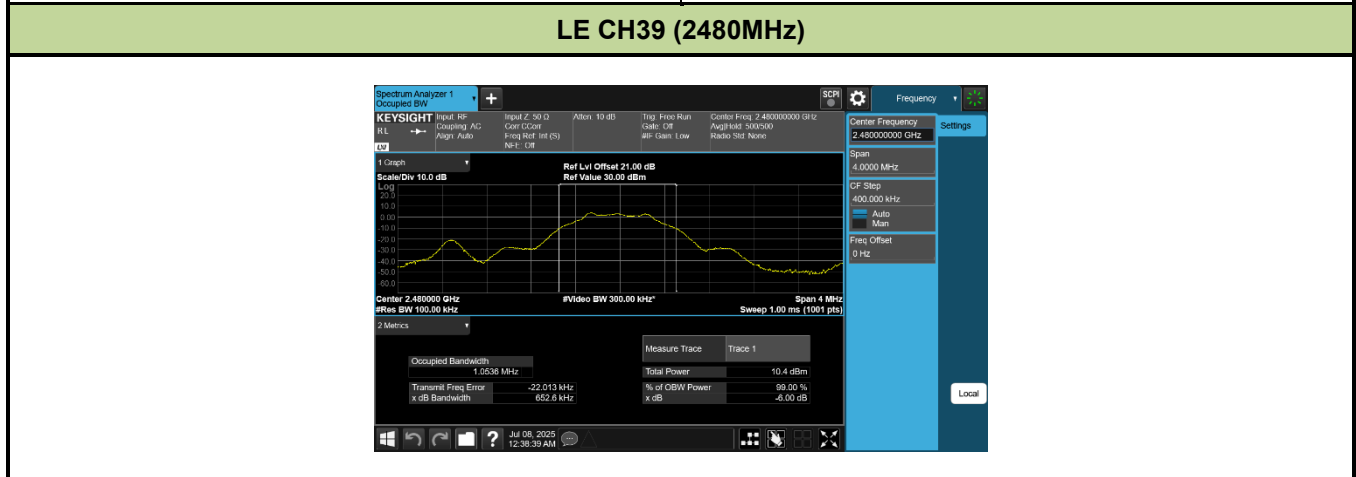
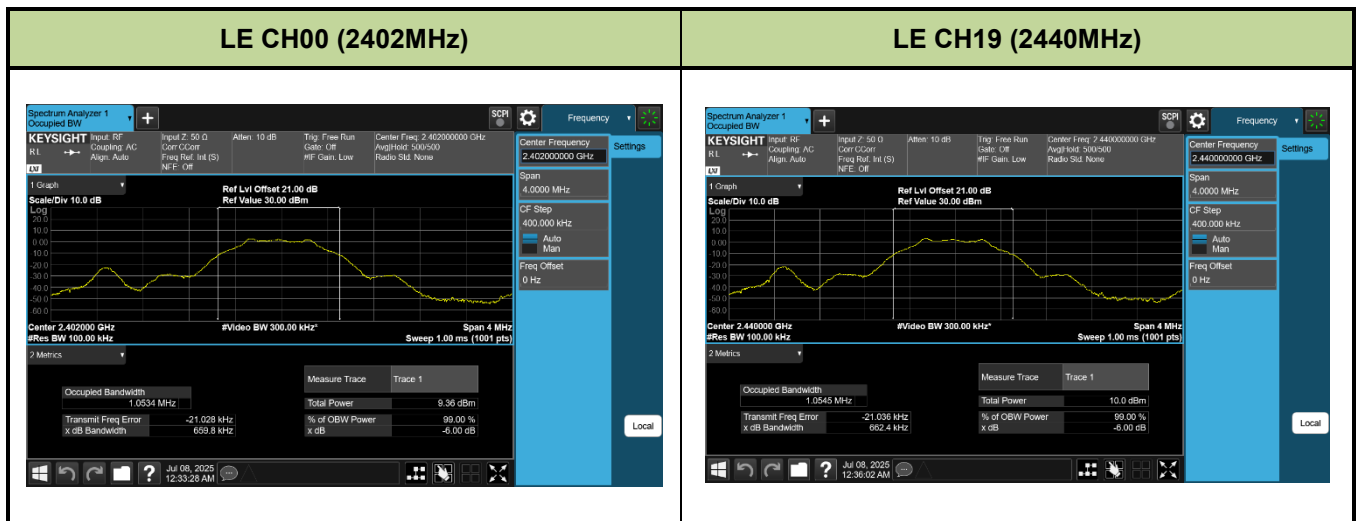

7.3. Output Power Measurement

7.3.1. Test Limit

The maximum out power shall be less 1 Watt (30dBm).

The conducted output power limit specified in paragraph FCC Part 15.247(b) of this section is based on the use of antennas with directional gains that do not exceed 6 dBi. If transmitting antennas of directional gain greater than 6 dBi are used, the conducted output power from the intentional radiator shall be reduced below the stated values in paragraphs FCC Part 15.247(b)(3) of this section, as appropriate, by the amount in dB that the directional gain of the antenna exceeds 6 dBi.

7.3.2. Test Procedure Used

ANSI C63.10 - 2013 Section 11.9.2.3.2

7.3.3. Test Setting

Average Power Measurement

Average power measurements were performed only when the EUT was transmitting at its maximum power control level using a broadband power meter with a pulse sensor. The power meter implemented triggering and gating capabilities which were set up such that power measurements were recorded only during the ON time of the transmitter. The trace was averaged over 100 traces to obtain the final measured average power.

7.3.4. Test Setup

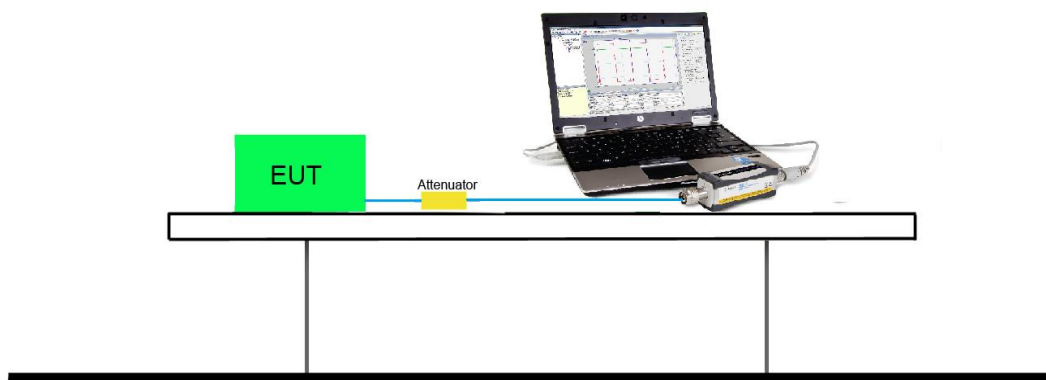

7.3.5. Test Result of Output Power

Product	BE11000 Whole Home Mesh Wi-Fi 7 System with PoE	Temperature	25°C
Test Engineer	Yang	Relative Humidity	54%
Test Site	SR6	Test Date	2025/7/8

Test Mode	Channel No.	Frequency (MHz)	Average Power (dBm)	Peak Power (dBm)	Power Limit (dBm)
LE	00	2402	2.96	3.47	< 30
LE	19	2440	3.5	4.06	< 30
LE	39	2480	3.88	4.48	< 30

Note1: Output power = Reading value on power meter + cable loss.

Note2: Antenna Gain: 2dBi.

7.4. Power Spectral Density Measurement

7.4.1. Test Limit

The maximum permissible power spectral density is 8dBm in any 3 kHz band.

7.4.2. Test Procedure Used

ANSI C63.10 - 2013 Section 11.10.5

7.4.3. Test Setting

1. Measure the duty cycle (x) of the transmitter output signal.
2. Set instrument center frequency to DTS channel center frequency.
3. Set span to at least 1.5 times the OBW.
4. RBW = 10 kHz.
5. VBW = 30 kHz.
6. Detector = RMS.
7. Ensure that the number of measurement points in the sweep $\geq 2 \times \text{span}/\text{RBW}$.
8. Sweep time = auto couple.
9. Don't use sweep triggering. Allow sweep to "free run".
10. Employ trace averaging (RMS) mode over a minimum of 100 traces.
11. Use the peak marker function to determine the maximum amplitude level.
12. Add $10 \log (1/x)$, where x is the duty cycle measured in step (a), to the measured PSD to compute the average PSD during the actual transmission time.

7.4.4. Test Setup

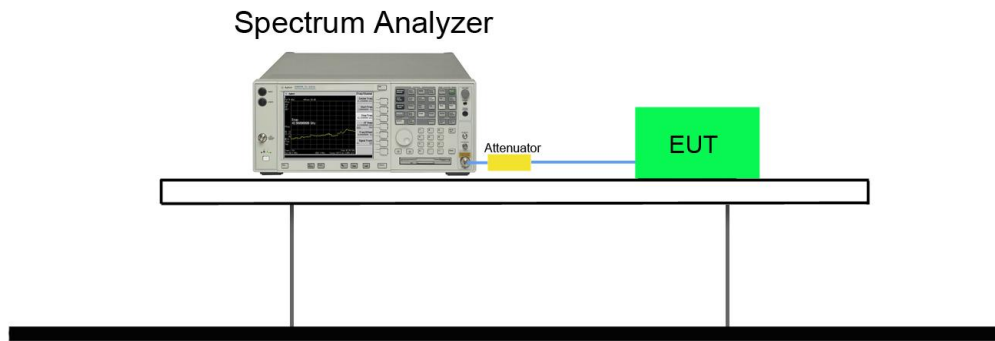

7.4.5. Test Result

Product	BE11000 Whole Home Mesh Wi-Fi 7 System with PoE	Temperature	25°C
Test Engineer	Yang	Relative Humidity	54%
Test Site	SR6	Test Date	2025/7/8

Test Mode	Channel No.	Frequency (MHz)	PSD (dBm / 10kHz)	Duty Cycle (%)	Total Average PSD (dBm / 10kHz)	Limit (dBm / 3kHz)	Result
LE	00	2402	-14.094	55.33%	-11.524	≤ 8	Pass
LE	19	2440	-12.787	55.33%	-10.217	≤ 8	Pass
LE	39	2480	-13.242	55.33%	-10.672	≤ 8	Pass

Note: Total Average PSD= Average PSD + 10*log (1/Duty cycle).

LE CH00 (2402MHz)



LE CH19 (2440MHz)



LE CH39 (2480MHz)

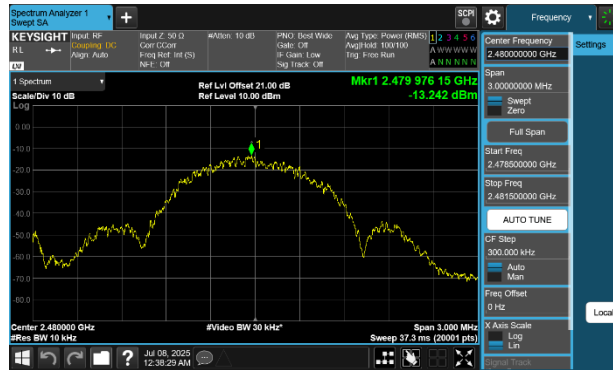

7.5. Out-of-Band Spurious Emissions Emissions Measurement

7.5.1. Test Limit

In any 100 kHz bandwidth outside the frequency band in which the spread spectrum or digitally modulated intentional radiator is operating, the radio frequency power that is produced by the intentional radiator shall be at least 30 dB below that in the 100 kHz bandwidth within the band that contains the highest level of the desired power, based on RF conducted measurement, provided the transmitter demonstrates compliance with the peak conducted power limits.

7.5.2. Test Procedure Used

ANSI C63.10 - 2013 Section 11.11 & 11.2

7.5.3. Test Setting

- (a) Set instrument center frequency to DTS channel center frequency
- (b) Set the span to ≥ 1.5 times the DTS bandwidth
- (c) Set the RBW = 100 kHz
- (d) Set the VBW $\geq 3 \times$ RBW
- (e) Detector = peak
- (f) Sweep time = auto couple
- (g) Trace mode = max hold
- (h) Allow trace to fully stabilize

7.5.4. Test Setup

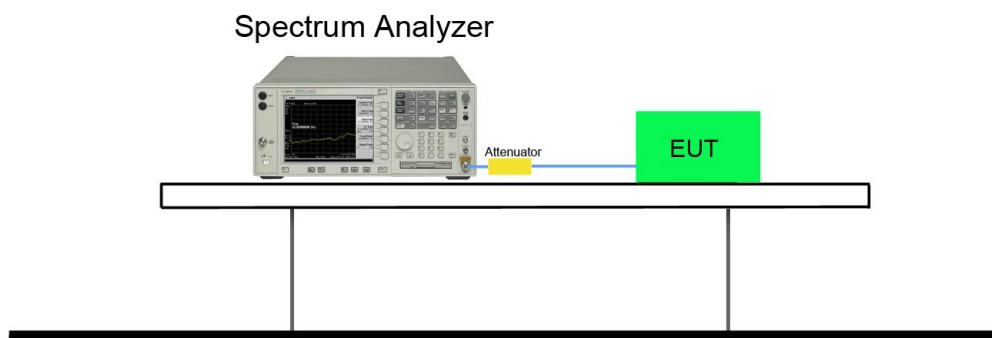

7.5.5. Test Result

Product	BE11000 Whole Home Mesh Wi-Fi 7 System with PoE	Temperature	25°C
Test Engineer	Yang	Relative Humidity	54%
Test Site	SR6	Test Date	2025/7/8

Test Mode	Channel No.	Frequency (MHz)	Limit	Result
LE	00	2402	30dBc	Pass
LE	19	2440	30dBc	Pass
LE	39	2480	30dBc	Pass

CH00 (2402MHz) LE(1Mbps)

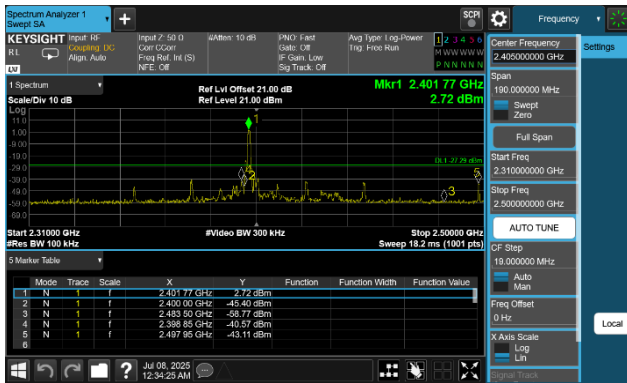

CH00 (2402MHz) LE(1Mbps)

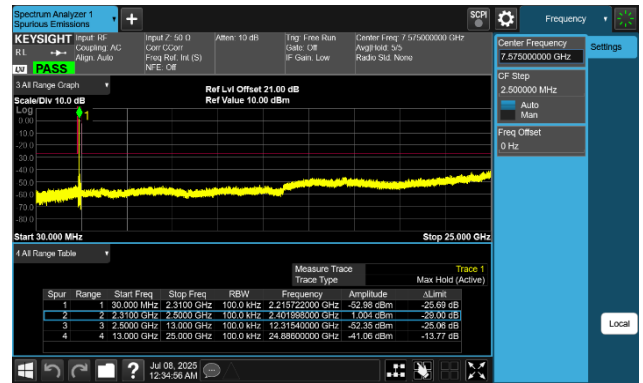

CH19 (2440MHz) LE(1Mbps)

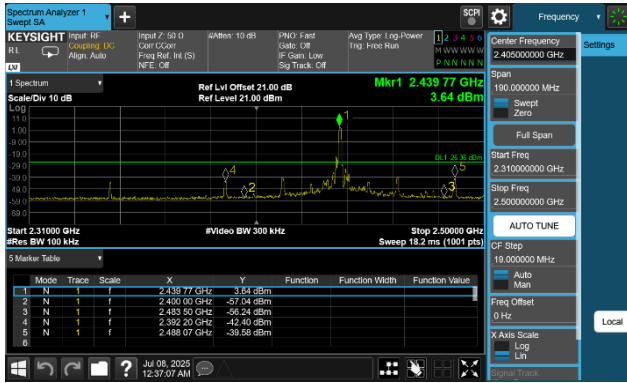

CH19 (2440MHz) LE(1Mbps)

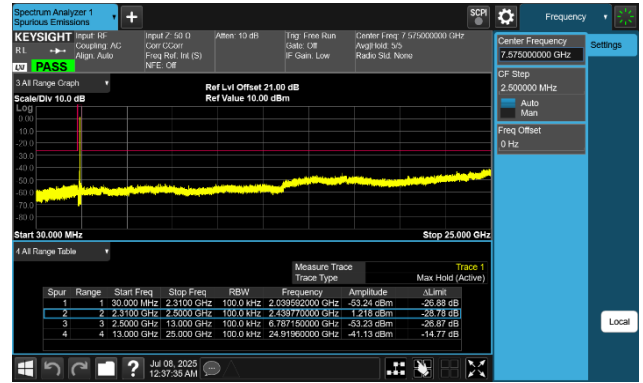

CH39 (2480MHz) LE(1Mbps)

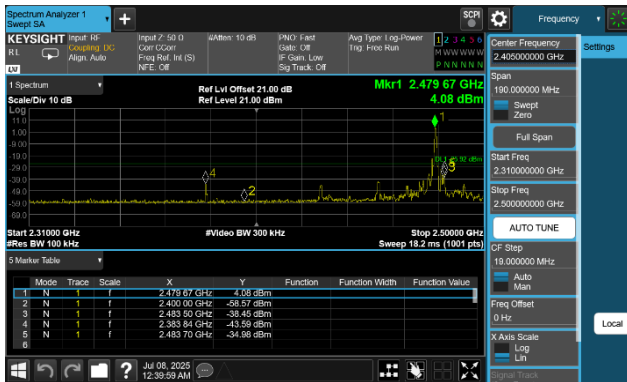

CH39 (2480MHz) LE(1Mbps)

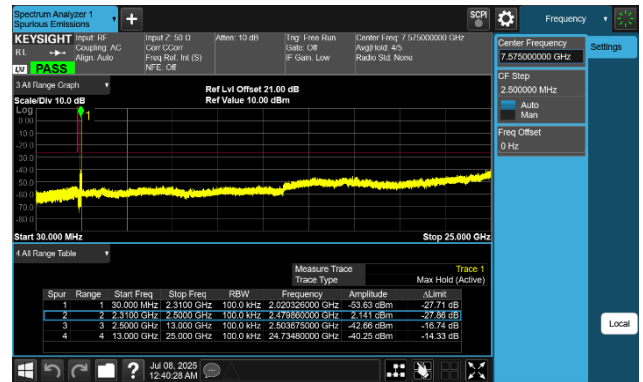

7.6. Radiated Spurious Emission Measurement

7.6.1. Test Limit

All out of band emissions appearing in a restricted band as specified in Section 15.205 of the Title 47 CFR must not exceed the limits shown in Table per Section 15.209.

FCC Part 15 Subpart C Paragraph 15.209		
Frequency [MHz]	Field Strength [V/m]	Measured Distance [Meters]
0.009 - 0.490	2400/F (kHz)	300
0.490 - 1.705	24000/F (kHz)	30
1.705 - 30	30	30
30 - 88	100	3
88 - 216	150	3
216 - 960	200	3
Above 960	500	3

7.6.2. Test Procedure Used

ANSI C63.10 - 2013 Section 6.3 (General Requirements)

ANSI C63.10 - 2013 Section 6.4 (Standard test method below 30MHz)

ANSI C63.10 - 2013 Section 6.5 (Standard test method above 30MHz to 1GHz)

ANSI C63.10 - 2013 Section 6.6 (Standard test method above 1GHz)

7.6.3. Test Setting

Peak Field Strength Measurements

1. Analyzer center frequency was set to the frequency of the radiated spurious emission of interest
2. RBW = as specified in Table 1
3. VBW = 3MHz
4. Detector = peak

5. Sweep time = auto couple
6. Trace mode = max hold
7. Trace was allowed to stabilize

Table 1 - RBW as a function of frequency

Frequency	RBW
9 ~ 150 kHz	200 ~ 300 Hz
0.15 ~ 30 MHz	9 ~ 10 kHz
30 ~ 1000 MHz	100 ~ 120 kHz
> 1000 MHz	1 MHz

Average Field Strength Measurements

1. Analyzer center frequency was set to the frequency of the radiated spurious emission of interest
2. RBW = 1MHz
3. VBW \geq 1/T
4. De As an alternative, the instrument may be set to linear detector mode. Ensure that video filtering is applied in linear voltage domain (rather than in a log or dB domain). Some instruments require linear display mode in order to accomplish this. Others have a setting for Average-VBW Type, which can be set to "Voltage" regardless of the display mode
5. Detector = Peak
6. Sweep time = auto
7. Trace mode = max hold
8. Allow max hold to run for at least 50 times (1/duty cycle) traces

7.6.4. Test Setup

9kHz ~ 30MHz Test Setup:

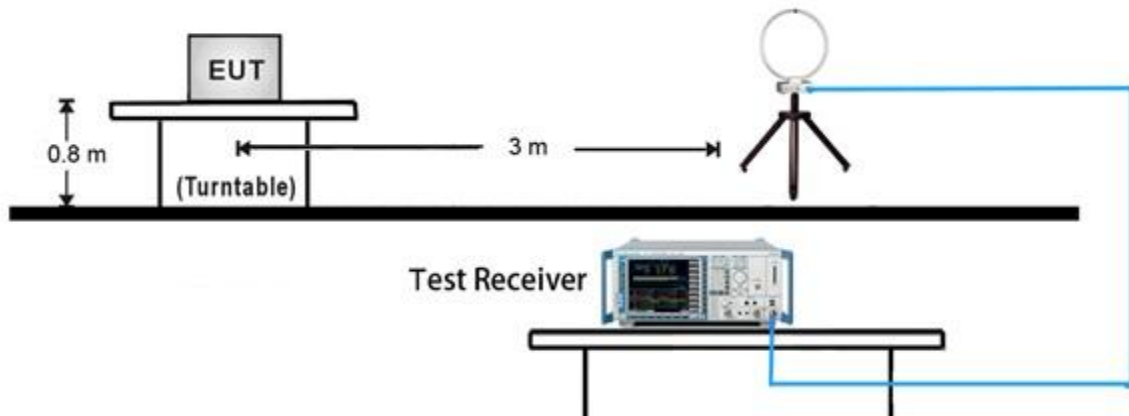

30MHz ~ 1GHz Test Setup:

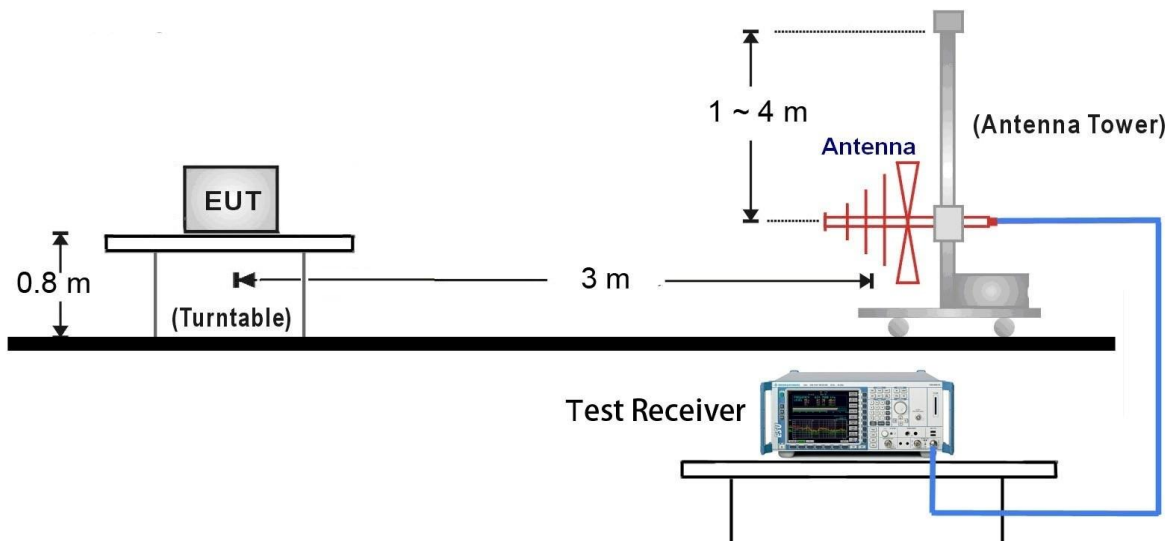

1GHz ~ 25GHz Test Setup:

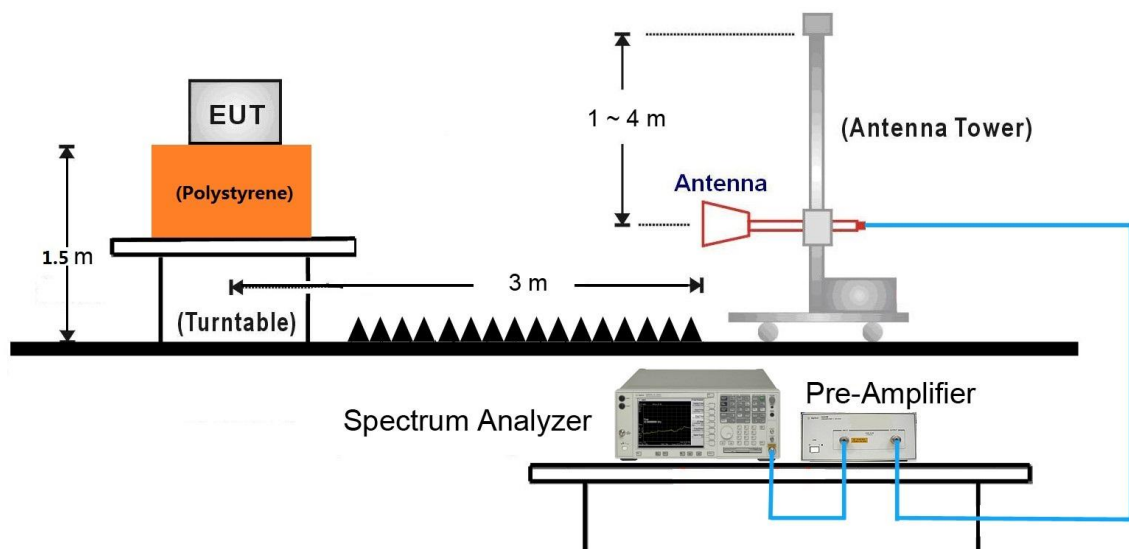

7.6.5. Test Result

EUT	BE11000 Whole Home Mesh Wi-Fi 7 System with PoE	Date of Test	2025-07-10
Factor	VULB 9162	Temp. / Humidity	25°C /67%
Polarity	Horizontal	Site / Test Engineer	AC1 / Tim
Test Mode	BLE_TX_1Mbps_CH 19	Test Voltage	AC 120V/60Hz

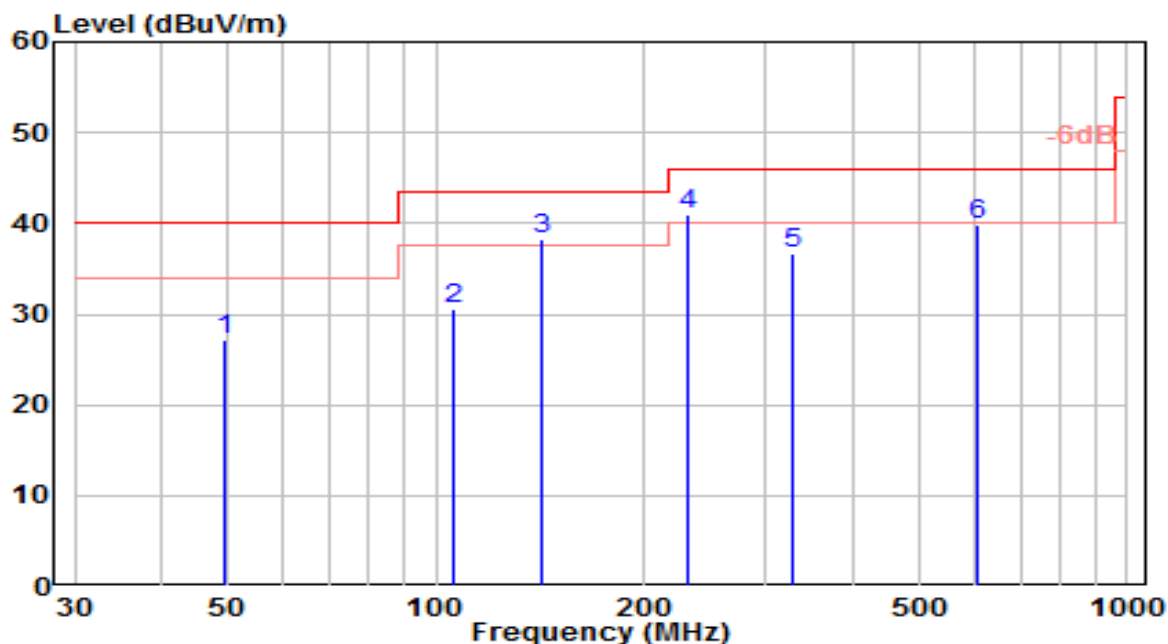

No	Frequency (MHz)	Reading (dBuV)	C.F (dB/m)	Measurement (dBuV/m)	Margin (dB)	Limit (dBuV/m)	Height (cm)	Angle (deg)	Remark (QP/PK/AV)
1	49.590	6.02	21.22	27.24	-12.76	40.00	100	260	QP
2	106.042	11.76	18.80	30.55	-12.95	43.50	150	90	QP
3	142.524	22.88	15.34	38.22	-5.28	43.50	150	85	QP
4	* 231.670	21.32	19.62	40.94	-5.06	46.00	100	260	QP
5	326.996	14.65	22.14	36.79	-9.21	46.00	100	125	QP
6	607.298	12.44	27.38	39.82	-6.18	46.00	100	335	QP

Note:

- "*", means this data is the worst emission level.
- C.F (Correction Factor) = Antenna Factor (dB/m) + Cable Loss (dB).
- Measurement (dBuV/m) = Reading(dBuV) + C.F (Correction Factor).
- The emission levels of other frequencies are very lower than the limit and not show in test report.
- The amplitude of radiated emissions (frequency range from 9kHz to 30MHz) is that proximity to ambient noise, which also are attenuated more than 20dB below the permissible value. Therefore, the data is not presented in the report.

EUT	BE11000 Whole Home Mesh Wi-Fi 7 System with PoE	Date of Test	2025-07-10
Factor	VULB 9162	Temp. / Humidity	25°C /67%
Polarity	Vertical	Site / Test Engineer	AC1 / Tim
Test Mode	BLE_TX_1Mbps_CH 19	Test Voltage	AC 120V/60Hz

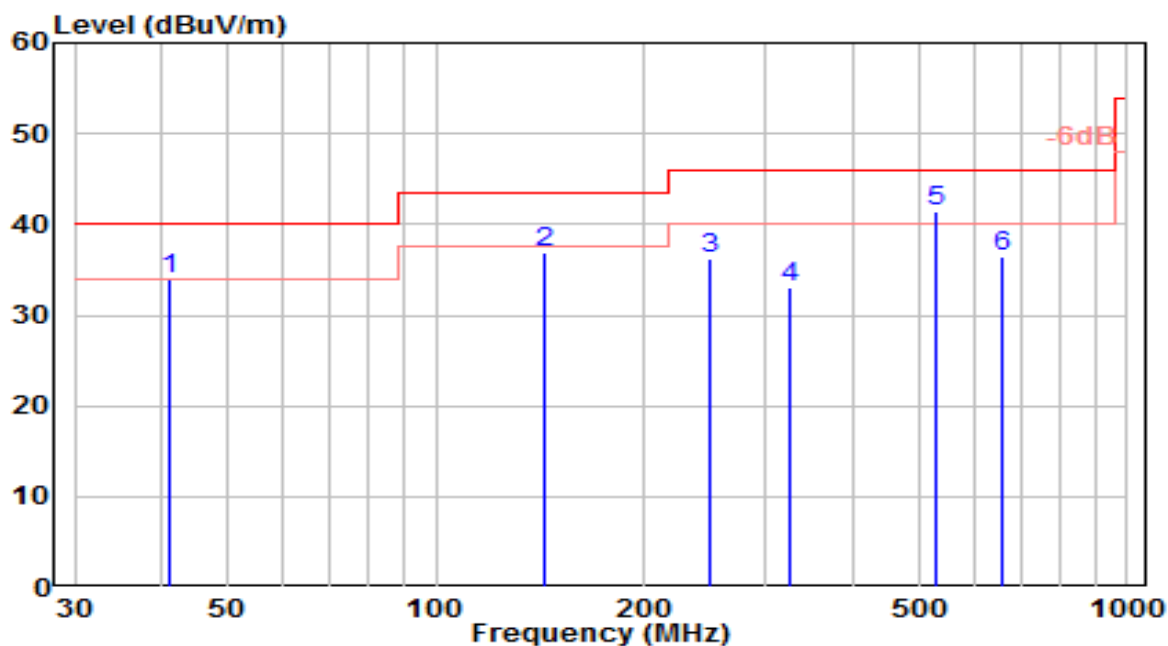

No	Frequency (MHz)	Reading (dBUV)	C.F (dB/m)	Measurement (dBUV/m)	Margin (dB)	Limit (dBUV/m)	Height (cm)	Angle (deg)	Remark (QP/PK/AV)
1	41.192	13.72	20.31	34.03	-5.97	40.00	100	105	QP
2	143.261	21.48	15.36	36.84	-6.66	43.50	100	320	QP
3	248.677	15.90	20.36	36.26	-9.74	46.00	150	360	QP
4	325.639	10.98	22.09	33.07	-12.93	46.00	100	305	QP
5 *	528.952	15.53	25.84	41.37	-4.63	46.00	100	285	QP
6	657.449	9.53	27.00	36.53	-9.47	46.00	100	160	QP

Note:

- " *", means this data is the worst emission level.
- C.F (Correction Factor) = Antenna Factor (dB/m) + Cable Loss (dB).
- Measurement (dBUV/m) = Reading(dBUV) + C.F (Correction Factor).
- The emission levels of other frequencies are very lower than the limit and not show in test report.
- The amplitude of radiated emissions (frequency range from 9kHz to 30MHz) is that proximity to ambient noise, which also are attenuated more than 20dB below the permissible value. Therefore, the data is not presented in the report.

EUT	BE11000 Whole Home Mesh Wi-Fi 7 System with PoE	Date of Test	2025-07-02
Factor	BBHA 9120D	Temp. / Humidity	23°C /60%
Polarity	Horizontal	Site / Test Engineer	AC1 / James
Test Mode	BLE_TX_1Mbps_CH 0	Test Voltage	AC 120V/60Hz

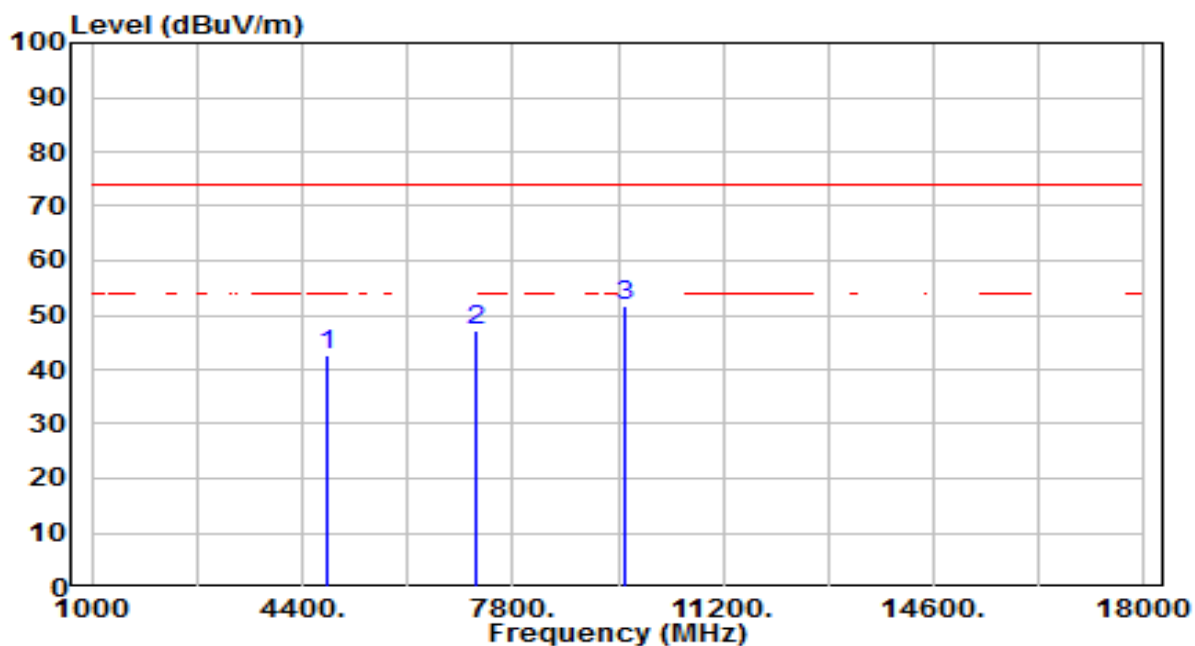

No	Frequency (MHz)	Reading (dBuV)	C.F (dB/m)	Measurement (dBuV/m)	Margin (dB)	Limit (dBuV/m)	Height (cm)	Angle (deg)	Remark (QP/PK/AV)
1	4804.000	38.39	4.30	42.69	-31.31	74.00	300	263	Peak
2	7206.000	34.58	12.57	47.15	-26.85	74.00	300	180	Peak
3	* 9608.000	34.84	16.69	51.53	-22.47	74.00	300	318	Peak

Note:

- "*", means this data is the worst emission level.
- C.F (Correction Factor) = Antenna Factor (dB/m) + Cable Loss (dB) – Preamplifier(dB).
- Measurement (dBuV/m) = Reading(dBuV) + C.F (Correction Factor).
- The emission levels of other frequencies are very lower than the limit and not show in test report.

EUT	BE11000 Whole Home Mesh Wi-Fi 7 System with PoE	Date of Test	2025-07-02
Factor	BBHA 9120D	Temp. / Humidity	23°C /60%
Polarity	Vertical	Site / Test Engineer	AC1 / James
Test Mode	BLE_TX_1Mbps_CH 0	Test Voltage	AC 120V/60Hz

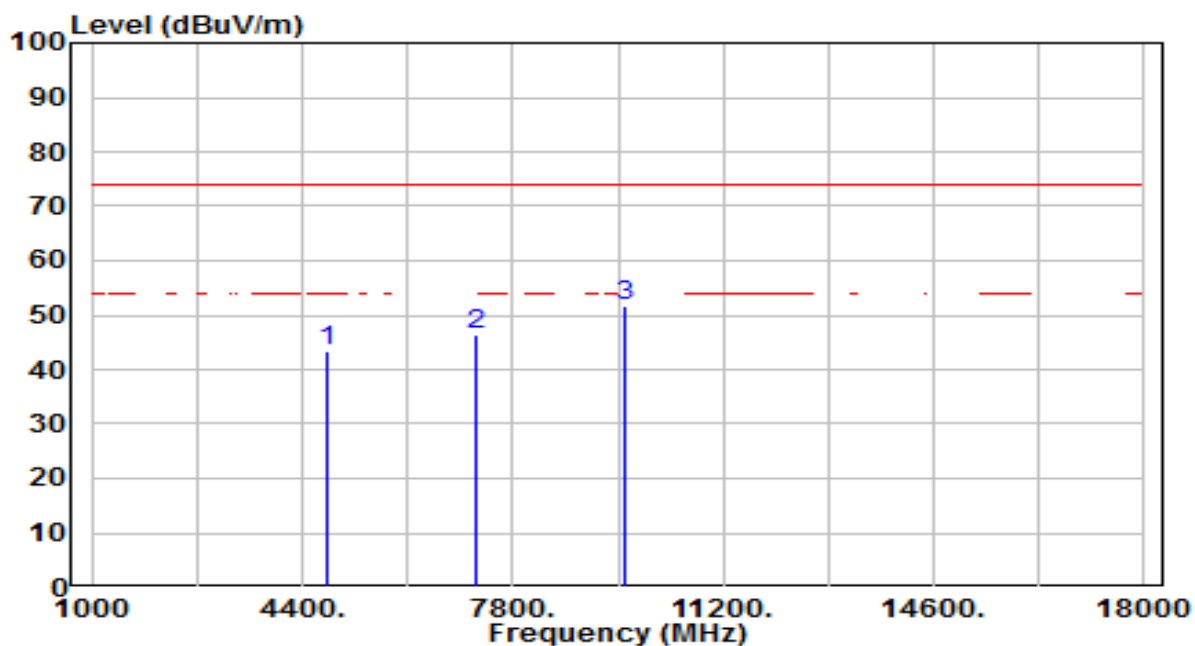

No	Frequency (MHz)	Reading (dBuV)	C.F (dB/m)	Measurement (dBuV/m)	Margin (dB)	Limit (dBuV/m)	Height (cm)	Angle (deg)	Remark (QP/PK/AV)
1	4804.000	38.93	4.30	43.23	-30.77	74.00	300	74	Peak
2	7206.000	33.74	12.57	46.31	-27.69	74.00	300	292	Peak
3	* 9608.000	35.19	16.69	51.88	-22.12	74.00	300	230	Peak

Note:

- "*", means this data is the worst emission level.
- C.F (Correction Factor) = Antenna Factor (dB/m) + Cable Loss (dB) – Preamplifier(dB).
- Measurement (dBuV/m) = Reading(dBuV) + C.F (Correction Factor).
- The emission levels of other frequencies are very lower than the limit and not show in test report.

EUT	BE11000 Whole Home Mesh Wi-Fi 7 System with PoE	Date of Test	2025-07-02
Factor	BBHA 9120D	Temp. / Humidity	23°C /60%
Polarity	Horizontal	Site / Test Engineer	AC1 / James
Test Mode	BLE_TX_1Mbps_CH 19	Test Voltage	AC 120V/60Hz

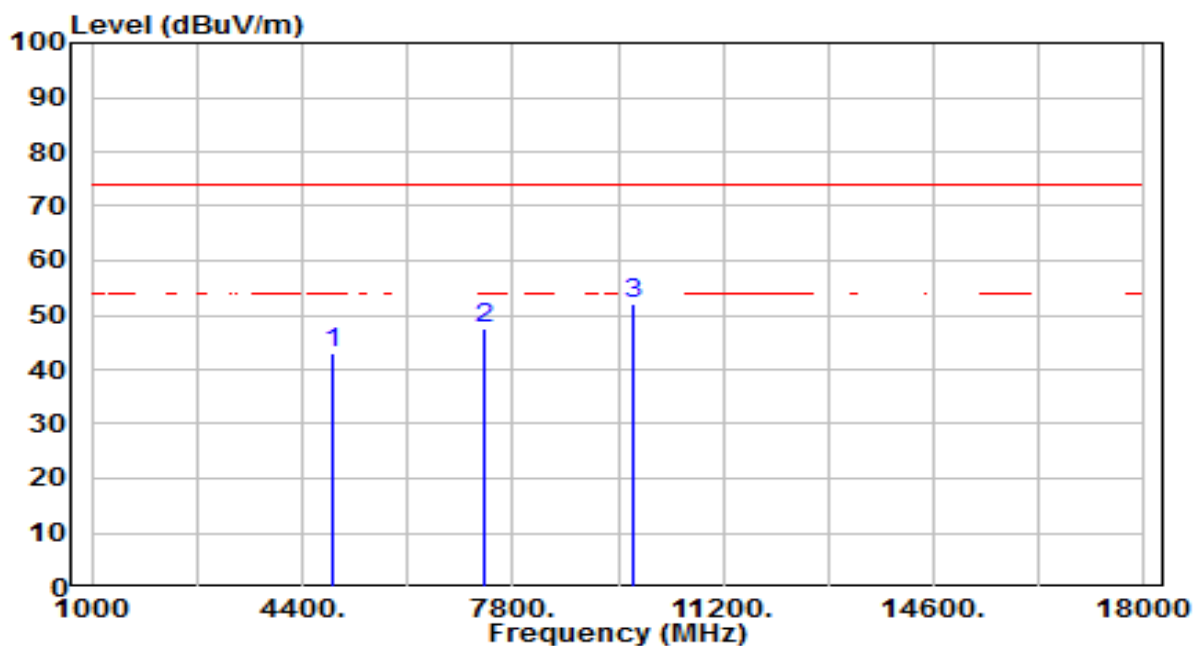

No	Frequency (MHz)	Reading (dBuV)	C.F (dB/m)	Measurement (dBuV/m)	Margin (dB)	Limit (dBuV/m)	Height (cm)	Angle (deg)	Remark (QP/PK/AV)
1	4880.000	38.52	4.48	43.00	-31.00	74.00	300	252	Peak
2	7320.000	34.20	13.17	47.37	-26.63	74.00	300	330	Peak
3	* 9760.000	35.00	16.95	51.95	-22.05	74.00	300	344	Peak

Note:

- "*", means this data is the worst emission level.
- C.F (Correction Factor) = Antenna Factor (dB/m) + Cable Loss (dB) – Preamplifier(dB).
- Measurement (dBuV/m) = Reading(dBuV) + C.F (Correction Factor).
- The emission levels of other frequencies are very lower than the limit and not show in test report.

EUT	BE11000 Whole Home Mesh Wi-Fi 7 System with PoE	Date of Test	2025-07-02
Factor	BBHA 9120D	Temp. / Humidity	23°C /60%
Polarity	Vertical	Site / Test Engineer	AC1 / James
Test Mode	BLE_TX_1Mbps_CH 19	Test Voltage	AC 120V/60Hz

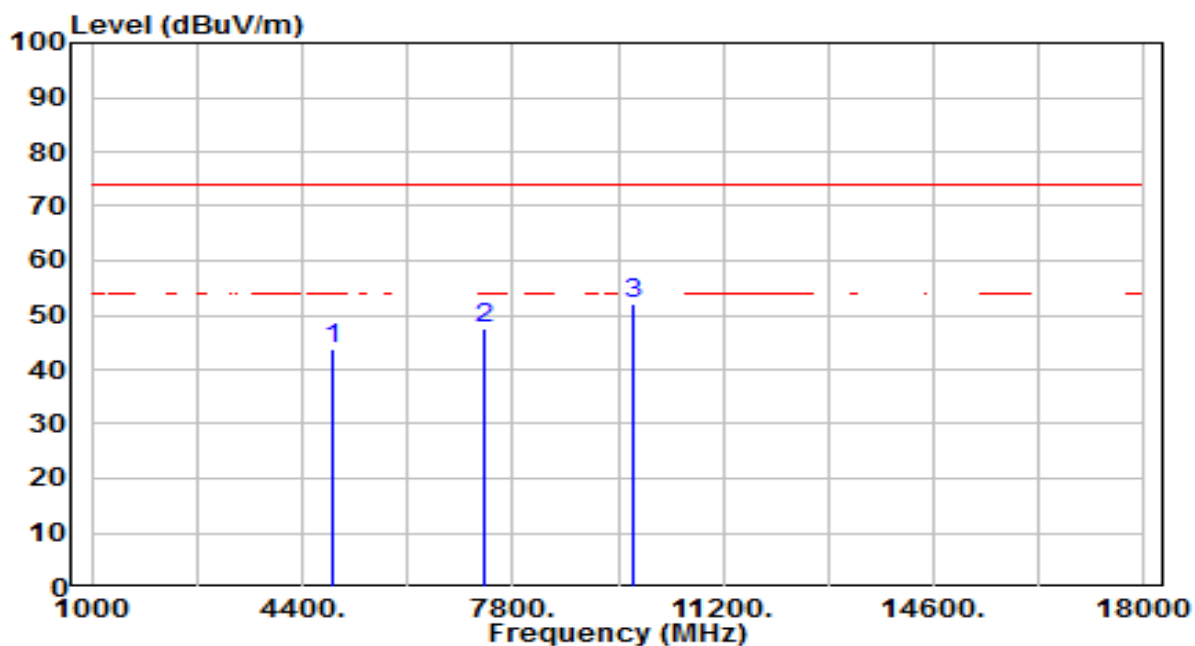

No	Frequency (MHz)	Reading (dBuV)	C.F (dB/m)	Measurement (dBuV/m)	Margin (dB)	Limit (dBuV/m)	Height (cm)	Angle (deg)	Remark (QP/PK/AV)
1	4880.000	39.12	4.48	43.59	-30.41	74.00	300	255	Peak
2	7320.000	34.49	13.17	47.66	-26.34	74.00	300	139	Peak
3	* 9760.000	35.27	16.95	52.21	-21.79	74.00	300	17	Peak

Note:

- "*", means this data is the worst emission level.
- C.F (Correction Factor) = Antenna Factor (dB/m) + Cable Loss (dB) – Preamplifier(dB).
- Measurement (dBuV/m) = Reading(dBuV) + C.F (Correction Factor).
- The emission levels of other frequencies are very lower than the limit and not show in test report.

EUT	BE11000 Whole Home Mesh Wi-Fi 7 System with PoE	Date of Test	2025-07-02
Factor	BBHA 9120D	Temp. / Humidity	23°C /60%
Polarity	Horizontal	Site / Test Engineer	AC1 / James
Test Mode	BLE_TX_1Mbps_CH 39	Test Voltage	AC 120V/60Hz

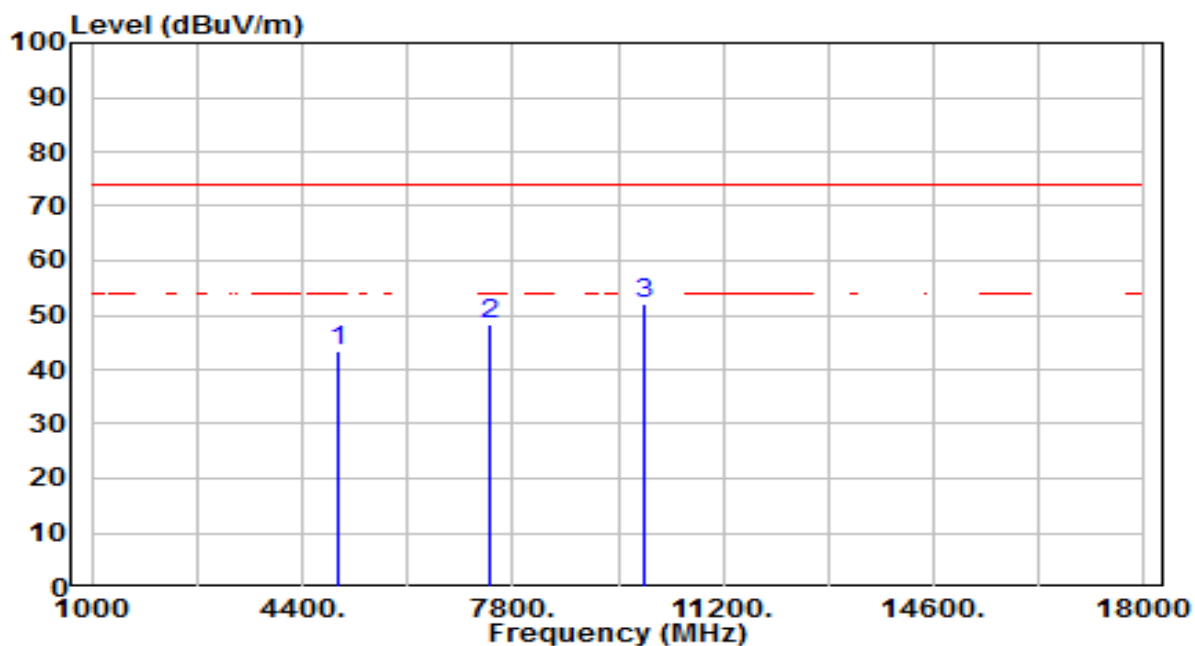

No	Frequency (MHz)	Reading (dBuV)	C.F (dB/m)	Measurement (dBuV/m)	Margin (dB)	Limit (dBuV/m)	Height (cm)	Angle (deg)	Remark (QP/PK/AV)
1	4960.000	38.51	4.75	43.26	-30.74	74.00	300	330	Peak
2	7440.000	34.60	13.78	48.38	-25.62	74.00	300	214	Peak
3	* 9920.000	34.86	17.28	52.14	-21.86	74.00	300	32	Peak

Note:

- "*", means this data is the worst emission level.
- C.F (Correction Factor) = Antenna Factor (dB/m) + Cable Loss (dB) – Preamplifier(dB).
- Measurement (dBuV/m) = Reading(dBuV) + C.F (Correction Factor).
- The emission levels of other frequencies are very lower than the limit and not show in test report.

EUT	BE11000 Whole Home Mesh Wi-Fi 7 System with PoE	Date of Test	2025-07-02
Factor	BBHA 9120D	Temp. / Humidity	23°C /60%
Polarity	Vertical	Site / Test Engineer	AC1 / James
Test Mode	BLE_TX_1Mbps_CH 39	Test Voltage	AC 120V/60Hz

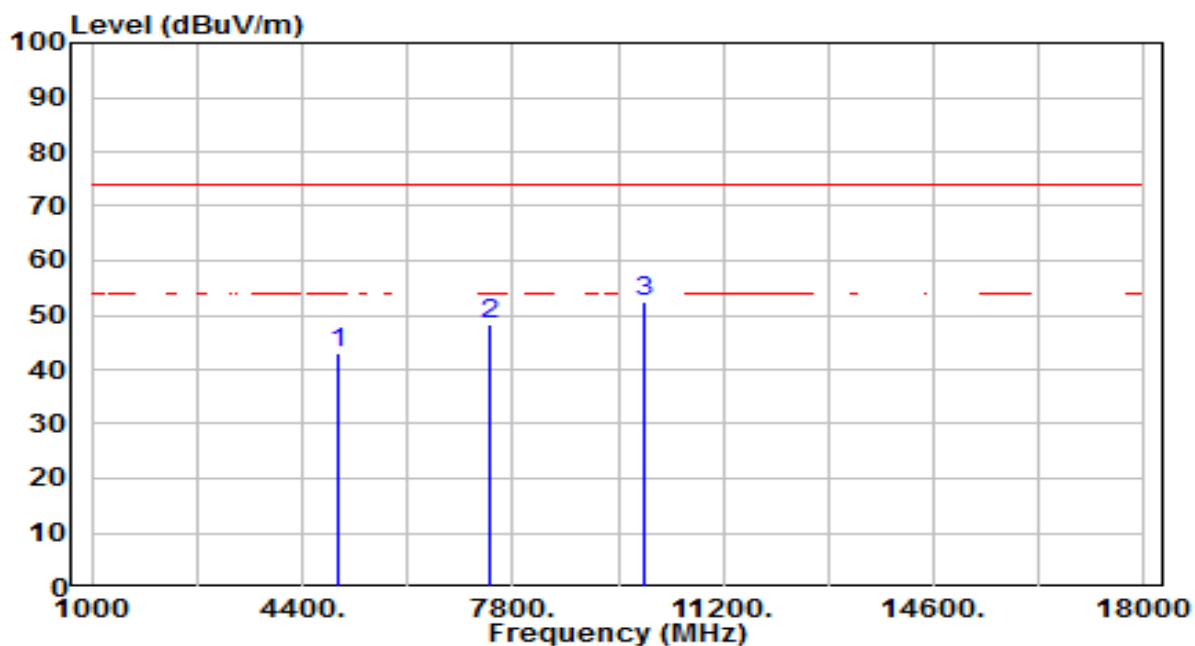

No	Frequency (MHz)	Reading (dBuV)	C.F (dB/m)	Measurement (dBuV/m)	Margin (dB)	Limit (dBuV/m)	Height (cm)	Angle (deg)	Remark (QP/PK/AV)
1	4960.000	38.19	4.75	42.93	-31.07	74.00	300	64	Peak
2	7440.000	34.50	13.78	48.28	-25.72	74.00	300	98	Peak
3	* 9920.000	35.30	17.28	52.58	-21.42	74.00	300	266	Peak

Note:

- "*", means this data is the worst emission level.
- C.F (Correction Factor) = Antenna Factor (dB/m) + Cable Loss (dB) – Preamplifier(dB).
- Measurement (dBuV/m) = Reading(dBuV) + C.F (Correction Factor).
- The emission levels of other frequencies are very lower than the limit and not show in test report.

EUT	BE11000 Whole Home Mesh Wi-Fi 7 System with PoE	Date of Test	2025-07-02
Factor	BBHA 9170	Temp. / Humidity	23°C /60%
Polarity	Horizontal	Site / Test Engineer	AC1 / Todd
Test Mode	BLE_TX_1Mbps_CH 19	Test Voltage	AC 120V/60Hz

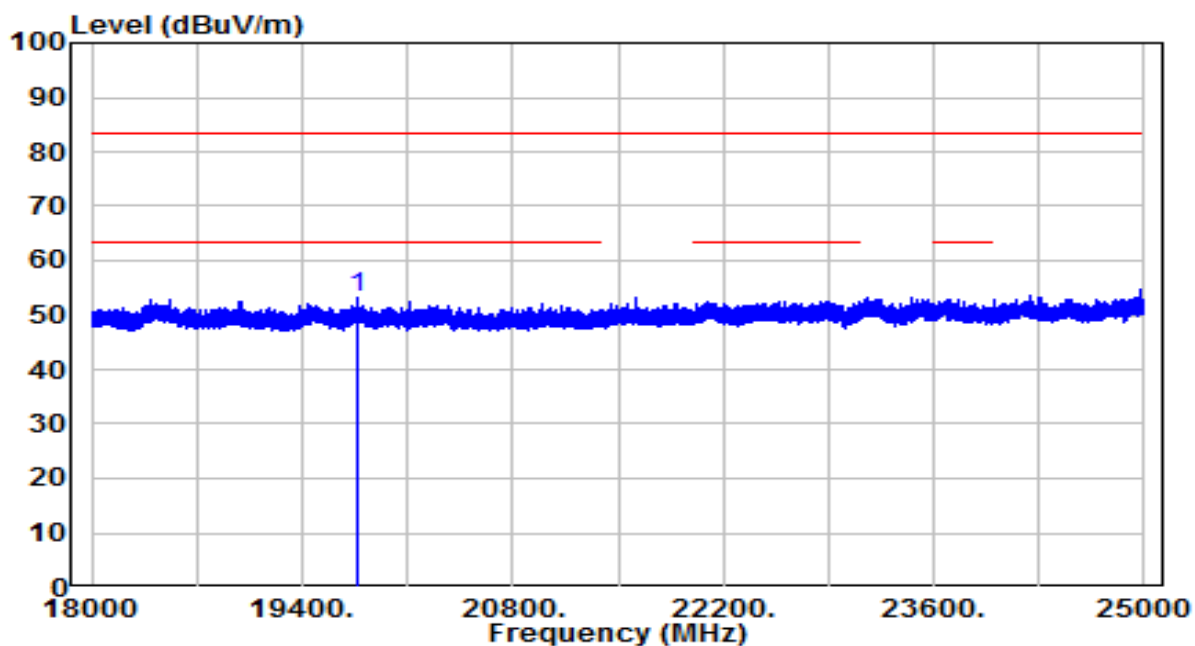

No	Frequency (MHz)	Reading (dBuV)	C.F (dB/m)	Measurement (dBuV/m)	Margin (dB)	Limit (dBuV/m)	Height (cm)	Angle (deg)	Remark (QP/PK/AV)
1	* 19759.630	42.14	10.95	53.09	-30.41	83.50	150	55	Peak

Note:

- "*" means this data is the worst emission level.
- C.F (Correction Factor) = Antenna Factor (dB/m) + Cable Loss (dB) – Preamplifier(dB).
- Measurement (dBuV/m) = Reading(dBuV) + C.F (Correction Factor).
- The emission levels of other frequencies are very lower than the limit and not show in test report.

EUT	BE11000 Whole Home Mesh Wi-Fi 7 System with PoE	Date of Test	2025-07-02
Factor	BBHA 9170	Temp. / Humidity	23°C /60%
Polarity	Vertical	Site / Test Engineer	AC1 / Todd
Test Mode	BLE_TX_1Mbps_CH 19	Test Voltage	AC 120V/60Hz

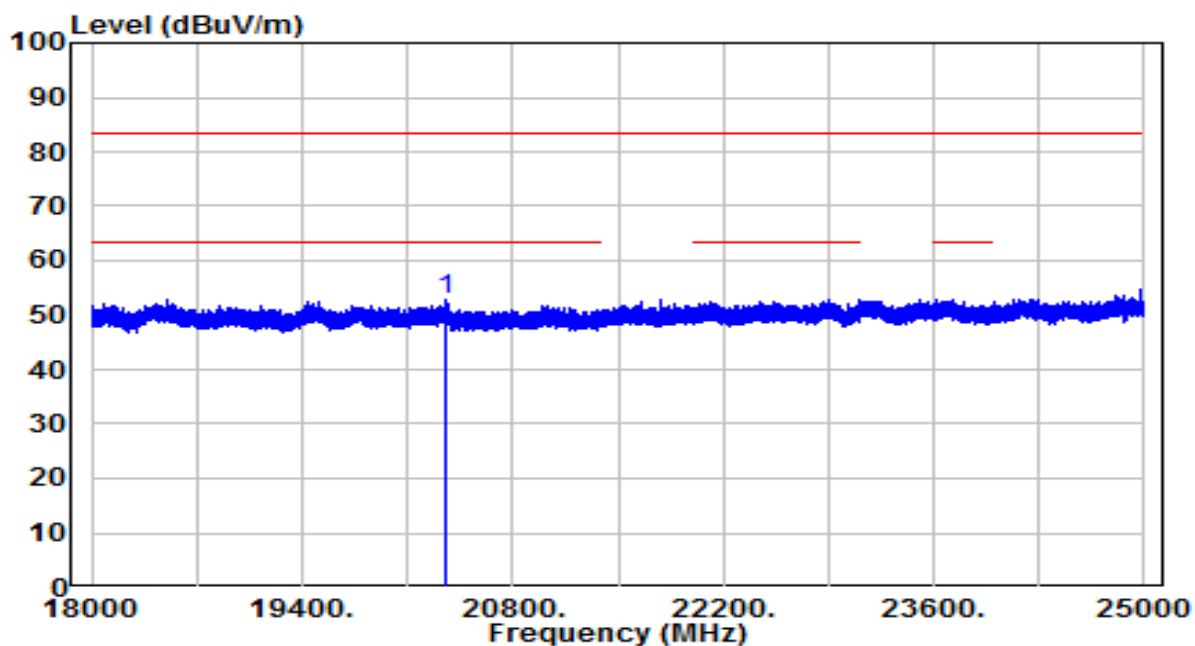

No	Frequency (MHz)	Reading (dBuV)	C.F (dB/m)	Measurement (dBuV/m)	Margin (dB)	Limit (dBuV/m)	Height (cm)	Angle (deg)	Remark (QP/PK/AV)
1	* 20353.750	42.15	10.77	52.92	-30.58	83.50	150	255	Peak

Note:

1. " *", means this data is the worst emission level.
2. C.F (Correction Factor) = Antenna Factor (dB/m) + Cable Loss (dB) – Preamplifier(dB).
3. Measurement (dBuV/m) = Reading(dBuV) + C.F (Correction Factor).
4. The emission levels of other frequencies are very lower than the limit and not show in test report.

7.7. Radiated Restricted Band Edge Measurement

7.7.1. Test Limit

All out of band emissions appearing in a restricted band as specified in Section 15.205 of the Title 47 CFR must not exceed the limits shown in Table per Section 15.209.

FCC Part 15 Subpart C Paragraph 15.209		
Frequency [MHz]	Field Strength [V/m]	Measured Distance [Meters]
0.009 - 0.490	2400/F (kHz)	300
0.490 - 1.705	24000/F (kHz)	30
1.705 – 30	30	30
30 – 88	100	3
88 – 216	150	3
216 – 960	200	3
Above 960	500	3

7.7.2. Test Procedure Used

ANSI C63.10-2013 - Section 11.13

7.7.3. Test Setting

Peak Field Strength Measurements

1. Analyzer center frequency was set to the frequency of the radiated spurious emission of interest
2. RBW = as specified in Table 1
3. VBW = 3 * RBW
4. Detector = peak
5. Sweep time = auto couple
6. Trace mode = max hold
7. Trace was allowed to stabilize

Table 1 - RBW as a function of frequency

Frequency	RBW
9 ~ 150 kHz	200 ~ 300 Hz
0.15 ~ 30 MHz	9 ~ 10 kHz
30 ~ 1000 MHz	100 ~ 120 kHz
> 1000 MHz	1 MHz

Average Field Strength Measurements

1. Analyzer center frequency was set to the frequency of the radiated spurious emission of interest
2. RBW = 1MHz
3. VBW $\geq 1/T$
4. De As an alternative, the instrument may be set to linear detector mode. Ensure that video filtering is applied in linear voltage domain (rather than in a log or dB domain). Some instruments require linear display mode in order to accomplish this. Others have a setting for Average-VBW Type, which can be set to "Voltage" regardless of the display mode
5. Detector = Peak
6. Sweep time = auto
7. Trace mode = max hold
8. Allow max hold to run for at least 50 times (1/duty cycle) traces

7.7.4. Test Setup

1GHz ~ 25GHz Test Setup:

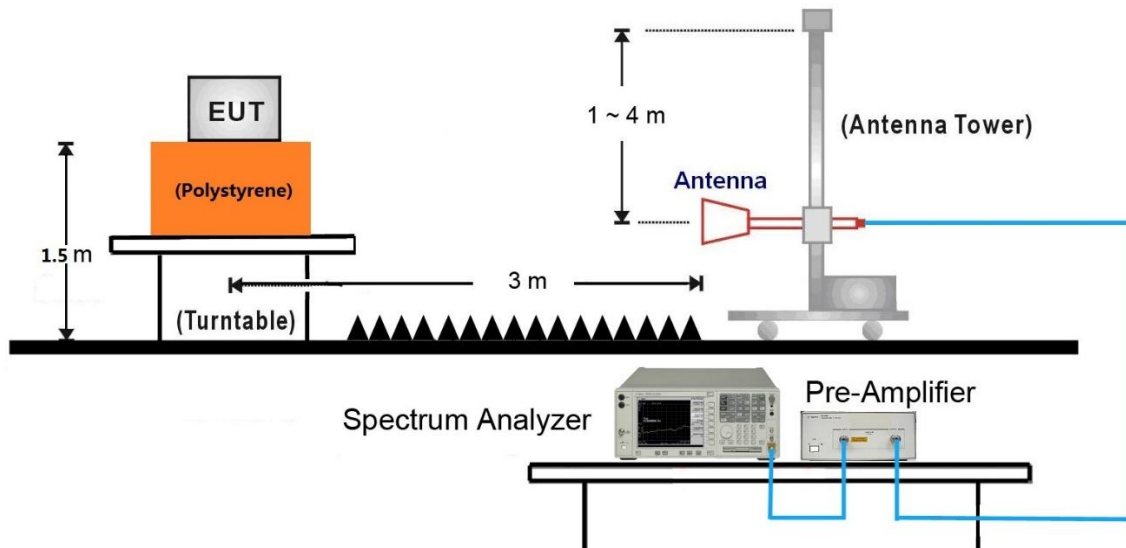

7.7.5. Test Result

EUT	BE11000 Whole Home Mesh Wi-Fi 7 System with PoE	Date of Test	2025-07-02
Factor	BBHA 9120D	Temp. / Humidity	23°C /60%
Polarity	Horizontal	Site / Test Engineer	AC1 / James
Test Mode	BLE_TX_1Mbps_CH 0	Test Voltage	AC 120V/60Hz

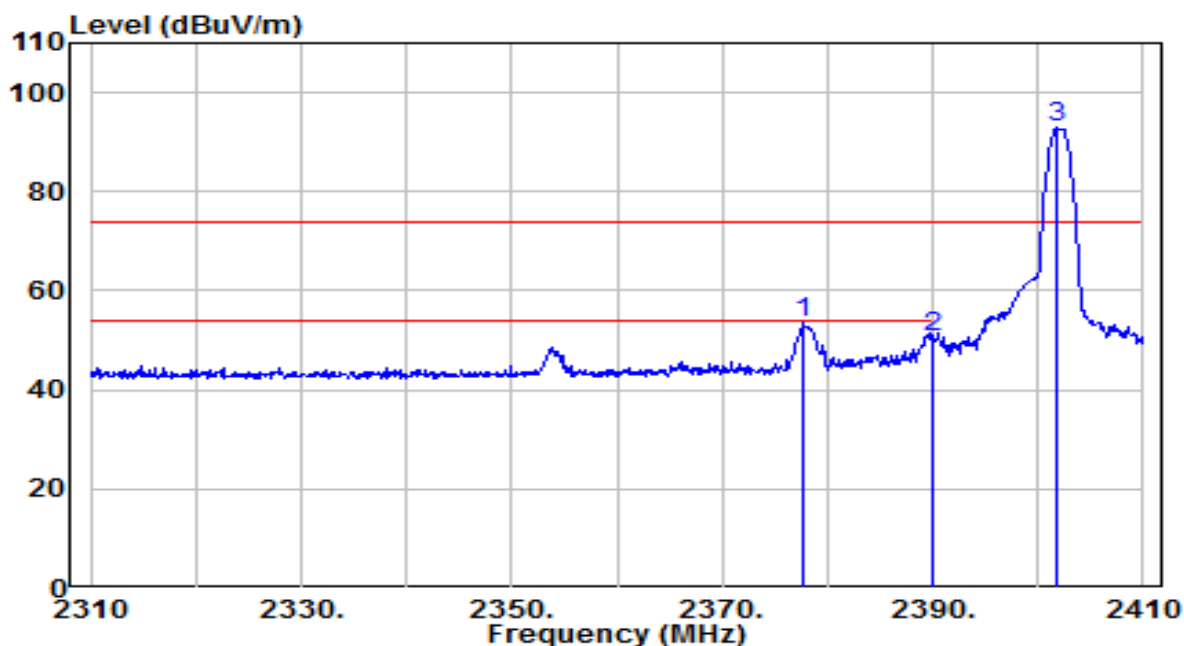

No	Frequency (MHz)	Reading (dBuV)	C.F (dB/m)	Measurement (dBuV/m)	Margin (dB)	Limit (dBuV/m)	Height (cm)	Angle (deg)	Remark (QP/PK/AV)
1	* 2377.800	55.00	-1.54	53.46	-20.54	74.00	235	210	Peak
2	2390.000	52.24	-1.50	50.74	-23.26	74.00	235	210	Peak
3	2401.800	94.28	-1.46	92.83	N/A	N/A	235	210	Peak

Note:

- "*", means this data is the worst emission level.
- C.F (Correction Factor) = Antenna Factor (dB/m) + Cable Loss (dB) – Preamplifier(dB).
- Measurement (dBuV/m) = Reading(dBuV) + C.F (Correction Factor).
- The emission levels of other frequencies are very lower than the limit and not show in test report.

EUT	BE11000 Whole Home Mesh Wi-Fi 7 System with PoE	Date of Test	2025-07-02
Factor	BBHA 9120D	Temp. / Humidity	23°C /60%
Polarity	Vertical	Site / Test Engineer	AC1 / James
Test Mode	BLE_TX_1Mbps_CH 0	Test Voltage	AC 120V/60Hz

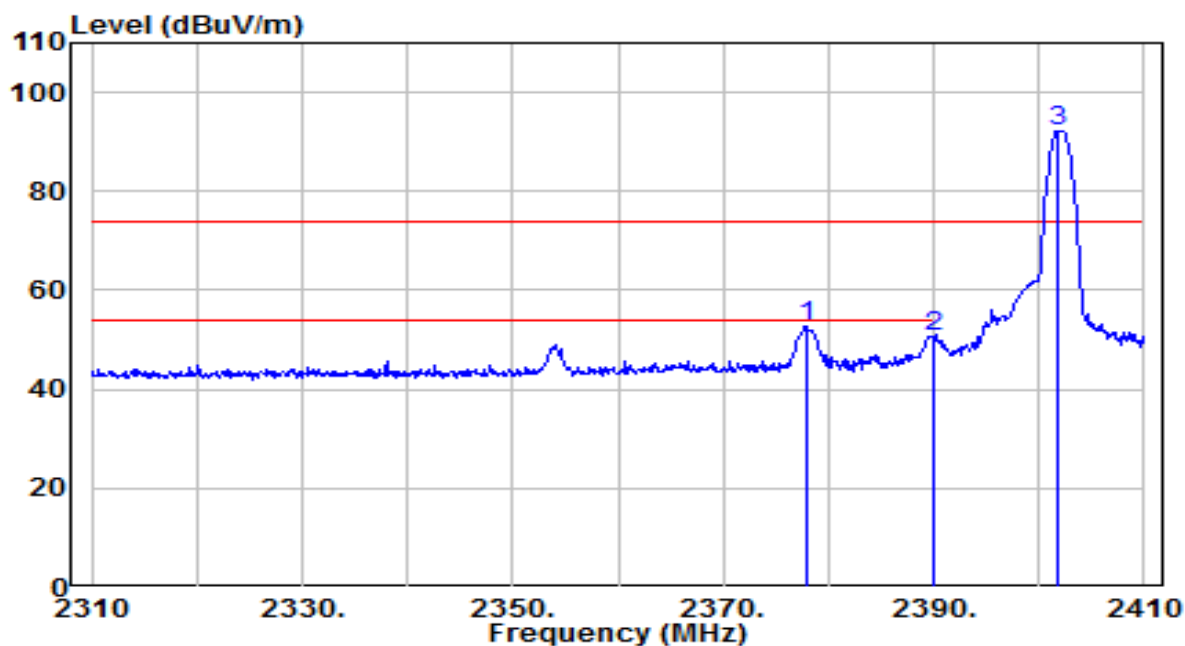

No	Frequency (MHz)	Reading (dBuV)	C.F (dB/m)	Measurement (dBuV/m)	Margin (dB)	Limit (dBuV/m)	Height (cm)	Angle (deg)	Remark (QP/PK/AV)
1	* 2377.900	54.27	-1.54	52.72	-21.28	74.00	175	195	Peak
2	2390.000	52.03	-1.50	50.53	-23.47	74.00	175	195	Peak
3	2401.900	93.70	-1.45	92.25	N/A	N/A	175	195	Peak

Note:

- "*", means this data is the worst emission level.
- C.F (Correction Factor) = Antenna Factor (dB/m) + Cable Loss (dB) – Preamplifier(dB).
- Measurement (dBuV/m) = Reading(dBuV) + C.F (Correction Factor).
- The emission levels of other frequencies are very lower than the limit and not show in test report.

EUT	BE11000 Whole Home Mesh Wi-Fi 7 System with PoE	Date of Test	2025-07-02
Factor	BBHA 9120D	Temp. / Humidity	23°C /60%
Polarity	Horizontal	Site / Test Engineer	AC1 / James
Test Mode	BLE_TX_1Mbps_CH 39	Test Voltage	AC 120V/60Hz

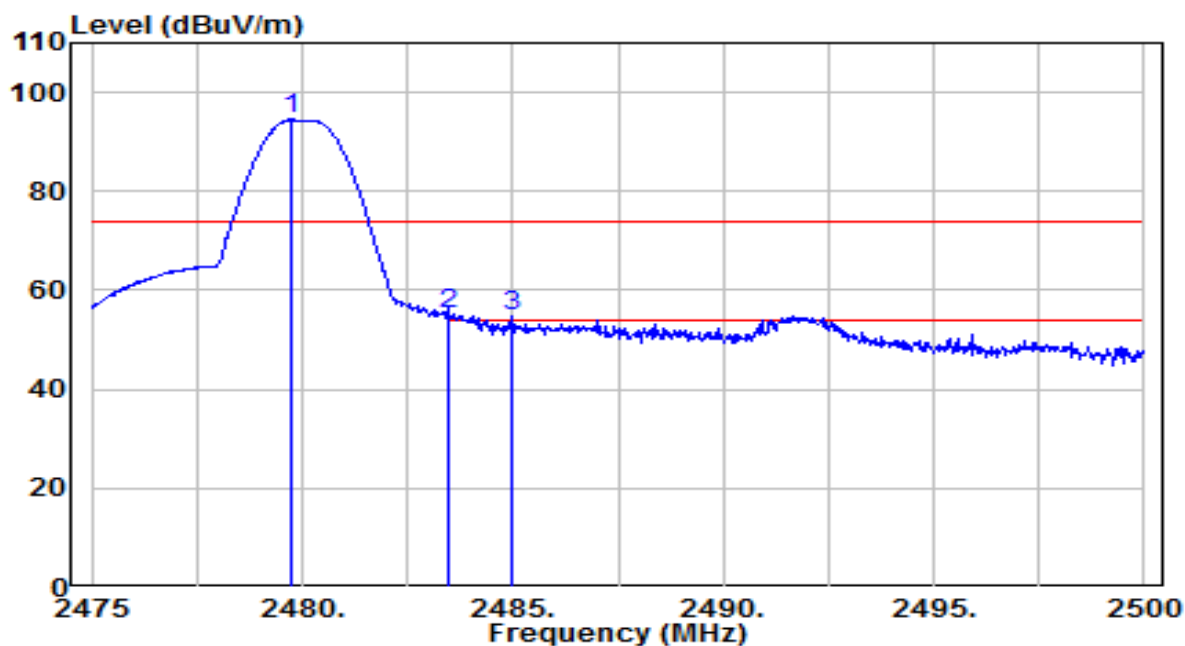

No	Frequency (MHz)	Reading (dBuV)	C.F (dB/m)	Measurement (dBuV/m)	Margin (dB)	Limit (dBuV/m)	Height (cm)	Angle (deg)	Remark (QP/PK/AV)
1	2479.725	95.62	-1.17	94.45	N/A	N/A	160	205	Peak
2	* 2483.500	56.25	-1.15	55.10	-18.90	74.00	160	205	Peak
3	2485.000	56.11	-1.15	54.96	-19.04	74.00	160	205	Peak

Note:

- "*" means this data is the worst emission level.
- C.F (Correction Factor) = Antenna Factor (dB/m) + Cable Loss (dB) – Preamplifier(dB).
- Measurement (dBuV/m) = Reading(dBuV) + C.F (Correction Factor).
- The emission levels of other frequencies are very lower than the limit and not show in test report.

EUT	BE11000 Whole Home Mesh Wi-Fi 7 System with PoE	Date of Test	2025-07-02
Factor	BBHA 9120D	Temp. / Humidity	23°C /60%
Polarity	Horizontal	Site / Test Engineer	AC1 / James
Test Mode	BLE_TX_1Mbps_CH 39	Test Voltage	AC 120V/60Hz

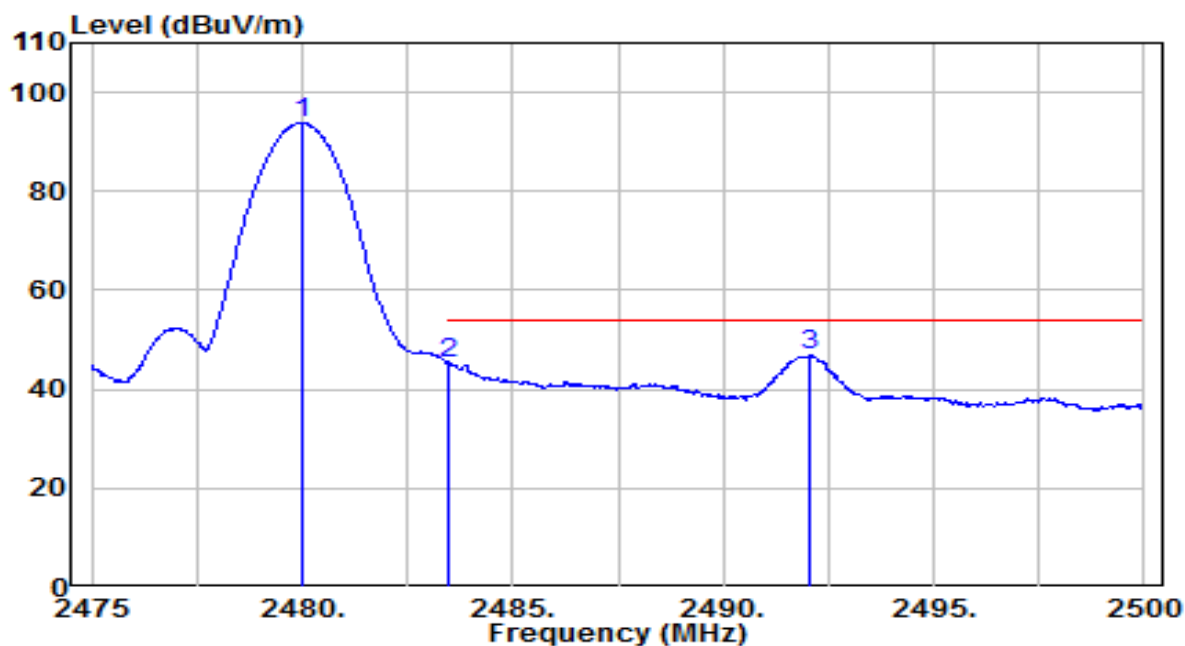

No	Frequency (MHz)	Reading (dBuV)	C.F (dB/m)	Measurement (dBuV/m)	Margin (dB)	Limit (dBuV/m)	Height (cm)	Angle (deg)	Remark (QP/PK/AV)
1	2479.975	94.92	-1.16	93.76	N/A	N/A	160	205	Average
2	2483.500	46.49	-1.15	45.34	-8.66	54.00	160	205	Average
3	* 2492.075	48.02	-1.12	46.90	-7.10	54.00	160	205	Average

Note:

- "*" means this data is the worst emission level.
- C.F (Correction Factor) = Antenna Factor (dB/m) + Cable Loss (dB) – Pre-amplifier(dB).
- Measurement (dBuV/m) = Reading(dBuV) + C.F (Correction Factor).
- The emission levels of other frequencies are very lower than the limit and not show in test report.

EUT	BE11000 Whole Home Mesh Wi-Fi 7 System with PoE	Date of Test	2025-07-02
Factor	BBHA 9120D	Temp. / Humidity	23°C /60%
Polarity	Vertical	Site / Test Engineer	AC1 / James
Test Mode	BLE_TX_1Mbps_CH 39	Test Voltage	AC 120V/60Hz

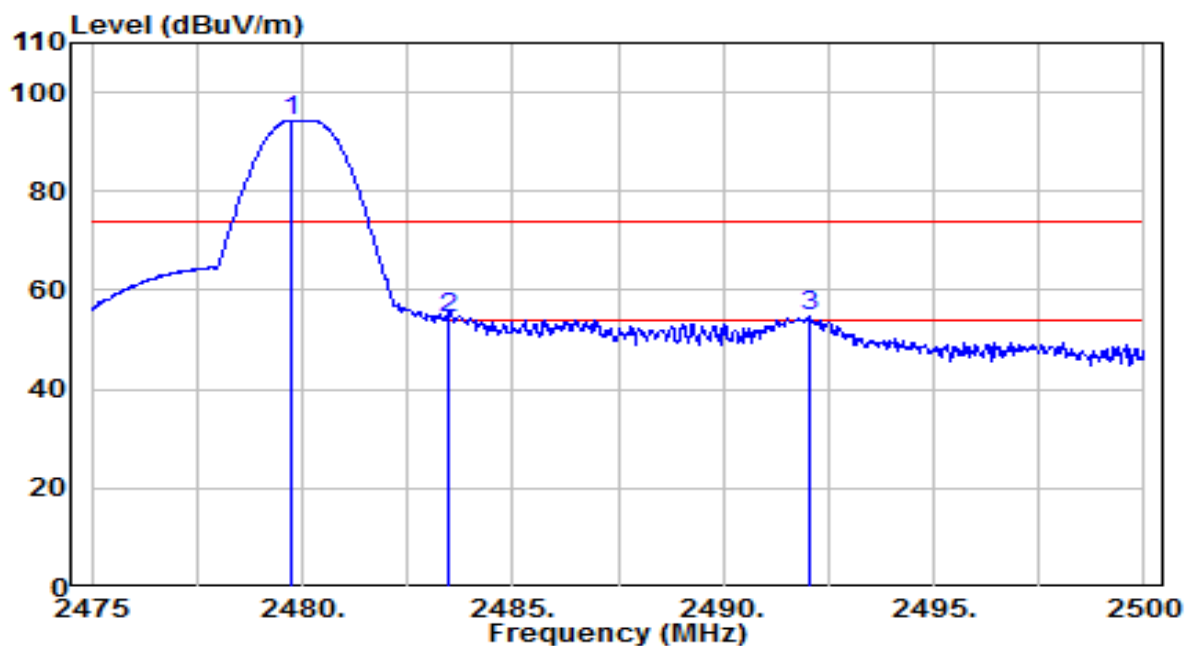

No	Frequency (MHz)	Reading (dBuV)	C.F (dB/m)	Measurement (dBuV/m)	Margin (dB)	Limit (dBuV/m)	Height (cm)	Angle (deg)	Remark (QP/PK/AV)
1	2479.750	95.53	-1.17	94.36	N/A	N/A	190	185	Peak
2	2483.500	55.67	-1.15	54.52	-19.48	74.00	190	185	Peak
3	* 2492.025	55.92	-1.12	54.81	-19.19	74.00	190	185	Peak

Note:

- "*" means this data is the worst emission level.
- C.F (Correction Factor) = Antenna Factor (dB/m) + Cable Loss (dB) – Pre-amplifier(dB).
- Measurement (dBuV/m) = Reading(dBuV) + C.F (Correction Factor).
- The emission levels of other frequencies are very lower than the limit and not show in test report.

EUT	BE11000 Whole Home Mesh Wi-Fi 7 System with PoE	Date of Test	2025-07-02
Factor	BBHA 9120D	Temp. / Humidity	23°C /60%
Polarity	Vertical	Site / Test Engineer	AC1 / James
Test Mode	BLE_TX_1Mbps_CH 39	Test Voltage	AC 120V/60Hz

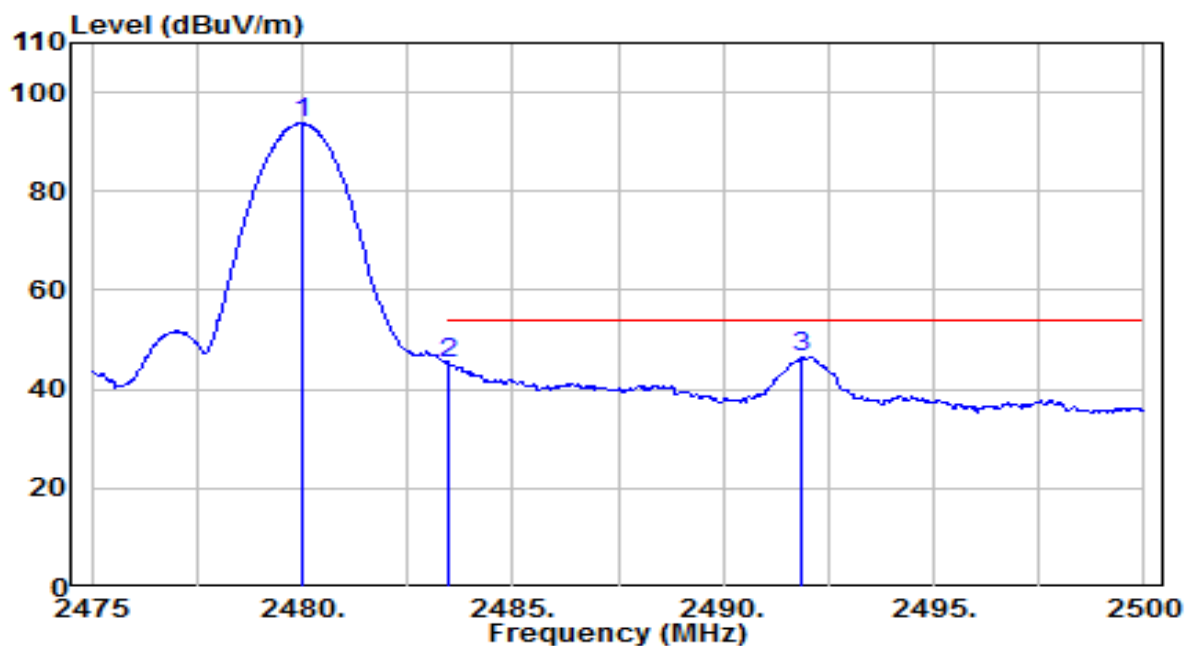

No	Frequency (MHz)	Reading (dBuV)	C.F (dB/m)	Measurement (dBuV/m)	Margin (dB)	Limit (dBuV/m)	Height (cm)	Angle (deg)	Remark (QP/PK/AV)
1	2479.975	94.86	-1.16	93.70	N/A	N/A	190	185	Average
2	2483.500	46.24	-1.15	45.09	-8.91	54.00	190	185	Average
3	* 2491.875	47.66	-1.12	46.54	-7.46	54.00	190	185	Average

Note:

1. " *", means this data is the worst emission level.
2. C.F (Correction Factor) = Antenna Factor (dB/m) + Cable Loss (dB) – Preamplifier(dB).
3. Measurement (dBuV/m) = Reading(dBuV) + C.F (Correction Factor).
4. The emission levels of other frequencies are very lower than the limit and not show in test report.

7.8. AC Conducted Emissions Measurement

7.8.1. Test Limit

FCC Part 15 Subpart C Paragraph 15.207 / RSS-Gen Limits		
Frequency (MHz)	QP (dB μ V)	Average (dB μ V)
0.15 - 0.50	66 - 56	56 - 46
0.50 - 5.0	56	46
5.0 - 30	60	50

Note 1: The lower limit shall apply at the transition frequencies.

Note 2: The limit decreases linearly with the logarithm of the frequency in the range 0.15MHz to 0.5MHz.

7.8.2. Test Setup

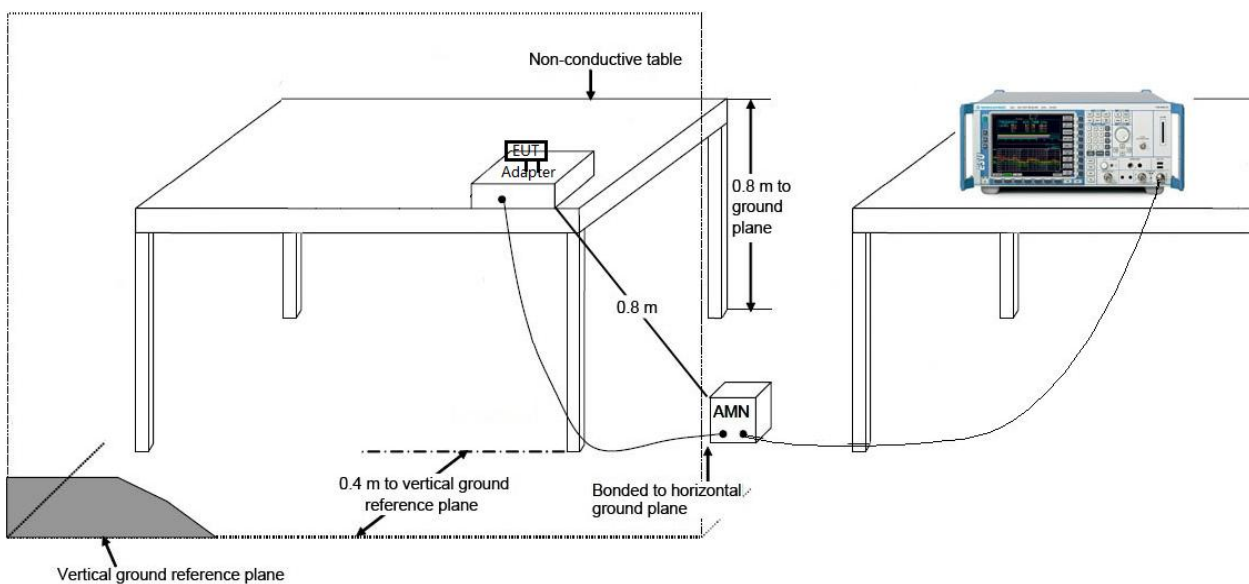

7.8.3. Test Result

EUT	BE11000 Whole Home Mesh Wi-Fi 7 System with PoE	Date of Test	2025-07-01
Factor	CE_ENV216-L1 (Filter ON)	Temp. / Humidity	26.5°C /55%
Polarity	Line1	Site / Test Engineer	SR2 / Ryan
Test Mode	BLE_TX_1Mbps_CH19	Test Voltage	AC 120V/60Hz

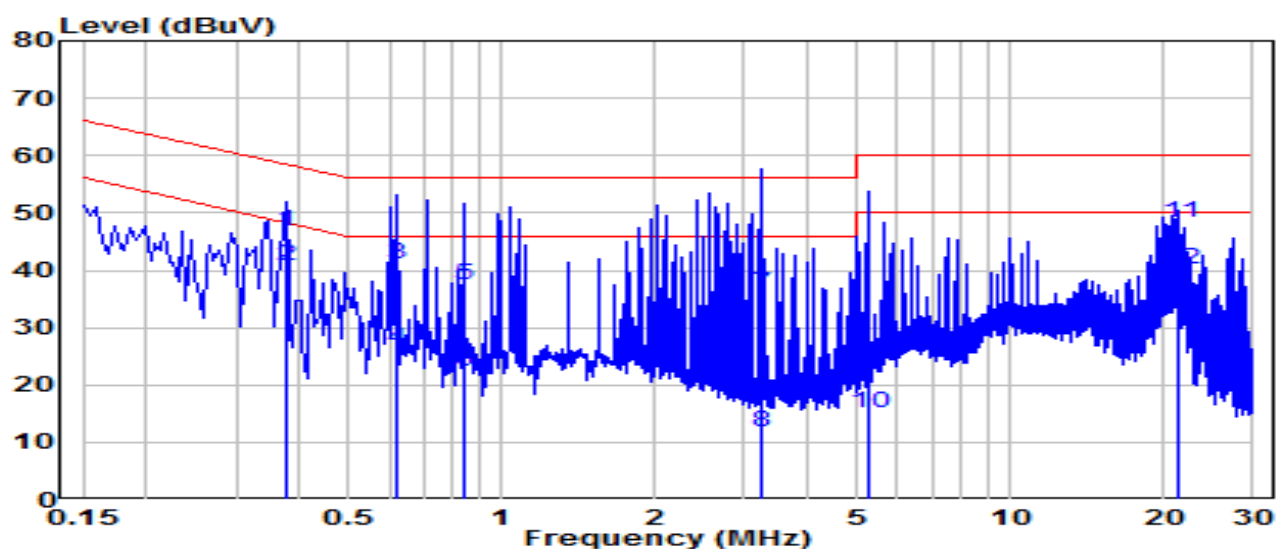

No		Frequency (MHz)	Reading (dBuV)	C.F (dB)	Measurement (dBuV)	Margin (dB)	Limit (dBuV)	Remark (QP/PK/AV)
1	*	0.375	37.22	9.63	46.85	-11.54	58.39	QP
2	*	0.375	31.18	9.63	40.82	-7.57	48.39	Average
3		0.622	31.54	9.65	41.19	-14.81	56.00	QP
4		0.622	16.69	9.65	26.34	-19.66	46.00	Average
5		0.838	27.83	9.66	37.49	-18.51	56.00	QP
6		0.838	12.76	9.66	22.42	-23.58	46.00	Average
7		3.223	26.31	9.72	36.03	-19.97	56.00	QP
8		3.223	2.14	9.72	11.85	-34.15	46.00	Average
9		5.252	12.79	9.75	22.54	-37.46	60.00	QP
10		5.252	5.33	9.75	15.08	-34.92	50.00	Average
11		21.509	38.45	9.93	48.38	-11.62	60.00	QP
12		21.509	30.08	9.93	40.01	-9.99	50.00	Average

Note:

1. " *", means this data is the worst emission level.
2. C.F (Correction Factor) = LISN Factor (dB)+ Cable Loss (dB).
3. Measurement (dBuV) = Reading(dBuV) + C.F (Correction Factor).

EUT	BE11000 Whole Home Mesh Wi-Fi 7 System with PoE	Date of Test	2025-07-01
Factor	CE_ENV216-N (Filter ON)	Temp. / Humidity	26.5°C /55%
Polarity	Neutral	Site / Test Engineer	SR2 / Ryan
Test Mode	BLE_TX_1Mbps_CH19	Test Voltage	AC 120V/60Hz

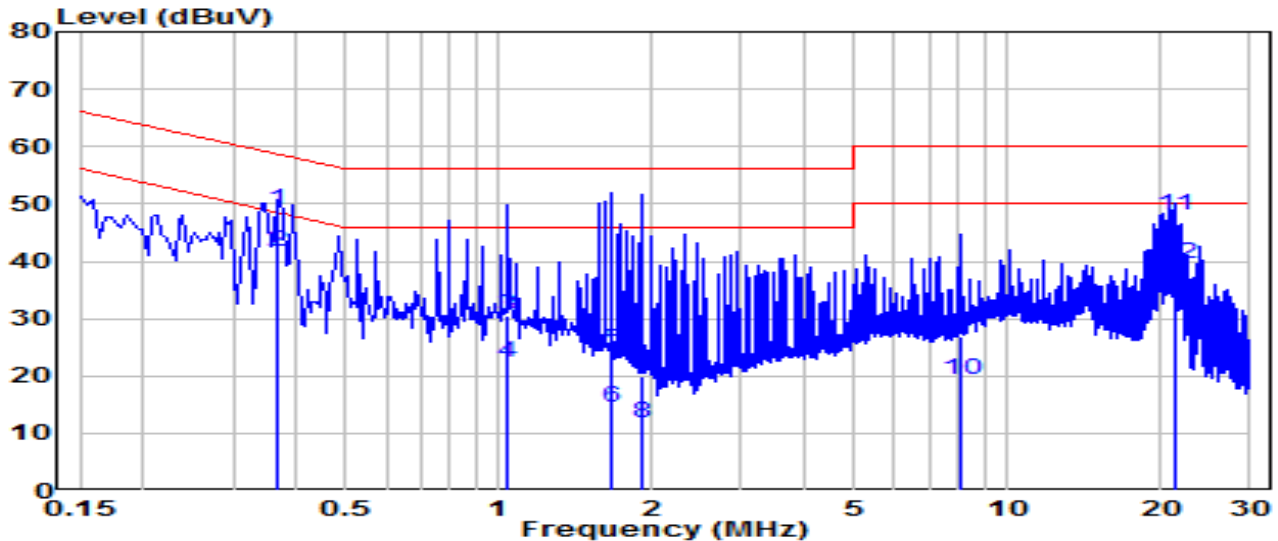

No	Frequency (MHz)	Reading (dBuV)	C.F (dB)	Measurement (dBuV)	Margin (dB)	Limit (dBuV)	Remark (QP/PK/AV)
1	*	39.37	9.63	49.01	-9.59	58.59	QP
2	*	31.96	9.63	41.60	-7.00	48.59	Average
3		20.94	9.67	30.61	-25.39	56.00	QP
4		12.65	9.67	22.32	-23.68	46.00	Average
5		14.65	9.69	24.34	-31.66	56.00	QP
6		4.89	9.69	14.58	-31.42	46.00	Average
7		10.28	9.70	19.98	-36.02	56.00	QP
8		2.12	9.70	11.81	-34.19	46.00	Average
9		17.15	9.82	26.97	-33.03	60.00	QP
10		9.63	9.82	19.45	-30.55	50.00	Average
11		37.99	9.98	47.97	-12.03	60.00	QP
12		29.50	9.98	39.49	-10.51	50.00	Average

Note:

- "*", means this data is the worst emission level.
- C.F (Correction Factor) = LISN Factor (dB)+ Cable Loss (dB).
- Measurement (dBuV) = Reading(dBuV) + C.F (Correction Factor).

8. CONCLUSION

The data collected relate only the item(s) tested and show that the **BE11000 Whole Home Mesh Wi-Fi 7 System with PoE** is in compliance with Part 15C of the FCC Rules.

Appendix A : Test Photograph

Refer to “2506TW0114-UT” file.

Appendix B : External Photograph

Refer to “2506TW0114-UE” file.

Appendix C : Internal Photograph

Refer to “2506TW0114-UI” file.

————— The End —————