

**MORE COMFORTABLE  
AND CLEAN LIFE WITH PETS**

+ Smart Cat Litter Box +  
**User Manual**



# CONTENT

I	PRODUCT LIST	03
II	INSTRUCTIONS FOR THE FIRST USE	06
III	INTRODUCTION OF CONTROL PANEL	10
IV	APP	12
V	OPERATING INSTRUCTIONS	16
VI	REPLACE GARBAGE BAG	28
VII	FAULT SELF-CHECK METHOD	30
VIII	FAQ	31
IX	PARAMETERS AND SPECIFICATIONS	33

## Cautions:

1. Please install and use this device strictly according to the instructions.
2. Please use it in an indoor environment, do not place it in direct sunlight, and keep it away from fire sources.
3. Please place the device on a flat and hard ground, and do not place articles on the top of the device.
4. Do not drag or place vigorously during placement to avoid device damage.
5. Kittens weighing less than 1kg and lactating cats should not use the auto cleaning mode of the device.
6. It is strictly forbidden to soak or immerse the host part of this device.
7. Please unplug the power cord when moving, cleaning the device or not using it for a long time.
8. Please use the original power adapter to avoid damage to the device or potential safety hazards.
9. If children use this device, please make sure to use it under the guidance of an adult.
  10. Please perform maintenance under the guidance of professionals to avoid all kinds of damages.
11. If you encounter product use problems, please contact customer service.
12. Please read this manual carefully before. Once installed and used, it means that you have carefully read and accepted the following safety instructions.
13. If the product does not work properly due to other unknown conditions, and you do not have time to refer to the instructions, please restart the power.

# I PRODUCT LIST

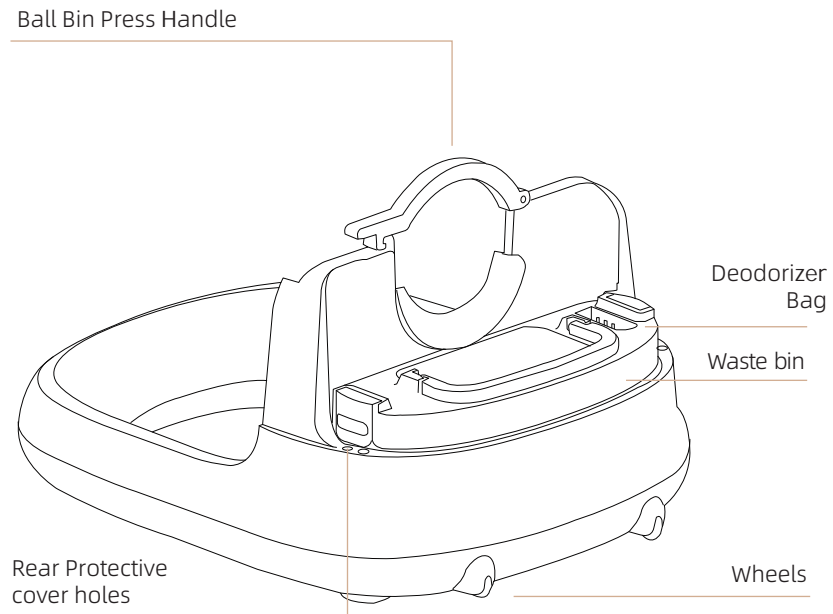
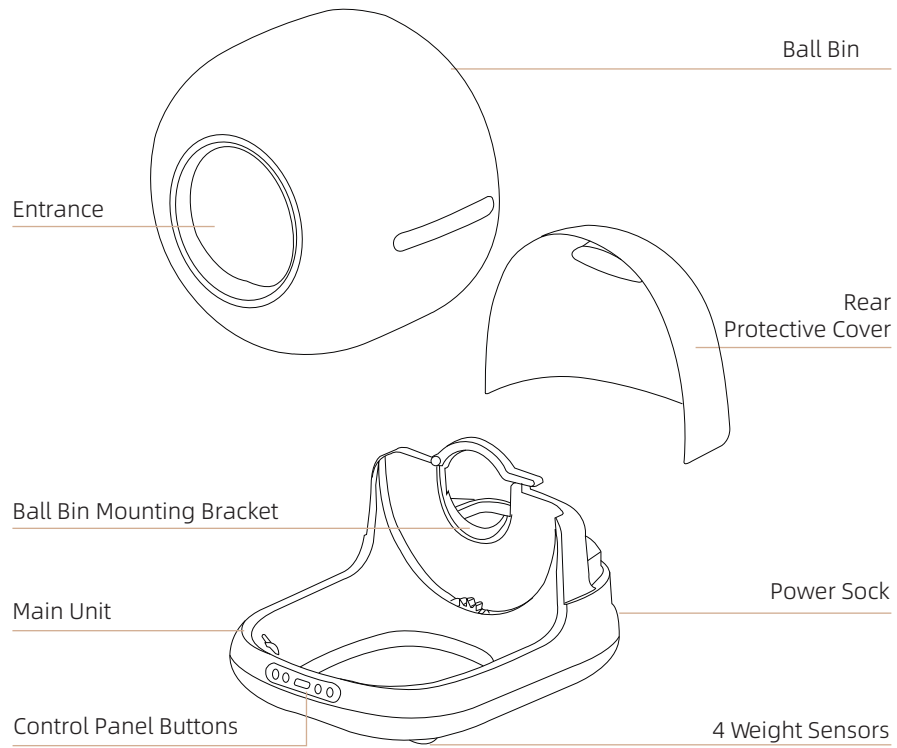

## 1.2 Accessories(in litter storage box):

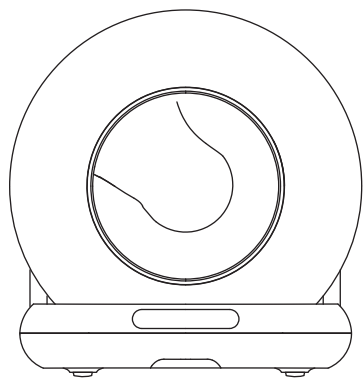

Product



User manual

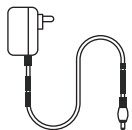

Adapter



Garbage bag

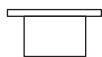

Deodorizer

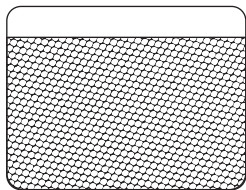

Sand control mat

### Notice:

Please follow the installation steps, including garbage bags and deodorizer.

## II INSTRUCTIONS FOR THE FIRST USE

### 2.1 Open the box

- ① Open the box ,take out the protective cottons on both sides.
- ② Take out the PE bag and the product.
- ③ Tear off all the traceless tapes on the product.

**2.2** Please place the machine on a firm and flat ground. Please make sure ball bin & waste bin(include garbage bag) properly install, then put on protective cover.

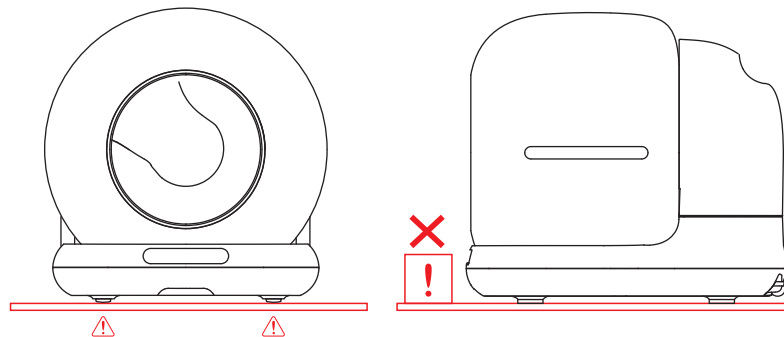

**2.3** Please power on the device and do self-checking. There will be no indicators if self-checking is well done.

**2.4** Please fill litter no exceed “Max Line “, Long press  for 5 seconds to calibrate.

**2.5** Long press WiFi button  for 5 seconds for App connecting.

## 2.6 Installation Steps:

- ① Put the waste bin to cat litter base.
- ② Fix the ball bin to mouting bracket.
- ③ Then press the handle at the Ball bin.

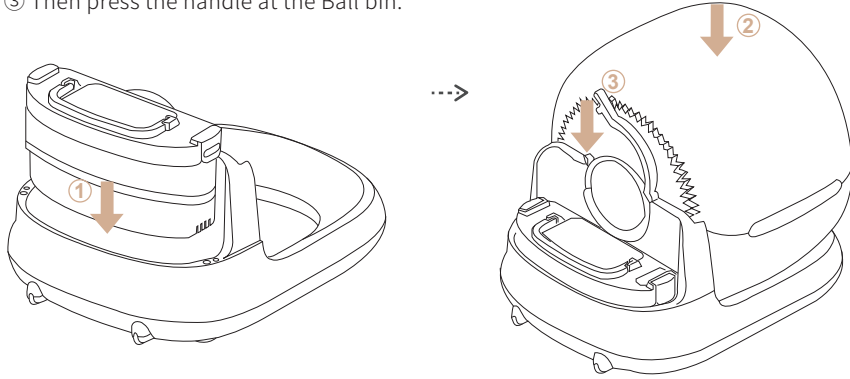

- ④ Put on the rear protective cover.

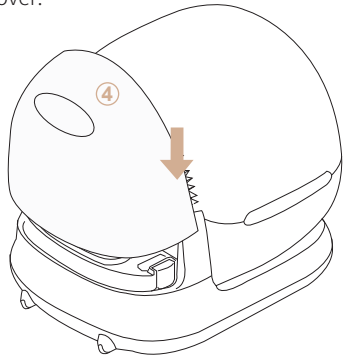

## 2.7 Use:

2.7.1 Power on the device, it will take time to do self-checking.

2.7.2 The device will automatically be in the state of smart sensing after self-check, no need to change its program.

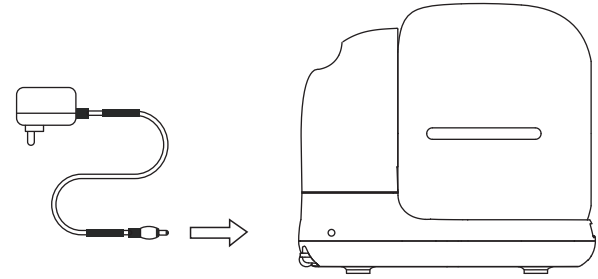

## Notice:

- ✗ Pick up or drag the product after powering up. (This will interfere with weight calibration in the reset program.)
- ① During the clearing process, all keys are suspended. If you need to perform other functions, please wait until the clearing process is complete.

## 2.8 Sands filling

Make sure the litter does not exceed the “MAX” line. (The amount of sand can be adjusted according to the actual situation.)

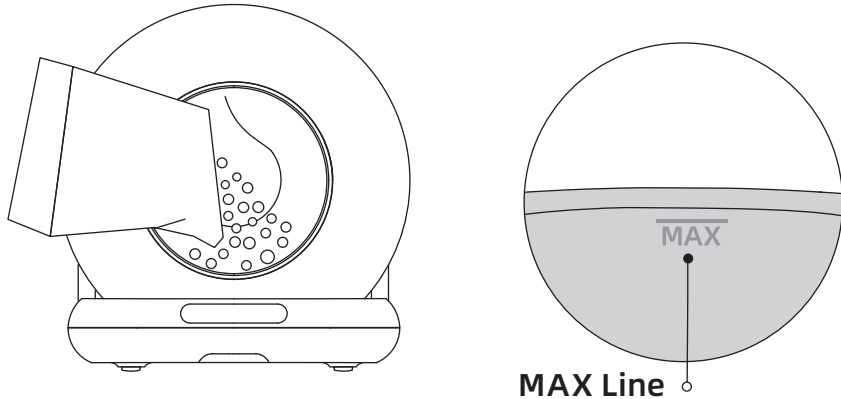

**MAX Line**  
The amount of cat litter should not exceed Max line

### Notice:

After adding cat litter, the "smoothing button" will light up blue for about 10 seconds. Press and hold the "smoothing button" for five seconds to calibrate or it will automatically smooth and calibrate after five minutes.



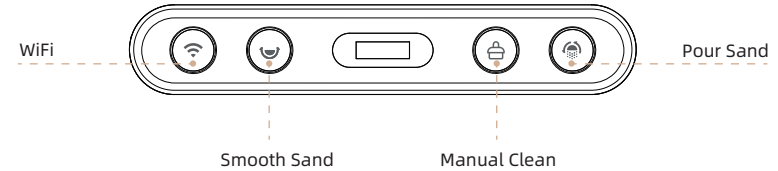

## III INTRODUCTION OF CONTROL PANEL



### Buttons

Button	Icon	Method	Description
WiFi		Press and hold for 5 seconds	APP Connection
Smooth Sand		Press once	Short Press, ON sand smoothing mode
		Press and hold for 5 seconds	Short Press, OFF sand smoothing mode
Manual Clean		Press once	Reset Cat weight
		Press and hold for 5 seconds	Short press, ON cleaning mode
Pour Sand		Press once	Short Press again, OFF Cleaning mode
		Press and hold for 5 seconds	The litter box is allowed to be calibrated without cat litter
Pour Sand		Press once	Short Press, ON Sand Pouring Mode
		Press and hold for 5 seconds	Short Press again, OFF Sand Pouring Mode
		Press and hold for 5 seconds	OFF Children Lock

## Indicators

Button	Icon	Color	Indicator status	Description
WiFi reset/ connect		Blue	Flashing	WiFi is not connected and will automatically turn off after successful connection.
		Red	Flashing	The waste bin is full or objects are detected by the sensors of the waste bin's infrared rays.
			Always on	Gear guards not in place.
Cat litter smoothing		Green	Always on	Short press, start working, once completed, the light will go off.
		Red	Always on	When an abnormality is detected during operation, the product is suspended.
Shoveling		Green	Always on	Short press, to start working, once completed, the light will go off.
		Red	Always on	When an abnormality is detected during operation, the product is suspended.
Inverted sand		Green	Always on	Short press, start working, once completed, the light will go off.
		Red	Always on	When an abnormality is detected during operation, the product is suspended.

## IV APP

### 4.1 Overseas users



Method 1: You can scan the above icon with your mobile phone



Method 2: You can download "tuya" App and install it by search it in the App store.

### 4.2 Networking:

4.2.1 Confirm that the phone is connected to 2.4G WiFi, then turn on Bluetooth and Location.

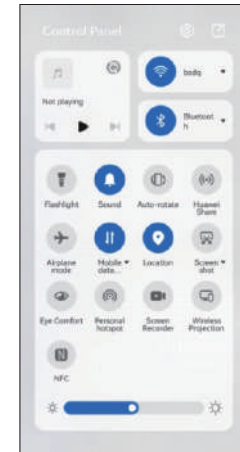

4.2.2 Press “WiFi”  for 5 seconds, WiFi Blue indicator begin to flash, It is ready for network connections.

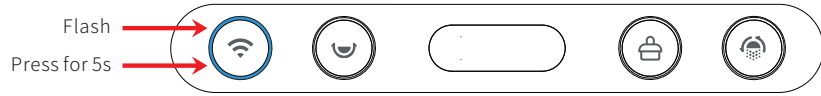

4.2.3 Open your phone App to add device by Bluetooth or WiFi.

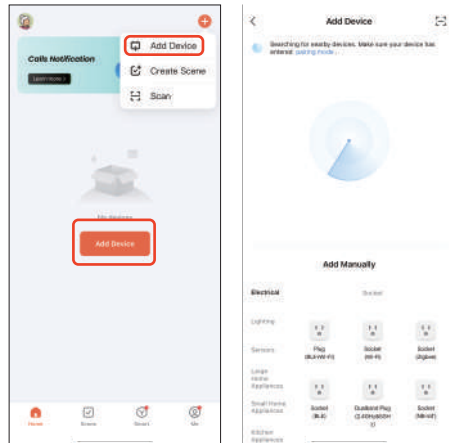

4.2.4 Continue “Next” after scanning the machine.

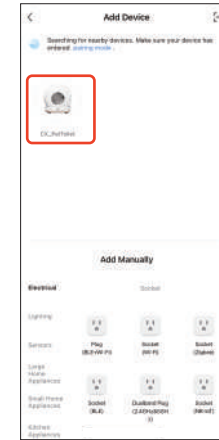

4.2.5 Continue “Next” after inputting WiFi code and wait to connect.

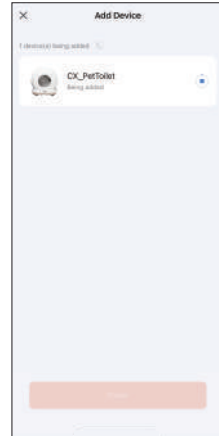
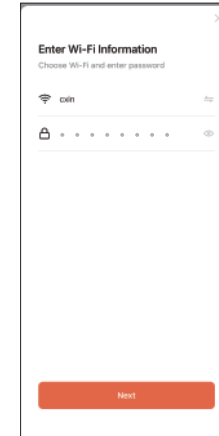



## 4.2.6 Enter APP after connecting.

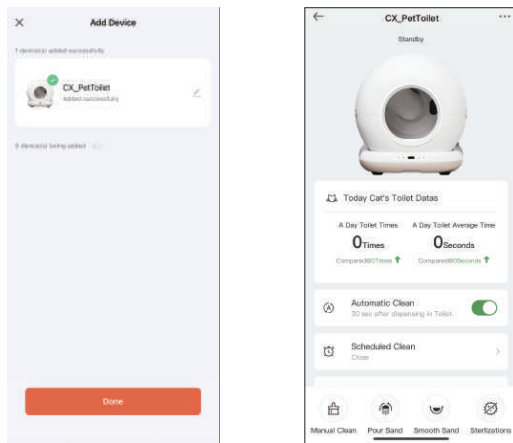

### Notice:

If the network configuration fails or a timeout message is displayed, check the following possibilities:

- ① Whether WiFi, Bluetooth, and Location switch are enabled at the same time.
- ② Whether the WiFi is in 2.4G band and whether the phone is connected to 2.4G band WiFi network. (The product cannot recognize the 5G band network.)
- ③ Whether the WiFi indicator on the panel is flashing during network configuration.
- ④ Whether the WiFi network in your home is faulty or down, please check whether other devices can use the network normally.
- ⑤ Whether the WiFi password is correct.
- ⑥ Whether the WiFi signal is too bad, please move the machine to a nearby router and reconnect.
- ⑦ The router connects to many wireless devices, causing IP address conflicts.

## V OPERATING INSTRUCTIONS

### 5.1 Clean:

Click “Manual Clean” on the panel or Same “Manual Clean” icon on the App for cleaning.

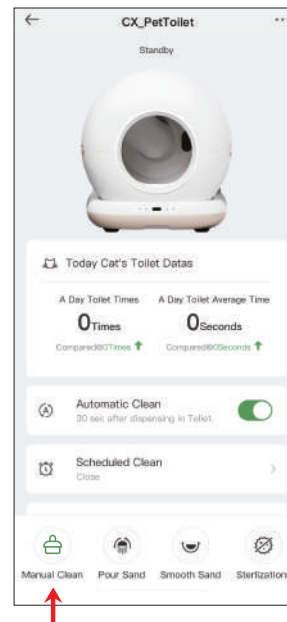

### Notice:

- ① During the cleaning process, you cannot implement other functions; you have to wait until the cleaning process is completed.
- ② During cleaning, you can cancel it by short-pressing the "manual clean" button.

## 5.2 Replace litter:

- ① Replace the garbage bag with an empty one (to avoid that the original one is already full of litters);
- ② Make sure the remaining sand is almost used out (to avoid spillage when sands pouring)
- ③ Press the “Sand Pouring” button and wait for the machine to clear the remaining litter.
- ④ Replace the garbage bag with an empty one again after clearing sand;

### Notice:

- ① Click “Replace Litter” again to cancel if you click it by mistake or if you find you have forgot to replace the garbage bag first.
- ② When the waste bin is full, the WiFi button will light up red and flash, and the app will send you a reminder message.

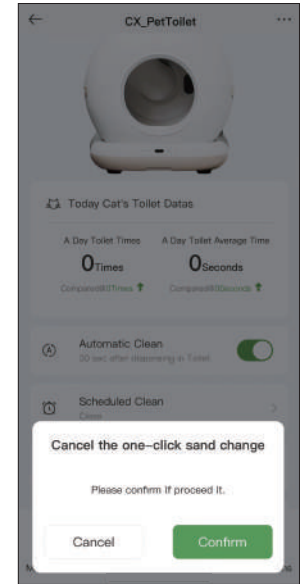
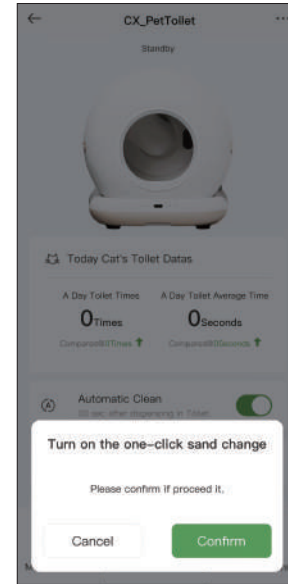
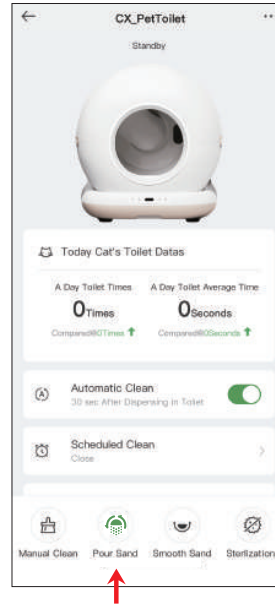
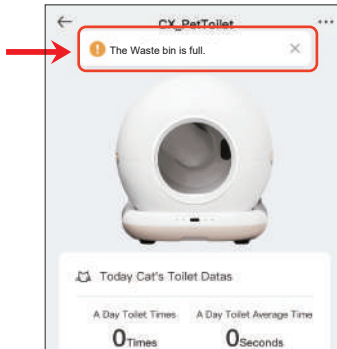

### 5.3 Add cat litter:

After filling cat litter, the “Smooth Sand” indicator will be in blue for about 10 seconds, press and hold the “Smooth Sand” button for five seconds to calibrate or wait for five minutes and it will be automatically smoothed and calibrated.

#### Notice:

- ① This device has a protective function during operation. During cleanup, it will stop as soon as the cat is approaching the entrance or the cat litter box feels the weight.
- ② After filling sands, please ensure that the liter of sands does not exceed the MAX line to avoid overflow when pouring the litter.
- ③ You can adjust the sand surface position by "Smooth Sand" button or APP "Smooth Sand" button.

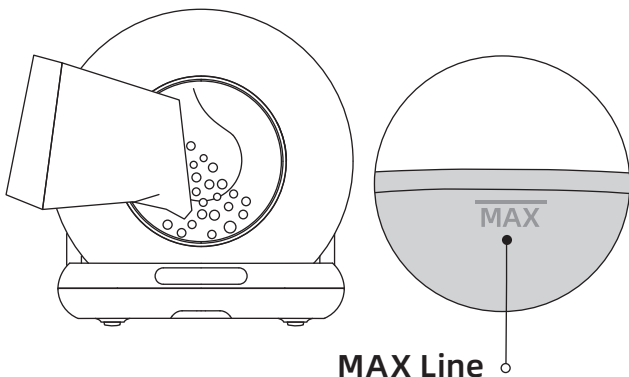
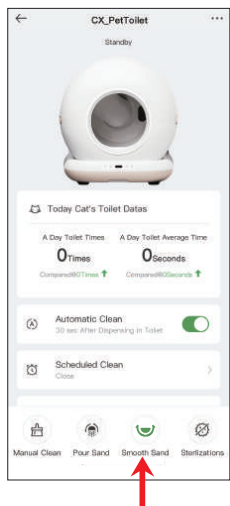

The amount of cat litter should not exceed Max line

### 5.4 Healthy Sterilizations:

- ① One-key sterilizations: 30 minutes working and automatically stop
- ② Sterilizations Schedule setting: Time /duration.

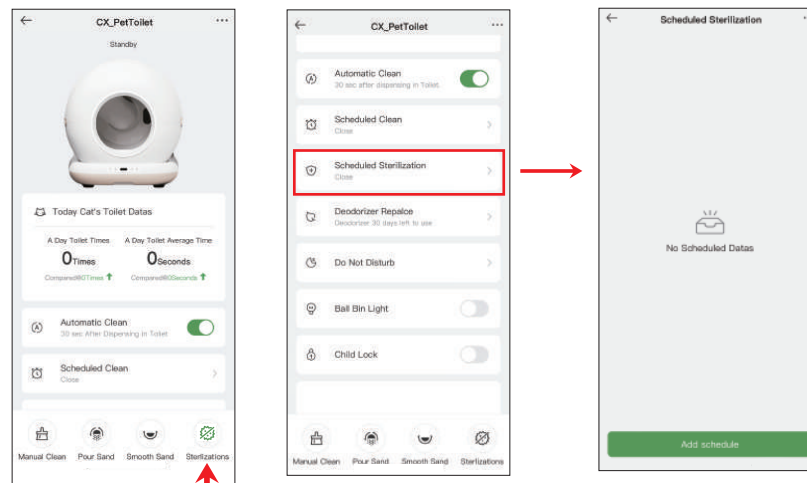

#### Notice:

- ① The machine will sterilize for 30 minutes after every cleaning.
- ② It will stop automatically once cat enters in, continue to work after cat leave.

## 5.5 Automatic Clean:

Click “Automatic Clean” on device panel button or App. The device will automatically detect the cats in and out.(It will start automatically after the device is powered on and self-checking).

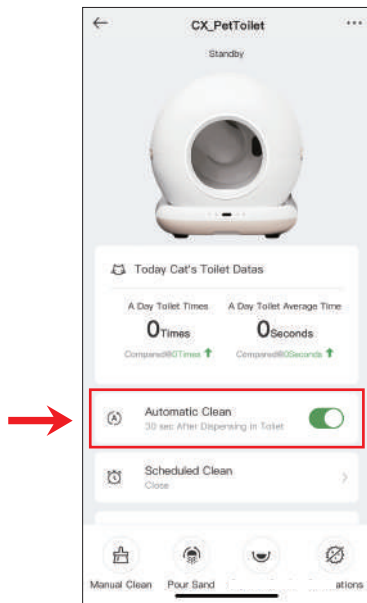

## Notice:

- ① If the kitten weighs less than 1 kg or is pregnant, please turn off the auto-cleaning on the APP, then click “Manual Clean” according to the actual situation.
- ② If you are using litter that clumps quickly, you can go to Automatic Clean, and enter to set up the "Shovel Poop Delay Time", then the device will wait for time after pets dispensing in toilet. such as 1 minute, to clean the litter as quickly as possible and reduce the smell.
- ③ If the cat enters the bin for more than 10 seconds, the cat is judged to have potty behavior.
- ④ If the button on the App can't be controlled and synchronized with the panel buttons temporarily, please check the network status or re-configure the network, or click the buttons on the App and repeat once or twice.

## 5.6 Schedule Clean:

Put up a clean schedule according to needs. Daily routine cleaning.

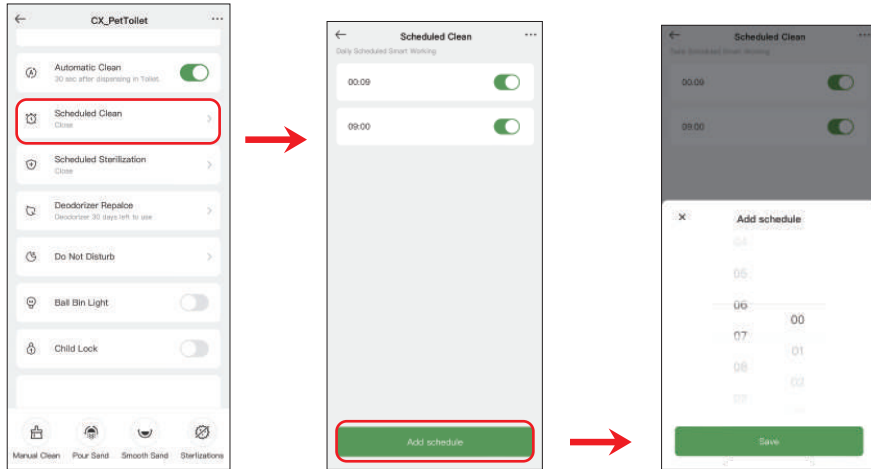

## 5.7 Deodorizer Replacement

To check how long the Deodorizer has been used and valid time for.

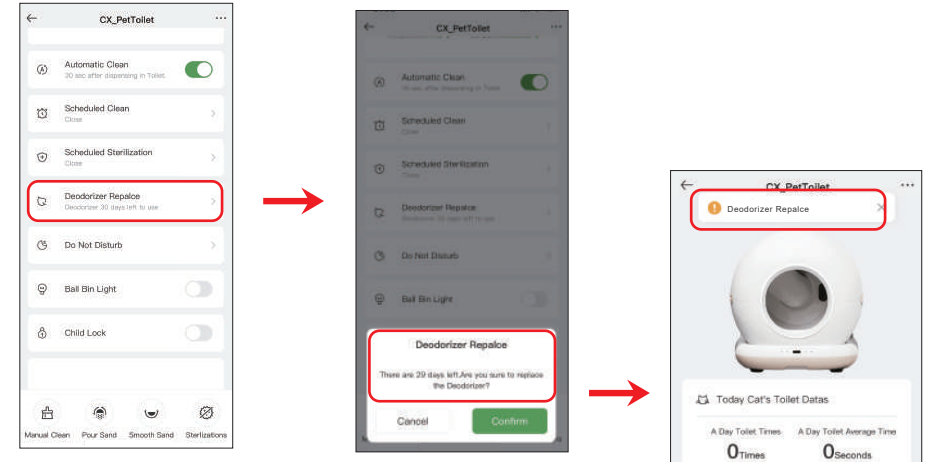

### Notice:

If there is an overlap with Do Not Disturb Mode, the device will do cleaning (not sterilised) and enter Do Not Disturb Mode again.

## 5.8 Sleep mode

When cat litter box is placed in the bedroom, you can set in the App “Do not Disturb ” to prevent the night-time activation from disturbing sleep.

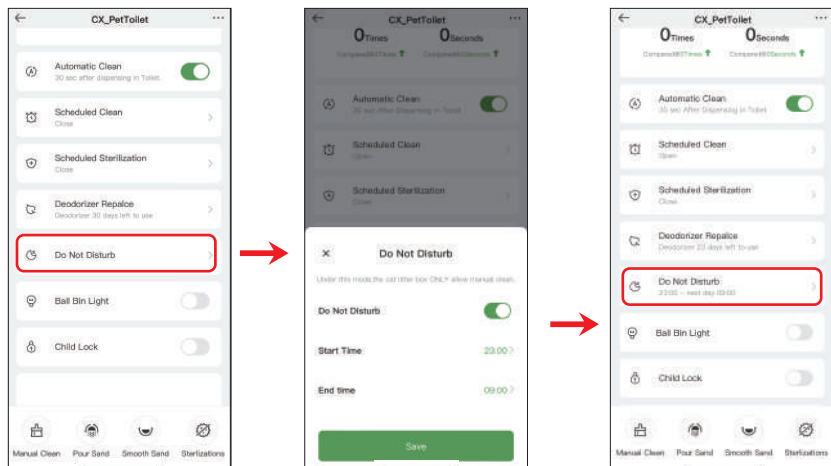

### Notice:

- ① Under Do Not Disturb mode, only support Manual Button Operation.
- ② Under Do Not Disturb Mode, the scheduled clean will still be carried out. if there is an overlap with Do Not Disturb Mode time, the device will do cleaning (not sterilised) and enter Do Not Disturb Mode again.

## 5.9 Ball Bin Light and Child Lock

- ① Click “Child Lock” on the APP to turn on or off it. or long press the “Sand Pouring” for 5 seconds to unlock the child lock.
- ② Ball Bin Light: You can turn on the light to check the inside of the ball bin in the night time.

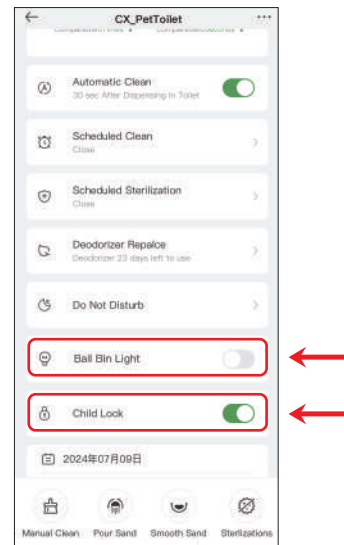

### Notice:

Child lock mode is only applicable to device front panel buttons.

## 5.10 Toilet Statistics

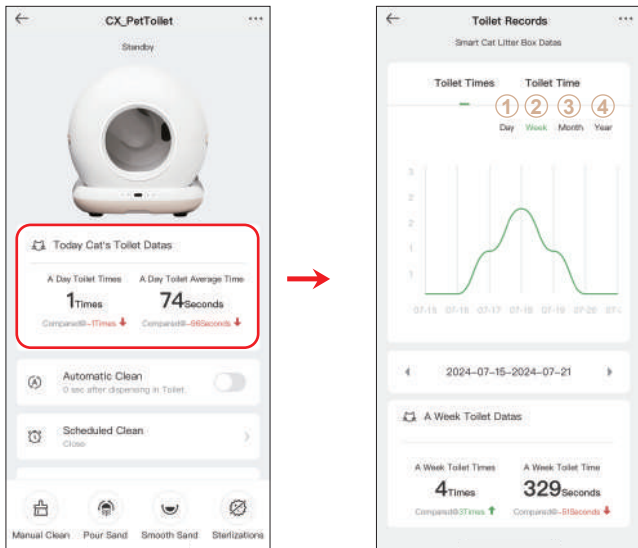

- ① Day: Check the toilet statistics of the 24 hours of a day.
- ② Week: Check the toilet statistics of a week.
- ③ Month: Check the toilet statistics every day of a month.
- ④ Year: Toilet statistics for each month of a year.

## VI Replace garbage bag

When the WiFi button Indicators in RED blink, or APP msg push "the waste bin is full", you need to change the waste bag.

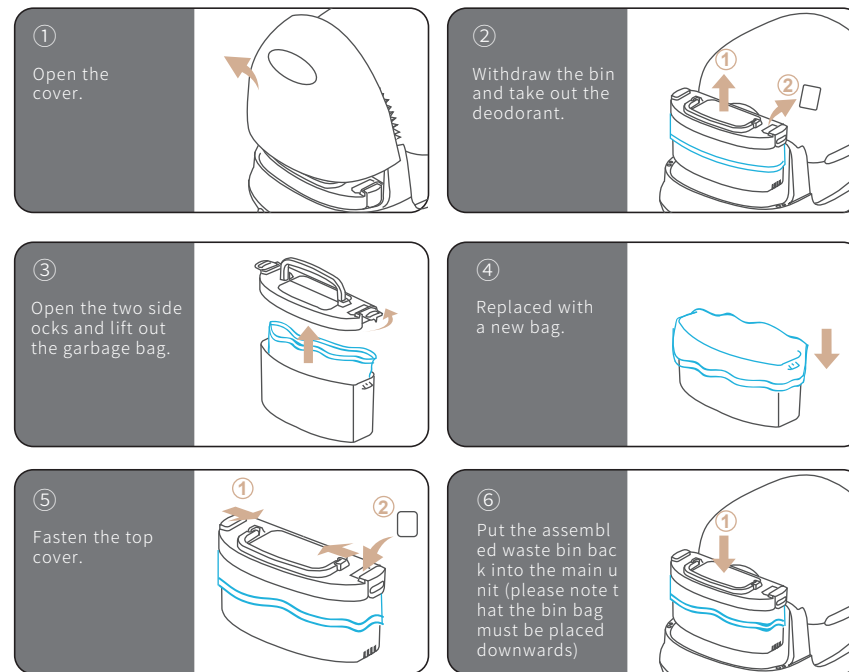

## 6.2 Wash bin:

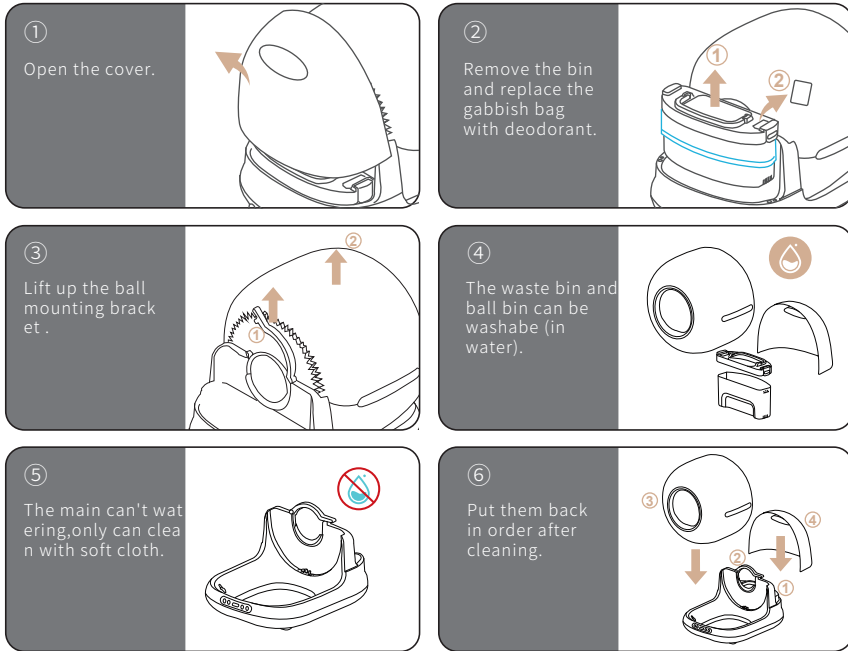

### Notice:

- ① Ball bin/waste bin including rear cover can be washed. the base can only be wiped with water.
- ② The deodorant can be used for 30 days, and in APP you can check the days it can be used.

## VII FAULT SELF-CHECK METHOD

Icon	Color	Status	Reason	Solution
WiFi	Blue	Flashing	WiFi not connected	Long press WiFi button for 5 seconds for App connection
	Red	Flashing	Full Garbage box or object blocking	Replace garbage bag or check whether there is blocked object
		Steady	Garbage cover is not installed well	Place garbage cover well
Smooth sand	Blue	Steady	Add litter without calibration, the machine stops working	Long press smooth sand button for 5 seconds or wait 5 minutes. (When cats enter, this icon will be on always)

### Notice:

If the indicator of bin sign lights up, please restart the machine or click "Clean" to make it clear.



## VIII FAQ

Q: Why does the APP's weight data not match my cat's weight?

A: Please check if it is caused by your pet's curiosity to access the device with just two feet;

Q: Why does the device not work and the control panel shows an abnormal red or blue light?

A: Please refer to the Control Panel Guide: For details on how to deal with the abnormality, please refer to the Control Panel Guide III;

Q: What kind of cat litter should be used for this product?

A: Mixed litter, tofu litter, bentonite clay, mineral sand, etc. The length should not exceed 8mm;

Q: Why does the product not work and the WiFi button light is red after replacing the litter bag?

A: When replacing the garbage bag, the edge is beyond the infrared sensing line, and the garbage bag needs to be organized and leveled out; whether there are objects in the waste bin, which cause the top of the waste bin to be on the high side, and thus the waste bin is beyond the infrared sensing line;

Q: Why is the pet weight inaccurate?

A: There is no cat litter in the product, long press the clean button for 5 seconds for product weight calibration (this operation must be done without cat litter, non-special cases are recommended not to do this operation);

Q: Why is there a blue light on the smoothing button when replacing cat litter or pets enter the ball bin?

A: Because the weighing module senses that there is cat litter or pets access to the ball bin: Because the weighing module can sense that there is an object to access, if it is to add cat litter, you can long press for 5 seconds to calibrate or wait for 5 minutes. If pets go to enter, it can be done without a hitch;

Q: Why doesn't it stop working immediately when a pet enters to Cat toilet ball ?

A: The weight sensors will take 1-2seconds to judge. Don't worry,the device is design in safty evaluations which to avoid pinching the cat . Hence, there is no risk if pet goes into ball and delay stop in 1-2 seconds;

Q: Q: Why is the cat litter not completely cleaned during the cat litter pouring operation?

A: Due to the multi-layers of cat litter being put in ball bin, as per our experiment, it is suggest to operate the sand pouring 2-times and it will be completely clean up.

Q: Why can't I upload my cat's weight as soon as my pet enters the cat litter box?

A: No, because when the pet enters the ball bin, the weight sensors detected has not yet stabilized, and the datas can only be uploaded after the weight has stabilized, it will take around 10seconds for the device system to judge and datas message push to app.

## IX PARAMETERS AND SPECIFICATIONS

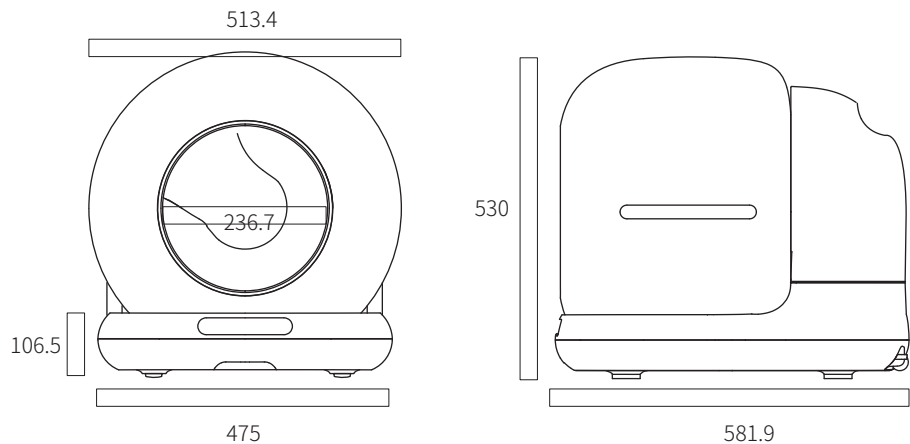

### FCC Warning

This device complies with Part 15 of the FCC Rules. Operation is subject to the following two conditions:

(1) This device may not cause harmful interference, and (2) this device must accept any interference received, including interference that may cause undesired operation.

NOTE 1: This equipment has been tested and found to comply with the limits for a Class B digital device, pursuant to part 15 of the FCC Rules. These limits are designed to provide reasonable protection against harmful interference in a residential installation. This equipment generates, uses and can radiate radio frequency energy and, if not installed and used in accordance with the instructions, may cause harmful interference to radio communications. However, there is no guarantee that interference will not occur in a particular installation. If this equipment does cause harmful interference to radio or television reception, which can be determined by turning the equipment off and on, the user is encouraged to try to correct the interference by one or more of the following measures:

- Reorient or relocate the receiving antenna.
- Increase the separation between the equipment and receiver.
- Connect the equipment into an outlet on a circuit different from that to which the receiver is connected.
- Consult the dealer or an experienced radio/TV technician for help.

NOTE 2: Any changes or modifications to this unit not expressly approved by the party responsible for compliance could void the user's authority to operate the equipment.

### RF Exposure Statement

To maintain compliance with FCC'S RF Exposure guidelines, This equipment should be installed and operated with minimum 20cm between the radiator and your body. This device and its antenna(s) must not be co-located or operation in conjunction with any other antenna or transmitter.

Product Name Smart Cat Litter Box	Product Model CB001	Whole Machine Size 513.4(W)x581.9(D)x530(H)mm
Rated Voltage DC12V-1.5A	Rated Power ≤18W	Suggested Pet Type Cat