

Digital Mobile Radio

DM660 VHF

Quick Start Guide

LEGAL INFORMATION

Copyright ©SATELRADIO TELECOMUNICACAO LTDA 2024

No part of this publication may be quoted, reproduced, translated or used in any form or by any means, electronic or mechanical, including photocopying and microfilm, without the prior written permission of Axiom Distribution Solutions. Violators Will Be Prosecuted. SATELRADIO TELECOMUNICACAO LTDA reserves the right to make modifications on typographical errors or update specifications in this guide without prior notice. The figures in this manual are for reference only. For the product structure and specifications of the battery and charger, please refer to the actual product. The accessories provided with the product may vary with product models and functions.

SAFETY INFORMATION



For your safe and efficient use of our products, Please read all warnings carefully before using the radio:

- This equipment should be installed and operated with minimum distance 1.5m between the radiator& your body.
- Maintain a safe use distance of at least 150cm .
- Confirm that the sample is embedded and only the screen part is exposed to avoid high-temperature burns on the metal shell.
- Maintenance must be carried out by professional technicians. Do not disassemble and assemble without permission.
- Setup and installation must be approved by the local radio authority.
- Lightning protection measures must be taken when installing antennas. Otherwise, serious loss of life and property may occur.
- Make sure to use qualified accessories such as power supply, antenna, lightning arrester, feeder line, power divider and install them correctly. Otherwise, the digital indoor base station may be damaged.

Disclaimer

In the process of compiling this manual, we strive to ensure the accuracy and completeness of the content. However, our company does not assume any responsibility for any errors or omissions that may occur. Due to the development of technology, we reserve the right to change product design and specifications without notice.

Because this product involves upgrades or improvements, our company reserve the right to change the software and hardware specifications described in this manual at any time without prior notice. The product specifications and information mentioned in this manual are for reference only. The pictures in this manual are only schematic drawings. If there is any inconsistency between the pictures and the actual objects, the actual objects shall prevail. According to the model and function of the product you buy, the accessories may be different, please refer to the actual material.

Radio radiation information

This product is limited to occupational applications that meet radio-frequency energy radiation requirements. Users must clearly understand the hazards of RF radiation and take appropriate measures to meet the requirements of RF radiation limits.

Content

1 Product Information	4
1.1 Accessories.....	4
1.2 Product Notice.....	4
1.3 Operating panel & interface information	4
2 Product Installation.....	6
2.1 Installation requirements	6
2.1.1 Installation environment.....	6
2.1.2 Installation site.....	6
2.1.3 Installation tool.....	6
2.2 Preparation before installation.....	7
2.2.1 Supply check	7
2.2.2 Product check	7
2.2.3 Parameter configuration	7
2.3 Installation procedure.....	7
3 Status indication	7
3.1 LCD icon.....	7
3.2 LED indicator	8
4 Basic operation	8
4.1 Power on/off.....	8
4.2 Channel/volume switching	8
4.3 Power switching	8
5 Troubleshooting guide	9
6 Maintenance and cleaning.....	9
6.1 Maintenance	10
6.2 Cleaning	10

1 Product Information

1.1 Accessories

Accessory	Quantity
Mobile	1
DC power cord	1
handheld microphone	1
Mobile holder	1
GPS antenna	1
Operating manual	1
Warranty card	1

1.2 Product Notice

- Operating temperature $-30^{\circ}\text{C} \sim 60^{\circ}\text{C}$, work in a ventilated and dry environment.
- Power off the device when installing, and power on the device after all accessories installed.
- Do not touch the antenna port to avoid burn when device is working.
- Do not disassemble or modify the equipment at will to avoid breakdown or accident.
- Do not operate with wet hands to avoid personal injury or device failure.
- Keep the device away from corrosive solid/ liquid/ gases.

1.3 Operating panel & interface information

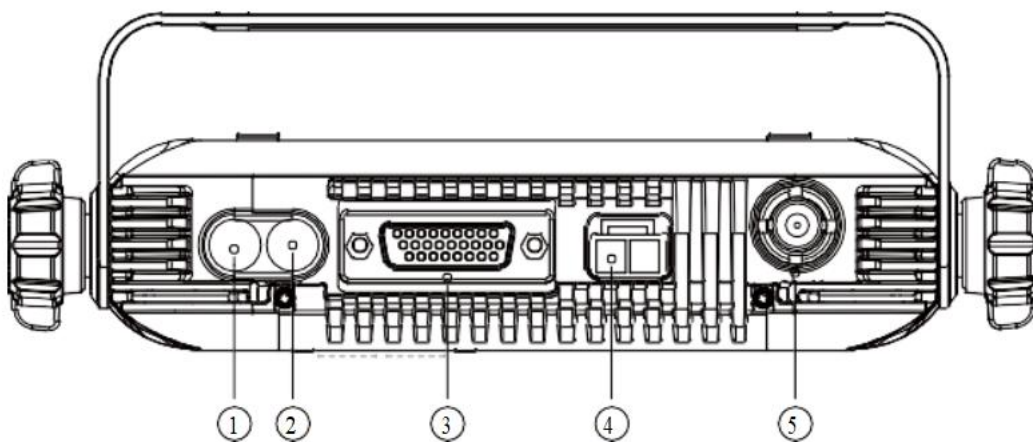

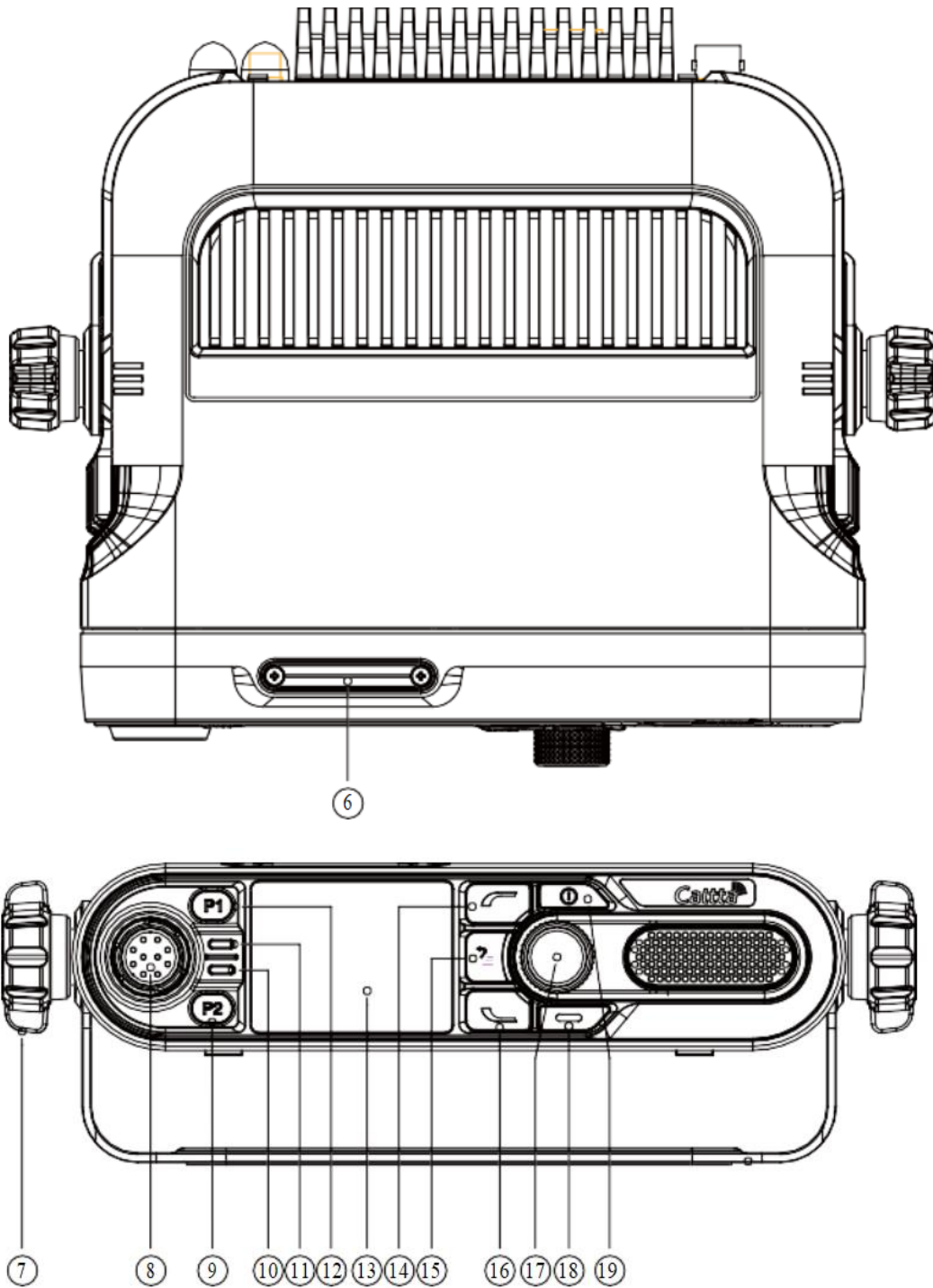

No.	Name	Function	No.	Name	Function
1	Reserved interface	/	11	LED indicator	Indicate the transmitting and receiving status
2	GPS	Connect the external GPS	12	Program	Run the preset function, default

	antenna connector	antenna		able button 2	as power level
3	DB26 accessory connector	Connect the accessory	13	LCD	Display the current information
4	Power connector	Connect the power supply	14	Hook key	Return to main interface
5	Antenna connector	Connect the antenna	15	Menu/Back key	Enter the menu in standby interface, or return to the previous menu
6	Reserved interface	/	16	Call/Answer key	Enter the contact menu (in standby interface)
7	Locking Knob	Fix the mobile radio	17	Volume/Channel/OK/Menu knob	Adjust the volume in volume mode; Rotate to select the channel in channel mode, short press to select the channel; Rotate to view the menu, press to select the menu
8	Palm microphone connector	Connect the palm microphone to make PTT call	18	Emergency key	Programmable button, default as emergency alarm switch on/off function
9	Programmable button 2	Run the preset function, default as squelch switch	19	Power key	Long press to power on/off the device
10	Reserved	/			

2 Product Installation

2.1 Installation requirements

2.1.1 Installation environment

The product must be installed in the environment where the temperature $-30^{\circ}\text{C}\sim+60^{\circ}\text{C}$, the relative humidity $< 95\%$, dry and ventilated.

2.1.2 Installation site

The product can be installed on racks and supports, or placed on a workbench.

2.1.3 Installation tool

The following tool is required to install: cross screwdriver.

2.2 Preparation before installation

2.2.1 Supply check

The DC power supply or battery is used. Check whether the DC power supply voltage or the battery voltage is within the operating voltage range($13.6V \pm 15\%$).

2.2.2 Product check

After the device is powered on, check whether the LCD display and LED indicators on the panel are normal.

2.2.3 Parameter configuration

After confirming that the product is running properly, configure the product parameters such as operating frequency, transmitting power.etc, by using CPS based on actual requirements. Then you can enter the field installation.

2.3 Installation procedure









Procedure as follows:





- 1、 Install this product in the required location.
- 2、 Connect the accessories such as antennas, feeder lines and power cords to this product.

3 Status indication

3.1 LCD icon

The meanings of different ICONS on the LCD as follows:

Icon	Status	Icon	Status
	Signal strength		Current channel in low-power transmission state
	Unread short messages		Current channel in high-power transmission state
	Inbox is full		Prompt tone is silent
	The device is in scanning state		Interphone is silent

	The device is in roaming state		GPS positioning
	Have a call		On the line
	Miss a call		

3.2 LED indicator

Indicator Status	Product status
Red light keeps on	TX work
Green light keeps on	RX work
Orange light keeps on	Call successfully, but there is no voice transmission on the service channel. In this case, you can press the phone PTT to talk.
Orange light flashes quickly	Be scanning

4 Basic operation

4.1 Power on/off



When the mobile is in power-off state, long press for more than 3 seconds, then the LCD will light up and enter the power-on state.

When the mobile is in power-on state, long press for more than 3 seconds, then the device will shut down.

4.2 Channel/volume switching

The channel can be set by CPS, then switched by channel/volume knob.

4.3 Power switching

The device can be set to high or low power through CPS, or switched by setting programmable keys 1 and 2. LCD displaying  indicates high power status, while displaying  indicates low power status.

5 Troubleshooting guide

Problem description	analysis	solution
Power on fail	Check whether the power button works properly and the power cord is connected reliably.	Connect the power cord correctly and reliably, hold down the power button for more than 3 seconds, and the LCD will light up.
The mobile can not communicate properly	The frequency of TX of mobile do not match that of RX.	Check whether the communication frequency is matched and set it as the matching frequency.
	The working frequency is interfered by strong signal.	Locate the interference source. If the interference source cannot be turned off, keep away from it or change the signal frequency.
	The terminal is not in range of the mobile signal	Get back in range of signal to talk.
The terminal receives a receiving tip, but the system group can not communicate properly.	The ID number of the terminal is the same as that of other members in the group.	Set an ID number that is different from that of other group members.
	The ID number is not in the group list.	Check whether the ID is in the group list. If it is not, add the terminal ID to the group list.
	The CTCSS/CDCSS of the terminal does not match that of the channel machine.	Check whether the CTCSS/CDCSS matches and reset if necessary.
Talking range is short, or the voice is not clear.	Connection cable is damaged.	Check the cable , and replace it if necessary.
	The antenna port and cable connector are loose or off	Check the joint, tighten the joint, and replace it with a new one if necessary.
	Internal damage to the cable.	Replace new cable.

If the above methods still do not solve your problem, or you encounter some other problems, please contact your local dealer or our company for more technical support.

6 Maintenance and cleaning

In order to ensure the good performance of this product and extend its service life, please be familiar with the following content to better maintain and clean this product.

6.1 Maintenance

- Please ensure the product in an environment that is ventilated and easy to heat dissipation, so that each component works normally.
- Do not place irrelevant items on this product to ensure effective heat dissipation.
- Do not puncture or scratch this product with hard objects.
- Do not store this product in an environment that contains substances that corrode electronic circuits.
- Do not immerse this product in any caustic, solution or water.

6.2 Cleaning

- Please use a clean and dry lint-free cloth or brush regularly to wipe the dust attached to each part of the product to keep it clean and prevent poor contact.
- If the buttons, control knobs, display and interfaces of this product become dirty, they can be cleaned using a non-woven cloth dipped with neutral detergent. Do not clean with strong corrosive chemicals such as detergent, alcohol, sprays or petroleum preparations.
- After cleaning, ensure that the product is thoroughly dry, otherwise do not use.

7 MAIN TECHNICAL SPECIFICATIONS

Transmitter Frequency :	VHF:136-174MHz
Receiver Frequency :	VHF:136-174MHz GPS L1 C/A,BDS L1I,Glionass G1:1559-1610MHz
RF-Output Power: ERP/EIRP/Conducted	50 Watts(High) 5 Watts(Low)
FM Modulation	12.5KHz:11K0F3E
4FSK Digital Modulation(Data only)	12.5KHz: 7K10FXD
4FSK Digital Modulation(Voice only)	12.5KHz: 7K10FXE
4FSK Digital Modulation(Voice and Data)	12.5KHz: 7K10FXE, 7K10FXD
Antenna Gain	3.5dBi

Note:The length of antenna connected cable is 3m and the cable loss is 0.9dB.

This equipment is marked



According to the requirements in the Radio Equipment 2014/53/EU Directive, the radio equipment DM660 VHF series is Class 2 and can be used in any European Union countries subject to authorization by the competent Authority for the type of service in each country.



BE	BG	CZ	DK	DE	EE	IE	EL
ES	FR	HR	IT	CY	LV	LT	LU
HU	MT	NL	AT	PL	PT	RO	SI
SK	FI	SE	NO	IS	LI	CH	TR

FCC Caution

Any Changes or modifications not expressly approved by the party responsible for compliance could void the user's authority to operate the equipment.

This device complies with part 15 of the FCC Rules. Operation is subject to the following two conditions:

1. This device may not cause harmful interference
2. This device must accept any interference received, including interference that may cause undesired operation.

NOTE: This equipment has been tested and found to comply with the limits for a Class B digital device, pursuant to part 15 of the FCC Rules. These limits are designed to provide reasonable protection against harmful interference in a residential installation. This equipment generates, uses and can radiate radio frequency energy and, if not installed and used in accordance with the instructions, may cause harmful interference to radio communications. However, there is no guarantee that interference will not occur in a particular installation. If this equipment does cause harmful interference to radio or television reception, which can be determined by turning the equipment off and on, the user is encouraged to try to correct the interference by one or more of the following measures:

- Reorient or relocate the receiving antenna.
- Increase the separation between the equipment and receiver.
- Connect the equipment into an outlet on a circuit different from that to which the receiver is connected.
- Consult the dealer or an experienced radio/TV technician for help.

– This radio is designed for and classified as “**Occupational/Controlled Use Only**”, meaning it must be used only during the course of employment by individuals aware of the hazards, and the

ways to minimize such hazards; NOT intended for use in an General population/uncontrolled environment

– DO NOT operate the radio without a proper antenna attached, as this may damage the radio and may also cause you to exceed RF exposure limits. A proper antenna is the antenna supplied with this radio by the manufacturer or an antenna specifically authorized by the manufacturer for use with this radio.

– DO NOT transmit for more than 50% of total radio use time, more than 50% of the time can cause RF exposure compliance requirements to be exceeded.

– During operation, if the antenna gain of the antenna used is 3.5dBi, the distance between the user and the antenna should be at least 1.07m, this separation distance will ensure that there is sufficient distance from a properly installed externally-mounted antenna to satisfy the RF exposure requirements.

– During transmissions, your radio generates RF energy that can possibly cause interference with other devices or systems. To avoid such interference, turn off the radio in areas where signs are posted to do so. DO NOT operate the transmitter in areas that are sensitive to electromagnetic radiation such as hospitals, aircraft, and blasting sites.

COMPANY INFORMATION

SATELRADIO TELECOMUNICACAO LTDA

AV.FRANCISCO MATARAZZO, 1752, SALAS 516, AGUA BRANCA, SAO

PAULO/SP, BRAZIL

+55(11) 3090-4094