

PLEASANT LITTER EXPERIENCE
FOR BOTH CATS & CAT FANCIERS



Please scan
the code to watch
the guide video.

+ Smart Cat Litter Box +

User Manual

BEFORE USE

1. Please place the device on a firm and flat ground.
2. Please add litter below MAX line after placing the device well.
3. Please power on the device and wait it to finish self-check.
Then it is ready to use.



CONTENT

BEFORE USE.....	01
I INSTRUCTIONS FOR THE FIRST USE.....	03
II APP	07
III OPERATING INSTRUCTIONS	11
IV FAULT SELF-CHECK METHOD.....	28
V FAQ	29
VI PRODUCT LIST	31
VII INTRODUCTION OF CONTROL PANEL	32
VIII CIRCUIT DIAGRAM	33
IX PARAMETERS AND SPECIFICATIONS.....	34

Cautions:

1. Please install and use this device according to the instructions.
2. Please use it indoors, do not place it in direct of sunlight or and fire sources.
3. Please place the device on a flat hard surface, and do not place articles on the top of the device.
4. Do not drag or place vigorously during placement to avoid device damage.
5. Cats weighing less than 1kg and lactating cats should not use the device under auto cleaning mode.
6. Do not soak or immerse the electric parts of this device.
7. Please unplug the power cord when moving, cleaning the device, or not using it for a long time.
8. Please use the original power adapter to avoid damage to the device or potential safety hazards.
9. If children use this device, please make sure to use it under the guidance of parents or guardians.
10. Please perform maintenance under the guidance of professionals to avoid all kinds of damages.
11. If you encounter product related issue, please contact our customer service.
12. Please read this manual carefully before use. Once installed and used, it is seen that you have carefully read and accepted the following safety instructions.
13. If the product does not work correctly due to other unknown conditions, please simply restart the power by unplugging and plugging-in the cord.

I INSTRUCTIONS FOR THE FIRST USE

1.1 Unpacking:

Turn over the carton to cut the tape from the bottom, then turn over the carton to pull up the carton vertically.

1.2 Placement:

Place the device on the flat ground and make sure all four feet of the product contact the flat and hard surface.

To avoid the cat identification sensor malfunction, please keep a 1 ft clear space for the device if the object is over 2 inches tall.

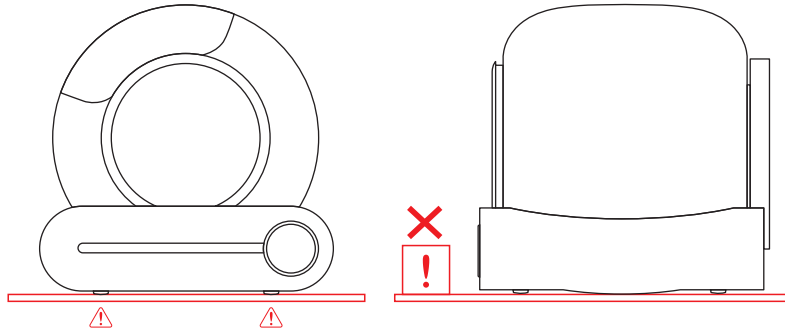

Notice:

- ✓ The four feet of the product must be in contact with a firm flat ground!
- ✗ Place the machine on the soft carpet.
- ✗ Place the two front feet of the device on the cat litter mat or rug.

1.3 What is in the box?

Power Adapter with Anti-bite Cord x 1

Manual x 1

Garbage Bag x 1 roll

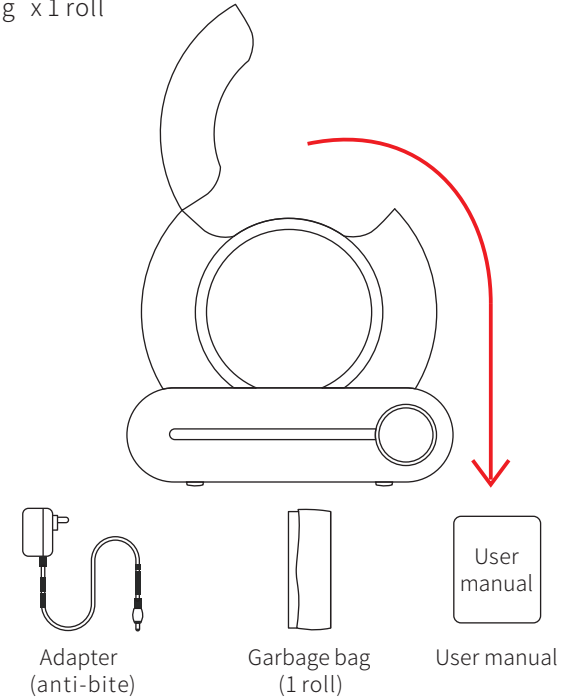

Notice:

Please review the installation instructions of garbage bags, or scan the code below to watch the video.

1.4 Adding Litter:

Make sure the leveled litter height is between the MAX line and the MIN line (based on your actual need).

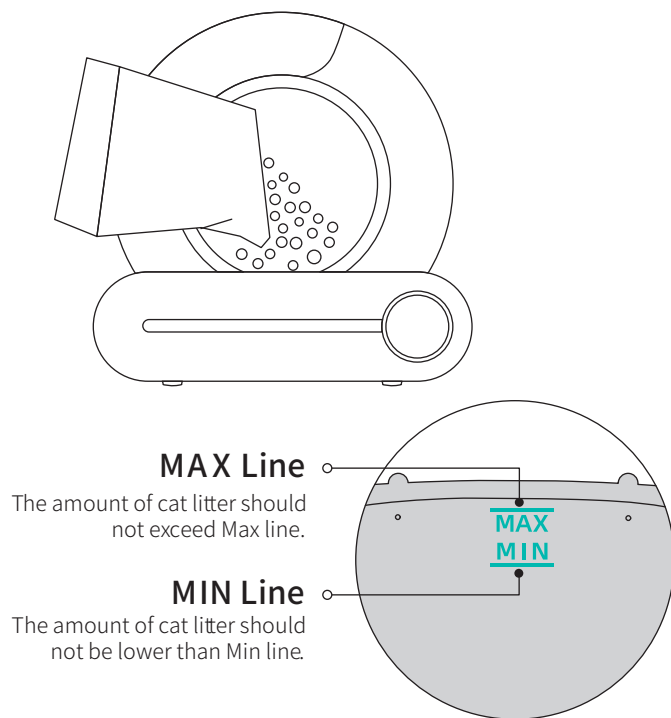

1.5 Power On:

- 1.5.1 Power on the device with plugging in the adapter and wait for the machine to self-check for about 3-8 minutes. It will automatically enter the sensing stage after self-check. No need to change its mode at this point.
- 1.5.2 After the cat litters and leaves, the device will automatically clean up in 3 minutes to allow enough time for the cat leaves and cat excrement clumps. Then the cleaning process will take 4 minutes to complete.
- 1.5.3 After cleaning, the device will automatically start the smell elimination and disinfection process which will last around 30 minutes.

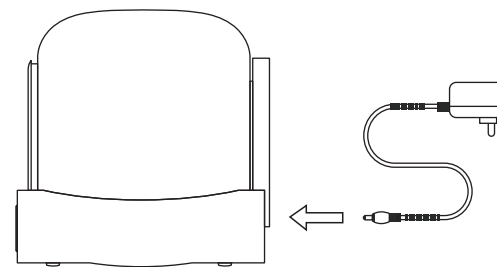

Notice:

- ✗ Pick up or drag the device after powering up. (This will interfere with weight calibration in the reset program.)
- ① If you place the device in a narrow space, or there is an infrared interference source in front of the device, the device self-check may take about 8 minutes. Please wait patiently.
 - ② Suppose the sensor has detected the space is not suitable for work. In that case, the detection function will be automatically disabled after the self-check is completed. The weight detection system will detect whether the cat enters automatically.
 - ③ During the cleaning process, all keys will be suspended. Please wait until the cleaning process is completed if you need the device to perform other functions.

II APP

2.1 App Installation



Method 1: You can scan the above QR Code with your mobile phone



Method 2: You can download "tuya" App from the App store.

2.2 Networking:

2.2.1 Confirm that the phone is connected to 2.4G WiFi, then turn on the Bluetooth and Location

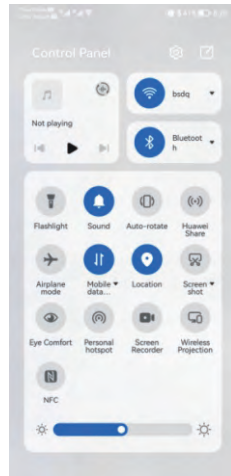

2.2.2 Press "Auto" for 2 seconds, when the WiFi indicator starts flashing, the device is ready to be connected.

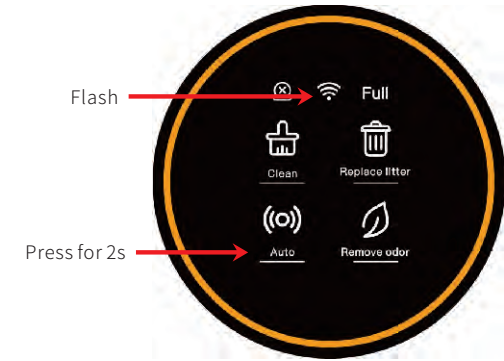

2.2.3 Open the App to add equipment or let the App scan automatically.

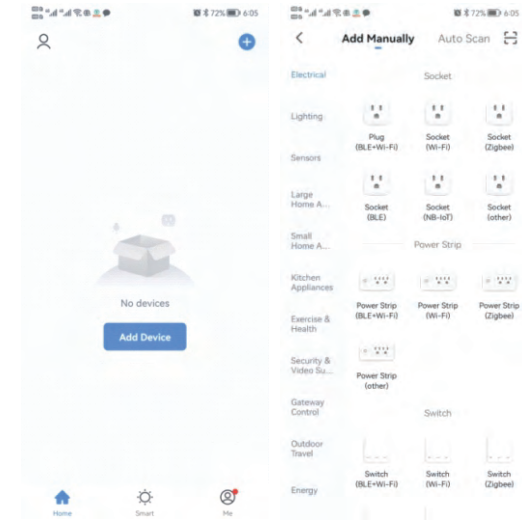

2.2.4 Press "Next" after scanning the device.

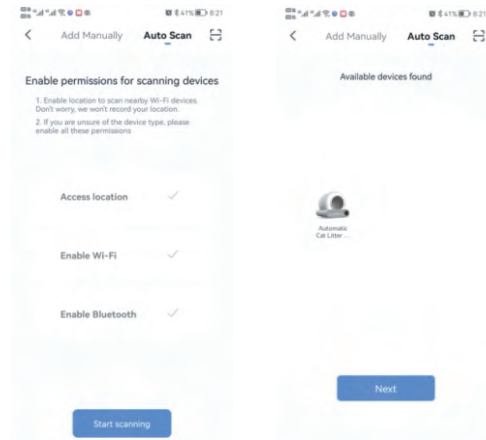

2.2.5 Press "Next" after entering the WiFi password and wait to connect.

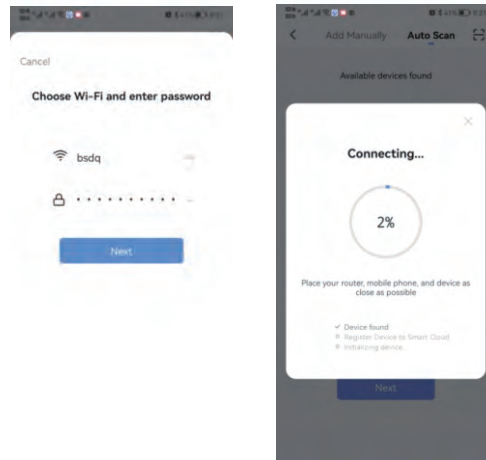

2.2.6 Enter APP after connecting.

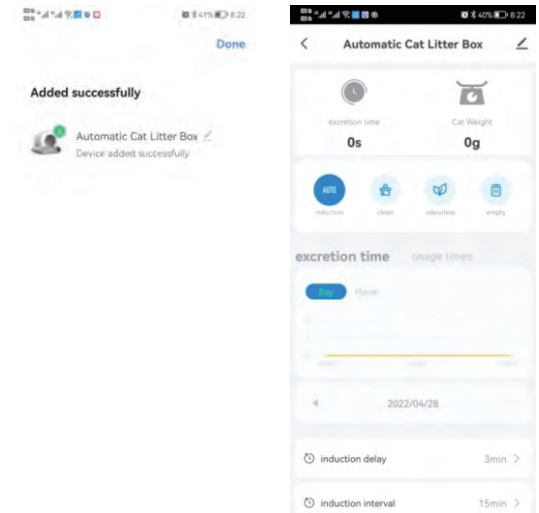

Notice:

If the network configuration fails or a timeout message is displayed, please follow the connections fix process as below:

- ① WiFi, Bluetooth, and Location switch are enabled simultaneously.
- ② WiFi connection is in the 2.4G band network. (The product can not recognize the 5G band network.)
- ③ WiFi indicator is flashing during network configuration.
- ④ WiFi network in your home is functioning
- ⑤ WiFi password is correct.
- ⑥ WiFi signal is weak and the WiFi needs to be closer to the device.
- ⑦ The router connects to many wireless devices, causing IP address conflicts.

III OPERATING INSTRUCTIONS

3.1 Auto Mode:

Click "Auto" on the panel or the App to start auto-sensing for cats in / out and auto cleaning. It is the default mode once the device has powered-on and self-checked.

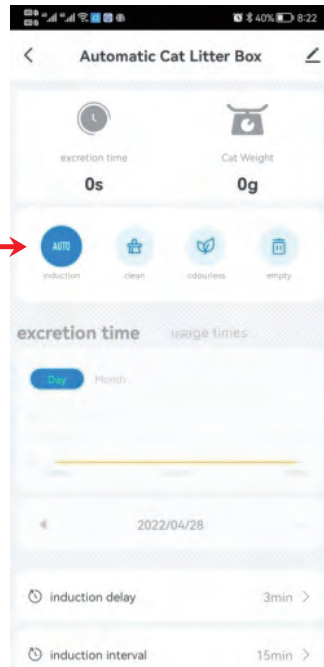

Notice:

- ① Please click "Auto" on the panel or the App to turn-off the auto-sensing feature if the cat is less than 2.2 lb (1kg) or the cat is pregnant. When the device needs cleaning, you will need to click "Clean" to start the cleaning process.
- ② To clean litter quicker, you can adjust the "cleaning wait time" in the App, for example, 1 minute, in that way you can clean as quickly as possible and reduce the smell. For families with two or more cats, you can adjust the "cleaning interval" in the App to avoid repeated ineffective cleaning of the device.
- ③ If the cat enters the bin for more than 10 seconds, the cat is considered to have potty behavior. After the cat leaves for 3 minutes, the automatic cleaning procedure will be performed. (The default interval between cleanups is 15 minutes to prevent the device from cleaning too frequently during multiple cats' use. The device might not work after the second cat pees; the interval of two pees is less than 15 minutes.)
- ④ If the App froze, please check the network status or re-configure the network, or click the corresponding button on the App and repeat once or twice.

3.2 Clean Mode:

Click "Clean" on the panel or the App to start cleaning process.

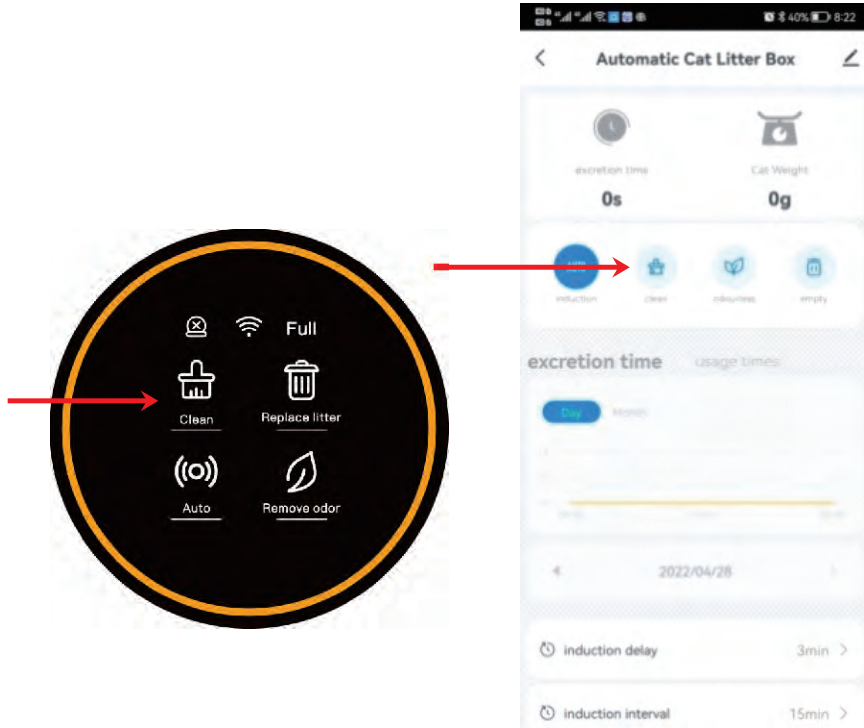

Notice:

- ① During the cleaning process, all keys will be disabled. If you need to perform other functions, please wait until the cleaning process is complete.
- ② Extend the cleaning time in the phone App when the cat has diarrhoea. It allows the cat litter to take enough time to clump and reduces the pollution of soft feces to the bin.
- ③ If you have restarted the device, the waiting time of the "Cleaning" procedure will be restored to the default by 3 minutes, which can be reset in the APP if necessary. (setting range: 0 to 60 minutes)
- ④ Extend the interval between two cleanings when you have multiple cats, preventing repeated device cleaning.
- ⑤ If you have restarted the device, the interval time between two clearings will be restored to the default by 15 minutes, which can be reset in the APP if necessary. (setting range: 0 to 120 minutes)

3.3 Add cat litter:

Method 1:

In "Auto" mode, when the adding cat litter is more than 2 lb (1kg), the "Auto" will start flashing. After 30 minutes, the cat litter will be automatically smoothed, and the weight will be calibrated.

Hold the 'Remove odor' button for 2 seconds or more to adjust the time. The cat litter will be smoothed, and the weight will be calibrated immediately.

Method 2:

Please turn off the power, add the litter and turn on the power.

Notice:

- ①The machine will not interrupt when it is smoothing litter, even the cat enters. The device spins gently and will not hurt cats. During cleaning process the device has protection and it will stop once the cats get close to the entrance.
- ②Please make sure the height of the litter is between the MIN line and MAX line. If not, please adjust the amount of litter using method 2.
- ③You can find the litter surface level correction option on the App to adjust the litter position manually. (For grade 0, the litter surface leans to the right, and in grade 6, the sand surface leans to the left.)

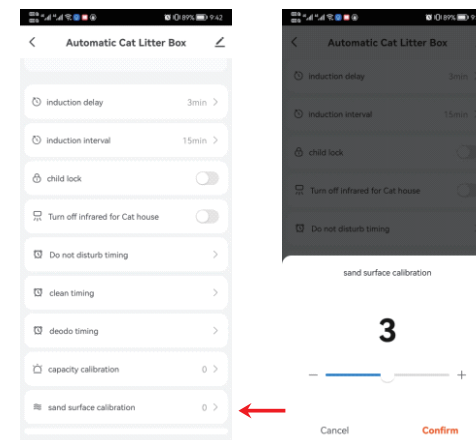
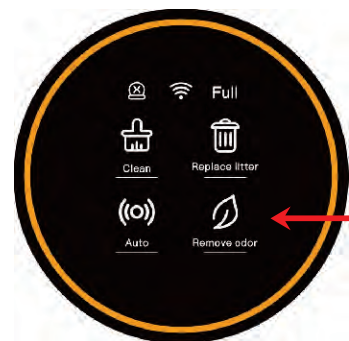
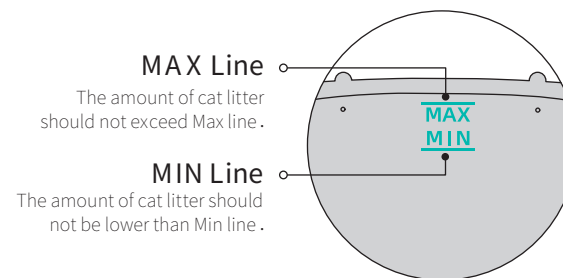
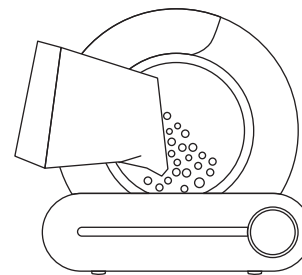

3.4 Replace litter:

- ① Replace the garbage bag with a new one (the original one is already full of polluted litter and bacteria)
- ② Make sure the remaining litter is close to the MIN line (to avoid the overflow when the bin rotates)
- ③ Press "Replace Litter" for 2 seconds, then wait for the device to clear the rest litter (about 3 minutes)
- ④ Replace the garbage bag with a new one again after clearing litter

Notice:

- ① Click "Replace Litter" again to cancel if you clicked it by mistake or forgot to replace the garbage bag.
- ② For fine mineral litter, when replacing the bag (step ①), you can hold the "Clean" button for 2 seconds to avoid the overflow from the bag opening. The litter bin will rotate 90° counterclockwise to ensure that the opening of the bag is upward when replacing. After replacing garbage bag, repeat ③ and ④.

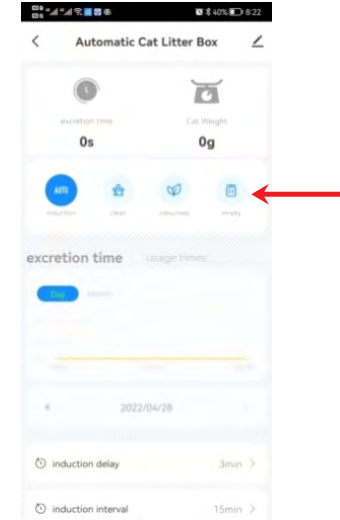

3.5 Remove Odor:

Method 1:

Click "Remove Odor" on the panel or click "Odorless" on the App.

Method 2

Set regular work on your App.

Notice:

- ①The device will remove odor automatically for 30 minutes after every cleaning.
- ②It will stop once the cat enters and continue to work after the cat leaves.

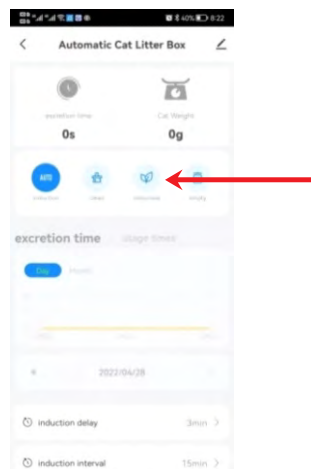

3.6 Replace Garbage Bag:

When indicator "Full" is on, you will need to replace the garbage bag.

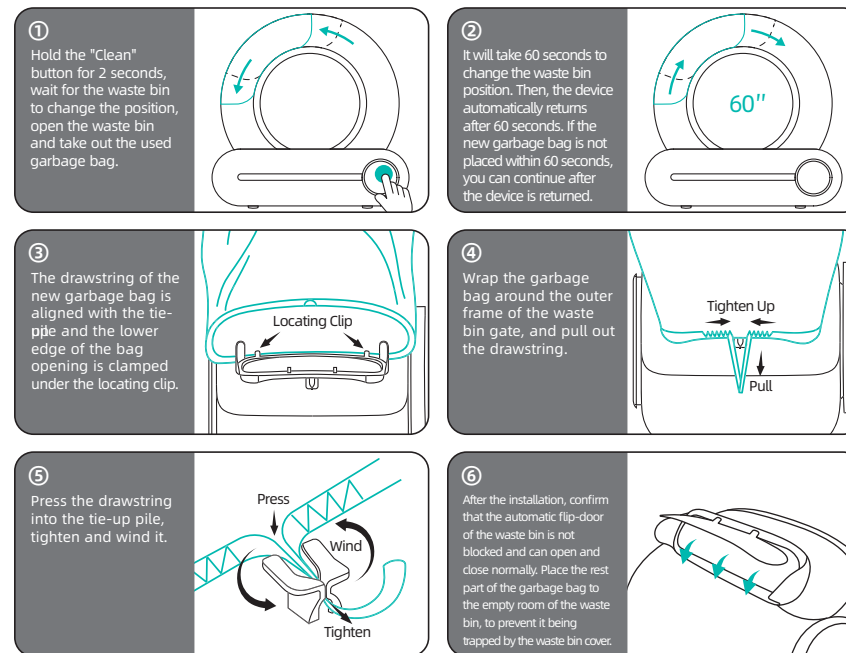

Notice:

- ①The "Full" indicator is only for reference. The "Full" indication may vary depending on the cat litter volume, density, and fluidity. You can adjust the delay of the "Full" sign on the App based on your preferences. The default is 0 (there is still a little space in the bag for garbage), and the maximum value is 15.
- ②If you have restarted the machine, the delay of the "Full" prompt will be restored to the default, which is 0. It can be reset in the APP if necessary.
- ③Normally, the waste bin storage capacity of 1 cat can be up to 15 days, and for 3 cats can be up to 5 days. Users can replace the garbage bag every five days, depending on the actual situation.

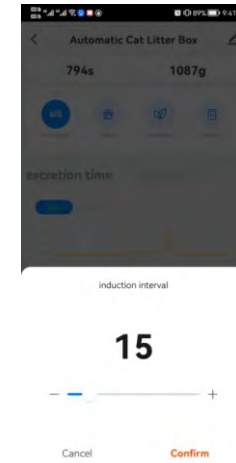
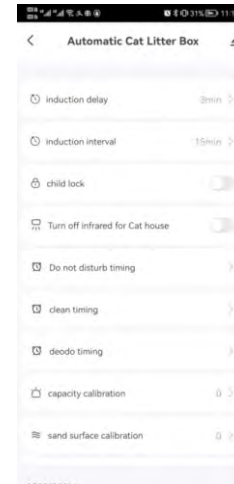

3.7 Wash Barrel:

- ① Power off the device first!
- ② Open the buckle of the barrel compartment and lift the bin.
- ③ Wash and dry the barrel before placing it back on the base!

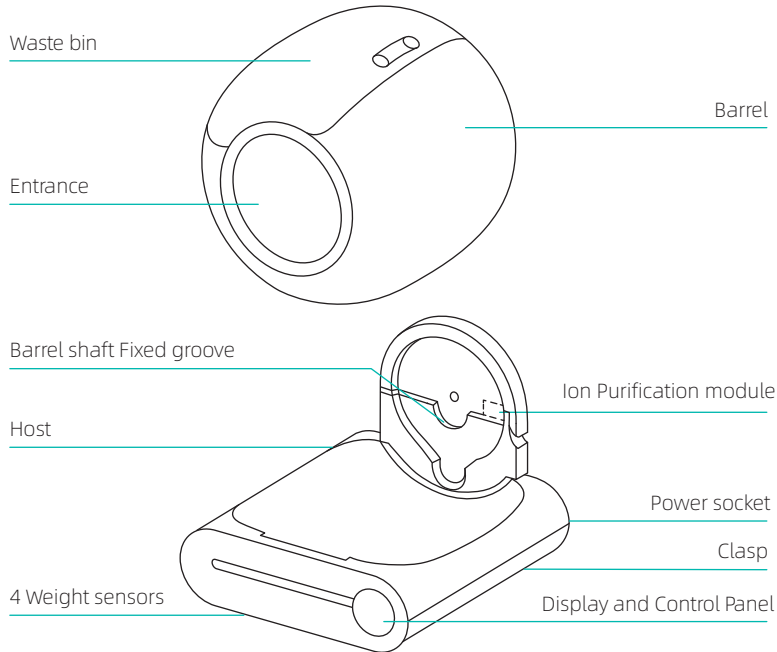

Notice:

If the indicator of the Bin sign is on, please restart the machine or click "Clean".

3.8 Lock the Panel:

Press the "Auto" and "Remove Odor" at the same time for more than 2 seconds to turn on and off the "Child Lock". You can also use the "Child Lock" button on the App.

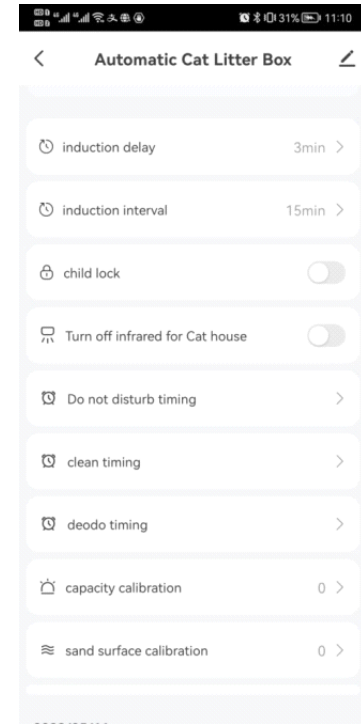

"auto" + "Remove odor" 2 seconds

3.9 Turn On / Off the Infrared Sensor:

Press "Clean" and "Replace litter" at the same time for more than 2 seconds if the device is placed in a cage or a narrow space. Or click the bucket infrared sensor option in the APP to turn on or off the bucket infrared sensor.

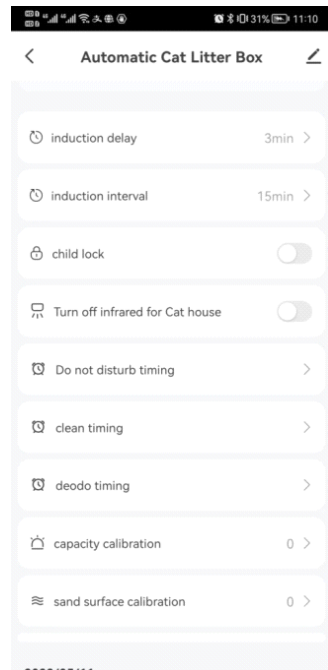

"Clean" + "Replace litter" 2 seconds



3.10 Timing:

3.10.1 Sleep Mode

When the device is placed in the bedroom, you can set in the App "Do not Disturb Timing" to prevent the night-time activation of the device.

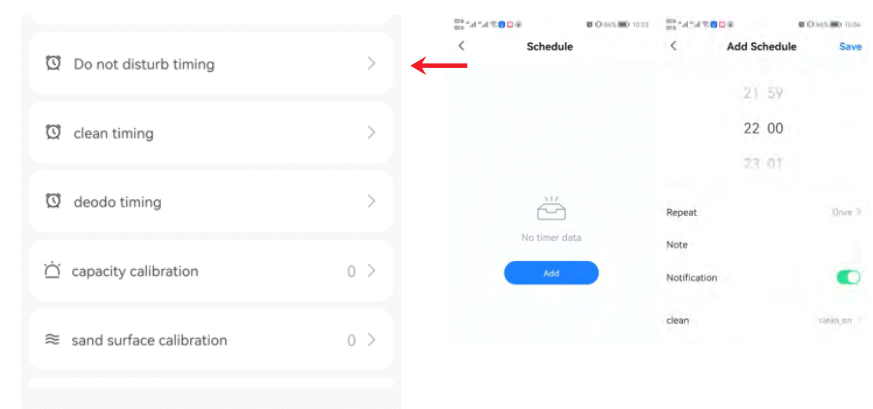

Notice:

- ①When the DND (Do not Disturb) mode is on, the light on the panel will be off. Touch any button to exit the DND (Do not Disturb) mode.
- ②If the device is clearing when setting DND (Do not Disturb), it will enter the DND (Do not Disturb) stage after the cleaning is complete.

3.10 Scheduled Cleaning:

3.10.2 Regular cleanup mode

Set the device to clean regularly in the App "Clean Timing".

3.10.3 Timing Odor Removing:

Set the device to remove odor regularly in the App "Deodo Timing".

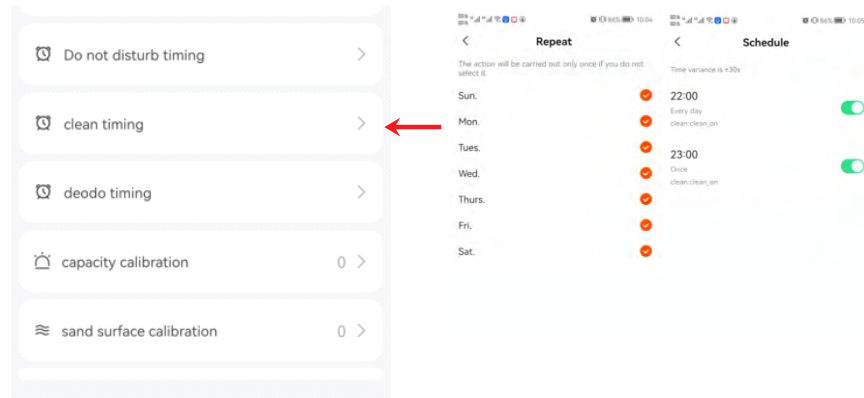

Notice:

Suppose the execution time of these scheduled procedures overlaps with the DND (Do not Disturb). In that case, the product will first perform odor cleaning and then return to DND mode.

IV FAULT SELF-CHECK METHOD

4.2 Testing Mode:

- ① Press each key to check whether the key works properly. If it works properly, the PCB hardware is functioning correctly.
- ② Press the device from the top with a force of more than 2.2 lb (1kg) to see whether the "Full" indicator flashes. If it does, the gravity sensor is functioning correctly.
- ③ If the Bin indicator keeps lighting up, the motor is working correctly.
- ④ If the WiFi indicator keeps lighting up, the WiFi hardware is functioning correctly.
- ⑤ Cover the infrared sensor at the barrel entrance, if the "Auto" mark flashes, the sensor functions correctly.

4.3 Restart the device after the testing mode is completed.

V FAQ

Q: Why is the weight data only about half of that of my cats?

A: Please check if the cat enters only halfway out of curiosity, or if the device is placed on flat ground and a hard surface.

Q: Why is the App showing motor failure, why is the fault indicator lighted on the equipment panel/why is the equipment always self-checking?

A: If the self-check takes more than 15 minutes, the fault indicator is on. It may be that the barrel compartment is not installed correctly or something is stuck. Please open the buckle of the barrel compartment, lift the barrel to inspect, and then put it back according to the tips (on the base) and close the buckle.

Q: Why does the clearing takes so long?

A: Lower revs make timid cats less scared. It will prolong the whole clearing time if cats enter or come closer frequently out to curiosity.

Q: Why the machine rotates back for a while before finishing the whole rotation?

A: To save litter and increase the capacity of the collection bin.

Q: Why the poop can't be cleaned in the garbage box?

A: It could be caused by garbage bag jam by cat litter. Please inspect the garbage bag port to see if it can be fully opened and close. (it is recommended to check every time after installing a new bag). The large size of garbage can be handled manually to make it smaller first.

Q: What kind of cat litter sand should I use?

A: Mixed sand and tofu sand are preferred. Bentonite sand and mineral sand are okay, this may affect the delay time of the "Full" prompt due to their weight density and liquidity.

Q: Why is there some litter sand left in the bin after using the "Replace Litter" function?

A: Please check the garbage bag space to see if there is enough space. Please replace the bag and then "Replace Litter" again.

Q: Why is the litter sand leaking out from the port of the garbage box when replacing the garbage bag?

A: Please hold the "Clean" for 2 seconds, and then the litter bin will rotate 90° counterclockwise to ensure that the port of the bag is upward when replacing.

Q: Why is the weight data incorrect?

A: Please hold the "Remove Odor" for 2 seconds, the litter sand will be smoothed, and the weight will be calibrated. Also, please check whether the device is placed on a flat and hard surface. If a cat enters the bin during working, it will also get an inaccurate weight. Cats entering halfway or staying in the bin for too short of time may also result in incorrect weighing.

Q: Why didn't the device stop working while the cat entered?

A: The device won't stop when sand leveling and weight calibrating. The device is designed with a safe structure. Rotating 45 degrees is safe when the cat enters.

VI PRODUCT LIST

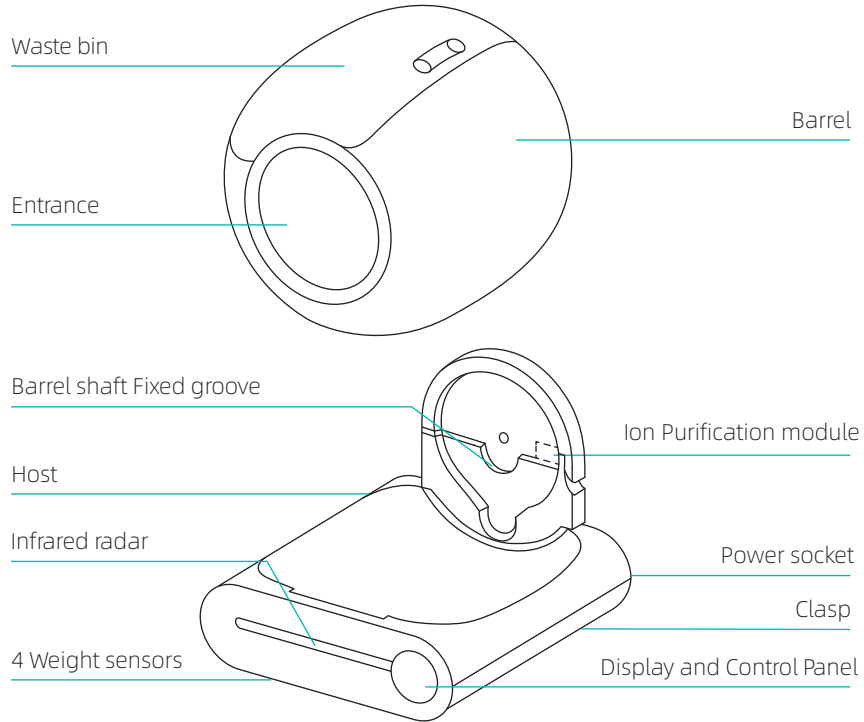

VII INTRODUCTION OF CONTROL PANEL

Category	Function	Operation	Status	Prompt tone	
wifi	Clean	Click	Start cleaning immediately	One ring	
	Replace litter	Press for 2"	Start replacing cat litter	Long ring for "	
	Auto cleaning	Click	Start Auto cleaning	One ring	
	Remove odor	Click	Start purifying the air	One ring	
	Join network	Press for 2"	Reset WiFi to start join network	Long ring for "	
	Leveling	Press for 2"	Leveling the cat litter	Long ring for "	
	Change garbage bag	Press for 2"	Adjust the barrel angle to the bag changing position	Long ring for "	
	Lock/Unlock	Press + for 2"	Locked/Unlock	Long ring for "	
	Indicator	Ring lamp	Lighting	Power On	
		Fault lamp (left)	Lighting	Barrel is not installed or it cannot run	
	WiFi lamp (middle)	Lighting	The device is connected		
		Flash	The device is trying to connect to the network		
		Unlit	The device is not connected		
	Waste full lamp (right)	Lighting	Remind users to replace garbage bag when the waste bin is almost full		

FCC Warning

This device complies with Part 15 of the FCC Rules. Operation is subject to the following two conditions:

(1) This device may not cause harmful interference, and (2) this device must accept any interference received, including interference that may cause undesired operation.

NOTE 1: This equipment has been tested and found to comply with the limits for a Class B digital device, pursuant to part 15 of the FCC Rules. These limits are designed to provide reasonable protection against harmful interference in a residential installation. This equipment generates, uses and can radiate radio frequency energy and, if not installed and used in accordance with the instructions, may cause harmful interference to radio communications. However, there is no guarantee that interference will not occur in a particular installation. If this equipment does cause harmful interference to radio or television reception, which can be determined by turning the equipment off and on, the user is encouraged to try to correct the interference by one or more of the following measures:

- Reorient or relocate the receiving antenna.
- Increase the separation between the equipment and receiver.
- Connect the equipment into an outlet on a circuit different from that to which the receiver is connected.
- Consult the dealer or an experienced radio/TV technician for help.

NOTE 2: Any changes or modifications to this unit not expressly approved by the party responsible for compliance could void the user's authority to operate the equipment.

RF Exposure Statement

To maintain compliance with FCC'S RF Exposure guidelines, This equipment should be installed and operated with minimum distance of 20cm between the radiator your body. This device and its antenna(s) must not be co-located or operation in conjunction with any other antenna or transmitter.