

APRIL 8, 2024

# MT-5-A-H USER MANUAL

V1.18

SHENZHEN MEK INTELLISYS PTE LTD

## History of Revisions

Revision	Date	Summary of changes
V1.00	April 15, 2023	First release.
V1.01	Sept 11, 2023	Revised for RTU.
V1.02	Oct 23, 2023	Revised for HPU.
V1.03	Nov 07, 2023	Revised for Event Log and RTC time.
V1.04	Nov 20, 2023	Revised for FCU.
V1.05	Nov 24, 2023	Revised for FCU 2 Pipe, 4 Pipe systems.
V1.06	Dec 06, 2023	Revised for RTU, HPU Cut in Cut Out Algorithm.
V1.07	Dec 20, 2023	Revise LoRaWAN Packet and FUOTA
V1.08	Dec 22, 2023	Revise Terminal configurations
V1.09	Jan 03, 2024	Add Temperature Unit Selection
V1.10	Jan 19, 2024	Separate heating and cooling setpoint Split SET_SETTING1 to two setting command Change Event Log to auto transmit Fix Scheduler bugs
V1.11	Jan 21, 2024	Add Cooling SP and Heating SP to Morning, Afternoon, Evening and Night Session
V1.12	Jan 24, 2024	Add Humidity Display
V1.13	Jan 31, 2024	Added New LoRaWAN Setting API
V1.14	Mar 04, 2024	Bug fix.
V1.15	Mar 09, 2024	Add BACnet Points
V1.16	Mar 11, 2024	Add restrictions on Application Mode and Operation Mode. Add RS485 Specifications
V1.17	Mar 25, 2024	Fix Temperature display for > 100 and <32°F or <0°C as HI and Lo. Add button cell warning statement
V1.18	April 08, 2024	Add user override function.

## Contents

1. Overview.....	1
2. Dimensions .....	1
3. MT-5 Series and Order Code .....	3
4. Specifications.....	4
5. Hardware Descriptions .....	5
5.1 Front .....	5
5.2 Back .....	5
5.3 Motherboard Battery .....	6
6. Wiring Connections .....	7
6.1 Power Supply.....	7
6.2 RS485 Connection.....	8
7. Installation .....	9
8. Application.....	11
8.1 Roof Top Unit Application .....	11
8.1.1 Operation Mode .....	13
8.1.2 Compressor On/Off Protection .....	14
8.2 Heat Pump Application.....	15
8.2.1 Operation Mode .....	18
8.2.2 Compressor On/Off Protection .....	19
8.2.3 4-Way Valve Changing .....	19
8.3 Fan Coil Application .....	21
8.3.1 Fan Operation.....	21
8.3.2 Two Pipe Cooling Mode And Heating Mode .....	22
8.3.3 Two Pipe Cooling Only Operation Mode .....	23
8.3.4 Two Pipe Heating Only Operation Mode .....	23
8.3.5 Four Pipe Cooling , Heating And Auto Mode.....	24
8.3.6 Four Pipe Cooling, Heating and Auto Operation Mode.....	25
8.3.7 Fan Mode.....	25
8.3.8 Dry Mode .....	25
8.3.9 FCU Application Type And Wiring .....	28
9. Operation Guides.....	30
9.1 Panel Operations .....	30

9.2 Mode .....	30
9.3 Fan Speed .....	30
9.4 Temperature Setting .....	30
9.5 Time Setting.....	31
9.6 LCD Brightness.....	32
9.7 Weekly Scheduler .....	32
9.8 Temperature and Humidity Display .....	33
9.9 User Override .....	33
10. Communication .....	34
10.1 Modbus RTU Settings .....	34
10.2 BACnet MSTP Settings .....	35
11. USB Virtual COM Terminal Program.....	35
11.1 User Name Menu .....	36
11.2 Password Menu .....	37
11.3 Main Menu .....	37
11.4 Thermostat Advanced Configuration .....	38
11.4.1 Thermostat Application .....	39
11.4.2 O/B Mode .....	40
11.4.3 Operation Mode .....	40
11.4.4 Keylock.....	41
11.4.5 Clock Mode .....	42
11.4.6 Power On Off .....	42
11.4.7 Power On Default State .....	43
11.4.8 Thermistor Selection .....	43
11.4.9 Cooling Set Point .....	44
11.4.10 Heating Set Point.....	44
11.4.11 Temperature Compensation .....	45
11.4.12 Temperature Offset.....	45
11.4.13 Temperature Unit.....	46
11.5 Thermostat Offset Configuration .....	46
11.6 Thermostat User Override Default Time .....	47
11.7 Thermostat Time Limit Configuration .....	47
11.8 Thermostat Schedule Configuration .....	48
11.9 LoRaWAN Setting .....	49

11.10 Real Time Clock Setup .....	50
11.11 Device Information .....	51
11.12 Bootloader Mode .....	51
11.13 Restore Factory Default Setting .....	53
11.14 Reboot .....	54
12. LoRaWAN(Only Model with LoRa).....	54
12.1 Regional Parameters .....	54
12.2 Activation.....	54
12.3 OTAA.....	55
12.4 DevEUI .....	55
12.5 JoinEUI .....	55
12.6 AppKey/JoinKey.....	55
12.7 ABP .....	55
12.8 Payload .....	56
12.9 FUOTA.....	56
12.10 Event Log .....	56
12.11 Command .....	56
12.12 UpLink Payload .....	57
12.12.1 GET_DATA Command .....	57
12.12.2 GET_SETTING0_REPLY .....	58
12.12.3 GET_SETTING1_REPLY .....	58
12.12.4 GET_SETTING2_REPLY .....	59
12.12.5 GET_SETTING3_REPLY .....	60
12.12.6 GET_SETTING4_REPLY .....	60
12.12.7 GET_SETTING5_REPLY .....	60
12.12.8 GET_SETTING6_REPLY .....	61
12.12.9 GET_SETTING7_REPLY .....	61
12.12.10 GET_SETTING8_REPLY .....	62
12.12.11 GET_SETTING9_REPLY .....	62
12.12.12 GET_EVENT_LOG_REPLY .....	62
12.12.13 SET_SETTING0_REPLY.....	63
12.12.14 SET_SETTING1_REPLY.....	63
12.12.15 SET_SETTING2_REPLY.....	63
12.12.16 SET_SETTING3_REPLY.....	63

12.12.17 SET_SETTING4_REPLY.....	63
12.12.18 SET_SETTING5_REPLY.....	63
12.12.19 SET_SETTING6_REPLY.....	64
12.12.20 SET_SETTING7_REPLY.....	64
12.12.21 SET_SETTING8_REPLY.....	64
12.12.22 SET_SETTING9_REPLY.....	64
12.12.23 SET_RTC_REPLY.....	64
12.12.24 GET_FIRMWARE_VERSION_REPLY.....	64
12.13 Downlink Payload.....	64
12.13.1 GET_SETTING0.....	64
12.13.2 GET_SETTING1.....	65
12.13.3 GET_SETTING2.....	65
12.13.4 GET_SETTING3.....	65
12.13.5 GET_SETTING4.....	65
12.13.6 GET_SETTING5.....	65
12.13.7 GET_SETTING6.....	65
12.13.8 GET_SETTING7.....	65
12.13.9 GET_SETTING8.....	65
12.13.10 GET_SETTING9.....	66
12.13.11 GET_EVENT_LOG.....	66
12.13.12 SET_SETTING0.....	66
12.13.13 SET_SETTING1.....	67
12.13.14 SET_SETTING2.....	67
12.13.15 SET_SETTING3.....	68
12.13.16 SET_SETTING4.....	68
12.13.17 SET_SETTING5.....	68
12.13.18 SET_SETTING6.....	69
12.13.19 SET_SETTING7.....	69
12.13.20 SET_SETTING8.....	70
12.13.21 SET_SETTING9.....	70
12.13.22 SET_RTC.....	71
12.14 Data Type Structure And Byte Order Decoding.....	71
13. BACnet Object Table.....	72

## Figures

Figure 1 : MT-5 Front and side Dimension(mm).....	1
Figure 2 : MT-5 Mounting Holes Distances And Sizes(mm).....	2
Figure 3 : MT-5-X/L dimension.....	3
Figure 4 : Front View .....	5
Figure 5 : Low Voltage wiring.....	5
Figure 6 : Connection without offline adapter .....	7
Figure 7 : RS485 Connection .....	8
Figure 8 : Open and separate the LCD from the back cover.....	9
Figure 9 : Slotted Screwdriver And Screen Cover .....	9
Figure 10 : Screen Cover Installation .....	10
Figure 11 : Roof Top Unit Sequences.....	12
Figure 12 : Roof Top Unit Connection.....	13
Figure 13 : Compressor On/Off Protection Sequences .....	14
Figure 14 : Heat Pump Unit Sequences .....	17
Figure 15 : Heat Pump Application .....	18
Figure 16 : Compressor Protection .....	19
Figure 17 : Compressor On/Off Delay Protection.....	20
Figure 18 : Fan Speed Sequence In Cool, Heat And Auto Fan Mode.....	22
Figure 19 : Two Pipe Cooling and Heating Mode .....	22
Figure 20 : Four Pipe Cooling, Heating and Auto Mode .....	24
Figure 21 : Dry Mode Zones.....	26
Figure 22 : Dry Mode Sequence.....	27
Figure 23 : FCU Application an Type and Wiring .....	29
Figure 24 : Panel Buttons and Symbols .....	30
Figure 25 : Weekly Scheduler .....	33
Figure 26 Check the communication port number.....	36
Figure 27 Terminal - Login Screen.....	36
Figure 28 Terminal : Main Menu .....	36
Figure 29 Terminal - User NAmE Menu .....	37
Figure 30 : Terminal - Password Menu .....	37

Figure 31 : Terminal - LoRaWAN Setting.....	50
Figure 32 : Terminal - Real Time Clock Setting .....	51
Figure 33 : Terminal - Device Information .....	51
Figure 34 : Terminal - Bootloader .....	52
Figure 35 : Terminal - Mass Storage Device.....	52
Figure 36 : Terminal - Restore Factory Default Setting .....	53
Figure 37 : Terminal - REboot .....	54



## 1. Overview

MT-5 is a series of advanced thermostat with LoRaWAN, RS485(BACnet MSTP and Modbus RTU), and WIFI supported. It measures the room temperature, and controls the fans and valves to adjust the room temperature to the pre-configured temperature. This device supports configuration like two-pipe/four-pipe, two-lines/three-lines valves, and three fan speeds controls, modulating valve and ECM fan. It supports relative humidity measurement and optional eCO2 measurement for comfort and Air Quality Control. It is developed as a LoRaWAN end node and can be communicated wirelessly with standard LoRaWAN system. Therefore, this is suitable to be applied in office buildings, residential buildings, hotels, clubhouses, airports, railway stations, stadiums, and so on.

This particular user manual only covers MT-5-A, 5 Relay DO model.

## 2. Dimensions

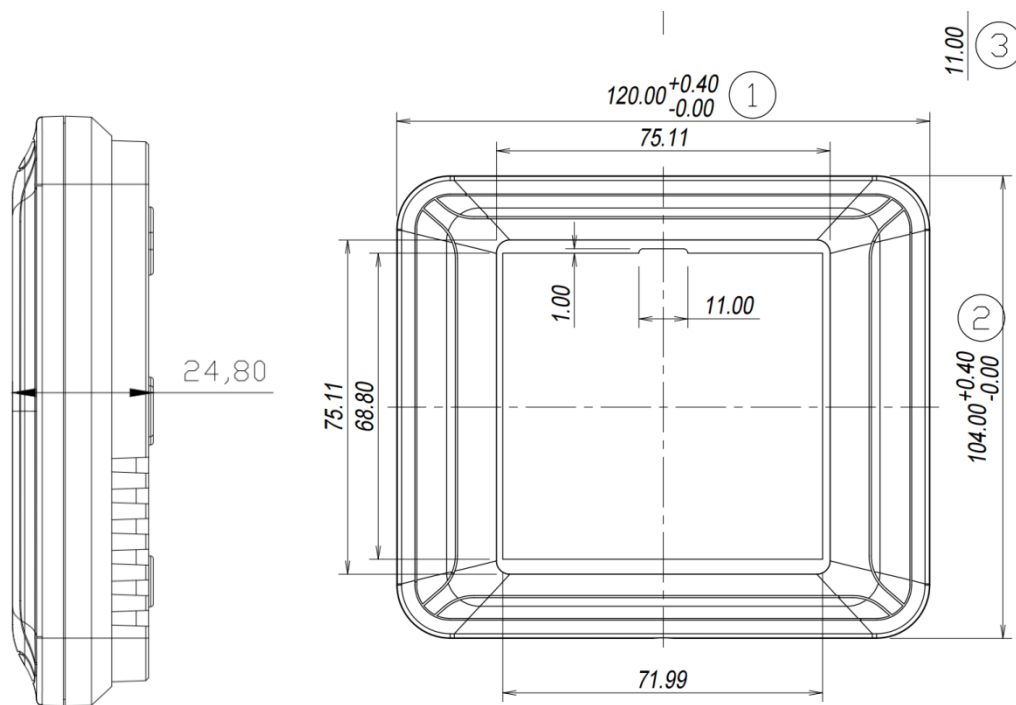

FIGURE 1: MT-5 FRONT AND SIDE DIMENSION(MM)

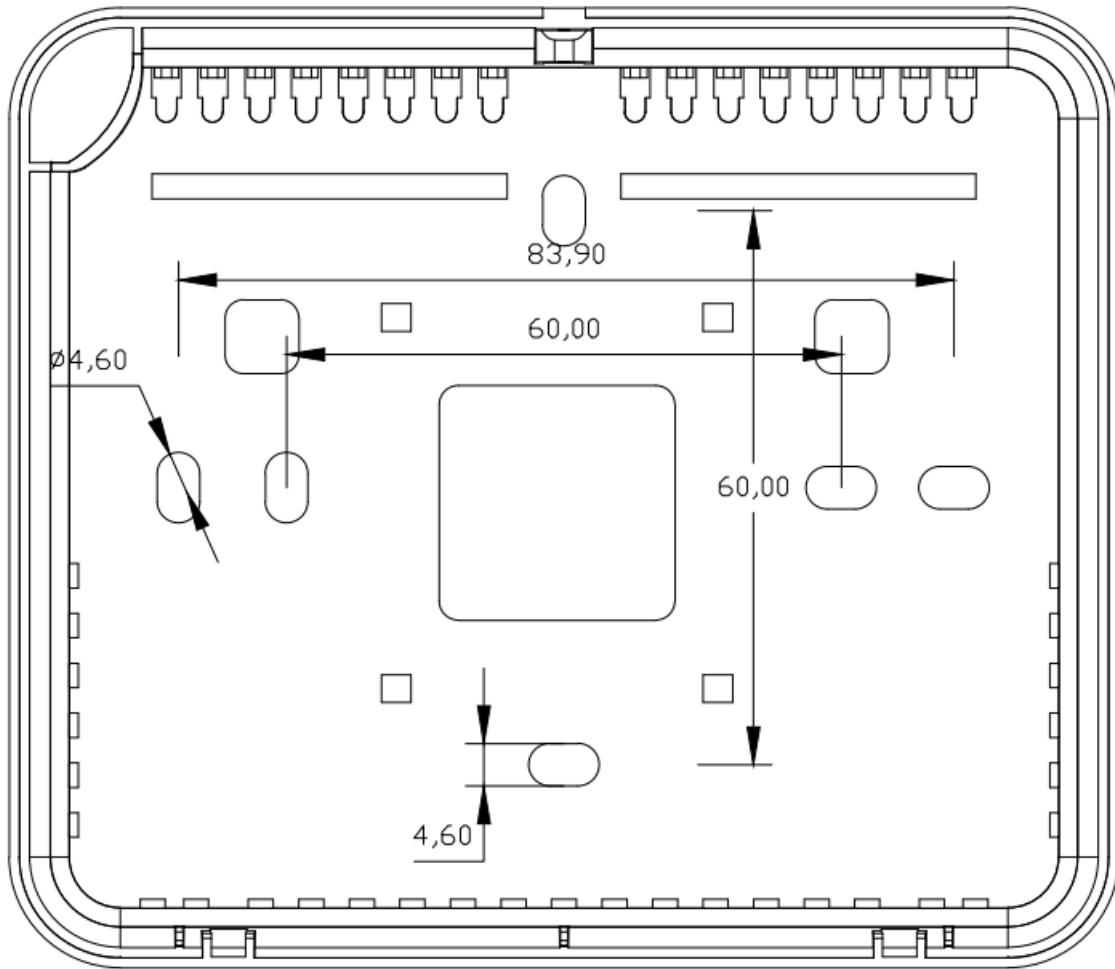

FIGURE 2: MT-5 MOUNTING HOLES DISTANCES AND SIZES(MM).

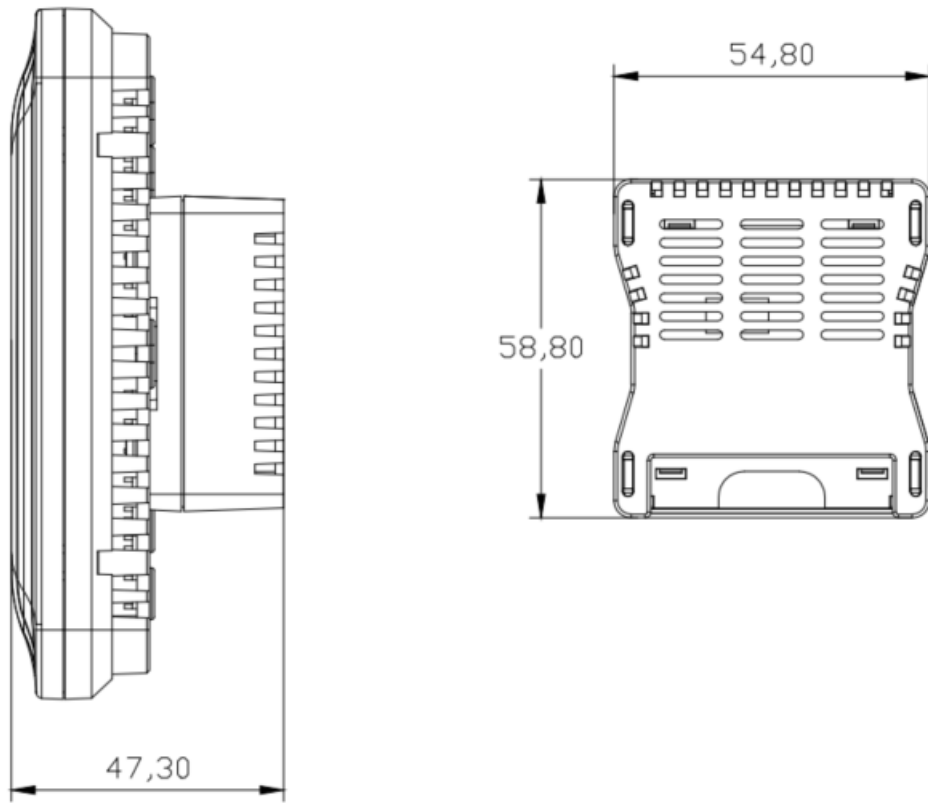
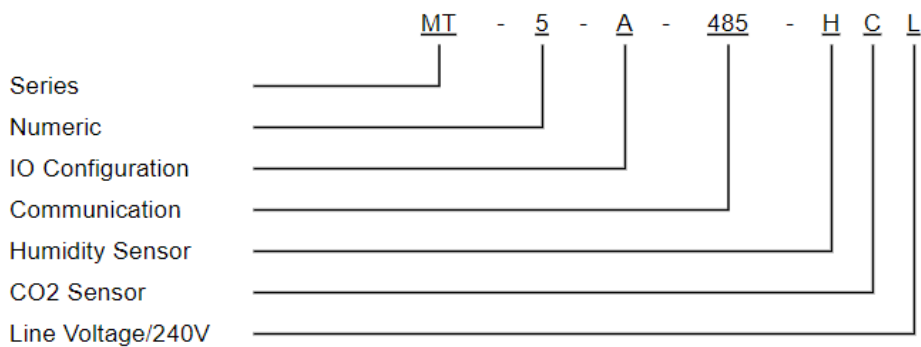

FIGURE 3: MT-5-X/L DIMENSION

### 3. MT-5 Series and Order Code

#### MT-5 Naming Convention and Order Code

##### MT-5 Series Order Code



##### Communication Option

- 485            RS485 supported. This option will supports Modbus RTU and BACnet MSTP
  
- LoRa            LoRaWan supported.  
This option will supports Modbus RTU and BACnet MSTP also.
  
- WIFI            WIFI supported. This option will supports Modbus TCP and BACnet IP via WIFI.  
This option will supports Modbus RTU and BACnet MSTP also.

Note : RS485 is the default feature. It is available for LoRA and WIFI version.

## 4. Specifications

MT-5	
Pwer Supply	24VAC +20%/-15% 50/60Hz
Power Consumption	TBA
Temperature Sensor	0°C to 70°C ± 0.25°C
Temperature Control Range	1°C to 50°C (default is 16-30°C)
Humidity Sensor	20% RH to 80% RH ±2.5% RH @ 20°C to 80°C
eCO2 Sensor	400 ppm to 5000 ppm
Relay	24VAC 0.3A, 24VDC 1A
Display	64 x 64mm Black Mask LCD
Control	Touch Screen Button
Casing Material	Fireproof ABS+PC with scratch resistance acrylic
Operating Temperature	-10 to 60°C, 5% RH to 95% RH non-condensing
Storage Temperature	-20°C to 70°C
Dimension	Panel : TBA(L x W x H)
Installation Method	Standard 86-type box, NEMA WD-6 junction box
Installation Hole Distance	60mm (standard 86-type box hole distance) 83.9mm (3.281")( NEMA WD-6 junction box)
Cable Specification	0.5-1.5mm <sup>2</sup>

## 5. Hardware Descriptions

### 5.1 Front

There are 7 button on the front panel.



FIGURE 4: FRONT VIEW

### 5.2 Back

Main Port is used to connect with the supply power and valve control.

Temperature Sensor is used to measure the room temperature.

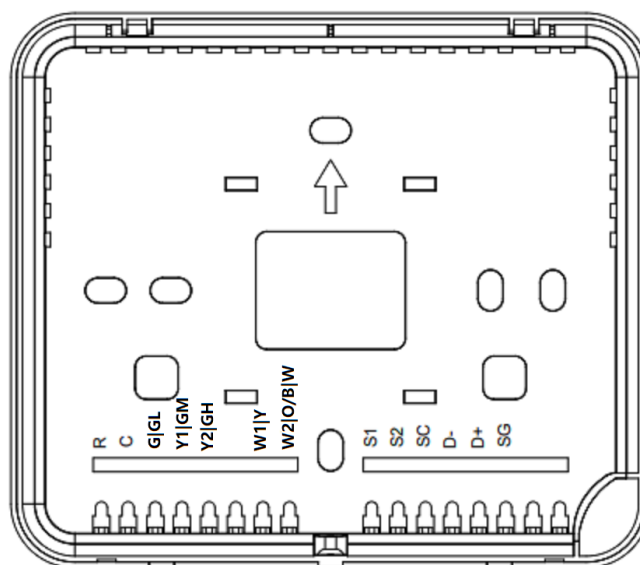

FIGURE 5: LOW VOLTAGE WIRING

### 5.3 Motherboard Battery

The only function of the battery is used for saving the device time, it does not need to be replaced in normal circumstances, since the configuration will not be lost even the battery is dead. To replace the battery in the MT-5, the back cover of the screen is required to be removed. Battery model is CR1216 lithium battery with nominal voltage of 3V, which can last for 5 years. The battery should be used carefully, as it can overheat, explode, catch fire. **The battery is not included. Please use a UL certified battery for safety.**

The followings are the precautions of using a battery:

- The battery type is CR1216, nominal voltage 3V, non-rechargeable lithium-ion button cell.
- Remove and immediately recycle or dispose of used batteries according to local regulations and keep away from children. Do NOT dispose of batteries in household trash or incinerate.
- Do not reuse recycled battery, used batteries may cause severe injury or death.
- Call a local poison control center for treatment information if the battery is accidentally swallowed.
- Non-rechargeable batteries are not to be recharged, doing this may cause the battery to catch fire.
- Do not force discharge, recharge, disassemble, heat above 50°C/122°F or incinerate. Doing so may result in injury due to venting, leakage or explosion resulting in chemical burns.
- Ensure the batteries are installed correctly according to polarity (+ and -).
- Do not mix old and new batteries, different brands or types of batteries, such as alkaline, carbon-zinc, or rechargeable batteries.
- Remove and immediately recycle or dispose of batteries from equipment not used for an extended period of time according to local regulations.
- Always completely secure the battery compartment. If the battery compartment does not close securely, stop using the product, remove the batteries, and keep them away from children.
- Do not short-circuit the battery, as it will leak, overheat, or explode.
- If the battery is overheating, stop using it.

## 6. Wiring Connections

### 6.1 Power Supply

MT-5 when used without offline adapter use 24VAC +20%/-15% or 24VDC +/- 5%

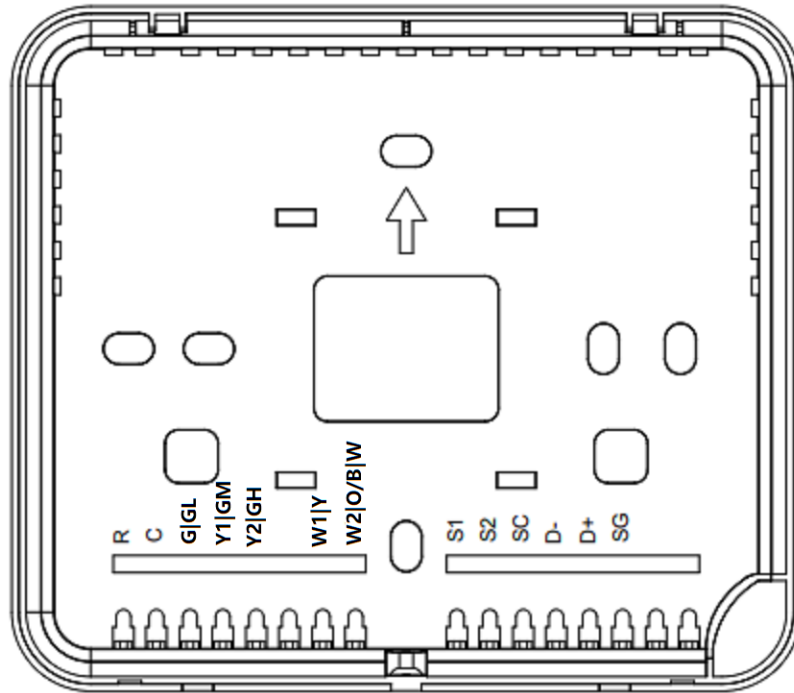

FIGURE 6: CONNECTION WITHOUT OFFLINE ADAPTER

## 6.2 RS485 Connection

RS485 port on MT-5 is used for Modbus RTU, and BACnet MSTP.

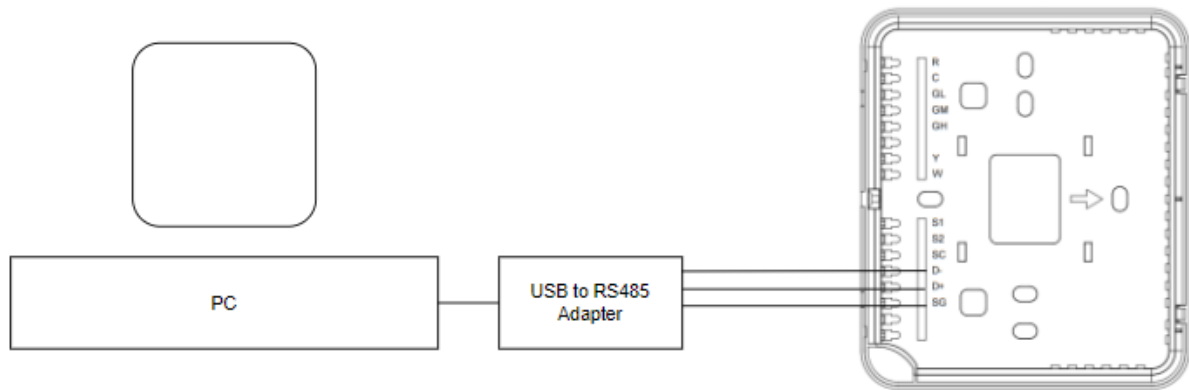

FIGURE 7: RS485 CONNECTION



## 7. Installation

Please make sure the device is not powered during installation. MT-5 should be installed at somewhere with good air circulation, far from the heat source and windows, to avoid direct sunlight. It also should be installed in a standard 86-type box (86 x 86 mm). Please do not punch any hole on the cover box, do not disassemble the power adapter, as it will damage the device and cause harm. Please consult manufacturer technician before performing any action that is dangerous. When the device is showing 'E01' on the screen and buzzing, it means that the device is in error.

Apply slotted screwdriver to pry the screen cover open at the holes as shown below to separate the LCD from the back cover or in case of Offline version from the back cover and the MTPS power adapter.

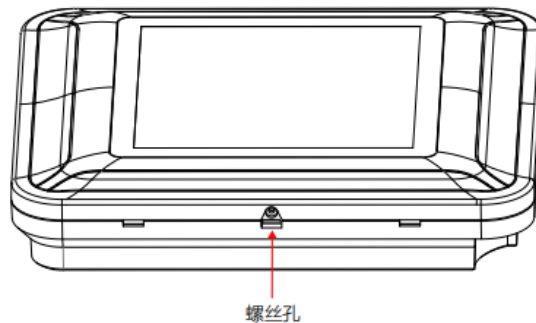

**FIGURE 8: OPEN AND SEPARATE THE LCD FROM THE BACK COVER**

Install the back cover to the wall plate box after wiring is done and screw the back casing to the box as shown below.

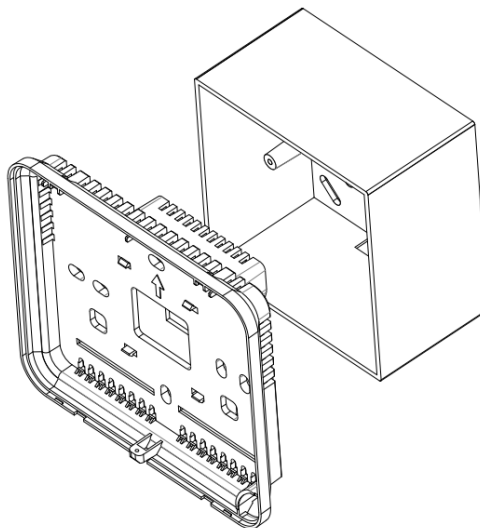

**FIGURE 9: SLOTTED SCREWDRIVER AND SCREEN COVER**

Snap the screen cover on to the bottom cover that is pried open previously. Do not apply force on the screen, as it will damage the screen sensor, apply force at the edge will do the work. Screw back the screw at the bottom to secure the screen.

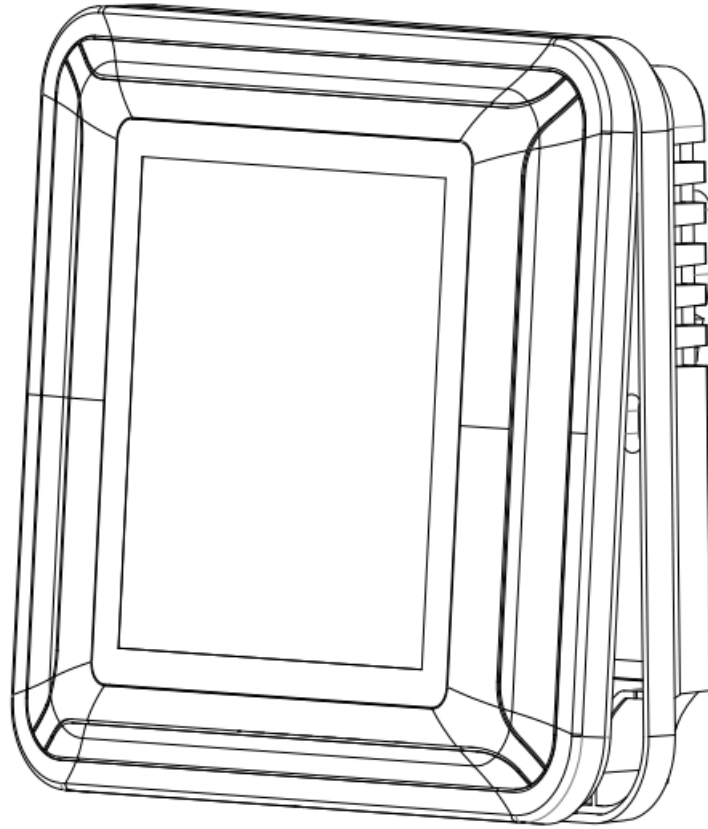

**FIGURE 10: SCREEN COVER INSTALLATION**

## 8. Application

### 8.1 Roof Top Unit Application

User can select the operating mode by touch screen mode button or remote access by network command. The available user selectable modes are: Off(by the power button), Fan, Dry, Cool, Heat and Auto.

Parameters used:

Cooling Setpoint	User selected cooling setpoint temperature
Y(1) Offset	Offset from setpoint, Y1 Off.
Y(2) Offset	Offset from setpoint, Y1 On, and Y2 Off.
Y(3) Offset	Offset from setpoint, Y2 On.
Heating Setpoint	User selected heating setpoint temperature
W(1) Offset	Offset from setpoint, W1 Off
W(2) Offset	Offset from setpoint, W1 On, and W2 Off.
W(3) Offset	Offset from setpoint, W2 On.
Coff	Compressor minimum off time, in seconds, 0 = disable, max 65535s.
Con	Compressor minimum on time, in seconds, 0 = disable, max 65535s.
Boost Min Time	Activate higher Fan/stage when temperature stay in the zone for too long, in second, 0 = disable, max 65535s.

Conditions:

$Y(3) \text{ Offset} > Y(2) \text{ Offset} > Y(1) \text{ Offset}$

$W3 \text{ Offset} < W2 \text{ Offset} < W1 \text{ Offset}$

Default values:

CoolSP = 25°C or 77°F

HeatSP = 20°C or 68°F

Y(1) Offset = -0.5, Y(2) Offset = 1.5, Y(3) Offset = 3.0,

W(1) Offset = -1.0, W(2) Offset = -3.5, W(3) Offset = -5.0

Coff = 180 s, Con = 120 s

Boost Stage Time = 180 s

Note : Only SP has unit, either °C or °F, Offsets are unit-less and will add directly from SP.

### Cooling/Heating Stages Cut In and Cut Out

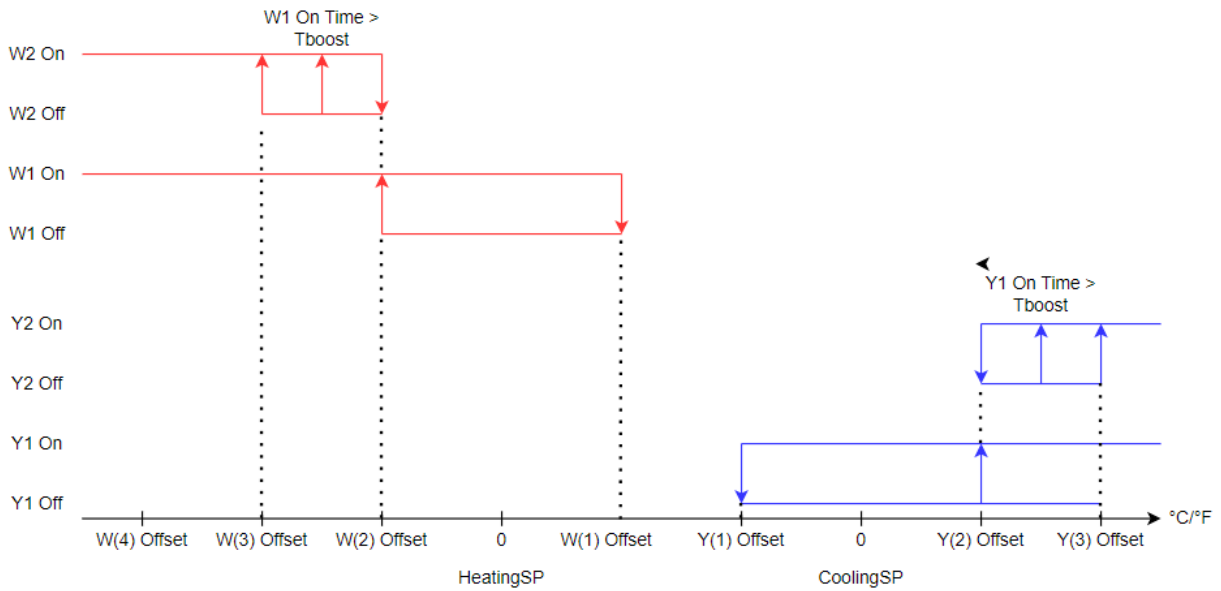

**Default Value**

HeatingSP = 20.0°C or 68°F	CoolingSP = 25.0°C or 77°F	Tboost = 180 s
W(1) Offset = 1.0	Y(1) Offset = -0.5	
W(2) Offset = -3.5	Y(2) Offset = 1.5	
W(3) Offset = -5.0	Y(3) Offset = 3.0	

### Cooling/Heating Stages Cut In and Cut Out In Time Domain

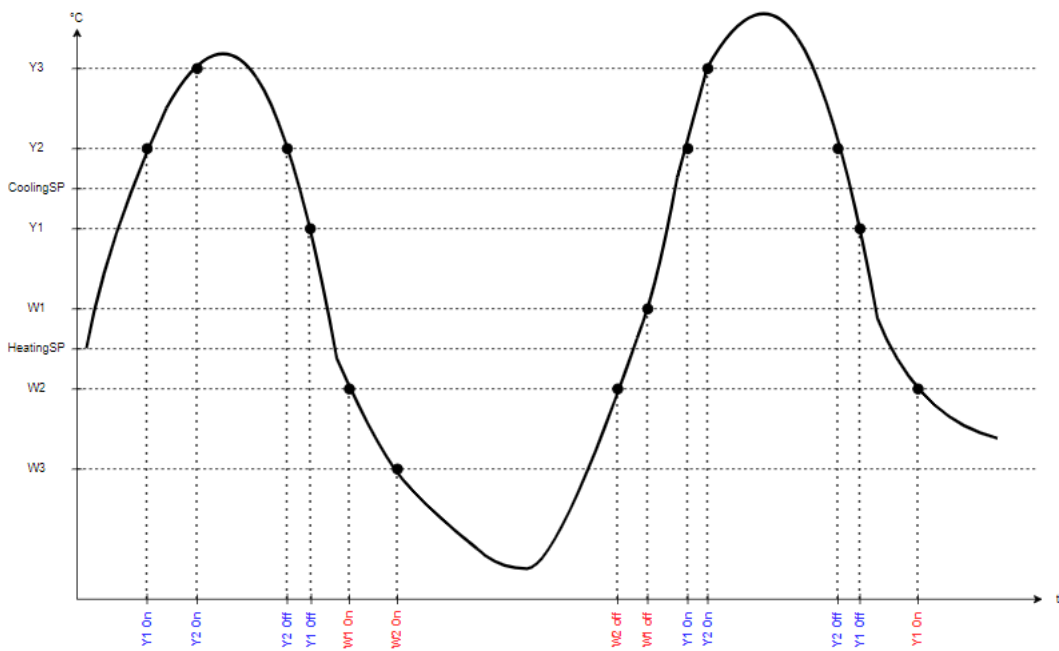
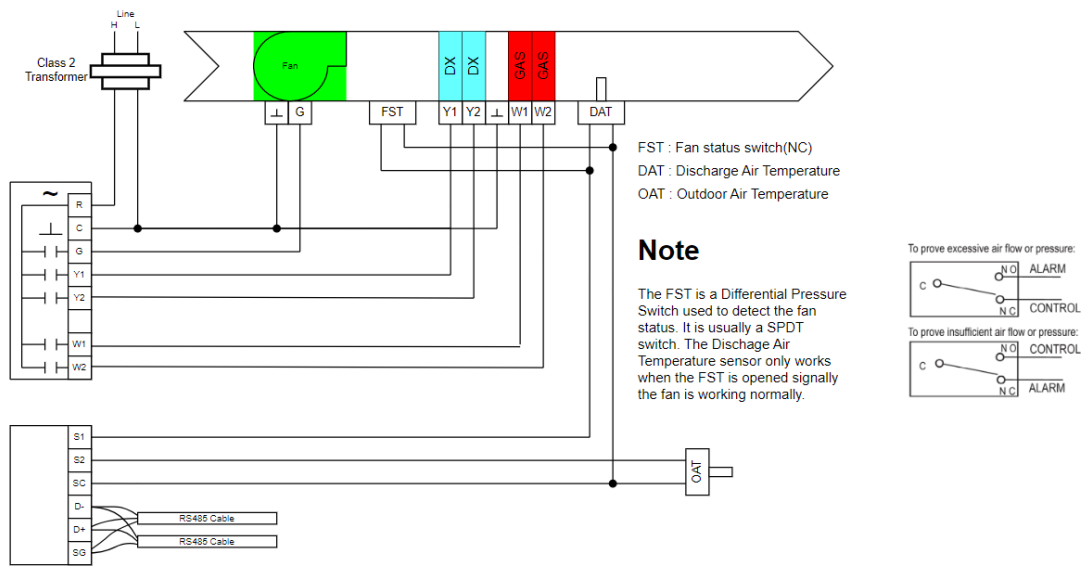

FIGURE 11: ROOF TOP UNIT SEQUENCES

**RTU - two-stage gas/electric heat and two-stage DX cooling**

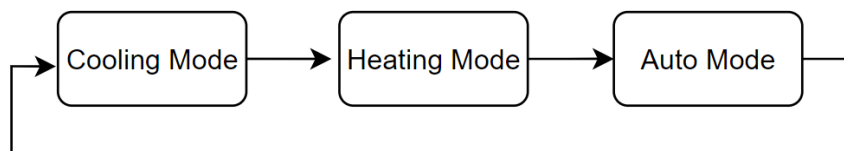

**FIGURE 12: ROOF TOP UNIT CONNECTION**

**Note :** FST, DAT and OAT are not implemented yet.

**8.1.1 Operation Mode**

User can change the operation mode from Cooling Mode, Heating Mode and Auto Mode.



For RTU application not all the operating mode is valid.

Operating Mode	Validity/Implement	Command from BACnet or LoRaWAN
Cooling Mode	Supported	Accepted
Fan Mode	Not Supported	Default to Cooling Mode
Heating Mode	Supported	Accepted
Auto Mode	Supported	Accepted
Dry Mode	Not Implemented	Default to Cooling Mode

### 8.1.2 Compressor On/Off Protection

The compressor must be idle for at least 3 minutes once it is deactivated. There will be no delay during power on reset for standard configuration. If the compressor has been turned off for more than 2 minutes before power off, then the compressor can be turned on immediately upon thermostat switch on, otherwise it will have to wait until the 3 minutes has passed.

#### Cooling Mode Compressor On/Off Protection

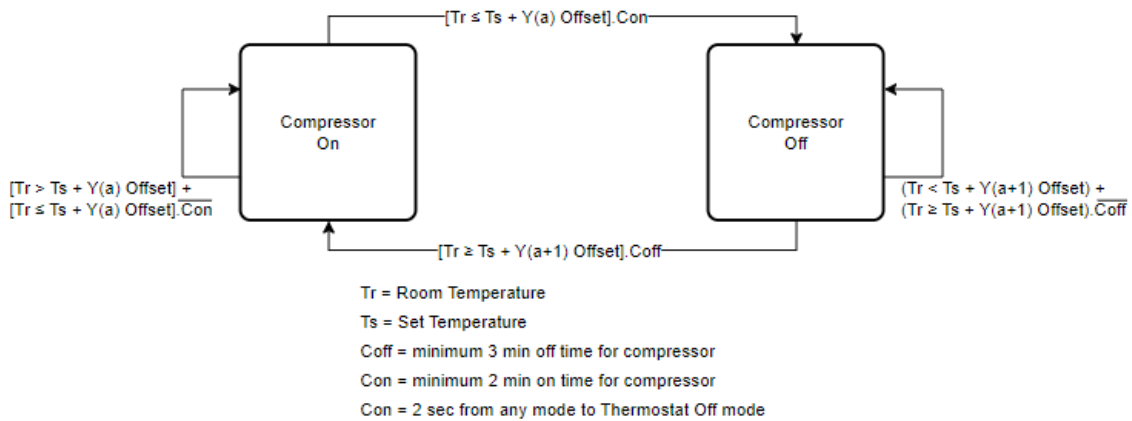

#### Heating Mode Compressor On/Off Protection

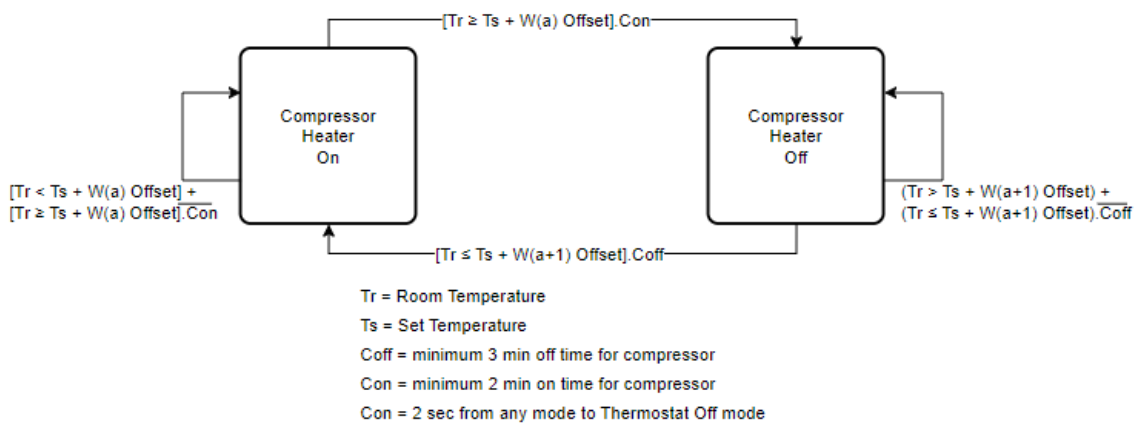

FIGURE 13: COMPRESSOR ON/OFF PROTECTION SEQUENCES

## 8.2 Heat Pump Application

User can select the operating mode by touch screen mode button or remote access by network command. The available user selectable modes are: Off(by the power button), Fan, Dry, Cool, Heat and Auto.

Parameters used:

Cooling Setpoint	User selected cooling setpoint temperature
Y(1) Offset	Offset from setpoint, Y1 Off
Y(2) Offset	Offset from setpoint, Y1 On, Y2 Off, O Off, B On.
Y(3) Offset	Offset from setpoint, Y2 On.
Heating Setpoint	User selected heating setpoint temperature
W(1) Offset	Offset from setpoint, Y1 Off.
W(2) Offset	Offset from setpoint, Y1 On, Y2 Off, O On, B Off.
W(3) Offset	Offset from setpoint, Y2 On, W1 Off.
W(4) Offset	Offset from setpoint, W1 On.
Coff	Compressor minimum off time, in seconds, 0 = disable, max 65535s.
Con	Compressor minimum on time, in seconds, 0 = disable, max 65535s.
Boost Min Time	Activate higher Fan/stage when temperature stay in the zone for too long, in seconds , 0 = disable.

Conditions:

Y(3) Offset > Y(2)Offset > Y(1) Offset

W(4) Offset < W3 Offset < W2 Offset < W1 Offset

Default values:

CoolSP = 25°C or 77°F

HeatSP = 20°C or 68°F

Y(1) Offset = -0.5, Y(2) Offset = 1.5, Y(3) Offset = 3.0,

W(1) Offset = 1.0, W(2) Offset = -3, W(3) Offset = -5.0, W(4) Offset = -7.0

Coff = 180 s, Con = 120 s

Boost Stage Time = 180 s

Note : Only SP has unit, either °C or °F, Offsets are unit-less and will add directly from SP.



### Cooling/Heating Stages Cut In and Cut Out

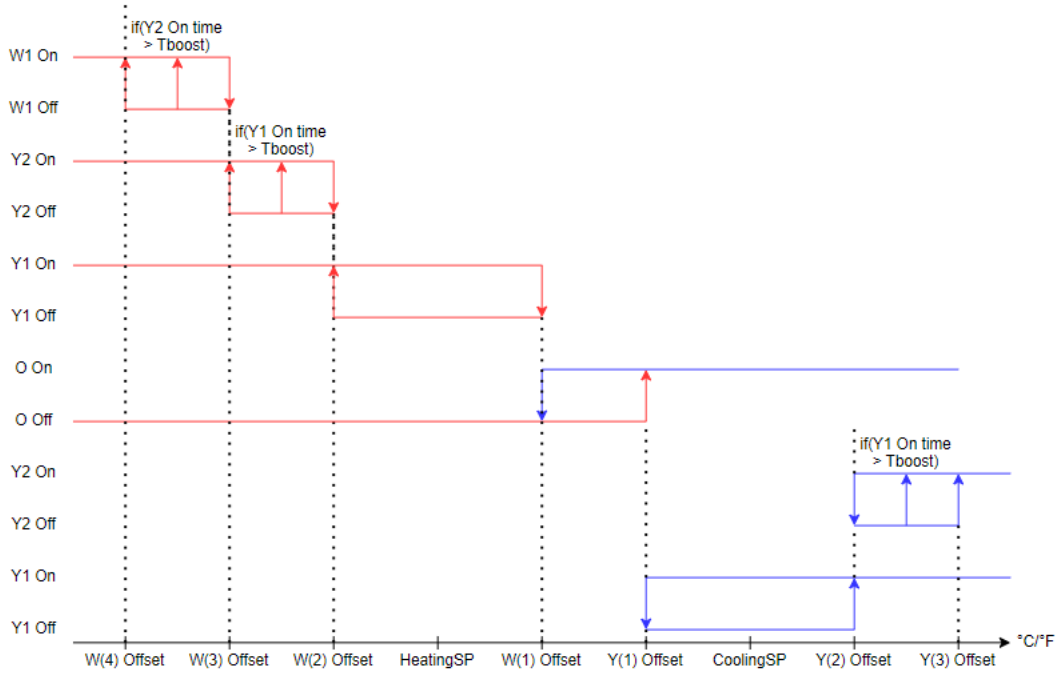

Default Value  
 HeatingSP = 20.0°C or 68°F      CoolingSP = 25.0°C or 77°F  
 W(1) Offset = 1.0                  Y(1) Offset = -0.5                  Tboost = 180 sec  
 W(2) Offset = -3.5                Y(2) Offset = 1.5  
 W(3) Offset = -5.0                Y(3) Offset = 3.0  
 W(4) Offset = -7.0

### Cooling/Heating Stages Cut In and Cut Out In Time Domain

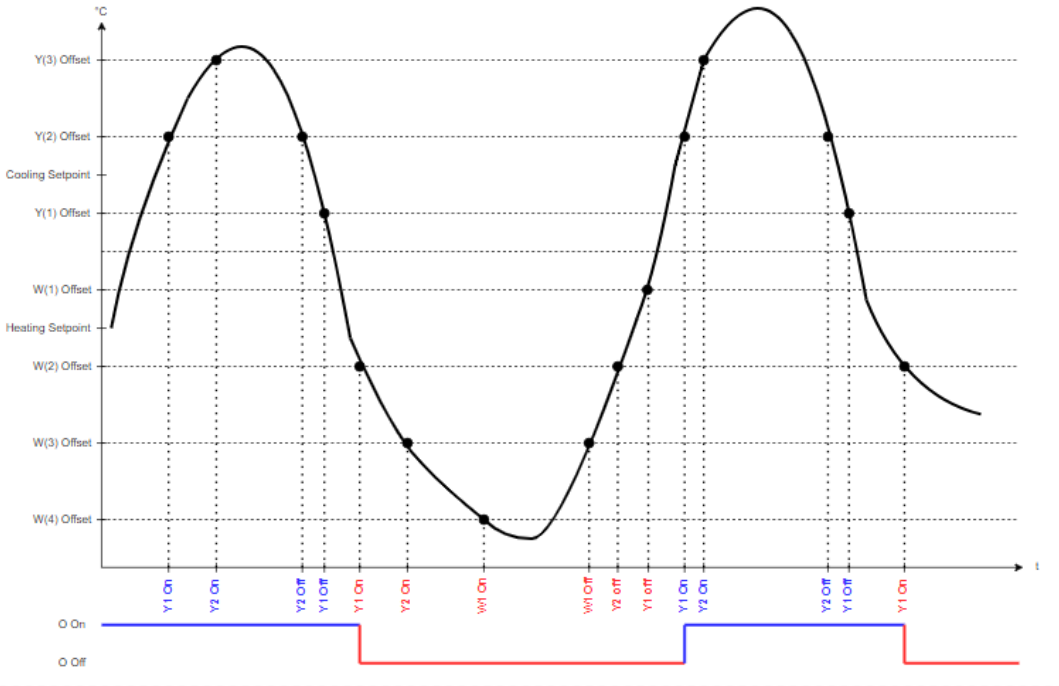

FIGURE 14: HEAT PUMP UNIT SEQUENCES

HPU - Three heat, 2 cool

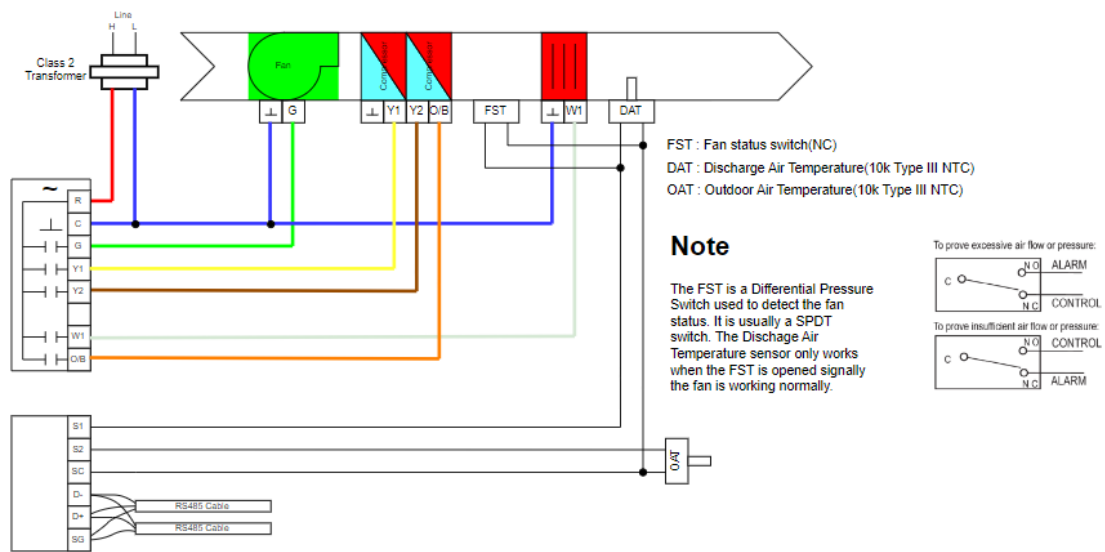
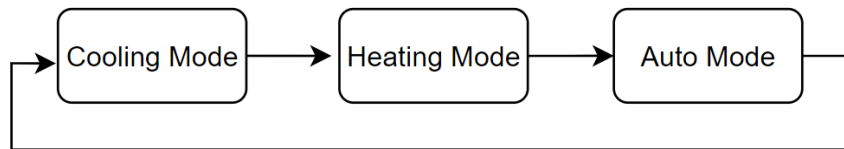

FIGURE 15: HEAT PUMP APPLICATION

Note : FST, DAT and OAT are not implemented yet.

### 8.2.1 Operation Mode

User can change the operation mode from Cooling Mode, Heating Mode and Auto Mode.



For HPU application not all the operating mode is valid.

Operating Mode	Validity/Implement	Command from BACnet or LoRaWAN
Cooling Mode	Supported	Accepted
Fan Mode	Not Supported	Default to Cooling Mode
Heating Mode	Supported	Accepted
Auto Mode	Supported	Accepted
Dry Mode	Not Implemented	Default to Cooling Mode

### 8.2.2 Compressor On/Off Protection

The compressor must be idle for at least 3 minutes once it is deactivated. There will be no delay during power on reset for standard configuration. If the compressor has been turned off for more than 2 minutes before power off, then the compressor can be turned on immediately upon thermostat switch on, otherwise it will have to wait until the 3 minutes has passed.

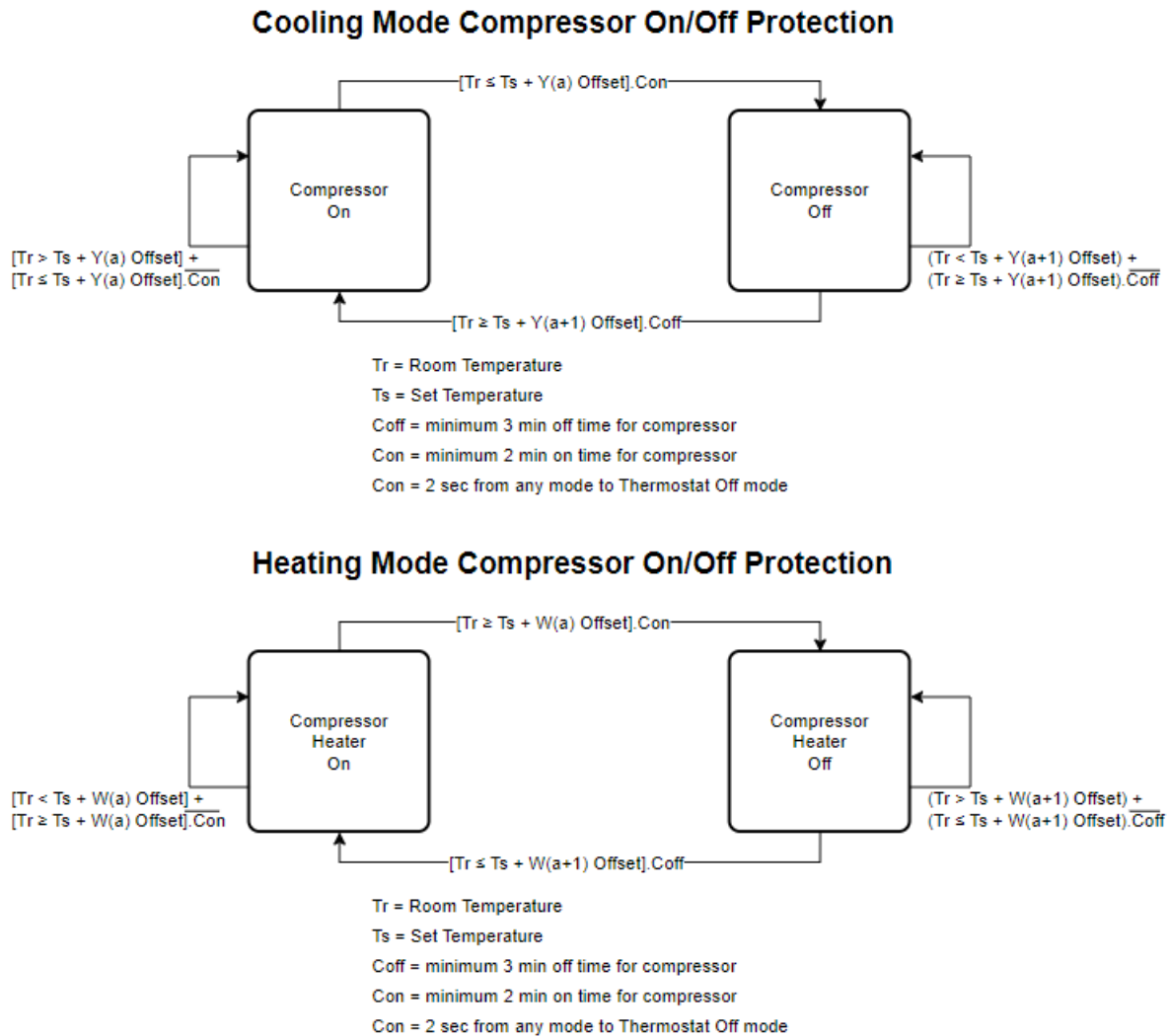

FIGURE 16: COMPRESSOR PROTECTION

### 8.2.3 4-Way Valve Changing

Before compressor cut in, if the 4-way valve is off, then the 4-way valve changing sequence must take effect to change the cooling circuit to that of heat pump circuit. The 4-way valve can only turn on in heat mode. Upon return to non-heat mode, the 4-way must change to OFF position. The 4-way valve only can be changed 56 seconds after the compressor has been cut out; the compressor after that can be cut in 2 minutes and 4 seconds later. When the 4-way valve has been changed and the compressor has not been switched on, the 4-way valve may still be changed again immediately.

Cooling Mode(O)

G	Y1	Y2	W1	O	B
ON	ON	ON	OFF	ON	OFF

Cooling Mode(B)

G	Y1	Y2	W1	O	B
ON	ON	ON	OFF	OFF	ON

Heating Mode(O)

G	Y1	Y2	W1	O	B
ON	ON	ON	OFF	OFF	ON

Heating Mode(B)

G	Y1	Y2	W1	O	B
ON	ON	ON	OFF	ON	OFF

4-Way Valve Changing : Cooling To Heating

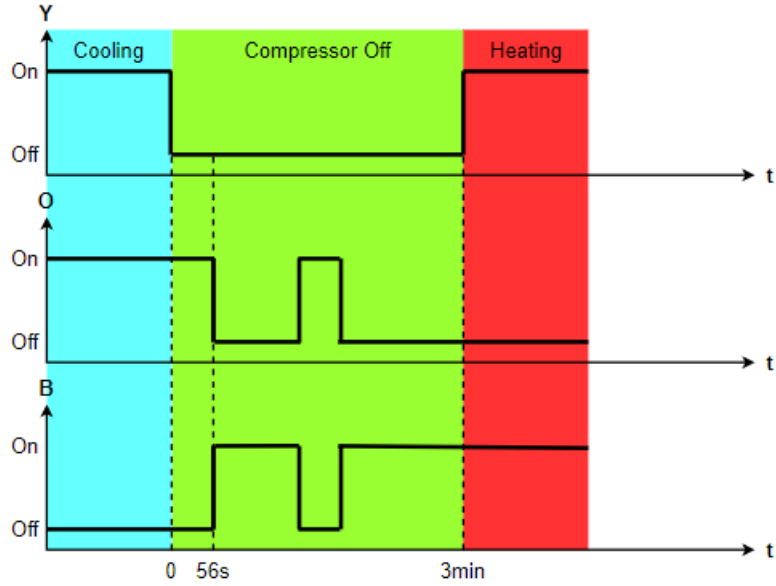

4-Way Valve Changing : Heating To Cooling

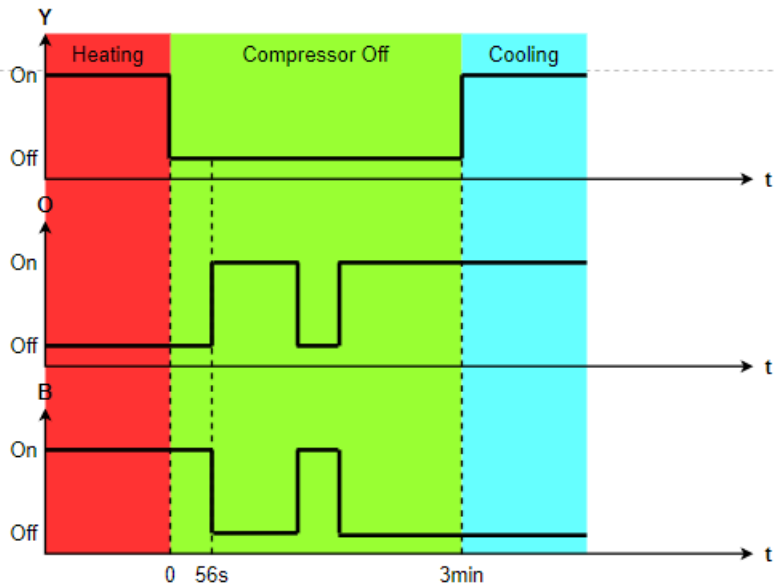

FIGURE 17: COMPRESSOR ON/OFF DELAY PROTECTION

### 8.3 Fan Coil Application

User can select the operating mode by touch screen mode button or remote access by network command. The available user selectable modes are: Off(by the power button), Fan, Dry, Cool, Heat and Auto.

Parameters used:

Cooling Setpoint	User selected cooling setpoint temperature
Y(1) Offset	Offset from set point, Y valve off, fan speed change to Low
Y2 Offset	Offset from set point, Y valve on, fan speed change to medium
Y3 Offset	Offset from set point, Y valve on, fan speed change to high
Heating Setpoint	User selected heating setpoint temperature
W1 Offset	Offset from set point, W valve off, fan speed change to Low
W2 Offset	Offset from set point, W valve on, fan speed change to medium
W3 Offset	Offset from set point, W valve on, fan speed change to high
Traveling Time	Use in Floating Valve application, in seconds, 0 = disable, max 65535s.
Boost Min Time	Activate higher Fan/stage when temperature stay in the zone for too long, in seconds , 0 = disable, max 65535s.

Default Value:

CoolSP = 25°C or 77°F

HeatSP = 20°C or 68°F

W1 Offset = 1.0                      Y1 Offsset = -0.5

W2 Offset = -3.5                    Y2 Offset = 1.5

W3 Offset = -5.0                    Y3 Offset = 3.0

Traveling Time = 0 s                Boost Stage Minimum Time = 180 s

**Note : Only SP has unit, either °C or °F, Offsets are unit-less and will add directly from SP.**

#### 8.3.1 Fan Operation

Four user selectable fan speed, Low, Medium, High and Auto. Whenever the system is on, the fan should be energized. When the user selected fan speed is not Auto, the fan shall operate at the user selected fan speed. In Dry Mode, the fan speed is always Low.

For Auto fan speed in Cool mode, its operation depends on room temperature and set point.

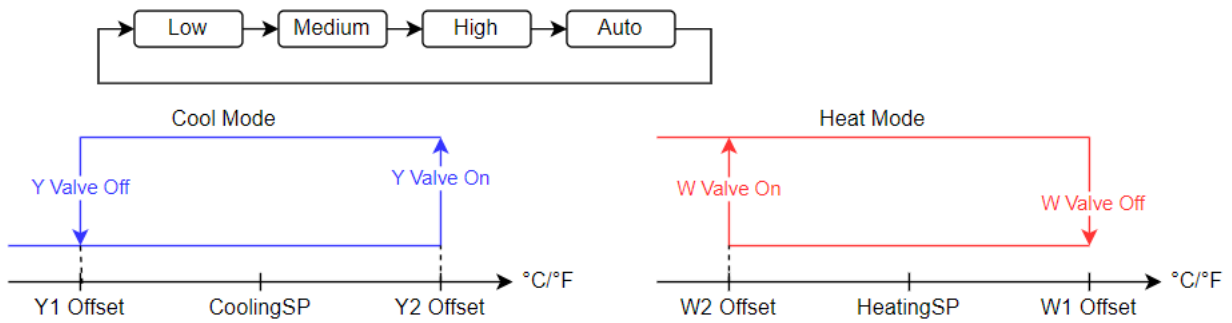

**Auto Fan Speed Sequence**

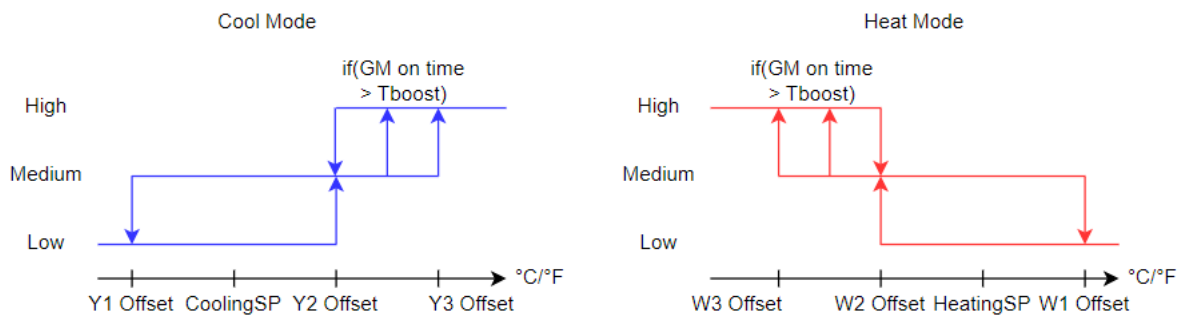

**FIGURE 18: FAN SPEED SEQUENCE IN COOL, HEAT AND AUTO FAN MODE**

**8.3.2 Two Pipe Cooling Mode And Heating Mode**

In this mode , fan is always running. User can select all fan speed.



**FIGURE 19: TWO PIPE COOLING AND HEATING MODE**

### 8.3.3 Two Pipe Cooling Only Operation Mode

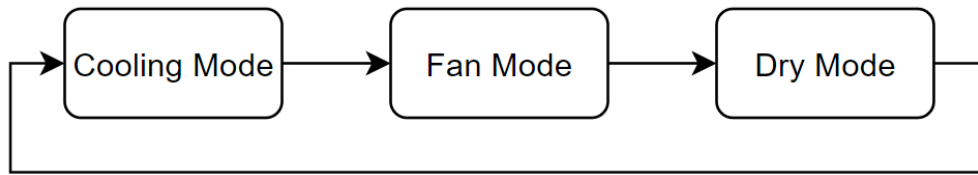

Operating Mode	Validity/Implement	Command from BACnet or LoRaWAN
Cooling Mode	Supported	Accepted
Fan Mode	Supported	Accepted
Heating Mode	Not Supported	Default to Cooling Mode
Auto Mode	Not Supported	Default to Cooling Mode
Dry Mode	Supported	Accepted

### 8.3.4 Two Pipe Heating Only Operation Mode

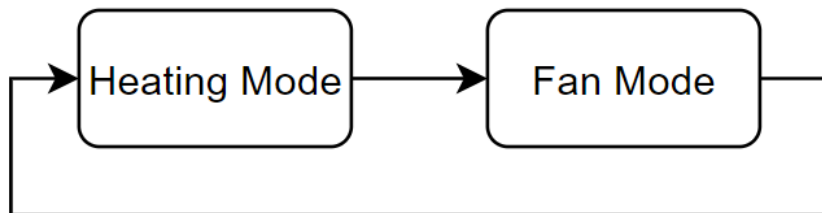

Operating Mode	Validity/Implement	Command from BACnet or LoRaWAN
Cooling Mode	Not Supported	Default to Heating Mode
Fan Mode	Supported	Accepted
Heating Mode	Supported	Accepted
Auto Mode	Not Supported	Default to Heating Mode
Dry Mode	Not Supported	Default to Heating Mode

### 8.3.5 Four Pipe Cooling , Heating And Auto Mode

#### Cool, Heat and Auto Mode Valve Control Sequence

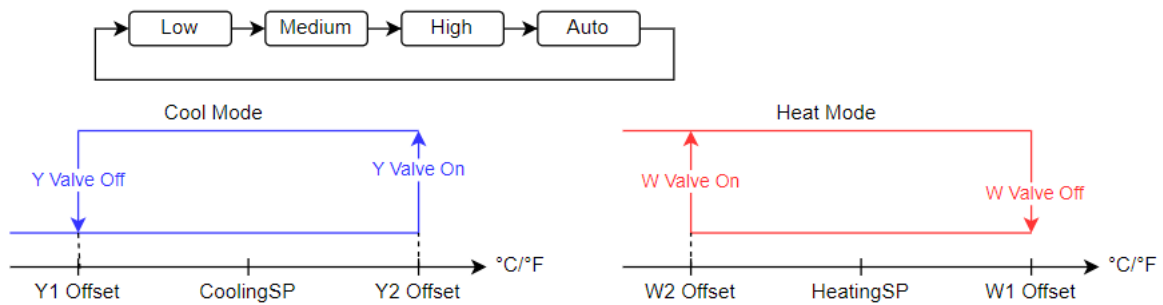

#### Auto Fan Speed Sequence

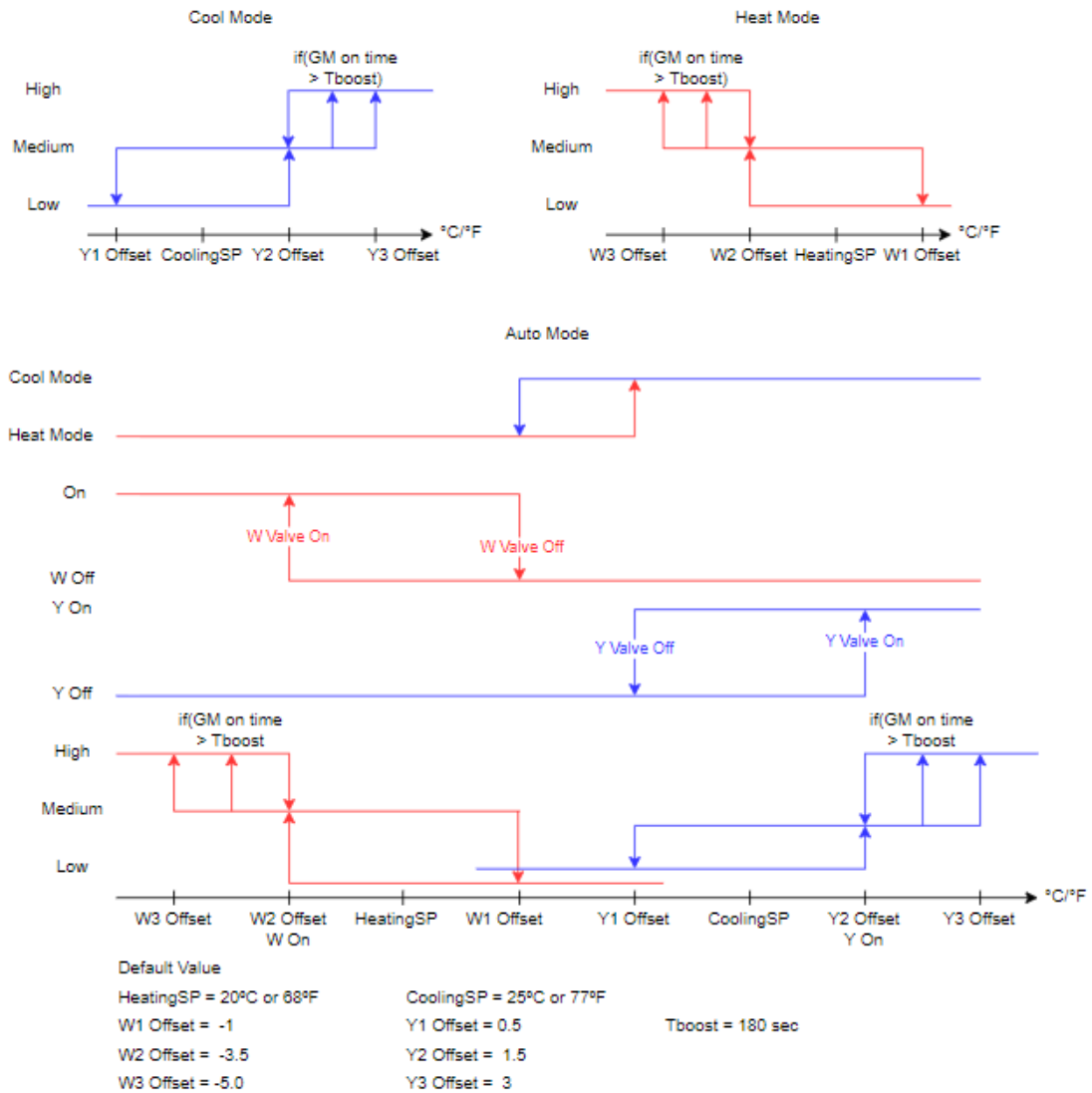
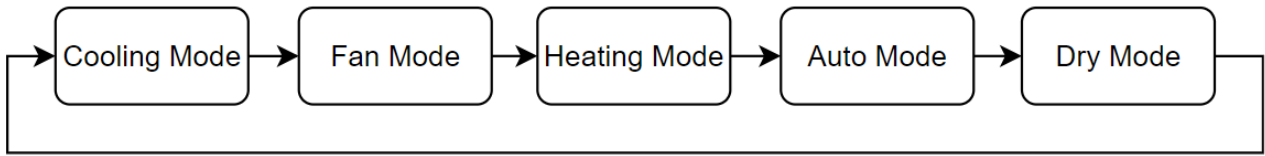

FIGURE 20: FOUR PIPE COOLING, HEATING AND AUTO MODE



### 8.3.6 Four Pipe Cooling, Heating and Auto Operation Mode



Operating Mode	Validity/Implement	Command from BACnet or LoRaWAN
Cooling Mode	Supported	Accepted
Fan Mode	Supported	Accepted
Heating Mode	Supported	Accepted
Auto Mode	Supported	Accepted
Dry Mode	Supported	Accepted

### 8.3.7 Fan Mode

User selectable speed are Low, Medium and High. No temperature setting is allowed. If the unit is running in Auto Fan speed, upon entering the Fan Mode, the unit will change the speed to Low. Vice-versa, if the unit is out from Fan Mode, then Auto Fan Speed will be restored.

### 8.3.8 Dry Mode

There are 4 operating Zone in Dry Mode. The operating Zone is determined by the difference between Room Temperature and Setpoint as shown below.

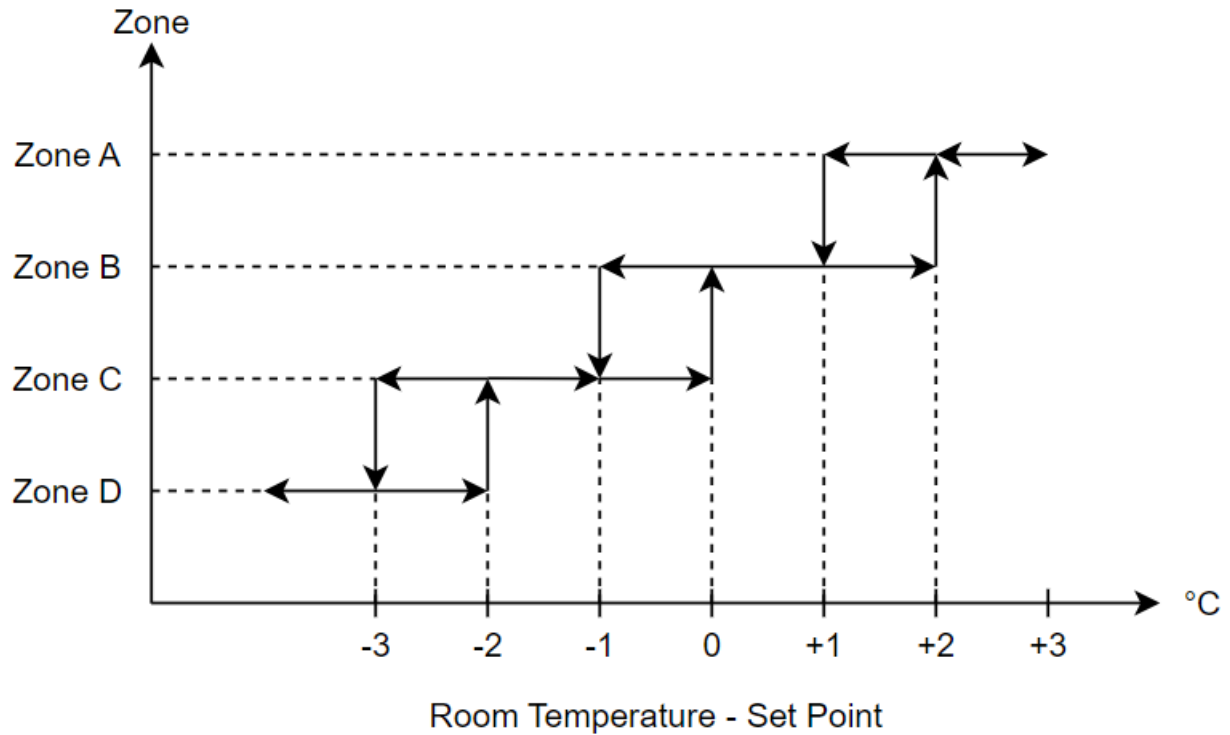

FIGURE 21: DRY MODE ZONES

The determination of Zone only will be done every 12 minutes(one cycle of Dry Mode cycle).

For the various operating zones, the cooling valve and the fan sequences are as shown below. Note that the low fan cuts in 30 seconds before the valve cuts in, and the low fan cuts out 30 seconds after the valve cuts out.

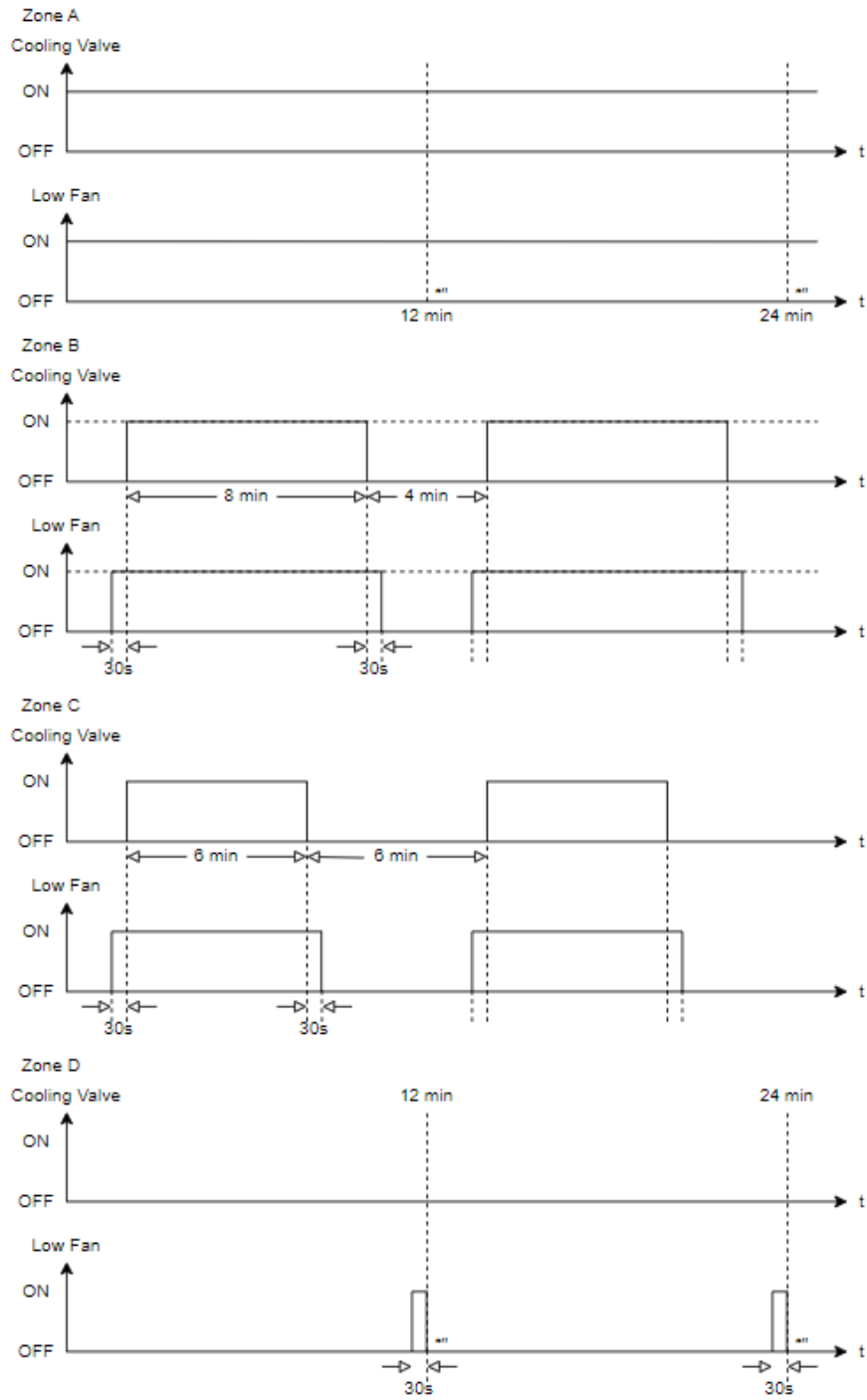
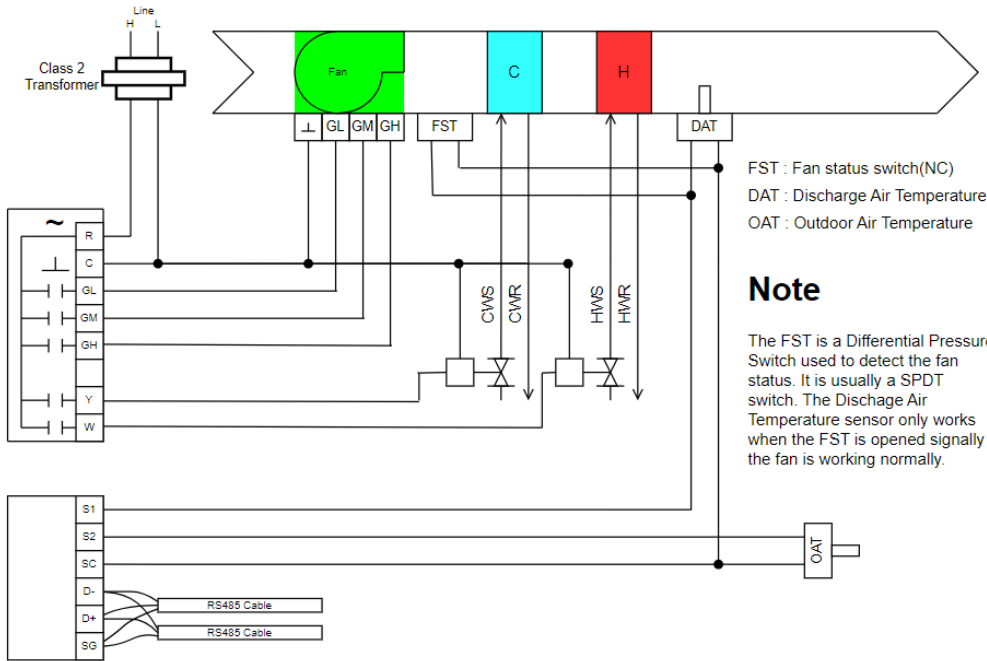

FIGURE 22: DRY MODE SEQUENCE

**FCU - Four Pipe, Three Speed Fan with Cooling and Heating**



FST : Fan status switch(NC)  
 DAT : Discharge Air Temperature  
 OAT : Outdoor Air Temperature

**Note**  
 The FST is a Differential Pressure Switch used to detect the fan status. It is usually a SPDT switch. The Discharge Air Temperature sensor only works when the FST is opened signally the fan is working normally.

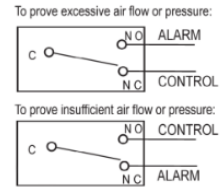

**Note : FST, DAT and OAT are not implemented yet.**

**8.3.9 FCU Application Type And Wiring**

01. Two Pipe Cooling With On/Off Valve

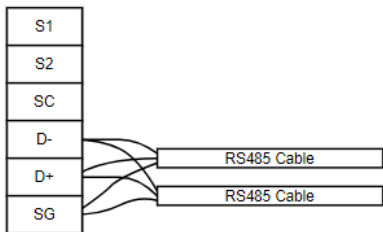
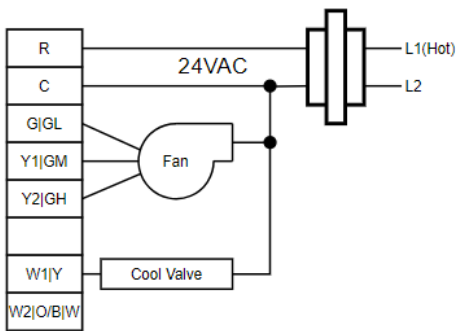

02. Two Pipe Heating With On/Off Valve

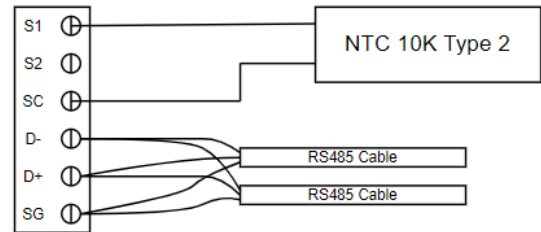
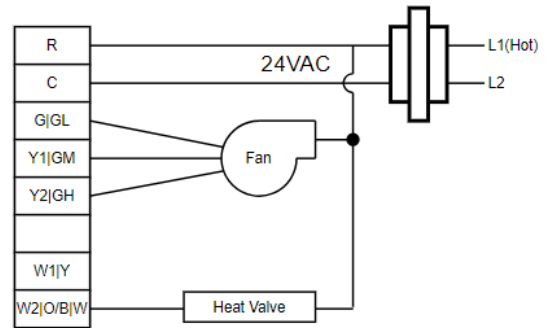

03. Two Pipe Cooling With Floating Valve

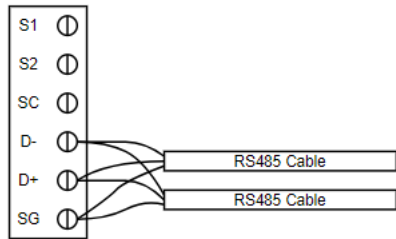
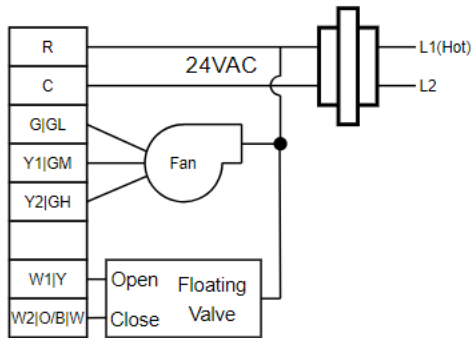

04. Two Pipe Heating With Floating Valve

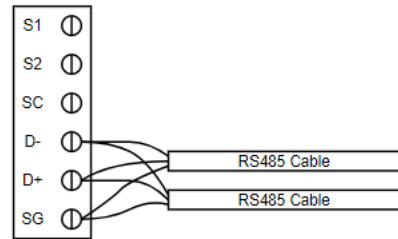
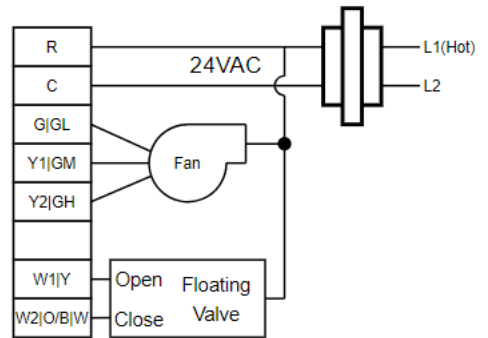

05. Four Pipe Cooling and Heating With On/Off Valve

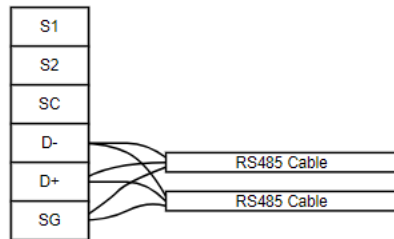
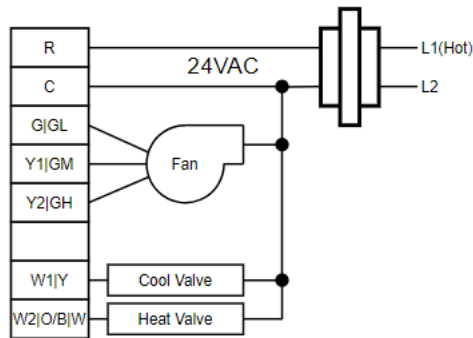

FIGURE 23: FCU APPLICATION AN TYPE AND WIRING

## 9. Operation Guides

### 9.1 Panel Operations

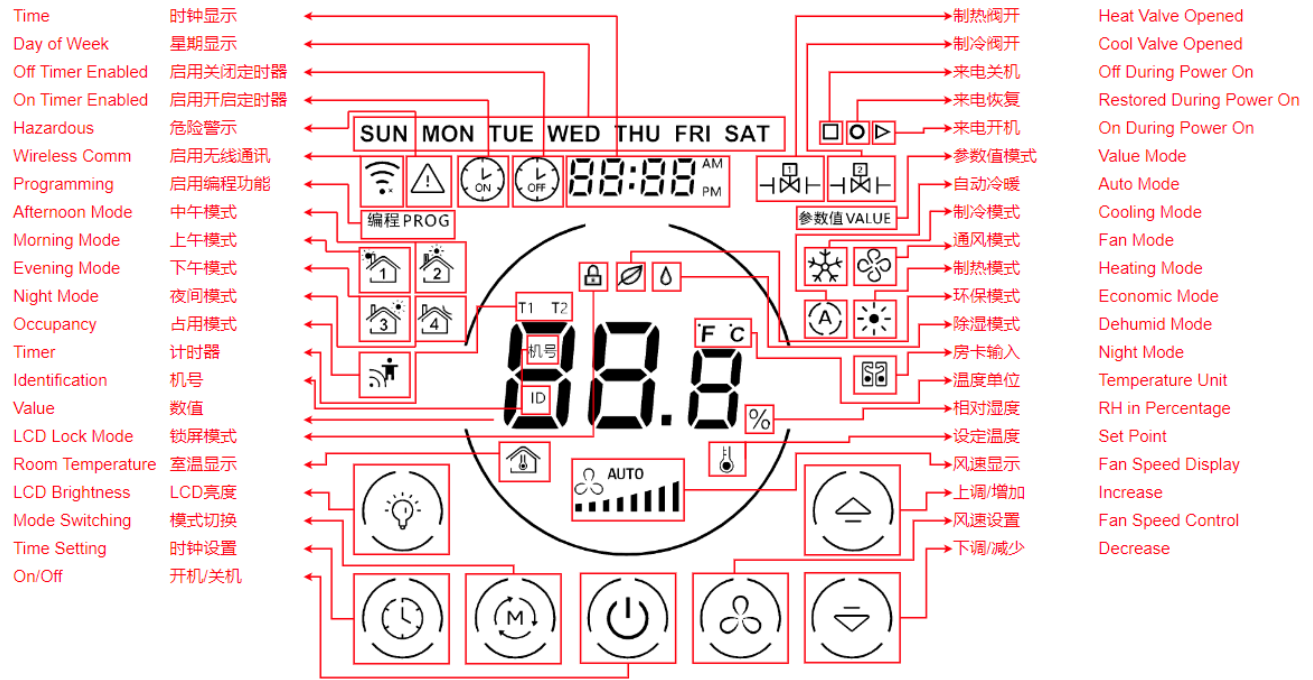













FIGURE 24: PANEL BUTTONS AND SYMBOLS

### 9.2 Mode



Press 'Mode'  button to switch the device modes. In 4 pipe FCU, HPU and RTU with both Heating and Cooling capabilities application, there are 4 modes can be switched to, which are 'Cool' , 'Fan' , 'Heat' , and 'Auto'  and 'Dry' .

### 9.3 Fan Speed

Press 'Fan Speed'  button to switch the fan speed. In FCU mode, there are 4 modes of speed can be switched to, which are 'low' , 'medium' , 'high' , and 'auto' . 'Auto' mode can only be set when the device is in 'Cool' or 'Heat' mode.



In HPU and RTU application, there is only one speed fan and it is always on.



### 9.4 Temperature Setting



Press 'Increase Temperature'  or 'Decrease Temperature'  to control the set temperature in 1°C of step level. To set the Cooling or Heating setpoint via the LCD panel, select the cooling mode or heating mode, then press the up or down key to change the cooling or heating setpoint respectively.





Auto mode will use these cooling and heating setpoint and can not change setpoint setting in auto mode. In auto mode, pressing up key will show the cooling setpoint, while pressing the down key will show the heating setpoint.





## 9.5 Time Setting





Press 'Time Setting'  button 1 time to enter to 'week' menu, the 'week' symbol will now be blinking, press 'Increase Temperature'  or 'Decrease Temperature'  button to configure the 'week' parameter.





Press 'Time Setting'  button 2 times to enter to 'hour' menu, the 'hour' symbol will now be blinking, press 'Increase Temperature'  or 'Decrease Temperature'  button to configure the 'hour' parameter.



Press 'Time Setting'  button 3 times to enter to 'minute' menu, the 'minute' symbol will now be blinking, press 'Increase Temperature'  or 'Decrease Temperature'  button to configure the 'minute' parameter.

Press 'Time Setting'  button 4 times to enter the 'hour open timer' menu, the 'Timer'  symbol and the 'hour' number will now be blinking (when the 'hour' is showing '—' instead of number, it means that the timer is not yet enabled), press 'Increase Temperature'  or 'Decrease Temperature'  button to configure the 'hour open timer' parameter.

Press 'Time Setting'  button 5 times to enter the 'minute open timer' menu, the 'Timer'  symbol and the 'minute' number will now be blinking (when the 'minute' is showing '—' instead of number, it means that the timer is not yet enabled), press 'Increase Temperature'  or 'Decrease Temperature'  button to configure the 'minute open timer' parameter.

Press 'Time Setting'  button 6 times to enter the 'hour close timer' menu, the 'Timer'  symbol and the 'hour' number will now be blinking (when the 'hour' is showing '—' instead of number, it means that the timer is not yet enabled), press 'Increase Temperature'  or 'Decrease Temperature'  button to configure the 'hour close timer' parameter.

Press 'Time Setting'  button 7 times to enter the 'minute close timer' menu, the 'Timer'  symbol and the 'minute' number will now be blinking (when the 'minute' is showing '—' instead of number, it means that the timer is not yet enabled), press 'Increase Temperature'  or 'Decrease Temperature'  button to configure the 'minute close timer' parameter.

Press 'Time Setting'  button 8 times to exit the time setting menus. If modification is made at the previous procedures, press 'Fan Speed'  button to instantly quick the time setting menus.

## 9.6 LCD Brightness

Press 'LCD Brightness'  button to adjust the brightness of the LCD.

## 9.7 Weekly Scheduler

The weekly scheduler consist of the following parameters:

Weekly Schedule Enable Sunday	: 0 = disable, 1 = enable
Weekly Schedule Enable Monday	: 0 = disable, 1 = enable
Weekly Schedule Enable Tuesday	: 0 = disable, 1 = enable
Weekly Schedule Enable Wednesday	: 0 = disable, 1 = enable
Weekly Schedule Enable Thursday	: 0 = disable, 1 = enable
Weekly Schedule Enable Friday	: 0 = disable, 1 = enable
Weekly Schedule Enable Saturday	: 0 = disable, 1 = enable
Scheduler On Time Hour	: 0-23, 24 = disable
Scheduler On Time Minute	: 0-59, 60 = disable
Scheduler Off Time Hour	: 0-23, 24 = disable
Scheduler Off Time Minute	: 0-59, 60 = disable
Morning Session Time Hour	: 0-23, 24 = disable
Morning Session Time Minute	: 0-59, 60 = disable
Afternoon Session Time Hour	: 0-23, 24 = disable
Afternoon Session Time Minute	: 0-59, 60 = disable



Evening Session Time Hour	: 0-23, 24 = disable
Evening Session Time Minute	: 0-59, 60 = disable
Night Session Time Hour	: 0-23, 24 = disable
Night Session Time Minute	: 0-59, 60 = disable
Morning Session Set Point	: Temperature Set Point for morning session
Afternoon Session Set Point	: Temperature Set Point for afternoon session
Evening Session Set Point	: Temperature Set Point for evening session
Night Session Set Point	: Temperature Set Point for night session

When the thermostat on time is reached but the session time is not yet reach, user set point is used.

If user changed the set point during any session, user set point is saved and used until the next session timer check point.

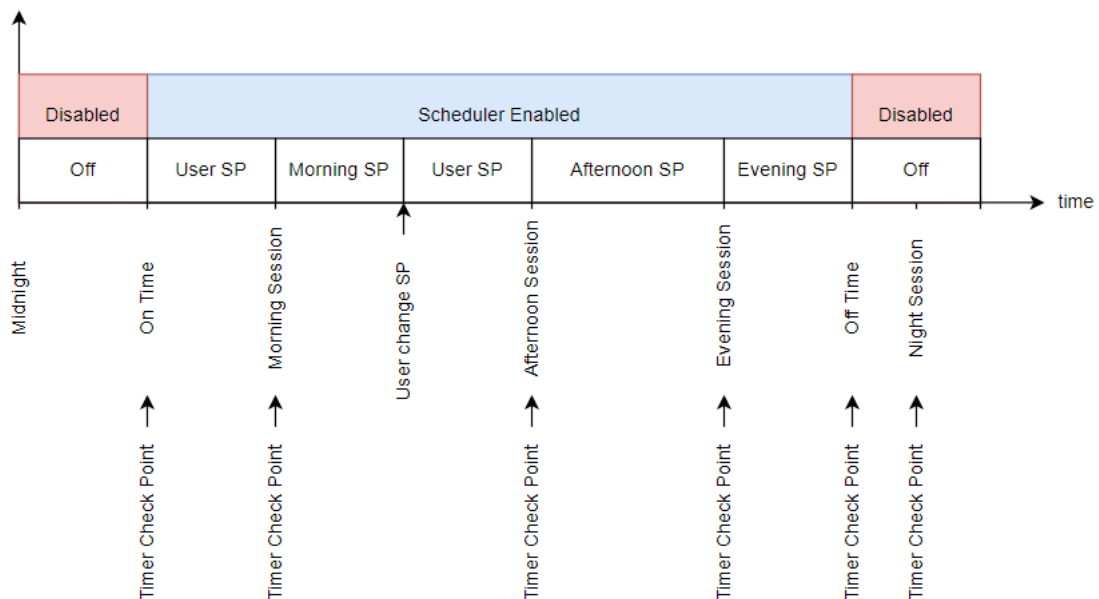







FIGURE 25: WEEKLY SCHEDULER





## 9.8 Temperature and Humidity Display





If the Model has humidity sensor, the humidity reader will be display with temperature alternatively with temperature display for 55s then humidity for 5s.



## 9.9 User Override

When scheduler is activated, user can override the scheduler using the following method.

Press and hold 'Mode'  button for around 5s, either 'Cool'  or 'Heat'  will be blinking depends on the current Application. Use the 'Increase Temperature'  or 'Decrease Temperature'  button to switch between Cool and Heat mode. Note that in certain Application, such as 2 Pipe Cooling or Heating only FCU, the mode would not switch as there is only one mode.

After the user override operation mode is selected, press 'Mode'  to enter user override set point setting, the "Set Point"  will be blinking. Use the 'Increase Temperature'  or 'Decrease Temperature'  button to select the desired user override set point.

Press 'Mode'  again to enter user override time in minutes. the 'Timer'  will be blinking and the time display will display the current user override default time. Use the 'Increase Temperature'  or 'Decrease Temperature'  button to select the desired user override time in minutes. The user override time is between 1 to 255 minutes.

Press 'Mode'  again to activates user override mode. In this mode, all off the Scheduler session symbol will be on, the 'Timer'  will be on, and the time display will be displaying the remaining user override time in minutes.

If the user wish to cancel or exit the user override mode, Press and hold 'Mode'  button for around 5s, this will cancel the user override mode and return to normal mode, whether if the scheduler is still active or not.

## 10. Communication

The Device ID and Modbus Address defaults to the third less significant byte of the serial number or DevEUI for LoRaWAN application unless user changed it in the terminal. For example:

SN/DevEUI = 0x18A7880200**12**0000

The BACnet ID or Modbus Address = 0x12 or 18 decimal.

If that byte is 0x00, the BACnet ID or Modbus Address default to 1.

### 10.1 Modbus RTU Settings

Modbus RTU supports the following:

Baud Rate	9600, 19200(Default), 38400, 57600, 115200
-----------	--

Parity	None, Odd, Even
Stop Bit	1, 2

## 10.2 BACnet MSTP Settings

For BACnet MSTP, user need to select the baud rate only as the parity and stop bit are fixed.

The selection of the parity and stop bit have no effect in BACnet MSTP.

Baud Rate	9600, 19200(Default), 38400, 76800
Parity	None(fixed)
Stop Bit	1(fixed)

## 11. USB Virtual COM Terminal Program

The Terminal Program provides a simple way to configure the controller with minimum hardware and software. It uses the controller's USB type C interface as virtual communication port, *MEK-i IO-Module Configuration Tools* or any dump terminal software and a PC.

After the LCD panel has been taken out from the back cover, connect the LCD panel to a computer via a USB type C data cable. The LCD panel will be powered by the USB type C cable. The computer will recognize the LCD panel as a virtual com port. Check the port number in the device manager.

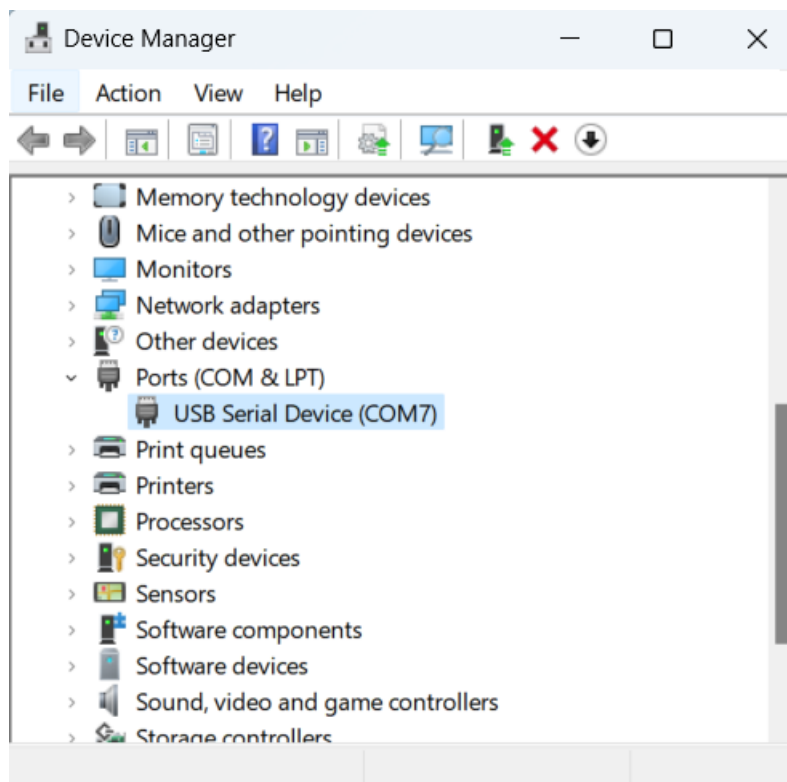

FIGURE 26 CHECK THE COMMUNICATION PORT NUMBER

To activate Terminal program, simply click the **Connect** on **Terminal** tab in *MEK-i IO-Module Configuration Tools* after select the correct PC serial communication port to establish the connection. If any dump terminal software (e.g. Hyper Terminal) is used, create a connection with following settings:

Baudrate	19200 bps
Data Bit	8 bits
Stop Bit	1 bit
Parity	Even
Flow Control	None

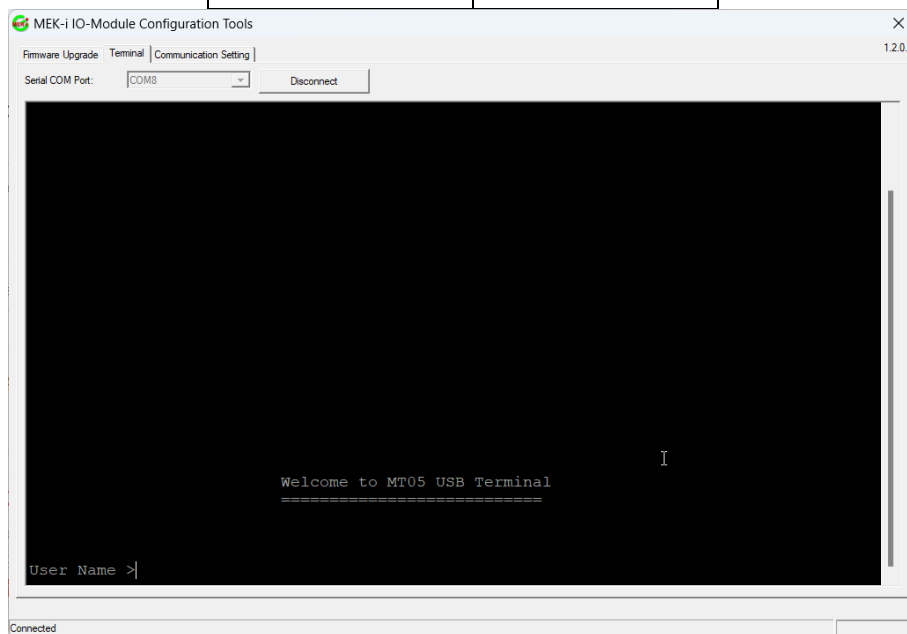

FIGURE 27 TERMINAL - LOGIN SCREEN

The default user name and password are **admin** and **1234** respectively. Follow the screen instructions for various settings. Press Esc key to return to previous menu or to refresh the display.

FIGURE 28 TERMINAL : MAIN MENU

### 11.1 User Name Menu

The User Name is used for Terminal Program login. The default value is 'admin'.

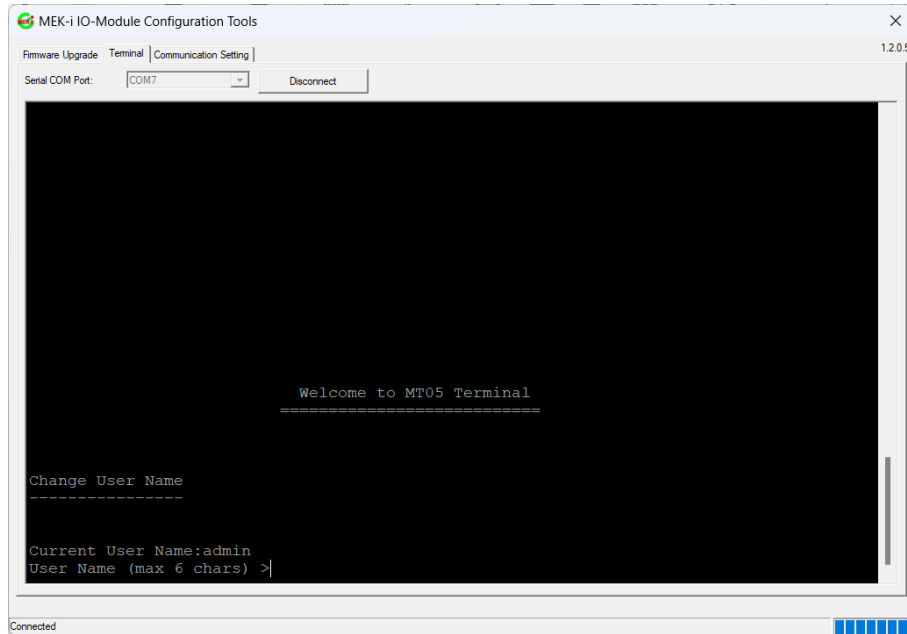

FIGURE 29 TERMINAL - USER NAME MENU

## 11.2 Password Menu

The Password is used for Terminal Program login. The default value is '1234'.

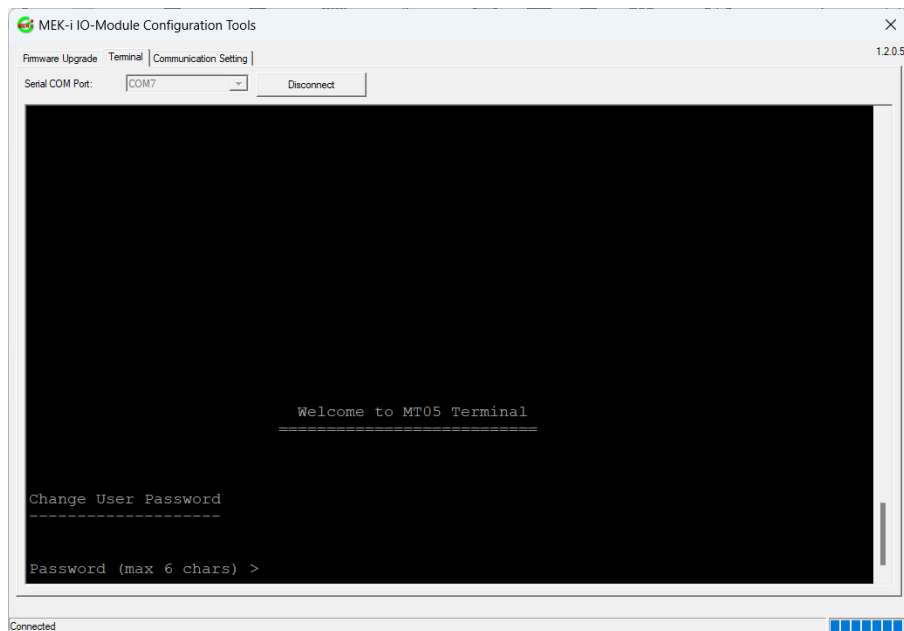
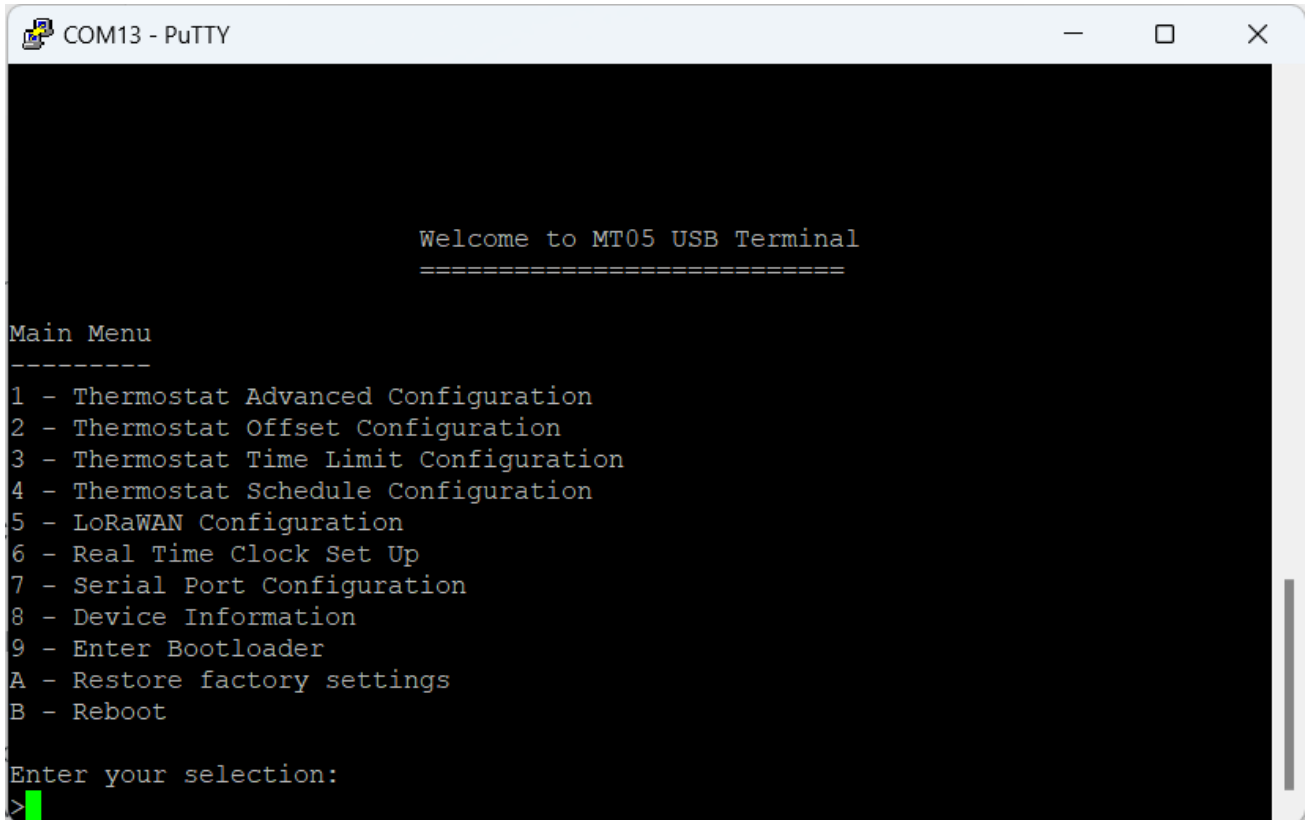

FIGURE 30: TERMINAL - PASSWORD MENU

## 11.3 Main Menu

The main menu consist of several setting menu as shown.



```
COM13 - PuTTY

Welcome to MT05 USB Terminal
=====

Main Menu
-----
1 - Thermostat Advanced Configuration
2 - Thermostat Offset Configuration
3 - Thermostat Time Limit Configuration
4 - Thermostat Schedule Configuration
5 - LoRaWAN Configuration
6 - Real Time Clock Set Up
7 - Serial Port Configuration
8 - Device Information
9 - Enter Bootloader
A - Restore factory settings
B - Reboot

Enter your selection:
>
```

## 11.4 Thermostat Advanced Configuration

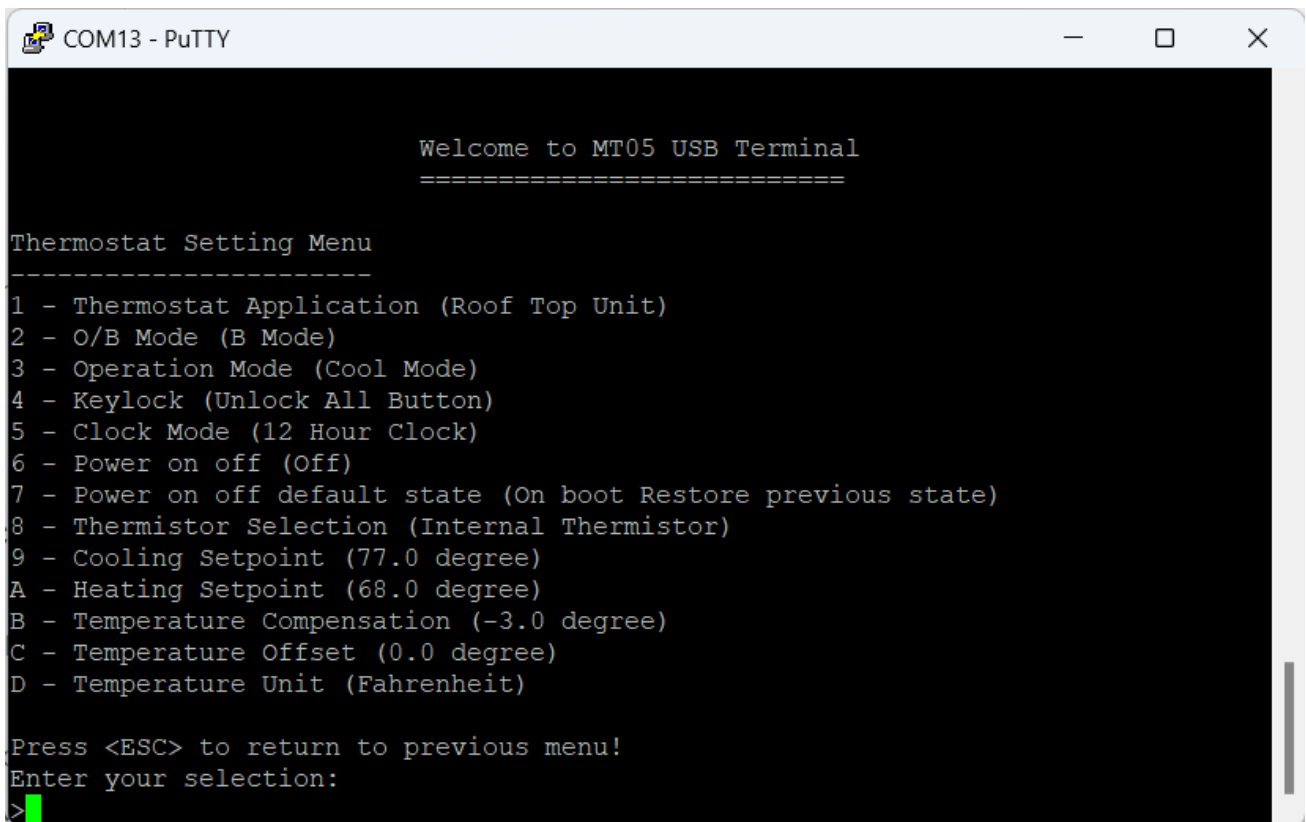

```
COM13 - PuTTY

Welcome to MT05 USB Terminal
=====

Thermostat Setting Menu
-----
1 - Thermostat Application (Roof Top Unit)
2 - O/B Mode (B Mode)
3 - Operation Mode (Cool Mode)
4 - Keylock (Unlock All Button)
5 - Clock Mode (12 Hour Clock)
6 - Power on off (Off)
7 - Power on off default state (On boot Restore previous state)
8 - Thermistor Selection (Internal Thermistor)
9 - Cooling Setpoint (77.0 degree)
A - Heating Setpoint (68.0 degree)
B - Temperature Compensation (-3.0 degree)
C - Temperature Offset (0.0 degree)
D - Temperature Unit (Fahrenheit)

Press <ESC> to return to previous menu!
Enter your selection:
>
```

### 11.4.1 Thermostat Application

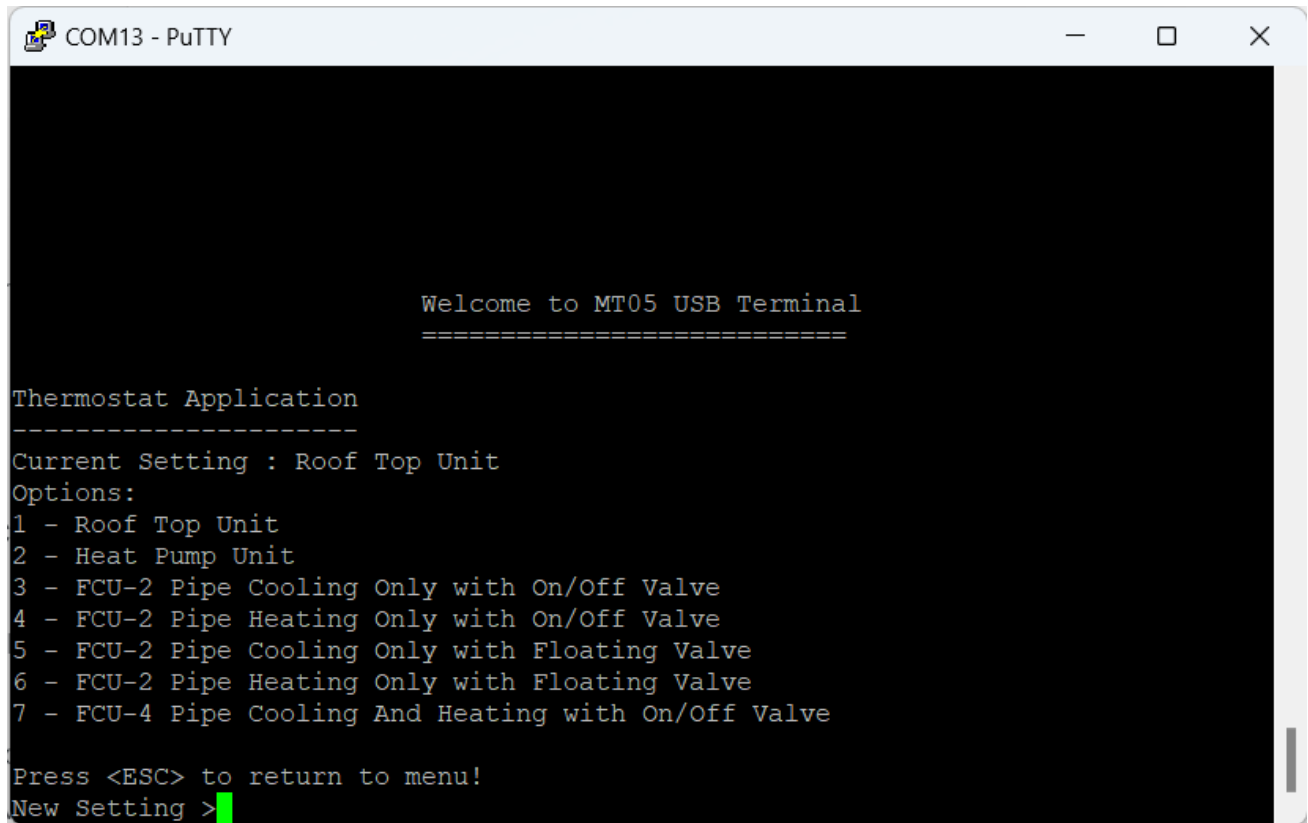

```
COM13 - PuTTY

Welcome to MT05 USB Terminal
=====

Thermostat Application
-----
Current Setting : Roof Top Unit
Options:
1 - Roof Top Unit
2 - Heat Pump Unit
3 - FCU-2 Pipe Cooling Only with On/Off Valve
4 - FCU-2 Pipe Heating Only with On/Off Valve
5 - FCU-2 Pipe Cooling Only with Floating Valve
6 - FCU-2 Pipe Heating Only with Floating Valve
7 - FCU-4 Pipe Cooling And Heating with On/Off Valve

Press <ESC> to return to menu!
New Setting >
```

There are twelve application:

1. Roof Top Unit
2. Heat Pump Unit
3. Fan Coil Unit Two Pipe Cooling Only With On/Off Valve
4. Fan Coil Unit Two Pipe Heating Only With On/Off Valve
5. Fan Coil Unit Two Pipe Cooling Only With Floating Valve
6. Fan Coil Unit Two Pipe Cooling Only With Floating Valve
7. Fan Coil Unit Four Pipe Cooling and Heating With On/Off Valve

### 11.4.2 O/B Mode

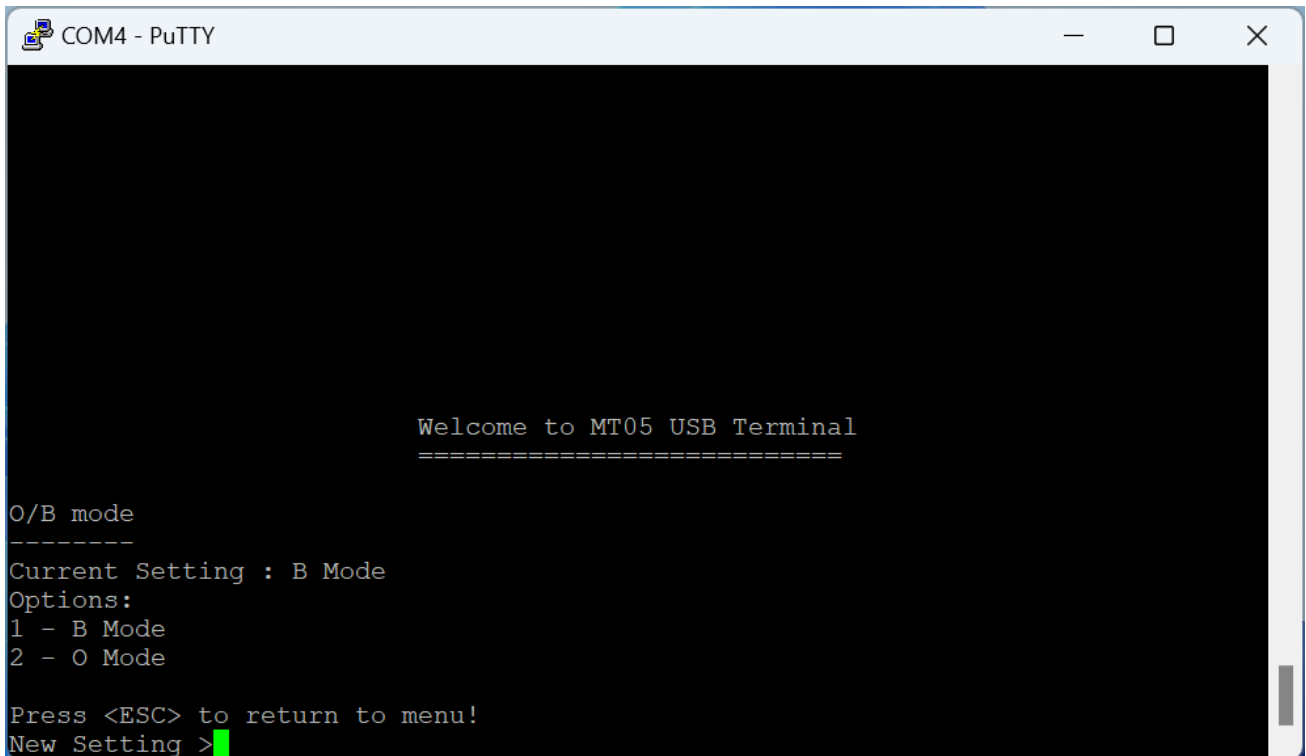

```
COM4 - PuTTY
Welcome to MT05 USB Terminal
=====
O/B mode
-----
Current Setting : B Mode
Options:
1 - B Mode
2 - O Mode
Press <ESC> to return to menu!
New Setting >
```

This defines the Four Way Valve Switch in O or B mode.

### 11.4.3 Operation Mode

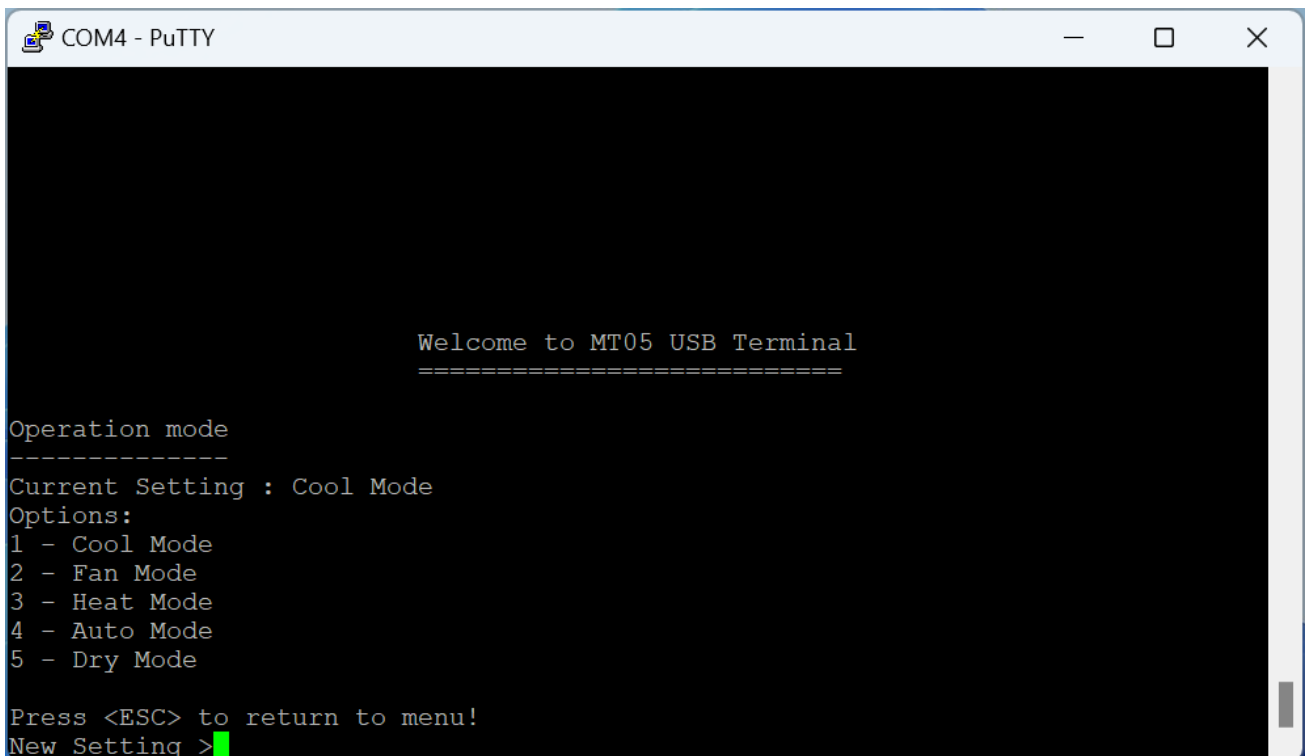

```
COM4 - PuTTY
Welcome to MT05 USB Terminal
=====
Operation mode
-----
Current Setting : Cool Mode
Options:
1 - Cool Mode
2 - Fan Mode
3 - Heat Mode
4 - Auto Mode
5 - Dry Mode
Press <ESC> to return to menu!
New Setting >
```

Retrieve and control the current operation mode.



Depends on the selected application, some of the application does not support certain operation mode. Refer to [section 8](#) for further details.

#### 11.4.4 Keylock

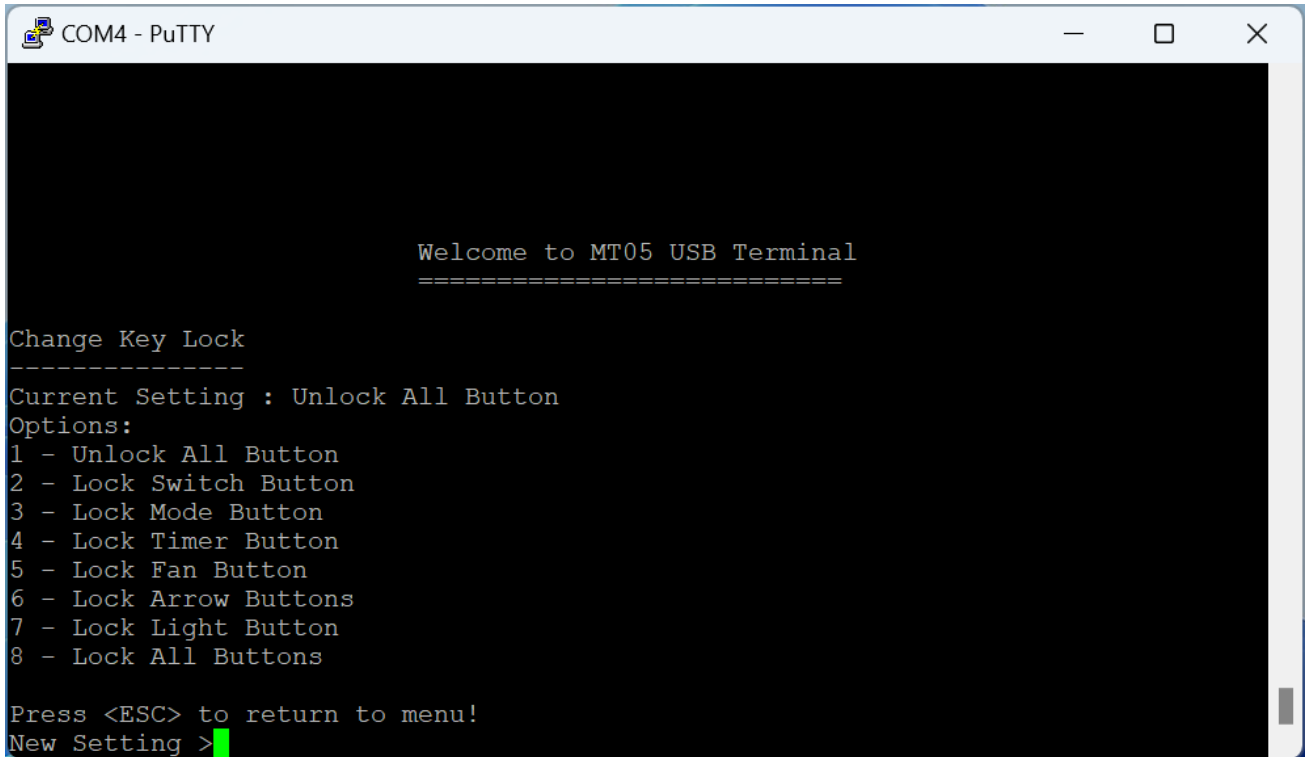

```
COM4 - PuTTY

Welcome to MT05 USB Terminal
=====

Change Key Lock
-----
Current Setting : Unlock All Button
Options:
1 - Unlock All Button
2 - Lock Switch Button
3 - Lock Mode Button
4 - Lock Timer Button
5 - Lock Fan Button
6 - Lock Arrow Buttons
7 - Lock Light Button
8 - Lock All Buttons

Press <ESC> to return to menu!
New Setting >
```

Touch screen button can be locked to prevent user changing the settings.

### 11.4.5 Clock Mode

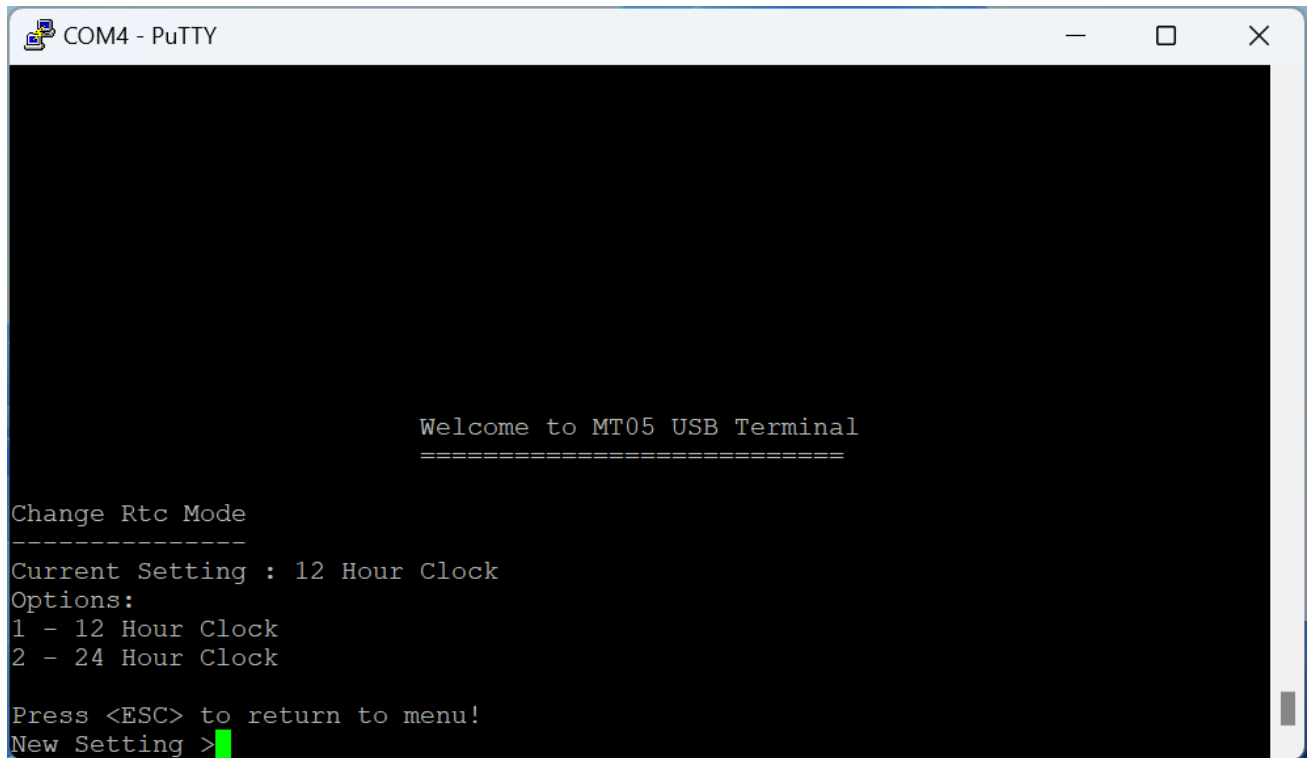

```
COM4 - PuTTY

Welcome to MT05 USB Terminal
=====

Change Rtc Mode
-----
Current Setting : 12 Hour Clock
Options:
1 - 12 Hour Clock
2 - 24 Hour Clock

Press <ESC> to return to menu!
New Setting >
```

Clock display can be set to 24 hour format or 12 hour format.

### 11.4.6 Power On Off

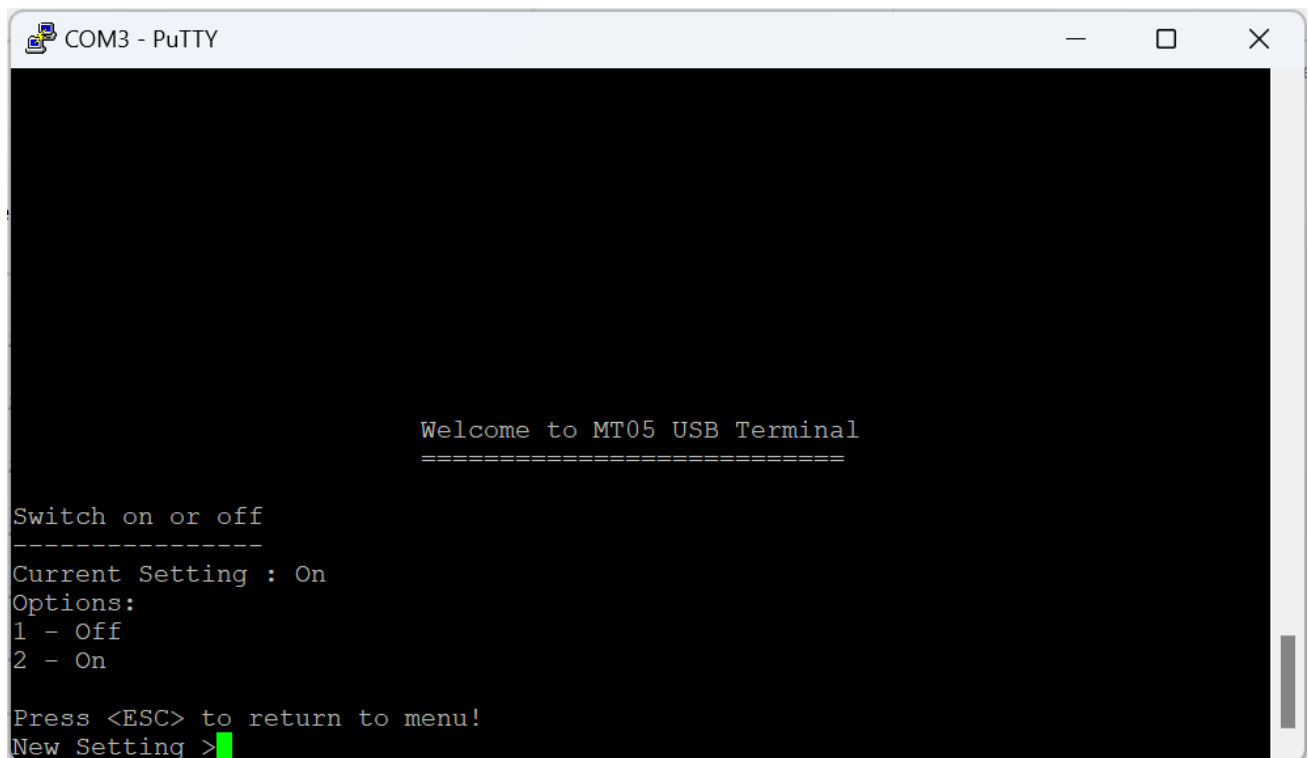

```
COM3 - PuTTY

Welcome to MT05 USB Terminal
=====

Switch on or off
-----
Current Setting : On
Options:
1 - Off
2 - On

Press <ESC> to return to menu!
New Setting >
```

Set the device on or off.

### 11.4.7 Power On Default State

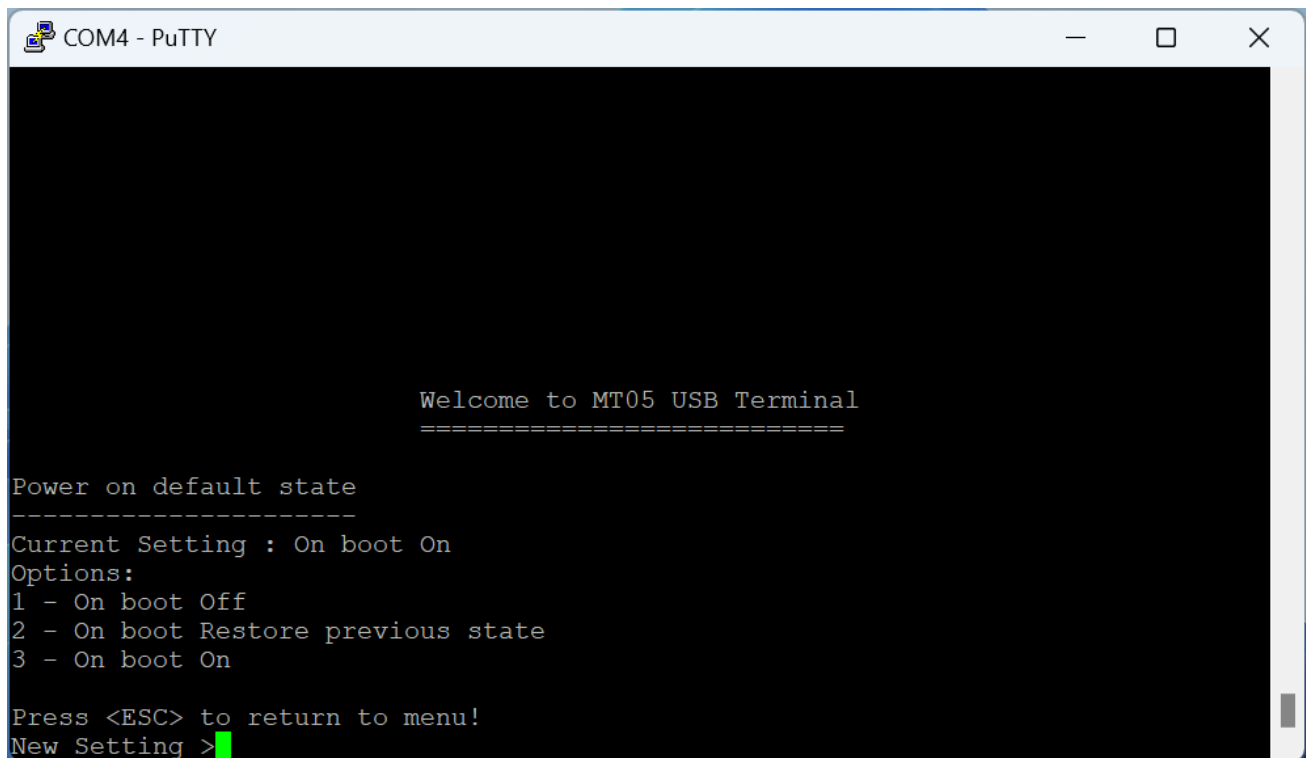

```
COM4 - PuTTY

Welcome to MT05 USB Terminal
=====

Power on default state
-----
Current Setting : On boot On
Options:
1 - On boot Off
2 - On boot Restore previous state
3 - On boot On

Press <ESC> to return to menu!
New Setting >
```

Configure the power on default state.

### 11.4.8 Thermistor Selection

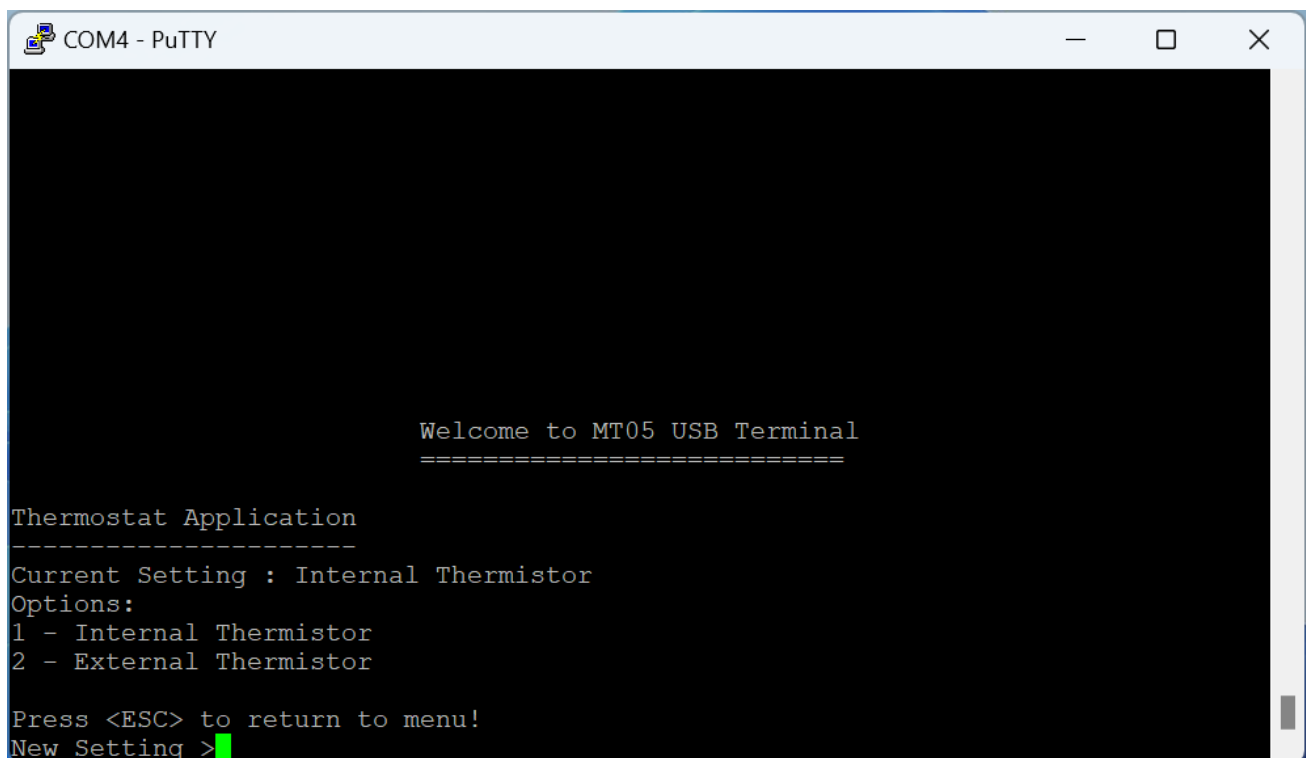

```
COM4 - PuTTY

Welcome to MT05 USB Terminal
=====

Thermostat Application
-----
Current Setting : Internal Thermistor
Options:
1 - Internal Thermistor
2 - External Thermistor

Press <ESC> to return to menu!
New Setting >
```

Select internal or external thermistor sensor.

### 11.4.9 Cooling Set Point

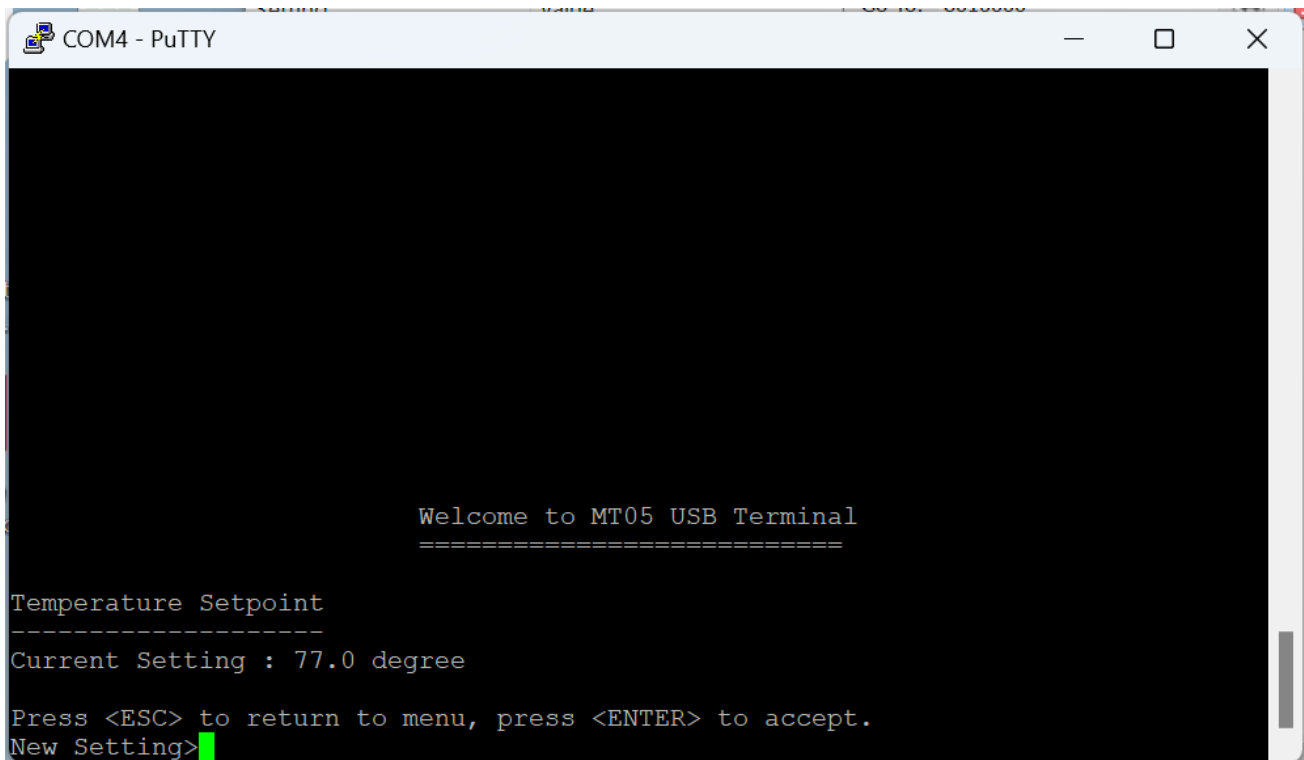

A screenshot of a PuTTY terminal window titled "COM4 - PuTTY". The terminal displays the following text:

```
Welcome to MT05 USB Terminal
=====

Temperature Setpoint
-----
Current Setting : 77.0 degree

Press <ESC> to return to menu, press <ENTER> to accept.
New Setting>
```

### 11.4.10 Heating Set Point

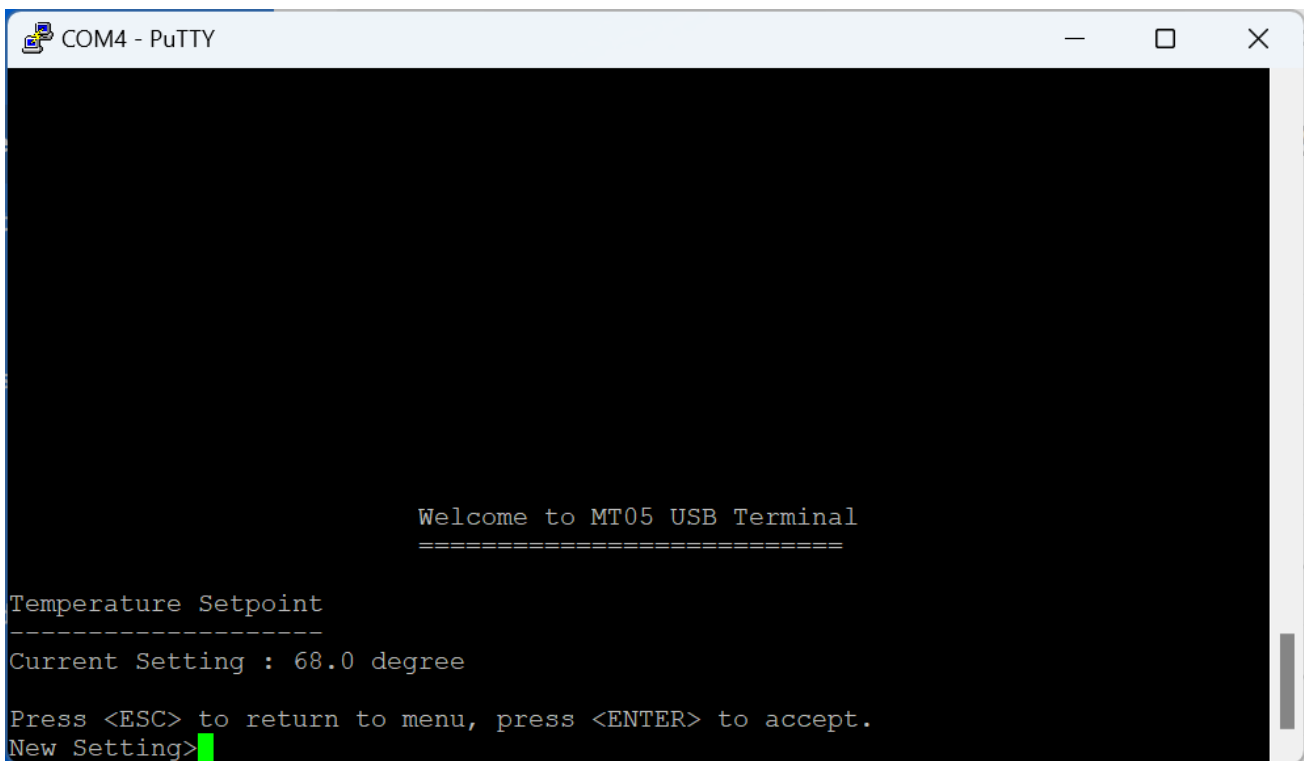

A screenshot of a PuTTY terminal window titled "COM4 - PuTTY". The terminal displays the following text:

```
Welcome to MT05 USB Terminal
=====

Temperature Setpoint
-----
Current Setting : 68.0 degree

Press <ESC> to return to menu, press <ENTER> to accept.
New Setting>
```

### 11.4.11 Temperature Compensation

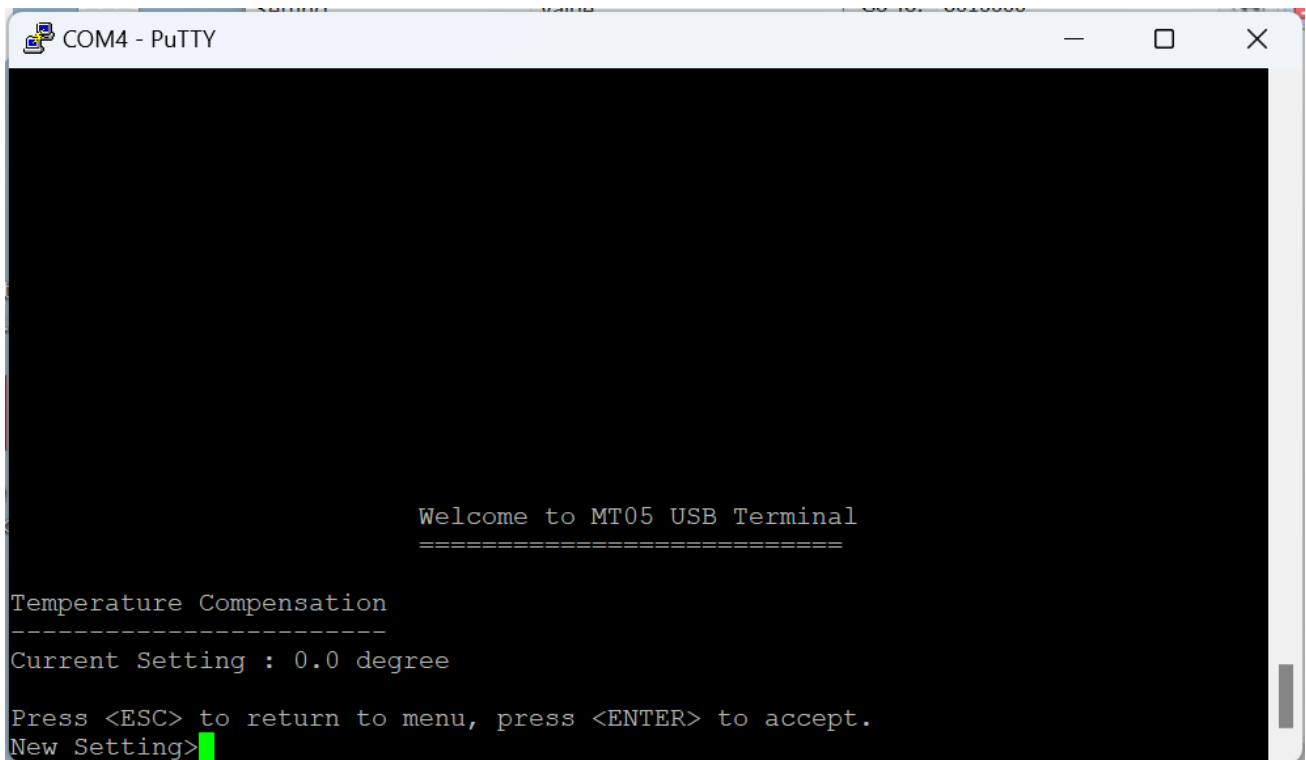

```
COM4 - PuTTY

Welcome to MT05 USB Terminal
=====

Temperature Compensation
-----
Current Setting : 0.0 degree

Press <ESC> to return to menu, press <ENTER> to accept.
New Setting>
```

### 11.4.12 Temperature Offset

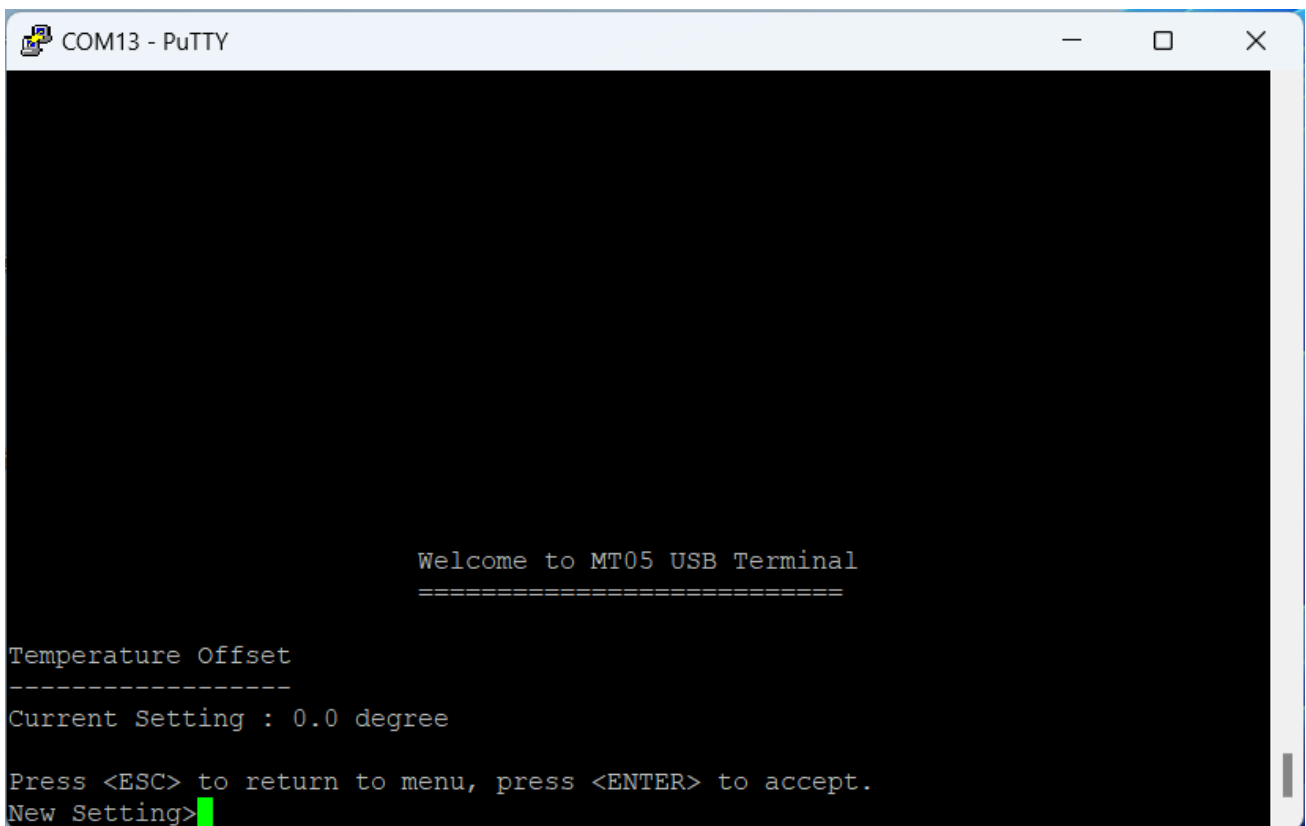

```
COM13 - PuTTY

Welcome to MT05 USB Terminal
=====

Temperature Offset
-----
Current Setting : 0.0 degree

Press <ESC> to return to menu, press <ENTER> to accept.
New Setting>
```

### 11.4.13 Temperature Unit

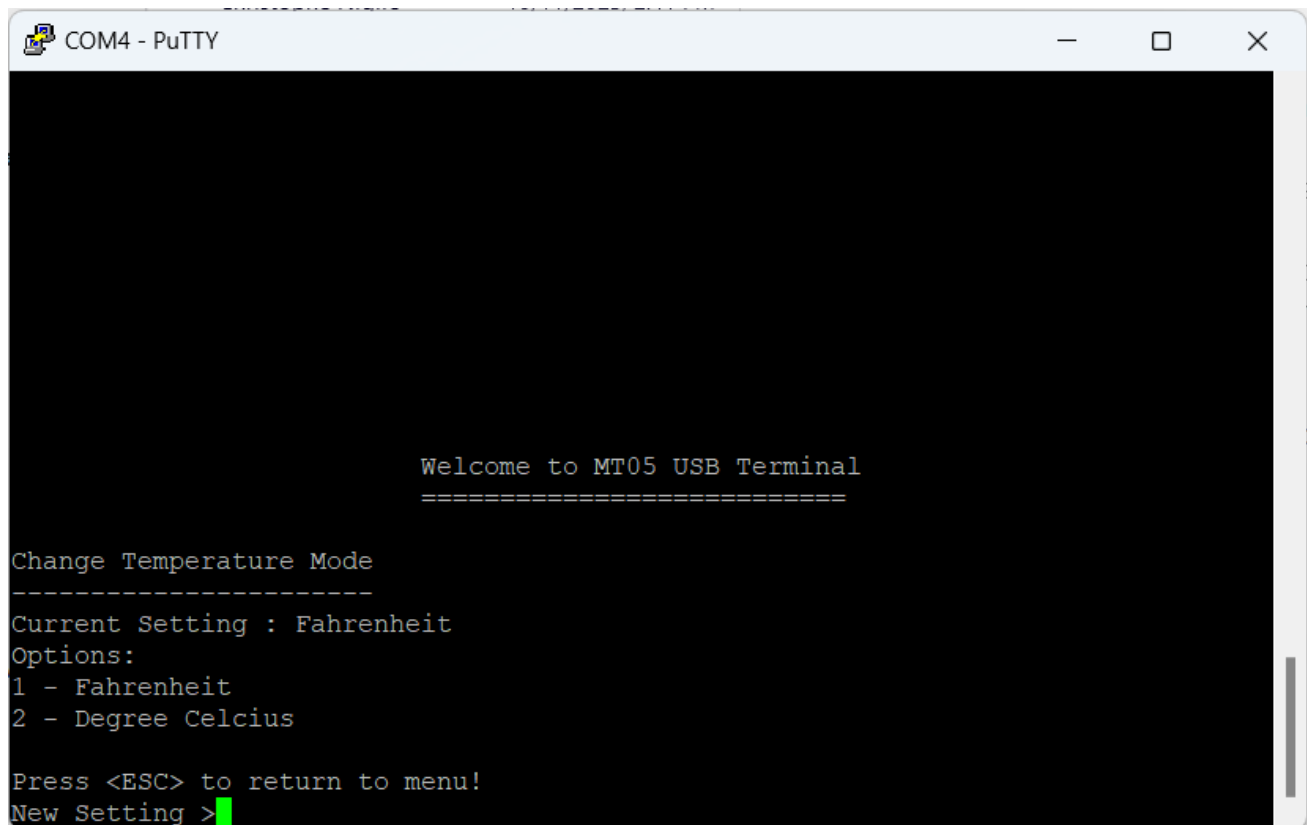

```
COM4 - PuTTY

Welcome to MT05 USB Terminal
=====

Change Temperature Mode
-----
Current Setting : Fahrenheit
Options:
1 - Fahrenheit
2 - Degree Celcius

Press <ESC> to return to menu!
New Setting >
```

Select temperature unit.

### 11.5 Thermostat Offset Configuration

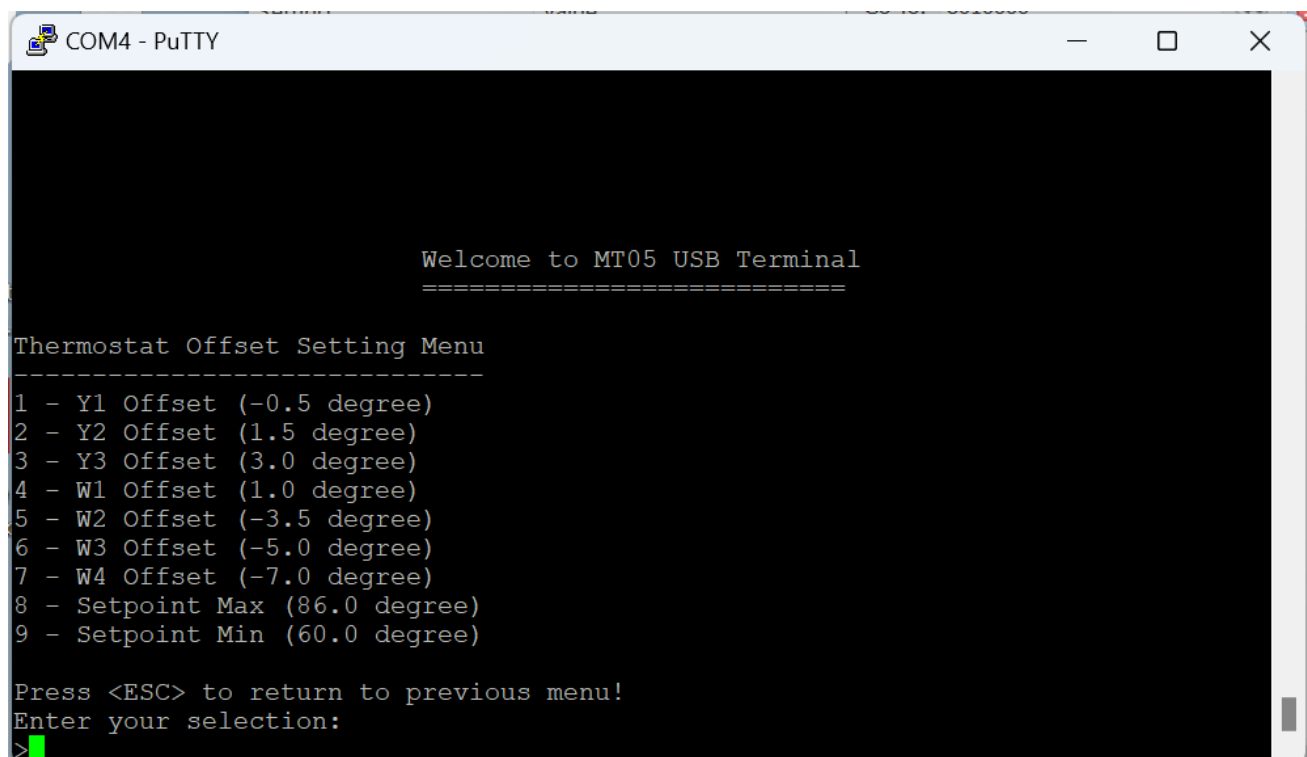

```
COM4 - PuTTY

Welcome to MT05 USB Terminal
=====

Thermostat Offset Setting Menu
-----
1 - Y1 Offset (-0.5 degree)
2 - Y2 Offset (1.5 degree)
3 - Y3 Offset (3.0 degree)
4 - W1 Offset (1.0 degree)
5 - W2 Offset (-3.5 degree)
6 - W3 Offset (-5.0 degree)
7 - W4 Offset (-7.0 degree)
8 - Setpoint Max (86.0 degree)
9 - Setpoint Min (60.0 degree)

Press <ESC> to return to previous menu!
Enter your selection:
>
```

Various Offset and Setpoint Maximum and minimum settings

## 11.6 Thermostat User Override Default Time

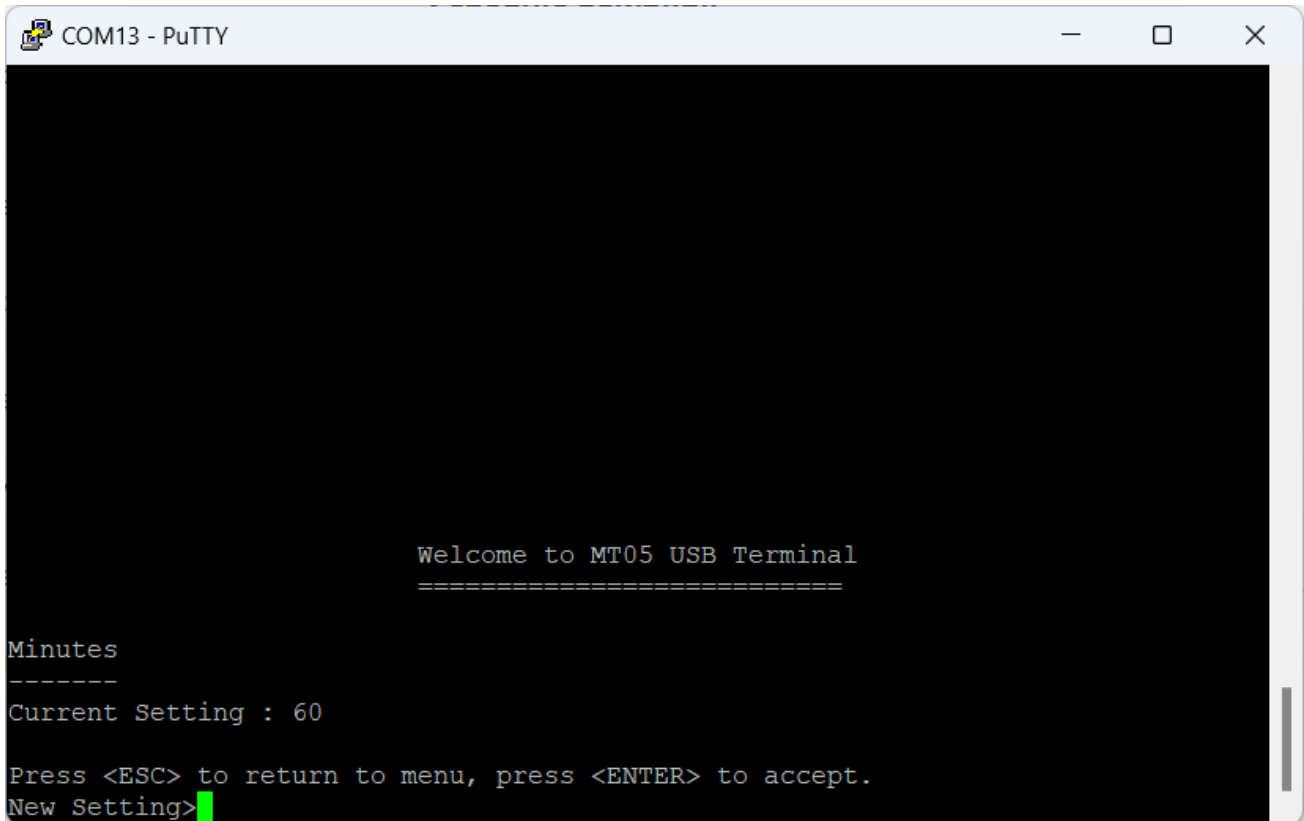

```
COM13 - PuTTY

Welcome to MT05 USB Terminal
=====

Minutes
-----
Current Setting : 60

Press <ESC> to return to menu, press <ENTER> to accept.
New Setting>
```

## 11.7 Thermostat Time Limit Configuration

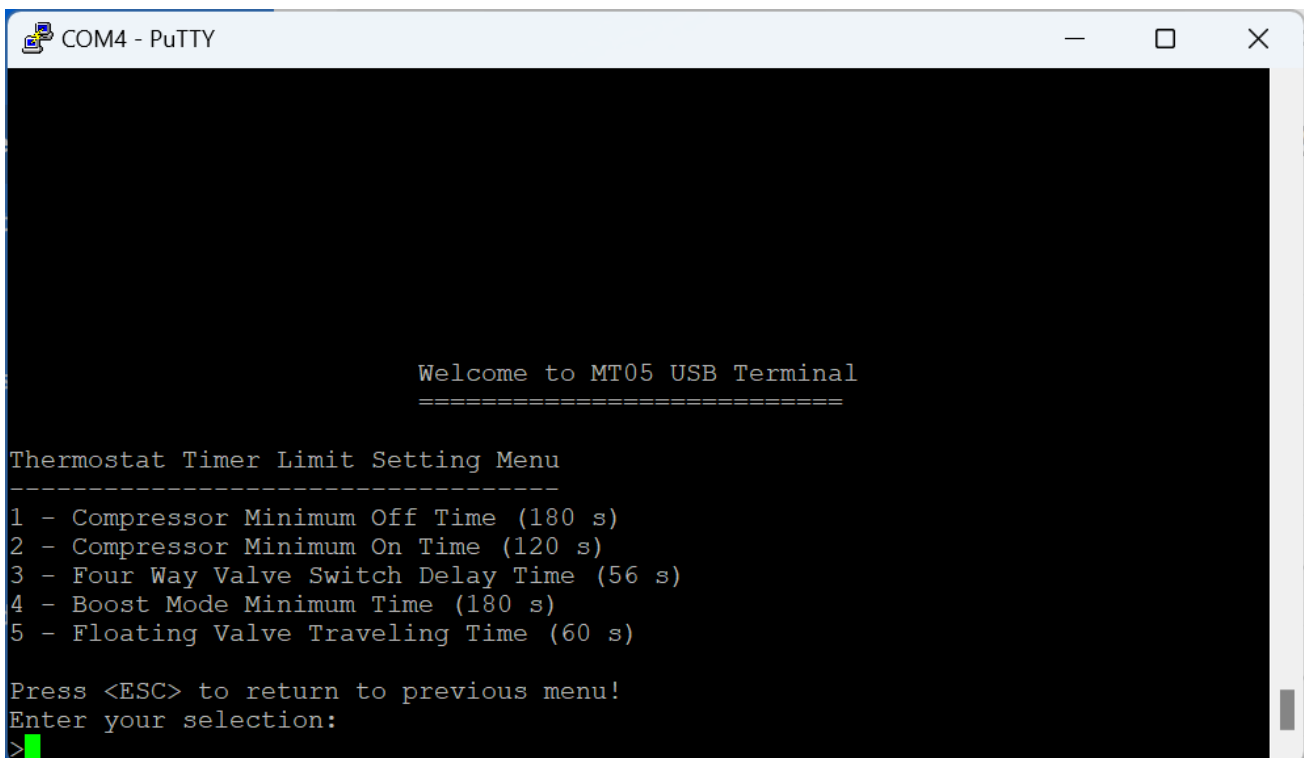

```
COM4 - PuTTY

Welcome to MT05 USB Terminal
=====

Thermostat Timer Limit Setting Menu
-----
1 - Compressor Minimum Off Time (180 s)
2 - Compressor Minimum On Time (120 s)
3 - Four Way Valve Switch Delay Time (56 s)
4 - Boost Mode Minimum Time (180 s)
5 - Floating Valve Traveling Time (60 s)

Press <ESC> to return to previous menu!
Enter your selection:
>
```

Various minimum timing settings

## 11.8 Thermostat Schedule Configuration

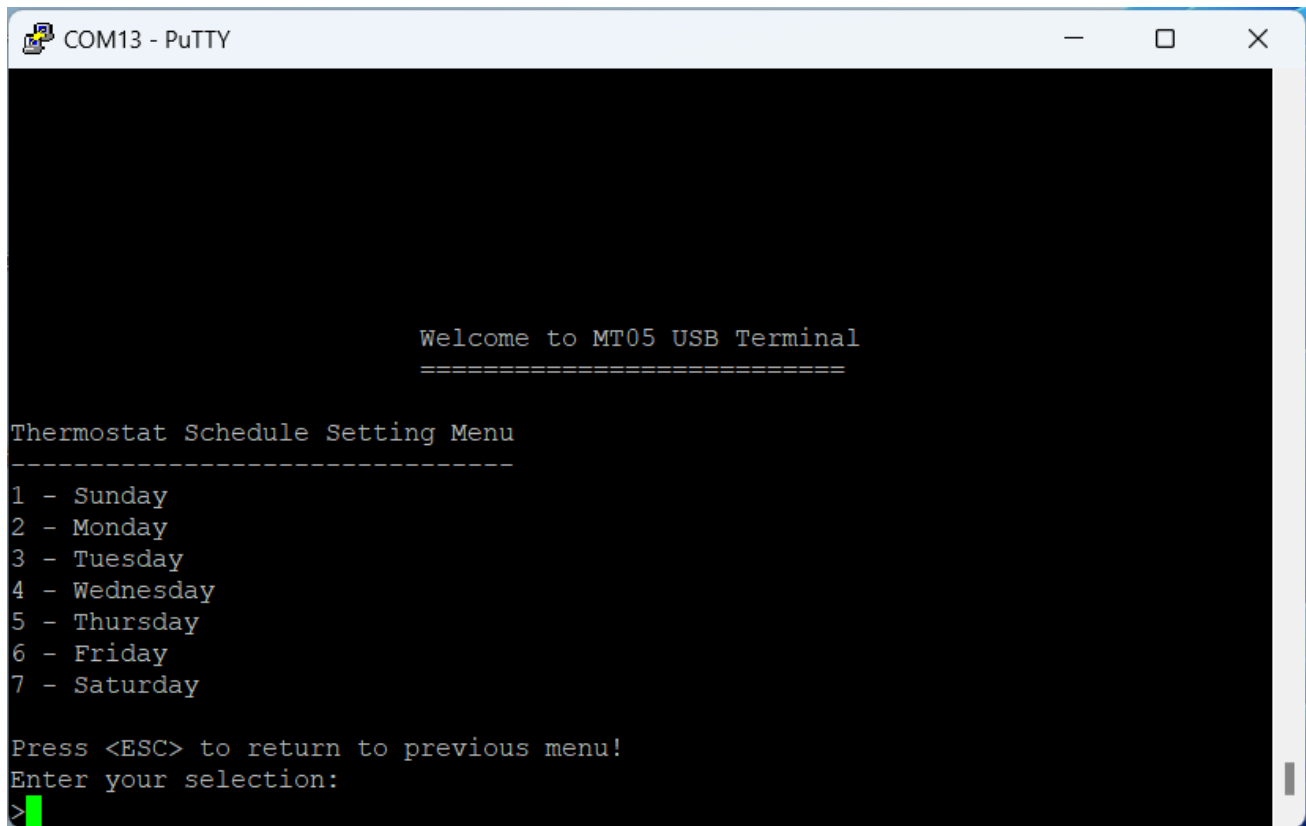
A screenshot of a PuTTY terminal window titled "COM13 - PuTTY". The terminal displays a welcome message and a menu for configuring the thermostat schedule. The menu lists seven days of the week, each with a corresponding number. The prompt "Enter your selection:" is followed by a green cursor character ">".

```
COM13 - PuTTY

Welcome to MT05 USB Terminal
=====

Thermostat Schedule Setting Menu
-----
1 - Sunday
2 - Monday
3 - Tuesday
4 - Wednesday
5 - Thursday
6 - Friday
7 - Saturday

Press <ESC> to return to previous menu!
Enter your selection:
>
```

The scheduler consist of a weekly schedule with each day four sessions. Refer to [section 9.7](#).



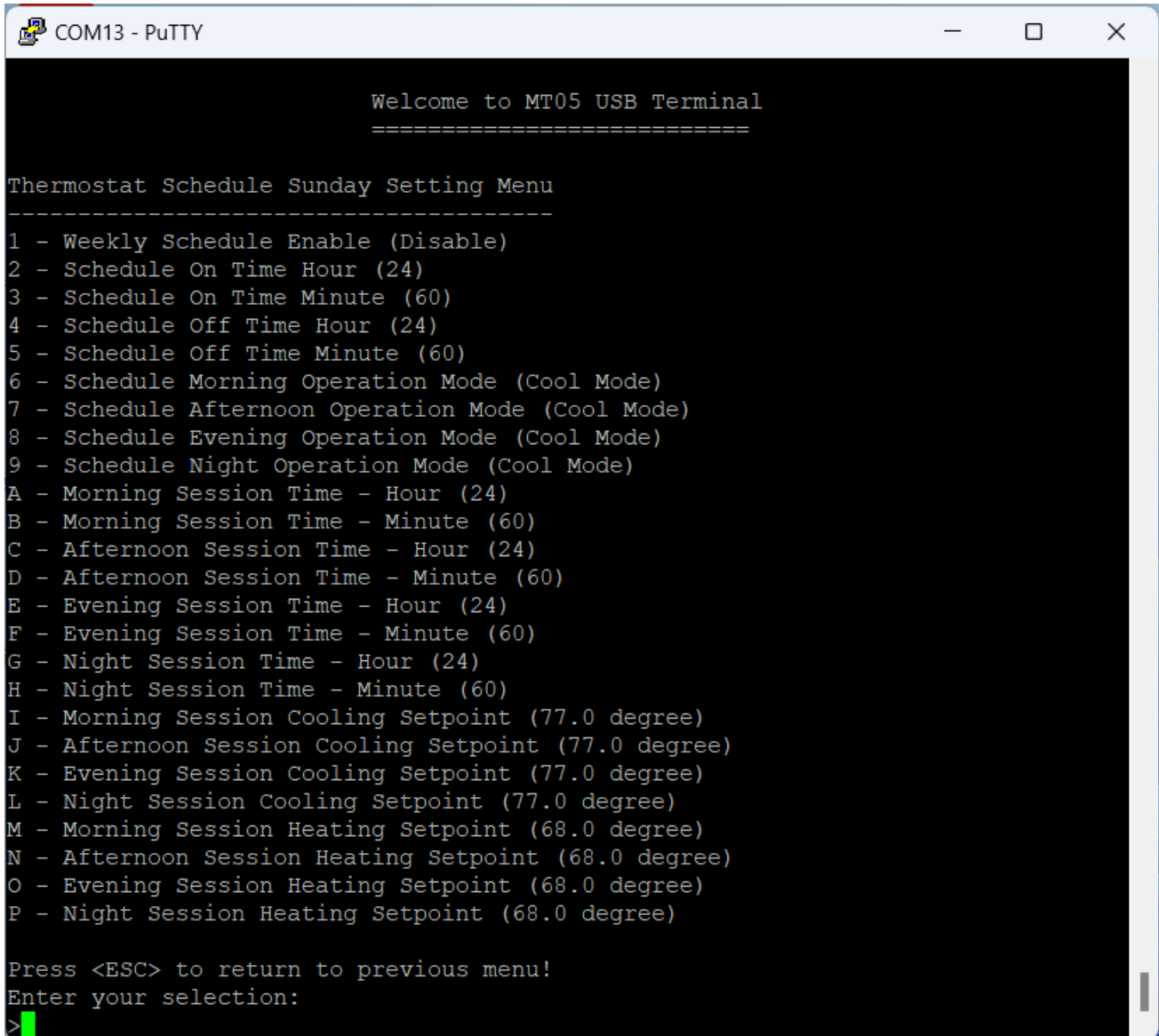

```
COM13 - PuTTY
Welcome to MT05 USB Terminal
=====

Thermostat Schedule Sunday Setting Menu
-----
1 - Weekly Schedule Enable (Disable)
2 - Schedule On Time Hour (24)
3 - Schedule On Time Minute (60)
4 - Schedule Off Time Hour (24)
5 - Schedule Off Time Minute (60)
6 - Schedule Morning Operation Mode (Cool Mode)
7 - Schedule Afternoon Operation Mode (Cool Mode)
8 - Schedule Evening Operation Mode (Cool Mode)
9 - Schedule Night Operation Mode (Cool Mode)
A - Morning Session Time - Hour (24)
B - Morning Session Time - Minute (60)
C - Afternoon Session Time - Hour (24)
D - Afternoon Session Time - Minute (60)
E - Evening Session Time - Hour (24)
F - Evening Session Time - Minute (60)
G - Night Session Time - Hour (24)
H - Night Session Time - Minute (60)
I - Morning Session Cooling Setpoint (77.0 degree)
J - Afternoon Session Cooling Setpoint (77.0 degree)
K - Evening Session Cooling Setpoint (77.0 degree)
L - Night Session Cooling Setpoint (77.0 degree)
M - Morning Session Heating Setpoint (68.0 degree)
N - Afternoon Session Heating Setpoint (68.0 degree)
O - Evening Session Heating Setpoint (68.0 degree)
P - Night Session Heating Setpoint (68.0 degree)

Press <ESC> to return to previous menu!
Enter your selection:
>
```

## 11.9 LoRaWAN Setting

All parameters for the operation of the thermostat LoRaWAN can be set/read through LoRaWAN Setting menu.

User can obtain all the information for the DevEUI, App/JoinEUI, AppKey, etc or apply your own parameters.

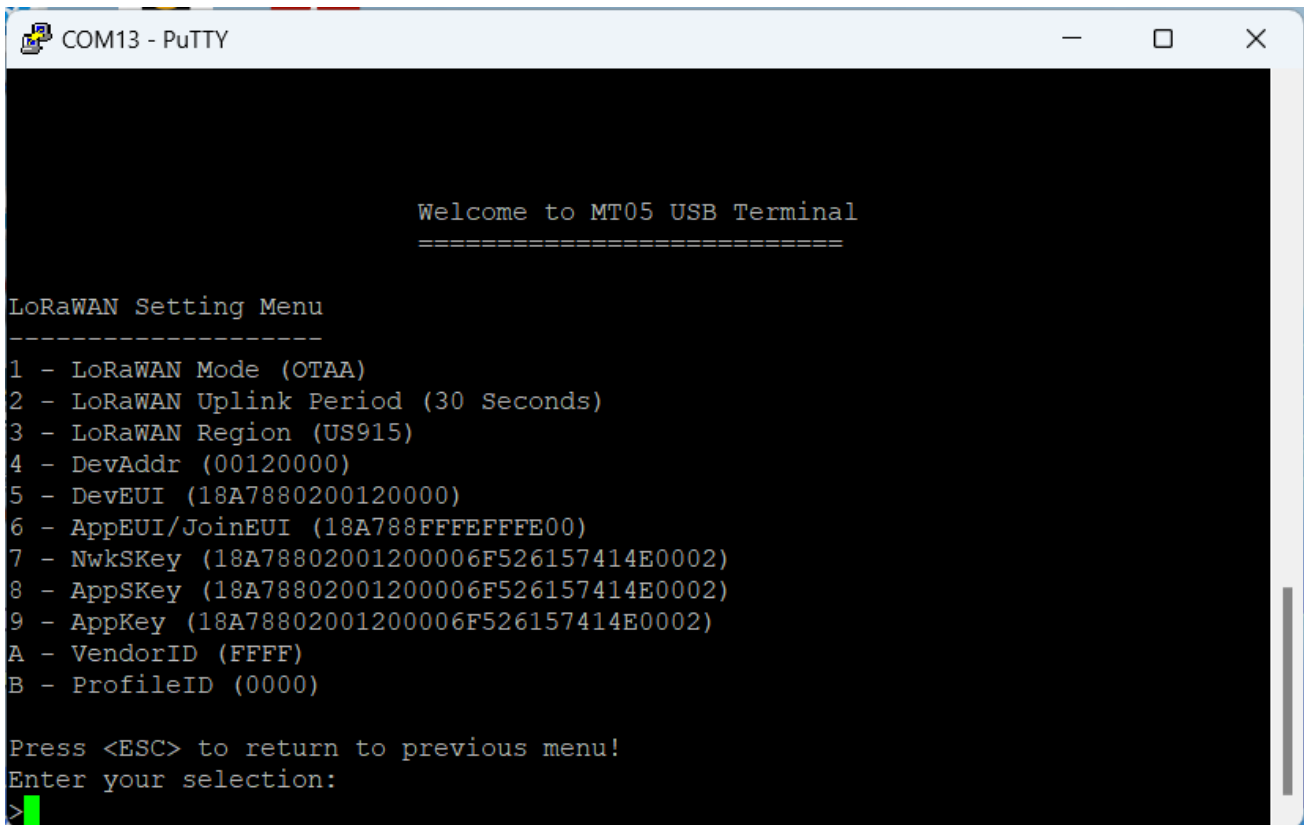

```
COM13 - PuTTY

Welcome to MT05 USB Terminal
=====

LoRaWAN Setting Menu
-----
1 - LoRaWAN Mode (OTAA)
2 - LoRaWAN Uplink Period (30 Seconds)
3 - LoRaWAN Region (US915)
4 - DevAddr (00120000)
5 - DevEUI (18A7880200120000)
6 - AppEUI/JoinEUI (18A788FFFEFFFE00)
7 - NwkSKey (18A78802001200006F526157414E0002)
8 - AppSKey (18A78802001200006F526157414E0002)
9 - AppKey (18A78802001200006F526157414E0002)
A - VendorID (FFFF)
B - ProfileID (0000)

Press <ESC> to return to previous menu!
Enter your selection:
>
```

FIGURE 31: TERMINAL - LORAWAN SETTING

## 11.10 Real Time Clock Setup

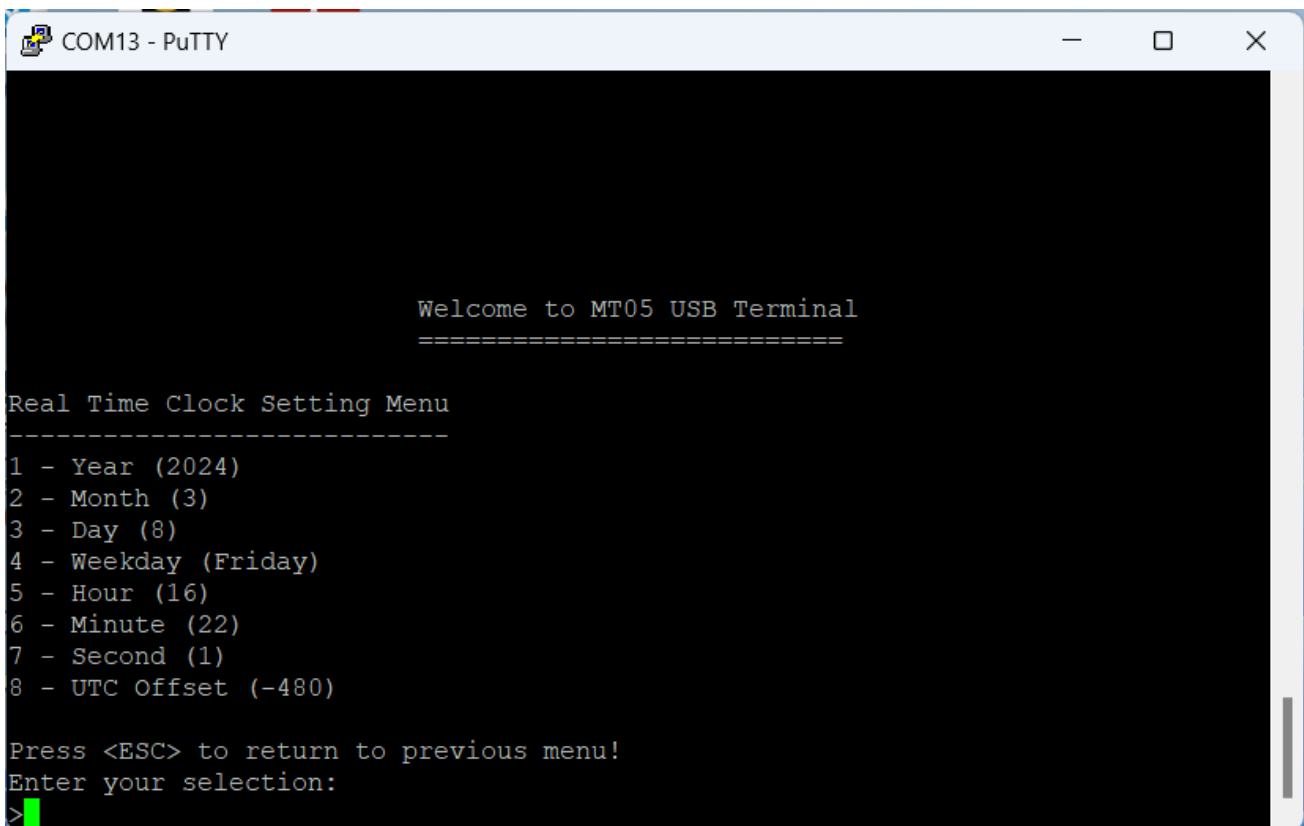

```
COM13 - PuTTY

Welcome to MT05 USB Terminal
=====

Real Time Clock Setting Menu
-----
1 - Year (2024)
2 - Month (3)
3 - Day (8)
4 - Weekday (Friday)
5 - Hour (16)
6 - Minute (22)
7 - Second (1)
8 - UTC Offset (-480)

Press <ESC> to return to previous menu!
Enter your selection:
>
```

**FIGURE 32: TERMINAL - REAL TIME CLOCK SETTING**

Set up Real time clock. The Real Time Clock stores the local time. UTC time will be obtained by substrating RTC time with UTC offset.

### 11.11 Device Information

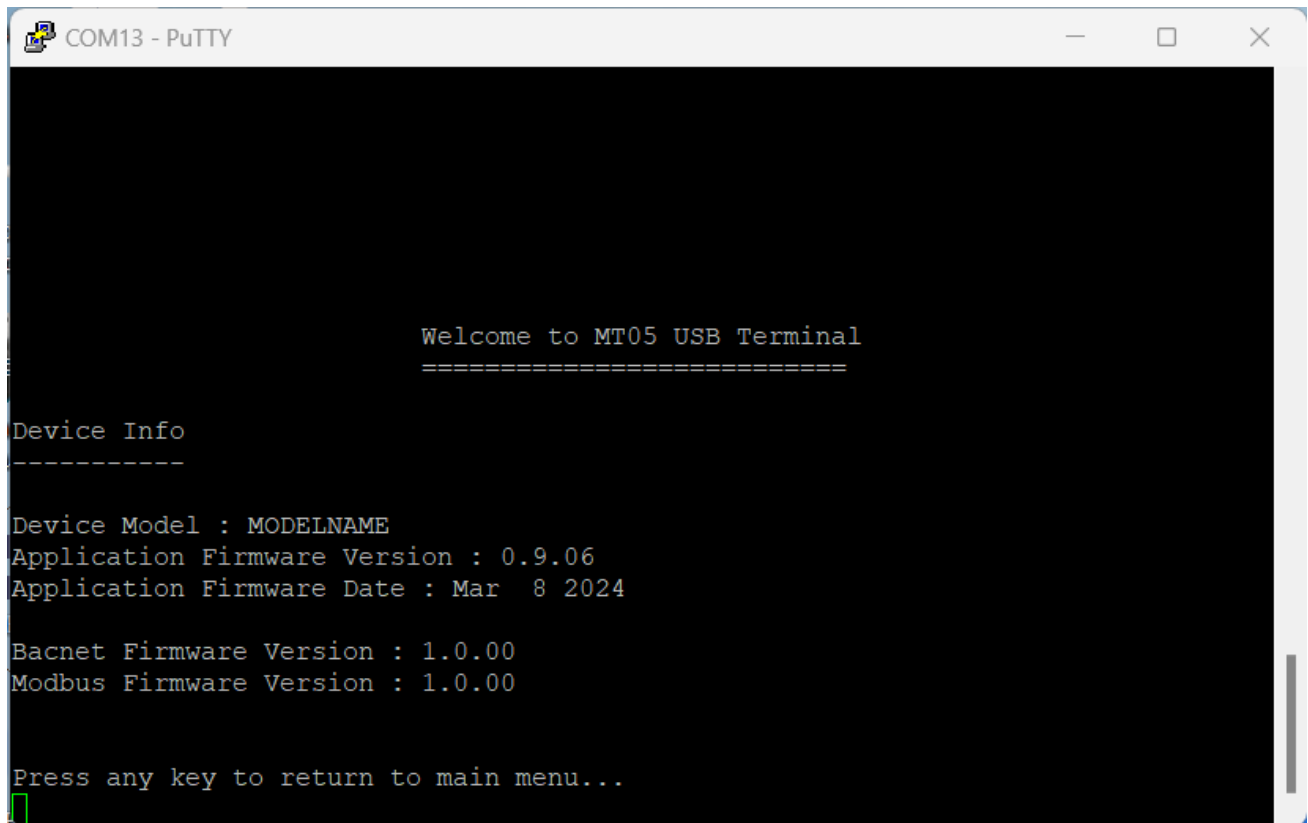
A screenshot of a terminal window titled "COM13 - PuTTY". The terminal displays the following text:

```
                Welcome to MT05 USB Terminal
                =====

Device Info
-----

Device Model : MODELNAME
Application Firmware Version : 0.9.06
Application Firmware Date : Mar  8 2024

Bacnet Firmware Version : 1.0.00
Modbus Firmware Version : 1.0.00

Press any key to return to main menu...
█
```

**FIGURE 33: TERMINAL - DEVICE INFORMATION**

Device Information contains the Device Model, Firmware Version and Date.

### 11.12 Bootloader Mode

Bootloader mode is used to update firmware.

Enter "Y" to go into bootloader mode.

MT-5 will turn into a Mass Storage Device.

The firmware can be updated just by drap and drop the firmware binary file into the MSD drive.

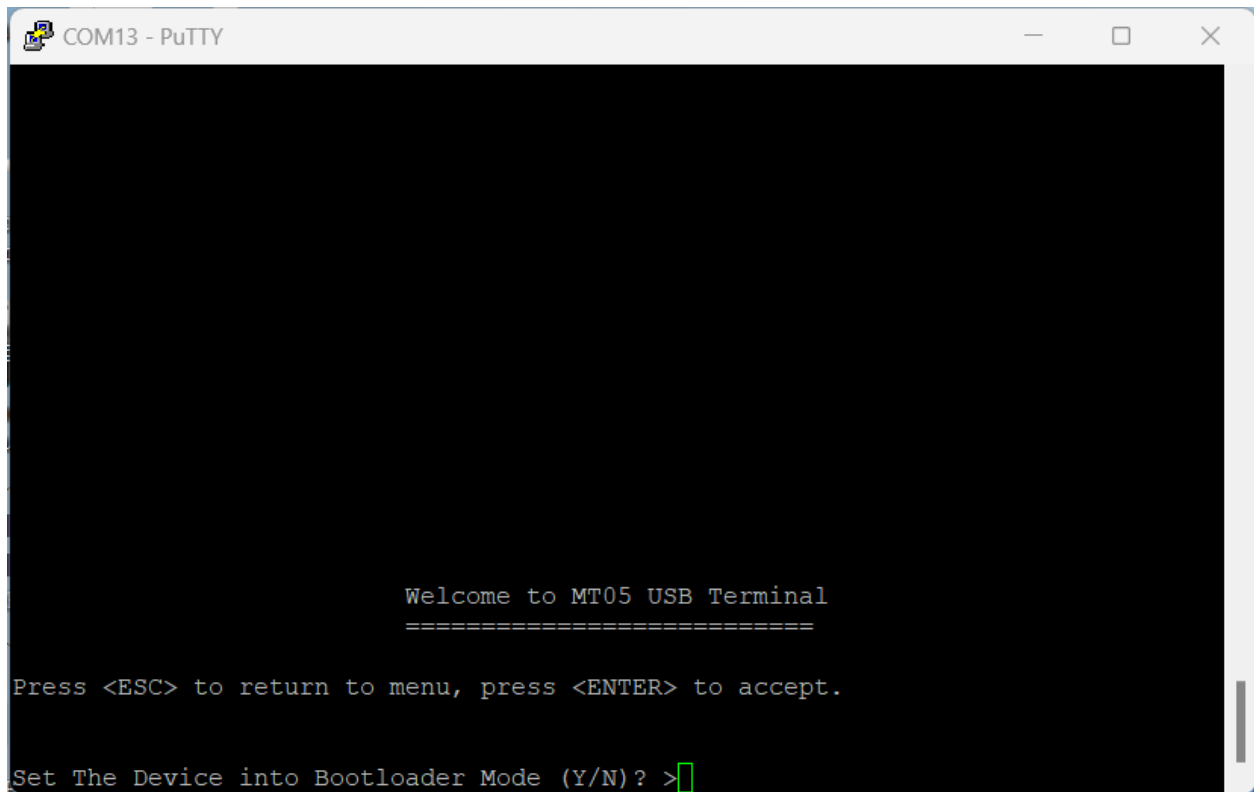

FIGURE 34: TERMINAL - BOOTLOADER

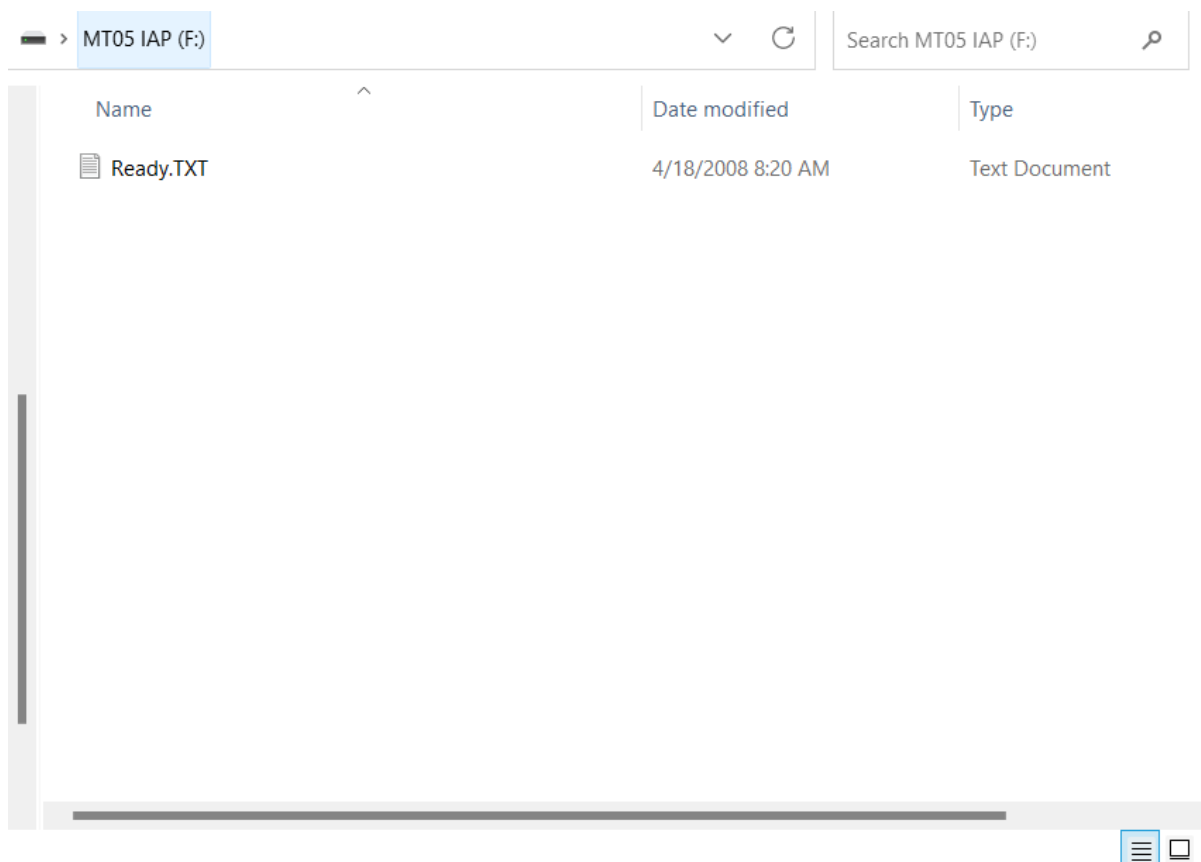
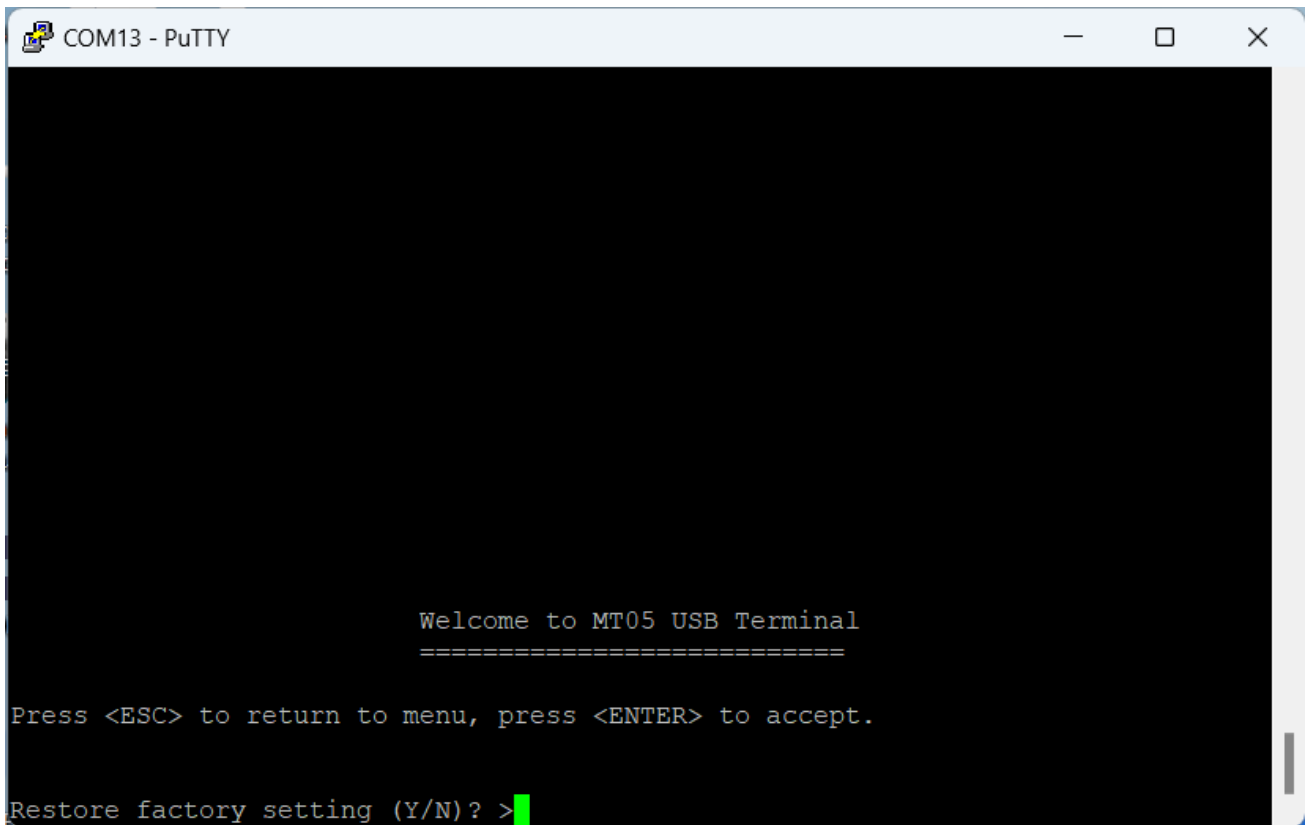

FIGURE 35: TERMINAL - MASS STORAGE DEVICE

### 11.13 Restore Factory Default Setting

A screenshot of a PuTTY terminal window titled 'COM13 - PuTTY'. The terminal displays the following text: 'Welcome to MT05 USB Terminal', followed by a line of equals signs. Below that, it says 'Press <ESC> to return to menu, press <ENTER> to accept.' At the bottom, the prompt 'Restore factory setting (Y/N)? >' is shown with a green cursor block at the end.

```
COM13 - PuTTY  
  
Welcome to MT05 USB Terminal  
=====
```

Press <ESC> to return to menu, press <ENTER> to accept.

Restore factory setting (Y/N)? >

**FIGURE 36: TERMINAL - RESTORE FACTORY DEFAULT SETTING**

This option will reset all the settings back to the factory default, including the LoRaWAN DevEUI etc.

## 11.14 Reboot

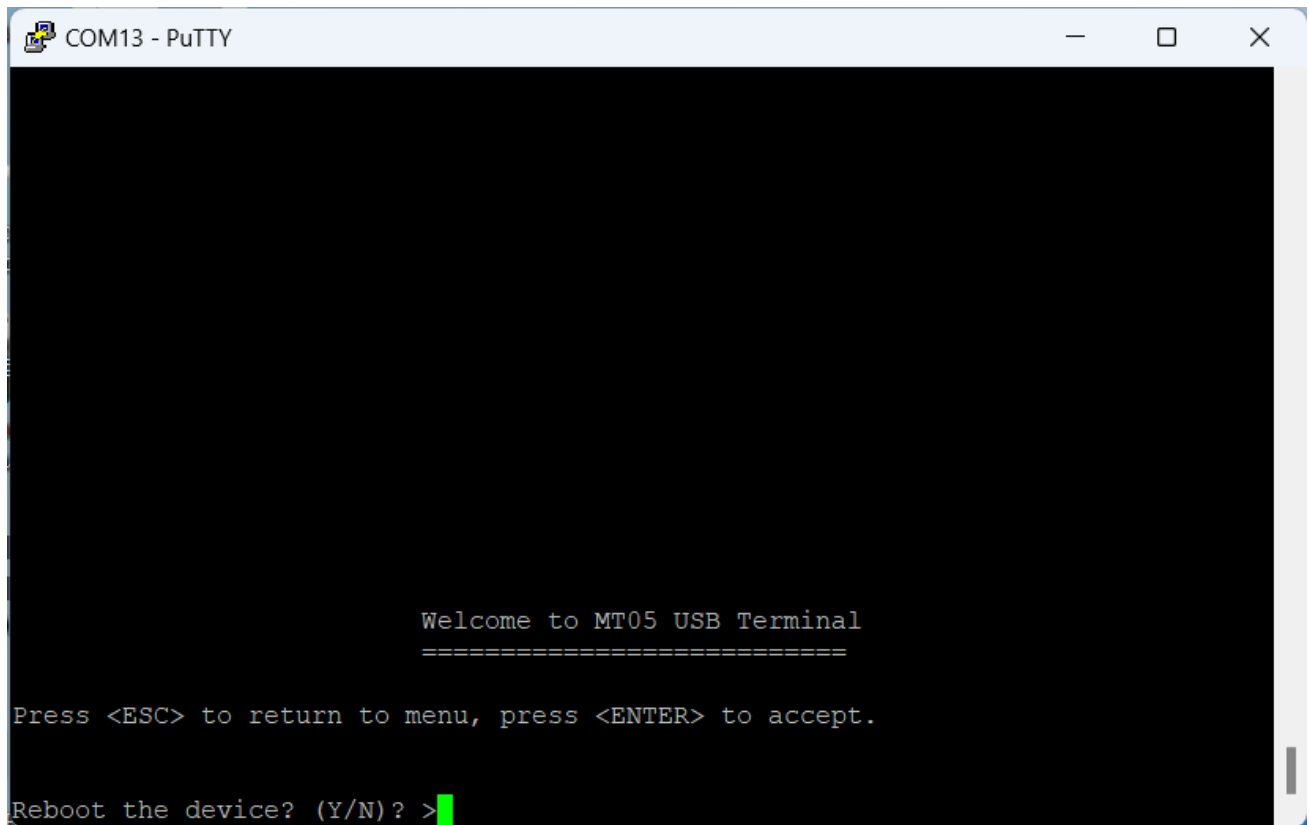

```
COM13 - PuTTY
Welcome to MT05 USB Terminal
=====
Press <ESC> to return to menu, press <ENTER> to accept.
Reboot the device? (Y/N)? >
```

FIGURE 37: TERMINAL - REBOOT

The reboot function is used when settings like Serial Port Configuration changes. The device need to be reboot for the new Serial Port Setting to take effect.

## 12. LoRaWAN(Only Model with LoRa)

### 12.1 Regional Parameters

MT-5 implements Regional Parameters RP002-1.0.3 Final.

### 12.2 Activation

There are 2 methods for the MT-5 to be applied in LoRaWAN system, which are OTAA and ABP.

All the parameters are available in the USB Terminal and can be overwrite with user preferred values.

The DevEUI, App/JoinEUI, VendorID and VendorProfileID can be scanned from the minimum required QR code as required in “LoRaWAN Device Identification QR Code” at the back of th top LCD Display panel.

The format is :

LW:D0:AppEUI/JoinEUI:DevEUI:VendorIDVendorProfileID

Example : LW:D0:18A788FFFEFFFE00:18A7880200000000:FFFF0000



**Note :** The VenderID and VenderProfileID will be provided after MT-5 has join LoRa Alliance.

User can provide his own VenderID and VenderProfileID in the USB terminal.

### 12.3 OTAA

There are three essential parameters to be used in LoRaWAN OTAA, which are 'DevEUI', 'JoinEUI' and 'JoinKey'.

### 12.4 DevEUI

Unique ID of each LoRaWAN device. This 'DevEUI' of MT-5 is provided by the manufacturer. User can use their own DevEUI.

### 12.5 JoinEUI

Unique ID of each type of LoRaWAN device. This 'JoinEUI' of MT-5 is provided by the manufacturer. User can provide their own JoinEUI.

### 12.6 AppKey/JoinKey

Unique ID of each LoRaWAN device to be used by the LoRaWAN system to decode the one-time 'NwkSKey' and 'AppSKey'. Due to 'NwkSKey' and 'AppSKey' are generated differently every time, therefore OTAA is better in term of privacy. 32-bits 'DevAddr' is also generated differently every time, so 'DevEUI' is required to identify an LoRaWAN OTAA device. This 'JoinKey' is also provided by the manufacturer. User can provide their own JoinKey.

The default JoinKey is generated using the following formula:

**DevEUI cascade with 6F:52:61:57:41:4E:00:02**

Example:

DevEUI                    18:A7:88:00:02:00:00:00

AppKey/JoinKey        18:A7:88:00:02:00:00:00:6F:52:61:57:41:4E:00:02

### 12.7 ABP

Comparing to OTAA, ABP is relatively easier to be configured. Insert the correct 'DevAddr', 'NwkSKey', 'AppSKey' into the LoRaWAN system, and the ABP device is ready to run. All the parameters are provided by the manufacturer. User can provide their own parameters.

## 12.8 Payload

It is necessary for the application to encode the application data structure into raw data before sending it down stream to a node and decode the raw data received from the node to application data structure that the application could understand.

## 12.9 FUOTA

MT-5-A supports FUOTA. It has been tested on AWS. It supports both Class C(single device) or multicast group.

Fragment size = 48 bytes, Maximum redundancy = 10%

## 12.10 Event Log

The Event Log will transmit in between the normal data transmission. For example, the default transmit time for the data payload is 30s, after the data payload has transmitted, this is time zero. At time 10s, if there is an event log, it will be transmitted, at time 20s, if there is still another event log, it will be transmitted. If the remaining time to data payload transmit is less than 10s, there will be no event log transmission. After the data payload is transmitted, the cycle repeats.

If the data payload transmit time is set to a longer period, then there will be more 10s interval for the event log to be transmit, if there is any.

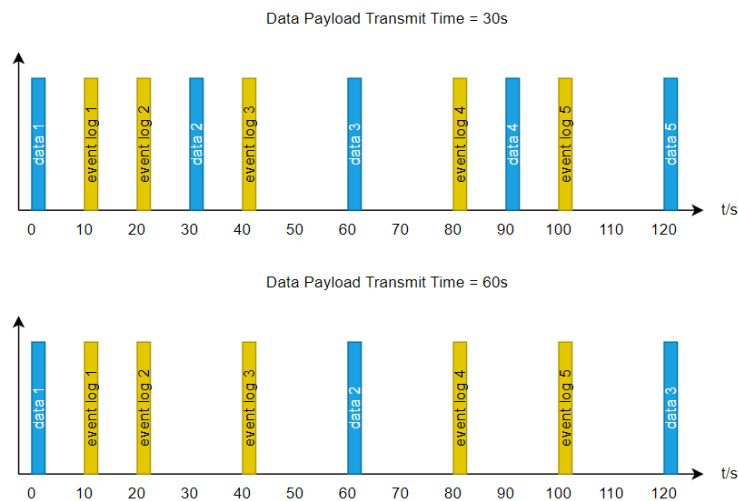

## 12.11 Command

Enum	Uplink Command Type	Downlink Command Type
1	GET_DATA*	
2	GET_SETTING0_REPLY	GET_SETTING0
3	GET_SETTING1_REPLY	GET_SETTING1
4	GET_SETTING2_REPLY	GET_SETTING2
5	GET_SETTING3_REPLY	GET_SETTING3



6	GET_SETTING4_REPLY	GET_SETTING4
7	GET_SETTING5_REPLY	GET_SETTING5
8	GET_SETTING6_REPLY	GET_SETTING6
9	GET_SETTING7_REPLY	GET_SETTING7
10	GET_SETTING8_REPLY	GET_SETTING8
11	GET_SETTING9_REPLY	GET_SETTING9
12	GET_EVENT_LOG_REPLY	GET_EVENT_LOG
13	SET_SETTING0_REPLY	SET_SETTING0
14	SET_SETTING1_REPLY	SET_SETTING1
15	SET_SETTING2_REPLY	SET_SETTING2
16	SET_SETTING3_REPLY	SET_SETTING3
17	SET_SETTING4_REPLY	SET_SETTING4
18	SET_SETTING5_REPLY	SET_SETTING5
19	SET_SETTING6_REPLY	SET_SETTING6
20	SET_SETTING7_REPLY	SET_SETTING7
21	SET_SETTING8_REPLY	SET_SETTING8
22	SET_SETTING9_REPLY	SET_SETTING9
23	SET_RTC_REPLY	SET_RTC
24	GET_FIRMWARE_VERSION_REPLY	GET_FIRMWARE_VERSION

\*Uplink periodically send GET\_DATA if no downlink command received.

\*All data sent in Little Endian byte order.

## 12.12 UpLink Payload

All uplink payloads are unconfirmed.

### 12.12.1 GET\_DATA Command

Operating Data : 11 BYTES

Byte 0 : Header (D7: Toggle when receive a downlink, D6-D1:Data type Command, D0: 0x01)

Byte 1-2: Room Temperature\*100

Byte 3-4: CO2 ppm

Byte 5-6: Humidity\*100 (% RH)

Byte 7-10: 32 bit Unix Timestamps(Little Endian, 4 byte aligned)

e.g.: 0x11223344, Byte 1 = 0x44, Byte 2 = 0x33, Byte 3 = 0x22, Byte 4 = 0x11

### 12.12.2 GET\_SETTING0\_REPLY

Operating Setting : 7 BYTES

Byte 0 : Header (D7: Toggle when receive a downlink, D6-D1:Data type Command, D0: 0x01)

Byte 1: Application

0 = RTU

1 = HPU

2 = FCU Two Pipe Cooling Only with On/Off Valve

3 = FCU Two Pipe Heating Only with On/Off Valve

4 = FCU Two Pipe Cooling Only with Floating Valve

5 = FCU Two Pipe Heating Only with Floating Valve

6 = FCU Four Pipe Cooling And Heating with On/Off Valve

Byte 2: O/B | Power On Default State | Thermistor Selection

Bit 4-7: Reserved

Bit 3: O/B configuration (0 : B mode, 1 = O mode)

Bit 1-2: Power on default state

0 = Default off

1 = Restore previous state

2 = Default on

Bit 0: Thermistor sensor selection, 0 = internal, 1 = external on UI1.

Byte 3-4: Temperature Compensation\*100, -9.9 to 9.9.

Byte 5-6: Temperature Offset\*100, -9.9 to 9.9.

Byte 7-8: Auto Uplink Period, Minimum 30s, 30s~ 65535s.

Byte 9-10: Event Log Count, Event Log that is not read or auto sent yet.

### 12.12.3 GET\_SETTING1\_REPLY

Operating Setting : 8 BYTES

Byte 0 : Header (D7: Toggle when receive a downlink, D6-D1:Data type Command, D0: 0x01)

Byte 1:            Operation Mode

0 = Cool Mode, 1 = Fan Mode, 2 = Heat Mode, 3 = Auto Mode, 4 = Dry Mode.

Byte 2:            Temperature Unit | Key Lock | Clock Mode | On/Off

Bit 6-7:           Reserved

Bit 5:              Temperature Unit, 0 = Fahrenheit, 1 = Celsius.

Bit 2-4:           Key Lock

0 = Unlocked

1 = Lock On/Off button

2 = Lock Mode button

3 = Lock Timer button

4 = Lock Fan button

5 = Lock Up/Down button

6 = Lock Light button

7 = Unlock All button

Bit 1:              Clock Mode(0 = 12 hour format, 1 = 24 hour format)

Bit 0:              On/Off (0 = OFF, 1 = ON)

Byte 3-4:          Cooling Set Point\*100, Set Point Min to Set Point Max.

Byte 5-6:          Heating Set Point\*100, Set Point Min to Set Point Max.

**Byte 7:            Operating State**

**0 = Normal, 1 = Scheduler, 2 = User Override.**

#### 12.12.4 GET\_SETTING2\_REPLY

operating setting Cont.. : 11 BYTES

Byte 0 :           Header (D7: Toggle when receive a downlink, D6-D1:Data type Command, D0: 0x01)

Byte 1-2:          Y(1) Offset\*100, -9.9 to 9.9.

Byte 3-4:          Y(2) Offset\*100, -9.9 to 9.9.

Byte 5-6:          Y(3) Offset\*100, -9.9 to 9.9.

Byte 7-8: Set Point Max\*100, 16.0 to 86.0.

Byte 9-10: Set Point Min\*100, 16.0 to 86.0.

### 12.12.5 GET\_SETTING3\_REPLY

operating setting Cont.. : 9 BYTES

Byte 0 : Header (D7: Toggle when receive a downlink, D6-D1:Data type Command, D0: 0x01)

Byte 1-2: W(1) Offset\*100, -9.9 to 9.9.

Byte 3-4: W(2) Offset\*100, -9.9 to 9.9.

Byte 5-6: W(3) Offset\*100, -9.9 to 9.9.

Byte 7-8: W(4) Offset\*100, -9.9 to 9.9.

### 12.12.6 GET\_SETTING4\_REPLY

operating setting Cont.. : 11 BYTES

Byte 0 : Header (D7: Toggle when receive a downlink, D6-D1:Data type Command, D0: 0x01)

Byte 1-2: Compressor Minimum Off Time, sec, 0 to 65535, 0 = disable.

Byte 3-4: Compressor Minimum On Time, sec, 0 to 65535, 0 = disable.

Byte 5-6: Four Way Valve Switch Delay from Compressor Off, sec, 0 to 65535, 0 = disable.

Byte 7-8: Boost Mode Minimum Time, sec, 0 to 65535, 0 = disable.

Byte 9-10: Floating Valve Traveling Time, sec, 0 to 65535.

### 12.12.7 GET\_SETTING5\_REPLY

Operating setting : 11 BYTES

Byte 0 : Header (D7: Toggle when receive a downlink, D6-D1:Data type Command, D0: 0x01)

Byte 1: Weekday(0-6, Sunday to Saturday)

Byte 2: 0 = Disable, 1 = Enable

Byte 3: Scheduled On Timer Hour, 0 to 23, 24 = disable.

Byte 4: Scheduled On Timer Minute, 0 to 59, 60 = disable.

Byte 5: Scheduled Off Timer Hour, 0 to 23, 24 = disable.

- Byte 6: Scheduled Off Timer Minute, 0 to 59, 60 = disable.
- Byte 7: Scheduler Morning Operation Mode.  
0 = Cool Mode, 1 = Fan Mode, 2 = Heat Mode, 3 = Auto Mode, 4 = Dry Mode.
- Byte 8: Scheduler Afternoon Operation Mode.  
0 = Cool Mode, 1 = Fan Mode, 2 = Heat Mode, 3 = Auto Mode, 4 = Dry Mode.
- Byte 9: Scheduler Evening Operation Mode.  
0 = Cool Mode, 1 = Fan Mode, 2 = Heat Mode, 3 = Auto Mode, 4 = Dry Mode.
- Byte 10: Scheduler Night Operation Mode.  
0 = Cool Mode, 1 = Fan Mode, 2 = Heat Mode, 3 = Auto Mode, 4 = Dry Mode.

### 12.12.8 GET\_SETTING6\_REPLY

Operating setting : 11 BYTES

- Byte 0 : Header (D7: Toggle when receive a downlink, D6-D1:Data type Command, D0: 0x01)
- Byte 1: Weekday(0-6, Sunday to Saturday)
- Byte 2: 0 = Disable, 1 = Enable
- Byte 3: Morning Session Temperature Timer Hour, 0 to 23, 24 = disable..
- Byte 4: Morning Session Temperature Timer Minute, 0 to 59, 60 = disable,
- Byte 5: Afternoon Session Temperature Timer Hour, 0 to 23, 24 = disable..
- Byte 6: Afternoon Session Temperature Timer Minute, 0 to 59, 60 = disable,
- Byte 7: Evening Session Temperature Timer Hour, 0 to 23, 24 = disable..
- Byte 8: Evening Session Temperature Timer Minute, 0 to 59, 60 = disable,
- Byte 9: Night Session Temperature Timer Hour, 0 to 23, 24 = disable..
- Byte 10: Night Session Temperature Timer Minute, 0 to 59, 60 = disable,

### 12.12.9 GET\_SETTING7\_REPLY

Operating setting : 11 BYTES

- Byte 0 : Header (D7: Toggle when receive a downlink, D6-D1:Data type Command, D0: 0x01)
- Byte 1: Weekday(0-6, Sunday to Saturday)

- Byte 2: 0 = Disable, 1 = Enable
- Byte 3-4: Morning Session Cooling Set Point \* 100, 16.0 to 86.0.
- Byte 5-6: Afternoon Session Cooling Set Point \* 100, 16.0 to 86.0.
- Byte 7-8: Evening Session Cooling Set Point \* 100, 16.0 to 86.0.
- Byte 9-10: Night Session Cooling Set Point \* 100, 16.0 to 86.0.

#### 12.12.10 GET\_SETTING8\_REPLY

Operating setting : 11 BYTES

- Byte 0 : Header (D7: Toggle when receive a downlink, D6-D1:Data type Command, D0: 0x01)
- Byte 1: Weekday(0-6, Sunday to Saturday)
- Byte 2: 0 = Disable, 1 = Enable
- Byte 3-4: Morning Session Heating Set Point \* 100, 16.0 to 86.0.
- Byte 5-6: Afternoon Session Heating Set Point \* 100, 16.0 to 86.0.
- Byte 7-8: Evening Session Heating Set Point \* 100, 16.0 to 86.0.
- Byte 9-10: Night Session Heating Set Point \* 100, 16.0 to 86.0.

#### 12.12.11 GET\_SETTING9\_REPLY

Operating setting : 6 BYTES

- Byte 0 : Header (D7: Toggle when receive a downlink, D6-D1:Data type Command, D0: 0x01)
- Byte 1: Operation State  
0 = Normal, 1 = Scheduler, 2 = User Override
- Byte 2: User selected overridden operation mode
- Byte 3-4: User selected overridden Set Point \* 100, 16.0 to 86.0.
- Byte 5: User selected override time in minutes

#### 12.12.12 GET\_EVENT\_LOG\_REPLY

Reply after received Downlink GET\_EVENT\_LOG command : 10 BYTES

- Byte 0 : Header (D7: Toggle when receive a downlink, D6-D1:Data type Command, D0: 0x01)
- Byte 1-4: 32 bit Unix Timestamps(Little Endian, 4 byte aligned)

e.g.: 0x11223344, Byte 1 = 0x44, Byte 2 = 0x33, Byte 3 = 0x22, Byte 4 = 0x11

Byte 5: Event Log Type

0 = Relay state change event

1 = USB Login event

Byte 6: Log Data

Depends on Byte 5, Event Log Type

Log Type = 0, Log Data = Relay state changed.

Log Type = 1, Log Data = 0, User Login Failed, Log Data = 1, User Login Success.

### 12.12.13 SET\_SETTING0\_REPLY

Reply after received Downlink configuration command : 1 BYTES

Byte 0 : Header (D7: Toggle when receive a downlink, D6-D1:Data type Command, D0: 0x01)

### 12.12.14 SET\_SETTING1\_REPLY

Reply after received Downlink configuration command : 1 BYTES

Byte 0 : Header (D7: Toggle when receive a downlink, D6-D1:Data type Command, D0: 0x01)

### 12.12.15 SET\_SETTING2\_REPLY

Reply after received Downlink configuration command : 1 BYTES

Byte 0 : Header (D7: Toggle when receive a downlink, D6-D1:Data type Command, D0: 0x01)

### 12.12.16 SET\_SETTING3\_REPLY

Reply after received Downlink configuration command : 1 BYTES

Byte 0 : Header (D7: Toggle when receive a downlink, D6-D1:Data type Command, D0: 0x01)

### 12.12.17 SET\_SETTING4\_REPLY

Reply after received Downlink configuration command : 1 BYTES

Byte 0 : Header (D7: Toggle when receive a downlink, D6-D1:Data type Command, D0: 0x01)

### 12.12.18 SET\_SETTING5\_REPLY

Reply after received Downlink configuration command : 1 BYTES

Byte 0 : Header (D7: Toggle when receive a downlink, D6-D1:Data type Command, D0: 0x01)

### 12.12.19 SET\_SETTING6\_REPLY

Reply after received Downlink configuration command : 1 BYTES

Byte 0 : Header (D7: Toggle when receive a downlink, D6-D1:Data type Command, D0: 0x01)

### 12.12.20 SET\_SETTING7\_REPLY

Reply after received Downlink configuration command : 1 BYTES

Byte 0 : Header (D7: Toggle when receive a downlink, D6-D1:Data type Command, D0: 0x01)

### 12.12.21 SET\_SETTING8\_REPLY

Reply after received Downlink configuration command : 1 BYTES

Byte 0 : Header (D7: Toggle when receive a downlink, D6-D1:Data type Command, D0: 0x01)

### 12.12.22 SET\_SETTING9\_REPLY

Reply after received Downlink configuration command : 1 BYTES

Byte 0 : Header (D7: Toggle when receive a downlink, D6-D1:Data type Command, D0: 0x01)

### 12.12.23 SET\_RTC\_REPLY

Reply after received Downlink SET\_RTC command : 1 BYTE

Byte 0: Header (D7: Toggle when receive a downlink, D6-D1:Data type Command, D0: 0x01)

### 12.12.24 GET\_FIRMWARE\_VERSION\_REPLY

Reply after received Downlink GET\_FIRMWARE\_VERSION command : 5 BYTE

Byte 0: Header (D7: Toggle when receive a downlink, D6-D1:Data type Command, D0: 0x01)

Byte 3-0: Firmware version in decimal.

Version = received decimal / 100;

905 = Version 9.05

## 12.13 Downlink Payload

All downlink payloads are confirmed.

### 12.13.1 GET\_SETTING0

Operating Setting : 1 BYTES

Byte 0: Data type Command



### 12.13.2 GET\_SETTING1

Operating Setting : 1 BYTES

Byte 0: Data type Command

### 12.13.3 GET\_SETTING2

Operating Setting : 1 BYTES

Byte 0: Data type Command

### 12.13.4 GET\_SETTING3

Operating Setting : 1 BYTES

Byte 0: Data type Command

### 12.13.5 GET\_SETTING4

Operating Setting : 1 BYTES

Byte 0: Data type Command

### 12.13.6 GET\_SETTING5

Operating Setting : 1 BYTES

Byte 0: Data type Command

Byte 1: Weekday(0-6, Sunday to Saturday)

### 12.13.7 GET\_SETTING6

Operating Setting : 1 BYTES

Byte 0: Data type Command

Byte 1: Weekday(0-6, Sunday to Saturday)

### 12.13.8 GET\_SETTING7

Operating Setting : 1 BYTES

Byte 0: Data type Command

Byte 1: Weekday(0-6, Sunday to Saturday)

### 12.13.9 GET\_SETTING8

Operating Setting : 1 BYTES

Byte 0: Data type Command

Byte 1: Weekday(0-6, Sunday to Saturday)

### 12.13.10 GET\_SETTING9

Operating Setting : 1 BYTES

Byte 0: Data type Command

### 12.13.11 GET\_EVENT\_LOG

Operating Setting : 1 BYTES

Byte 0: Data type Command

### 12.13.12 SET\_SETTING0

Operating Setting : 7 BYTES

Byte 1: Application

0 = RTU

1 = HPU

2 = FCU Two Pipe Cooling Only with On/Off Valve

3 = FCU Two Pipe Heating Only with On/Off Valve

4 = FCU Two Pipe Cooling Only with Floating Valve

5 = FCU Two Pipe Heating Only with Floating Valve

6 = FCU Four Pipe Cooling And Heating with On/Off Valve

Byte 2: O/B | Power On Default State | Thermistor Selection

Bit 4-7: Reserved

Bit 3: O/B configuration (0 : B mode, 1 = O mode)

Bit 1-2: Power on default state

0 = Default off

1 = Restore previous state

2 = Default on

Bit 0: Thermistor sensor selection, 0 = internal, 1 = external on UI1.

Byte 3-4: Temperature Compensation\*100, -9.9 to 9.9.

Byte 5-6: Temperature Offset\*100 , -9.9 to 9.9.

### 12.13.13 SET\_SETTING1

Operating Setting : 7 BYTES

Byte 0: Data type Command

Byte 1: Operation Mode

0 = Cool Mode, 1 = Fan Mode, 2 = Heat Mode, 3 = Auto Mode, 4 = Dry Mode.

Byte 2: Temperature Unit | Key Lock | Clock Mode | On/Off

Bit 6-7: Reserved

Bit 5: Temperature Unit, 0 = Fahrenheit, 1 = Celsius.

Bit 2-4: Key Lock

0 = Unlocked

1 = Lock On/Off button

2 = Lock Mode button

3 = Lock Timer button

4 = Lock Fan button

5 = Lock Up/Down button

6 = Lock Light button

7 = Unlock All button

Bit 1: Clock Mode(0 = 12 hour format, 1 = 24 hour format)

Bit 0: On/Off (0 = OFF, 1 = ON)

Byte 3-4: Cooling Set Point\*100, Set Point Min to Set Point Max.

Byte 5-6: Heating Set Point\*100, Set Point Min to Set Point Max.

### 12.13.14 SET\_SETTING2

Operating Setting: 11 BYTES

Byte 0: Data type Command

Byte 1-2: Y(1) Offset\*100, -9.9 to 9.9.

- Byte 3-4: Y(2) Offset\*100, -9.9 to 9.9.
- Byte 6-5: Y(3) Offset\*100, -9.9 to 9.9.
- Byte 7-8: Setpoint Max\*100, -16.0 to 86.0.
- Byte 9-10: Setpoint Min\*100, -16.0 to 86.0.

### 12.13.15 SET\_SETTING3

Operating Setting : 9 BYTES

- Byte 0: Data type Command
- Byte 1-2: W(1) Offset\*100, -9.9 to 9.9.
- Byte 3-4: W(2) Offset\*100, -9.9 to 9.9.
- Byte 5-6: W(3) Offset\*100, -9.9 to 9.9.
- Byte 7-8: W(4) Offset\*100, -9.9 to 9.9.

### 12.13.16 SET\_SETTING4

Operating Setting : 11 BYTES

- Byte 0: Data type Command
- Byte 1-2: Compressor Minimum Off Time, sec, 0 to 65,535.
- Byte 3-4: Compressor Minimum On Time, sec, 0 to 65,535.
- Byte 5-6: Four Way Valve Switch Delay from Compressor Off, sec, 0 to 65,535.
- Byte 7-8: Boost Mode Minimum Time, sec, 0 to 65,535.
- Byte 9-10: Floating Valve Traveling Time, sec, 0 to 65535.

### 12.13.17 SET\_SETTING5

Operating Setting : 11 BYTES

- Byte 0: Data type Command
- Byte 1: Weekday(0-6, Sunday to Saturday)
- Byte 2: 0 = Disable, 1 = Enable
- Byte 3: Scheduled On Timer Hour, 0 to 23, 24 = disable..
- Byte 4: Scheduled On Timer Minute, 0 to 59, 60 = disable,

- Byte 5: Scheduled Off Timer Hour , 0 to 23, 24 = disable..
- Byte 6: Scheduled Off Timer Minute, 0 to 59, 60 = disable,
- Byte 7: Scheduler Morning Operation Mode.  
0 = Cool Mode, 1 = Fan Mode, 2 = Heat Mode, 3 = Auto Mode, 4 = Dry Mode.
- Byte 8: Scheduler Afternoon Operation Mode.  
0 = Cool Mode, 1 = Fan Mode, 2 = Heat Mode, 3 = Auto Mode, 4 = Dry Mode.
- Byte 9: Scheduler Evening Operation Mode.  
0 = Cool Mode, 1 = Fan Mode, 2 = Heat Mode, 3 = Auto Mode, 4 = Dry Mode.
- Byte 10: Scheduler Night Operation Mode.  
0 = Cool Mode, 1 = Fan Mode, 2 = Heat Mode, 3 = Auto Mode, 4 = Dry Mode.

### 12.13.18 SET\_SETTING6

Operating Setting : 11 BYTES

- Byte 0: Data type Command
- Byte 1: Weekday(0-6, Sunday to Saturday)
- Byte 2: 0 = Disable, 1 = Enable
- Byte3: Morning Session Temperature Set Point Timer Hour, 0 to 23, 24 = disable..
- Byte 4: Morning Session Temperature Set Point Timer Minute, 0 to 59, 60 = disable,
- Byte 5: Afternoon Session Temperature Set Point Timer Hour, 0 to 23, 24 = disable..
- Byte 6: Afternoon Session Temperature Set Point Timer Minute, 0 to 59, 60 = disable,
- Byte 7: Evening Session Temperature Set Point Timer Hour, 0 to 23, 24 = disable..
- Byte 8: Evening Session Temperature Set Point Timer Minute, 0 to 59, 60 = disable,
- Byte 9: Night Session Temperature Set Point Timer Hour, 0 to 23, 24 = disable..
- Byte10: Night Session Temperature Set Point Timer Minute, 0 to 59, 60 = disable,

### 12.13.19 SET\_SETTING7

Operating Setting : 11 BYTES

- Byte 0: Data type Command

- Byte 1: Weekday(0-6, Sunday to Saturday)
- Byte 2: 0 = Disable, 1 = Enable
- Byte 3-4: Morning Session Cooling Set Point \* 100, 16.0 to 86.0..
- Byte 5-6: Afternoon Session Cooling Set Point \* 100, 16.0 to 86.0..
- Byte 7-8: Evening Session Cooling Set Point \* 100, 16.0 to 86.0..
- Byte 9-10: Night Session Cooling Set Point \* 100, 16.0 to 86.0..

### 12.13.20 SET\_SETTING8

Operating setting : 11 BYTES

- Byte 0: Data type Command
- Byte 1: Weekday(0-6, Sunday to Saturday)
- Byte 2: 0 = Disable, 1 = Enable
- Byte 3-4: Morning Session Heating Set Point \* 100, 16.0 to 86.0.
- Byte 5-6: Afternoon Session Heating Set Point \* 100, 16.0 to 86.0.
- Byte 7-8: Evening Session Heating Set Point \* 100, 16.0 to 86.0.
- Byte 9-10: Night Session Heating Set Point \* 100, 16.0 to 86.0.

### 12.13.21 SET\_SETTING9

Operating setting : 11 BYTES

- Byte 0: Data type Command
- Byte 1: Operation State  
0, 1 = Not used, 2 = User Override Enable, 3 = User Override Cancel  
User Override Enable will be ignored if MT-5 currently not in Scheduler state.
- Byte 2: Operation Mode  
User selected override operation mode
- Byte 3-4: User selected override Set Point \* 100, 16.0 to 86.0.
- Byte 5: User selected override time in minutes.  
1 to 255 minutes.

### 12.13.22 SET\_RTC

Operating Setting : 10 BYTES

- Byte 0: Data type Command
- Byte 1-2: RTC Year, (0 to 65,535).
- Byte 3: Month(1-12)
- Byte 4: Day(1-31)
- Byte 5: Hour(0-23)
- Byte 6: Minute(0-59)
- Byte 7: Second(0-59)
- Byte 8: Weekday(0-6, Sunday to Saturday)
- Byte 9-10: Offset in minutes.

This offset is needed to convert the local time stored in RTC to UTC timestamp.

Please refer to [Section 10](#) for detail.

### 12.14 Data Type Structure And Byte Order Decoding

All the data values such as AI, AO and remote point values are encoded in little endian byte order 4 byte memory slots and send in less significant byte first.

For example, AI temperature is represented using IEEE-754 single precision floating point format and has an hexadecimal value of 0x41CDEB85. 0x41 is the most significant byte and 0x85 is the less significant byte.

This hexadecimal value is stored in memory in little endian byte order as 0x85 0xEB 0xCD 0x41 in increasing memory address order and is sent less significant byte first.

Byte x : 0x85

Byte x+1 : 0xEB

Byte x+2 : 0xCD

Byte x+3 : 0x41

### 13. BACnet Object Table

Object Name	Type & Instance	Readable/Writable	Description	Range and Definition
On Off Status	BV 1	R	Current On Off Status	0 = Off, 1 = On
W2 O/B W Status	BV2	R	DO Status	0 = Off, 1 = On
W1 Y Status	BV3	R	DO Status	0 = Off, 1 = On
Y2 GH Status	BV4	R	DO Status	0 = Off, 1 = On
Y1 GM Status	BV5	R	DO Status	0 = Off, 1 = On
G GL Status	BV6	R	DO Status	0 = Off, 1 = On
Set On Off	BV7	R/W	Set On Off Status	0 = Off, 1 = On
Clock Mode	BV8	R/W	12 Hour or 24 hour format	0 = 12 hour , 1 = 24 hour
Temperature Unit	BV9	R/W	Fahrenheit or Celsius	0 = Fahrenheit, 1 = Celsius
Thermistor Selection	BV10	R/W	Internal or External	0 = Internal, 1 = External
O/B Configuration	BV11	R/W	O/B Configuration	0 = B Mode, 1 = O Mode
Weekly Schedule Enable Sunday	BV12	R/W	Enable/Disable	0 = Disable, 1 = Enable
Weekly Schedule Enable Mondayday	BV13	R/W	Enable/Disable	0 = Disable, 1 = Enable
Weekly Schedule Enable Tuesday	BV14	R/W	Enable/Disable	0 = Disable, 1 = Enable
Weekly Schedule Enable Wednesday	BV15	R/W	Enable/Disable	0 = Disable, 1 = Enable
Weekly Schedule Enable Thursday	BV16	R/W	Enable/Disable	0 = Disable, 1 = Enable
Weekly Schedule Enable Friday	BV17	R/W	Enable/Disable	0 = Disable, 1 = Enable
Weekly Schedule Enable Saturday	BV18	R/W	Enable/Disable	0 = Disable, 1 = Enable
Room Temperature	AV1	R	Room Temperature	0.0 ~ 999
Humidity	AV2	R	Relative Humidity	0% ~ 100 %
Cooling Set Point	AV3	R/W	Cooling Set Point	Set Point Min to Set Point Max (Configured in Terminal)
Heating Set Point	AV4	R/W	Heating Set Point	Set Point Min to Set Point Max (Configured in Terminal)
Set Point Minimum	AV5	R/W	Set Point Minimum	16 ~ 86
Set Point Maximum	AV6	R/W	Set Point Maximum	16 ~ 86



Temperature Compensation	AV7	R/W	Temperature Compensation	-9.9 ~ 9.9
Temperature Offset	AV8	R/W	Temperature Offset	-9.9 ~ 9.9
Y1 Offset	AV9	R/W	Y1 Offset	-9.9 ~ 9.9
Y2 Offset	AV10	R/W	Y2 Offset	-9.9 ~ 9.9
Y3 Offset	AV11	R/W	Y3 Offset	-9.9 ~ 9.9
W1 Offset	AV12	R/W	W1 Offset	-9.9 ~ 9.9
W2 Offset	AV13	R/W	W2 Offset	-9.9 ~ 9.9
W3 Offset	AV14	R/W	W3 Offset	-9.9 ~ 9.9
W4 Offset	AV15	R/W	W4 Offset	-9.9 ~ 9.9
Compressor Minimum On Time	AV16	R/W	Compressor Minimum On Time	0 ~ 65,535
Compressor Minimum Off Time	AV17	R/W	Compressor Minimum Off Time	0 ~ 65,535
Four Way Valve Switch Delay	AV18	R/W	Four Way Valve Switch Delay	0 ~ 65,535
Boost Mode Minimum Time	AV19	R/W	Boost Mode Minimum Time	0 ~ 65,535
Floating Valve Traveling Time	AV20	R/W	Floating Valve Traveling Time	0 ~ 65,535
Sunday Scheduled On Time Hour	AV21	R/W	Sunday Scheduled On Time Hour	0 ~ 23, 24 = Disable
Sunday Scheduled On Time Minute	AV22	R/W	Sunday Scheduled On Time Minute	0 ~ 59, 60 = Disable
Sunday Scheduled Off Time Hour	AV23	R/W	Sunday Scheduled Off Time Hour	0 ~ 23, 24 = Disable
Sunday Scheduled Off Time Minute	AV24	R/W	Sunday Scheduled Off Time Minute	0 ~ 59, 60 = Disable
Sunday Morning Session Hour	AV25	R/W	Sunday Morning Session Hour	0 ~ 23, 24 = Disable
Sunday Morning Session Minute	AV26	R/W	Sunday Morning Session Minute	0 ~ 59, 60 = Disable
Sunday Afternoon Session Hour	AV27	R/W	Sunday Afternoon Session Hour	0 ~ 23, 24 = Disable

Sunday Afternoon Session Minute	AV28	R/W	Sunday Afternoon Session Minute	0~ 59, 60 = Disable
Sunday Evening Session Hour	AV29	R/W	Sunday Evening Session Hour	0 ~ 23, 24 = Disable
Sunday Evening Session Minute	AV30	R/W	Sunday Evening Session Minute	0~ 59, 60 = Disable
Sunday Night Session Hour	AV31	R/W	Sunday Night Session Hour	0 ~ 23, 24 = Disable
Sunday Night Session Minute	AV32	R/W	Sunday Night Session Minute	0~ 59, 60 = Disable
Sunday Morning Session Cooling Set Point	AV33	R/W	Sunday Morning Session Cooling Set Point	16 ~ 86
Sunday Afternoon Session Cooling Set Point	AV34	R/W	Sunday Afternoon Session Cooling Set Point	16 ~ 86
Sunday Evening Session Cooling Set Point	AV35	R/W	Sunday Evening Session Cooling Set Point	16 ~ 86
Sunday Night Session Cooling Set Point	AV36	R/W	Sunday Night Session Cooling Set Point	16 ~ 86
Sunday Morning Session Heating Set Point	AV37	R/W	Sunday Morning Session Heating Set Point	16 ~ 86
Sunday Afternoon Session Heating Set Point	AV38	R/W	Sunday Afternoon Session Heating Set Point	16 ~ 86
Sunday Evening Session Heating Set Point	AV39	R/W	Sunday Evening Session Heating Set Point	16 ~ 86
Sunday Night Session Heating Set Point	AV40	R/W	Sunday Night Session Heating Set Point	16 ~ 86
Monday Scheduled On Time Hour	AV41	R/W	Monday Scheduled On Time Hour	0 ~ 23, 24 = Disable
Monday Scheduled On Time Minute	AV42	R/W	Monday Scheduled On Time Minute	0~ 59, 60 = Disable
Monday Scheduled Off Time Hour	AV43	R/W	Monday Scheduled Off Time Hour	0 ~ 23, 24 = Disable
Monday Scheduled Off Time Minute	AV44	R/W	Monday Scheduled Off Time Minute	0~ 59, 60 = Disable
Monday Morning Session Hour	AV45	R/W	Monday Morning Session Hour	0 ~ 23,

				24 = Disable
Monday Morning Session Minute	AV46	R/W	Monday Morning Session Minute	0~ 59, 60 = Disable
Monday Afternoon Session Hour	AV47	R/W	Monday Afternoon Session Hour	0 ~ 23, 24 = Disable
Monday Afternoon Session Minute	AV48	R/W	Monday Afternoon Session Minute	0~ 59, 60 = Disable
Monday Evening Session Hour	AV49	R/W	Monday Evening Session Hour	0 ~ 23, 24 = Disable
Monday Evening Session Minute	AV50	R/W	Monday Evening Session Minute	0~ 59, 60 = Disable
Monday Night Session Hour	AV51	R/W	Monday Night Session Hour	0 ~ 23, 24 = Disable
Monday Night Session Minute	AV52	R/W	Monday Night Session Minute	0~ 59, 60 = Disable
Monday Morning Session Cooling Set Point	AV53	R/W	Monday Morning Session Cooling Set Point	16 ~ 86
Monday Afternoon Session Cooling Set Point	AV54	R/W	Monday Afternoon Session Cooling Set Point	16 ~ 86
Monday Evening Session Cooling Set Point	AV55	R/W	Monday Evening Session Cooling Set Point	16 ~ 86
Monday Night Session Cooling Set Point	AV56	R/W	Monday Night Session Cooling Set Point	16 ~ 86
Monday Morning Session Heating Set Point	AV57	R/W	Monday Morning Session Heating Set Point	16 ~ 86
Monday Afternoon Session Heating Set Point	AV58	R/W	Monday Afternoon Session Heating Set Point	16 ~ 86
Monday Evening Session Heating Set Point	AV59	R/W	Monday Evening Session Heating Set Point	16 ~ 86
Monday Night Session Heating Set Point	AV60	R/W	Monday Night Session Heating Set Point	16 ~ 86
Tuesday Scheduled On Time Hour	AV61	R/W	Tuesday Scheduled On Time Hour	0 ~ 23, 24 = Disable
Tuesday Scheduled On Time Minute	AV62	R/W	Tuesday Scheduled On Time Minute	0~ 59,60 = Disable

Tuesday Scheduled Off Time Hour	AV63	R/W	Tuesday Scheduled Off Time Hour	0 ~ 23, 24 = Disable
Tuesday Scheduled Off Time Minute	AV64	R/W	Tuesday Scheduled Off Time Minute	0 ~ 59, 60 = Disable
Tuesday Morning Session Hour	AV65	R/W	Tuesday Morning Session Hour	0 ~ 23, 24 = Disable
Tuesday Morning Session Minute	AV66	R/W	Tuesday Morning Session Minute	0 ~ 59, 60 = Disable
Tuesday Afternoon Session Hour	AV67	R/W	Tuesday Afternoon Session Hour	0 ~ 23, 24 = Disable
Tuesday Afternoon Session Minute	AV68	R/W	Tuesday Afternoon Session Minute	0 ~ 59, 60 = Disable
Tuesday Evening Session Hour	AV69	R/W	Tuesday Evening Session Hour	0 ~ 23, 24 = Disable
Tuesday Evening Session Minute	AV70	R/W	Tuesday Evening Session Minute	0 ~ 59, 60 = Disable
Tuesday Night Session Hour	AV71	R/W	Tuesday Night Session Hour	0 ~ 23, 24 = Disable
Tuesday Night Session Minute	AV72	R/W	Tuesday Night Session Minute	0 ~ 59, 60 = Disable
Tuesday Morning Session Cooling Set Point	AV73	R/W	Tuesday Morning Session Cooling Set Point	16 ~ 86
Tuesday Afternoon Session Cooling Set Point	AV74	R/W	Tuesday Afternoon Session Cooling Set Point	16 ~ 86
Tuesday Evening Session Cooling Set Point	AV75	R/W	Tuesday Evening Session Cooling Set Point	16 ~ 86
Tuesday Night Session Cooling Set Point	AV76	R/W	Tuesday Night Session Cooling Set Point	16 ~ 86
Tuesday Morning Session Heating Set Point	AV77	R/W	Tuesday Morning Session Heating Set Point	16 ~ 86
Tuesday Afternoon Session Heating Set Point	AV78	R/W	Tuesday Afternoon Session Heating Set Point	16 ~ 86
Tuesday Evening Session Heating Set Point	AV79	R/W	Tuesday Evening Session Heating Set Point	16 ~ 86

Tuesday Night Session Heating Set Point	AV80	R/W	Tuesday Night Session Heating Set Point	16 ~ 86
Wednesday Scheduled On Time Hour	AV81	R/W	Wednesday Scheduled On Time Hour	0 ~ 23, 24 = Disable
Wednesday Scheduled On Time Minute	AV82	R/W	Wednesday Scheduled On Time Minute	0 ~ 59, 60 = Disable
Wednesday Scheduled Off Time Hour	AV83	R/W	Wednesday Scheduled Off Time Hour	0 ~ 23, 24 = Disable
Wednesday Scheduled Off Time Minute	AV84	R/W	Wednesday Scheduled Off Time Minute	0 ~ 59, 60 = Disable
Wednesday Morning Session Hour	AV85	R/W	Wednesday Morning Session Hour	0 ~ 23, 24 = Disable
Wednesday Morning Session Minute	AV86	R/W	Wednesday Morning Session Minute	0 ~ 59, 60 = Disable
Wednesday Afternoon Session Hour	AV87	R/W	Wednesday Afternoon Session Hour	0 ~ 23, 24 = Disable
Wednesday Afternoon Session Minute	AV88	R/W	Wednesday Afternoon Session Minute	0 ~ 59, 60 = Disable
Wednesday Evening Session Hour	AV89	R/W	Wednesday Evening Session Hour	0 ~ 23, 24 = Disable
Wednesday Evening Session Minute	AV90	R/W	Wednesday Evening Session Minute	0 ~ 59, 60 = Disable
Wednesday Night Session Hour	AV91	R/W	Wednesday Night Session Hour	0 ~ 23, 24 = Disable
Wednesday Night Session Minute	AV92	R/W	Wednesday Night Session Minute	0 ~ 59, 60 = Disable
Wednesday Morning Session Cooling Set Point	AV93	R/W	Wednesday Morning Session Cooling Set Point	16 ~ 86
Wednesday Afternoon Session Cooling Set Point	AV94	R/W	Wednesday Afternoon Session Cooling Set Point	16 ~ 86
Wednesday Evening Session Cooling Set Point	AV95	R/W	Wednesday Evening Session Cooling Set Point	16 ~ 86
Wednesday Night Session Cooling Set Point	AV96	R/W	Wednesday Night Session Cooling Set Point	16 ~ 86

Wednesday Morning Session Heating Set Point	AV97	R/W	Wednesday Morning Session Heating Set Point	16 ~ 86
Wednesday Afternoon Session Heating Set Point	AV98	R/W	Wednesday Afternoon Session Heating Set Point	16 ~ 86
Wednesday Evening Session Heating Set Point	AV99	R/W	Wednesday Evening Session Heating Set Point	16 ~ 86
Wednesday Night Session Heating Set Point	AV100	R/W	Wednesday Night Session Heating Set Point	16 ~ 86
Thursday Scheduled On Time Hour	AV101	R/W	Thursday Scheduled On Time Hour	0 ~ 23, 24 = Disable
Thursday Scheduled On Time Minute	AV102	R/W	Thursday Scheduled On Time Minute	0 ~ 59, 60 = Disable
Thursday Scheduled Off Time Hour	AV103	R/W	Thursday Scheduled Off Time Hour	0 ~ 23, 24 = Disable
Thursday Scheduled Off Time Minute	AV104	R/W	Thursday Scheduled Off Time Minute	0 ~ 59, 60 = Disable
Thursday Morning Session Hour	AV105	R/W	Thursday Morning Session Hour	0 ~ 23, 24 = Disable
Thursday Morning Session Minute	AV106	R/W	Thursday Morning Session Minute	0 ~ 59, 60 = Disable
Thursday Afternoon Session Hour	AV107	R/W	Thursday Afternoon Session Hour	0 ~ 23, 24 = Disable
Thursday Afternoon Session Minute	AV108	R/W	Thursday Afternoon Session Minute	0 ~ 59, 60 = Disable
Thursday Evening Session Hour	AV109	R/W	Thursday Evening Session Hour	0 ~ 23, 24 = Disable
Thursday Evening Session Minute	AV110	R/W	Thursday Evening Session Minute	0 ~ 59, 60 = Disable
Thursday Night Session Hour	AV111	R/W	Thursday Night Session Hour	0 ~ 23, 24 = Disable
Thursday Night Session Minute	AV112	R/W	Thursday Night Session Minute	0 ~ 59, 60 = Disable
Thursday Morning Session Cooling Set Point	AV113	R/W	Thursday Morning Session Cooling Set Point	16 ~ 86

Thursday Afternoon Session Cooling Set Point	AV114	R/W	Thursday Afternoon Session Cooling Set Point	16 ~ 86
Thursday Evening Session Cooling Set Point	AV115	R/W	Thursday Evening Session Cooling Set Point	16 ~ 86
Thursday Night Session Cooling Set Point	AV116	R/W	Thursday Night Session Cooling Set Point	16 ~ 86
Thursday Morning Session Heating Set Point	AV117	R/W	Thursday Morning Session Heating Set Point	16 ~ 86
Thursday Afternoon Session Heating Set Point	AV118	R/W	Thursday Afternoon Session Heating Set Point	16 ~ 86
Thursday Evening Session Heating Set Point	AV119	R/W	Thursday Evening Session Heating Set Point	16 ~ 86
Thursday Night Session Heating Set Point	AV120	R/W	Thursday Night Session Heating Set Point	16 ~ 86
Friday Scheduled On Time Hour	AV121	R/W	Friday Scheduled On Time Hour	0 ~ 23, 24 = Disable
Friday Scheduled On Time Minute	AV122	R/W	Friday Scheduled On Time Minute	0 ~ 59, 60 = Disable
Friday Scheduled Off Time Hour	AV123	R/W	Friday Scheduled Off Time Hour	0 ~ 23, 24 = Disable
Friday Scheduled Off Time Minute	AV124	R/W	Friday Scheduled Off Time Minute	0 ~ 59, 60 = Disable
Friday Morning Session Hour	AV125	R/W	Friday Morning Session Hour	0 ~ 23, 24 = Disable
Friday Morning Session Minute	AV126	R/W	Friday Morning Session Minute	0 ~ 59, 60 = Disable
Friday Afternoon Session Hour	AV127	R/W	Friday Afternoon Session Hour	0 ~ 23, 24 = Disable
Friday Afternoon Session Minute	AV128	R/W	Friday Afternoon Session Minute	0 ~ 59, 60 = Disable
Friday Evening Session Hour	AV129	R/W	Friday Evening Session Hour	0 ~ 23, 24 = Disable
Friday Evening Session Minute	AV130	R/W	Friday Evening Session Minute	0 ~ 59, 60 = Disable
Friday Night Session Hour	AV131	R/W	Friday Night Session Hour	0 ~ 23,

				24 = Disable
Friday Night Session Minute	AV132	R/W	Friday Night Session Minute	0~ 59, 60 = Disable
Friday Morning Session Cooling Set Point	AV133	R/W	Friday Morning Session Cooling Set Point	16 ~ 86
Friday Afternoon Session Cooling Set Point	AV134	R/W	Friday Afternoon Session Cooling Set Point	16 ~ 86
Friday Evening Session Cooling Set Point	AV135	R/W	Friday Evening Session Cooling Set Point	16 ~ 86
Friday Night Session Cooling Set Point	AV136	R/W	Friday Night Session Cooling Set Point	16 ~ 86
Friday Morning Session Heating Set Point	AV137	R/W	Friday Morning Session Heating Set Point	16 ~ 86
Friday Afternoon Session Heating Set Point	AV138	R/W	Friday Afternoon Session Heating Set Point	16 ~ 86
Friday Evening Session Heating Set Point	AV139	R/W	Friday Evening Session Heating Set Point	16 ~ 86
Friday Night Session Heating Set Point	AV140	R/W	Friday Night Session Heating Set Point	16 ~ 86
Saturday Scheduled On Time Hour	AV141	R/W	Saturday Scheduled On Time Hour	0 ~ 23, 24 = Disable
Saturday Scheduled On Time Minute	AV142	R/W	Saturday Scheduled On Time Minute	0~ 59, 60 = Disable
Saturday Scheduled Off Time Hour	AV143	R/W	Saturday Scheduled Off Time Hour	0 ~ 23, 24 = Disable
Saturday Scheduled Off Time Minute	AV144	R/W	Saturday Scheduled Off Time Minute	0~ 59, 60 = Disable
Saturday Morning Session Hour	AV145	R/W	Saturday Morning Session Hour	0 ~ 23, 24 = Disable
Saturday Morning Session Minute	AV146	R/W	Saturday Morning Session Minute	0~ 59, 60 = Disable
Saturday Afternoon Session Hour	AV147	R/W	Saturday Afternoon Session Hour	0 ~ 23, 24 = Disable
Saturday Afternoon Session Minute	AV148	R/W	Saturday Afternoon Session Minute	0~ 59, 60 = Disable



Saturday Evening Session Hour	AV149	R/W	Saturday Evening Session Hour	0 ~ 23, 24 = Disable
Saturday Evening Session Minute	AV150	R/W	Saturday Evening Session Minute	0 ~ 59, 60 = Disable
Saturday Night Session Hour	AV151	R/W	Saturday Night Session Hour	0 ~ 23, 24 = Disable
Saturday Night Session Minute	AV152	R/W	Saturday Night Session Minute	0 ~ 59, 60 = Disable
Saturday Morning Session Cooling Set Point	AV153	R/W	Saturday Morning Session Cooling Set Point	16 ~ 86
Saturday Afternoon Session Cooling Set Point	AV154	R/W	Saturday Afternoon Session Cooling Set Point	16 ~ 86
Saturday Evening Session Cooling Set Point	AV155	R/W	Saturday Evening Session Cooling Set Point	16 ~ 86
Saturday Night Session Cooling Set Point	AV156	R/W	Saturday Night Session Cooling Set Point	16 ~ 86
Saturday Morning Session Heating Set Point	AV157	R/W	Saturday Morning Session Heating Set Point	16 ~ 86
Saturday Afternoon Session Heating Set Point	AV158	R/W	Saturday Afternoon Session Heating Set Point	16 ~ 86
Saturday Evening Session Heating Set Point	AV159	R/W	Saturday Evening Session Heating Set Point	16 ~ 86
Saturday Night Session Heating Set Point	AV160	R/W	Saturday Night Session Heating Set Point	16 ~ 86
Fan Speed	MV1	R	Fan Speed	0 = Low, 1 = Medium, 2 = High, 3 = Auto
Operation Mode Feedback	MV2	R	Current operation Mode	0 = Cooling Mode, 1 = Fan Mode, 2 = Heating Mode, 3 = Auto Mode, 4 = Dry Mode
Thermostat Application	MV3	R/W	Thermostat Application	0 = Roof Top Unit, 1 = Heat Pump Unit, 2 = FCU-2 Pipe Cooling Only with On/Off Valve, 3 = FCU-2 Pipe Heating Only with On/Off Valve, 4 = FCU-2 Pipe Cooling Only with Floating Valve, 5 = FCU-2 Pipe Heating Only with floating Valve, 6 = FCU-4 Pipe Cooling and Heating with On/Off Valve,
Key Lock	MV4	R/W	Key Lock	0 = Unlock All Buttons 1 = Lock Switch Button 2 = Lock Mode Button 3 = Lock Timer Button 4 = Lock Fan Button, 5 = Lock Arrow Button 6 = Lock Light Button 7 = Lock All Buttons

Set Operation Mode	MV5	R/W	Set Operation Mode	0 = Cooling Mode, 2 = Heating Mode, 4 = Dry Mode	1 = Fan Mode, 3 = Auto Mode,
Power On Off Default State	MV6	R/W	Determine the thermostat should be on or off when power up.	0 = On Boot Off Previous State	1 = On Boot Restore 2 = On Boot Off
Sunday Morning Session Operation Mode	MV7	R/W	Sunday Morning Session Operation Mode	0 = Cooling Mode, 2 = Heating Mode, 4 = Dry Mode	1 = Fan Mode, 3 = Auto Mode,
Sunday Afternoon Session Operation Mode	MV8	R/W	Sunday Afternoon Session Operation Mode	0 = Cooling Mode, 2 = Heating Mode, 4 = Dry Mode	1 = Fan Mode, 3 = Auto Mode,
Sunday Evening Session Operation Mode	MV9	R/W	Sunday Evening Session Operation Mode	0 = Cooling Mode, 2 = Heating Mode, 4 = Dry Mode	1 = Fan Mode, 3 = Auto Mode,
Sunday Night Session Operation Mode	MV10	R/W	Sunday Night Session Operation Mode	0 = Cooling Mode, 2 = Heating Mode, 4 = Dry Mode	1 = Fan Mode, 3 = Auto Mode,
Monday Morning Session Operation Mode	MV11	R/W	Monday Morning Session Operation Mode	0 = Cooling Mode, 2 = Heating Mode, 4 = Dry Mode	1 = Fan Mode, 3 = Auto Mode,
Monday Afternoon Session Operation Mode	MV12	R/W	Monday Afternoon Session Operation Mode	0 = Cooling Mode, 2 = Heating Mode, 4 = Dry Mode	1 = Fan Mode, 3 = Auto Mode,
Monday Evening Session Operation Mode	MV13	R/W	Monday Evening Session Operation Mode	0 = Cooling Mode, 2 = Heating Mode, 4 = Dry Mode	1 = Fan Mode, 3 = Auto Mode,
Monday Night Session Operation Mode	MV14	R/W	Monday Night Session Operation Mode	0 = Cooling Mode, 2 = Heating Mode, 4 = Dry Mode	1 = Fan Mode, 3 = Auto Mode,
Tuesday Morning Session Operation Mode	MV15	R/W	Tuesday Morning Session Operation Mode	0 = Cooling Mode, 2 = Heating Mode, 4 = Dry Mode	1 = Fan Mode, 3 = Auto Mode,
Tuesday Afternoon Session Operation Mode	MV16	R/W	Tuesday Afternoon Session Operation Mode	0 = Cooling Mode, 2 = Heating Mode, 4 = Dry Mode	1 = Fan Mode, 3 = Auto Mode,
Tuesday Evening Session Operation Mode	MV17	R/W	Tuesday Evening Session Operation Mode	0 = Cooling Mode, 2 = Heating Mode, 4 = Dry Mode	1 = Fan Mode, 3 = Auto Mode,
Tuesday Night Session Operation Mode	MV18	R/W	Tuesday Night Session Operation Mode	0 = Cooling Mode, 2 = Heating Mode, 4 = Dry Mode	1 = Fan Mode, 3 = Auto Mode,
Wednesday Morning Session Operation Mode	MV19	R/W	Wednesday Morning Session Operation Mode	0 = Cooling Mode, 2 = Heating Mode, 4 = Dry Mode	1 = Fan Mode, 3 = Auto Mode,

Wednesday Afternoon Session Operation Mode	MV20	R/W	Wednesday Afternoon Session Operation Mode	0 = Cooling Mode, 2 = Heating Mode, 4 = Dry Mode	1 = Fan Mode, 3 = Auto Mode,
Wednesday Evening Session Operation Mode	MV21	R/W	Wednesday Evening Session Operation Mode	0 = Cooling Mode, 2 = Heating Mode, 4 = Dry Mode	1 = Fan Mode, 3 = Auto Mode,
Wednesday Night Session Operation Mode	MV22	R/W	Wednesday Night Session Operation Mode	0 = Cooling Mode, 2 = Heating Mode, 4 = Dry Mode	1 = Fan Mode, 3 = Auto Mode,
Thursday Morning Session Operation Mode	MV23	R/W	Thursday Morning Session Operation Mode	0 = Cooling Mode, 2 = Heating Mode, 4 = Dry Mode	1 = Fan Mode, 3 = Auto Mode,
Thursday Afternoon Session Operation Mode	MV24	R/W	Thursday Afternoon Session Operation Mode	0 = Cooling Mode, 2 = Heating Mode, 4 = Dry Mode	1 = Fan Mode, 3 = Auto Mode,
Thursday Evening Session Operation Mode	MV25	R/W	Thursday Evening Session Operation Mode	0 = Cooling Mode, 2 = Heating Mode, 4 = Dry Mode	1 = Fan Mode, 3 = Auto Mode,
Thursday Night Session Operation Mode	MV26	R/W	Thursday Night Session Operation Mode	0 = Cooling Mode, 2 = Heating Mode, 4 = Dry Mode	1 = Fan Mode, 3 = Auto Mode,
Friday Morning Session Operation Mode	MV27	R/W	Friday Morning Session Operation Mode	0 = Cooling Mode, 2 = Heating Mode, 4 = Dry Mode	1 = Fan Mode, 3 = Auto Mode,
Friday Afternoon Session Operation Mode	MV28	R/W	Friday Afternoon Session Operation Mode	0 = Cooling Mode, 2 = Heating Mode, 4 = Dry Mode	1 = Fan Mode, 3 = Auto Mode,
Friday Evening Session Operation Mode	MV29	R/W	Friday Evening Session Operation Mode	0 = Cooling Mode, 2 = Heating Mode, 4 = Dry Mode	1 = Fan Mode, 3 = Auto Mode,
Friday Night Session Operation Mode	MV30	R/W	Friday Night Session Operation Mode	0 = Cooling Mode, 2 = Heating Mode, 4 = Dry Mode	1 = Fan Mode, 3 = Auto Mode,
Saturday Morning Session Operation Mode	MV31	R/W	Saturday Morning Session Operation Mode	0 = Cooling Mode, 2 = Heating Mode, 4 = Dry Mode	1 = Fan Mode, 3 = Auto Mode,
Saturday Afternoon Session Operation Mode	MV32	R/W	Saturday Afternoon Session Operation Mode	0 = Cooling Mode, 2 = Heating Mode, 4 = Dry Mode	1 = Fan Mode, 3 = Auto Mode,
Saturday Evening Session Operation Mode	MV33	R/W	Saturday Evening Session Operation Mode	0 = Cooling Mode, 2 = Heating Mode, 4 = Dry Mode	1 = Fan Mode, 3 = Auto Mode,
Saturday Night Session Operation Mode	MV34	R/W	Saturday Night Session Operation Mode	0 = Cooling Mode, 2 = Heating Mode, 4 = Dry Mode	1 = Fan Mode, 3 = Auto Mode,

## FCC Statement

This equipment has been tested and found to comply with the limits for a Class B digital device, pursuant to part 15 of the FCC Rules. These limits are designed to provide reasonable protection against harmful interference in a residential installation. This equipment generates, uses and can radiate radio frequency energy and, if not installed and used in accordance with the instructions, may cause harmful interference to radio communications. However, there is no guarantee that interference will not occur in a particular installation. If this equipment does cause harmful interference to radio or television reception, which can be determined by turning the equipment off and on, the user is encouraged to try to correct the interference by one or more of the following measures:

- Reorient or relocate the receiving antenna.
- Increase the separation between the equipment and receiver.
- Connect the equipment into an outlet on a circuit different from that to which the receiver is connected.
- Consult the dealer or an experienced radio/TV technician for help.

Caution: Any changes or modifications to this device not explicitly approved by manufacturer could void your authority to operate this equipment.

This device complies with part 15 of the FCC Rules. Operation is subject to the following two conditions: (1) This device may not cause harmful interference, and (2) this device must accept any interference received, including interference that may cause undesired operation.

## RF Exposure Information

This equipment complies with FCC radiation exposure limits set forth for an uncontrolled environment. This equipment should be installed and operated with minimum distance 20cm between the radiator and your body.