



Test Report No.: FCC2024-0032-RF3

TEST REPORT

FCC ID : 2BG9T-TCLSMARTDP
Applicant : Shenzhen TCL Smart Home Technology Co., Ltd
Product Name : Smart Lock
D1 Pro,D10 Pro,D11 Pro,D12 Pro,D13
Mode No. : Pro,D14 Pro,D15 Pro,D16 Pro,D17
Pro,D18 Pro,D19 Pro
Classification Of Test: **COMMISSION TEST**

CVC Testing Technology Co., Ltd.



Applicant		Name: Shenzhen TCL Smart Home Technology Co., Ltd	
		Address: 7/F,TCL G1 Building. TCL International E City, No.1001 Zhongshan Yuan Road, Nanshan District,Shenzhen	
Manufacturer		Name: Shenzhen TCL Smart Home Technology Co., Ltd	
		Address: 7/F,TCL G1 Building. TCL International E City, No.1001 Zhongshan Yuan Road, Nanshan District,Shenzhen	
Equipment Under Test		Product Name : Smart Lock	
		Model No. : D1 Pro	
		Trade mark : TCL	
		Serial no. : D1Pro240800001	
		Sampling : 1-1	
Date of Receipt.	2024.7.4	Date of Testing	2024.8.1
Test Specification		Test Result	
FCC CFR47 Part 15C Radio Frequency Devices ANSI C63.10-2020/Cor1-2023		PASS	
Evaluation of Test Result	The equipment under test was found to comply with the requirements of the standards applied.		
	Seal of CVC Issue Date: 2024-8-16		
Approved by: Chen Huawen 	Reviewed by: Xu Zhenfei 	Tested by: Lu Weiji 	
Other Aspects: NONE.			
Abbreviations:OK, Pass= passed Fail = failed N/A= not applicable EUT= equipment, sample(s) under tested			
This test report relates only to the EUT, and shall not be reproduced except in full, without written approval of CVC .			

TABLE OF CONTENTS

- 1. GENERAL PRODUCT INFORMATION 4**
 - 1.1 GENERAL INFORMATION 4
- 2. TEST SITES 6**
 - 2.1 TEST FACILITIES 6
 - 2.2 DESCRIPTION OF NON-STANDARD METHOD AND DEVIATIONS 6
 - 2.3 LIST OF TEST AND MEASUREMENT INSTRUMENTS 6
- 3. TEST CONFIGURATION 7**
 - 3.1 TEST MODE 7
- 4. SUMMARY OF MEASUREMENT RESULTS 8**
- 5. MEASUREMENT PROCEDURE 9**
 - 5.1 CONDUCTED EMISSION 9
 - 5.2 RADIATED EMISSION 13
 - 5.3 FREQUENCY TOLERANCE 21
 - 5.4 20dB BANDWIDTH MEASUREMENT 23
- 6. APPENDIX A 25**

1. General Product Information

1.1 General information

Product Name	Smart Lock	
Model No.	D1 Pro	
Additional model	D10 Pro,D11 Pro,D12 Pro,D13 Pro,D14 Pro,D15 Pro,D16 Pro,D17 Pro,D18 Pro,D19 Pro	
Power Supply	Rated voltage	DC 5.0V
	Battery voltage	DC 3.7V
Serial Number(SN)	D1Pro240800001	
firmware	Front motherboard:S300-FRONT-V03; Rear motherboard:S300-REARLOCK_V03; Touch Pad: S300_TOUCH_V02	
software	V2007019	
specific power settings	Default	
Antenna Type	Internal Antenna	
Antenna Connector	A permanently attached antenna	
Antenna Gain	0.5 dBi (provided by client)	
Beamforming gain	Unsupported (provided by client)	
Frequency Range	13.110-14.010MHz	
Channel Number	1 Channel	
Type of Modulation	ASK	
Max. Power	-42.55dBm	
Operate Temp.Range	-20~85°C	

Note:

- The information of the EUT is declared by the manufacturer.
- The laboratory is not responsible for the product technical specification provided by the client.
- All the models are electrical identical including the same software parameter and hardware design (i.e., circuit design, PCB Layout, RF module/circuit, antenna type(s) and antenna location, components on PCB, etc.), same mechanical structure and design (including product enclosure, materials, etc.), the only difference is the model name, color, package..

No.	Model	Difference	Remarks
1	D1 Pro	1. Only the appearance color difference is different. 2. Only the printing style on the surface of the package is different, the product inside the package is the same.	Inspection model
2	D10 Pro		Coverage model
3	D11 Pro		Coverage model
4	D12 Pro		Coverage model
5	D13 Pro		Coverage model
6	D14 Pro		Coverage model
7	D15 Pro		Coverage model
8	D16 Pro		Coverage model
9	D17 Pro		Coverage model

	10	D18 Pro		Coverage model	
	11	D19 Pro		Coverage model	

2. Test Sites

2.1 Test Facilities

The tests and measurements refer to this report were performed by RF testing Lab. of CVC Testing Technology Co., Ltd.

Add.: No.3, Tiantaiyi Road, Kaitai Avenue, Science City, Guangzhou,Guangdong,510663, People's Republic of China

Telephone : +86-20-32293888

Fax : +86-20-32293889

FCC(Test firm designation number: CN1282)

2.2 Description of Non-standard Method and Deviations

The testing and measurement methods used in this report are applied by all standard methods. Not any non-standard method or deviation from the used standards was used.

2.3 List of Test and Measurement Instruments

Refer to **Appendix A**.

3. Test Configuration

3.1 Test Mode

The EUT has been associated with peripherals and configuration operated in a manner tended to maximize its emission characteristics in a typical application.

Test Mode	Antenna Delivery	Test Channel
Transmitting	1TX	13.56MHz

The radiated emission was measured in the following position: EUT stand-up position (Z axis), lie-down position (X, Y axis). The worst emission was found in lie-down position (X axis) and the worst case was recorded.

In order to find the worst case condition, Pre-tests are needed at the presence of different data rate and different channels. Preliminary tests have been done on all the configurations for confirming worst case. Data rate below means worst-case rate of each test item.

Worst-case data rates and channels are shown as following table.

Test Mode	Data Rate		
	Antenna 1	Antenna 2	MIMO
Transmitting	√	/	/

Test Items	Test Antenna	Test Mode	Test Channel
Conducted Emissions	Antenna 1	Transmitting	13.56MHz
The field strength of Fundamental Emission	Antenna 1	Transmitting	13.56MHz
Radiated Emissions	Antenna 1	Transmitting	13.56MHz
Frequency tolerance	Antenna 1	Transmitting	13.56MHz
20dB Bandwidth	Antenna 1	Transmitting	13.56MHz

4. Summary of measurement results

Summary of measurements of results	Clause in FCC rules	Verdict	Note
Conducted Emissions	15.207	PASS	/
The field strength of Fundamental Emission	FCC 15.225(a)&(b)&(c)	PASS	/
Radiated Emissions	FCC 15.225 (d) FCC 15.209	PASS	/
Frequency tolerance	FCC 15.225 (e)	PASS	/
20dB Bandwidth	FCC 15.215 (c)	PASS	/
Antenna Requirement	15.203	PASS	See note 1

Note 1: According to 15.203, it is considered sufficient to comply with the provisions of this section.

5. Measurement procedure

5.1 Conducted Emission

Ambient condition:

Temperature	Relative humidity	Pressure
23°C ~25°C	45%~50%	101.3kPa

Method of Measurement:

The EUT was setup according to ANSI C63.10-2020/Cor1-2023 for compliance to FCC 47CFR 15.247 requirements. The EUT was placed on a platform of nominal size, 1 m by 1.5 m, raised 80 cm above the conducting ground plane. The vertical conducting plane was located 40 cm to the rear of the EUT. All other surfaces of EUT were at least 80 cm from any other grounded conducting surface. The EUT and simulators are connected to the main power through a line impedance stabilization network (LISN). The LISN provides a 50 ohm /50uH coupling impedance for the measuring equipment. The peripheral devices are also connected to the main power through a LISN. (Please refer to the block diagram of the test setup and photographs) Each current-carrying conductor of the EUT power cord, except the ground (safety) conductor, was individually connected through a LISN to the input power source.

The excess length of the power cord between the EUT and the LISN receptacle were folded back and forth at the center of the lead to form a bundle not exceeding 40 cm in length.

Conducted emissions were investigated over the frequency range from 0.15MHz to 30MHz using a receiver bandwidth of 9 kHz.

Limits:

Frequency (MHz)	Conducted Limits(dBµV)	
	Quasi-peak	Average
0.15 - 0.5	66 to 56 *	56 to 46*
0.5 - 5	56	46
5 - 30	60	50

Note 1: The lower limit shall apply at the transition frequencies.

Note 2: The limit decreases linearly with the logarithm of the frequency in the range 0.15 MHz to 0.5 MHz.

Test Setup:

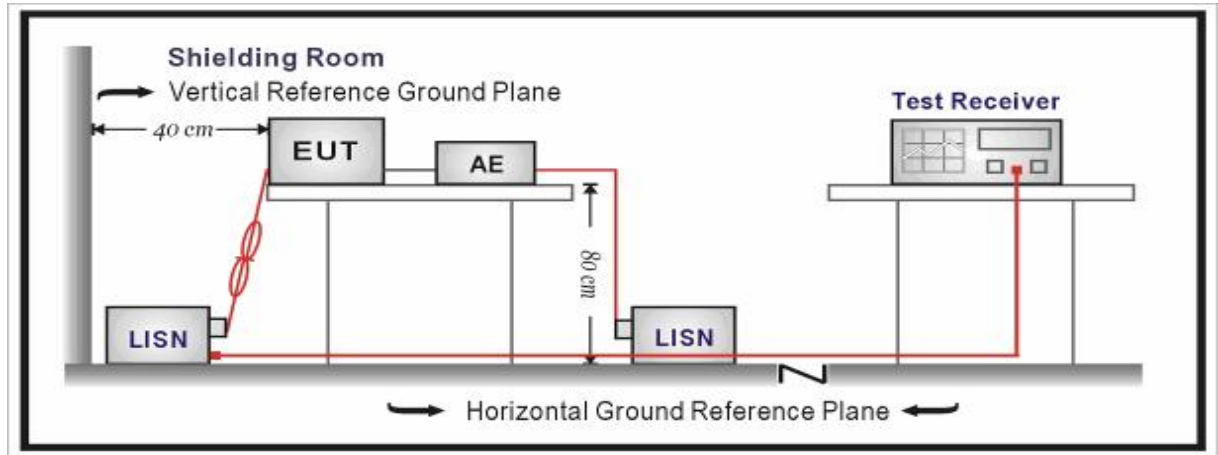

Measurement Data

An initial pre-scan was performed on the live and neutral lines with peak detector.

Quasi-Peak and Average measurement were performed at the frequencies with maximized peak emission were detected.

Notes:

1. The following Quasi-Peak and Average measurements were performed on the EUT:
2. Final Level = Reading + Factor.

Measurement Uncertainty:

The assessed measurement uncertainty to ensure 95% confidence level for the normal distribution is with the coverage factor $k = 1.96$. $U = 3.12$ dB.

Test Results:

During the test, the Conducted Emission from 150kHz to 30MHz was performed in all modes with all channels, and all antennas. Transmitting, 13.56MHz, Antenna 1 are selected as the worst condition. The test data of the worst-case condition was recorded in this report.

Power Line	L
Test channel	Worst-Case

NO.	Freq. [MHz]	Factor [dB]	Reading [dBμV]	Level [dBμV]	Limit [dBμV]	Margin [dB]	Detector	Pass/Fail
1	0.6743	10.24	27.29	37.53	56.00	18.47	QP	PASS
3	2.5395	10.32	16.97	27.29	56.00	28.71	QP	PASS
5	20.5058	11.44	11.31	22.75	60.00	37.25	QP	PASS
2	0.6743	10.24	9.46	19.70	46.00	26.30	AV	PASS
4	20.5868	11.44	4.79	16.23	50.00	33.77	AV	PASS
6	2.5395	10.32	0.53	10.85	46.00	35.15	AV	PASS

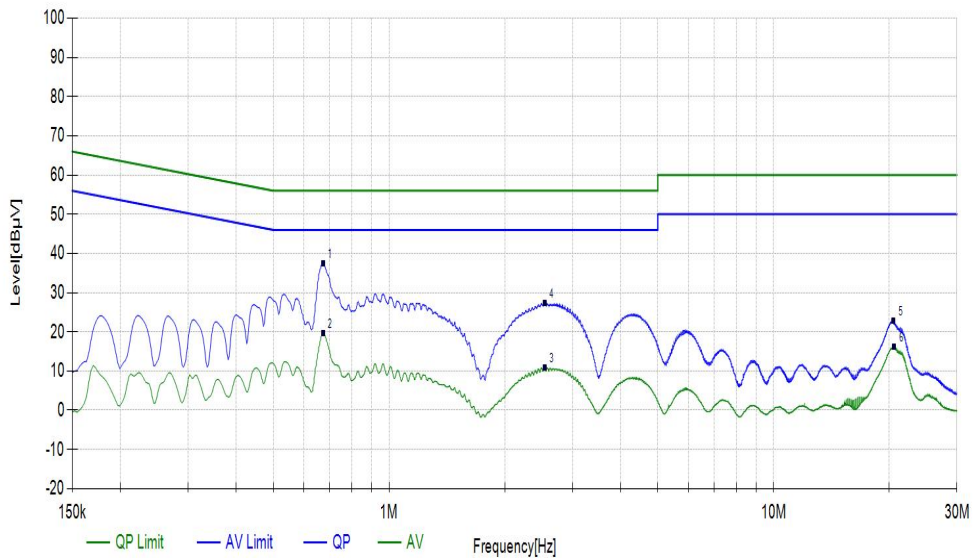

Power Line	N
Test channel	Worst-Case

NO.	Freq. [MHz]	Factor [dB]	Reading [dBμV]	Level [dBμV]	Limit [dBμV]	Margin [dB]	Detector	Pass/Fail
1	0.6743	10.22	31.95	42.17	56.00	13.83	QP	PASS
3	2.6813	10.32	19.83	30.15	56.00	25.85	QP	PASS
5	4.3080	10.37	20.36	30.73	56.00	25.27	QP	PASS
2	0.6743	10.22	14.78	25.00	46.00	21.00	AV	PASS
4	4.3575	10.37	3.30	13.67	46.00	32.33	AV	PASS
6	2.6250	10.32	2.51	12.83	46.00	33.17	AV	PASS

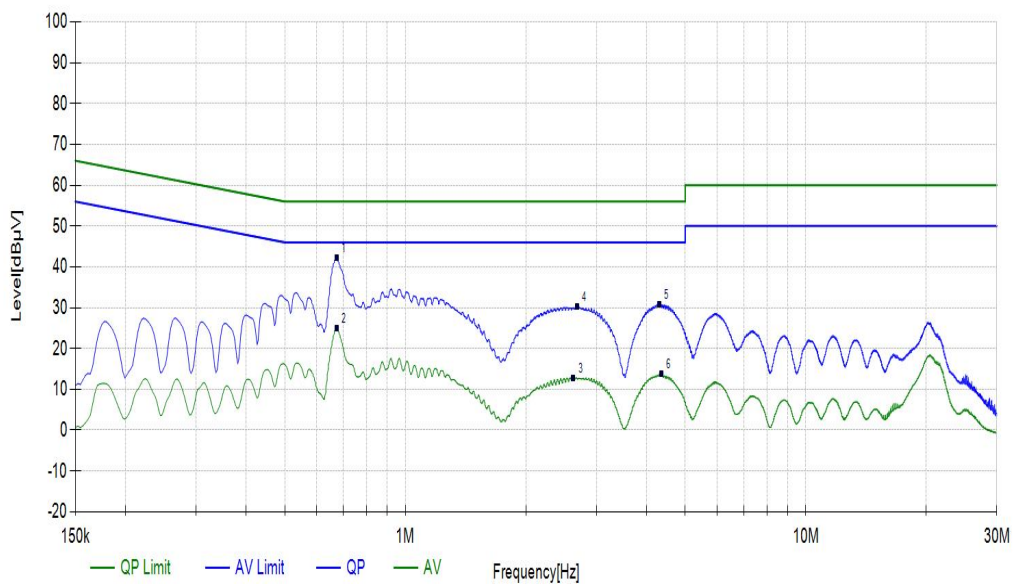

5.2 Radiated Emission

Ambient condition:

Temperature	Relative humidity	Pressure
23°C ~25°C	45%~50%	101.3kPa

Method of Measurement:

The EUT was setup and tested according to ANSI C63.10-2020/Cor1-2023.

The EUT is placed on a turn table which is 1.5 meter above ground. The turn table is rotated 360 degrees to determine the position of the maximum emission level. The EUT was positioned such that the distance from Antenna to the EUT was 3 meters.

The Antenna is scanned from 1 meter to 4 meters to find out the maximum emission level. This is repeated for both horizontal and vertical polarization of the Antenna. In order to find the maximum emission, all of the interface cables were manipulated according to ANSI C63.10-2020/Cor1-2023 on radiated measurement. The resolution bandwidth below 1GHz setting on the field strength meter is 120 kHz and above 1GHz is 1MHz.

The frequency range from 30MHz to 10th harmonic is checked.

Note: When doing emission measurement above 1GHz, the horn Antenna will be bended down a little (as horn Antenna has the narrow beamwidth) in order to keeping the Antenna in the “cone of radiation” of EUT. The 3dB beamwidth is 10~60 degrees for H-plane and 10~90 degrees for E-plane.

Limits:

§15.225

(a) The field strength of any emissions within the band 13.553-13.567 MHz shall not exceed 15,848 microvolts/meter at 30 meters. (124.00dB μ V/m@3m)

(b) Within the bands 13.410-13.553 MHz and 13.567-13.710 MHz, the field strength of any emissions shall not exceed 334 microvolts/meter at 30 meters. (90.50dB μ V/m@3m)

(c) Within the bands 13.110-13.410 MHz and 13.710-14.010 MHz the field strength of any emissions shall not exceed 106 microvolts/meter at 30 meters.(80.50dB μ V/m@3m)

(d) The field strength of any emissions appearing outside of the 13.110– 14.010 MHz and shall not exceed the general radiated emission limits in § 15.209 as follows:

Radiated emissions which fall in the restricted bands, as defined in Section 15.205(a) of FCC part 15, must also comply with the radiated emission limits specified in Section 15.209(a) (see Section 15.205(c)).

Frequency	Limit (µV/m)	Limit (dBµV/m @3m)	Remark
0.009MHz-0.490MHz	2400/F(kHz)@300m	20lg(24000000/F(kHz))	Quasi-peak Level
0.490MHz~1.705MHz	24000/F(kHz)@30m	20lg(2400000/F(kHz))	Quasi-peak Level
1.705MHz~30.0MHz	30@30m	69.54	Quasi-peak Level
30MHz-88MHz	100@3m	40.0	Quasi-peak Level
88MHz-216MHz	150@3m	43.5	Quasi-peak Level
216MHz-960MHz	200@3m	46.0	Quasi-peak Level
960MHz-1GHz	500@3m	54.0	Quasi-peak Level
Above 1GHz	500@3m	54.0	Average Level
	5000@3m	74.0	Peak Level

Test Setup:

Below 30MHz Test Setup:

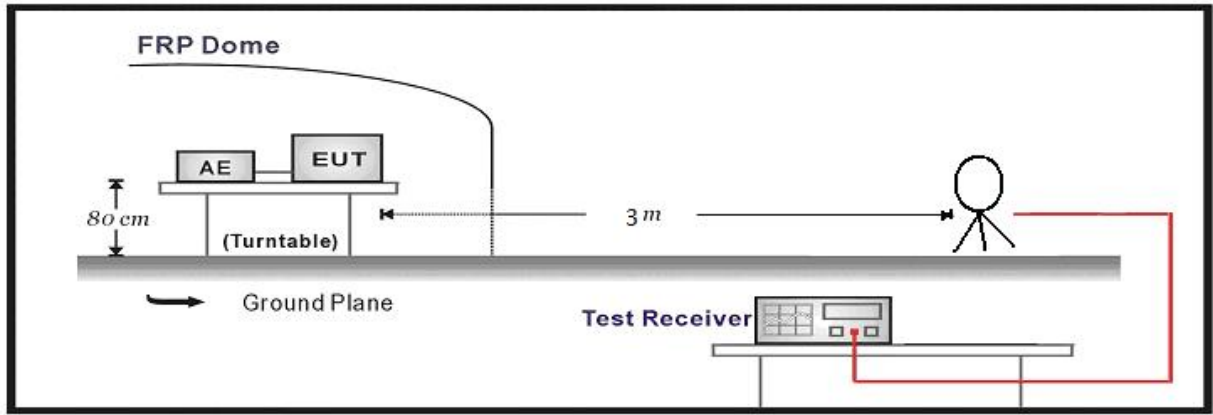

Below 1GHz Test Setup:

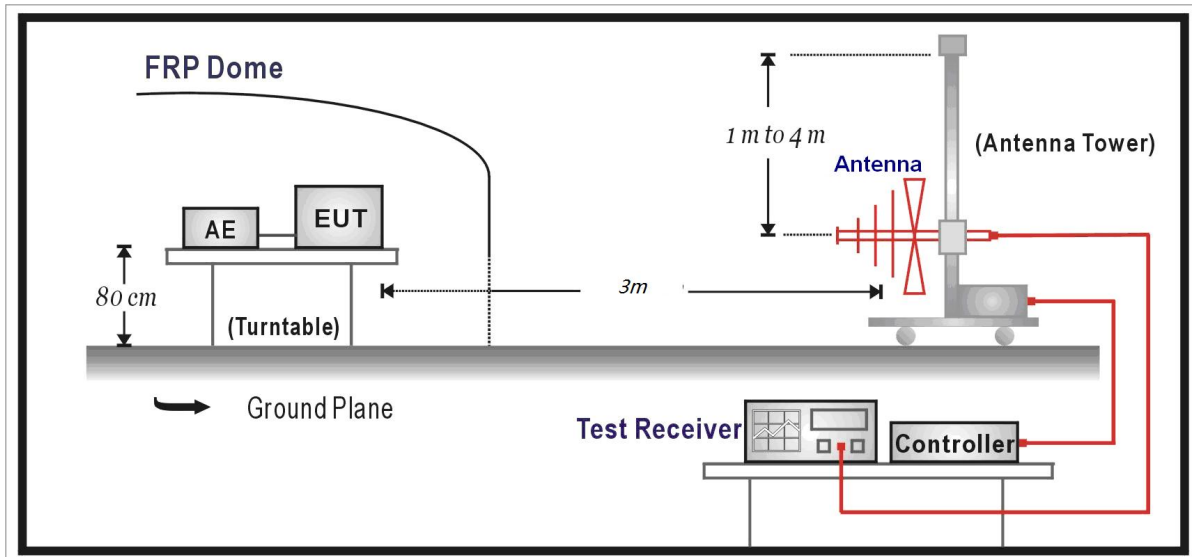

Measurement Data:

The field strength is calculated by adding the Antenna Factor, Cable Factor & Preamplifier. The basic equation with a sample calculation is as follows:

Final Level = Reading - Factor

Factor = Preamplifier Factor – Antenna Factor–Cable Loss

Measurement Uncertainty:

The assessed measurement uncertainty to ensure 95% confidence level for the normal distribution is with the coverage factor $k = 1.96$.

Frequency	Uncertainty
9KHz-30MHz	3.55 dB
30MHz-200MHz	4.19 dB
200MHz-1GHz	3.63 dB
Above 1GHz	3.68 dB

Test Results:

Result of The field strength of Fundamental Emission

During the test, the Radiates Emission from 9kHz to 1GHz was performed in NFC all modes with all channels and all antennas. Transmitting, 13.56MHz, Antenna 1, X Polarity are selected as the worst condition. The test data of the worst-case condition was recorded in this report.

Test channel	13.56MHz								
Polarity	X								
Suspected List									
Frequency [MHz]	Factor [dB]	Reading [dB μ V/m]	Level [dB μ V/m]	Limit [dB μ V/m]	Margin [dB]	Detector	Height [cm]	Angle deg	Pass/Fail
12.9234	20.94	12.85	33.79	69.85	36.06	PK	100	40	PASS
13.2646	20.95	13.49	34.44	80.50	46.06	PK	100	200	PASS
13.5588	20.98	31.67	52.65	124.00	71.35	PK	100	110	PASS
14.2412	21.00	13.86	34.86	69.50	34.64	PK	100	190	PASS
Final Data List									
Frequency [MHz]	Factor [dB]	QP Value [dB μ V/m]	QP Limit [dB μ V/m]	QP Margin [dB]	Height [cm]	Angle [°]	Pass/Fail		
12.927	20.94	25.76	69.85	44.09	250	45	PASS		
13.2894	20.95	25.53	80.50	54.97	260	205	PASS		
13.5590	20.98	45.55	124.00	78.45	100	110	PASS		
14.2653	21.00	25.84	69.50	43.66	120	195	PASS		

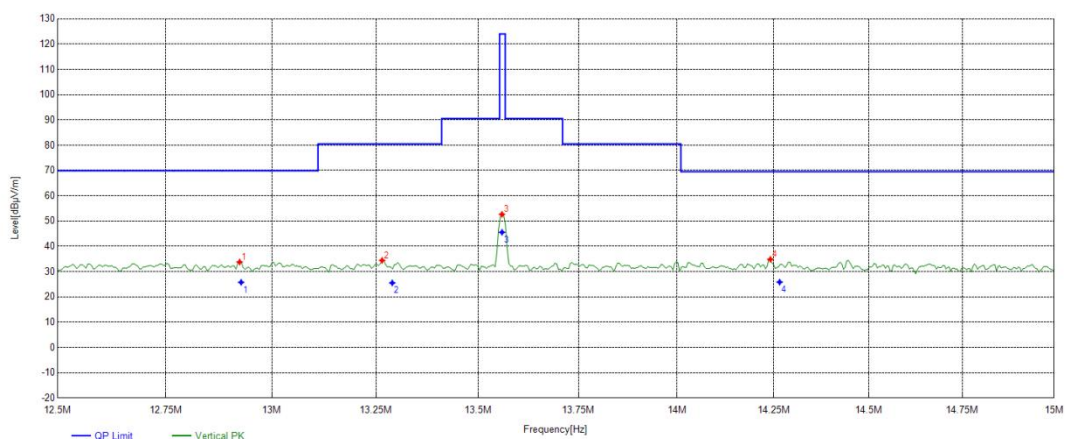

Result of Radiated Emissions

During the test, the Radiates Emission from 9kHz to 1GHz was performed in NFC all modes with all channels and all antennas. Transmitting, 13.56MHz, Antenna 1 are selected as the worst condition. The test data of the worst-case condition was recorded in this report.

Radiates Emission		9k~30M							
Test channel		13.56MHz							
Polarity		X							
Suspected List									
Frequency [MHz]	Factor [dB]	Reading [dBμV/m]	Level [dBμV/m]	Limit [dBμV/m]	Margin [dB]	Detector	Height [cm]	Angle deg	Pass/Fail
0.6703	20.54	22.65	43.19	71.09	27.90	PK	100	320	PASS
5.4171	20.78	14.85	35.63	69.50	33.87	PK	100	30	PASS
13.5588	20.98	31.67	52.65	69.50	16.85	PK	100	110	PASS
21.9991	20.62	14.48	35.10	69.50	34.40	PK	100	40	PASS
Final Data List									
Frequency [MHz]	Factor [dB]	QP Value [dBμV/m]	QP Limit [dBμV/m]	QP Margin [dB]	Height [cm]	Angle [°]	Pass/Fail		
0.6705	Vertical	42.01	71.08	29.07	170	325	PASS		
5.4005	Vertical	28.10	69.50	41.40	240	35	PASS		
13.5590	Vertical	45.55	69.50	23.95	100	110	PASS		
21.9927	Vertical	24.35	69.50	45.15	250	45	PASS		

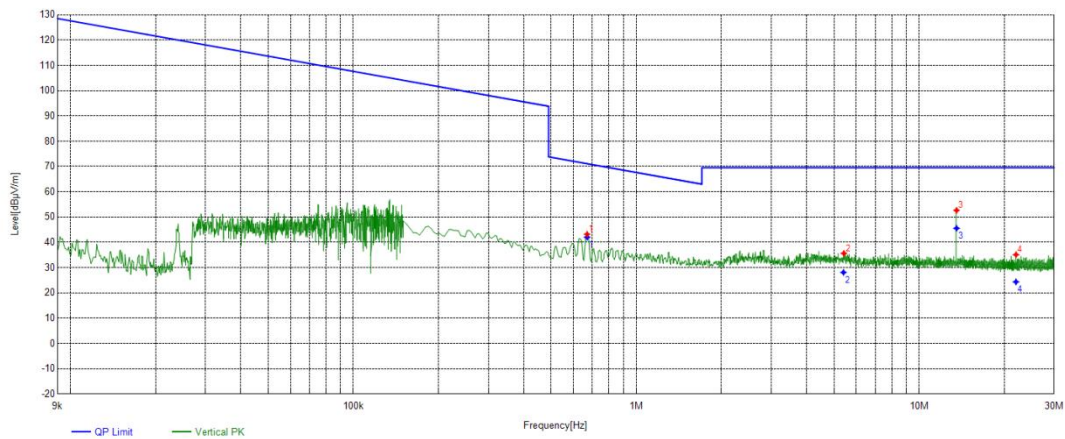

Radiates Emission		30M~1G							
Test channel		13.56MHz							
Polarity		Horizontal							
Suspected List									
Frequency [MHz]	Factor [dB]	Reading [dBμV/m]	Level [dBμV/m]	Limit [dBμV/m]	Margin [dB]	Detector	Height [cm]	Angle deg	Pass/Fail
54.6405	20.35	-1.77	18.58	---	---	PK	100	70	---
162.7093	20.85	-0.47	20.38	---	---	PK	100	170	---
733.9994	31.10	0.64	31.74	---	---	PK	100	240	---
Final Data List									
Frequency [MHz]	Factor [dB]	QP Value [dBμV/m]	QP Limit [dBμV/m]	QP Margin [dB]	Height [cm]	Angle [°]	Pass/Fail		
54.6411	20.34	17.16	40.00	22.84	100	150	PASS		
162.7033	20.85	18.94	43.50	24.56	100	170	PASS		
733.9901	31.10	30.88	46.00	15.12	100	240	PASS		

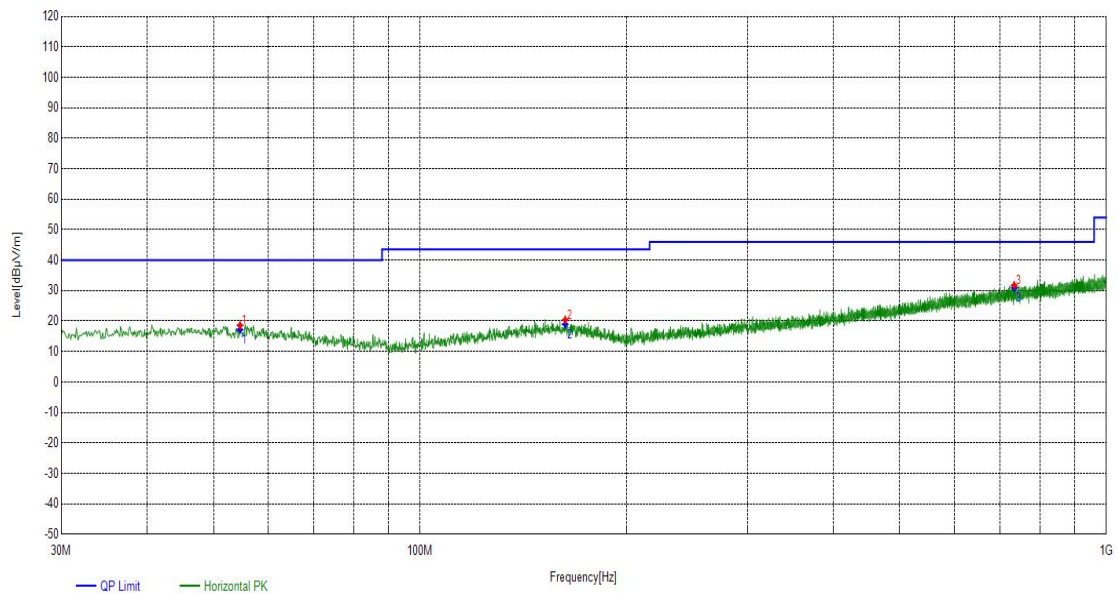

Radiates Emission		30M~1G							
Test channel		13.56MHz							
Polarity		Vertical							
Suspected List									
Frequency [MHz]	Factor [dB]	Reading [dBμV/m]	Level [dBμV/m]	Limit [dBμV/m]	Margin [dB]	Detector	Height [cm]	Angle deg	Pass/Fail
41.1561	20.09	5.86	25.95	---	---	PK	100	90	---
85.4895	15.15	10.86	26.01	---	---	PK	100	250	---
367.2057	23.24	0.99	24.23	---	---	PK	100	360	---
Final Data List									
Frequency [MHz]	Factor [dB]	QP Value [dBμV/m]	QP Limit [dBμV/m]	QP Margin [dB]	Height [cm]	Angle [°]	Pass/Fail		
41.0376	20.09	20.09	40.00	19.91	390	95	PASS		
85.3275	15.15	14.56	40.00	25.44	250	255	PASS		
367.2500	23.24	19.19	46.00	26.81	100	360	PASS		

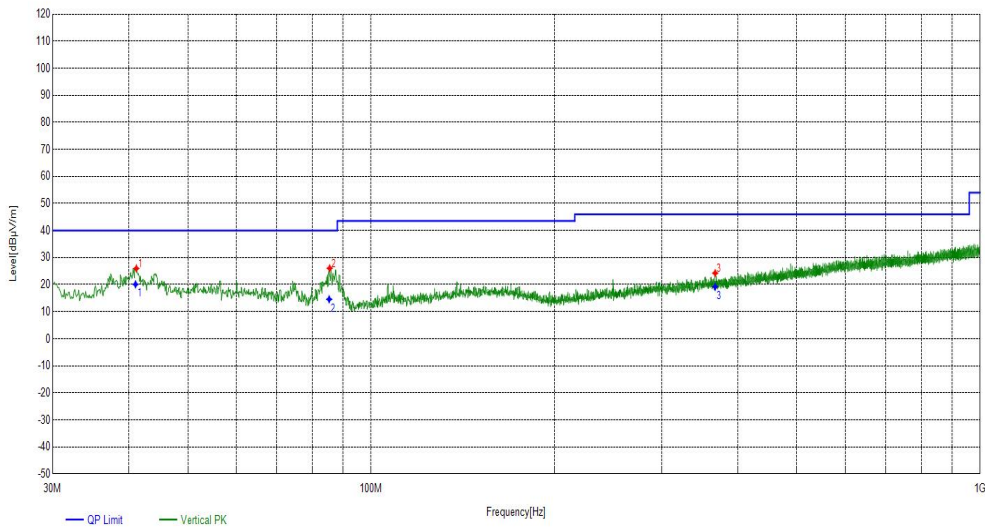

5.3 FREQUENCY TOLERANCE

Ambient condition:

Temperature	Relative humidity	Pressure
23°C ~25°C	45%~50%	101.3kPa

Method of Measurement:

- a. The EUT was placed inside the environmental test chamber and powered by nominal DC voltage.
- b. Turn the EUT on and couple its output to a spectrum analyzer.
- c. Turn the EUT off and set the chamber to the highest temperature specified.
- d. Allow sufficient time (approximately 30 min) for the temperature of the chamber to stabilize, turn the EUT on and measure the operating frequency after 2, 5, and 10 minutes.
- e. Repeat step c) and d) with the temperature chamber set to the lowest temperature.
- f. The test chamber was allowed to stabilize at +20 degree C for a minimum of 30 minutes. The supply voltage was then adjusted on the EUT from 85% to 115% and the frequency record.

Test Setup:

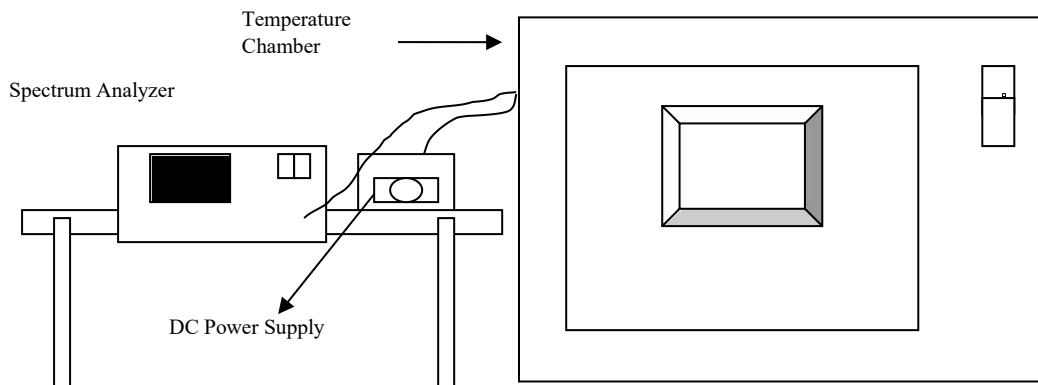

LIMITS OF FREQUENCY TOLERANCE

The frequency tolerance of the carrier signal shall be maintained within $\pm 0.01\%$ (100ppm) of the operating frequency over a temperature variation of -20 degrees to $+ 50$ degrees C at normal supply voltage, and for a variation in the primary supply voltage from 85% to 115% of the rated supply voltage at a temperature of 20 degrees C. For battery operated equipment, the equipment tests shall be performed using a new battery.

Measurement Uncertainty:

The assessed measurement uncertainty to ensure 95% confidence level for the normal distribution is with the coverage factor $k = 2$, $U = 936$ Hz.

Test Results:

FREQUENCY STABILITY VERSUS TEMP.											
TEMP. (°C)	POWER SUPPLY (V)	0 MINUTE		2 MINUTE		5 MINUTE		10 MINUTE		Limit (ppm)	PASS/ FAIL
		Measured Frequency	Frequency Drift	Measured Frequency	Frequency Drift	Measured Frequency	Frequency Drift	Measured Frequency	Frequency Drift		
		(MHz)	ppm	(MHz)	ppm	(MHz)	ppm	(MHz)	ppm		
50	24	13.5612	86.7075	13.5612	87.1948	13.5612	87.3919	13.5612	87.5020	100	PASS
40	24	13.5612	87.8501	13.5612	86.5798	13.5612	87.3593	13.5612	86.6693	100	PASS
30	24	13.5612	87.3606	13.5612	87.5567	13.5612	87.7738	13.5612	87.2441	100	PASS
20	24	13.5612	87.7799	13.5612	87.1670	13.5612	86.7650	13.5612	86.8099	100	PASS
10	24	13.5612	86.4485	13.5612	87.5738	13.5612	87.6693	13.5612	87.4283	100	PASS
0	24	13.5612	87.6259	13.5612	86.7628	13.5612	86.6395	13.5612	87.6130	100	PASS
-10	24	13.5612	87.5290	13.5612	86.8527	13.5612	86.9520	13.5612	86.6877	100	PASS
-20	24	13.5612	87.4786	13.5612	87.1225	13.5612	87.8588	13.5612	87.1355	100	PASS
20	20.4	13.5612	86.5013	13.5612	86.8600	13.5612	86.9572	13.5612	86.6627	100	PASS
	27.6	13.5612	87.0052	13.5612	87.1874	13.5612	87.4685	13.5612	87.1191	100	PASS

5.4 20dB BANDWIDTH MEASUREMENT

Ambient condition:

Temperature	Relative humidity	Pressure
23°C ~25°C	45%~50%	101.3kPa

Method of Measurement:

The spectrum analyzer was receiving the maximum emission level. The 20dB bandwidth is defined as the total spectrum the power of which is higher than peak power minus 20dB.

Test Setup:

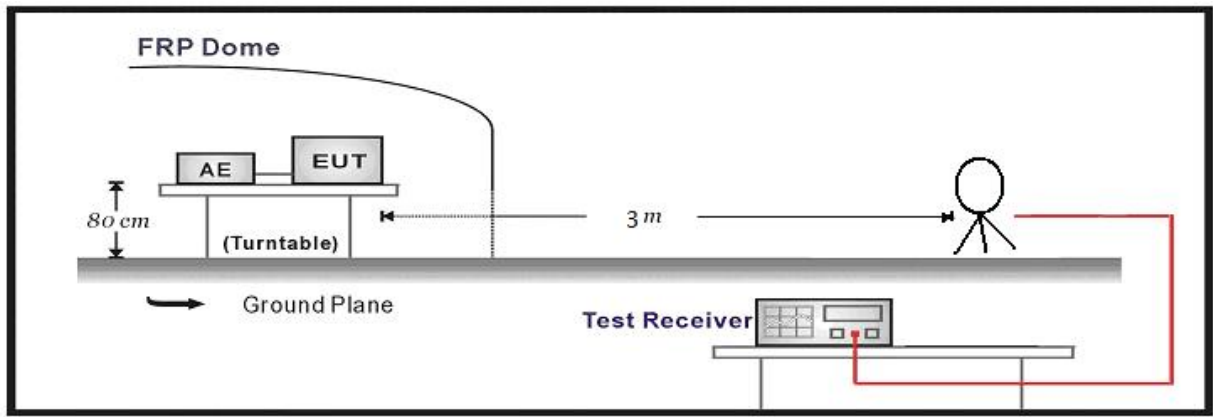

LIMITS OF 20dB BANDWIDTH MEASUREMENT

The 20dB bandwidth shall be specified in operating frequency band. (13.11MHz ~ 14.01MHz)

Measurement Uncertainty:

The assessed measurement uncertainty to ensure 95% confidence level for the normal distribution is with the coverage factor $k = 2$, $U = 936$ Hz.

Test Results:

Frequency (MHz)	20dB Bandwidth (kHz)	Lower (MHz)	Upper (MHz)	Limit (MHz)	PASS/FAIL
13.56	2.417	13.5599	13.5624	13.11~14.01	PASS

The plots of test results are attached as below.

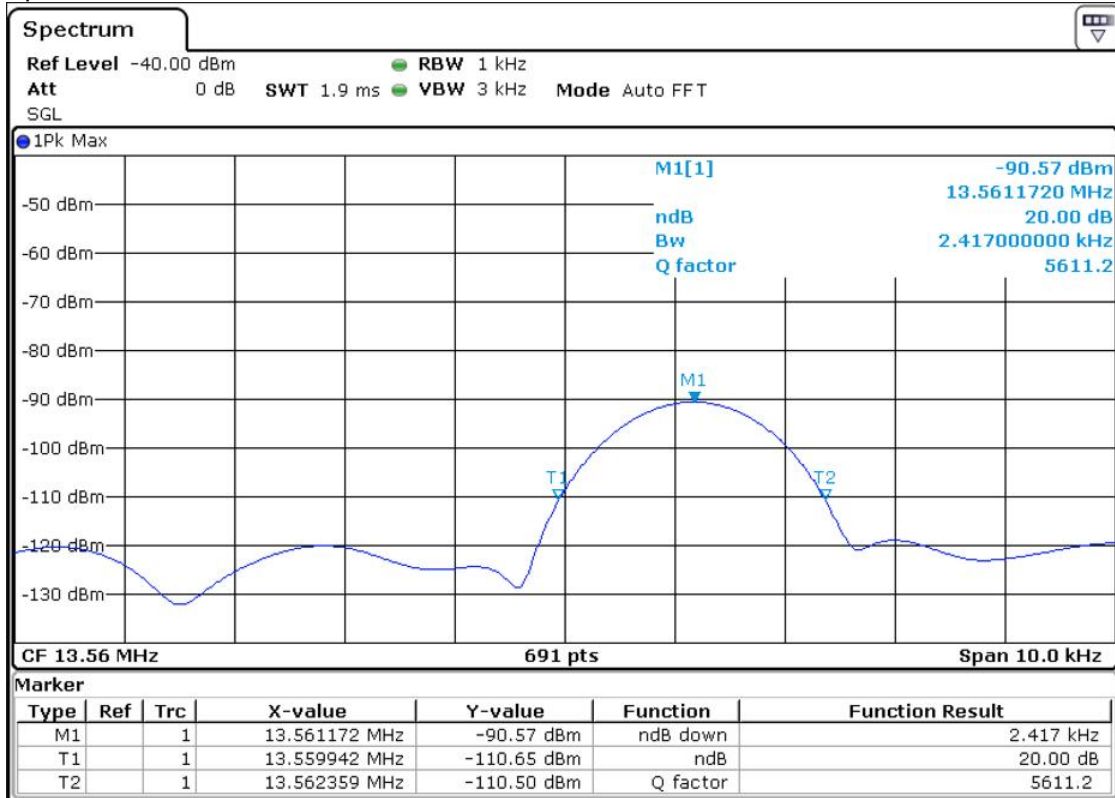

6. Appendix A

Test Equipment	Type/Mode	SERIAL NO.	Equipment No.	Manufacturer	Cal. Due
Spectrum Analyzer	FSV40	101580	DZ-000238-3	R&S	2025/04/22
5m Semi-Anechoic Chamber	SAC-5	SAC-5-2.0	EM-000557	COMTEST	2024/11/02
EMI Test Receiver	N9038A-508	MY532290079	EM-000397	Agilent	2025/01/13
EMI Test Receiver	ESR7	102235	EM-000574	R&S	2025/01/13
loop antenna	HLA 6121	540046	EM-000546	TESEQ	2025/06/04
Broadband Antenna	VULB 9163	9163-530	EM-000342	SCHWARZBECK	2025/06/09
Constant temperature and humidity (high and low temperature) test chamber	LGH-80LA	LG20210902-A10	DZ-000328	/	2024/10/17
Temperature and humidity meter	MHO-C201	/	DZ-000249-2	Seconds test	2024/08/30
SuperCharge	HW-100400C01	/	/	HUAWEI	/

Dynacomm	Software Release	Software Developer
TS+ (5m,Radiation test)	JS32-RE 5.0.0	Tonscend

_____ The End _____

Important

1. The test report is invalid without the official stamp of CVC;
2. Any part photocopies of the test report are forbidden without the written permission from CVC;
3. The test report is invalid without the signatures of Author and Reviewer;
4. The test report is invalid if altered;
5. Objections to the test report must be submitted to CVC within 15 days;
6. Generally, commission test is responsible for the tested samples only;
7. As for the test result, “—” or “N” means “not applicable”, “ / ”means “not testing”, “P” means “pass” and “F” means “fail”.

Address: No.3,Tiantaiyi Road, Kaitai Avenue, Science City, Guangzhou, China (Test location)

Post Code: 510663 Tel: 020-32293888

FAX: 020 32293889 E-mail: office@cvc.org.cn