

FCC SAR Test Report

APPLICANT : FCNT LLC.
EQUIPMENT : Mobile cellular phone
BRAND NAME : arrows We2
MODEL NAME : A402FC
FCC ID : 2BEPUFMP200
STANDARD : FCC 47 CFR Part 2 (2.1093)

We, Sporton International Inc. (Kunshan), would like to declare that the tested sample has been evaluated in accordance with the test procedures given in 47 CFR Part 2.1093 and FCC KDB and has been in compliance with the applicable technical standards.

The test results in this report apply exclusively to the tested model / sample. Without written approval of Sporton International Inc. (Kunshan), the test report shall not be reproduced except in full.



Approved by: Si Zhang

Sporton International Inc. (Kunshan)

No. 1098, Pengxi North Road, Kunshan Economic Development Zone Jiangsu Province 215300
People's Republic of China



Table of Contents

1. Statement of Compliance 4
2. Administration Data 5
3. Data Reuse Approach 6
3.1 Introduction Section 6
3.2 Model Difference Information 6
3.3 Reference detail Section 6
4. Guidance Applied 7
5. Equipment Under Test (EUT) Information 8
5.1 General Information 8
5.2 General LTE SAR Test and Reporting Considerations 10
5.3 General 5G NR SAR Test and Reporting Considerations 12
6. RF Exposure Limits 13
6.1 Uncontrolled Environment 13
6.2 Controlled Environment 13
7. Specific Absorption Rate (SAR) 14
7.1 Introduction 14
7.2 SAR Definition 14
8. System Description and Setup 15
8.1 E-Field Probe 16
8.2 Data Acquisition Electronics (DAE) 16
8.3 Phantom 17
8.4 Device Holder 18
9. Measurement Procedures 19
9.1 Spatial Peak SAR Evaluation 19
9.2 Power Reference Measurement 20
9.3 Area Scan 20
9.4 Zoom Scan 21
9.5 Volume Scan Procedures 21
9.6 Power Drift Monitoring 21
10. Test Equipment List 22
11. System Verification 23
11.1 Tissue Simulating Liquids 23
11.2 Tissue Verification 23
11.3 System Performance Check Results 24
12. RF Exposure Positions 26
12.1 Ear and handset reference point 26
12.2 Definition of the cheek position 27
12.3 Definition of the tilt position 28
12.4 Body Worn Accessory 29
12.5 Product Specific 10g SAR Exposure 30
12.6 Wireless Router 30
13. Conducted RF Output Power (Unit: dBm) 31
14. Antenna Location 41
15. SAR Test Results 42
15.1 Head SAR 44
15.2 Hotspot SAR 46
15.3 Body Worn Accessory SAR 49
15.4 Product Specific SAR 51
15.5 Repeated SAR Measurement 51
16. Simultaneous Transmission Analysis 52
16.1 Head Exposure Conditions 53
16.2 Hotspot Exposure Conditions 54
16.3 Body-Worn Accessory Exposure Conditions 56
16.4 Product Specific Exposure Conditions 57
16.5 SPLSR Evaluation and Analysis 58
17. Uncertainty Assessment 63
18. References 64
Appendix A. Plots of System Performance Check
Appendix B. Plots of High SAR Measurement
Appendix C. DASy Calibration Certificate
Appendix D. Test Setup Photos
Appendix E. Conducted RF Output Power Table



1. Statement of Compliance

The maximum results of Specific Absorption Rate (SAR) found during testing for **FCNT LLC., Mobile cellular phone, A402FC**, are as follows.

Highest 1g SAR Summary						
Equipment Class	Frequency Band		Head (Separation 0mm)	Hotspot (Separation 5mm)	Body-worn (Separation 5mm)	Highest Simultaneous Transmission 1g SAR (W/kg)
			1g SAR (W/kg)			
Licensed	GSM	GSM850	0.36	0.60	0.60	1.59
		GSM1900	0.27	0.79	0.79	
	WCDMA	Band V	0.33	0.88	0.88	
		Band IV	0.12	0.86	0.86	
		WCDMA II	0.13	0.88	0.88	
	LTE	LTE Band 2	0.13	0.66	0.66	
		LTE Band 4	<0.10	0.61	0.61	
		LTE Band 5	0.35	0.94	0.94	
		LTE Band 12	0.22	0.54	0.54	
		LTE Band 38	<0.10	0.87	0.87	
		LTE Band 41	<0.10	0.81	0.81	
		LTE Band 42	<0.10	0.43	0.43	
	FR1	FR1 n41	<0.10	1.18	1.18	
FR1 n77/n78		<0.10	0.55	0.55		
DTS	WLAN	2.4GHz WLAN	0.35	0.37	0.23	1.18
NII		5GHz WLAN	0.19	0.94	0.94	1.59
DSS	Bluetooth	2.4GHz Bluetooth	0.28	0.51	0.29	1.59

Highest 10g SAR Summary				
Equipment Class	Frequency Band		Product Specific 10g SAR (W/kg) (Separation 0mm)	Highest Simultaneous Transmission 10g SAR (W/kg)
NII	WLAN	5GHz WLAN	0.66	0.68

Date of Testing: 2024/5/22 ~ 2024/7/29

Remark: This device supports 5GNR n78 and 5GNR n77. Since the supported frequency span for 5GNR n78 falls completely within the supports frequency span for 5GNR n77, both 5GNR bands have the same target power, and both 5GNR bands share the same transmission path; therefore, SAR was only assessed for 5GNR n77.

Declaration of Conformity:

The test results with all measurement uncertainty excluded are presented in accordance with the regulation limits or requirements declared by manufacturers.

Comments and Explanations:

The declared of product specification for EUT presented in the report are provided by the manufacturer, and the manufacturer takes all the responsibilities for the accuracy of product specification.

This device is in compliance with Specific Absorption Rate (SAR) for general population/uncontrolled exposure limits (1.6 W/kg for Partial-Body 1g SAR, 4.0 W/kg for Product Specific 10g SAR) specified in FCC 47 CFR part 2 (2.1093) and ANSI/IEEE C95.1-1992, and had been tested in accordance with the measurement methods and procedures specified in IEEE 1528-2013 and FCC KDB publications.

2. Administration Data

Sporton International Inc. (Kunshan) is accredited to ISO/IEC 17025:2017 by American Association for Laboratory Accreditation with Certificate Number 5145.02.

Testing Laboratory			
Test Firm	Sporton International Inc. (Kunshan)		
Test Site Location	No. 1098, Pengxi North Road, Kunshan Economic Development Zone Jiangsu Province 215300 People's Republic of China TEL : +86-512-57900158		
Test Site No.	Sporton Site No.	FCC Designation No.	FCC Test Firm Registration No.
	SAR02-KS	CN1257	314309

Applicant	
Company Name	FCNT LLC.
Address	Sanki Yamato Bldg. 3F, 7-10-1, Chuorinkan, Yamato-shi, Kanagawa, 242-0007, Japan

Manufacturer	
Company Name	FCNT LLC.
Address	Sanki Yamato Bldg. 3F, 7-10-1, Chuorinkan, Yamato-shi, Kanagawa, 242-0007, Japan

3. Data Reuse Approach

3.1 Introduction Section

This application re-uses data collected on a similar device, FCC ID: 2BEPUFMP195 (reference model) and FCC ID: 2BEPUFMP200 (variant model). Due to the same design are identical between parent model and variant model, SAR data reuse is requested and spot check data in this report is used to justify the SAR data reuse.

Per KDB 484596 D01 v02r03, the deviation of variant model 1g SAR and 10g SAR spot check result was no larger than 3 dB, and 1g SAR < 1.2W/kg, 10g SAR < 3.0W/kg of the reference model, the WWAN/WLAN/BT max SAR summary are identical with parent model/ was always choose the higher SAR between parent model and variant model.

The applicant should take full responsibility that the test data as referenced in this report represent compliance for this FCC ID: 2BEPUFMP200

3.2 Model Difference Information

The **main** difference between FCC ID: 2BEPUFMP195 and FCC ID: 2BEPUFMP200 is as below:

- Remove LTE B39 and 5G NR n79;
- Add WCDMA II/IV/VIII, LTE Band 2/4/38 and 5GNR n3/n41;
- Change PA for 5G NR n77/n78.

Other differences and all the details of similarity and difference can be found in the confidential documents (A402FC_Operational Description of Product Equality Declaration).

3.3 Reference detail Section

Rule Part	Equipment Class	Wireless Technology	Frequency Band (MHz)	FCC ID (Reference)	Type Grant/ Permissive Change	Reference Title	FCC ID Filling (Variant)	Test on the variant
Part 2.1093	PCE	GSM	GSM850/1900	2BEPUFMP195	Original Grant	FA3D0613-04	2BEPUFMP200	Spot check
		WCDMA	B5	2BEPUFMP195	Original Grant	FA3D0613-04	2BEPUFMP200	Spot check
		WCDMA	B4				2BEPUFMP200	Full Test
		WCDMA	B2				2BEPUFMP200	Full Test
		LTE	B5/12/41/42	2BEPUFMP195	Original Grant	FA3D0613-04	2BEPUFMP200	Spot check
		LTE	B2/4/38				2BEPUFMP200	Full Test
		5GNR FR1	n41/ n77/78				2BEPUFMP200	Full Test
	DTS	BLE/ WiFi	2400~2483.5	2BEPUFMP195	Original Grant	FA3D0613-04	2BEPUFMP200	Spot check
	NII	Wi-Fi	5150 ~ 5250 5250 ~ 5350 5470 ~ 5725 5725 ~ 5850	2BEPUFMP195	Original Grant	FA3D0613-04	2BEPUFMP200	Spot check
	DSS	Bluetooth	2400~2483.5	2BEPUFMP195	Original Grant	FA3D0613-04	2BEPUFMP200	Spot check
DXX	NFC	13.56				2BEPUFMP200	Full Test	



4. Guidance Applied

The Specific Absorption Rate (SAR) testing specification, method, and procedure for this device is in accordance with the following standards:

- FCC 47 CFR Part 2 (2.1093)
- ANSI/IEEE C95.1-1992
- IEEE 1528-2013
- FCC KDB 865664 D01 SAR Measurement 100 MHz to 6 GHz v01r04
- FCC KDB 865664 D02 SAR Reporting v01r02
- FCC KDB 447498 D01 General RF Exposure Guidance v06
- FCC KDB 648474 D04 SAR Evaluation Considerations for Wireless Handsets v01r03
- FCC KDB 248227 D01 802.11 Wi-Fi SAR v02r02
- FCC KDB 941225 D01 3G SAR Procedures v03r01
- FCC KDB 941225 D05 SAR for LTE Devices v02r05
- FCC KDB 941225 D05A Rel.10 LTE SAR Test Guidance v01r02
- FCC KDB 941225 D06 Hotspot Mode SAR v02r01
- FCC KDB 484596 D01 Referencing Test Data v02r03

5. Equipment Under Test (EUT) Information

5.1 General Information

Product Feature & Specification	
Equipment Name	Mobile cellular phone
Brand Name	arrows We2
Model Name	A402FC
FCC ID	2BEPUFMP200
IMEI Code	Sample 1 IMEI 1: 355117620005069 IMEI 2: 355117620005077 Sample 2: IMEI 1: 355117620018849 IMEI 2: 355117620018856
Wireless Technology and Frequency Range	GSM850: 824 MHz ~ 849 MHz GSM1900: 1850 MHz ~ 1910 MHz WCDMA Band V: 824 MHz ~ 849 MHz WCDMA Band II: 1850 MHz ~ 1910 MHz WCDMA Band IV: 1710 MHz ~ 1755 MHz LTE Band 4: 1710 MHz ~ 1755 MHz LTE Band 2: 1850 MHz ~ 1910 MHz LTE Band 4: 1710 MHz ~ 1755 MHz LTE Band 5: 824 MHz ~ 849 MHz LTE Band 12: 699 MHz ~ 716 MHz LTE Band 38: 2570 MHz ~ 2620 MHz LTE Band 41: 2496 MHz ~ 2690 MHz LTE Band 42: 3450 MHz ~ 3550 MHz 5G NR n41: 2496 MHz ~ 2690 MHz 5G NR n77: 3450 MHz ~ 3550 MHz, 3700 MHz ~ 3980 MHz 5G NR n78: 3450 MHz ~ 3550 MHz, 3700 MHz ~ 3800 MHz WLAN 2.4GHz Band: 2412 MHz ~ 2462 MHz WLAN 5.2GHz Band: 5180 MHz ~ 5240 MHz WLAN 5.3GHz Band: 5260 MHz ~ 5320 MHz WLAN 5.5GHz Band: 5500 MHz ~ 5720 MHz WLAN 5.8GHz Band: 5745 MHz ~ 5825 MHz Bluetooth: 2402 MHz ~ 2480 MHz NFC: 13.56 MHz
Mode	GSM/GPRS RMC/AMR 12.2Kbps HSDPA/HSUPA DC-HSDPA HSPA+ (16QAM uplink is supported) LTE: QPSK, 16QAM, 64QAM 5G NR: CP-OFDM / DFT-s-OFDM, PI/2 BPSK, QPSK, 16QAM, 64QAM, 256QAM WLAN 2.4GHz 802.11b/g/n HT20/HT40 WLAN 5GHz 802.11a/n HT20/HT40 WLAN 5GHz 802.11ac VHT20/VHT40/VHT80 Bluetooth BR/EDR/LE NFC: ASK
HW Version	V4
SW Version	sys_mssi_yamato-userdebug 14 UP1A.231005.007 37 release-keys
GSM / (E)GPRS Transfer mode	Class B – EUT cannot support Packet Switched and Circuit Switched Network simultaneously but can automatically switch between Packet and Circuit Switched Network.
EUT Stage	Identical Prototype
Remark:	<ol style="list-style-type: none"> This device supports VoIP in GPRS, WCDMA, LTE and 5GNR (e.g. for 3rd-party VoIP), LTE supports VoLTE operation. This device 2.4GHz WLAN support hotspot operation and Bluetooth support tethering applications.



3. This device 5.2GHz WLAN/5.8GHz WLAN support hotspot operation, and 5.2GHz WLAN/5.8GHz WLAN supports WiFi Direct (GC/GO), and 5.3GHz / 5.5GHz supports WiFi Direct (GC only).
4. This device does not support DTM operation and supports GPRS mode up to multi-slot class 12.
5. For dual SIM card mobile has two SIM slots and supports dual SIM dual standby. The WWAN radio transmission will be enabled by either one SIM at a time (single active).
6. There are three samples. The difference between them could be referred to the A402FC_Operational Description of Product Equality Declaration which is exhibited separately. According to the difference, sample 1 was chosen to perform full SAR testing and sample 2 verified the worst case of sample 1. For sample3, the differences do not affect the test, so sample 3 are not tested.
7. For 5G NR test, using FTM (Factory Test Mode) to perform SAR with default 100% transmission.
8. For 5G NR EN-DC mode, standalone SAR performed for 5G NR NSA band with the maximum power, EN-DC SAR summed EN-DC mode 5G NR standalone SAR and LTE standalone SAR, the result of EN-DC SAR is more conservatively.
9. This device has NFC function and the NFC SAR report will be separately submitted.
10. This device supports 5G NR FR1 bands as following table, including NSA mode.

<5G NR>

Mode	Band	Duplex	SCS(KHz)	Bandwidths(BW)
NSA	n77	TDD	30	20, 40, 100
	n78	TDD	30	20, 40, 80, 100
SA	n41	TDD	30	20, 30
	n77	TDD	30	20, 40, 100
	n78	TDD	30	20, 40, 80, 100

5.2 General LTE SAR Test and Reporting Considerations

Summarized necessary items addressed in KDB 941225 D05 v02r05																																																															
FCC ID	2BEPUFMP200																																																														
Equipment Name	Mobile cellular phone																																																														
Operating Frequency Range of each LTE transmission band	LTE Band 2: 1850 MHz ~ 1910 MHz LTE Band 4: 1710 MHz ~ 1755 MHz LTE Band 5: 824 MHz ~ 849 MHz LTE Band 12: 699 MHz ~ 716 MHz LTE Band 38: 2570 MHz ~ 2620 MHz LTE Band 41: 2496 MHz ~ 2690 MHz LTE Band 42: 3450 MHz ~ 3550 MHz																																																														
Channel Bandwidth	LTE Band 2: 1.4MHz, 3MHz, 5MHz, 10MHz, 15MHz, 20MHz LTE Band 4: 1.4MHz, 3MHz, 5MHz, 10MHz, 15MHz, 20MHz LTE Band 5: 1.4MHz, 3MHz, 5MHz, 10MHz LTE Band 12: 1.4MHz, 3MHz, 5MHz, 10MHz LTE Band 38: 5MHz, 10MHz, 15MHz, 20MHz LTE Band 41: 5MHz, 10MHz, 15MHz, 20MHz LTE Band 42: 5MHz, 10MHz, 15MHz, 20MHz																																																														
uplink modulations used	QPSK / 16QAM / 64QAM																																																														
LTE Voice / Data requirements	Voice and Data																																																														
LTE Release Version	R15, Cat5																																																														
CA Support	Yes, Downlink only																																																														
LTE MPR permanently built-in by design	<p>Table 6.2.3-1: Maximum Power Reduction (MPR) for Power Class 1, 2 and 3</p> <table border="1"> <thead> <tr> <th rowspan="2">Modulation</th> <th colspan="6">Channel bandwidth / Transmission bandwidth (N_{RB})</th> <th rowspan="2">MPR (dB)</th> </tr> <tr> <th>1.4 MHz</th> <th>3.0 MHz</th> <th>5 MHz</th> <th>10 MHz</th> <th>15 MHz</th> <th>20 MHz</th> </tr> </thead> <tbody> <tr> <td>QPSK</td> <td>> 5</td> <td>> 4</td> <td>> 8</td> <td>> 12</td> <td>> 16</td> <td>> 18</td> <td>≤ 1</td> </tr> <tr> <td>16 QAM</td> <td>≤ 5</td> <td>≤ 4</td> <td>≤ 8</td> <td>≤ 12</td> <td>≤ 16</td> <td>≤ 18</td> <td>≤ 1</td> </tr> <tr> <td>16 QAM</td> <td>> 5</td> <td>> 4</td> <td>> 8</td> <td>> 12</td> <td>> 16</td> <td>> 18</td> <td>≤ 2</td> </tr> <tr> <td>64 QAM</td> <td>≤ 5</td> <td>≤ 4</td> <td>≤ 8</td> <td>≤ 12</td> <td>≤ 16</td> <td>≤ 18</td> <td>≤ 2</td> </tr> <tr> <td>64 QAM</td> <td>> 5</td> <td>> 4</td> <td>> 8</td> <td>> 12</td> <td>> 16</td> <td>> 18</td> <td>≤ 3</td> </tr> <tr> <td>256 QAM</td> <td colspan="6">≥ 1</td> <td>≤ 5</td> </tr> </tbody> </table>	Modulation	Channel bandwidth / Transmission bandwidth (N_{RB})						MPR (dB)	1.4 MHz	3.0 MHz	5 MHz	10 MHz	15 MHz	20 MHz	QPSK	> 5	> 4	> 8	> 12	> 16	> 18	≤ 1	16 QAM	≤ 5	≤ 4	≤ 8	≤ 12	≤ 16	≤ 18	≤ 1	16 QAM	> 5	> 4	> 8	> 12	> 16	> 18	≤ 2	64 QAM	≤ 5	≤ 4	≤ 8	≤ 12	≤ 16	≤ 18	≤ 2	64 QAM	> 5	> 4	> 8	> 12	> 16	> 18	≤ 3	256 QAM	≥ 1						≤ 5
Modulation	Channel bandwidth / Transmission bandwidth (N_{RB})						MPR (dB)																																																								
	1.4 MHz	3.0 MHz	5 MHz	10 MHz	15 MHz	20 MHz																																																									
QPSK	> 5	> 4	> 8	> 12	> 16	> 18	≤ 1																																																								
16 QAM	≤ 5	≤ 4	≤ 8	≤ 12	≤ 16	≤ 18	≤ 1																																																								
16 QAM	> 5	> 4	> 8	> 12	> 16	> 18	≤ 2																																																								
64 QAM	≤ 5	≤ 4	≤ 8	≤ 12	≤ 16	≤ 18	≤ 2																																																								
64 QAM	> 5	> 4	> 8	> 12	> 16	> 18	≤ 3																																																								
256 QAM	≥ 1						≤ 5																																																								
LTE A-MPR	In the base station simulator configuration, Network Setting value is set to NS_01 to disable A-MPR during SAR testing and the LTE SAR tests was transmitting on all TTI frames (Maximum TTI)																																																														
Spectrum plots for RB configuration	A properly configured base station simulator was used for the SAR and power measurement; therefore, spectrum plots for each RB allocation and offset configuration are not included in the SAR report.																																																														
LTE Carrier Aggregation Combinations	Intra-Band and Inter-Band possible combinations and the detail power verification please referred to section 13.																																																														
LTE Carrier Aggregation Additional Information	This device supports maximum of 3 carriers in the downlink. Additional following LTE Release features are not supported: Relay, HetNet, Enhanced MIMO, eICI, WiFi Offloading, MDH, eMBMA, Cross-Carrier Scheduling, Enhanced SC-FDMA.																																																														



Transmission (H, M, L) channel numbers and frequencies in each LTE band												
LTE Band 2												
	Bandwidth 1.4 MHz		Bandwidth 3 MHz		Bandwidth 5 MHz		Bandwidth 10 MHz		Bandwidth 15 MHz		Bandwidth 20 MHz	
	Ch. #	Freq. (MHz)	Ch. #	Freq. (MHz)	Ch. #	Freq. (MHz)	Ch. #	Freq. (MHz)	Ch. #	Freq. (MHz)	Ch. #	Freq. (MHz)
L	18607	1850.7	18615	1851.5	18625	1852.5	18650	1855	18675	1857.5	18700	1860
M	18900	1880	18900	1880	18900	1880	18900	1880	18900	1880	18900	1880
H	19193	1909.3	19185	1908.5	19175	1907.5	19150	1905	19125	1902.5	19100	1900
LTE Band 4												
	Bandwidth 1.4 MHz		Bandwidth 3 MHz		Bandwidth 5 MHz		Bandwidth 10 MHz		Bandwidth 15 MHz		Bandwidth 20 MHz	
	Ch. #	Freq. (MHz)	Ch. #	Freq. (MHz)	Ch. #	Freq. (MHz)	Ch. #	Freq. (MHz)	Ch. #	Freq. (MHz)	Ch. #	Freq. (MHz)
L	19957	1710.7	19965	1711.5	19975	1712.5	20000	1715	20025	1717.5	20050	1720
M	20175	1732.5	20175	1732.5	20175	1732.5	20175	1732.5	20175	1732.5	20175	1732.5
H	20393	1754.3	20385	1753.5	20375	1752.5	20350	1750	20325	1747.5	20300	1745
LTE Band 5												
	Bandwidth 1.4 MHz		Bandwidth 3 MHz		Bandwidth 5 MHz		Bandwidth 10 MHz					
	Ch. #	Freq. (MHz)	Ch. #	Freq. (MHz)	Ch. #	Freq. (MHz)	Ch. #	Freq. (MHz)	Ch. #	Freq. (MHz)	Ch. #	Freq. (MHz)
L	20407	824.7	20415	825.5	20425	826.5	20450	829				
M	20525	836.5	20525	836.5	20525	836.5	20525	836.5	20525	836.5	20525	836.5
H	20643	848.3	20635	847.5	20625	846.5	20600	844				
LTE Band 12												
	Bandwidth 1.4 MHz		Bandwidth 3 MHz		Bandwidth 5 MHz		Bandwidth 10 MHz					
	Ch. #	Freq. (MHz)	Ch. #	Freq. (MHz)	Ch. #	Freq. (MHz)	Ch. #	Freq. (MHz)	Ch. #	Freq. (MHz)	Ch. #	Freq. (MHz)
L	23017	699.7	23025	700.5	23035	701.5	23060	704				
M	23095	707.5	23095	707.5	23095	707.5	23095	707.5	23095	707.5	23095	707.5
H	23173	715.3	23165	714.5	23155	713.5	23130	711				
LTE Band 38												
	Bandwidth 5 MHz		Bandwidth 10 MHz		Bandwidth 15 MHz		Bandwidth 20 MHz					
	Ch. #	Freq. (MHz)	Ch. #	Freq. (MHz)	Ch. #	Freq. (MHz)	Ch. #	Freq. (MHz)	Ch. #	Freq. (MHz)	Ch. #	Freq. (MHz)
L	37775	2572.5	37800	2575	37825	2577.5	37850	2580				
M	38000	2595	38000	2595	38000	2595	38000	2595	38000	2595	38000	2595
H	38225	2617.5	38200	2615	38175	2612.5	38150	2610				
LTE Band 41												
	Bandwidth 5 MHz		Bandwidth 10 MHz		Bandwidth 15 MHz		Bandwidth 20 MHz					
	Ch. #	Freq. (MHz)	Ch. #	Freq. (MHz)	Ch. #	Freq. (MHz)	Ch. #	Freq. (MHz)	Ch. #	Freq. (MHz)	Ch. #	Freq. (MHz)
L	39675	2498.5	39700	2501	39725	2503.5	39750	2506				
LM	40148	2545.8	40160	2547	40173	2548.3	40185	2549.5				
M	40620	2593	40620	2593	40620	2593	40620	2593	40620	2593	40620	2593
HM	41093	2640.3	41080	2639	41068	2637.8	41055	2636.5				
H	41565	2687.5	41540	2685	41515	2682.5	41490	2680				
LTE Band 42												
	Bandwidth 5 MHz		Bandwidth 10 MHz		Bandwidth 15 MHz		Bandwidth 20 MHz					
	Ch. #	Freq. (MHz)	Ch. #	Freq. (MHz)	Ch. #	Freq. (MHz)	Ch. #	Freq. (MHz)	Ch. #	Freq. (MHz)	Ch. #	Freq. (MHz)
L	42115	3452.5	42140	3455	42165	3457.5	42190	3460				
M	42590	3500	42590	3500	42590	3500	42590	3500	42590	3500	42590	3500
H	43065	3547.5	43040	3545	43015	3542.5	42990	3540				



5.3 General 5G NR SAR Test and Reporting Considerations

5G NR Information	
Operating Frequency Range of each 5G NR transmission band	5G NR n41: 2496 MHz ~ 2690 MHz 5G NR n77: 3450 MHz ~ 3550 MHz, 3700 MHz ~ 3980 MHz 5G NR n78: 3450 MHz ~ 3550 MHz, 3700 MHz ~ 3800 MHz
Channel Bandwidth	The detail please refers to section 5.1 5GNR FR1 bands table.
SCS	TDD: SCS30KHz
uplink modulations used	DFT-s-OFDM: PI/2 BPSK / QPSK / 16QAM / 64QAM / 256QAM CP-OFDM QPSK / 16QAM / 64QAM / 256QAM
A-MPR (Additional MPR) disabled for SAR Testing?	Yes
LTE Anchor Bands for n77	LTE B41
LTE Anchor Bands for n78	LTE B41

NR Band 41 SCS30KHz				
	Bandwidth 20MHz		Bandwidth 30MHz	
	Ch. #	Freq. (MHz)	Ch. #	Freq. (MHz)
L	501204	2506.02	502200	2511
M	518598	2592.99	518598	2592.99
H	535998	2679.99	534996	2674.98

NR Band 77 SCS30KHz						
	Bandwidth 20MHz		Bandwidth 40MHz		Bandwidth 100MHz	
	Ch. #	Freq. (MHz)	Ch. #	Freq. (MHz)	Ch. #	Freq. (MHz)
L	647334	3710.01	648000	3720	650000	3750
M	656000	3840	656000	3840	656000	3840
H	664668	3970.02	664000	3960	662000	3930

NR Band 78 SCS30KHz								
	Bandwidth 20MHz		Bandwidth 40MHz		Bandwidth 80MHz		Bandwidth 100MHz	
	Ch. #	Freq. (MHz)	Ch. #	Freq. (MHz)	Ch. #	Freq. (MHz)	Ch. #	Freq. (MHz)
L	647334	3710.01	648000	3720	649334	3740.01		
M	650000	3750	650000	3750	650000	3750	650000	3750
H	652668	3790.02	652000	3780	650668	3760.02		

For <3450 MHz ~ 3550 MHz >

NR Band 77 SCS30KHz						
	Bandwidth 20MHz		Bandwidth 40MHz		Bandwidth 100MHz	
	Ch. #	Freq. (MHz)	Ch. #	Freq. (MHz)	Ch. #	Freq. (MHz)
L	630668	3460.02	631334	3470.01		
M	633332	3499.98	633332	3499.98	633332	3499.98
H	636000	3540	635332	3529.98		

NR Band 78 SCS30KHz								
	Bandwidth 20MHz		Bandwidth 40MHz		Bandwidth 80MHz		Bandwidth 100MHz	
	Ch. #	Freq. (MHz)	Ch. #	Freq. (MHz)	Ch. #	Freq. (MHz)	Ch. #	Freq. (MHz)
L	630668	3460.02	631334	3470.01	632668	3490.02		
M	633334	3500.01	633334	3500.01	633334	3500.01	633334	3500.01
H	636000	3540	635334	3530.01	634000	3510		

<For NR Overlap Bands Description>

1) NR Bands BW

Band	5 MHz	10 MHz	15 MHz	20 MHz	25 MHz	30 MHz	35 MHz	40 MHz	45 MHz	50 MHz	60 MHz	70 MHz	80 MHz	90 MHz	100 MHz
FR1 n77				Yes				Yes							Yes
FR1 n78				Yes				Yes					Yes		Yes

2) NR Bands Tune up:

Band	Antenna	Head Tune-up Limit	Body-worn Tune-up Limit	Hotspot Tune-up Limit	Extremity Tune-up Limit	Default Tune-up Limit
5G NR n77	Ant 0	17.0	17.0	17.0	17.0	17.0
5G NR n78	Ant 0	17.0	17.0	17.0	17.0	17.0

6. RF Exposure Limits

6.1 Uncontrolled Environment

Uncontrolled Environments are defined as locations where there is the exposure of individuals who have no knowledge or control of their exposure. The general population/uncontrolled exposure limits are applicable to situations in which the general public may be exposed or in which persons who are exposed as a consequence of their employment may not be made fully aware of the potential for exposure or cannot exercise control over their exposure. Members of the general public would come under this category when exposure is not employment-related; for example, in the case of a wireless transmitter that exposes persons in its vicinity.

6.2 Controlled Environment

Controlled Environments are defined as locations where there is exposure that may be incurred by persons who are aware of the potential for exposure, (i.e. as a result of employment or occupation). In general, occupational/controlled exposure limits are applicable to situations in which persons are exposed as a consequence of their employment, who have been made fully aware of the potential for exposure and can exercise control over their exposure. The exposure category is also applicable when the exposure is of a transient nature due to incidental passage through a location where the exposure levels may be higher than the general population/uncontrolled limits, but the exposed person is fully aware of the potential for exposure and can exercise control over his or her exposure by leaving the area or by some other appropriate means.

Limits for Occupational/Controlled Exposure (W/kg)

Whole-Body	Partial-Body	Hands, Wrists, Feet and Ankles
0.4	8.0	20.0

Limits for General Population/Uncontrolled Exposure (W/kg)

Whole-Body	Partial-Body	Hands, Wrists, Feet and Ankles
0.08	1.6	4.0

Whole-Body SAR is averaged over the entire body, partial-body SAR is averaged over any 1gram of tissue defined as a tissue volume in the shape of a cube. SAR for hands, wrists, feet and ankles is averaged over any 10 grams of tissue defined as a tissue volume in the shape of a cube.

7. Specific Absorption Rate (SAR)

7.1 Introduction

SAR is related to the rate at which energy is absorbed per unit mass in an object exposed to a radio field. The SAR distribution in a biological body is complicated and is usually carried out by experimental techniques or numerical modeling. The standard recommends limits for two tiers of groups, occupational/controlled and general population/uncontrolled, based on a person's awareness and ability to exercise control over his or her exposure. In general, occupational/controlled exposure limits are higher than the limits for general population/uncontrolled.

7.2 SAR Definition

The SAR definition is the time derivative (rate) of the incremental energy (dW) absorbed by (dissipated in) an incremental mass (dm) contained in a volume element (dv) of a given density (ρ). The equation description is as below:

$$\text{SAR} = \frac{d}{dt} \left(\frac{dW}{dm} \right) = \frac{d}{dt} \left(\frac{dW}{\rho dv} \right)$$

SAR is expressed in units of Watts per kilogram (W/kg)

$$\text{SAR} = \frac{\sigma |E|^2}{\rho}$$

Where: σ is the conductivity of the tissue, ρ is the mass density of the tissue and E is the RMS electrical field strength.

8. System Description and Setup

The DASY system used for performing compliance tests consists of the following items:

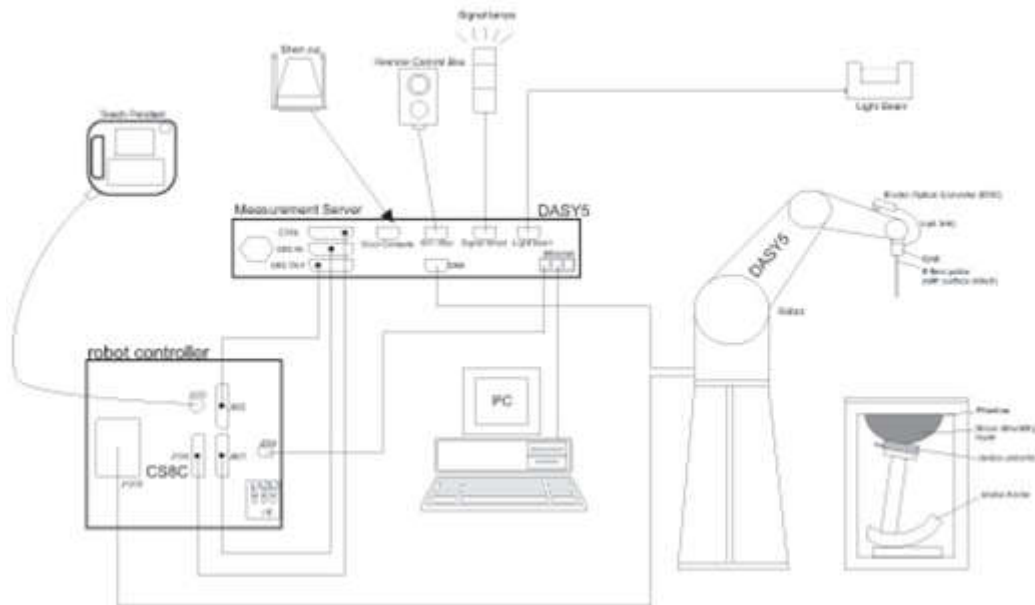

- A standard high precision 6-axis robot with controller, teach pendant and software. An arm extension for accommodating the data acquisition electronics (DAE).
- An isotropic Field probe optimized and calibrated for the targeted measurement.
- A data acquisition electronics (DAE) which performs the signal amplification, signal multiplexing, AD-conversion, offset measurements, mechanical surface detection, collision detection, etc. The unit is battery powered with standard or rechargeable batteries. The signal is optically transmitted to the EOC.
- The Electro-optical converter (EOC) performs the conversion from optical to electrical signals for the digital communication to the DAE. To use optical surface detection, a special version of the EOC is required. The EOC signal is transmitted to the measurement server.
- The function of the measurement server is to perform the time critical tasks such as signal filtering, control of the robot operation and fast movement interrupts.
- The Light Beam used is for probe alignment. This improves the (absolute) accuracy of the probe positioning.
- A computer running WinXP or Win7 and the DASY5 software.
- Remote control and teach pendant as well as additional circuitry for robot safety such as warning lamps, etc.
- The phantom, the device holder and other accessories according to the targeted measurement.

8.1 E-Field Probe

The SAR measurement is conducted with the dosimetric probe (manufactured by SPEAG).The probe is specially designed and calibrated for use in liquid with high permittivity. The dosimetric probe has special calibration in liquid at different frequency. This probe has a built in optical surface detection system to prevent from collision with phantom.

<EX3DV4 Probe>

Construction	Symmetric design with triangular core Built-in shielding against static charges PEEK enclosure material (resistant to organic solvents, e.g., DGBE)	
Frequency	4 MHz – 10 GHz Linearity: ±0.2 dB (30 MHz – 10 GHz)	
Directivity	±0.3 dB in TSL (rotation around probe axis) ±0.5 dB in TSL (rotation normal to probe axis)	
Dynamic Range	10 µW/g – >100 mW/g Linearity: ±0.2 dB (noise: typically <1 µW/g)	
Dimensions	Overall length: 337 mm (tip: 20 mm) Tip diameter: 2.5 mm (body: 12 mm) Typical distance from probe tip to dipole centers: 1 mm	

8.2 Data Acquisition Electronics (DAE)

The data acquisition electronics (DAE) consists of a highly sensitive electrometer-grade preamplifier with auto-zeroing, a channel and gain-switching multiplexer, a fast 16 bit AD-converter and a command decoder and control logic unit. Transmission to the measurement server is accomplished through an optical downlink for data and status information as well as an optical uplink for commands and the clock.

The input impedance of the DAE is 200 MOhm; the inputs are symmetrical and floating. Common mode rejection is above 80 dB.



Photo of DAE

8.3 Phantom

<SAM Twin Phantom>

Shell Thickness	2 ± 0.2 mm; Center ear point: 6 ± 0.2 mm	
Filling Volume	Approx. 25 liters	
Dimensions	Length: 1000 mm; Width: 500 mm; Height: adjustable feet	
Measurement Areas	Left Hand, Right Hand, Flat Phantom	

The bottom plate contains three pair of bolts for locking the device holder. The device holder positions are adjusted to the standard measurement positions in the three sections. A white cover is provided to tap the phantom during off-periods to prevent water evaporation and changes in the liquid parameters. On the phantom top, three reference markers are provided to identify the phantom position with respect to the robot.

<ELI Phantom>

Shell Thickness	2 ± 0.2 mm (sagging: <1%)	
Filling Volume	Approx. 30 liters	
Dimensions	Major ellipse axis: 600 mm Minor axis: 400 mm	

The ELI phantom is intended for compliance testing of handheld and body-mounted wireless devices or for evaluating transmitters operating at low frequencies. ELI is fully compatible with standard and all known tissue simulating liquids.

8.4 Device Holder

<Mounting Device for Hand-Held Transmitter>

In combination with the Twin SAM V5.0/V5.0c or ELI phantoms, the Mounting Device for Hand-Held Transmitters enables rotation of the mounted transmitter device to specified spherical coordinates. At the heads, the rotation axis is at the ear opening. Transmitter devices can be easily and accurately positioned according to IEC 62209-1, IEEE 1528, FCC, or other specifications. The device holder can be locked for positioning at different phantom sections (left head, right head, flat). And upgrade kit to Mounting Device to enable easy mounting of wider devices like big smart-phones, e-books, small tablets, etc. It holds devices with width up to 140 mm.



Mounting Device for Hand-Held Transmitters



Mounting Device Adaptor for Wide-Phones

<Mounting Device for Laptops and other Body-Worn Transmitters>

The extension is lightweight and made of POM, acrylic glass and foam. It fits easily on the upper part of the mounting device in place of the phone positioned. The extension is fully compatible with the SAM Twin and ELI phantoms.



Mounting Device for Laptops

9. Measurement Procedures

The measurement procedures are as follows:

<Conducted power measurement>

- (a) For WWAN power measurement, use base station simulator to configure EUT WWAN transmission in conducted connection with RF cable, at maximum power in each supported wireless interface and frequency band.
- (b) Read the WWAN RF power level from the base station simulator.
- (c) For WLAN/BT power measurement, use engineering software to configure EUT WLAN/BT continuously transmission, at maximum RF power in each supported wireless interface and frequency band
- (d) Connect EUT RF port through RF cable to the power meter, and measure WLAN/BT output power

<SAR measurement>

- (a) Use base station simulator to configure EUT WWAN transmission in radiated connection, and engineering software to configure EUT WLAN/BT continuously transmission, at maximum RF power, in the highest power channel.
- (b) Place the EUT in the positions as Appendix D demonstrates.
- (c) Set scan area, grid size and other setting on the DASY software.
- (d) Measure SAR results for the highest power channel on each testing position.
- (e) Find out the largest SAR result on these testing positions of each band
- (f) Measure SAR results for other channels in worst SAR testing position if the reported SAR of highest power channel is larger than 0.8 W/kg

According to the test standard, the recommended procedure for assessing the peak spatial-average SAR value consists of the following steps:

- (a) Power reference measurement
- (b) Area scan
- (c) Zoom scan
- (d) Power drift measurement

9.1 Spatial Peak SAR Evaluation

The procedure for spatial peak SAR evaluation has been implemented according to the test standard. It can be conducted for 1g and 10g, as well as for user-specific masses. The DASY software includes all numerical procedures necessary to evaluate the spatial peak SAR value.

The base for the evaluation is a "cube" measurement. The measured volume must include the 1g and 10g cubes with the highest averaged SAR values. For that purpose, the center of the measured volume is aligned to the interpolated peak SAR value of a previously performed area scan.

The entire evaluation of the spatial peak values is performed within the post-processing engine (SEMCAD). The system always gives the maximum values for the 1g and 10g cubes. The algorithm to find the cube with highest averaged SAR is divided into the following stages:

- (a) Extraction of the measured data (grid and values) from the Zoom Scan
- (b) Calculation of the SAR value at every measurement point based on all stored data (A/D values and measurement parameters)
- (c) Generation of a high-resolution mesh within the measured volume
- (d) Interpolation of all measured values from the measurement grid to the high-resolution grid
- (e) Extrapolation of the entire 3-D field distribution to the phantom surface over the distance from sensor to surface
- (f) Calculation of the averaged SAR within masses of 1g and 10g

9.2 Power Reference Measurement

The Power Reference Measurement and Power Drift Measurements are for monitoring the power drift of the device under test in the batch process. The minimum distance of probe sensors to surface determines the closest measurement point to phantom surface. This distance cannot be smaller than the distance of sensor calibration points to probe tip as defined in the probe properties.

9.3 Area Scan

The area scan is used as a fast scan in two dimensions to find the area of high field values, before doing a fine measurement around the hot spot. The sophisticated interpolation routines implemented in DASY software can find the maximum found in the scanned area, within a range of the global maximum. The range (in dB0 is specified in the standards for compliance testing. For example, a 2 dB range is required in IEEE standard 1528 and IEC 62209 standards, whereby 3 dB is a requirement when compliance is assessed in accordance with the ARIB standard (Japan), if only one zoom scan follows the area scan, then only the absolute maximum will be taken as reference. For cases where multiple maximums are detected, the number of zoom scans has to be increased accordingly.

Area scan parameters extracted from FCC KDB 865664 D01v01r04 SAR measurement 100 MHz to 6 GHz.

	≤ 3 GHz	> 3 GHz
Maximum distance from closest measurement point (geometric center of probe sensors) to phantom surface	5 ± 1 mm	$\frac{1}{2} \cdot \delta \cdot \ln(2) \pm 0.5$ mm
Maximum probe angle from probe axis to phantom surface normal at the measurement location	$30^\circ \pm 1^\circ$	$20^\circ \pm 1^\circ$
Maximum area scan spatial resolution: $\Delta x_{Area}, \Delta y_{Area}$	≤ 2 GHz: ≤ 15 mm $2 - 3$ GHz: ≤ 12 mm	$3 - 4$ GHz: ≤ 12 mm $4 - 6$ GHz: ≤ 10 mm
	When the x or y dimension of the test device, in the measurement plane orientation, is smaller than the above, the measurement resolution must be \leq the corresponding x or y dimension of the test device with at least one measurement point on the test device.	

9.4 Zoom Scan

Zoom scans are used to assess the peak spatial SAR values within a cubic averaging volume containing 1 gram and 10 gram of simulated tissue. The zoom scan measures points (refer to table below) within a cube whose base faces are centered on the maxima found in a preceding area scan job within the same procedure. When the measurement is done, the zoom scan evaluates the averaged SAR for 1 gram and 10 gram and displays these values next to the job's label.

Zoom scan parameters extracted from FCC KDB 865664 D01v01r04 SAR measurement 100 MHz to 6 GHz.

		≤ 3 GHz	> 3 GHz
Maximum zoom scan spatial resolution: Δx_{Zoom} , Δy_{Zoom}		≤ 2 GHz: ≤ 8 mm 2 – 3 GHz: ≤ 5 mm*	3 – 4 GHz: ≤ 5 mm* 4 – 6 GHz: ≤ 4 mm*
Maximum zoom scan spatial resolution, normal to phantom surface	uniform grid: $\Delta z_{Zoom}(n)$	≤ 5 mm	3 – 4 GHz: ≤ 4 mm 4 – 5 GHz: ≤ 3 mm 5 – 6 GHz: ≤ 2 mm
	graded grid	$\Delta z_{Zoom}(1)$: between 1 st two points closest to phantom surface	≤ 4 mm
		$\Delta z_{Zoom}(n>1)$: between subsequent points	$\leq 1.5 \cdot \Delta z_{Zoom}(n-1)$
Minimum zoom scan volume	x, y, z	≥ 30 mm	3 – 4 GHz: ≥ 28 mm 4 – 5 GHz: ≥ 25 mm 5 – 6 GHz: ≥ 22 mm
Note: δ is the penetration depth of a plane-wave at normal incidence to the tissue medium; see draft standard IEEE P1528-2011 for details. * When zoom scan is required and the <i>reported</i> SAR from the <i>area scan based 1-g SAR estimation</i> procedures of KDB 447498 is ≤ 1.4 W/kg, ≤ 8 mm, ≤ 7 mm and ≤ 5 mm zoom scan resolution may be applied, respectively, for 2 GHz to 3 GHz, 3 GHz to 4 GHz and 4 GHz to 6 GHz.			

9.5 Volume Scan Procedures

The volume scan is used to assess overlapping SAR distributions for antennas transmitting in different frequency bands. It is equivalent to an oversized zoom scan used in standalone measurements. The measurement volume will be used to enclose all the simultaneous transmitting antennas. For antennas transmitting simultaneously in different frequency bands, the volume scan is measured separately in each frequency band. In order to sum correctly to compute the 1g aggregate SAR, the EUT remain in the same test position for all measurements and all volume scan use the same spatial resolution and grid spacing. When all volume scan were completed, the software, SEMCAD postprocessor can combine and subsequently superpose these measurement data to calculating the multiband SAR.

9.6 Power Drift Monitoring

All SAR testing is under the EUT install full charged battery and transmit maximum output power. In DASy measurement software, the power reference measurement and power drift measurement procedures are used for monitoring the power drift of EUT during SAR test. Both these procedures measure the field at a specified reference position before and after the SAR testing. The software will calculate the field difference in dB. If the power drifts more than 5%, the SAR will be retested.



10. Test Equipment List

Manufacturer	Name of Equipment	Type/Model	Serial Number	Calibration	
				Last Cal.	Due Date
SPEAG	750MHz System Validation Kit	D750V3	1087	2022/2/24	2025/2/22
SPEAG	835MHz System Validation Kit	D835V2	4d091	2022/8/19	2025/8/18
SPEAG	1750MHz System Validation Kit	D1750V2	1090	2022/2/24	2025/2/22
SPEAG	1900MHz System Validation Kit	D1900V2	5d118	2022/3/30	2025/3/28
SPEAG	2450MHz System Validation Kit	D2450V2	1095	2024/2/8	2025/2/7
SPEAG	2600MHz System Validation Kit	D2600V2	1112	2023/12/18	2024/12/17
SPEAG	3500MHz System Validation Kit	D3500V2	1037	2023/11/20	2024/11/19
SPEAG	3700MHz System Validation Kit	D3700V2	1008	2023/11/20	2024/11/19
SPEAG	3900MHz System Validation Kit	D3900V2	1048	2023/3/9	2026/3/8
SPEAG	5000MHz System Validation Kit	D5GHzV2	1113	2022/9/23	2025/9/22
SPEAG	Data Acquisition Electronics	DAE4	1650	2023/9/13	2024/9/12
SPEAG	Data Acquisition Electronics	DAE4	1358	2024/5/23	2025/5/22
SPEAG	Dosimetric E-Field Probe	EX3DV4	3857	2024/1/22	2025/1/21
SPEAG	Dosimetric E-Field Probe	ES3DV3	3279	2023/8/18	2024/8/17
SPEAG	SAM Twin Phantom	SAM Twin	TP-1842	NCR	NCR
Testo	Thermo-Hygrometer	608-H1	1241332126	2023/7/10	2024/7/9
Testo	Thermo-Hygrometer	HTC-1	55009	2024/1/4	2025/1/3
SPEAG	Phone Positioner	N/A	N/A	NCR	NCR
Anritsu	Radio Communication Analyzer	MT8821C	6262306175	2023/7/5	2024/7/4
Agilent	ENA Series Network Analyzer	E5071C	MY46111157	2023/7/5	2024/7/4
Anritsu	Radio Communication Analyzer	MT8821C	6262306175	2024/7/4	2025/7/3
Agilent	ENA Series Network Analyzer	E5071C	MY46112129	2024/7/4	2025/7/3
SPEAG	Dielectric Probe Kit	DAK-3.5	1144	2023/8/17	2024/8/16
Anritsu	Vector Signal Generator	MG3710A	6201682672	2024/1/2	2025/1/1
Rohde & Schwarz	Power Meter	NRVD	102081	2023/7/5	2024/7/4
Rohde & Schwarz	Power Sensor	NRV-Z5	100538	2023/7/5	2024/7/4
Rohde & Schwarz	Power Sensor	NRV-Z5	100539	2023/7/5	2024/7/4
Rohde & Schwarz	Power Meter	NRVD	102081	2024/7/4	2025/7/3
Rohde & Schwarz	Power Sensor	NRV-Z5	100538	2024/7/4	2025/7/3
Rohde & Schwarz	Power Sensor	NRV-Z5	100539	2024/7/4	2025/7/3
R&S	BLUETOOTH TESTER	CBT	100641	2024/1/2	2025/1/1
Rohde & Schwarz	Spectrum Analyzer	FSV7	101631	2023/10/11	2024/10/10
TES	DIGITAC THERMOMETER	1310	220305411	2023/7/8	2024/7/7
TES	DIGITAC THERMOMETER	TYPE-K	220305411	2024/1/4	2025/1/3
ARRA	Power Divider	A3200-2	N/A	Note 1	
MCL	Attenuation1	BW-S10W5+	N/A	Note 1	
MCL	Attenuation2	BW-S10W5+	N/A	Note 1	
MCL	Attenuation3	BW-S10W5+	N/A	Note 1	
BONN	POWER AMPLIFIER	BLMA 0830-3	087193A	Note 1	
BONN	POWER AMPLIFIER	BLMA 2060-2	087193B	Note 1	
Agilent	Dual Directional Coupler	778D	20500	Note 1	
Agilent	Dual Directional Coupler	11691D	MY48151020	Note 1	

Note:

1. Prior to system verification and validation, the path loss from the signal generator to the system check source and the power meter, which includes the amplifier, cable, attenuator and directional coupler, was measured by the network analyzer. The reading of the power meter was offset by the path loss difference between the path to the power meter and the path to the system check source to monitor the actual power level fed to the system check
2. Referring to KDB 865664 D01v01r04, the dipole calibration interval can be extended to 3 years with justification. The dipoles are also not physically damaged, or repaired during the interval.
3. The justification data of dipole can be found in appendix C. The return loss is < -20dB, within 20% of prior calibration, the impedance is within 5 ohm of prior calibration.

11. System Verification

11.1 Tissue Simulating Liquids

For the measurement of the field distribution inside the SAM phantom with DASY, the phantom must be filled with around 25 liters of homogeneous body tissue simulating liquid. For head SAR testing, the liquid height from the ear reference point (ERP) of the phantom to the liquid top surface is larger than 15 cm, which is shown in Fig. 11.1. For body SAR testing, the liquid height from the center of the flat phantom to the liquid top surface is larger than 15 cm, which is shown in Fig. 11.2.

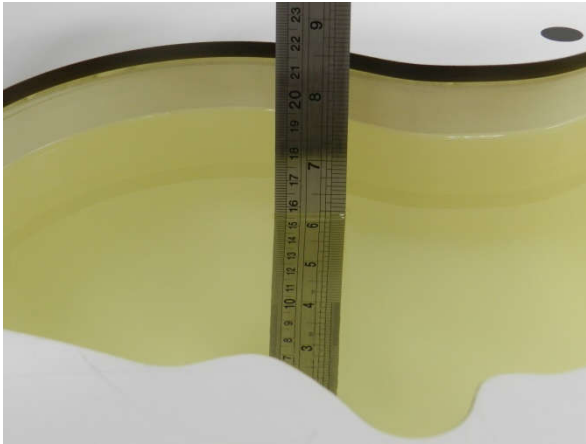

Fig 11.1 Photo of Liquid Height for Head SAR

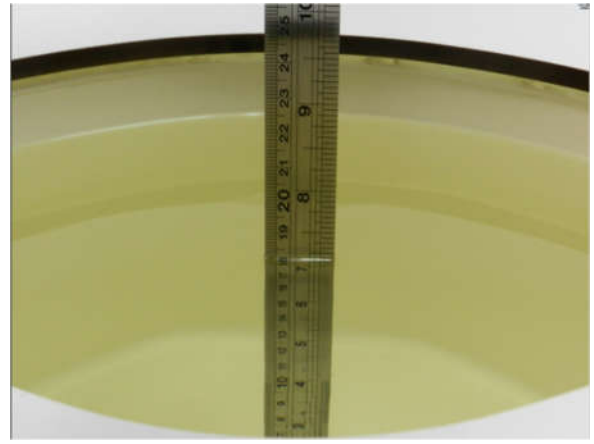

Fig 11.2 Photo of Liquid Height for Body SAR

11.2 Tissue Verification

The following tissue formulations are provided for reference only as some of the parameters have not been thoroughly verified. The composition of ingredients may be modified accordingly to achieve the desired target tissue parameters required for routine SAR evaluation.

Frequency (MHz)	Water (%)	Sugar (%)	Cellulose (%)	Salt (%)	Preventol (%)	DGBE (%)	Conductivity (σ)	Permittivity (ϵ_r)
For Head								
750	41.1	57.0	0.2	1.4	0.2	0	0.89	41.9
835	40.3	57.9	0.2	1.4	0.2	0	0.90	41.5
1800, 1900	55.2	0	0	0.3	0	44.5	1.40	40.0
2450	55.0	0	0	0	0	45.0	1.80	39.2
2600	54.8	0	0	0.1	0	45.1	1.96	39.0

Simulating Liquid for 5GHz, Manufactured by SPEAG

Ingredients	(% by weight)
Water	64~78%
Mineral oil	11~18%
Emulsifiers	9~15%
Additives and Salt	2~3%



<Tissue Dielectric Parameter Check Results>

Frequency (MHz)	Tissue Type	Liquid Temp. (°C)	Conductivity (σ)	Permittivity (ε _r)	Conductivity Target (σ)	Permittivity Target (ε _r)	Delta (σ) (%)	Delta (ε _r) (%)	Limit (%)	Date
750	Head	22.8	0.888	42.260	0.89	41.90	-0.22	0.86	±5	2024/5/22
835	Head	22.8	0.912	41.937	0.90	41.50	1.33	1.05	±5	2024/5/22
1750	Head	22.8	1.317	40.224	1.37	40.10	-3.87	0.31	±5	2024/6/7
1900	Head	22.8	1.407	40.215	1.40	40.00	0.50	0.54	±5	2024/6/8
2450	Head	22.8	1.880	40.373	1.80	39.20	4.44	2.99	±5	2024/5/24
2600	Head	22.8	2.031	40.361	1.96	39.00	3.62	3.49	±5	2024/6/9
3500	Head	22.7	2.813	38.735	2.91	37.90	-3.33	2.20	±5	2024/6/11
3700	Head	22.7	2.991	38.382	3.12	37.70	-4.13	1.81	±5	2024/6/11
3900	Head	22.7	3.175	38.058	3.32	37.50	-4.37	1.49	±5	2024/6/11
5250	Head	22.8	4.573	35.720	4.71	35.90	-2.91	-0.50	±5	2024/5/26
5600	Head	22.8	4.946	35.102	5.07	35.50	-2.45	-1.12	±5	2024/5/27
5750	Head	22.8	5.106	34.869	5.22	35.40	-2.18	-1.50	±5	2024/5/28
1750	Head	22.6	1.409	40.669	1.37	40.10	2.85	1.42	±5	2024/7/29

11.3 System Performance Check Results

Comparing to the original SAR value provided by SPEAG, the verification data should be within its specification of 10 %. Below table shows the target SAR and measured SAR after normalized to 1W input power. The table below indicates the system performance check can meet the variation criterion and the plots can be referred to Appendix A of this report.

<1g SAR>

Date	Frequency (MHz)	Tissue Type	Input Power (mW)	Dipole S/N	Probe S/N	DAE S/N	Measured 1g SAR (W/kg)	Targeted 1g SAR (W/kg)	Normalized 1g SAR (W/kg)	Deviation (%)
2024/5/22	750	Head	50	1087	3857	1650	0.419	8.58	8.38	-2.33
2024/5/22	835	Head	50	4d091	3857	1650	0.454	9.45	9.08	-3.92
2024/6/7	1750	Head	50	1090	3857	1650	1.930	37.00	38.6	4.32
2024/6/8	1900	Head	50	5d118	3857	1650	2.030	39.30	40.6	3.31
2024/5/24	2450	Head	50	1095	3857	1650	2.750	52.60	55	4.56
2024/6/9	2600	Head	50	1112	3857	1650	2.690	55.10	53.8	-2.36
2024/6/11	3500	Head	50	1037	3857	1650	3.120	65.40	62.4	-4.59
2024/6/11	3700	Head	50	1008	3857	1650	3.350	67.20	67	-0.30
2024/6/11	3900	Head	50	1048	3857	1650	3.650	69.10	73	5.64
2024/5/26	5250	Head	50	1113	3857	1650	4.300	81.50	86	5.52
2024/5/27	5600	Head	50	1113	3857	1650	4.420	82.60	88.4	7.02
2024/5/28	5750	Head	50	1113	3857	1650	4.080	80.80	81.6	0.99
2024/7/29	1750	Head	50	1090	3279	1358	1.910	37.00	38.2	3.24

<10g SAR>

Date	Frequency (MHz)	Tissue Type	Input Power (mW)	Dipole S/N	Probe S/N	DAE S/N	Measured 10g SAR (W/kg)	Targeted 10g SAR (W/kg)	Normalized 10g SAR (W/kg)	Deviation (%)
2024/5/22	750	Head	50	1087	3857	1650	0.295	5.65	5.9	4.42
2024/5/22	835	Head	50	4d091	3857	1650	0.327	6.22	6.54	5.14
2024/6/7	1750	Head	50	1090	3857	1650	1.010	19.50	20.2	3.59
2024/6/8	1900	Head	50	5d118	3857	1650	1.080	20.40	21.6	5.88
2024/5/24	2450	Head	50	1095	3857	1650	1.320	24.70	26.4	6.88
2024/6/9	2600	Head	50	1112	3857	1650	1.240	24.80	24.8	0.00
2024/6/11	3500	Head	50	1037	3857	1650	1.200	24.70	24	-2.83
2024/6/11	3700	Head	50	1008	3857	1650	1.240	24.40	24.8	1.64
2024/6/11	3900	Head	50	1048	3857	1650	1.230	24.10	24.6	2.07
2024/5/26	5250	Head	50	1113	3857	1650	1.250	23.30	25	7.30
2024/5/27	5600	Head	50	1113	3857	1650	1.200	23.70	24	1.27
2024/5/28	5750	Head	50	1113	3857	1650	1.170	23.00	23.4	1.74
2024/7/29	1750	Head	50	1090	3279	1358	1.030	19.50	20.6	5.64

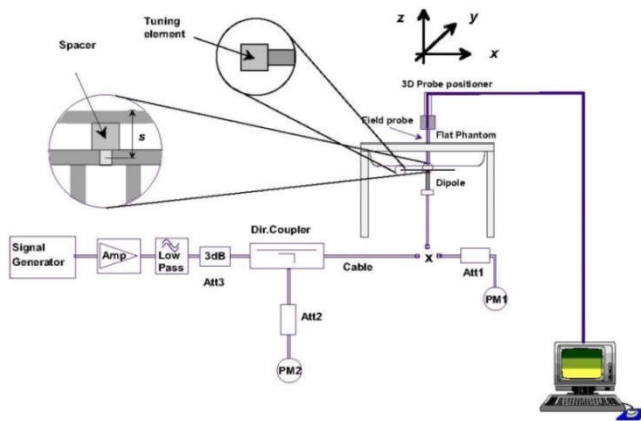

Fig 11.3.1 System Performance Check Setup



Fig 11.3.2 Setup Photo

12. RF Exposure Positions

12.1 Ear and handset reference point

Figure 12.1.1 shows the front, back, and side views of the SAM phantom. The center-of-mouth reference point is labeled “M,” the left ear reference point (ERP) is marked “LE,” and the right ERP is marked “RE.” Each ERP is 15 mm along the B-M (back-mouth) line behind the entrance-to-ear-canal (EEC) point, as shown in Figure 12.1.2 The Reference Plane is defined as passing through the two ear reference points and point M. The line N-F (neck-front), also called the reference pivoting line, is normal to the Reference Plane and perpendicular to both a line passing through RE and LE and the B-M line (see Figure 12.1.3). Both N-F and B-M lines should be marked on the exterior of the phantom shell to facilitate handset positioning. Posterior to the N-F line the ear shape is a flat surface with 6 mm thickness at each ERP, and forward of the N-F line the ear is truncated, as illustrated in Figure 12.1.2. The ear truncation is introduced to preclude the ear lobe from interfering with handset tilt, which could lead to unstable positioning at the cheek.

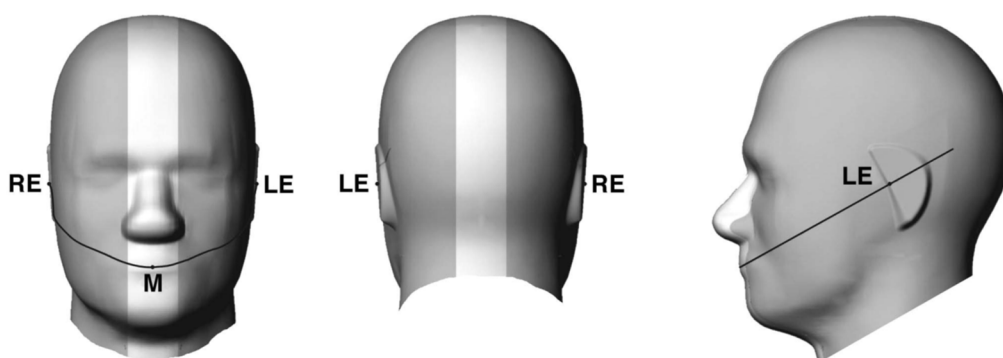

Fig 12.1.1 Front, back, and side views of SAM twin phantom

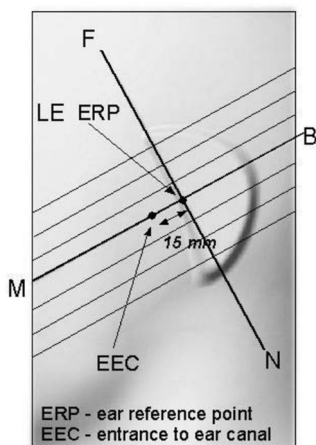

Fig 12.1.2 Close-up side view of phantom showing the ear region.

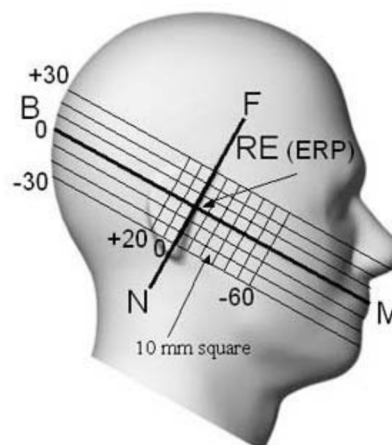

Fig 12.1.3 Side view of the phantom showing relevant markings and seven cross-sectional plane locations

12.2 Definition of the cheek position

1. Ready the handset for talk operation, if necessary. For example, for handsets with a cover piece (flip cover), open the cover. If the handset can transmit with the cover closed, both configurations must be tested.
2. Define two imaginary lines on the handset—the vertical centerline and the horizontal line. The vertical centerline passes through two points on the front side of the handset—the midpoint of the width w_t of the handset at the level of the acoustic output (point A in Figure 12.2.1 and Figure 12.2.2), and the midpoint of the width w_b of the bottom of the handset (point B). The horizontal line is perpendicular to the vertical centerline and passes through the center of the acoustic output (see Figure 12.2.1). The two lines intersect at point A. Note that for many handsets, point A coincides with the center of the acoustic output; however, the acoustic output may be located elsewhere on the horizontal line. Also note that the vertical centerline is not necessarily parallel to the front face of the handset (see Figure 12.2.2), especially for clamshell handsets, handsets with flip covers, and other irregularly-shaped handsets.
3. Position the handset close to the surface of the phantom such that point A is on the (virtual) extension of the line passing through points RE and LE on the phantom (see Figure 12.2.3), such that the plane defined by the vertical centerline and the horizontal line of the handset is approximately parallel to the sagittal plane of the phantom.
4. Translate the handset towards the phantom along the line passing through RE and LE until handset point A touches the pinna at the ERP.
5. While maintaining the handset in this plane, rotate it around the LE-RE line until the vertical centerline is in the plane normal to the plane containing B-M and N-F lines, i.e., the Reference Plane.
6. Rotate the handset around the vertical centerline until the handset (horizontal line) is parallel to the N-F line.
7. While maintaining the vertical centerline in the Reference Plane, keeping point A on the line passing through RE and LE, and maintaining the handset contact with the pinna, rotate the handset about the N-F line until any point on the handset is in contact with a phantom point below the pinna on the cheek. See Figure 12.2.3. The actual rotation angles should be documented in the test report.

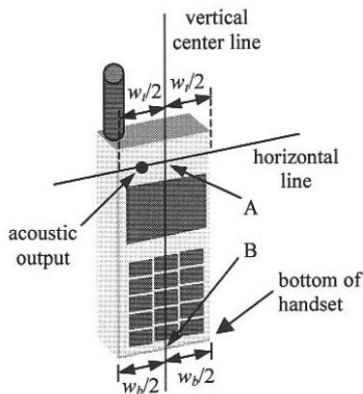

Fig 12.2.1 Handset vertical and horizontal reference lines—“fixed case”

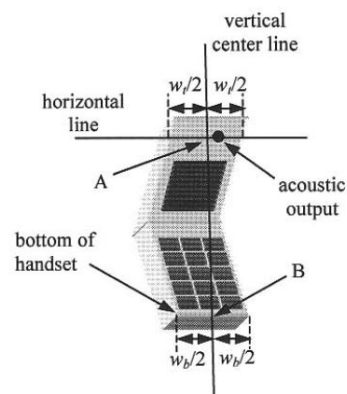

Fig 12.2.2 Handset vertical and horizontal reference lines—“clam-shell case”

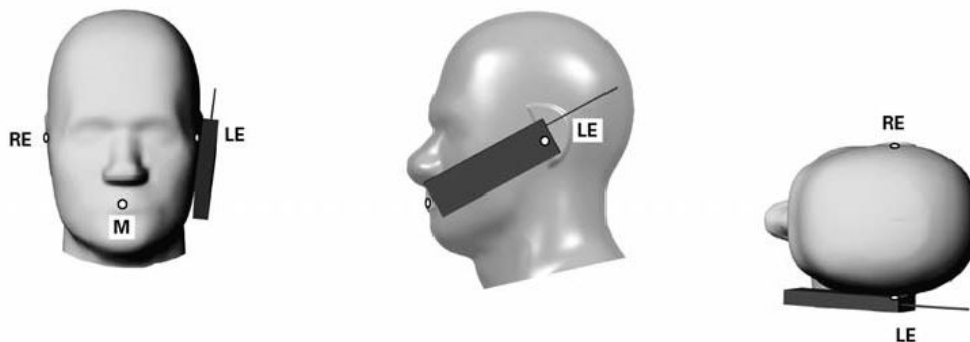

Fig 12.2.3 cheek or touch position. The reference points for the right ear (RE), left ear (LE), and mouth (M), which establish the Reference Plane for handset positioning, are indicated.

12.3 Definition of the tilt position

1. Ready the handset for talk operation, if necessary. For example, for handsets with a cover piece (flip cover), open the cover. If the handset can transmit with the cover closed, both configurations must be tested.
2. While maintaining the orientation of the handset, move the handset away from the pinna along the line passing through RE and LE far enough to allow a rotation of the handset away from the cheek by 15°.
3. Rotate the handset around the horizontal line by 15°.
4. While maintaining the orientation of the handset, move the handset towards the phantom on the line passing through RE and LE until any part of the handset touches the ear. The tilt position is obtained when the contact point is on the pinna. See Figure 12.3.1. If contact occurs at any location other than the pinna, e.g., the antenna at the back of the phantom head, the angle of the handset should be reduced. In this case, the tilt position is obtained if any point on the handset is in contact with the pinna and a second point

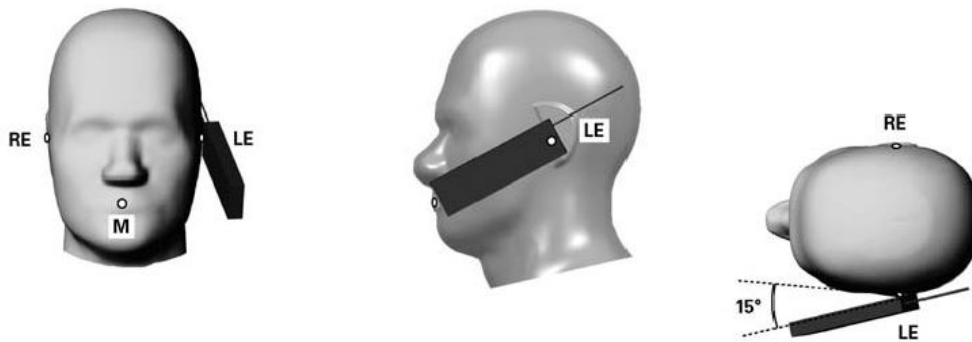

Fig 12.3.1 Tilt position. The reference points for the right ear (RE), left ear (LE), and mouth (M), which define the Reference Plane for handset positioning, are indicated.

12.4 Body Worn Accessory

Body-worn operating configurations are tested with the belt-clips and holsters attached to the device and positioned against a flat phantom in a normal use configuration (see Figure 12.4). Per KDB648474 D04v01r03, body-worn accessory exposure is typically related to voice mode operations when handsets are carried in body-worn accessories. The body-worn accessory procedures in FCC KDB 447498 D01v06 should be used to test for body-worn accessory SAR compliance, without a headset connected to it. This enables the test results for such configuration to be compatible with that required for hotspot mode when the body-worn accessory test separation distance is greater than or equal to that required for hotspot mode, when applicable. When the reported SAR for body-worn accessory, measured without a headset connected to the handset is $> 1.2 \text{ W/kg}$, the highest reported SAR configuration for that wireless mode and frequency band should be repeated for that body-worn accessory with a headset attached to the handset.

Accessories for body-worn operation configurations are divided into two categories: those that do not contain metallic components and those that do contain metallic components. When multiple accessories that do not contain metallic components are supplied with the device, the device is tested with only the accessory that dictates the closest spacing to the body. Then multiple accessories that contain metallic components are test with the device with each accessory. If multiple accessories share an identical metallic component (i.e. the same metallic belt-chip used with different holsters with no other metallic components) only the accessory that dictates the closest spacing to the body is tested.

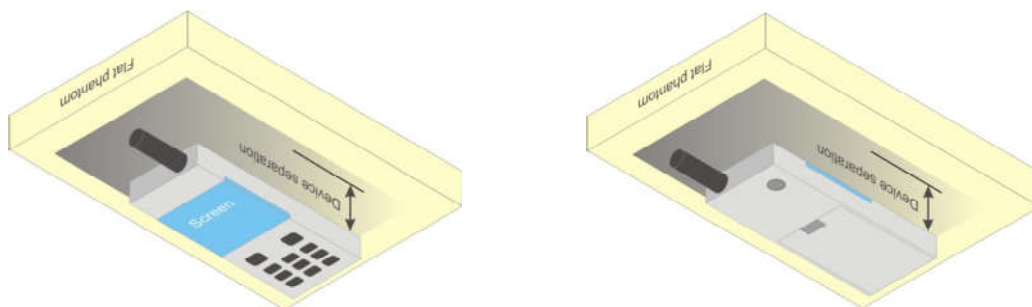

Fig 12.4 Body Worn Position

12.5 Product Specific 10g SAR Exposure

For smart phones with a display diagonal dimension > 15.0 cm or an overall diagonal dimension > 16.0 cm, that can provide similar mobile web access and multimedia support found in mini-tablets or UMPC mini-tablets and support voice calls next to the ear, According to KDB648474 D04v01r03, the following phablet procedures should be applied to evaluate SAR compliance for each applicable wireless modes and frequency band. Devices marketed as phablets, regardless of form factors and operating characteristics must be tested as a phablet to determine SAR compliance

1. The normally required head and body-worn accessory SAR test procedures for handsets, including hotspot mode, must be applied.
2. The UMPC mini-tablet procedures must also be applied to test the SAR of all surfaces and edges with an antenna located at ≤ 25 mm from that surface or edge, in direct contact with a flat phantom, for 10-g extremity SAR according to the body-equivalent tissue dielectric parameters in KDB 865664 to address interactive hand use exposure conditions.6 The UMPC mini-tablet 1-g SAR at 5 mm is not required. When hotspot mode applies, 10-g extremity SAR is required only for the surfaces and edges with hotspot mode 1-g reported SAR > 1.2 W/kg.

12.6 Wireless Router

Some battery-operated handsets have the capability to transmit and receive user through simultaneous transmission of WIFI simultaneously with a separate licensed transmitter. The FCC has provided guidance in FCC KDB Publication 941225 D06 v02r01 where SAR test considerations for handsets ($L \times W \geq 9$ cm x 5 cm) are based on a composite test separation distance of 10mm from the front, back and edges of the device containing transmitting antennas within 2.5cm of their edges, determined from general mixed use conditions for this type of devices. Since the hotspot SAR results may overlap with the body-worn accessory SAR requirements, the more conservative configurations can be considered, thus excluding some body-worn accessory SAR tests.

When the user enables the personal wireless router functions for the handset, actual operations include simultaneous transmission of both the WIFI transmitter and another licensed transmitter. Both transmitters often do not transmit at the same transmitting frequency and thus cannot be evaluated for SAR under actual use conditions due to the limitations of the SAR assessment probes. Therefore, SAR must be evaluated for each frequency transmission and mode separately and spatially summed with the WIFI transmitter according to FCC KDB Publication 447498 D01v06 publication procedures. The "Portable Hotspot" feature on the handset was NOT activated during SAR assessments, to ensure the SAR measurements were evaluated for a single transmission frequency RF signal at a time.

13. Conducted RF Output Power (Unit: dBm)

The detailed conducted power table can refer to Appendix E.

<WCDMA Conducted Power>

1. The following tests were conducted according to the test requirements outlines in 3GPP TS 34.121 specification.
2. The procedures in KDB 941225 D01v03r01 are applied for 3GPP Rel. 6 HSPA to configure the device in the required sub-test mode(s) to determine SAR test exclusion.
3. For HSPA+ devices supporting 16 QAM in the uplink, power measurements procedure is according to the configurations in Table C.11.1.4 of 3GPP TS 34.121-1.
4. For DC-HSDPA, the device was configured according to the H-Set 12, Fixed Reference Channel (FRC) configuration in Table C.8.1.12 of 3GPP TS 34.121-1, with the primary and the secondary serving HS-DSCH Cell enabled during the power measurement.

A summary of these settings are illustrated below:

HSDPA Setup Configuration:

- a. The EUT was connected to Base Station Agilent E5515C referred to the Setup Configuration.
- b. The RF path losses were compensated into the measurements.
- c. A call was established between EUT and Base Station with following setting:
 - i. Set Gain Factors (β_c and β_d) and parameters were set according to each
 - ii. Specific sub-test in the following table, C10.1.4, quoted from the TS 34.121
 - iii. Set RMC 12.2Kbps + HSDPA mode.
 - iv. Set Cell Power = -86 dBm
 - v. Set HS-DSCH Configuration Type to FRC (H-set 1, QPSK)
 - vi. Select HSDPA Uplink Parameters
 - vii. Set Delta ACK, Delta NACK and Delta CQI = 8
 - viii. Set Ack-Nack Repetition Factor to 3
 - ix. Set CQI Feedback Cycle (k) to 4 ms
 - x. Set CQI Repetition Factor to 2
 - xi. Power Ctrl Mode = All Up bits
- d. The transmitted maximum output power was recorded.

Table C.10.1.4: β values for transmitter characteristics tests with HS-DPCCH

Sub-test	β_c	β_d	β_d (SF)	β_c/β_d	β_{HS} (Note 1, Note 2)	CM (dB) (Note 3)	MPR (dB) (Note 3)
1	2/15	15/15	64	2/15	4/15	0.0	0.0
2	12/15 (Note 4)	15/15 (Note 4)	64	12/15 (Note 4)	24/15	1.0	0.0
3	15/15	8/15	64	15/8	30/15	1.5	0.5
4	15/15	4/15	64	15/4	30/15	1.5	0.5

Note 1: $\Delta_{ACK}, \Delta_{NACK}$ and $\Delta_{CQI} = 30/15$ with $\beta_{HS} = 30/15 * \beta_c$.

Note 2: For the HS-DPCCH power mask requirement test in clause 5.2C, 5.7A, and the Error Vector Magnitude (EVM) with HS-DPCCH test in clause 5.13.1A, and HSDPA EVM with phase discontinuity in clause 5.13.1AA, Δ_{ACK} and $\Delta_{NACK} = 30/15$ with $\beta_{HS} = 30/15 * \beta_c$, and $\Delta_{CQI} = 24/15$ with $\beta_{HS} = 24/15 * \beta_c$.

Note 3: CM = 1 for $\beta_c/\beta_d = 12/15, \beta_{HS}/\beta_c = 24/15$. For all other combinations of DPDCH, DPCCH and HS-DPCCH the MPR is based on the relative CM difference. This is applicable for only UEs that support HSDPA in release 6 and later releases.

Note 4: For subtest 2 the β_c/β_d ratio of 12/15 for the TFC during the measurement period (TF1, TF0) is achieved by setting the signalled gain factors for the reference TFC (TF1, TF1) to $\beta_c = 11/15$ and $\beta_d = 15/15$.

Setup Configuration

HSUPA Setup Configuration:

- a. The EUT was connected to Base Station Agilent E5515C referred to the Setup Configuration.
- b. The RF path losses were compensated into the measurements.
- c. A call was established between EUT and Base Station with following setting * :
 - i. Call Configs = 5.2B, 5.9B, 5.10B, and 5.13.2B with QPSK
 - ii. Set the Gain Factors (β_c and β_d) and parameters (AG Index) were set according to each specific sub-test in the following table, C11.1.3, quoted from the TS 34.121
 - iii. Set Cell Power = -86 dBm
 - iv. Set Channel Type = 12.2k + HSPA
 - v. Set UE Target Power
 - vi. Power Ctrl Mode= Alternating bits
 - vii. Set and observe the E-TFCI
 - viii. Confirm that E-TFCI is equal to the target E-TFCI of 75 for sub-test 1, and other subtest's E-TFCI
- d. The transmitted maximum output power was recorded.

Table C.11.1.3: β values for transmitter characteristics tests with HS-DPCCH and E-DCH

Sub-test	β_c	β_d	β_d (SF)	β_c/β_d	β_{HS} (Note1)	β_{ec}	β_{ed} (Note 4) (Note 5)	β_{ed} (SF)	β_{ed} (Codes)	CM (dB) (Note 2)	MPR (dB) (Note 2) (Note 6)	AG Index (Note 5)	E-TFCI
1	11/15 (Note 3)	15/15 (Note 3)	64	11/15 (Note 3)	22/15	209/25	1309/225	4	1	1.0	0.0	20	75
2	6/15	15/15	64	6/15	12/15	12/15	94/75	4	1	3.0	2.0	12	67
3	15/15	9/15	64	15/9	30/15	30/15	β_{ed1} : 47/15 β_{ed2} : 47/15	4 4	2	2.0	1.0	15	92
4	2/15	15/15	64	2/15	4/15	2/15	56/75	4	1	3.0	2.0	17	71
5	15/15	0	-	-	5/15	5/15	47/15	4	1	1.0	0.0	12	67

Note 1: For sub-test 1 to 4, Δ_{ACK} , Δ_{NACK} and $\Delta_{CQI} = 30/15$ with $\beta_{hs} = 30/15 * \beta_c$. For sub-test 5, Δ_{ACK} , Δ_{NACK} and $\Delta_{CQI} = 5/15$ with $\beta_{hs} = 5/15 * \beta_c$.

Note 2: CM = 1 for $\beta_c/\beta_d = 12/15$, $\beta_{hs}/\beta_c = 24/15$. For all other combinations of DPDCH, DPCCH, HS- DPCCH, E-DPDCH and E-DPCCH the MPR is based on the relative CM difference.

Note 3: For subtest 1 the β_c/β_d ratio of 11/15 for the TFC during the measurement period (TF1, TF0) is achieved by setting the signalled gain factors for the reference TFC (TF1, TF1) to $\beta_c = 10/15$ and $\beta_d = 15/15$.

Note 4: In case of testing by UE using E-DPDCH Physical Layer category 1, Sub-test 3 is omitted according to TS25.306 Table 5.1g.

Note 5: β_{ed} can not be set directly; it is set by Absolute Grant Value.

Note 6: For subtests 2, 3 and 4, UE may perform E-DPDCH power scaling at max power which could results in slightly smaller MPR values.

Setup Configuration

DC-HSDPA 3GPP release 8 Setup Configuration:

- a. The EUT was connected to Base Station Agilent E5515C referred to the Setup Configuration below
- b. The RF path losses were compensated into the measurements.
- c. A call was established between EUT and Base Station with following setting:
 - i. Set RMC 12.2Kbps + HSDPA mode.
 - ii. Set Cell Power = -25 dBm
 - iii. Set HS-DSCH Configuration Type to FRC (H-set 12, QPSK)
 - iv. Select HSDPA Uplink Parameters
 - v. Set Gain Factors (β_c and β_d) and parameters were set according to each Specific sub-test in the following table, C10.1.4, quoted from the TS 34.121
 - a). Subtest 1: $\beta_c/\beta_d=2/15$
 - b). Subtest 2: $\beta_c/\beta_d=12/15$
 - c). Subtest 3: $\beta_c/\beta_d=15/8$
 - d). Subtest 4: $\beta_c/\beta_d=15/4$
 - vi. Set Delta ACK, Delta NACK and Delta CQI = 8
 - vii. Set Ack-Nack Repetition Factor to 3
 - viii. Set CQI Feedback Cycle (k) to 4 ms
 - ix. Set CQI Repetition Factor to 2
 - x. Power Ctrl Mode = All Up bits
- d. The transmitted maximum output power was recorded.

The following tests were conducted according to the test requirements outlines in 3GPP TS 34.121 specification. A summary of these settings are illustrated below:

C.8.1.12 Fixed Reference Channel Definition H-Set 12

Table C.8.1.12: Fixed Reference Channel H-Set 12

Parameter	Unit	Value
Nominal Avg. Inf. Bit Rate	kbps	60
Inter-TTI Distance	TTI's	1
Number of HARQ Processes	Processes	6
Information Bit Payload (N_{INF})	Bits	120
Number Code Blocks	Blocks	1
Binary Channel Bits Per TTI	Bits	960
Total Available SML's in UE	SML's	19200
Number of SML's per HARQ Proc.	SML's	3200
Coding Rate		0.15
Number of Physical Channel Codes	Codes	1
Modulation		QPSK
Note 1: The RMC is intended to be used for DC-HSDPA mode and both cells shall transmit with identical parameters as listed in the table. Note 2: Maximum number of transmission is limited to 1, i.e., retransmission is not allowed. The redundancy and constellation version 0 shall be used.		

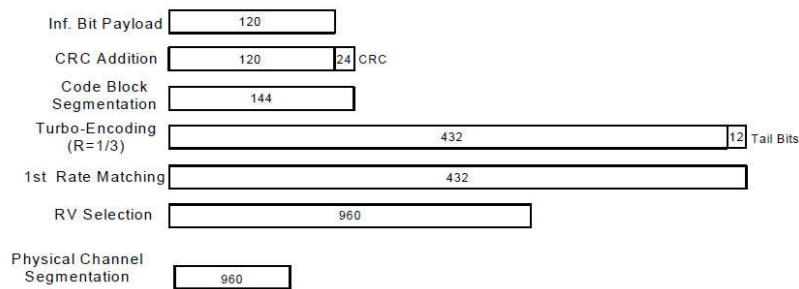

Figure C.8.19: Coding rate for Fixed reference Channel H-Set 12 (QPSK)

Setup Configuration

HSPA+ 3GPP release 7 (uplink category 7) 16QAM, Setup Configuration:

- a. The EUT was connected to Base Station Agilent E5515C referred to the Setup Configuration.
- b. The RF path losses were compensated into the measurements.
- c. A call was established between EUT and Base Station with following setting * :
 - i. Call Configs = 5.2E:HSPA+:UL with 16QAM
 - ii. Set the Gain Factors (β_c and β_d) and parameters (AG Index) were set according to each specific sub-test in the following table, C11.1.4, quoted from the TS 34.121-1 s5.2E
 - iii. Set Channel Parm
 - iv. Set Cell Power = -86 dBm
 - v. Set Channel Type = HSPA
 - vi. Set UE Target Power =21 dBm
 - vii. Power Ctrl Mode= All Up Bits
 - viii. Set Manual Uplink DPCH Bc/Bd = Manual
 - ix. Set Manual Uplink DPCH Bc and Bd=15,15(for 34.121-1 v8.10.0 table C11.1.4 sub-test 1)
 - x. Set HSPA Conn DL Channel Levels
 - xi. Set HS-SCCH Configs
 - xii. Set RB Test Mode Setup
 - xiii. Set Common HSUPA Parameters
 - xiv. Set Serving Grant
 - xv. Confirm that E-TFCI is equal to the target E-TFCI of 105 for sub-test 1, and other subtest's E-TFCI
- d. The transmitted maximum output power was recorded.

Table C.11.1.4: β values for transmitter characteristics tests with HS-DPCCH and E-DCH with 16QAM

Sub-test	β_c (Note3)	β_d	β_{HS} (Note1)	β_{ec}	β_{ed} (2xSF2) (Note 4)	β_{ed} (2xSF4) (Note 4)	CM (dB) (Note 2)	MPR (dB) (Note 2)	AG Index (Note 4)	E-TFCI (Note 5)	E-TFCI (boost)
1	1	0	30/15	30/15	β_{ed1} : 30/15 β_{ed2} : 30/15	β_{ed3} : 24/15 β_{ed4} : 24/15	3.5	2.5	14	105	105

Note 1: $\Delta_{ACK}, \Delta_{NACK}$ and $\Delta_{CQI} = 30/15$ with $\beta_{fs} = 30/15 * \beta_c$.

Note 2: CM = 3.5 and the MPR is based on the relative CM difference, MPR = MAX(CM-1,0).

Note 3: DPDCH is not configured, therefore the β_c is set to 1 and $\beta_d = 0$ by default.

Note 4: β_{ed} can not be set directly; it is set by Absolute Grant Value.

Note 5: All the sub-tests require the UE to transmit 2SF2+2SF4 16QAM EDCH and they apply for UE using E-DPDCH category 7. E-DCH TTI is set to 2ms TTI and E-DCH table index = 2. To support these E-DCH configurations DPDCH is not allocated. The UE is signaled to use the extrapolation algorithm.

Setup Configuration

<WCDMA Conducted Power>

General Note:

- 1. Per KDB 941225 D01v03r01, for SAR testing is measured using a 12.2 kbps RMC with TPC bits configured to all "1's".
- 2. Per KDB 941225 D01v03r01, RMC 12.2kbps setting is used to evaluate SAR. The maximum output power and tune-up tolerance specified for production units in HSDPA / HSUPA / DC-HSDPA / HSPA+ is $\leq 1/4$ dB higher than RMC 12.2Kbps or when the highest reported SAR of the RMC12.2Kbps is scaled by the ratio of specified maximum output power and tune-up tolerance of HSDPA / HSUPA / DC-HSDPA / HSPA+ to RMC12.2Kbps and the adjusted SAR is ≤ 1.2 W/kg, SAR measurement is not required for HSDPA / HSUPA / DC-HSDPA / HSPA+, and according to the following RF output power, the output power results of the secondary modes (HSDPA / HSUPA / DC-HSDPA / HSPA+) are less than $1/4$ dB higher than the primary modes; therefore, SAR measurement is not required for HSDPA / HSUPA / DC-HSDPA / HSPA+.

<LTE Conducted Power>

General Note:

1. Anritsu MT8820C base station simulator was used to setup the connection with EUT; the frequency band, channel bandwidth, RB allocation configuration, modulation type are set in the base station simulator to configure EUT transmitting at maximum power and at different configurations which are requested to be reported to FCC, for conducted power measurement and SAR testing.
2. Per KDB 941225 D05v02r05, when a properly configured base station simulator is used for the SAR and power measurements, spectrum plots for each RB allocation and offset configuration is not required.
3. Per KDB 941225 D05v02r05, start with the largest channel bandwidth and measure SAR for QPSK with 1 RB allocation, using the RB offset and required test channel combination with the highest maximum output power for RB offsets at the upper edge, middle and lower edge of each required test channel.
4. Per KDB 941225 D05v02r05, 50% RB allocation for QPSK SAR testing follows 1RB QPSK allocation procedure.
5. Per KDB 941225 D05v02r05, for QPSK with 100% RB allocation, SAR is not required when the highest maximum output power for 100 % RB allocation is less than the highest maximum output power in 50% and 1 RB allocations and the highest reported SAR for 1 RB and 50% RB allocation are ≤ 0.8 W/kg. Otherwise, SAR is measured for the highest output power channel; and if the reported SAR is > 1.45 W/kg, the remaining required test channels must also be tested.
6. Per KDB 941225 D05v02r05, 16QAM output power for each RB allocation configuration is $>$ not $\frac{1}{2}$ dB higher than the same configuration in QPSK and the reported SAR for the QPSK configuration is ≤ 1.45 W/kg; Per KDB 941225 D05v02r05, 16QAM/64QAM SAR testing is not required.
7. Per KDB 941225 D05v02r05, smaller bandwidth output power for each RB allocation configuration is $>$ not $\frac{1}{2}$ dB higher than the same configuration in the largest supported bandwidth, and the reported SAR for the largest supported bandwidth is ≤ 1.45 W/kg; Per KDB 941225 D05v02r05, smaller bandwidth SAR testing is not required.
8. For LTE B4/B5/B12/B38 the maximum bandwidth does not support three non-overlapping channels, per KDB 941225 D05v02r05, when a device supports overlapping channel assignment in a channel bandwidth configuration, the middle channel of the group of overlapping channels should be selected for testing.
9. According to May 2017 TCB workshop, for 16QAM and 64QAM should be verified by checking the signal constellation with a call box to avoid incorrect maximum power levels due to MPR and other requirements associated with signal modulation, and the following figure is taken from the "Fundamental Measurement >> Modulation Analysis >> constellation" mode of the device connect to the MT8821C base station, therefore, the device 64QAM and 16QAM signal modulation are correct.

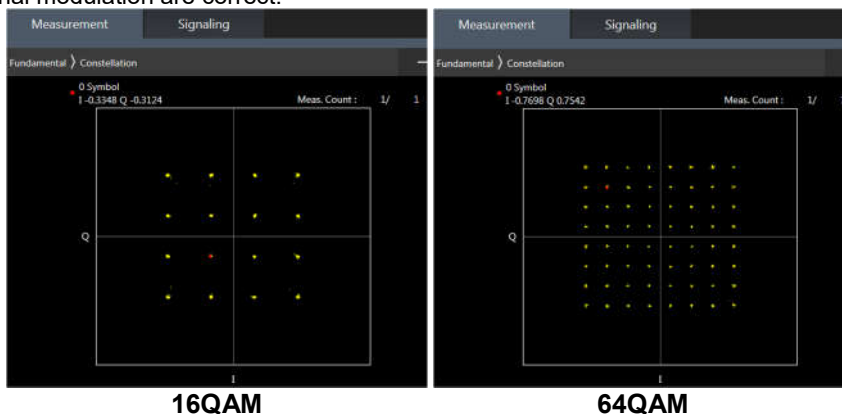

<TDD LTE SAR Measurement>

TDD LTE configuration setup for SAR measurement

SAR was tested with a fixed periodic duty factor according to the highest transmission duty factor implemented for the device and supported by 3GPP.

- a. 3GPP TS 36.211 section 4.2 for Type 2 Frame Structure and Table 4.2-2 for uplink-downlink configurations
- b. "special subframe S" contains both uplink and downlink transmissions, it has been taken into consideration to determine the transmission duty factor according to the worst case uplink and downlink cyclic prefix requirements for UpPTS
- c. Establishing connections with base station simulators ensure a consistent means for testing SAR and recommended for evaluating SAR. The Anritsu MT8820C (firmware: #22.52#004) was used for LTE output power measurements and SAR testing.

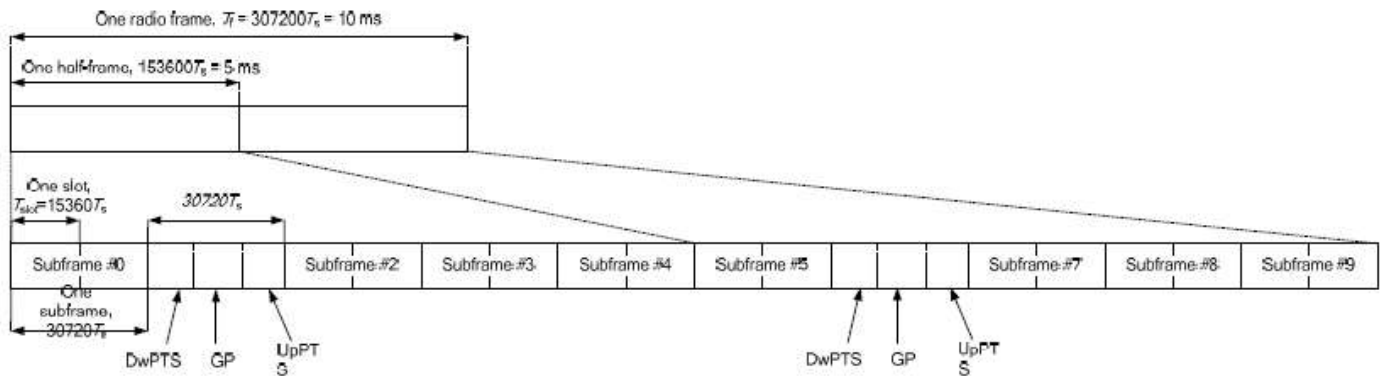

Figure 4.2-1: Frame structure type 2 (for 5 ms switch-point periodicity).

Table 4.2-2: Uplink-downlink configurations.

Uplink-downlink configuration	Downlink-to-Uplink Switch-point periodicity	Subframe number									
		0	1	2	3	4	5	6	7	8	9
0	5 ms	D	S	U	U	U	D	S	U	U	U
1	5 ms	D	S	U	U	D	D	S	U	U	D
2	5 ms	D	S	U	D	D	D	S	U	D	D
3	10 ms	D	S	U	U	U	D	D	D	D	D
4	10 ms	D	S	U	U	D	D	D	D	D	D
5	10 ms	D	S	U	D	D	D	D	D	D	D
6	5 ms	D	S	U	U	D	S	U	U	D	D

Table 4.2-1: Configuration of special subframe (lengths of DwPTS/GP/UpPTS).

Special subframe configuration	Normal cyclic prefix in downlink				Extended cyclic prefix in downlink		
	DwPTS	UpPTS		DwPTS	UpPTS		
		Normal cyclic prefix in uplink	Extended cyclic prefix in uplink		Normal cyclic prefix in uplink	Extended cyclic prefix in uplink	
0	6592 · Ts	2192 · Ts	2560 · Ts	7680 · Ts	2192 · Ts	2560 · Ts	
1	19760 · Ts			20480 · Ts			
2	21952 · Ts			23040 · Ts			
3	24144 · Ts			25600 · Ts			
4	26336 · Ts	4384 · Ts	5120 · Ts	7680 · Ts	4384 · Ts	5120 · Ts	
5	6592 · Ts			20480 · Ts			
6	19760 · Ts			23040 · Ts			
7	21952 · Ts			12800 · Ts			
8	24144 · Ts			-			-
9	13168 · Ts	-	-	-	-	-	

Special subframe (30720·T _s): Normal cyclic prefix in downlink (UpPTS)			
	Special subframe configuration	Normal cyclic prefix in uplink	Extended cyclic prefix in uplink
Uplink duty factor in one special subframe	0~4	7.13%	8.33%
	5~9	14.3%	16.7%

Special subframe(30720·T _s): Extended cyclic prefix in downlink (UpPTS)			
	Special subframe configuration	Normal cyclic prefix in uplink	Extended cyclic prefix in uplink
Uplink duty factor in one special subframe	0~3	7.13%	8.33%
	4~7	14.3%	16.7%

The highest duty factor is resulted from:

For LTE TDD Power class 3

- i. Uplink-downlink configuration: 0. In a half-frame consisted of 5 subframes, uplink operation is in 3 uplink subframes and 1 special subframe.
- ii. special subframe configuration: 5-9 for normal cyclic prefix in downlink, 4-7 for extended cyclic prefix in downlink
- iii. for special subframe with extended cyclic prefix in uplink, the total uplink duty factor in one half-frame is: $(3+0.167)/5 = 63.3\%$
- iv. for special subframe with normal cyclic prefix in uplink, the total uplink duty factor in one half-frame is: $(3+0.143)/5 = 62.9\%$
- v. For TDD LTE SAR measurement, the duty cycle 1:1.59 (62.9 %) was used perform testing and considering the theoretical duty cycle of 63.3% for extended cyclic prefix in the uplink, and the theoretical duty cycle of 62.9% for normal cyclic prefix in uplink, a scaling factor of extended cyclic prefix $63.3\%/62.9\% = 1.006$ is applied to scale-up the measured SAR result. The scaled TDD LTE SAR = measured SAR (W/kg)* Tune-up Scaling Factor* scaling factor for extended cyclic prefix.

<LTE Carrier Aggregation>

General Note:

1. This device supports Carrier Aggregation on downlink for inter and intra band. For the device supports bands and bandwidths and configurations are provided as follow table was according to 3GPP.
2. In applying the existing power measurement procedures of KDB 941225 D05A for DL CA SAR test exclusion, only the subset with the largest number of combinations of frequency bands and CCs in each row need combination, and for this device that all the configurations were choose to power measurement.
3. The gray color table is covered by other combinations and no need to verify power.

2CC Downlink Carrier Aggregation				3CC Downlink Carrier Aggregation			
Number	Combination	4X4 MIMO	Covered by	Number	Combination	4X4 MIMO	Covered by
			Measurement Superset				Measurement Superset
1	CA_41A-42A		3CC-1	1	CA_41A-42C		
2	CA_41C		3CC-2	2	CA_41C-42A		
3	CA_42C		3CC-1				

LTE Carrier Aggregation Conducted Power (Downlink)

- i. According to KDB941225 D05A v01r02, Uplink maximum output power measurement with downlink carrier aggregation active should be measured, using the highest output channel measured without downlink carrier aggregation, to confirm that uplink maximum output power with downlink carrier aggregation active remains within the specified tune-up tolerance limits and not more than ¼ dB higher than the maximum output measured without downlink carrier aggregation active.
- ii. Uplink maximum output power with downlink carrier aggregation active does not show more than ¼ dB higher than the maximum output power without downlink carrier aggregation active, therefore SAR evaluation with downlink carrier aggregation active can be excluded.
- iii. The device supports downlink three carrier aggregation. For power measurement were control and acknowledge data is sent on uplink channels that operate identical to specifications when downlink carrier aggregation is inactive.
- iv. Selected highest measured power when downlink carrier aggregation is inactive for conducted power comparison with downlink carrier aggregation is active, to confirm that when downlink carrier aggregation is active uplink maximum output power remains within the specified tune-up tolerance limits and not more than ¼ dB higher than the maximum output power measured when downlink carrier aggregation inactive.
- v. For inter-band CA, the SCC selected highest bandwidth and near the middle of its transmission band. For SCC DL RB size and offset will base on the PCC corresponding RB allocation.
- vi. For non-contiguous intra-band CA, the SCC selected to provide maximum separation from the PCC and must remain fully within the downlink transmission band.
- vii. For Intra-band, contiguous CA, the downlink channels selected to perform the uplink power measurement must satisfy 3GPP channel spacing (5.4.1A of 3GPP TS 36.521 or equivalent) and channel bandwidth (5.4.2A) requirements.

$$\text{Nominal channel spacing} = \left\lceil \frac{BW_{\text{Channel}(1)} + BW_{\text{Channel}(2)} - 0.1|BW_{\text{Channel}(1)} - BW_{\text{Channel}(2)}|}{0.6} \right\rceil 0.3 \text{ [MHz]}$$

5G NR Output Power (Unit: dBm)

General Note:

1. 5G NR n77/n78 is NSA mode, 5G NR n41/n77/n78 is SA mode.
2. For 5G NR test procedure was following step similar FCC KDB 941225 D05:
 - a. For DFT-OFDM and CP-OFDM output power measurement reduction, according to 38.101 maximum power reduction for power class2 and 3, the CP-OFDM mode will not higher than DFT-OFDM mode, therefore, similar FCC KDB 941225 D05 procedure for other modulation output power for each RB allocation configuration is > not ½ dB higher than the same configuration in DFT-QPSK and the reported SAR for the DFT-QPSK configuration is ≤ 1.45 W/kg; CP-OFDM testing is not required.
 - b. For DFT-OFDM output power measurement reduction, according to 38.101 maximum power reduction for power class2 and 3, for 16QAM/64QAM/256QAM and smaller bandwidth output power will spot check largest channel bandwidth worst RB configuration to ensure the 16QAM/64QAM/256QAM and smaller bandwidth output power will not ½ dB higher than the same configuration in the largest supported bandwidth.
 - c. SAR testing start with the largest channel bandwidth and measure SAR for QPSK with 1 RB allocation, using the RB offset and required test channel combination with the highest maximum output power for RB offsets at the upper edge, middle and lower edge of each required test channel
 - d. 50% RB allocation for QPSK SAR testing follows 1RB QPSK allocation procedure
 - e. QPSK with 100% RB allocation, SAR is not required when the highest maximum output power for 100 % RB allocation is less than the highest maximum output power in 50% and 1 RB allocations and the highest reported SAR for 1 RB and 50% RB allocation are ≤ 0.8 W/kg. Otherwise, SAR is measured for the highest output power channel; and if the reported SAR is > 1.45 W/kg, the remaining required test channels must also be tested
 - f. PI/2 BPSK/16QAM/64QAM/256QAM output powers according to 3GPP MPR will not ½ dB higher than the same configuration in QPSK, also reported SAR for the QPSK configuration is less than 1.45 W/kg, PI/2 BPSK/16QAM /64QAM/256QAM SAR testing are not required.
 - g. Smaller bandwidth output power for each RB allocation configuration for this device will not ½ dB higher than the same configuration in the largest supported bandwidth, and the reported SAR for the largest supported bandwidth is ≤ 1.45 W/kg, smaller bandwidth SAR testing is not required for this device
3. For 5G NR bands test, using FTM (Factory Test Mode) with default 100% duty cycle transmission to perform SAR testing.
4. 5G NR supports CP-OFDM and DFT-s-OFDM modulation, for DFT-s-OFDM power is higher than CP-OFDM, so only show DFT-s-OFDM power table and chose DFT-s-OFDM to perform SAR testing.
5. For DFT-s-OFDM and CP-OFDM output power measurement reduction, according to 38.101 maximum power reduction for the CP-OFDM mode will not higher than DFT-s-OFDM mode, therefore, CP-OFDM measurement is unnecessary.
6. NSA and SA mode should perform SAR separately. For the maximum power of NSA mode is the same as SA total power level, so SA SAR can represent NSA mode SAR.
7. 5G NR NSA mode, the power level is the same as 5G NR SA mode, so 5G NR NSA mode and SA mode power table only show one time.
8. For 5G NR EN-DC mode, standalone SAR performed for 5G NR NSA band with the maximum power, EN-DC SAR summed EN-DC mode 5G NR standalone SAR and LTE standalone SAR, the result of EN-DC SAR is more conservatively.

<3GPP 38.101 MPR for EN-DC>

Table 6.2.2-1 Maximum power reduction (MPR) for power class 3

Modulation		MPR (dB)		
		Edge RB allocations	Outer RB allocations	Inner RB allocations
DFT-s-OFDM	Pi/2 BPSK	$\leq 3.5^1$	$\leq 1.2^1$	$\leq 0.2^1$
		$\leq 0.5^2$	$\leq 0.5^2$	0 ²
	QPSK		≤ 1	0
	16 QAM		≤ 2	≤ 1
	64 QAM		≤ 2.5	
CP-OFDM	256 QAM		≤ 4.5	
	QPSK	≤ 3		≤ 1.5
	16 QAM	≤ 3		≤ 2
	64 QAM		≤ 3.5	
	256 QAM		≤ 6.5	

NOTE 1: Applicable for UE operating in TDD mode with Pi/2 BPSK modulation and UE indicates support for UE capability *powerBoosting-pi2BPSK* and if the IE *powerBoostPi2BPSK* is set to 1 and 40 % or less slots in radio frame are used for UL transmission for bands n40, n41, n77, n78 and n79. The reference power of 0 dB MPR is 26 dBm.

NOTE 2: Applicable for UE operating in FDD mode, or in TDD mode in bands other than n40, n41, n77, n78 and n79 with Pi/2 BPSK modulation and if the IE *powerBoostPi2BPSK* is set to 0 and if more than 40 % of slots in radio frame are used for UL transmission for bands n40, n41, n77, n78 and n79.

Table 6.2.2-2 Maximum power reduction (MPR) for power class 2

Modulation		MPR (dB)		
		Edge RB allocations	Outer RB allocations	Inner RB allocations
DFT-s-OFDM	Pi/2 BPSK	≤ 3.5	≤ 0.5	0
	QPSK	≤ 3.5	≤ 1	0
	16 QAM	≤ 3.5	≤ 2	≤ 1
	64 QAM	≤ 3.5		≤ 2.5
	256 QAM		≤ 4.5	
CP-OFDM	QPSK	≤ 3.5	≤ 3	≤ 1.5
	16 QAM	≤ 3.5	≤ 3	≤ 2
	64 QAM		≤ 3.5	
	256 QAM		≤ 6.5	

<EN-DC combination>

ENDC	Main Antenna Tx	
	LTE TX	NR TX
DC_41A_n78A	ANT0	ANT0
DC_41A_n77A	ANT0	ANT0



14. Antenna Location

The detailed antenna location information can refer to SAR Test Setup Photos.

15. SAR Test Results

Spot Check General Note:

1. According to section 3.3, spot check conducted power test against the variant project based on the worst-case SAR condition from the original project was performed in this filing to demonstrate the test data from original project remains representative for the variant project. Detail Conducted power measurement referred to appendix E.
2. SAR spot check verification on the worst cases from the original model was performed to demonstrate the test data from original model remains representative for the variant model.
3. Per KDB 484596 D01 v02r03, the variant filings must demonstrate that the referenced test data remain valid for the variant device by including spot-check measurements that meet the following criteria:
 - a. Spot-check measurements shall be made in correspondence to the worst-case scenario reported in the reference device filing, i.e., for those conditions that are the closest to non-compliance
 - b. Spot-check measurements, while being always compliant with the applicable rule part(s) for the test under consideration, may show a deviation d_{dB} from the reference data no larger than 3 dB:
$$d_{dB} = |V_{dB} - R_{dB}| \leq 3 \text{ dB} \quad (1)$$
where between V_{dB} , the variant spot-check level in dB, and R_{dB} is the corresponding measurement level in dB for the reference model.
4. The Spot check results showed that deviation of the SAR results did not exceed 3 dB, therefore referring to the guidance in the KDB inquiry, SAR data reuse is justified.
5. 1st as parent model, 2nd as variant model.

General Note:

1. Per KDB 447498 D01v06, the reported SAR is the measured SAR value adjusted for maximum tune-up tolerance.
 - a. Tune-up scaling Factor = tune-up limit power (mW) / EUT RF power (mW), where tune-up limit is the maximum rated power among all production units.
 - b. For SAR testing of WLAN signal with non-100% duty cycle, the measured SAR is scaled-up by the duty cycle scaling factor which is equal to "1/(duty cycle)".
 - c. For SAR testing of Bluetooth signal with 83.3% theoretical duty cycle, the measured SAR is scaled-up by the duty cycle scaling factor which is equal to "1/(duty cycle) * 83.3%".
 - d. For WWAN: Reported SAR(W/kg)= Measured SAR(W/kg)*Tune-up Scaling Factor
 - e. For BT/WLAN: Reported SAR(W/kg)= Measured SAR(W/kg)* Duty Cycle scaling factor * Tune-up scaling factor
 - f. For TDD LTE SAR measurement of power class 3, the duty cycle 1:1.59 (62.9 %) was used perform testing and considering the theoretical duty cycle of 63.3% for extended cyclic prefix in the uplink, and the theoretical duty cycle of 62.9% for normal cyclic prefix in uplink, a scaling factor of extended cyclic prefix 63.3%/62.9% = 1.006 is applied to scale-up the measured SAR result. The Reported TDD LTE SAR = measured SAR (W/kg)* Tune-up Scaling Factor* scaling factor for extended cyclic prefix.
2. Per KDB 447498 D01v06, for each exposure position, testing of other required channels within the operating mode of a frequency band is not required when the *reported* 1-g or 10-g SAR for the mid-band or highest output power channel is:
 - $\leq 0.8 \text{ W/kg}$ or 2.0 W/kg , for 1-g or 10-g respectively, when the transmission band is $\leq 100 \text{ MHz}$
 - $\leq 0.6 \text{ W/kg}$ or 1.5 W/kg , for 1-g or 10-g respectively, when the transmission band is between 100 MHz and 200 MHz
 - $\leq 0.4 \text{ W/kg}$ or 1.0 W/kg , for 1-g or 10-g respectively, when the transmission band is $\geq 200 \text{ MHz}$
3. Per KDB 865664 D01v01r04, for each frequency band, repeated SAR measurement is required when the measured SAR is $\geq 0.8 \text{ W/kg}$. Per KDB 865664 D01v01r04, if the extremity repeated SAR is necessary, the same procedures should be adapted for measurements according to extremity and occupational exposure limits by applying a factor of 2.5 for extremity exposure and a factor of 5 for occupational exposure to the corresponding SAR thresholds.
4. Per KDB648474 D04v01r03, for smart phones with a display diagonal dimension $> 15.0 \text{ cm}$ or an overall diagonal dimension $> 16.0 \text{ cm}$, when hotspot mode applies, 10-g extremity SAR is required only for the surfaces and edges with hotspot mode 1-g reported SAR $> 1.2 \text{ W/kg}$, however, when power reduction applies to hotspot mode the measured SAR must be scaled to the maximum output power, including tolerance, allowed for phablet modes to compare with the 1.2 W/kg SAR test reduction threshold.
 - a. WLAN 5.3/5.5GHz tested the product specific 10g SAR since it has no hotspot mode.
 - b. When 10-g product specific 10g SAR is considered, SAR thresholds is specified in the procedures for SAR test reduction and exclusion should be multiplied by 2.5.

WCDMA Note:

1. Per KDB 941225 D01v03r01, for SAR testing is measured using a 12.2 kbps RMC with TPC bits configured to all "1's".
2. Per KDB 941225 D01v03r01, RMC 12.2kbps setting is used to evaluate SAR. The maximum output power and tune-up tolerance specified for production units in HSDPA / HSUPA / DC-HSDPA / HSPA+ is $\leq \frac{1}{4}$ dB higher than RMC 12.2Kbps or when the highest reported SAR of the RMC12.2Kbps is scaled by the ratio of specified maximum output power and tune-up tolerance of HSDPA / HSUPA / DC-HSDPA / HSPA+ to RMC12.2Kbps and the adjusted SAR is ≤ 1.2 W/kg, SAR measurement is not required for HSDPA / HSUPA / DC-HSDPA / HSPA+, and according to the following RF output power, the output power results of the secondary modes (HSDPA / HSUPA / DC-HSDPA / HSPA+) are less than $\frac{1}{4}$ dB higher than the primary modes; therefore, SAR measurement is not required for HSDPA / HSUPA / DC-HSDPA / HSPA+.

LTE Note:

1. Per KDB 941225 D05v02r05, start with the largest channel bandwidth and measure SAR for QPSK with 1 RB allocation, using the RB offset and required test channel combination with the highest maximum output power for RB offsets at the upper edge, middle and lower edge of each required test channel.
2. Per KDB 941225 D05v02r05, 50% RB allocation for QPSK SAR testing follows 1RB QPSK allocation procedure.
3. Per KDB 941225 D05v02r05, for QPSK with 100% RB allocation, SAR is not required when the highest maximum output power for 100 % RB allocation is less than the highest maximum output power in 50% and 1 RB allocations and the highest reported SAR for 1 RB and 50% RB allocation are ≤ 0.8 W/kg. Otherwise, SAR is measured for the highest output power channel; and if the reported SAR is > 1.45 W/kg, the remaining required test channels must also be tested.
4. Per KDB 941225 D05v02r05, 16QAM output power for each RB allocation configuration is $>$ not $\frac{1}{2}$ dB higher than the same configuration in QPSK and the reported SAR for the QPSK configuration is ≤ 1.45 W/kg; Per KDB 941225 D05v02r05, 16QAM/64QAM SAR testing is not required.
5. Per KDB 941225 D05v02r05, smaller bandwidth output power for each RB allocation configuration is $>$ not $\frac{1}{2}$ dB higher than the same configuration in the largest supported bandwidth, and the reported SAR for the largest supported bandwidth is ≤ 1.45 W/kg; Per KDB 941225 D05v02r05, smaller bandwidth SAR testing is not required.
6. For LTE B4 / B5 / B12 / B38 the maximum bandwidth does not support three non-overlapping channels, per KDB 941225 D05v02r05, when a device supports overlapping channel assignment in a channel bandwidth configuration, the middle channel of the group of overlapping channels should be selected for testing.

5G NR Note:

For 5G NR test procedure was following step similar FCC KDB 941225 D05:

- a. SAR testing start with the largest channel bandwidth and measure SAR for QPSK with 1 RB allocation, using the RB offset and required test channel combination with the highest maximum output power for RB offsets at the upper edge, middle and lower edge of each required test channel.
- b. 50% RB allocation for QPSK SAR testing follows 1RB QPSK allocation procedure
- c. QPSK with 100% RB allocation, SAR is not required when the highest maximum output power for 100 % RB allocation is less than the highest maximum output power in 50% and 1 RB allocations and the highest reported SAR for 1 RB and 50% RB allocation are ≤ 0.8 W/kg. Otherwise, SAR is measured for the highest output power channel; and if the reported SAR is > 1.45 W/kg, the remaining required test channels must also be tested.
- d. PI/2 BPSK/16QAM/64QAM/256QAM output powers according to 3GPP MPR will not $\frac{1}{2}$ dB higher than the same configuration in QPSK, also reported SAR for the QPSK configuration is less than 1.45 W/kg, PI/2 BPSK/16QAM /64QAM/256QAM SAR testing are not required.
- e. Smaller bandwidth output power for each RB allocation configuration for this device will not $\frac{1}{2}$ dB higher than the same configuration in the largest supported bandwidth, and the reported SAR for the largest supported bandwidth is ≤ 1.45 W/kg, smaller bandwidth SAR testing is not required for this device.
- f. For 5G FR1 n41/n77 the maximum bandwidth does not support three non-overlapping channels, when a device supports overlapping channel assignment in a channel bandwidth configuration, the middle channel of the group of overlapping channels should be selected for testing.



15.1 Head SAR

Plot No.	No.	Band	BW (MHz)	Modulation	RB Size	RB offset	Mode	Test Position	Gap (mm)	Antenna	Ch.	Freq. (MHz)	Sample	Average Power (dBm)	Tune-Up Limit (dBm)	Tune-up Scaling Factor	Duty Cycle %	Duty Cycle Scaling Factor	Power Drift (dB)	Measured 1g SAR (W/kg)	Reported 1g SAR (W/kg)	Deviation d _{dB} (dB)		
750MHz																								
01	1st	LTE Band 12	10M	QPSK	25	0	-	Right Tilted	0mm	Ant 0	23095	707.5	1	22.18	23.00	1.208	-	-	-0.08	0.178	0.215	2.68		
	2nd	LTE Band 12	10M	QPSK	25	0	-	Right Tilted	0mm	Ant 0	23095	707.5	1	22.12	23.00	1.225	-	-	0.06	0.095	0.116			
835MHz																								
02	1st	GSM850	-	-	-	-	GPRS (3 Tx slots)	Right Cheek	0mm	Ant 0	189	836.4	1	26.89	28.00	1.291	-	-	-0.15	0.281	0.363	0.00		
	2nd	GSM850	-	-	-	-	GPRS (3 Tx slots)	Right Cheek	0mm	Ant 0	189	836.4	1	26.79	28.00	1.321	-	-	-0.09	0.275	0.363			
03	1st	WCDMA V	-	-	-	-	RMC 12.2Kbps	Right Cheek	0mm	Ant 0	4182	836.4	1	23.34	24.50	1.306	-	-	0.02	0.254	0.332	2.78		
	2nd	WCDMA V	-	-	-	-	RMC 12.2Kbps	Right Cheek	0mm	Ant 0	4182	836.4	1	23.17	24.50	1.358	-	-	0.08	0.129	0.175			
04	1st	LTE Band 5	10M	QPSK	1	0	-	Right Cheek	0mm	Ant 0	20525	836.5	1	23.26	24.50	1.330	-	-	0.03	0.259	0.345	0.09		
	2nd	LTE Band 5	10M	QPSK	1	0	-	Right Cheek	0mm	Ant 0	20525	836.5	1	23.12	24.50	1.374	-	-	0.02	0.246	0.338			
1750MHz																								
05	2nd	LTE Band 4	20M	QPSK	1	0	-	Right Cheek	0mm	Ant 1	20175	1732.5	1	18.54	20.00	1.400	-	-	0.08	0.035	0.049			
	2nd	LTE Band 4	20M	QPSK	50	0	-	Right Cheek	0mm	Ant 1	20175	1732.5	1	18.43	20.00	1.435	-	-	0.01	0.038	0.055			
	2nd	LTE Band 4	20M	QPSK	1	0	-	Right Tilted	0mm	Ant 1	20175	1732.5	1	18.54	20.00	1.400	-	-	0.03	0.000	0.000			
	2nd	LTE Band 4	20M	QPSK	50	0	-	Right Tilted	0mm	Ant 1	20175	1732.5	1	18.43	20.00	1.435	-	-	-0.08	0.000	0.000			
	2nd	LTE Band 4	20M	QPSK	1	0	-	Left Cheek	0mm	Ant 1	20175	1732.5	1	18.54	20.00	1.400	-	-	-0.08	0.059	0.083			
	2nd	LTE Band 4	20M	QPSK	50	0	-	Left Cheek	0mm	Ant 1	20175	1732.5	1	18.43	20.00	1.435	-	-	0.06	0.064	0.092			
	2nd	LTE Band 4	20M	QPSK	1	0	-	Left Tilted	0mm	Ant 1	20175	1732.5	1	18.54	20.00	1.400	-	-	0.1	0.000	0.000			
	2nd	LTE Band 4	20M	QPSK	50	0	-	Left Tilted	0mm	Ant 1	20175	1732.5	1	18.43	20.00	1.435	-	-	-0.18	0.000	0.000			
	2nd	WCDMA IV	-	-	-	-	-	RMC 12.2Kbps	Right Cheek	0mm	Ant 1	1413	1732.6	1	20.22	21.00	1.197	-	-	0.08	0.064		0.077	
	2nd	WCDMA IV	-	-	-	-	-	RMC 12.2Kbps	Right Tilted	0mm	Ant 1	1413	1732.6	1	20.22	21.00	1.197	-	-	0.01	0.044		0.053	
	56	2nd	WCDMA IV	-	-	-	-	RMC 12.2Kbps	Left Cheek	0mm	Ant 1	1413	1732.6	1	20.22	21.00	1.197	-	-	0.06	0.100		0.119	
	2nd	WCDMA IV	-	-	-	-	-	RMC 12.2Kbps	Left Tilted	0mm	Ant 1	1413	1732.6	1	20.22	21.00	1.197	-	-	0.03	0.054		0.065	
1900MHz																								
06	1st	GSM1900	-	-	-	-	GPRS (4 Tx slots)	Left Cheek	0mm	Ant 1	661	1880	1	22.28	23.50	1.324	-	-	0.06	0.204	0.270	2.09		
	2nd	GSM1900	-	-	-	-	GPRS (4 Tx slots)	Left Cheek	0mm	Ant 1	661	1880	1	22.13	23.50	1.371	-	-	0.03	0.122	0.167			
07	2nd	WCDMA II	-	-	-	-	RMC 12.2Kbps	Right Cheek	0mm	Ant 1	9400	1880	1	19.45	21.00	1.429	-	-	0.1	0.035	0.050			
	2nd	WCDMA II	-	-	-	-	RMC 12.2Kbps	Right Tilted	0mm	Ant 1	9400	1880	1	19.45	21.00	1.429	-	-	0.12	0.042	0.060			
	2nd	WCDMA II	-	-	-	-	RMC 12.2Kbps	Left Cheek	0mm	Ant 1	9400	1880	1	19.45	21.00	1.429	-	-	0.02	0.089	0.127			
	2nd	WCDMA II	-	-	-	-	RMC 12.2Kbps	Left Tilted	0mm	Ant 1	9400	1880	1	19.45	21.00	1.429	-	-	0.08	0.048	0.069			
08	2nd	LTE Band 2	20M	QPSK	1	0	-	Right Cheek	0mm	Ant 1	18900	1880	1	18.59	20.00	1.384	-	-	0.08	0.048	0.066			
	2nd	LTE Band 2	20M	QPSK	50	0	-	Right Cheek	0mm	Ant 1	18900	1880	1	18.55	20.00	1.396	-	-	0.01	0.051	0.071			
	2nd	LTE Band 2	20M	QPSK	1	0	-	Right Tilted	0mm	Ant 1	18900	1880	1	18.59	20.00	1.384	-	-	0.03	0.056	0.077			
	2nd	LTE Band 2	20M	QPSK	50	0	-	Right Tilted	0mm	Ant 1	18900	1880	1	18.55	20.00	1.396	-	-	-0.08	0.057	0.080			
	2nd	LTE Band 2	20M	QPSK	1	0	-	Left Cheek	0mm	Ant 1	18900	1880	1	18.59	20.00	1.384	-	-	-0.08	0.087	0.120			
	2nd	LTE Band 2	20M	QPSK	50	0	-	Left Cheek	0mm	Ant 1	18900	1880	1	18.55	20.00	1.396	-	-	-0.08	0.090	0.126			
08	2nd	LTE Band 2	20M	QPSK	1	0	-	Left Tilted	0mm	Ant 1	18900	1880	1	18.59	20.00	1.384	-	-	0.1	0.059	0.082			
	2nd	LTE Band 2	20M	QPSK	50	0	-	Left Tilted	0mm	Ant 1	18900	1880	1	18.55	20.00	1.396	-	-	-0.18	0.055	0.077			
2600MHz																								
09	2nd	LTE Band 38	20M	QPSK	1	0	-	Right Cheek	0mm	Ant 0	38000	2595	1	19.15	20.00	1.216	62.9	1.006	0.1	0.000	0.000			
	2nd	LTE Band 38	20M	QPSK	50	0	-	Right Cheek	0mm	Ant 0	38000	2595	1	19.05	20.00	1.245	62.9	1.006	0.12	0.000	0.000			
	2nd	LTE Band 38	20M	QPSK	1	0	-	Right Tilted	0mm	Ant 0	38000	2595	1	19.15	20.00	1.216	62.9	1.006	0.08	0.000	0.000			
	2nd	LTE Band 38	20M	QPSK	50	0	-	Right Tilted	0mm	Ant 0	38000	2595	1	19.05	20.00	1.245	62.9	1.006	-0.17	0.000	0.000			
	2nd	LTE Band 38	20M	QPSK	1	0	-	Left Cheek	0mm	Ant 0	38000	2595	1	19.15	20.00	1.216	62.9	1.006	0.09	0.006	0.007			
	2nd	LTE Band 38	20M	QPSK	50	0	-	Left Cheek	0mm	Ant 0	38000	2595	1	19.05	20.00	1.245	62.9	1.006	-0.03	0.002	0.003			
	2nd	LTE Band 38	20M	QPSK	1	0	-	Left Tilted	0mm	Ant 0	38000	2595	1	19.15	20.00	1.216	62.9	1.006	0.14	0.000	0.000			
	2nd	LTE Band 38	20M	QPSK	50	0	-	Left Tilted	0mm	Ant 0	38000	2595	1	19.05	20.00	1.245	62.9	1.006	0.11	0.000	0.000			
	10	1st	LTE Band 41	20M	QPSK	1	0	-	Left Cheek	0mm	Ant 0	40620	2593	1	18.30	19.00	1.175	62.9	1.006	0.01	0.006		0.007	0.67
		2nd	LTE Band 41	20M	QPSK	1	0	-	Left Cheek	0mm	Ant 0	40620	2593	1	18.05	19.00	1.245	62.9	1.006	-0.04	0.005		0.006	
2nd	FR1 n41	30M	QPSK	1	1	1	DFT-SCS-30KHz	Right Cheek	0mm	Ant 0	518598	2593	1	17.29	18.50	1.321	-	-	-0.05	0.000	0.000			



FCC SAR Test Report

Report No. : FA3D0613-06

2nd	FR1 n41	30M	QPSK	36	18	DFT-SCS-30KHz	Right Cheek	0mm	Ant 0	518598	2593	1	17.19	18.50	1.352	-	-	0.18	0.000	0.000	
2nd	FR1 n41	30M	QPSK	1	1	DFT-SCS-30KHz	Right Tilted	0mm	Ant 0	518598	2593	1	17.29	18.50	1.321	-	-	0.14	0.000	0.000	
2nd	FR1 n41	30M	QPSK	36	18	DFT-SCS-30KHz	Right Tilted	0mm	Ant 0	518598	2593	1	17.19	18.50	1.352	-	-	-0.17	0.000	0.000	
11	2nd	FR1 n41	30M	QPSK	1	1	DFT-SCS-30KHz	Left Cheek	0mm	Ant 0	518598	2593	1	17.29	18.50	1.321	-	-	0.04	0.004	0.005
2nd	FR1 n41	30M	QPSK	36	18	DFT-SCS-30KHz	Left Cheek	0mm	Ant 0	518598	2593	1	17.19	18.50	1.352	-	-	0.17	0.002	0.003	
2nd	FR1 n41	30M	QPSK	1	1	DFT-SCS-30KHz	Left Tilted	0mm	Ant 0	518598	2593	1	17.29	18.50	1.321	-	-	-0.05	0.000	0.000	
2nd	FR1 n41	30M	QPSK	36	18	DFT-SCS-30KHz	Left Tilted	0mm	Ant 0	518598	2593	1	17.19	18.50	1.352	-	-	0.01	0.000	0.000	
3500MHz																					
1st	LTE Band 42	20M	QPSK	1	0	-	Right Tilted	0mm	Ant 0	42590	3500	1	14.92	16.00	1.282	62.9	1.006	0.06	0.015	0.019	2.37
12	2nd	LTE Band 42	20M	QPSK	1	0	-	Right Tilted	0mm	Ant 0	42590	3500	1	15.45	16.00	1.135	62.9	1.006	-0.09	0.010	0.011
13	2nd	FR1 n77 Part 27Q	100M	QPSK	1	1	DFT-SCS-30KHz	Right Cheek	0mm	Ant 0	656000	3840	1	15.91	17.00	1.285	-	-	-0.04	0.020	0.026
2nd	FR1 n77 Part 27Q	100M	QPSK	135	69	DFT-SCS-30KHz	Right Cheek	0mm	Ant 0	656000	3840	1	15.82	17.00	1.312	-	-	0.1	0.000	0.000	
2nd	FR1 n77 Part 27Q	100M	QPSK	1	1	DFT-SCS-30KHz	Right Tilted	0mm	Ant 0	656000	3840	1	15.91	17.00	1.285	-	-	-0.17	0.000	0.000	
2nd	FR1 n77 Part 27Q	100M	QPSK	135	69	DFT-SCS-30KHz	Right Tilted	0mm	Ant 0	656000	3840	1	15.82	17.00	1.312	-	-	0.04	0.000	0.000	
2nd	FR1 n77 Part 27Q	100M	QPSK	1	1	DFT-SCS-30KHz	Left Cheek	0mm	Ant 0	656000	3840	1	15.91	17.00	1.285	-	-	-0.01	0.000	0.000	
2nd	FR1 n77 Part 27Q	100M	QPSK	135	69	DFT-SCS-30KHz	Left Cheek	0mm	Ant 0	656000	3840	1	15.82	17.00	1.312	-	-	-0.08	0.000	0.000	
2nd	FR1 n77 Part 27Q	100M	QPSK	1	1	DFT-SCS-30KHz	Left Tilted	0mm	Ant 0	656000	3840	1	15.91	17.00	1.285	-	-	0.05	0.014	0.018	
2nd	FR1 n77 Part 27Q	100M	QPSK	135	69	DFT-SCS-30KHz	Left Tilted	0mm	Ant 0	656000	3840	1	15.82	17.00	1.312	-	-	0.06	0.000	0.000	
2nd	FR1 n77 Part 27Q	100M	QPSK	1	1	DFT-SCS-30KHz	Right Cheek	0mm	Ant 0	633332	3500	1	15.85	17.00	1.303	-	-	0.02	0.001	0.001	
2nd	FR1 n77 Part 27Q	100M	QPSK	135	69	DFT-SCS-30KHz	Right Cheek	0mm	Ant 0	633332	3500	1	15.77	17.00	1.327	-	-	-0.08	0.000	0.000	
2nd	FR1 n77 Part 27Q	100M	QPSK	1	1	DFT-SCS-30KHz	Right Tilted	0mm	Ant 0	633332	3500	1	15.85	17.00	1.303	-	-	0.13	0.000	0.000	
2nd	FR1 n77 Part 27Q	100M	QPSK	135	69	DFT-SCS-30KHz	Right Tilted	0mm	Ant 0	633332	3500	1	15.77	17.00	1.327	-	-	0.12	0.000	0.000	
2nd	FR1 n77 Part 27Q	100M	QPSK	1	1	DFT-SCS-30KHz	Left Cheek	0mm	Ant 0	633332	3500	1	15.85	17.00	1.303	-	-	0.03	0.000	0.000	
2nd	FR1 n77 Part 27Q	100M	QPSK	135	69	DFT-SCS-30KHz	Left Cheek	0mm	Ant 0	633332	3500	1	15.77	17.00	1.327	-	-	0.18	0.000	0.000	
2nd	FR1 n77 Part 27Q	100M	QPSK	1	1	DFT-SCS-30KHz	Left Tilted	0mm	Ant 0	633332	3500	1	15.85	17.00	1.303	-	-	0.16	0.000	0.000	
2nd	FR1 n77 Part 27Q	100M	QPSK	135	69	DFT-SCS-30KHz	Left Tilted	0mm	Ant 0	633332	3500	1	15.77	17.00	1.327	-	-	-0.1	0.000	0.000	

Plot No.	No.	Band	Mode	Test Position	Gap (mm)	Antenna Ch.	Freq. (MHz)	Sample	Average Power (dBm)	Tune-Up Limit (dBm)	Tune-up Scaling Factor	Duty Cycle %	Duty Cycle Scaling Factor	Power Drift (dB)	Measured 1g SAR (W/kg)	Reported 1g SAR (W/kg)	Deviation d _{dB} (dB)
2450MHz																	
14	1st	WLAN2.4GHz	802.11b 1Mbps	Right Tilted	0mm	Ant 6	1	2412	11.49	13.00	1.416	100	1.000	0.07	0.248	0.351	0.01
14	2nd	WLAN2.4GHz	802.11b 1Mbps	Right Tilted	0mm	Ant 6	1	2412	11.42	13.00	1.439	100	1.000	0.08	0.243	0.350	
15	1st	Bluetooth	1Mbps	Right Tilted	0mm	Ant 6	78	2480	12.90	14.00	1.287	77.04	1.081	0.05	0.204	0.284	0.00
15	2nd	Bluetooth	1Mbps	Right Tilted	0mm	Ant 6	78	2480	12.83	14.00	1.309	77.04	1.081	-0.05	0.201	0.284	
5000MHz																	
16	1st	WLAN5.3GHz	802.11n-HT40 MCS0	Right Tilted	0mm	Ant 8	54	5270	10.73	12.50	1.504	95.13	1.051	0.01	0.007	0.011	1.38
16	2nd	WLAN5.3GHz	802.11n-HT40 MCS0	Right Tilted	0mm	Ant 8	54	5270	10.61	12.50	1.545	95.13	1.051	0.09	0.005	0.008	
17	1st	WLAN5.5GHz	802.11n-HT40 MCS0	Right Cheek	0mm	Ant 8	134	5670	10.84	12.50	1.467	95.13	1.051	0.01	0.042	0.064	0.00
17	2nd	WLAN5.5GHz	802.11n-HT40 MCS0	Right Cheek	0mm	Ant 8	134	5670	10.70	12.50	1.514	95.13	1.051	0	0.040	0.064	
18	1st	WLAN5.8GHz	802.11n-HT40 MCS0	Right Cheek	0mm	Ant 8	151	5755	10.74	12.50	1.501	95.13	1.051	-0.09	0.117	0.185	2.42
18	2nd	WLAN5.8GHz	802.11n-HT40 MCS0	Right Cheek	0mm	Ant 8	151	5755	10.64	12.50	1.535	95.13	1.051	0	0.066	0.106	



15.2 Hotspot SAR

Plot No.	No.	Band	BW (MHz)	Modulation	RB Size	RB offset	Mode	Test Position	Gap (mm)	Antenna	Ch.	Freq. (MHz)	Sample	Average Power (dBm)	Tune-Up Limit (dBm)	Tune-up Scaling Factor	Duty Cycle %	Duty Cycle Scaling Factor	Power Drift (dB)	Measured 1g SAR (W/kg)	Reported 1g SAR (W/kg)	Deviation d _{dB} (dB)
750MHz																						
	1st	LTE Band 12	10M	QPSK	1	0	-	Back	5mm	Ant 0	23095	707.5	1	23.17	24.00	1.211	-	-	-0.02	0.442	0.535	0.04
19	2nd	LTE Band 12	10M	QPSK	1	0	-	Back	5mm	Ant 0	23095	707.5	1	23.02	24.00	1.253	-	-	0.17	0.423	0.530	
835MHz																						
	1st	GSM850	-	-	-	-	GPRS (3 Tx slots)	Back	5mm	Ant 0	189	836.4	1	26.89	28.00	1.291	-	-	0.05	0.465	0.600	0.06
20	2nd	GSM850	-	-	-	-	GPRS (3 Tx slots)	Back	5mm	Ant 0	189	836.4	1	26.79	28.00	1.321	-	-	0.04	0.448	0.592	
	1st	WCDMA V	-	-	-	-	RMC 12.2Kbps	Back	5mm	Ant 0	4233	846.6	1	23.28	24.50	1.324	-	-	-0.01	0.667	0.883	0.01
21	2nd	WCDMA V	-	-	-	-	RMC 12.2Kbps	Back	5mm	Ant 0	4233	846.6	1	23.11	24.50	1.377	-	-	0.05	0.639	0.880	
	1st	LTE Band 5	10M	QPSK	1	0	-	Back	5mm	Ant 0	20525	836.5	1	23.26	24.50	1.330	-	-	0.09	0.707	0.941	0.04
22	2nd	LTE Band 5	10M	QPSK	1	0	-	Back	5mm	Ant 0	20525	836.5	1	23.12	24.50	1.374	-	-	0.03	0.679	0.933	
1750MHz																						
	2nd	LTE Band 4	20M	QPSK	1	0	RMC 12.2Kbps	Front	5mm	Ant 1	20175	1732.5	1	18.54	20.00	1.400	-	-	0.08	0.350	0.490	0.04
	2nd	LTE Band 4	20M	QPSK	50	0	RMC 12.2Kbps	Front	5mm	Ant 1	20175	1732.5	1	18.43	20.00	1.435	-	-	0.01	0.334	0.479	
	2nd	LTE Band 4	20M	QPSK	1	0	RMC 12.2Kbps	Back	5mm	Ant 1	20175	1732.5	1	18.54	20.00	1.400	-	-	0.03	0.401	0.561	
23	2nd	LTE Band 4	20M	QPSK	50	0	RMC 12.2Kbps	Back	5mm	Ant 1	20175	1732.5	1	18.43	20.00	1.435	-	-	-0.08	0.425	0.610	
	2nd	LTE Band 4	20M	QPSK	1	0	RMC 12.2Kbps	Left Side	5mm	Ant 1	20175	1732.5	1	18.54	20.00	1.400	-	-	-0.15	0.218	0.305	
	2nd	LTE Band 4	20M	QPSK	50	0	RMC 12.2Kbps	Left Side	5mm	Ant 1	20175	1732.5	1	18.43	20.00	1.435	-	-	0.19	0.235	0.337	
	2nd	LTE Band 4	20M	QPSK	1	0	RMC 12.2Kbps	Right Side	5mm	Ant 1	20175	1732.5	1	18.54	20.00	1.400	-	-	0.07	0.039	0.055	
	2nd	LTE Band 4	20M	QPSK	50	0	RMC 12.2Kbps	Right Side	5mm	Ant 1	20175	1732.5	1	18.43	20.00	1.435	-	-	-0.18	0.040	0.057	
	2nd	LTE Band 4	20M	QPSK	1	0	RMC 12.2Kbps	Bottom Side	5mm	Ant 1	20175	1732.5	1	18.54	20.00	1.400	-	-	0.03	0.366	0.512	
	2nd	LTE Band 4	20M	QPSK	50	0	RMC 12.2Kbps	Bottom Side	5mm	Ant 1	20175	1732.5	1	18.43	20.00	1.435	-	-	-0.15	0.377	0.541	
	2nd	WCDMA IV	-	-	-	-	RMC 12.2Kbps	Front	5mm	Ant 1	1413	1732.6	1	20.22	21.00	1.197	-	-	-0.08	0.523	0.626	
	2nd	WCDMA IV	-	-	-	-	RMC 12.2Kbps	Back	5mm	Ant 1	1413	1732.6	1	20.22	21.00	1.197	-	-	-0.08	0.670	0.802	
	2nd	WCDMA IV	-	-	-	-	RMC 12.2Kbps	Back	5mm	Ant 1	1312	1712.4	1	20.12	21.00	1.225	-	-	0.1	0.643	0.787	
57	2nd	WCDMA IV	-	-	-	-	RMC 12.2Kbps	Back	5mm	Ant 1	1513	1752.6	1	20.15	21.00	1.216	-	-	-0.02	0.704	0.856	
	2nd	WCDMA IV	-	-	-	-	RMC 12.2Kbps	Left Side	5mm	Ant 1	1413	1732.6	1	20.22	21.00	1.197	-	-	-0.18	0.369	0.442	
	2nd	WCDMA IV	-	-	-	-	RMC 12.2Kbps	Right Side	5mm	Ant 1	1413	1732.6	1	20.22	21.00	1.197	-	-	0.1	0.060	0.072	
	2nd	WCDMA IV	-	-	-	-	RMC 12.2Kbps	Bottom Side	5mm	Ant 1	1413	1732.6	1	20.22	21.00	1.197	-	-	0.12	0.595	0.712	
1900MHz																						
	1st	GSM1900	-	-	-	-	GPRS (4 Tx slots)	Back	5mm	Ant 1	661	1880	1	22.28	23.50	1.324	-	-	-0.06	0.594	0.787	0.93
24	2nd	GSM1900	-	-	-	-	GPRS (4 Tx slots)	Back	5mm	Ant 1	661	1880	1	22.13	23.50	1.371	-	-	-0.17	0.463	0.635	
	2nd	WCDMA II	-	-	-	-	RMC 12.2Kbps	Front	5mm	Ant 1	9400	1880	1	19.45	21.00	1.429	-	-	-0.08	0.477	0.682	
	2nd	WCDMA II	-	-	-	-	RMC 12.2Kbps	Back	5mm	Ant 1	9400	1880	1	19.45	21.00	1.429	-	-	0.1	0.573	0.819	
	2nd	WCDMA II	-	-	-	-	RMC 12.2Kbps	Left Side	5mm	Ant 1	9400	1880	1	19.45	21.00	1.429	-	-	-0.15	0.394	0.563	
	2nd	WCDMA II	-	-	-	-	RMC 12.2Kbps	Right Side	5mm	Ant 1	9400	1880	1	19.45	21.00	1.429	-	-	0.11	0.053	0.076	
	2nd	WCDMA II	-	-	-	-	RMC 12.2Kbps	Bottom Side	5mm	Ant 1	9400	1880	1	19.45	21.00	1.429	-	-	-0.08	0.466	0.666	
25	2nd	WCDMA II	-	-	-	-	RMC 12.2Kbps	Back	5mm	Ant 1	9262	1852.4	1	19.40	21.00	1.445	-	-	-0.18	0.606	0.876	
	2nd	WCDMA II	-	-	-	-	RMC 12.2Kbps	Back	5mm	Ant 1	9538	1907.6	1	19.43	21.00	1.435	-	-	-0.18	0.542	0.778	
	2nd	LTE Band 2	20M	QPSK	1	0	RMC 12.2Kbps	Front	5mm	Ant 1	18900	1880	1	18.59	20.00	1.384	-	-	0.12	0.409	0.566	
	2nd	LTE Band 2	20M	QPSK	50	0	RMC 12.2Kbps	Front	5mm	Ant 1	18900	1880	1	18.55	20.00	1.396	-	-	0.08	0.409	0.571	
26	2nd	LTE Band 2	20M	QPSK	1	0	RMC 12.2Kbps	Back	5mm	Ant 1	18900	1880	1	18.59	20.00	1.384	-	-	-0.07	0.477	0.660	
	2nd	LTE Band 2	20M	QPSK	50	0	RMC 12.2Kbps	Back	5mm	Ant 1	18900	1880	1	18.55	20.00	1.396	-	-	-0.17	0.470	0.656	
	2nd	LTE Band 2	20M	QPSK	1	0	RMC 12.2Kbps	Left Side	5mm	Ant 1	18900	1880	1	18.59	20.00	1.384	-	-	-0.17	0.298	0.412	
	2nd	LTE Band 2	20M	QPSK	50	0	RMC 12.2Kbps	Left Side	5mm	Ant 1	18900	1880	1	18.55	20.00	1.396	-	-	-0.08	0.332	0.464	
	2nd	LTE Band 2	20M	QPSK	1	0	RMC 12.2Kbps	Right Side	5mm	Ant 1	18900	1880	1	18.59	20.00	1.384	-	-	-0.04	0.052	0.072	
	2nd	LTE Band 2	20M	QPSK	50	0	RMC 12.2Kbps	Right Side	5mm	Ant 1	18900	1880	1	18.55	20.00	1.396	-	-	-0.08	0.047	0.066	
	2nd	LTE Band 2	20M	QPSK	1	0	RMC 12.2Kbps	Bottom Side	5mm	Ant 1	18900	1880	1	18.59	20.00	1.384	-	-	0.17	0.411	0.569	
	2nd	LTE Band 2	20M	QPSK	50	0	RMC 12.2Kbps	Bottom Side	5mm	Ant 1	18900	1880	1	18.55	20.00	1.396	-	-	0.18	0.408	0.570	
2600MHz																						
	2nd	LTE Band 38	20M	QPSK	1	0	-	Front	5mm	Ant 0	38000	2595	1	19.15	20.00	1.216	62.9	1.006	-0.03	0.141	0.173	
	2nd	LTE Band 38	20M	QPSK	50	0	-	Front	5mm	Ant 0	38000	2595	1	19.05	20.00	1.245	62.9	1.006	0.14	0.127	0.159	
27	2nd	LTE Band 38	20M	QPSK	1	0	-	Back	5mm	Ant 0	38000	2595	1	19.15	20.00	1.216	62.9	1.006	0.05	0.709	0.867	



FCC SAR Test Report

Report No. : FA3D0613-06

2nd	LTE Band 38	20M	QPSK	1	0	-	Back	5mm	Ant 0	38000	2595	2	19.15	20.00	1.216	62.9	1.006	0.11	0.659	0.806	
2nd	LTE Band 38	20M	QPSK	1	0	-	Back	5mm	Ant 0	38000	2595	1	19.02	20.00	1.253	62.9	1.006	-0.05	0.643	0.811	
2nd	LTE Band 38	20M	QPSK	1	0	-	Back	5mm	Ant 0	37850	2580	1	19.01	20.00	1.256	62.9	1.006	0.18	0.648	0.819	
2nd	LTE Band 38	20M	QPSK	50	0	-	Back	5mm	Ant 0	38150	2610	1	19.05	20.00	1.245	62.9	1.006	0.14	0.603	0.755	
2nd	LTE Band 38	20M	QPSK	50	0	-	Back	5mm	Ant 0	38000	2595	1	18.98	20.00	1.265	62.9	1.006	-0.17	0.614	0.781	
2nd	LTE Band 38	20M	QPSK	50	0	-	Back	5mm	Ant 0	38000	2595	1	19.06	20.00	1.242	62.9	1.006	0.17	0.617	0.771	
2nd	LTE Band 38	20M	QPSK	100	0	-	Back	5mm	Ant 0	38000	2595	1	18.99	20.00	1.262	62.9	1.006	-0.05	0.595	0.755	
2nd	LTE Band 38	20M	QPSK	1	0	-	Left Side	5mm	Ant 0	38000	2595	1	19.15	20.00	1.216	62.9	1.006	0.05	0.000	0.000	
2nd	LTE Band 38	20M	QPSK	50	0	-	Left Side	5mm	Ant 0	38000	2595	1	19.05	20.00	1.245	62.9	1.006	-0.11	0.000	0.000	
2nd	LTE Band 38	20M	QPSK	1	0	-	Right Side	5mm	Ant 0	38000	2595	1	19.15	20.00	1.216	62.9	1.006	-0.12	0.000	0.000	
2nd	LTE Band 38	20M	QPSK	50	0	-	Right Side	5mm	Ant 0	38000	2595	1	19.05	20.00	1.245	62.9	1.006	0.03	0.000	0.000	
2nd	LTE Band 38	20M	QPSK	1	0	-	Bottom Side	5mm	Ant 0	38000	2595	1	19.15	20.00	1.216	62.9	1.006	-0.16	0.353	0.432	
2nd	LTE Band 38	20M	QPSK	50	0	-	Bottom Side	5mm	Ant 0	38000	2595	1	19.05	20.00	1.245	62.9	1.006	-0.02	0.385	0.482	
1st	LTE Band 41	20M	QPSK	1	0	-	Back	5mm	Ant 0	40620	2593	1	18.30	19.00	1.175	62.9	1.006	0.03	0.686	0.811	0.70
28 2nd	LTE Band 41	20M	QPSK	1	0	-	Back	5mm	Ant 0	40620	2593	1	18.05	19.00	1.245	62.9	1.006	0.01	0.551	0.690	
2nd	FR1 n41	30M	QPSK	1	1	DFT-SCS-30KHz	Front	5mm	Ant 0	518598	2593	1	17.29	18.50	1.321	-	-	0.01	0.178	0.235	
2nd	FR1 n41	30M	QPSK	36	18	DFT-SCS-30KHz	Front	5mm	Ant 0	518598	2593	1	17.19	18.50	1.352	-	-	0.1	0.160	0.216	
29 2nd	FR1 n41	30M	QPSK	1	1	DFT-SCS-30KHz	Back	5mm	Ant 0	518598	2593	1	17.29	18.50	1.321	-	-	-0.03	0.892	1.179	
2nd	FR1 n41	30M	QPSK	1	1	DFT-SCS-30KHz	Back	5mm	Ant 0	518598	2593	2	17.29	18.50	1.321	-	-	-0.17	0.858	1.134	
2nd	FR1 n41	30M	QPSK	1	1	DFT-SCS-30KHz	Back	5mm	Ant 0	502200	2511	1	17.06	18.50	1.393	-	-	-0.01	0.810	1.128	
2nd	FR1 n41	30M	QPSK	1	1	DFT-SCS-30KHz	Back	5mm	Ant 0	534996	2675	1	16.87	18.50	1.455	-	-	-0.08	0.805	1.172	
2nd	FR1 n41	30M	QPSK	36	18	DFT-SCS-30KHz	Back	5mm	Ant 0	518598	2593	1	17.19	18.50	1.352	-	-	0.05	0.759	1.026	
2nd	FR1 n41	30M	QPSK	36	18	DFT-SCS-30KHz	Back	5mm	Ant 0	502200	2511	1	17.03	18.50	1.403	-	-	0.06	0.772	1.083	
2nd	FR1 n41	30M	QPSK	36	18	DFT-SCS-30KHz	Back	5mm	Ant 0	534996	2675	1	17.00	18.50	1.413	-	-	-0.09	0.776	1.096	
2nd	FR1 n41	30M	QPSK	75	0	DFT-SCS-30KHz	Back	5mm	Ant 0	518598	2593	1	17.12	18.50	1.374	-	-	-0.08	0.749	1.029	
2nd	FR1 n41	30M	QPSK	1	1	DFT-SCS-30KHz	Left Side	5mm	Ant 0	518598	2593	1	17.29	18.50	1.321	-	-	0.02	0.000	0.000	
2nd	FR1 n41	30M	QPSK	36	18	DFT-SCS-30KHz	Left Side	5mm	Ant 0	518598	2593	1	17.19	18.50	1.352	-	-	0.02	0.000	0.000	
2nd	FR1 n41	30M	QPSK	1	1	DFT-SCS-30KHz	Right Side	5mm	Ant 0	518598	2593	1	17.29	18.50	1.321	-	-	0.07	0.000	0.000	
2nd	FR1 n41	30M	QPSK	36	18	DFT-SCS-30KHz	Right Side	5mm	Ant 0	518598	2593	1	17.19	18.50	1.352	-	-	0.16	0.000	0.000	
2nd	FR1 n41	30M	QPSK	1	1	DFT-SCS-30KHz	Bottom Side	5mm	Ant 0	518598	2593	1	17.29	18.50	1.321	-	-	0.13	0.446	0.589	
2nd	FR1 n41	30M	QPSK	36	18	DFT-SCS-30KHz	Bottom Side	5mm	Ant 0	518598	2593	1	17.19	18.50	1.352	-	-	-0.18	0.482	0.652	
3500MHz																					
1st	LTE Band 42	20M	QPSK	1	0	-	Back	5mm	Ant 0	42590	3500	1	14.92	16.00	1.282	62.9	1.006	0.01	0.332	0.428	0.08
30 2nd	LTE Band 42	20M	QPSK	1	0	-	Back	5mm	Ant 0	42590	3500	1	15.45	16.00	1.135	62.9	1.006	0	0.368	0.420	
2nd	FR1 n77 Part 27Q	100M	QPSK	1	1	DFT-SCS-30KHz	Front	5mm	Ant 0	656000	3840	1	15.91	17.00	1.285	-	-	0.13	0.100	0.129	
2nd	FR1 n77 Part 27Q	100M	QPSK	135	69	DFT-SCS-30KHz	Front	5mm	Ant 0	656000	3840	1	15.82	17.00	1.312	-	-	0.12	0.100	0.131	
2nd	FR1 n77 Part 27Q	100M	QPSK	1	1	DFT-SCS-30KHz	Back	5mm	Ant 0	656000	3840	1	15.91	17.00	1.285	-	-	0.01	0.289	0.371	
2nd	FR1 n77 Part 27Q	100M	QPSK	135	69	DFT-SCS-30KHz	Back	5mm	Ant 0	656000	3840	1	15.82	17.00	1.312	-	-	0.18	0.276	0.362	
2nd	FR1 n77 Part 27Q	100M	QPSK	1	1	DFT-SCS-30KHz	Left Side	5mm	Ant 0	656000	3840	1	15.91	17.00	1.285	-	-	0	0.000	0.000	
2nd	FR1 n77 Part 27Q	100M	QPSK	135	69	DFT-SCS-30KHz	Left Side	5mm	Ant 0	656000	3840	1	15.82	17.00	1.312	-	-	0.01	0.000	0.000	
2nd	FR1 n77 Part 27Q	100M	QPSK	1	1	DFT-SCS-30KHz	Right Side	5mm	Ant 0	656000	3840	1	15.91	17.00	1.285	-	-	-0.01	0.000	0.000	
2nd	FR1 n77 Part 27Q	100M	QPSK	135	69	DFT-SCS-30KHz	Right Side	5mm	Ant 0	656000	3840	1	15.82	17.00	1.312	-	-	-0.06	0.000	0.000	
2nd	FR1 n77 Part 27Q	100M	QPSK	1	1	DFT-SCS-30KHz	Bottom Side	5mm	Ant 0	656000	3840	1	15.91	17.00	1.285	-	-	-0.04	0.187	0.240	
2nd	FR1 n77 Part 27Q	100M	QPSK	135	69	DFT-SCS-30KHz	Bottom Side	5mm	Ant 0	656000	3840	1	15.82	17.00	1.312	-	-	-0.09	0.175	0.230	
2nd	FR1 n77 Part 27Q	100M	QPSK	1	1	DFT-SCS-30KHz	Front	5mm	Ant 0	633332	3500	1	15.85	17.00	1.303	-	-	-0.1	0.222	0.289	
2nd	FR1 n77 Part 27Q	100M	QPSK	135	69	DFT-SCS-30KHz	Front	5mm	Ant 0	633332	3500	1	15.77	17.00	1.327	-	-	0.07	0.187	0.248	
31 2nd	FR1 n77 Part 27Q	100M	QPSK	1	1	DFT-SCS-30KHz	Back	5mm	Ant 0	633332	3500	1	15.85	17.00	1.303	-	-	0.01	0.425	0.554	
2nd	FR1 n77 Part 27Q	100M	QPSK	135	69	DFT-SCS-30KHz	Back	5mm	Ant 0	633332	3500	1	15.77	17.00	1.327	-	-	-0.1	0.408	0.542	
2nd	FR1 n77 Part 27Q	100M	QPSK	1	1	DFT-SCS-30KHz	Left Side	5mm	Ant 0	633332	3500	1	15.85	17.00	1.303	-	-	-0.17	0.000	0.000	
2nd	FR1 n77 Part 27Q	100M	QPSK	135	69	DFT-SCS-30KHz	Left Side	5mm	Ant 0	633332	3500	1	15.77	17.00	1.327	-	-	-0.04	0.028	0.037	
2nd	FR1 n77 Part 27Q	100M	QPSK	1	1	DFT-SCS-30KHz	Right Side	5mm	Ant 0	633332	3500	1	15.85	17.00	1.303	-	-	-0.05	0.053	0.069	
2nd	FR1 n77 Part 27Q	100M	QPSK	135	69	DFT-SCS-30KHz	Right Side	5mm	Ant 0	633332	3500	1	15.77	17.00	1.327	-	-	0	0.058	0.077	
2nd	FR1 n77 Part 27Q	100M	QPSK	1	1	DFT-SCS-30KHz	Bottom Side	5mm	Ant 0	633332	3500	1	15.85	17.00	1.303	-	-	-0.13	0.401	0.523	
2nd	FR1 n77 Part 27Q	100M	QPSK	135	69	DFT-SCS-30KHz	Bottom Side	5mm	Ant 0	633332	3500	1	15.77	17.00	1.327	-	-	-0.01	0.407	0.540	



Plot No.	No.	Band	Mode	Test Position	Gap (mm)	Antenna	Ch.	Freq. (MHz)	Sample	Average Power (dBm)	Tune-Up Limit (dBm)	Tune-up Scaling Factor	Duty Cycle %	Duty Cycle Scaling Factor	Power Drift (dB)	Measured 1g SAR (W/kg)	Reported 1g SAR (W/kg)	Deviation d _{dB} (dB)
2450MHz																		
	1st	WLAN2.4GHz	802.11b 1Mbps	Top Side	5mm	Ant 6	1	2412	1	11.49	13.00	1.416	100	1.000	0.02	0.258	0.365	0.74
32	2nd	WLAN2.4GHz	802.11b 1Mbps	Top Side	5mm	Ant 6	1	2412	1	11.42	13.00	1.439	100	1.000	0.05	0.214	0.308	
	1st	Bluetooth	1Mbps	Top Side	5mm	Ant 6	78	2480	1	12.90	14.00	1.287	77.04	1.081	0.02	0.367	0.511	1.58
33	2nd	Bluetooth	1Mbps	Top Side	5mm	Ant 6	78	2480	1	12.83	14.00	1.309	77.04	1.081	0.02	0.251	0.355	
5000MHz																		
	1st	WLAN5.2GHz	802.11n-HT40 MCS0	Back	5mm	Ant 8	46	5230	1	10.71	12.50	1.511	95.13	1.051	-0.05	0.489	0.777	2.63
34	2nd	WLAN5.2GHz	802.11n-HT40 MCS0	Back	5mm	Ant 8	46	5230	1	10.61	12.50	1.545	95.13	1.051	0.01	0.261	0.424	
	1st	WLAN5.8GHz	802.11n-HT40 MCS0	Back	5mm	Ant 8	151	5755	1	10.74	12.50	1.501	95.13	1.051	0.01	0.596	0.940	0.04
35	2nd	WLAN5.8GHz	802.11n-HT40 MCS0	Back	5mm	Ant 8	151	5755	1	10.64	12.50	1.535	95.13	1.051	0.01	0.578	0.932	



15.3 Body Worn Accessory SAR

Plot No.	No.	Band	BW (MHz)	Modulation	RB Size	RB offset	Mode	Test Position	Gap (mm)	Antenna	Ch.	Freq. (MHz)	Sample	Average Power (dBm)	Tune-Up Limit (dBm)	Tune-up Scaling Factor	Duty Cycle %	Duty Cycle Scaling Factor	Power Drift (dB)	Measured 1g SAR (W/kg)	Reported 1g SAR (W/kg)	Deviation d_{dB} (dB)
750MHz																						
	1st	LTE Band 12	10M	QPSK	1	0	-	Back	5mm	Ant 0	23095	707.5	1	23.17	24.00	1.211	-	-	-0.02	0.442	0.535	0.04
36	2nd	LTE Band 12	10M	QPSK	1	0	-	Back	5mm	Ant 0	23095	707.5	1	23.02	24.00	1.253	-	-	0.17	0.423	0.530	
835MHz																						
	1st	GSM850	-	-	-	-	GPRS (3 Tx slots)	Back	5mm	Ant 0	189	836.4	1	26.89	28.00	1.291	-	-	0.05	0.465	0.600	0.06
37	2nd	GSM850	-	-	-	-	GPRS (3 Tx slots)	Back	5mm	Ant 0	189	836.4	1	26.79	28.00	1.321	-	-	0.04	0.448	0.592	
	1st	WCDMA V	-	-	-	-	RMC 12.2Kbps	Back	5mm	Ant 0	4233	846.6	1	23.28	24.50	1.324	-	-	-0.01	0.667	0.883	0.01
38	2nd	WCDMA V	-	-	-	-	RMC 12.2Kbps	Back	5mm	Ant 0	4233	846.6	1	23.11	24.50	1.377	-	-	0.05	0.639	0.880	
	1st	LTE Band 5	10M	QPSK	1	0	-	Back	5mm	Ant 0	20525	836.5	1	23.26	24.50	1.330	-	-	0.09	0.707	0.941	0.04
39	2nd	LTE Band 5	10M	QPSK	1	0	-	Back	5mm	Ant 0	20525	836.5	1	23.12	24.50	1.374	-	-	0.03	0.679	0.933	
1750MHz																						
	2nd	LTE Band 4	20M	QPSK	1	0	RMC 12.2Kbps	Front	5mm	Ant 1	20175	1732.5	1	18.54	20.00	1.400	-	-	0.08	0.350	0.490	
	2nd	LTE Band 4	20M	QPSK	50	0	RMC 12.2Kbps	Front	5mm	Ant 1	20175	1732.5	1	18.43	20.00	1.435	-	-	0.01	0.334	0.479	
	2nd	LTE Band 4	20M	QPSK	1	0	RMC 12.2Kbps	Back	5mm	Ant 1	20175	1732.5	1	18.54	20.00	1.400	-	-	0.03	0.401	0.561	
40	2nd	LTE Band 4	20M	QPSK	50	0	RMC 12.2Kbps	Back	5mm	Ant 1	20175	1732.5	1	18.43	20.00	1.435	-	-	-0.08	0.425	0.610	
	2nd	LTE Band 4	20M	QPSK	50	0	RMC 12.2Kbps	Back	5mm	Ant 1	20175	1732.5	2	18.43	20.00	1.435	-	-	-0.08	0.405	0.581	
	2nd	WCDMA IV	-	-	-	-	RMC 12.2Kbps	Front	5mm	Ant 1	1413	1732.6		20.22	21.00	1.197	-	-	-0.08	0.523	0.626	
	2nd	WCDMA IV	-	-	-	-	RMC 12.2Kbps	Back	5mm	Ant 1	1413	1732.6		20.22	21.00	1.197	-	-	-0.08	0.670	0.802	
	2nd	WCDMA IV	-	-	-	-	RMC 12.2Kbps	Back	5mm	Ant 1	1312	1712.4		20.12	21.00	1.225	-	-	0.1	0.643	0.787	
58	2nd	WCDMA IV	-	-	-	-	RMC 12.2Kbps	Back	5mm	Ant 1	1513	1752.6		20.15	21.00	1.216	-	-	-0.02	0.704	0.856	
1900MHz																						
	1st	GSM1900	-	-	-	-	GPRS (4 Tx slots)	Back	5mm	Ant 1	661	1880	1	22.28	23.50	1.324	-	-	-0.06	0.594	0.787	0.93
41	2nd	GSM1900	-	-	-	-	GPRS (4 Tx slots)	Back	5mm	Ant 1	661	1880	1	22.13	23.50	1.371	-	-	-0.17	0.463	0.635	
	2nd	WCDMA II	-	-	-	-	RMC 12.2Kbps	Front	5mm	Ant 1	9400	1880	1	19.45	21.00	1.429	-	-	-0.08	0.477	0.682	
	2nd	WCDMA II	-	-	-	-	RMC 12.2Kbps	Back	5mm	Ant 1	9400	1880	1	19.45	21.00	1.429	-	-	0.1	0.573	0.819	
42	2nd	WCDMA II	-	-	-	-	RMC 12.2Kbps	Back	5mm	Ant 1	9262	1852.4	1	19.40	21.00	1.445	-	-	-0.18	0.606	0.876	
	2nd	WCDMA II	-	-	-	-	RMC 12.2Kbps	Back	5mm	Ant 1	9262	1852.4	2	19.40	21.00	1.445	-	-	-0.18	0.542	0.783	
	2nd	WCDMA II	-	-	-	-	RMC 12.2Kbps	Back	5mm	Ant 1	9538	1907.6	1	19.43	21.00	1.435	-	-	0.1	0.539	0.774	
	2nd	LTE Band 2	20M	QPSK	1	0	-	Front	5mm	Ant 1	18900	1880	1	18.59	20.00	1.384	-	-	0.12	0.409	0.566	
	2nd	LTE Band 2	20M	QPSK	50	0	-	Front	5mm	Ant 1	18900	1880	1	18.55	20.00	1.396	-	-	0.08	0.409	0.571	
43	2nd	LTE Band 2	20M	QPSK	1	0	-	Back	5mm	Ant 1	18900	1880	1	18.59	20.00	1.384	-	-	-0.07	0.477	0.660	
	2nd	LTE Band 2	20M	QPSK	50	0	-	Back	5mm	Ant 1	18900	1880	1	18.55	20.00	1.396	-	-	-0.17	0.470	0.656	
2600MHz																						
	2nd	LTE Band 38	20M	QPSK	1	0	-	Front	5mm	Ant 0	38000	2595	1	19.15	20.00	1.216	62.9	1.006	-0.03	0.141	0.173	
	2nd	LTE Band 38	20M	QPSK	50	0	-	Front	5mm	Ant 0	38000	2595	1	19.05	20.00	1.245	62.9	1.006	0.14	0.127	0.159	
44	2nd	LTE Band 38	20M	QPSK	1	0	-	Back	5mm	Ant 0	38000	2595	1	19.15	20.00	1.216	62.9	1.006	0.05	0.709	0.867	
	2nd	LTE Band 38	20M	QPSK	1	0	-	Back	5mm	Ant 0	38000	2595	2	19.15	20.00	1.216	62.9	1.006	0.11	0.659	0.806	
	2nd	LTE Band 38	20M	QPSK	1	0	-	Back	5mm	Ant 0	37850	2580	1	19.02	20.00	1.253	62.9	1.006	-0.05	0.643	0.811	
	2nd	LTE Band 38	20M	QPSK	1	0	-	Back	5mm	Ant 0	38150	2610	1	19.01	20.00	1.256	62.9	1.006	0.18	0.648	0.819	
	2nd	LTE Band 38	20M	QPSK	50	0	-	Back	5mm	Ant 0	38000	2595	1	19.05	20.00	1.245	62.9	1.006	0.14	0.603	0.755	
	2nd	LTE Band 38	20M	QPSK	50	0	-	Back	5mm	Ant 0	38000	2595	1	18.98	20.00	1.265	62.9	1.006	-0.17	0.614	0.781	
	2nd	LTE Band 38	20M	QPSK	50	0	-	Back	5mm	Ant 0	38000	2595	1	19.06	20.00	1.242	62.9	1.006	0.17	0.617	0.771	
	2nd	LTE Band 38	20M	QPSK	100	0	-	Back	5mm	Ant 0	38000	2595	1	18.99	20.00	1.262	62.9	1.006	-0.05	0.595	0.755	
	1st	LTE Band 41	20M	QPSK	1	0	-	Back	5mm	Ant 0	40620	2593	1	18.30	19.00	1.175	62.9	1.006	0.03	0.686	0.811	0.70
45	2nd	LTE Band 41	20M	QPSK	1	0	-	Back	5mm	Ant 0	40620	2593	1	18.05	19.00	1.245	62.9	1.006	0.01	0.551	0.690	
	2nd	FR1 n41	30M	QPSK	1	1	DFT-SCS-30KHz	Front	5mm	Ant 0	518598	2592.99	1	17.29	18.50	1.321	-	-	0.01	0.178	0.235	
	2nd	FR1 n41	30M	QPSK	36	18	DFT-SCS-30KHz	Front	5mm	Ant 0	518598	2592.99	1	17.19	18.50	1.352	-	-	0.1	0.160	0.216	
46	2nd	FR1 n41	30M	QPSK	1	1	DFT-SCS-30KHz	Back	5mm	Ant 0	518598	2592.99	1	17.29	18.50	1.321	-	-	-0.03	0.892	1.179	
	2nd	FR1 n41	30M	QPSK	1	1	DFT-SCS-30KHz	Back	5mm	Ant 0	518598	2592.99	2	17.29	18.50	1.321	-	-	-0.17	0.858	1.134	
	2nd	FR1 n41	30M	QPSK	1	1	DFT-SCS-30KHz	Back	5mm	Ant 0	502200	2511	1	17.06	18.50	1.393	-	-	-0.01	0.810	1.128	
	2nd	FR1 n41	30M	QPSK	1	1	DFT-SCS-30KHz	Back	5mm	Ant 0	534996	2674.98	1	16.87	18.50	1.455	-	-	-0.08	0.805	1.172	



FCC SAR Test Report

Report No. : FA3D0613-06

2nd	FR1 n41	30M	QPSK	36	18	DFT-SCS-30KHz	Back	5mm	Ant 0	518598	2592.99	1	17.19	18.50	1.352	-	-	0.05	0.759	1.026	
2nd	FR1 n41	30M	QPSK	36	18	DFT-SCS-30KHz	Back	5mm	Ant 0	502200	2511	1	17.03	18.50	1.403	-	-	0.06	0.772	1.083	
2nd	FR1 n41	30M	QPSK	36	18	DFT-SCS-30KHz	Back	5mm	Ant 0	534996	2674.98	1	17.00	18.50	1.413	-	-	-0.09	0.776	1.096	
2nd	FR1 n41	30M	QPSK	75	0	DFT-SCS-30KHz	Back	5mm	Ant 0	518598	2592.99	1	17.12	18.50	1.374	-	-	-0.08	0.749	1.029	
3500MHz																					
1st	LTE Band 42	20M	QPSK	1	0		Back	5mm	Ant 0	42590	3500	1	14.92	16.00	1.282	62.9	1.006	0.01	0.332	0.428	0.08
47 2nd	LTE Band 42	20M	QPSK	1	0		Back	5mm	Ant 0	42590	3500	1	15.45	16.00	1.135	62.9	1.006	0	0.368	0.420	
2nd	FR1 n77 Part 27Q	100M	QPSK	1	1	DFT-SCS-30KHz	Front	5mm	Ant 0	656000	3840	1	15.91	17.00	1.285	-	-	0.13	0.100	0.129	
2nd	FR1 n77 Part 27Q	100M	QPSK	135	69	DFT-SCS-30KHz	Front	5mm	Ant 0	656000	3840	1	15.82	17.00	1.312	-	-	0.12	0.100	0.131	
2nd	FR1 n77 Part 27Q	100M	QPSK	1	1	DFT-SCS-30KHz	Back	5mm	Ant 0	656000	3840	1	15.91	17.00	1.285	-	-	0.01	0.289	0.371	
2nd	FR1 n77 Part 27Q	100M	QPSK	1	1	DFT-SCS-30KHz	Back	5mm	Ant 0	656000	3840	2	15.91	17.00	1.285	-	-	0.03	0.270	0.347	
2nd	FR1 n77 Part 27Q	100M	QPSK	135	69	DFT-SCS-30KHz	Back	5mm	Ant 0	656000	3840	1	15.82	17.00	1.312	-	-	0.18	0.276	0.362	
2nd	FR1 n77 Part 27Q	100M	QPSK	1	1	DFT-SCS-30KHz	Front	5mm	Ant 0	633332	3499.98	1	15.85	17.00	1.303	-	-	-0.1	0.222	0.289	
2nd	FR1 n77 Part 27Q	100M	QPSK	135	69	DFT-SCS-30KHz	Front	5mm	Ant 0	633332	3499.98	1	15.77	17.00	1.327	-	-	0.07	0.187	0.248	
48 2nd	FR1 n77 Part 27Q	100M	QPSK	1	1	DFT-SCS-30KHz	Back	5mm	Ant 0	633332	3499.98	1	15.85	17.00	1.303	-	-	0.01	0.425	0.554	
2nd	FR1 n77 Part 27Q	100M	QPSK	1	1	DFT-SCS-30KHz	Back	5mm	Ant 0	633332	3499.98	2	15.85	17.00	1.303	-	-	0.18	0.390	0.508	
2nd	FR1 n77 Part 27Q	100M	QPSK	135	69	DFT-SCS-30KHz	Back	5mm	Ant 0	633332	3499.98	1	15.77	17.00	1.327	-	-	-0.1	0.408	0.542	

Plot No.	No.	Band	Mode	Test Position	Gap (mm)	Antenna	Ch.	Freq. (MHz)	Sample	Average Power (dBm)	Tune-Up Limit (dBm)	Tune-up Scaling Factor	Duty Cycle %	Duty Cycle Scaling Factor	Power Drift (dB)	Measured 1g SAR (W/kg)	Reported 1g SAR (W/kg)	Deviation dB (dB)	
2450MHz																			
	1st	WLAN2.4GHz	802.11b 1Mbps	Back	5mm	Ant 6	1	2412	1	11.49	13.00	1.416	100	1.000	0.02	0.165	0.234	1.57	
49	2nd	WLAN2.4GHz	802.11b 1Mbps	Back	5mm	Ant 6	1	2412	1	11.42	13.00	1.439	100	1.000	0.02	0.113	0.163		
	1st	Bluetooth	1Mbps	Back	5mm	Ant 6	78	2480	1	12.90	14.00	1.287	77.04	1.081	0.07	0.209	0.291	0.14	
50	2nd	Bluetooth	1Mbps	Back	5mm	Ant 6	78	2480	1	12.83	14.00	1.309	77.04	1.081	0.01	0.199	0.282		
5000MHz																			
	1st	WLAN5.3GHz	802.11n-HT40 MCS0	Back	5mm	Ant 8	54	5270	1	10.73	12.50	1.504	95.13	1.051	0.03	0.368	0.582	2.52	
51	2nd	WLAN5.3GHz	802.11n-HT40 MCS0	Back	5mm	Ant 8	54	5270	1	10.61	12.50	1.545	95.13	1.051	0.01	0.201	0.326		
	1st	WLAN5.5GHz	802.11n-HT40 MCS0	Back	5mm	Ant 8	134	5670	1	10.84	12.50	1.467	95.13	1.051	-0.04	0.371	0.572	0.09	
52	2nd	WLAN5.5GHz	802.11n-HT40 MCS0	Back	5mm	Ant 8	134	5670	1	10.70	12.50	1.514	95.13	1.051	0.01	0.352	0.560		
	1st	WLAN5.8GHz	802.11n-HT40 MCS0	Back	5mm	Ant 8	151	5755	1	10.74	12.50	1.501	95.13	1.051	0.01	0.596	0.940	0.04	
53	2nd	WLAN5.8GHz	802.11n-HT40 MCS0	Back	5mm	Ant 8	151	5755	1	10.64	12.50	1.535	95.13	1.051	0.01	0.578	0.932		



15.4 Product Specific SAR

Plot No.	No.	Band	Mode	Test Position	Gap (mm)	Antenna	Ch.	Freq. (MHz)	Sample	Average Power (dBm)	Tune-Up Limit (dBm)	Tune-up Scaling Factor	Duty Cycle %	Duty Cycle Scaling Factor	Power Drift (dB)	Measured 10g SAR (W/kg)	Reported 10g SAR (W/kg)	Deviation dB
5000MHz																		
	1st	WLAN5.3GHz	802.11n-HT40 MCS0	Back	0mm	Ant 8	54	5270	1	10.73	12.50	1.504	95.13	1.051	0.01	0.280	0.443	1.90
54	2nd	WLAN5.3GHz	802.11n-HT40 MCS0	Back	0mm	Ant 8	54	5270	1	10.61	12.50	1.545	95.13	1.051	0.01	0.176	0.286	
	1st	WLAN5.5GHz	802.11n-HT40 MCS0	Back	0mm	Ant 8	134	5670	1	10.84	12.50	1.467	95.13	1.051	0.02	0.430	0.663	0.01
55	2nd	WLAN5.5GHz	802.11n-HT40 MCS0	Back	0mm	Ant 8	134	5670	1	10.70	12.50	1.514	95.13	1.051	0.01	0.416	0.662	

15.5 Repeated SAR Measurement

<1g>

Plot No.	Band	BW (MHz)	Modulation	RB Size	RB offset	Mode	Test Position	Gap (mm)	Antenna	Ch.	Freq. (MHz)	Sample	Average Power (dBm)	Tune-Up Limit (dBm)	Tune-up Scaling Factor	Duty Cycle %	Duty Cycle Scaling Factor	Power Drift (dB)	Measured 1g SAR (W/kg)	Ratio	Reported 1g SAR (W/kg)
1st	FR1 n41	30M	QPSK	1	1	DFT-SCS-30KHz	Back	5mm	Ant 0	518598	2592.99	1	17.29	18.50	1.321	-	-	-0.03	0.892	1	1.179
2nd	FR1 n41	30M	QPSK	1	1	DFT-SCS-30KHz	Back	5mm	Ant 0	518598	2592.99	1	17.29	18.50	1.321	-	-	0.01	0.822	1.085	1.086

General Note:

- Per KDB 865664 D01v01r04, for each frequency band, repeated SAR measurement is required only when the measured SAR is $\geq 0.8W/kg$.
- Per KDB 865664 D01v01r04, if the ratio among the repeated measurement is ≤ 1.2 and the measured SAR $< 1.45W/kg$, only one repeated measurement is required.
- The ratio is the difference in percentage between original and repeated *measured SAR*.
- All measurement SAR result is scaled-up to account for tune-up tolerance and is compliant.

16. Simultaneous Transmission Analysis

No.	Simultaneous Transmission Configurations	Portable Handset			
		Head	Body-worn	Hotspot	Product specific 10g SAR
1.	WWAN + WLAN2.4GHz	Yes	Yes	Yes	Yes
2.	WWAN + WLAN5GHz	Yes	Yes	Yes	Yes
3.	WWAN + Bluetooth	Yes	Yes	Yes	Yes
4.	WWAN + WLAN5GHz + Bluetooth	Yes	Yes	Yes	Yes
5.	WWAN + WLAN2.4GHz + NFC				Yes
6.	WWAN + WLAN5GHz + NFC				Yes
7.	WWAN + Bluetooth + NFC				Yes
8.	WWAN + WLAN5GHz + Bluetooth + NFC				Yes

General Note:

- This device supports VoIP in GPRS, WCDMA, LTE and 5GNR (e.g. for 3rd-party VoIP), LTE supports VoLTE operation.
- WWAN above includes 5G NR bands and EN-DC combination.
- EUT will choose each GSM, WCDMA, LTE and 5GNR according to the network signal condition; therefore, they will not operate simultaneously at any moment.
- This device 2.4GHz WLAN support hotspot operation and Bluetooth support tethering applications.
- This device 5.2GHz WLAN/5.8GHz WLAN support hotspot operation, and 5.2GHz WLAN/5.8GHz WLAN supports WLAN Direct (GC/GO), and 5.3GHz / 5.5GHz supports WLAN Direct (GC only).
- The worst case 5 GHz WLAN SAR for each configuration was used for SAR summation.
- WLAN 2.4GHz and Bluetooth share the same antenna so can't transmit simultaneously.
- According to the EUT characteristic, WLAN 5GHz and Bluetooth can transmit simultaneously.
- According to the EUT characteristic, WLAN 5GHz and WLAN 2.4GHz can't transmit simultaneously.
- NFC can transmit simultaneously with other Radios in extremity exposure condition.
- The maximum SAR summation is calculated based on the same configuration and test position.
- For standalone WWAN, always choose the highest SAR among all WWAN bands within the selected antenna for Head exposure condition each exposure position to perform simultaneous transmission analysis with WLAN/BT. This is the worst co-located analysis and can represent each band.
- For standalone WWAN, always choose the highest SAR among selected WWAN bands within the selected antenna for Hotspot/body-worn exposure condition each exposure position to perform simultaneous transmission analysis with WLAN/BT. This is the worst co-located analysis and can represent each band.
- For EN-DC SAR co-located with WLAN/Bluetooth, chose the worst SAR among the selected LTE bands within the selected antenna per each test position and also the worst SAR of the selected 5GNR Band within the selected antenna to do co-located with WLAN/Bluetooth. This is the worst co-located analysis and can represent each LTE bands and each 5GNR bands.
- Per KDB 447498 D01v06, simultaneous transmission SAR is compliant if,
 - 1g Scalar SAR summation < 1.6W/kg and 10g Scalar SAR summation < 4.0W/kg.
 - $SPLSR = (SAR1 + SAR2)^{1.5} / (\text{min. separation distance, mm})$, and the peak separation distance is determined from the square root of $[(x1-x2)^2 + (y1-y2)^2 + (z1-z2)^2]$, where (x1, y1, z1) and (x2, y2, z2) are the coordinates of the extrapolated peak SAR locations in the zoom scan.
 - If $SPLSR \leq 0.04$ for 1g SAR and $SPLSR \leq 0.10$ for 10g SAR, simultaneously transmission SAR measurement is not necessary.
 - Simultaneously transmission SAR measurement, and the reported multi-band 1g SAR < 1.6W/kg and 10g SAR < 4.0W/kg.
 - The SPLSR calculated results please refer to section 16.5.

Conclusion:

1. The Spot check results from chapter 15.1 to 15.4, showed that Deviation of the SAR results did not exceed 3dB, SAR data reuse is justified.
2. For the verified maximum SAR from chapter 15.1 to 15.4, when the SAR test results were less than reference model SAR results (Sporton SAR report no.: FA3D0613-04), there is no need to consider co-located SAR for reference model report had been performed conservatively. For the SAR results were higher than reference model SAR results and full tested bands, they were evaluated to do simultaneous transmission analysis with WLAN/BT. WLAN/BT SAR Chose higher SAR between reference model SAR results and variant model SAR results for each exposure position to perform co-located SAR analysis.

16.1 Head Exposure Conditions

WWAN Band	Exposure Position	1	2	3	4	1+2	1+3+4
		WWAN	WLAN2.4GHz Ant 6	WLAN5GHz Ant 8	Bluetooth Ant 6	Summed	Summed
		1g SAR (W/kg)	1g SAR (W/kg)	1g SAR (W/kg)	1g SAR (W/kg)	1g SAR (W/kg)	1g SAR (W/kg)
All Bands Ant0	Right Cheek	0.363	0.300	0.185	0.283	0.66	0.83
	Right Tilted	0.215	0.351	0.164	0.284	0.57	0.66
	Left Cheek	0.278	0.218	0.093	0.206	0.50	0.58
	Left Tilted	0.156	0.225	0.128	0.239	0.38	0.52
All Bands Ant1	Right Cheek	0.179	0.300	0.185	0.283	0.48	0.65
	Right Tilted	0.156	0.351	0.164	0.284	0.51	0.60
	Left Cheek	0.270	0.218	0.093	0.206	0.49	0.57
	Left Tilted	0.204	0.225	0.128	0.239	0.43	0.57

<ENDC>

WWAN Band	FR1 Band	Exposure Position	1	2	3	4	5	1+2+3	1+2+4+5
			WWAN	FR1	WLAN2.4GHz Ant 6	WLAN5GHz Ant 8	Bluetooth Ant 6	Summed	Summed
			1g SAR (W/kg)	1g SAR (W/kg)	1g SAR (W/kg)	1g SAR (W/kg)	1g SAR (W/kg)	1g SAR (W/kg)	1g SAR (W/kg)
LTE B41 Ant0	FR1 n77(78) Ant0	Right Cheek		0.026	0.300	0.185	0.283	0.33	0.49
		Right Tilted			0.351	0.164	0.284	0.35	0.45
		Left Cheek	0.007		0.218	0.093	0.206	0.23	0.31
		Left Tilted		0.018	0.225	0.128	0.239	0.24	0.39



16.2 Hotspot Exposure Conditions

WWAN Band	Exposure Position	1	2	3	4	1+2	1+3+4	Case No
		WWAN	WLAN2.4GHz Ant 6	WLAN5GHz Ant 8	Bluetooth Ant 6	Summed	Summed	
		1g SAR (W/kg)	1g SAR (W/kg)	1g SAR (W/kg)	1g SAR (W/kg)	1g SAR (W/kg)	1g SAR (W/kg)	
GSM850 Ant 0	Front	0.577	0.210	0.411	0.274	0.79	1.26	
	Back	0.600	0.234	0.940	0.291	0.83	1.83	1
	Left side	0.163	0.028	0.044	0.038	0.19	0.25	
	Right side	0.285	0.038	0.009	0.032	0.32	0.33	
	Top side		0.365	0.068	0.511	0.37	0.58	
	Bottom side	0.532				0.53	0.53	
GSM1900 Ant 1	Front	0.567	0.210	0.411	0.274	0.78	1.25	
	Back	0.787	0.234	0.940	0.291	1.02	2.02	2
	Left side	0.509	0.028	0.044	0.038	0.54	0.59	
	Right side	0.090	0.038	0.009	0.032	0.13	0.13	
	Top side		0.365	0.068	0.511	0.37	0.58	
	Bottom side	0.732				0.73	0.73	
WCDMA V Ant 0	Front	0.769	0.210	0.411	0.274	0.98	1.45	
	Back	0.883	0.234	0.940	0.291	1.12	2.11	3
	Left side	0.259	0.028	0.044	0.038	0.29	0.34	
	Right side	0.487	0.038	0.009	0.032	0.53	0.53	
	Top side		0.365	0.068	0.511	0.37	0.58	
	Bottom side	0.712				0.71	0.71	
LTE Band 5 Ant 0	Front	0.938	0.210	0.411	0.274	1.15	1.62	12
	Back	0.941	0.234	0.940	0.291	1.18	2.17	4
	Left side	0.291	0.028	0.044	0.038	0.32	0.37	
	Right side	0.543	0.038	0.009	0.032	0.58	0.58	
	Top side		0.365	0.068	0.511	0.37	0.58	
	Bottom side	0.834				0.83	0.83	
LTE Band 12 Ant 0	Front	0.488	0.210	0.411	0.274	0.70	1.17	
	Back	0.535	0.234	0.940	0.291	0.77	1.77	5
	Left side	0.285	0.028	0.044	0.038	0.31	0.37	
	Right side	0.495	0.038	0.009	0.032	0.53	0.54	
	Top side		0.365	0.068	0.511	0.37	0.58	
	Bottom side	0.450				0.45	0.45	
LTE Band 41 Ant 0	Front	0.162	0.210	0.411	0.274	0.37	0.85	
	Back	0.811	0.234	0.940	0.291	1.05	2.04	6
	Left side		0.028	0.044	0.038	0.03	0.08	
	Right side		0.038	0.009	0.032	0.04	0.04	
	Top side		0.365	0.068	0.511	0.37	0.58	
	Bottom side	0.443				0.44	0.44	
LTE Band 42 Ant 0	Front	0.130	0.210	0.411	0.274	0.34	0.82	
	Back	0.428	0.234	0.940	0.291	0.66	1.66	7
	Left side	0.018	0.028	0.044	0.038	0.05	0.10	
	Right side	0.031	0.038	0.009	0.032	0.07	0.07	
	Top side		0.365	0.068	0.511	0.37	0.58	
	Bottom side	0.372				0.37	0.37	



WWAN Band	Exposure Position	1	2	3	4	1+2	1+3+4	SPLSR
		WWAN	WLAN2.4GHz Ant 6	WLAN5GHz Ant 8	Bluetooth Ant 6	Summed	Summed	
		1g SAR (W/kg)	1g SAR (W/kg)	1g SAR (W/kg)	1g SAR (W/kg)	1g SAR (W/kg)	1g SAR (W/kg)	
WCDMA II Ant1	Front	0.682	0.210	0.411	0.274	0.89	1.37	
	Back	0.876	0.234	0.940	0.291	1.11	2.11	13
	Left side	0.563	0.028	0.044	0.038	0.59	0.65	
	Right side	0.076	0.038	0.009	0.032	0.11	0.12	
	Top side		0.365	0.068	0.511	0.37	0.58	
	Bottom side	0.666				0.67	0.67	
LTE Band 2 Ant1	Front	0.571	0.210	0.411	0.274	0.78	1.26	
	Back	0.660	0.234	0.940	0.291	0.89	1.89	14
	Left side	0.464	0.028	0.044	0.038	0.49	0.55	
	Right side	0.072	0.038	0.009	0.032	0.11	0.11	
	Top side		0.365	0.068	0.511	0.37	0.58	
	Bottom side	0.570				0.57	0.57	
LTE Band 4 Ant1	Front	0.490	0.210	0.411	0.274	0.70	1.18	
	Back	0.610	0.234	0.940	0.291	0.84	1.84	15
	Left side	0.337	0.028	0.044	0.038	0.37	0.42	
	Right side	0.057	0.038	0.009	0.032	0.10	0.10	
	Top side		0.365	0.068	0.511	0.37	0.58	
	Bottom side	0.541				0.54	0.54	
LTE Band 38 Ant0	Front	0.173	0.210	0.411	0.274	0.38	0.86	
	Back	0.867	0.234	0.940	0.291	1.10	2.10	16
	Left side		0.028	0.044	0.038	0.03	0.08	
	Right side		0.038	0.009	0.032	0.04	0.04	
	Top side		0.365	0.068	0.511	0.37	0.58	
	Bottom side	0.482				0.48	0.48	
FR1 n41 Ant0	Front	0.235	0.210	0.411	0.274	0.45	0.92	
	Back	1.179	0.234	0.940	0.291	1.41	2.41	17
	Left side		0.028	0.044	0.038	0.03	0.08	
	Right side		0.038	0.009	0.032	0.04	0.04	
	Top side		0.365	0.068	0.511	0.37	0.58	
	Bottom side	0.652				0.65	0.65	
FR1 n77 Part 27O Ant0	Front	0.131	0.210	0.411	0.274	0.34	0.82	
	Back	0.371	0.234	0.940	0.291	0.61	1.60	18
	Left side		0.028	0.044	0.038	0.03	0.08	
	Right side		0.038	0.009	0.032	0.04	0.04	
	Top side		0.365	0.068	0.511	0.37	0.58	
	Bottom side	0.240				0.24	0.24	
FR1 n77 Part 27Q Ant0	Front	0.289	0.210	0.411	0.274	0.50	0.97	
	Back	0.554	0.234	0.940	0.291	0.79	1.79	19
	Left side	0.037	0.028	0.044	0.038	0.07	0.12	
	Right side	0.077	0.038	0.009	0.032	0.12	0.12	
	Top side		0.365	0.068	0.511	0.37	0.58	
	Bottom side	0.540				0.54	0.54	
WCDMA IV Ant1	Front	0.626	0.210	0.411	0.274	0.84	1.31	
	Back	0.856	0.234	0.940	0.291	1.09	2.09	20
	Left side	0.442	0.028	0.044	0.038	0.47	0.52	
	Right side	0.072	0.038	0.009	0.032	0.11	0.11	
	Top side		0.365	0.068	0.511	0.37	0.58	
	Bottom side	0.712				0.71	0.71	



<ENDC>

WWAN Band	FR1 Band	Exposure Position	1	2	3	4	5	1+2+3	1+2+4+5	Case No
			WWAN	FR1	WLAN2.4GHz Ant 6	WLAN5GHz Ant 8	Bluetooth Ant 6	Summed	Summed	
			1g SAR (W/kg)	1g SAR (W/kg)	1g SAR (W/kg)	1g SAR (W/kg)	1g SAR (W/kg)	1g SAR (W/kg)	1g SAR (W/kg)	
LTE B41 Ant0	FR1 n77(78) Ant0	Front	0.162	0.289	0.210	0.411	0.274	0.66	1.14	
		Back	0.811	0.554	0.234	0.940	0.291	1.60	2.60	10&11
		Left side		0.037	0.028	0.044	0.038	0.07	0.12	
		Right side		0.077	0.038	0.009	0.032	0.12	0.12	
		Top side			0.365	0.068	0.511	0.37	0.58	
		Bottom side	0.443	0.540				0.98	0.98	

16.3 Body-Worn Accessory Exposure Conditions

WWAN Band	Exposure Position	1	2	3	4	1+2	1+3+4	Case No
		WWAN	WLAN2.4GHz Ant 6	WLAN5GHz Ant 8	Bluetooth Ant 6	Summed	Summed	
		1g SAR (W/kg)	1g SAR (W/kg)	1g SAR (W/kg)	1g SAR (W/kg)	1g SAR (W/kg)	1g SAR (W/kg)	
GSM850 Ant 0	Front	0.577	0.210	0.377	0.274	0.79	1.23	
	Back	0.600	0.234	0.940	0.291	0.83	1.83	1
GSM1900 Ant 1	Front	0.567	0.210	0.377	0.274	0.78	1.22	
	Back	0.787	0.234	0.940	0.291	1.02	2.02	2
WCDMA V Ant 0	Front	0.769	0.210	0.377	0.274	0.98	1.42	
	Back	0.883	0.234	0.940	0.291	1.12	2.11	3
LTE Band 5 Ant 0	Front	0.938	0.210	0.377	0.274	1.15	1.59	
	Back	0.941	0.234	0.940	0.291	1.18	2.17	4
LTE Band 12 Ant 0	Front	0.488	0.210	0.377	0.274	0.70	1.14	
	Back	0.535	0.234	0.940	0.291	0.77	1.77	5
LTE Band 41 Ant 0	Front	0.162	0.210	0.377	0.274	0.37	0.81	
	Back	0.811	0.234	0.940	0.291	1.05	2.04	6
LTE Band 42 Ant 0	Front	0.130	0.210	0.377	0.274	0.34	0.78	
	Back	0.428	0.234	0.940	0.291	0.66	1.66	7

WWAN Band	Exposure Position	1	2	3	4	1+2	1+3+4	SPLSR
		WWAN	WLAN2.4GHz Ant 6	WLAN5GHz Ant 8	Bluetooth Ant 6	Summed	Summed	
		1g SAR (W/kg)	1g SAR (W/kg)	1g SAR (W/kg)	1g SAR (W/kg)	1g SAR (W/kg)	1g SAR (W/kg)	
WCDMA II Ant1	Front	0.682	0.210	0.377	0.274	0.89	1.33	
	Back	0.876	0.234	0.940	0.291	1.11	2.11	13
LTE Band 2 Ant1	Front	0.571	0.210	0.377	0.274	0.78	1.22	
	Back	0.660	0.234	0.940	0.291	0.89	1.89	14
LTE Band 4 Ant1	Front	0.490	0.210	0.377	0.274	0.70	1.14	
	Back	0.610	0.234	0.940	0.291	0.84	1.84	15
LTE Band 38 Ant0	Front	0.173	0.210	0.377	0.274	0.38	0.82	
	Back	0.867	0.234	0.940	0.291	1.10	2.10	16
FR1 n41 Ant0	Front	0.235	0.210	0.377	0.274	0.45	0.89	
	Back	1.179	0.234	0.940	0.291	1.41	2.41	17
FR1 n77 Part 27Q Ant0	Front	0.131	0.210	0.377	0.274	0.34	0.78	
	Back	0.371	0.234	0.940	0.291	0.61	1.60	18
FR1 n77 Part 27Q Ant0	Front	0.289	0.210	0.377	0.274	0.50	0.94	
	Back	0.554	0.234	0.940	0.291	0.79	1.79	19
WCDMA IV Ant1	Front	0.626	0.210	0.377	0.274	0.84	1.28	
	Back	0.856	0.234	0.940	0.291	1.09	2.09	20

<ENDC>

WWAN Band	FR1 Band	Exposure Position	1	2	3	4	5	1+2+3	1+2+4+5	Case No
			WWAN	FR1	WLAN2.4GHz Ant 6	WLAN5GHz Ant 8	Bluetooth Ant 6	Summed	Summed	
			1g SAR (W/kg)	1g SAR (W/kg)	1g SAR (W/kg)	1g SAR (W/kg)	1g SAR (W/kg)	1g SAR (W/kg)	1g SAR (W/kg)	
LTE B41 Ant0	FR1 n77(78) Ant0	Front	0.162	0.289	0.210	0.377	0.274	0.66	1.10	
		Back	0.811	0.554	0.234	0.940	0.291	1.60	2.60	10&11

16.4 Product Specific Exposure Conditions

Note: 1. For WLAN2.4GHz/Bluetooth Product specific 10g stand-alone SAR is not required for a transmitter or antenna, due to 1g hotspot SAR is <1.2W/kg.

Exposure Position	1	2	1+2
	WLAN5GHz Ant 8	NFC	Summed
	10g SAR (W/kg)	10g SAR (W/kg)	10g SAR (W/kg)
Front	0.079	0.001	0.08
Back	0.663	0.015	0.68
Left side	0.063	0.001	0.06
Right side		0.001	0.00
Top side	0.150	0.001	0.15
Bottom side		0.001	0.00

16.5 SPLSR Evaluation and Analysis

General Note:

1. When standalone SAR is measured for both antennas in the pair, the peak location separation distance is computed by the square root of $[(x1-x2)^2 + (y1-y2)^2 + (z1-z2)^2]$, where $(x1, y1, z1)$ and $(x2, y2, z2)$ are the coordinates in the area scans or extrapolated peak SAR locations in the zoom scans, as appropriate.
2. $SPLSR = (SAR1 + SAR2)1.5 / (\text{min. separation distance, mm})$. If $SPLSR \leq 0.04$ for 1g SAR, simultaneously transmission SAR measurement is not necessary.
3. Per April 2022 TCB Workshop Notes, BT antenna 6 was summed algebraically with the WIFI Antenna 8 separately for the purposes of hybrid SPLSR combination and they are located at the top of the device.
4. Per April 2022 TCB Workshop, instead of doing a small volume scan over a co-located antenna pair, used summing the SAR values of the co-located pair and using that value in SPLSR calculation. In the calculation used the minimum distance between the spatially separated antenna and the closest antenna of the co-located antenna pair to be conservative.

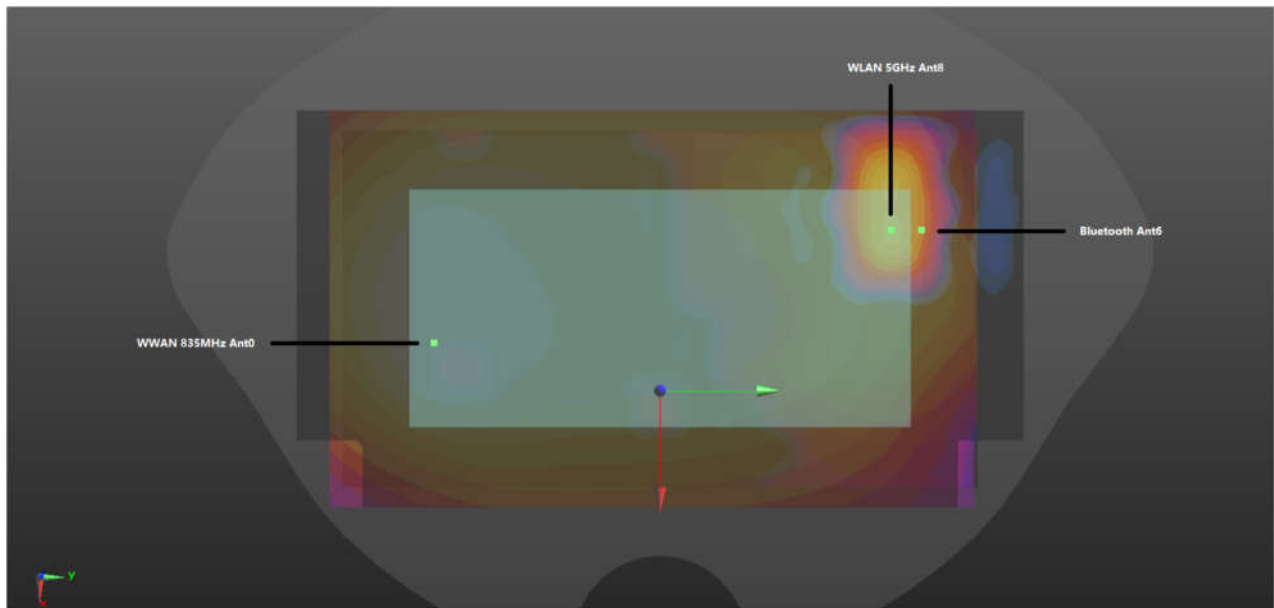

WWAN+WLAN+BT Front 5mm

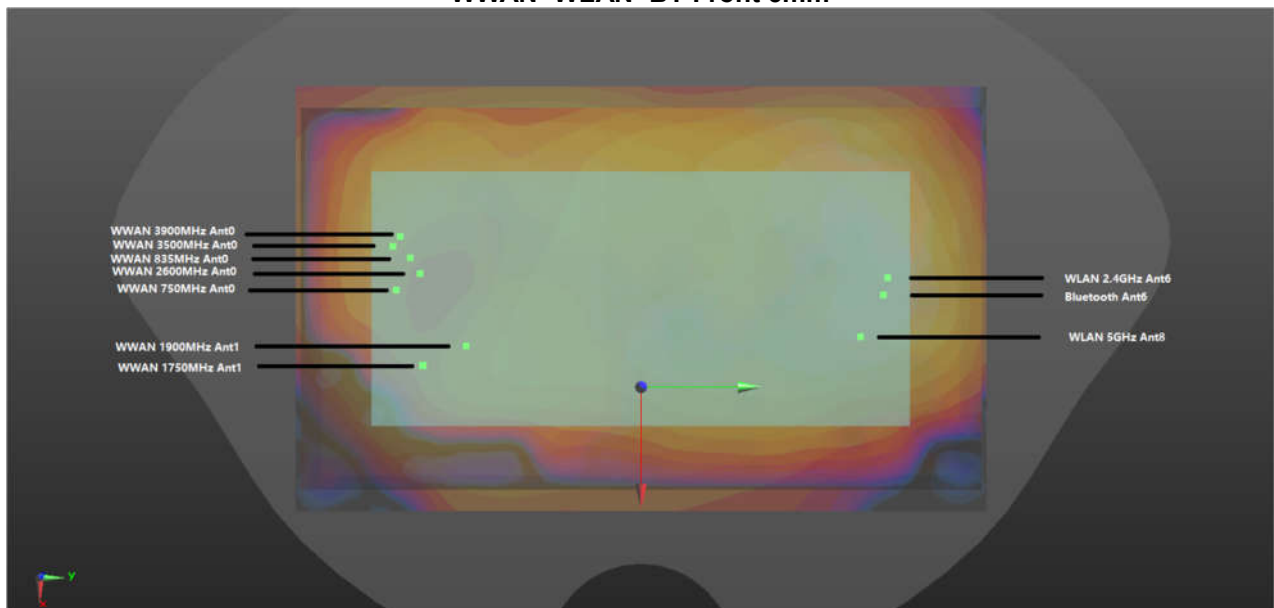

WWAN+WLAN+BT Back 5mm



For Hotspot

Case	Band	Position	SAR (W/kg)	Gap (mm)	SAR peak location (mm)			3D distance (mm)	Summed SAR (W/kg)	SPLSR Results	Simultaneous SAR
					X	Y	Z				
Case 1	GSM850 Ant 0	Back	0.6	5mm	-2.8	-58.3	-10.98	123.3	1.83	0.02	Not required
	WLAN5GHz Ant 8		0.94	5mm	14.2	63.6	-2.83				
	Bluetooth Ant 6		0.291	5mm	-6	79.6	-10.96				
Case 2	GSM1900 Ant 1	Back	0.787	5mm	-16.7	-55.9	-10.83	123.7	2.02	0.02	Not required
	WLAN5GHz Ant 8		0.94	5mm	14.2	63.6	-2.83				
	Bluetooth Ant 6		0.291	5mm	-6	79.6	-10.96				
Case 3	WCDMA V Ant 0	Back	0.883	5mm	-4.6	-61.3	-11	126.6	2.11	0.02	Not required
	WLAN5GHz Ant 8		0.94	5mm	14.2	63.6	-2.83				
	Bluetooth Ant 6		0.291	5mm	-6	79.6	-10.96				
Case 4	LTE Band 5 Ant 0	Back	0.941	5mm	1.8	-63.9	-10.89	128.4	2.17	0.02	Not required
	WLAN5GHz Ant 8		0.94	5mm	14.2	63.6	-2.83				
	Bluetooth Ant 6		0.291	5mm	-6	79.6	-10.96				
Case 5	LTE Band 12 Ant 0	Back	0.535	5mm	3.4	-65.4	-10.89	129.7	1.77	0.02	Not required
	WLAN5GHz Ant 8		0.94	5mm	14.2	63.6	-2.83				
	Bluetooth Ant 6		0.291	5mm	-6	79.6	-10.96				
Case 6	LTE B41 Ant 0	Back	0.811	5mm	-6.2	-60.4	-10.99	125.9	2.04	0.02	Not required
	WLAN5GHz Ant 8		0.94	5mm	14.2	63.6	-2.83				
	Bluetooth Ant 6		0.291	5mm	-6	79.6	-10.96				
Case 7	LTE B42 Ant 0	Back	0.428	5mm	-17	-73.2	-2.87	140.3	1.66	0.02	Not required
	WLAN5GHz Ant 8		0.94	5mm	14.2	63.6	-2.83				
	Bluetooth Ant 6		0.291	5mm	-6	79.6	-10.96				



Case	Band	Position	SAR (W/kg)	Gap (mm)	SAR peak location (mm)			3D distance (mm)	Summed SAR (W/kg)	SPLSR Results	Simultaneous SAR
					X	Y	Z				
Case 18	FR1 n77 Part 270 Ant 0	Back	0.371	5mm	-17.2	-68.2	-8.99	135.6	1.60	0.01	Not required
	WLAN5GHz Ant 8		0.94	5mm	14.2	63.6	-2.83				
	Bluetooth Ant 6		0.291	5mm	-6	79.6	-10.96				
Case 19	FR1 n77 Part 27Q Ant 0	Back	0.554	5mm	-15.6	-71.6	-10.52	138.7	1.79	0.02	Not required
	WLAN5GHz Ant 8		0.94	5mm	14.2	63.6	-2.83				
	Bluetooth Ant 6		0.291	5mm	-6	79.6	-10.96				
Case 10	LTE B41 Ant 0	Back	0.811	5mm	-6.2	-60.4	-10.99	150.6	1.60	0.01	Not required
	FR1 n77 Ant0		0.554	5mm	-15.6	-71.6	-10.52				
	WLAN2.4GHz Ant 6		0.234	5mm	-2.4	90.2	-10.82				
Case 11	LTE B41 Ant 0	Back	0.811	5mm	-6.2	-60.4	-10.99	125.9	2.60	0.03	Not required
	FR1 n77 Ant0		0.554	5mm	-15.6	-71.6	-10.52				
	WLAN5GHz Ant 8		0.94	5mm	14.2	63.6	-2.83				
	Bluetooth Ant 6		0.292	5mm	-6	79.6	-10.96				
Case 12	LTE Band 5 Ant 0	Front	0.938	5mm	2.5	-71.7	-10.59	150.5	1.62	0.01	Not required
	WLAN5GHz Ant 8		0.411	5mm	-24	76.4	-9.99				
	Bluetooth Ant 6		0.274	5mm	-23	78.6	-10.66				
Case 13	WCDMA II Ant1	Back	0.876	5mm	18	-60	-1.64	123.7	2.11	0.02	Not required
	WLAN5GHz Ant 8		0.94	5mm	14.2	63.6	-2.83				
	Bluetooth Ant 6		0.291	5mm	-6	79.6	-10.96				
Case 14	LTE Band 2 Ant1	Back	0.66	5mm	19.6	-64	-10.52	127.9	1.89	0.02	Not required
	WLAN5GHz Ant 8		0.94	5mm	14.2	63.6	-2.83				
	Bluetooth Ant 6		0.291	5mm	-6	79.6	-10.96				
Case 15	LTE Band 4 Ant1	Back	0.61	5mm	21.1	-62.5	-10.52	126.5	1.84	0.02	Not required
	WLAN5GHz Ant 8		0.94	5mm	14.2	63.6	-2.83				
	Bluetooth Ant 6		0.291	5mm	-6	79.6	-10.96				
Case 16	LTE Band 38 Ant0	Back	0.867	5mm	-13.6	-65	-10.7	131.8	2.10	0.02	Not required
	WLAN5GHz Ant 8		0.94	5mm	14.2	63.6	-2.83				
	Bluetooth Ant 6		0.291	5mm	-6	79.6	-10.96				
Case 17	FR1 n41 Ant0	Back	1.179	5mm	-8	-66.2	-10.81	131.9	2.41	0.03	Not required
	WLAN5GHz Ant 8		0.94	5mm	14.2	63.6	-2.83				
	Bluetooth Ant 6		0.291	5mm	-6	79.6	-10.96				



Case 20	Band	Position	SAR (W/kg)	Gap (mm)	SAR peak location (mm)			3D distance (mm)	Summed SAR (W/kg)	SPLSR Results	Simultaneous SAR
					X	Y	Z				
	WCDMA IV Ant1	Back	0.856	5mm	16.7	-67.4	-1.08	131.0	2.09	0.02	Not required
	WLAN5GHz Ant 8		0.94	5mm	14.2	63.6	-2.83				
	Bluetooth Ant 6		0.291	5mm	-6	79.6	-10.96				

For Body

Case 1	Band	Position	SAR (W/kg)	Gap (mm)	SAR peak location (mm)			3D distance (mm)	Summed SAR (W/kg)	SPLSR Results	Simultaneous SAR
					X	Y	Z				
	GSM850 Ant 0	Back	0.6	5mm	-2.8	-58.3	-10.98	123.3	1.83	0.02	Not required
	WLAN5GHz Ant 8		0.94	5mm	14.2	63.6	-2.83				
	Bluetooth Ant 6		0.291	5mm	-6	79.6	-10.96				
Case 2	Band	Position	SAR (W/kg)	Gap (mm)	SAR peak location (mm)			3D distance (mm)	Summed SAR (W/kg)	SPLSR Results	Simultaneous SAR
	GSM1900 Ant 1	Back	0.787	5mm	-16.7	-55.9	-10.83	123.7	2.02	0.02	Not required
	WLAN5GHz Ant 8		0.94	5mm	14.2	63.6	-2.83				
	Bluetooth Ant 6		0.291	5mm	-6	79.6	-10.96				
Case 3	Band	Position	SAR (W/kg)	Gap (mm)	SAR peak location (mm)			3D distance (mm)	Summed SAR (W/kg)	SPLSR Results	Simultaneous SAR
	WCDMA V Ant 0	Back	0.883	5mm	-4.6	-61.3	-11	126.6	2.11	0.02	Not required
	WLAN5GHz Ant 8		0.94	5mm	14.2	63.6	-2.83				
	Bluetooth Ant 6		0.291	5mm	-6	79.6	-10.96				
Case 4	Band	Position	SAR (W/kg)	Gap (mm)	SAR peak location (mm)			3D distance (mm)	Summed SAR (W/kg)	SPLSR Results	Simultaneous SAR
	LTE Band 5 Ant 0	Back	0.941	5mm	1.8	-63.9	-10.89	128.4	2.17	0.02	Not required
	WLAN5GHz Ant 8		0.94	5mm	14.2	63.6	-2.83				
	Bluetooth Ant 6		0.291	5mm	-6	79.6	-10.96				
Case 5	Band	Position	SAR (W/kg)	Gap (mm)	SAR peak location (mm)			3D distance (mm)	Summed SAR (W/kg)	SPLSR Results	Simultaneous SAR
	LTE Band 12 Ant 0	Back	0.535	5mm	3.4	-65.4	-10.89	129.7	1.77	0.02	Not required
	WLAN5GHz Ant 8		0.94	5mm	14.2	63.6	-2.83				
	Bluetooth Ant 6		0.291	5mm	-6	79.6	-10.96				
Case 6	Band	Position	SAR (W/kg)	Gap (mm)	SAR peak location (mm)			3D distance (mm)	Summed SAR (W/kg)	SPLSR Results	Simultaneous SAR
	LTE B41 Ant 0	Back	0.811	5mm	-6.2	-60.4	-10.99	125.9	2.04	0.02	Not required
	WLAN5GHz Ant 8		0.94	5mm	14.2	63.6	-2.83				
	Bluetooth Ant 6		0.291	5mm	-6	79.6	-10.96				
Case 7	Band	Position	SAR (W/kg)	Gap (mm)	SAR peak location (mm)			3D distance (mm)	Summed SAR (W/kg)	SPLSR Results	Simultaneous SAR
	LTE B42 Ant 0	Back	0.428	5mm	-17	-73.2	-2.87	140.3	1.66	0.02	Not required
	WLAN5GHz Ant 8		0.94	5mm	14.2	63.6	-2.83				
	Bluetooth Ant 6		0.291	5mm	-6	79.6	-10.96				
Case 18	Band	Position	SAR (W/kg)	Gap (mm)	SAR peak location (mm)			3D distance (mm)	Summed SAR (W/kg)	SPLSR Results	Simultaneous SAR
	FR1 n77 Part 27O Ant 0	Back	0.371	5mm	-17.2	-68.2	-8.99	135.6	1.60	0.01	Not required
	WLAN5GHz Ant 8		0.94	5mm	14.2	63.6	-2.83				
	Bluetooth Ant 6		0.291	5mm	-6	79.6	-10.96				
Case 19	Band	Position	SAR (W/kg)	Gap (mm)	SAR peak location (mm)			3D distance (mm)	Summed SAR (W/kg)	SPLSR Results	Simultaneous SAR
	FR1 n77 Part 27Q Ant 0	Back	0.554	5mm	-15.6	-71.6	-10.52	138.7	1.79	0.02	Not required
	WLAN5GHz Ant 8		0.94	5mm	14.2	63.6	-2.83				
	Bluetooth Ant 6		0.291	5mm	-6	79.6	-10.96				



Case	Band	Position	SAR (W/kg)	Gap (mm)	SAR peak location (mm)			3D distance (mm)	Summed SAR (W/kg)	SPLSR Results	Simultaneous SAR
					X	Y	Z				
Case 10	LTE B41 Ant 0	Back	0.811	5mm	-6.2	-60.4	-10.99	150.6	1.60	0.01	Not required
	FR1 n77 Ant0		0.554	5mm	-15.6	-71.6	-10.52				
	WLAN2.4GHz Ant 6		0.234	5mm	-2.4	90.2	-10.82				
Case 11	LTE B41 Ant 0	Back	0.811	5mm	-6.2	-60.4	-10.99	125.9	2.60	0.03	Not required
	FR1 n77 Ant0		0.554	5mm	-15.6	-71.6	-10.52				
	WLAN5GHz Ant 8		0.94	5mm	14.2	63.6	-2.83				
	Bluetooth Ant 6		0.291	5mm	-6	79.6	-10.96				
Case 13	WCDMA II Ant1	Back	0.876	5mm	18	-60	-1.64	123.7	2.11	0.02	Not required
	WLAN5GHz Ant 8		0.94	5mm	14.2	63.6	-2.83				
	Bluetooth Ant 6		0.291	5mm	-6	79.6	-10.96				
Case 14	LTE Band 2 Ant1	Back	0.66	5mm	19.6	-64	-10.52	127.9	1.89	0.02	Not required
	WLAN5GHz Ant 8		0.94	5mm	14.2	63.6	-2.83				
	Bluetooth Ant 6		0.291	5mm	-6	79.6	-10.96				
Case 15	LTE Band 4 Ant1	Back	0.61	5mm	21.1	-62.5	-10.52	126.5	1.84	0.02	Not required
	WLAN5GHz Ant 8		0.94	5mm	14.2	63.6	-2.83				
	Bluetooth Ant 6		0.291	5mm	-6	79.6	-10.96				
Case 16	LTE Band 38 Ant0	Back	0.867	5mm	-13.6	-65	-10.7	131.8	2.10	0.02	Not required
	WLAN5GHz Ant 8		0.94	5mm	14.2	63.6	-2.83				
	Bluetooth Ant 6		0.291	5mm	-6	79.6	-10.96				
Case 17	FR1 n41 Ant0	Back	1.179	5mm	-8	-66.2	-10.81	131.9	2.41	0.03	Not required
	WLAN5GHz Ant 8		0.94	5mm	14.2	63.6	-2.83				
	Bluetooth Ant 6		0.291	5mm	-6	79.6	-10.96				

Case	Band	Position	SAR (W/kg)	Gap (mm)	SAR peak location (mm)			3D distance (mm)	Summed SAR (W/kg)	SPLSR Results	Simultaneous SAR
					X	Y	Z				
Case 20	WCDMA IV Ant1	Back	0.856	5mm	16.7	-67.4	-1.08	131.0	2.09	0.02	Not required
	WLAN5GHz Ant 8		0.94	5mm	14.2	63.6	-2.83				
	Bluetooth Ant 6		0.291	5mm	-6	79.6	-10.96				

Test Engineer : Martin Li, Varus Wang, Light Wang, Ricky Gu



17. Uncertainty Assessment

Per KDB 865664 D01 SAR measurement 100MHz to 6GHz, when the highest measured 1-g SAR within a frequency band is < 1.5 W/kg and the measured 10-g SAR within a frequency band is < 3.75 W/kg. The expanded SAR measurement uncertainty must be $\leq 30\%$, for a confidence interval of $k = 2$. If these conditions are met, extensive SAR measurement uncertainty analysis described in IEEE Std 1528-2013 is not required in SAR reports submitted for equipment approval. For this device, the highest measured 1-g SAR is less 1.5W/kg and highest measured 10-g SAR is less 3.75W/kg. Therefore, the measurement uncertainty table is not required in this report.

18. References

- [1] FCC 47 CFR Part 2 “Frequency Allocations and Radio Treaty Matters; General Rules and Regulations”
- [2] ANSI/IEEE Std. C95.1-1992, “IEEE Standard for Safety Levels with Respect to Human Exposure to Radio Frequency Electromagnetic Fields, 3 kHz to 300 GHz”, September 1992
- [3] IEEE Std. 1528-2013, “IEEE Recommended Practice for Determining the Peak Spatial-Average Specific Absorption Rate (SAR) in the Human Head from Wireless Communications Devices: Measurement Techniques”, Sep 2013
- [4] SPEAG DASY System Handbook
- [5] FCC KDB 865664 D01 v01r04, "SAR Measurement Requirements for 100 MHz to 6 GHz", Aug 2015.
- [6] FCC KDB 865664 D02 v01r02, “RF Exposure Compliance Reporting and Documentation Considerations” Oct 2015.
- [7] FCC KDB 447498 D01 v06, “Mobile and Portable Device RF Exposure Procedures and Equipment Authorization Policies”, Oct 2015
- [8] FCC KDB 648474 D04 v01r03, “SAR Evaluation Considerations for Wireless Handsets”, Oct 2015.
- [9] FCC KDB 248227 D01 v02r02, “SAR Guidance for IEEE 802.11 (WiFi) Transmitters”, Oct 2015.
- [10] FCC KDB 941225 D01 v03r01, “3G SAR MEAUREMENT PROCEDURES”, Oct 2015
- [11] FCC KDB 941225 D05 v02r05, “SAR Evaluation Considerations for LTE Devices”, Dec 2015
- [12] FCC KDB 941225 D05A v01r02, “Rel. 10 LTE SAR Test Guidance and KDB Inquiries”, Oct 2015
- [13] FCC KDB 941225 D06 v02r01, "SAR Evaluation Procedures for Portable Devices with Wireless Router Capabilities", Oct 2015.

-----THE END-----