

FCC SAR EVALUATION REPORT

**In accordance with the requirements of
FCC 47 CFR Part 2(2.1093) and
IEEE Std 1528-2013**

Product Name: Mobile phone

Model No.: Power A07 Plus

Serial Model: Universe S24 Plus

Brand Name: KXD, EL 意龍, E&L 意龍

Report No.: AiTSZ-240815010FW7

FCC ID: 2BEC4-A07PA09P

Prepared for

Shenzhen Kenxinda Technology Co., Ltd.

5 Floors, Shenzhen Bay Science and Technology Park, Nanshan District Community,
Shenzhen, China

Prepared by

Guangdong Asia Hongke Test Technology Limited

B1/F, Building 11, Junfeng Industrial Park, Chongqing Road, Heping Community, Fuhai
Street, Bao'an District, Shenzhen, Guangdong, China

Tel.: +86 0755-230967639 Fax.: +86 0755-230967639

TEST RESULT CERTIFICATION

Applicant's name : Shenzhen Kenxinda Technology Co., Ltd.
Address : 5 Floors, Shenzhen Bay Science and Technology Park, Nanshan District Community, Shenzhen, China
Manufacturer's Name : Sichuan Southwest Prosperity Communication technology Limited Company
Address : No.98, New Tianwan Road, Lingang Development Zone, Yibin, Sichuan P.R, China

Product description

Product name : Mobile phone
Trademark : KXD, EL 意龍, E&L 意龍
Model and/or type reference : Power A07 Plus
Serial Model..... : Universe S24 Plus
FCC 47 CFR Part 2(2.1093)

Standards : IEEE Std 1528-2013
Published RF exposure KDB procedures

This device described above has been tested by Guangdong Asia Hongke Test Technology Limited. In accordance with the measurement methods and procedures specified in IEEE Std 1528-2013 and KDB 865664 D01. Testing has shown that this device is capable of compliance with localized specific absorption rate (SAR) specified in FCC 47 CFR Part 2(2.1093). The test results in this report apply only to the tested sample of the stated device/equipment. Other similar device/equipment will not necessarily produce the same results due to production tolerance and measurement uncertainties.

This report shall not be reproduced except in full, without the written approval of Guangdong Asia Hongke Test Technology Limited, this document may be altered or revised by Guangdong Asia Hongke Test Technology Limited, personal only, and shall be noted in the revision of the document.

Date of Test

Date (s) of performance of tests : Nov. 21, 2024~ Dec. 11, 2024
Date of Issue..... : Dec. 28, 2024
Test Result..... : **Pass**

Reviewed by: Simba Huang
Simba Huang

Approved by: Seal.chen
Seal.chen

※ ※ Revision History ※ ※

REV.	DESCRIPTION	ISSUED DATE	REMARK
Rev.1.0	Initial Test Report Release	Dec. 28, 2024	Seal.chen

TABLE OF CONTENTS

1. General Information	6
1.1. RF exposure limits.....	6
1.2. Statement of Compliance	7
1.3. EUT Description	8
1.4. Test specification(s).....	10
1.5. Ambient Condition.....	10
2. SAR Measurement System	11
2.1. SATIMO SAR Measurement Set-up Diagram	11
2.2. Robot	12
2.3. Probe	13
2.3.1. E-Field Probe Calibration	13
2.4. Phantoms.....	14
2.5. Technical Data	15
2.6. Device Holder	16
2.7. Test Equipment List	17
3. SAR Measurement Procedures	19
3.1. Power Reference	19
3.2. Area scan & Zoom scan.....	19
3.3. Description of interpolation/extrapolation scheme	21
3.4. Volumetric Scan	21
3.5. Power Drift	21
4. System Verification Procedure	22
4.1. Tissue Verification	22
4.1.1. Tissue Dielectric Parameter Check Results	23
4.2. System Verification Procedure	24
4.2.1. System Verification Results.....	25
5. SAR measurement variability	26
6. SAR Measurement Uncertainty	27
7. RF Exposure Positions.....	28
7.1. Ear and handset reference point	28
7.2. Definition of the cheek position	28
7.3. Definition of the tilt position	30
7.4. Body Worn Accessory	30
7.5. Wireless Router Devices.....	31
8. RF Output Power	32
8.1. GSM Conducted Power	32
8.2. WCDMA Conducted Power	33
8.3. LTE Conducted Power	35
8.4. Wi-Fi & BT Output Power.....	52



9. Antenna Location.....	53
10. Stand-alone SAR test exclusion	54
11. SAR Measurement Results.....	55
12. Simultaneous Transmission Analysis	75
Appendix A. Photo documentation.....	76
Appendix B. System Check Plots	77
Appendix C. SAR Test Plots	94
Appendix D. Calibration Certificate.....	163

1. General Information

1.1. RF exposure limits

(A).Limits for Occupational/Controlled Exposure (W/kg)

Whole-Body	Partial-Body	Hands, Wrists, Feet and Ankles
0.4	8.0	20.0

(B).Limits for General Population/Uncontrolled Exposure (W/kg)

Whole-Body	Partial-Body	Hands, Wrists, Feet and Ankles
0.08	1.6	4.0

NOTE: **Whole-Body SAR** is averaged over the entire body, **partial-body SAR** is averaged over any 1 gram of tissue defined as a tissue volume in the shape of a cube. **SAR for hands, wrists, feet and ankles** is averaged over any 10 grams of tissue defined as a tissue volume in the shape of a cube.

Occupational/Controlled Environments:

Are defined as locations where there is exposure that may be incurred by people who are aware of the potential for exposure, (i.e. as a result of employment or occupation).

General Population/Uncontrolled Environments:

Are defined as locations where there is the exposure of individuals who have no knowledge or control of their exposure.

NOTE
 HEAD AND TRUNK LIMIT
 1.6 W/kg
 APPLIED TO THIS EUT

1.2. Statement of Compliance

The maximum results of Specific Absorption Rate (SAR) found during testing as follows.

Band	Max SAR Value Reported(W/kg)		Max SAR Summation
	1-g Head (Separation distance of 0mm)	1-g Body&Hotspot (Separation distance of 10mm)	
GSM850	0.349	0.740	Head: 1.343 Body: 1.268 Hotspot: 1.268
GSM1900	0.301	0.253	
WCDMA Band II	0.085	0.392	
WCDMA Band V	0.246	0.253	
LTE band 2	0.364	0.395	
LTE band 4	0.346	0.367	
LTE band 5	0.224	0.246	
LTE band 7	0.053	0.097	
LTE band 12	0.126	0.340	
LTE band 17	0.557	0.430	
LTE band 26a	0.173	0.202	
LTE band 26b	0.093	0.106	
LTE band 41	0.778	0.701	
LTE band 66	0.064	0.386	
2.4GHz WLAN	0.417	0.223	
5.2GHz WLAN	0.468	0.446	
5.8GHz WLAN	0.565	0.528	

NOTE: The Max SAR Summation is calculated based on the same configuration and test position.

This device is in compliance with Specific Absorption Rate (SAR) for general population/uncontrolled exposure limits (1.6 W/kg) specified in FCC 47 CFR Part 2(2.1093), and had been tested in accordance with the measurement methods and procedures specified in IEEE Std 1528-2013 & KDB 865664 D01.

1.3. EUT Description

Device Information			
Product Name	Mobile phone		
Model Name	Power A07 Plus		
Family Model	Universe S24 Plus		
Device Phase	Identical Prototype		
Exposure Category	General population / Uncontrolled environment		
Antenna Type	PIFA Antenna		
Power rating:	Input: DC 5V/2A DC 3.85V 4300mAh 16.555Wh Rechargeable Li-ion battery		
Hardware version	A07_MB_V1.0		
Software version	A07PLUS_KXD_A14_V1.11		
Device Operating Configurations			
Supporting Mode(s)	GSM850/1900,WCDMABand2/5,LTEBand2/4/5/7/12/17/26a/26b/41/66, WLAN 2.4G/5.2G/5.8G, Bluetooth		
Test Modulation	GSM(GMSK/8PSK), WCDMA(QPSK), LTE(QPSK/16QAM), WLAN(DSSS/OFDM), Bluetooth(GFSK, $\pi/4$ -DQPSK, 8DPSK)		
Device Class	B		
Operating Frequency Range(s)	Band	Tx (MHz)	Rx (MHz)
	GSM 850	824-849	869-894
	GSM 1900	1850-1910	1930-1990
	WCDMA Band 2	1850-1910	1930-1990
	WCDMA Band 5	824-849	869-894
	LTE Band 2	1850-1910	1930-1990
	LTE Band 4	1710-1755	2110-2155
	LTE Band 5	824-849	869-894
	LTE Band 7	2500-2570	2620-2690
	LTE Band 12	699-716	729-746
	LTE Band 17	704-716	734-746
	LTE Band 26a	814-824	859-869
	LTE Band 26b	824-849	869-894
	LTE Band 41	2555-2655	
	LTE Band 66	1710-1780	2110-2200
	WLAN 2.4G	2412-2462	
	WLAN 5.2G	5180-5240	
WLAN 5.8G	5745-5825		
Bluetooth	2402-2480		
GPRS Multislot Class(12)	Max Number of Timeslots in Uplink	4	
	Max Number of Timeslots in Downlink	4	

	Max Total Timeslot	5
EGPRS Multislot Class(12)	Max Number of Timeslots in Uplink	4
	Max Number of Timeslots in Downlink	4
	Max Total Timeslot	5
Power Class	4, tested with power level 5(GSM 850)	
	1, tested with power level 0(GSM 1900)	
	3, tested with power control "all 1"(WCDMA Band 2)	
	3, tested with power control "all 1"(WCDMA Band 5)	
	3, tested with power control all Max.(LTE Band 2)	
	3, tested with power control all Max.(LTE Band 4)	
	3, tested with power control all Max.(LTE Band 5)	
	3, tested with power control all Max.(LTE Band 7)	
	3, tested with power control all Max.(LTE Band 12)	
	3, tested with power control all Max.(LTE Band 17)	
	3, tested with power control all Max.(LTE Band 26a)	
	3, tested with power control all Max.(LTE Band 26b)	
	3, tested with power control all Max.(LTE Band 41)	
	3, tested with power control all Max.(LTE Band 66)	

1.4. Test specification(s)

FCC 47 CFR Part 2(2.1093)
IEEE Std 1528-2013
KDB 865664 D01 SAR measurement 100 MHz to 6 GHz
KDB 865664 D02 RF Exposure Reporting
KDB 447498 D01 General RF Exposure Guidance
KDB 248227 D01 802.11 Wi-Fi SAR
KDB 941225 D01 3G SAR Procedures
KDB 941225 D05 SAR for LTE Devices
KDB 941225 D06 Hotspot SAR
KDB 648474 D04 Handset SAR

1.5. Ambient Condition

Ambient temperature	20°C – 24°C
Relative Humidity	30% – 70%

2. SAR Measurement System

2.1. SATIMO SAR Measurement Set-up Diagram

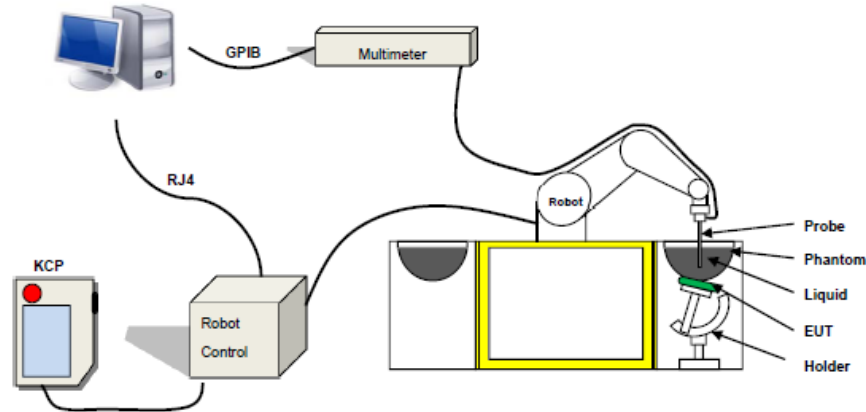

These measurements were performed with the automated near-field scanning system OPENSAR from SATIMO. The system is based on a high precision robot (working range: 901 mm), which positions the probes with a positional repeatability of better than ± 0.03 mm. The SAR measurements were conducted with dosimetric probe (manufactured by SATIMO), designed in the classical triangular configuration and optimized for dosimetric evaluation.

The first step of the field measurement is the evaluation of the voltages induced on the probe by the device under test. Probe diode detectors are nonlinear. Below the diode compression point, the output voltage is proportional to the square of the applied E-field; above the diode compression point, it is linear to the applied E-field. The compression point depends on the diode, and a calibration procedure is necessary for each sensor of the probe.

The Keithley multimeter reads the voltage of each sensor and send these three values to the PC. The corresponding E field value is calculated using the probe calibration factors, which are stored in the working directory. This evaluation includes linearization of the diode characteristics. The field calculation is done separately for each sensor. Each component of the E field is displayed on the "Dipole Area Scan Interface" and the total E field is displayed on the "3D Interface"

2.2. Robot

The SATIMO SAR system uses the high precision robots from KUKA. For the 6-axis controller system, the robot controller version (KUKA) from KUKA is used. The KUKA robot series have many features that are important for our application:



- High precision (repeatability ± 0.03 mm)
- High reliability (industrial design)
- Jerk-free straight movements
- Low ELF interference (the closed metallic construction shields against motor control fields)

2.3. Probe

This E-field detection probe is composed of three orthogonal dipoles linked to special Schottky diodes with low detection thresholds. The probe allows the measurement of electric fields in liquids such as the one defined in the IEEE and CENELEC standards.

For the measurements the Specific Dosimetric E-Field Probe EPGO 0523-403 with following specifications is used.



- Probe Length: 330 mm
- Length of Individual Dipoles: 2 mm
- Maximum external diameter: 8 mm
- Probe Tip External Diameter: 2.5 mm
- Distance between dipole/probe extremity: 1 mm
- Dynamic range: 0.01-100 W/kg
- Probe linearity: 3%
- Axial Isotropy: < 0.10 dB
- Spherical Isotropy: < 0.10 dB
- Calibration range: 150 MHz to 6 GHz for head & body simulating liquid.
- Angle between probe axis (evaluation axis) and surface normal line: less than 30°

2.3.1. E-Field Probe Calibration

Each probe needs to be calibrated according to a dosimetric assessment procedure with accuracy better than $\pm 10\%$. The spherical isotropy shall be evaluated and within $\pm 0.25\text{dB}$. The sensitivity parameters (Norm X, Norm Y, and Norm Z), the diode compression parameter (DCP) and the conversion factor (Conv F) of the probe are tested. The calibration data can be referred to appendix D of this report.

2.4. Phantoms

For the measurements the Specific Anthropomorphic Mannequin (SAM) defined by the IEEE SCC-34/SC2 group is used. The phantom is a polyurethane shell integrated in a wooden table. The thickness of the phantom amounts to 2mm +/- 0.2mm. It enables the dosimetric evaluation of left and right phone usage and includes an additional flat phantom part for the simplified performance check. The phantom set-up includes a cover, which prevents the evaporation of the liquid.



SAM

2.5. Technical Data

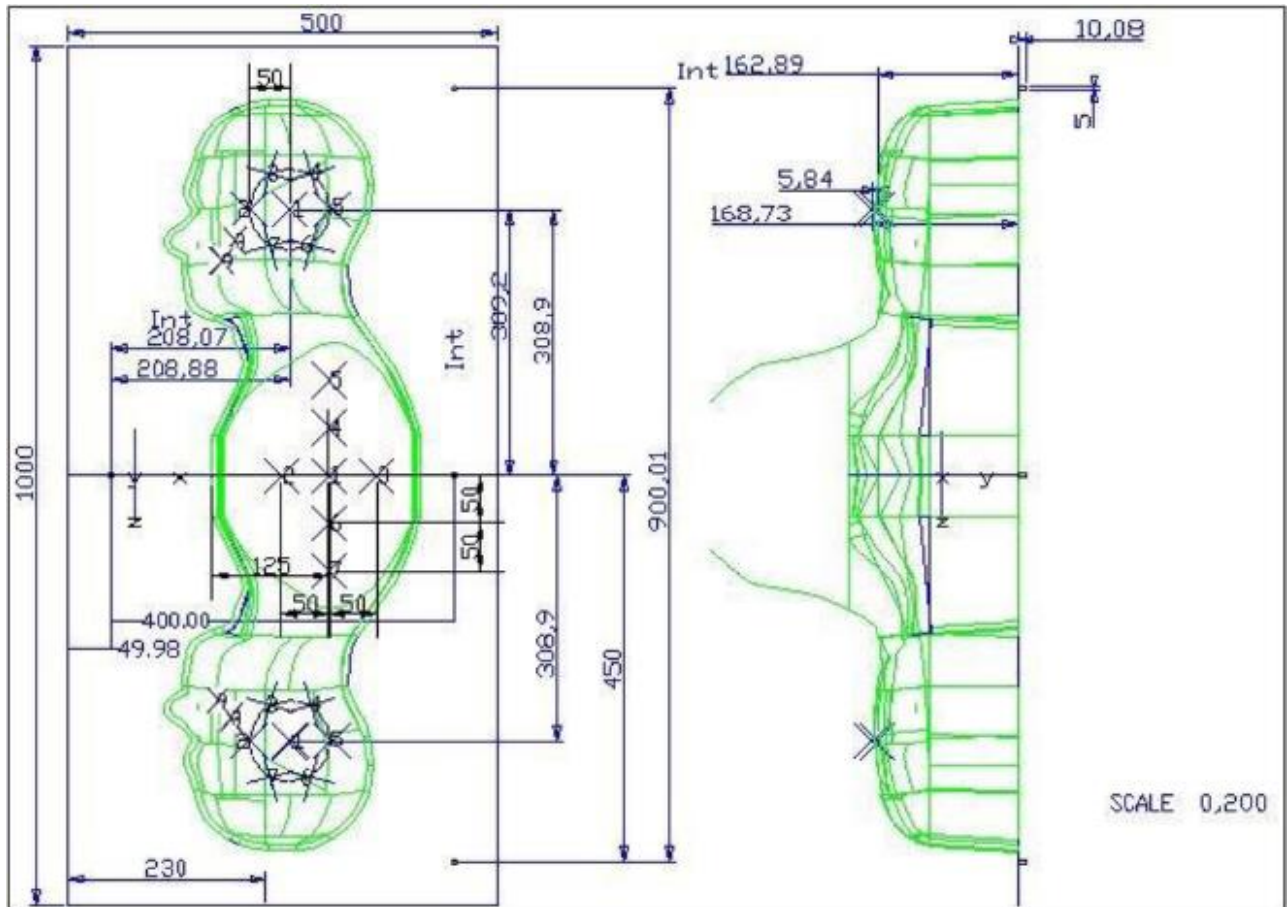

Left Head(mm)		Right Head(mm)		Flat Part(mm)	
2	2.02	2	2.08	1	2.09
3	2.05	3	2.06	2	2.06
4	2.07	4	2.07	3	2.08
5	2.08	5	2.08	4	2.10
6	2.05	6	2.07	5	2.10
7	2.05	7	2.05	6	2.07
8	2.07	8	2.06	7	2.07
9	2.08	9	2.06	-	-

The test, based on ultrasonic system, allows measuring the thickness with an accuracy of 10 µm.

2.6. Device Holder

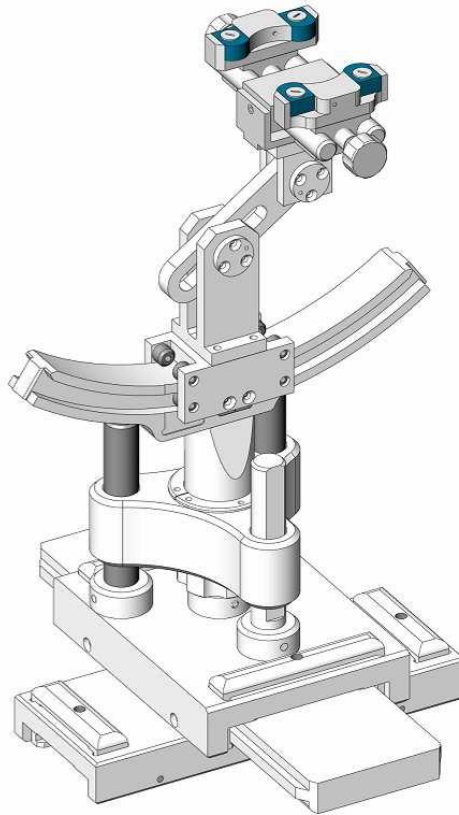

The SAR in the phantom is approximately inversely proportional to the square of the distance between the source and the liquid surface. For a source at 5 mm distance, a positioning uncertainty of ± 0.5 mm would produce a SAR uncertainty of ± 20 %. Accurate device positioning is therefore crucial for accurate and repeatable measurements. The positions in which the devices must be measured are defined by the standards.

2.7. Test Equipment List

This table gives a complete overview of the SAR measurement equipment.

Devices used during the test described are marked

	Manufacturer	Name of Equipment	Type/Model	Serial Number	Calibration	
					Last Cal.	Due Date
<input checked="" type="checkbox"/>	MVG	E FIELD PROBE	SSE2	EPGO 0523-403	Sep. 11, 2024	Sep. 10, 2025
<input checked="" type="checkbox"/>	MVG	750 MHz Dipole	SID750	SN 03/15 DIP 0G750-355	Feb. 21, 2024	Feb. 20, 2027
<input checked="" type="checkbox"/>	MVG	835 MHz Dipole	SID835	SN 03/15 DIP 0G835-347	Feb. 21, 2024	Feb. 20, 2027
<input type="checkbox"/>	MVG	900 MHz Dipole	SID900	SN 03/15 DI P 0G900-348	Feb. 21, 2024	Feb. 20, 2027
<input checked="" type="checkbox"/>	MVG	1800 MHz Dipole	SID1800	SN 03/15 DIP 1G800-349	Feb. 21, 2024	Feb. 20, 2027
<input checked="" type="checkbox"/>	MVG	1900 MHz Dipole	SID1900	SN 03/15 DIP 1G900-350	Feb. 21, 2024	Feb. 20, 2027
<input type="checkbox"/>	MVG	2000 MHz Dipole	SID2000	SN 03/15 DIP 2G000-351	Feb. 21, 2024	Feb. 20, 2027
<input type="checkbox"/>	MVG	2300 MHz Dipole	SID2300	SN 03/16 DIP 2G300-358	Feb. 21, 2024	Feb. 20, 2027
<input checked="" type="checkbox"/>	MVG	2450 MHz Dipole	SID2450	SN 03/15 DIP 2G450-352	Feb. 21, 2024	Feb. 20, 2027
<input checked="" type="checkbox"/>	MVG	2600 MHz Dipole	SID2600	SN 03/15 DIP 2G600-356	Feb. 21, 2024	Feb. 20, 2027
<input checked="" type="checkbox"/>	MVG	5000 MHz Dipole	SWG5500	SN 13/14 WGA 33	Feb. 21, 2024	Feb. 20, 2027
<input checked="" type="checkbox"/>	MVG	Liquid measurement Kit	SCLMP	SN 21/15 OCPG 72	Jul. 01, 2024	Jun. 30, 2025
<input checked="" type="checkbox"/>	MVG	Power Amplifier	N.A	AMPLISAR_28/14_003	NCR	NCR
<input checked="" type="checkbox"/>	KEITHLEY	Millivoltmeter	2000	4072790	Jul. 01, 2024	Jun. 30, 2025
<input checked="" type="checkbox"/>	R&S	Universal radio communication tester	CMU200	117858	Jul. 01, 2024	Jun. 30, 2025
<input checked="" type="checkbox"/>	R&S	Wideband radio communication tester	CMW500	116581	Jul. 01, 2024	Jun. 30, 2025
<input checked="" type="checkbox"/>	HP	Network Analyzer	8753D	3410J01136	Jul. 01, 2024	Jun. 30, 2025

<input checked="" type="checkbox"/>	Agilent	PSG Analog Signal Generator	E8257D	MY51110112	Jul. 01, 2024	Jun. 30, 2025
<input checked="" type="checkbox"/>	Agilent	Power meter	E4419B	MY45102538	Jul. 01, 2024	Jun. 30, 2025
<input checked="" type="checkbox"/>	Agilent	Power meter	E4419B	MY45102140	Jul. 01, 2024	Jun. 30, 2025
<input checked="" type="checkbox"/>	Agilent	Power meter	E4419B	MY45102215	Jul. 01, 2024	Jun. 30, 2025
<input checked="" type="checkbox"/>	JFW	attenuator	50FPE-006	4360846-494-4	Jul. 01, 2024	Jun. 30, 2025
<input checked="" type="checkbox"/>	JFW	attenuator	50FPE-006	4360846-492-1	Jul. 01, 2024	Jun. 30, 2025
<input checked="" type="checkbox"/>	JFW	attenuator	50FPE-006	4360846-490-6	Jul. 01, 2024	Jun. 30, 2025
<input checked="" type="checkbox"/>	Agilent	Power sensor	E9301A	MY41495644	Jul. 01, 2024	Jun. 30, 2025
<input checked="" type="checkbox"/>	Agilent	Power sensor	E9301A	US39212148	Jul. 01, 2024	Jun. 30, 2025
<input checked="" type="checkbox"/>	MCLI/USA	Directional Coupler	CB11-20	0D2L51502	Jul. 17, 2024	Jul. 16, 2027
<input checked="" type="checkbox"/>	MVG	SAR Phantom	SSM2	SN 24/11 SAM87	NCR	NCR
<input checked="" type="checkbox"/>	MVG	Device Holder	SMPPD	SN 24/11 MSH73	NCR	NCR

3. SAR Measurement Procedures

The measurement procedures are as follows:

<Conducted power measurement>

- (a) For WWAN power measurement, use base station simulator to configure EUT WWAN transmission in conducted connection with RF cable, at maximum power in each supported wireless interface and frequency band.
- (b) Read the WWAN RF power level from the base station simulator.
- (c) For Wi-Fi/BT power measurement, use engineering software to configure EUT Wi-Fi/BT continuously transmission, at maximum RF power in each supported wireless interface and frequency band.
- (d) Connect EUT RF port through RF cable to the power meter, and measure Wi-Fi/BT output power.

<SAR measurement>

- (a) Use base station simulator to configure EUT WWAN transmission in radiated connection, and engineering software to configure EUT Wi-Fi/BT continuously transmission, at maximum RF power, in the highest power channel.
- (b) Place the EUT in the positions as Appendix A demonstrates.
- (c) Set scan area, grid size and other setting on the OPENSAR software.
- (d) Measure SAR results for the highest power channel on each testing position.
- (e) Find out the largest SAR result on these testing positions of each band.
- (f) Measure SAR results for other channels in worst SAR testing position if the reported SAR of highest power channel is larger than 0.8 W/kg.

According to the test standard, the recommended procedure for assessing the peak spatial-average SAR value consists of the following steps:

- (a) Power reference measurement
- (b) Area scan
- (c) Zoom scan
- (d) Power drift measurement

3.1. Power Reference

The Power Reference Measurement and Power Drift Measurements are for monitoring the power drift of the device under test in the batch process. The minimum distance of probe sensors to surface determines the closest measurement point to phantom surface. This distance cannot be smaller than the distance of sensor calibration points to probe tip as defined in the probe properties.

3.2. Area scan & Zoom scan

The area scan is a 2D scan to find the hot spot location on the DUT. The zoom scan is a 3D scan

above the hot spot to calculate the 1g and 10g SAR value.

Measurement of the SAR distribution with a grid of 8 to 16 mm * 8 to 16 mm and a constant distance to the inner surface of the phantom. Since the sensors cannot directly measure at the inner phantom surface, the values between the sensors and the inner phantom surface are extrapolated. With these values the area of the maximum SAR is calculated by an interpolation scheme. Around this point, a cube of 30 * 30 * 30 mm or 32 * 32 * 32 mm is assessed by measuring 5 or 8 * 5 or 8 * 4 or 5 mm. With these data, the peak spatial-average SAR value can be calculated.

From the scanned SAR distribution, identify the position of the maximum SAR value, in addition identify the positions of any local maxima with SAR values within 2 dB of the maximum value that will not be within the zoom scan of other peaks; additional peaks shall be measured only when the primary peak is within 2 dB of the SAR compliance limit (e.g., 1 W/kg for 1,6 W/kg 1 g limit, or 1,26 W/kg for 2 W/kg, 10 g limit).

Area scan & Zoom scan scan parameters extracted from FCC KDB 865664 D01 SAR measurement 100 MHz to 6 GHz.

		≤ 3 GHz	> 3 GHz
Maximum distance from closest measurement point (geometric center of probe sensors) to phantom surface		5 ± 1 mm	$\frac{1}{2} \cdot \delta \cdot \ln(2) \pm 0.5$ mm
Maximum probe angle from probe axis to phantom surface normal at the measurement location		30° ± 1°	20° ± 1°
Maximum area scan spatial resolution: Δx_{Area} , Δy_{Area}		≤ 2 GHz: ≤ 15 mm 2 – 3 GHz: ≤ 12 mm	3 – 4 GHz: ≤ 12 mm 4 – 6 GHz: ≤ 10 mm
		When the x or y dimension of the test device, in the measurement plane orientation, is smaller than the above, the measurement resolution must be ≤ the corresponding x or y dimension of the test device with at least one measurement point on the test device.	
Maximum zoom scan spatial resolution: Δx_{Zoom} , Δy_{Zoom}		≤ 2 GHz: ≤ 8 mm 2 – 3 GHz: ≤ 5 mm*	3 – 4 GHz: ≤ 5 mm* 4 – 6 GHz: ≤ 4 mm*
Maximum zoom scan spatial resolution, normal to phantom surface	uniform grid: $\Delta z_{Zoom}(n)$	≤ 5 mm	3 – 4 GHz: ≤ 4 mm 4 – 5 GHz: ≤ 3 mm 5 – 6 GHz: ≤ 2 mm
	graded grid	$\Delta z_{Zoom}(1)$: between 1 st two points closest to phantom surface	≤ 4 mm 3 – 4 GHz: ≤ 3 mm 4 – 5 GHz: ≤ 2.5 mm 5 – 6 GHz: ≤ 2 mm
		$\Delta z_{Zoom}(n>1)$: between subsequent points	≤ 1.5 · $\Delta z_{Zoom}(n-1)$
Minimum zoom scan volume	x, y, z	≥ 30 mm	3 – 4 GHz: ≥ 28 mm 4 – 5 GHz: ≥ 25 mm 5 – 6 GHz: ≥ 22 mm
Note: δ is the penetration depth of a plane-wave at normal incidence to the tissue medium; see draft standard IEEE P1528-2011 for details.			
* When zoom scan is required and the <i>reported</i> SAR from the <i>area scan based 1-g SAR estimation</i> procedures of KDB 447498 is ≤ 1.4 W/kg, ≤ 8 mm, ≤ 7 mm and ≤ 5 mm zoom scan resolution may be applied, respectively, for 2 GHz to 3 GHz, 3 GHz to 4 GHz and 4 GHz to 6 GHz.			

3.3. Description of interpolation/extrapolation scheme

The local SAR inside the phantom is measured using small dipole sensing elements inside a probe body. The probe tip must not be in contact with the phantom surface in order to minimise measurements errors, but the highest local SAR will occur at the surface of the phantom.

An extrapolation is used to determine these highest local SAR values. The extrapolation is based on a fourth-order least-square polynomial fit of measured data. The local SAR value is then extrapolated from the liquid surface with a 1 mm step.

The measurements have to be performed over a limited time (due to the duration of the battery) so the step of measurement is high. It could vary between 5 and 8 mm. To obtain an accurate assessment of the maximum SAR averaged over 10 grams and 1 gram requires a very fine resolution in the three dimensional scanned data array.

3.4. Volumetric Scan

The volumetric scan consists of a full 3D scan over a specific area. This 3D scan is useful for multi Tx SAR measurement. Indeed, it is possible with OpenSAR to add, point by point, several volumetric scans to calculate the SAR value of the combined measurement as it is defined in the standard IEEE1528 and IEC62209.

3.5. Power Drift

All SAR testing is under the EUT installed with a full charged battery and transmit maximum output power. In OpenSAR measurement software, the power reference measurement and power drift measurement procedures are used for monitoring the power drift of EUT during SAR test. Both these procedures measure the field at a specified reference position before and after the SAR testing. The software will calculate the field difference in V/m. If the power drifts more than $\pm 5\%$, the SAR will be retested.

4. System Verification Procedure

4.1. Tissue Verification

The following tissue formulations are provided for reference only as some of the parameters have not been thoroughly verified. The composition of ingredients may be modified accordingly to achieve the desired target tissue parameters required for routine SAR evaluation.

Ingredients (% of weight)	Head Tissue									
	750	835	900	1800	1900	2000	2450	2600	5200	5800
Frequency Band (MHz)	750	835	900	1800	1900	2000	2450	2600	5200	5800
Water	34.40	34.40	34.40	55.36	55.36	57.87	57.87	57.87	65.53	65.53
NaCl	0.79	0.79	0.79	0.35	0.35	0.16	0.16	0.16	0.00	0.00
1,2-Propanediol	64.81	64.81	64.81	0.00	0.00	0.00	0.00	0.00	0.00	0.00
Triton X-100	0.00	0.00	0.00	30.45	30.45	19.97	19.97	19.97	24.24	24.24
DGBE	0.00	0.00	0.00	13.84	13.84	22.00	22.00	22.00	10.23	10.23

For SAR measurement of the field distribution inside the phantom, the phantom must be filled with homogeneous tissue simulating liquid to a depth of at least 15 cm. For head SAR testing, the liquid depth from the ear reference point (ERP) of the phantom to the liquid top surface is larger than 15 cm.



4.1.1. Tissue Dielectric Parameter Check Results

The simulating liquids should be checked at the beginning of a series of SAR measurements to determine of the dielectric parameter are within the tolerances of the specified target values. The measured conductivity and relative permittivity should be within $\pm 5\%$ of the target values.

Tissue Type	Measured Frequency (MHz)	Target Tissue		Measured Tissue		Liquid Temp.	Test Date
		$\epsilon_r (\pm 5\%)$	σ (S/m) ($\pm 5\%$)	ϵ_r	σ (S/m)		
Head 750	750	41.96 (39.86~44.06)	0.89 (0.85~0.93)	42.56	0.91	21.6 °C	Dec. 09, 2024
Head 850	835	41.50 (39.43~43.58)	0.90 (0.86~0.95)	42.01	0.94	21.7 °C	Dec. 03, 2024
Head 1800	1800	40.00 (38.00~42.00)	1.40 (1.33~1.47)	39.61	1.41	21.6 °C	Nov. 21, 2024
Head 1900	1900	40.00 (38.00~42.00)	1.40 (1.33~1.47)	41.42	1.39	21.4 °C	Nov. 25, 2024
Head 2450	2450	39.20 (37.24~41.16)	1.80 (1.71~1.89)	40.41	1.82	21.2 °C	Nov. 28, 2024
Head 2600	2600	39.01 (37.06~40.96)	1.96 (1.86~2.06)	39.43	1.99	21.4 °C	Dec. 11, 2024
Head 5200	5200	36.00 (34.20~37.80)	4.66 (4.43~4.89)	37.40	4.51	21.5 °C	Dec. 04, 2024
Head 5800	5800	35.30 (33.54~37.07)	5.27 (5.01~5.53)	35.30	5.27	21.3 °C	Dec. 05, 2024

NOTE: The dielectric parameters of the tissue-equivalent liquid should be measured under similar ambient conditions and within 2 °C of the conditions expected during the SAR evaluation to satisfy protocol requirements.

4.2. System Verification Procedure

The system verification is performed for verifying the accuracy of the complete measurement system and performance of the software. The dipole is connected to the signal source consisting of signal generator and amplifier via a directional coupler, N-connector cable and adaption to SMA. It is fed with a power of 100mW (below 5GHz) or 100mW (above 5GHz). To adjust this power a power meter is used. The power sensor is connected to the cable before the system verification to measure the power at this point and do adjustments at the signal generator. At the outputs of the directional coupler both return loss as well as forward power are controlled during the system verification to make sure that emitted power at the dipole is kept constant. This can also be checked by the power drift measurement after the test (result on plot).

The system verification is shown as below picture:

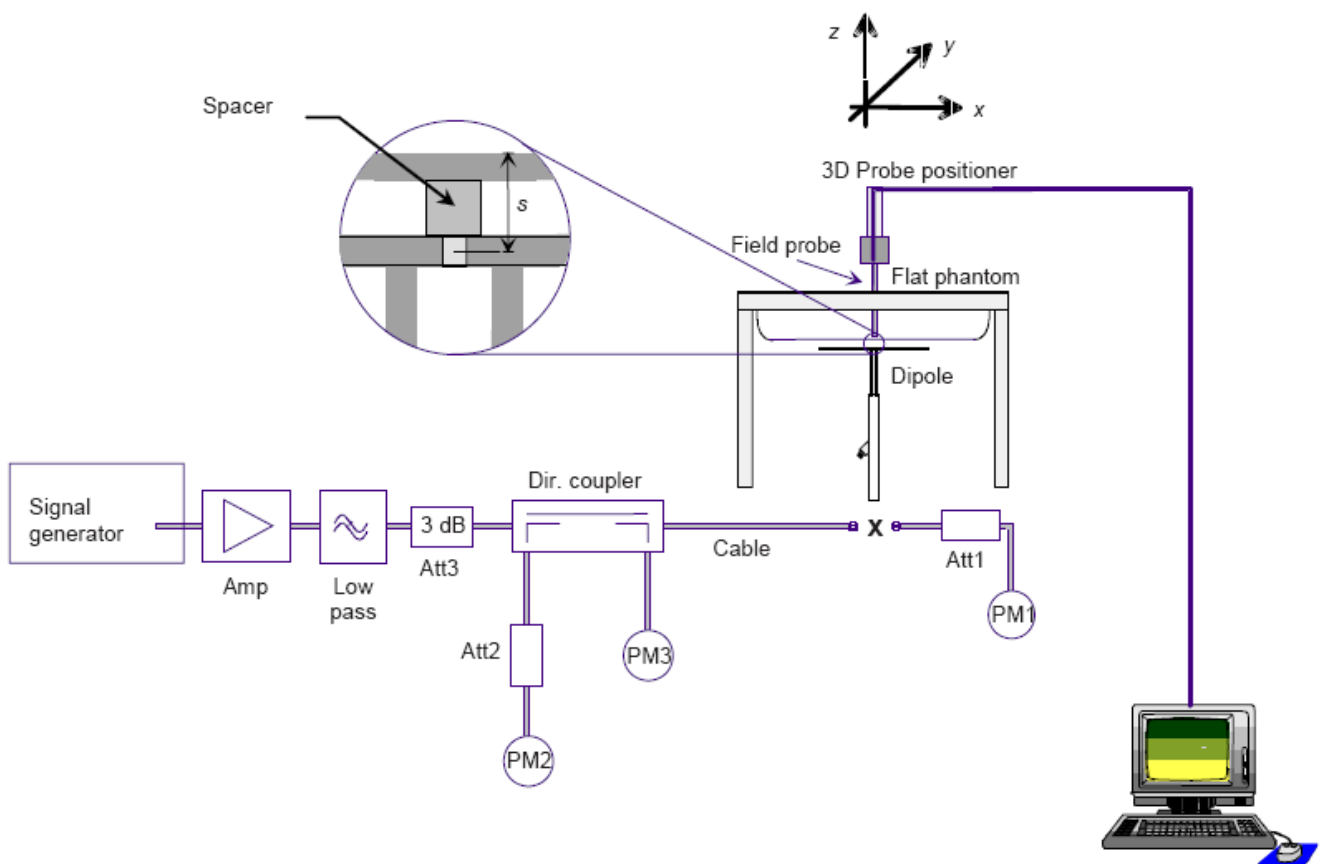

4.2.1. System Verification Results

Comparing to the original SAR value provided by SATIMO, the verification data should be within its specification of $\pm 10\%$. Below table shows the target SAR and measured SAR after normalized to 1W input power. The table below indicates the system performance verification can meet the variation criterion and the plots can be referred to Appendix B of this report.

System Verification	Target SAR (1W) ($\pm 10\%$)		Measured SAR Normalized to 1W (100mW)		Liquid Temp.	Test Date
	1-g (W/Kg)	10-g (W/Kg)	1-g (W/Kg)	10-g (W/Kg)		
750MHz	8.60 (7.74~9.46)	5.78 (5.20~6.36)	9.30 (0.930)	6.21 (0.621)	21.6 °C	Dec. 09, 2024
835MHz	9.40 (8.46~10.34)	6.28 (5.65~6.91)	10.11 (1.011)	6.12 (0.612)	21.7 °C	Dec. 03, 2024
1800MHz	37.06 (33.35~40.77)	20.01 (18.01~22.01)	38.32 (3.832)	20.25 (2.025)	21.6 °C	Nov. 21, 2024
1900MHz	39.69 (35.72~43.66)	20.92 (18.83~23.01)	41.54 (4.154)	21.53 (2.153)	21.4 °C	Nov. 25, 2024
2450MHz	50.05 (45.05~55.06)	23.80 (21.42~26.18)	51.84 (5.184)	23.59 (2.359)	21.2 °C	Nov. 28, 2024
2600MHz	54.16 (48.74~59.58)	24.85 (22.37~27.34)	54.33 (5.433)	25.23 (2.523)	21.4 °C	Dec. 11, 2024
5200MHz	162.59 (146.33~178.85)	56.21 (50.59~61.83)	147.12 (14.712)	52.12 (5.212)	21.5 °C	Dec. 04, 2024
5800MHz	182.20 (163.98~200.42)	61.32 (55.19~67.45)	164.21 (16.421)	56.23 (5.623)	21.3 °C	Dec. 05, 2024

5. SAR measurement variability

Per KDB865664 D01 SAR measurement 100 MHz to 6 GHz, SAR measurement variability must be assessed for each frequency band, which is determined by the SAR probe calibration point and tissue-equivalent medium used for the device measurements. The additional measurements are repeated after the completion of all measurements requiring the same head or body tissue-equivalent medium in a frequency band. The test device should be returned to ambient conditions (normal room temperature) with the battery fully charged before it is re-mounted on the device holder for the repeated measurement(s) to minimize any unexpected variations in the repeated results.

1) Repeated measurement is not required when the original highest measured SAR is < 0.80 W/kg; steps 2) through 4) do not apply.

2) When the original highest measured SAR is ≥ 0.80 W/kg, repeat that measurement once.

3) Perform a second repeated measurement only if the ratio of largest to smallest SAR for the original and first repeated measurements is > 1.20 or when the original or repeated measurement is ≥ 1.45 W/kg (~ 10% from the 1-g SAR limit).

4) Perform a third repeated measurement only if the original, first or second repeated measurement is ≥ 1.5 W/kg and the ratio of largest to smallest SAR for the original, first and second repeated measurements is > 1.20 .

6. SAR Measurement Uncertainty

Per KDB865664 D01 SAR Measurement 100 MHz to 6 GHz, when the highest measured 1-g SAR within a frequency band is < 1.5 W/kg, the extensive SAR measurement uncertainty analysis described in IEEE Std 1528-2013 is not required in SAR reports submitted for equipment approval. The equivalent ratio (1.5/1.6) is applied to extremity and occupational exposure conditions.

7. RF Exposure Positions

7.1. Ear and handset reference point

Figure 7.1.1 shows the front, back, and side views of the SAM phantom. The center-of-mouth reference point is labeled “M”, the left ear reference point (ERP) is marked “LE”, and the right ERP is marked “RE”.



Fig 7.1.1 Front, back, and side views of SAM phantom

7.2. Definition of the cheek position

1. Define two imaginary lines on the handset, the vertical centerline and the horizontal line. The vertical centerline passes through two points on the front side of the handset: the midpoint of the width w_t of the handset at the level of the acoustic output (point A in Figure 7.2.1 and Figure 7.2.2), and the midpoint of the width w_b of the bottom of the handset (point B). The horizontal line is perpendicular to the vertical centerline and passes through the center of the acoustic output (see Figure 7.2.1). The two lines intersect at point A. Note that for many handsets, point A coincides with the center of the acoustic output; however, the acoustic output may be located elsewhere on the horizontal line. Also note that the vertical centerline is not necessarily parallel to the front face of the handset (see Figure 7.2.2), especially for clamshell handsets, handsets with flip covers, and other irregularly-shaped handsets.
2. Position the handset close to the surface of the phantom such that point A is on the (virtual) extension of the line passing through points RE and LE on the phantom (see Figure 7.2.3), such that the plane defined by the vertical centerline and the horizontal line of the handset is approximately parallel to the sagittal plane of the phantom.
3. Translate the handset towards the phantom along the line passing through RE and LE until handset point A touches the pinna at the ERP
4. While maintaining the handset in this plane, rotate it around the LE-RE line until the vertical centerline is in the plane normal to the plane containing B-M and N-F lines, i.e., the Reference Plane.
5. Rotate the handset around the vertical centerline until the handset (horizontal line) is parallel to the N-F line.

6. While maintaining the vertical centerline in the Reference Plane, keeping point A on the line passing through RE and LE, and maintaining the handset contact with the pinna, rotate the handset about the N-F line until any point on the handset is in contact with a phantom point below the pinna on the cheek. See Figure 7.2.3. The actual rotation angles should be documented in the test report.

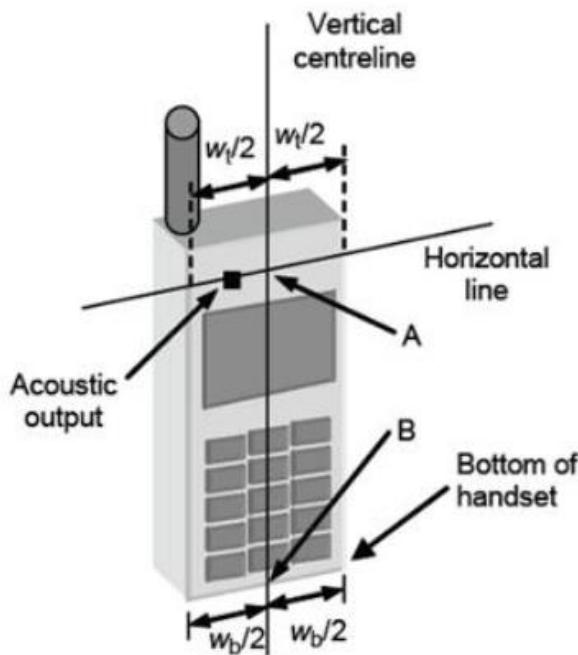

Fig 7.2.1 Handset vertical and horizontal reference lines—fixed case

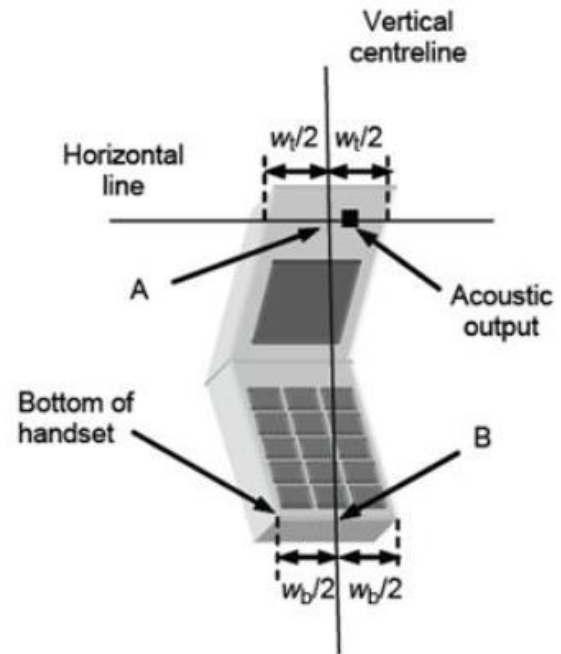

Fig 7.2.2 Handset vertical and horizontal reference lines—“clam-shell case”

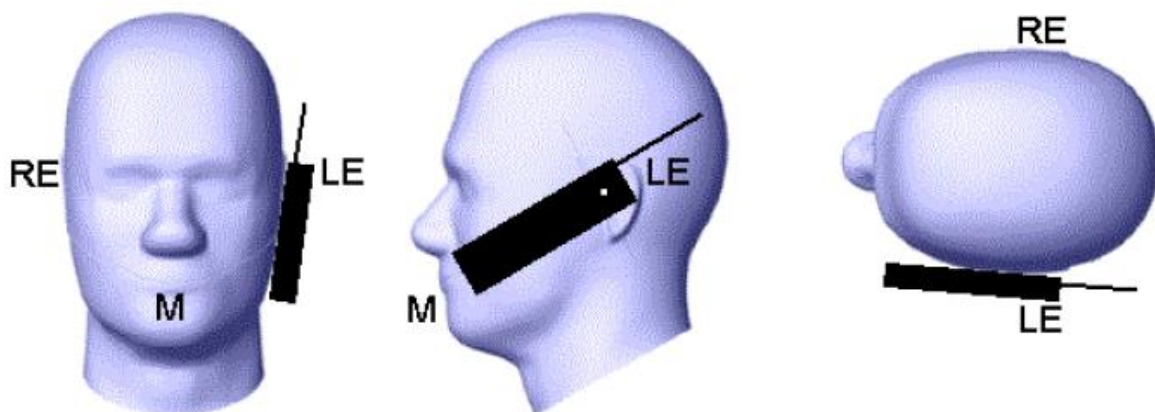

Fig 7.2.3 cheek or touch position. The reference points for the right ear (RE), left ear (LE), and mouth (M), which establish the Reference Plane for handset positioning, are indicated.

7.3. Definition of the tilt position

1. While maintaining the orientation of the handset, retract the handset parallel to the reference plane far enough away from the phantom to enable a rotation of the device by 15 degree.
2. Rotate the Handset around the horizontal line by 15 degree (see Figure 7.3.1).
3. While maintaining the orientation of the handset, move the handset towards the phantom on a line passing through RE and LE until any part of the handset touches the ear. The tilt position is obtained when the contact is on the pinna. If the contact is at any location other than the pinna, e.g., the antenna with the back of the phantom head, the angle of the handset shall be reduced. In this case, the tilt position is obtained if any part of the handset is in contact with the pinna as well as a second part of the handset is in contact with the phantom, e.g., the antenna with the back of the head.



Figure 7.3.1 – Tilt position of the wireless device on the left side of SAM

7.4. Body Worn Accessory

1. Body-worn operating configurations are tested with the belt-clips and holsters attached to the device and positioned against a flat phantom in a normal use configuration (see Figure 7.4.1). Per KDB 648474 D04, body-worn accessory exposure is typically related to voice mode operations when handsets are carried in body-worn accessories. The body-worn accessory procedures in FCC KDB 447498 D01 should be used to test for body-worn accessory SAR compliance, without a headset connected to it. This enables the test results for such configuration to be compatible with that required for hotspot mode when the body-worn accessory test separation distance is greater than or equal to that required for hotspot mode, when applicable. When the reported SAR for body-worn accessory, measured without a headset connected to the handset is $< 1.2 \text{ W/kg}$, the highest reported SAR configuration for that wireless mode and frequency band should be repeated for that body-worn accessory with a headset attached to the handset.
2. Accessories for body-worn operation configurations are divided into two categories: those that do not contain metallic components and those that do contain metallic components and those that do

contain metallic components. When multiple accessories that do not contain metallic components are supplied with the device, the device is tested with only the accessory that dictates the closest spacing to the body. Then multiple accessories that contain metallic components are test with the device with each accessory. If multiple accessories share an identical metallic component (i.e. the same metallic belt-chip used with different holsters with no other metallic components) only the accessory that dictates the closest spacing to the body is tested.

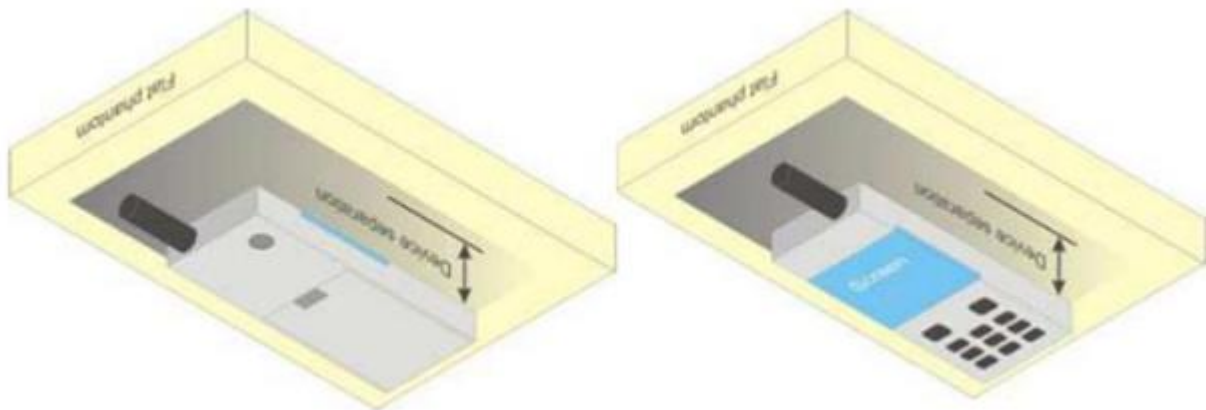

Figure 7.4.1 – Test positions for body-worn devices

7.5. Wireless Router Devices

Some battery-operated handsets have the capability to transmit and receive user through simultaneous transmission of WLAN simultaneously with a separate licensed transmitter. The FCC has provided guidance in FCC KDB Publication 941225 D06 where SAR test considerations for handsets ($L \times W \geq 9 \text{ cm} \times 5 \text{ cm}$) are based on a composite test separation distance of 10mm from the front, back and edges of the device containing transmitting antennas within 2.5cm of their edges, determined from general mixed use conditions for this type of devices. Since the hotspot SAR results may overlap with the body-worn accessory SAR requirements, the more conservative configurations can be considered, thus excluding some body-worn accessory SAR tests.

When the user enables the personal wireless router functions for the handset, actual operations include simultaneous transmission of both the WLAN transmitter and another licensed transmitter. Both transmitters often do not transmit at the same transmitting frequency and thus cannot be evaluated for SAR under actual use conditions due to the limitations of the SAR assessment probes. Therefore, SAR must be evaluated for each frequency transmission and mode separately and spatially summed with the WLAN transmitter according to FCC KDB Publication 447498 D01 publication procedures. The —Portable Hotspot || feature on the handset was NOT activated during SAR assessments, to ensure the SAR measurements were evaluated for a single transmission frequency RF signal at a time.

8. RF Output Power

8.1. GSM Conducted Power

Mode	Txslot	Measured Power (dBm)			Tune-Up	Calculation (dB)	Frame-Averaged Power (dBm)		
		824.2 MHz	836.4 MHz	848.8 MHz			824.2 MHz	836.4 MHz	848.8 MHz
GSM850	/	32.76	32.86	32.82	32±1	/	/	/	/
GPRS 850 (GMSK)	1 Txslot	32.75	32.80	32.74	32±1	-9.03	23.72	23.77	23.71
	2 Txslot	32.00	32.08	32.02	32±1	-6.02	25.98	26.06	26.00
	3 Txslot	30.23	30.32	30.30	30±1	-4.26	25.97	26.06	26.04
	4 Txslot	29.05	29.19	29.16	29±1	-3.01	26.04	26.18	26.15
GPRS 850 (EDGE)	1 Txslot	27.48	27.26	27.18	27±1	-9.03	18.45	18.23	18.15
	2 Txslot	26.07	26.05	25.92	26±1	-6.02	20.05	20.03	19.90
	3 Txslot	24.24	23.95	23.68	24±1	-4.26	19.98	19.69	19.42
	4 Txslot	22.58	22.27	22.11	22±1	-3.01	19.57	19.26	19.10
Mode	Txslot	Measured Power (dBm)			Tune-Up	Calculation (dB)	Frame-Averaged Power (dBm)		
		1850.2 MHz	1880 MHz	1909.8 MHz			1850.2 MHz	1880 MHz	1909.8 MHz
DCS1900	/	30.63	30.11	30.02	30±1	/	/	/	/
GPRS 1900 (GMSK)	1 Txslot	30.64	30.09	30.00	30±1	-9.03	21.61	21.06	20.97
	2 Txslot	29.72	29.20	29.14	29±1	-6.02	23.70	23.18	23.12
	3 Txslot	27.67	27.20	27.21	27±1	-4.26	23.41	22.94	22.95
	4 Txslot	26.62	26.20	26.16	26±1	-3.01	23.61	23.19	23.15
GPRS 1900 (EDGE)	1 Txslot	27.07	27.56	26.21	27±1	-9.03	18.04	18.53	17.18
	2 Txslot	25.75	25.65	25.08	25±1	-6.02	19.73	19.63	19.06
	3 Txslot	23.95	23.54	23.14	23±1	-4.26	19.69	19.28	18.88
	4 Txslot	22.62	23.25	21.90	23±1	-3.01	19.61	20.24	18.89

Note:

Remark: GPRS, CS4 coding scheme. EGPRS, MCS5 coding scheme.

Multi-Slot Class 8, Support Max 4 downlink, 1 uplink, 5 working link

Multi-Slot Class 10, Support Max 4 downlink, 2 uplink, 5 working link

Multi-Slot Class 12, Support Max 4 downlink, 4 uplink, 5 working link

SAR testing was performed on the maximum frame-averaged power mode.

The frame-averaged power is linearly proportion to the slot number configured and it is linearly scaled the maximum

Burst-averaged power based on time slots. The calculated method is shown as below:

Frame-averaged power = Burst averaged power (1 TX Slot) – 9.03 dB

Frame-averaged power = Burst averaged power (2 TX Slots) – 6.02 dB

Frame-averaged power = Burst averaged power (3 TX Slots) - 4.26 dB

Frame-averaged power = Burst averaged power (4 TX Slots) – 3.01 dB

8.2. WCDMA Conducted Power

The following tests were conducted according to the test requirements outlines in 3GPP TS 34.121 specification. A summary of these settings are illustrated below:

1. Release99 Setup Configuration

Mode	Subtest	Rel99
WCDMA General Settings	Loopback Mode	Test Mode 1
	Rel99 RMC	12.2kbps RMC
	Power Control Algorithm	Algorithm1
	β_c/β_d	8/15

2. HSDPA Setup Configuration

	Mode	HSDPA	HSDPA	HSDPA	HSDPA
	Subtest	1	2	3	4
WCDMA General Settings	Loopback Mode	Test Mode 1			
	Rel99 RMC	12.2kbps RMC			
	HSDPA FRC	H-Set1			
	Power Control Algorithm	Algorithm 2			
	β_c	2/15	12/15	15/15	15/15
	β_d	15/15	15/15	8/15	4/15
	Bd (SF)	64			
	β_c/β_d	2/15	12/15	15/8	15/4
HSDPA Specific Settings	β_{hs}	4/15	24/15	30/15	30/15
	D_{ACK}	8			
	D_{NAK}	8			
	DCQI	8			
	Ack-Nack repetition factor	3			
	CQI Feedback (Table 5.2B.4)	4ms			
	CQI Repetition Factor (Table 5.2B.4)	2			
	$A_{hs} = \beta_{hs}/\beta_c$	30/15			

3. HSUPA Setup Configuration

	Mode	HSUPA	HSUPA	HSUPA	HSUPA	HSUPA
	Subtest	1	2	3	4	5
WCDMA General Settings	Loopback Mode	Test Mode 1				
	Rel99 RMC	12.2kbps RMC				
	HSDPA FRC	H-Set1				
	HSUPA Test	HSUPA Loopback				
	Power Control Algorithm	Algorithm1				
	β_c	11/15	6/15	15/15	2/15	15/15
	β_d	15/15	15/15	9/15	15/15	15/15
	β_{ec}	209/225	12/15	30/15	2/15	24/15
	β_c/β_d	11/15	6/15	15/9	2/15	15/15
	β_{hs}	22/15	12/15	30/15	4/15	30/15
	β_{ed}	1309/225	94/75	47/15 47/15	56/75	134/15
CM (dB)	1.0	3.0	2.0	3.0	1.0	
HSDPA Specific Settings	D_{ACK}	8				
	D_{NAK}	8				
	DCQI	8				
	Ack-Nack repetition factor	3				
	CQI Feedback (Table 5.2B.4)	4ms				

	CQI Repetition Factor (Table 5.2B.4)	2				
	Ahs = β_{hs}/β_c	30/15				
HSUPA Specific Settings	D E-DPCCH	6	8	8	5	7
	DHARQ	0	0	0	0	0
	AG Index	20	12	15	17	21
	ETFCI (from 34.121 Table C.11.1.3)	75	67	92	71	81
	Associated Max UL Data Rate kbps	242.1	174.9	482.8	205.8	308.9

4. WCDMA Conducted Power Results

Choose the highest output power mode RMC 12.2Kbps for Band VIII/I at middle channel to test SAR and determine the worst configuration for further high/low channel test.

Band	WCDMA Band II			Tune-Up	WCDMA Band V			Tune-Up	
	Channel	9262	9400		9538	4132	4182		4233
	Frequency (MHz)	1852.4	1880	1907.6		826.4	836.4	846.6	
	RMC 12.2Kbps	24.28	24.51	24.72	24±1	24.19	24.13	24.25	24±1
	HSDPA Subtest-1	22.27	22.45	22.65	22±1	22.14	22.14	22.26	22±1
	HSDPA Subtest-2	22.29	22.48	22.67	22±1	22.15	22.13	22.23	22±1
	HSDPA Subtest-3	22.27	22.46	22.67	22±1	22.15	22.13	22.24	22±1
	HSDPA Subtest-4	22.28	22.48	22.66	22±1	22.13	22.16	22.24	22±1
	HSUPA Subtest-1	19.53	19.75	19.94	19±1	19.36	19.14	19.76	19±1
	HSUPA Subtest-2	19.77	19.68	20.18	20±1	19.65	19.67	19.43	19±1
	HSUPA Subtest-3	19.78	20.01	20.16	20±1	19.70	19.66	19.74	19±1
	HSUPA Subtest-4	19.84	19.74	20.17	20±1	19.38	19.15	19.20	19±1
	HSUPA Subtest-5	20.59	20.45	20.90	20±1	19.55	19.53	19.62	19±1

8.3. LTE Conducted Power

1. The following tests were conducted according to the test requirements outlines in 3GPP TS 36.521-1 specification. A summary of these configurations are illustrated below:

Test Parameters for Channel Bandwidths				
Ch BW	Downlink Configuration	Uplink Configuration		
		Mod'n	RB allocation	
	N/A for Max UE output power testing		FDD	TDD
1.4MHz		QPSK	1	1
1.4MHz		QPSK	5	5
3MHz		QPSK	1	1
3MHz		QPSK	4	4
5MHz		QPSK	1	1
5MHz		QPSK	8	8
10MHz		QPSK	1	1
10MHz		QPSK	12	12
15MHz		QPSK	1	1
15MHz		QPSK	16	16
20MHz		QPSK	1	1
20MHz		QPSK	18	18

Note 1: Test Channel Bandwidths are checked separately for each E-UTRA band, the applicable channel bandwidths are specified in Table 5.4.2.1-1.

Note 2: For E-UTRA bands not applied with Note 2 in Table 6.2.2.3-1:

- The 1 RB allocation shall be tested at RB#0 for low and mid range, RB #max for high range test frequency.
- The RBstart of non-1RB allocation shall be RB #0 for low and mid range, RB# (max +1 - RB allocation) for high range test frequency.

Note 3: For E-UTRA bands applied with Note 2 in Table 6.2.2.3-1:

- If the test channel bandwidth is larger than 4MHz, then the 1 RB allocation shall be tested at both RB #0 and RB #max.
- If the test channel bandwidth is smaller or equal to 4MHz, then the 1 RB allocation shall be tested at RB #0.
- If the test channel bandwidth = (FUL_high - FUL_low) specified by the operating band, then only one frequency range shall be tested and the 1 RB allocation shall be tested at RB #0, RB # $\lceil N_{RB}^{UL} / 2 \rceil$ and RB #max.
- For non-1RB allocation, test frequency is middle range, and the RBstart shall be RB #0.

2. LTE Conducted Power Results

LTE output list

Band	Band Width	Modulation	RB Configuration		Tune-up (dBm)	Channel/Frequency(MHz)		
			RB Size	RB Offset		18607/1850.7	18900/1880	19193/1909.3
LTE Band 2	1.4MHz	QPSK	1	0	24.00	23.85	23.59	23.85
			1	2	24.00	23.81	23.61	23.85
			1	5	24.00	23.91	23.61	23.87
			3	0	24.00	23.84	23.76	23.93
			3	1	24.00	23.92	23.69	23.85
			3	2	24.00	23.84	23.63	23.91
			6	0	23.00	22.87	22.69	22.84
		16QAM	1	0	23.00	22.37	22.98	22.92
			1	2	23.00	22.38	23.00	22.89
			1	5	23.00	22.32	22.96	22.91
			3	0	23.00	22.76	22.90	22.77
			3	1	23.00	22.78	22.90	22.78
			3	2	23.00	22.73	22.86	22.77
			6	0	22.00	21.95	21.71	21.97
Band	Band Width	Modulation	RB Configuration		Tune-up (dBm)	Channel/Frequency(MHz)		
RB Size	RB Offset	18615/1851.5	18900/1880	19185/1908.5				
LTE Band 2	3MHz	QPSK	1	0	24.00	23.88	23.70	23.98
			1	7	24.00	23.84	23.70	24.00
			1	14	24.00	23.89	23.67	23.92
			8	0	23.00	22.89	22.66	22.91
			8	4	23.00	22.95	22.59	22.88
			8	7	23.00	22.93	22.72	22.91
			15	0	23.00	22.94	22.69	22.85
		16QAM	1	0	23.50	23.40	22.40	23.10
			1	7	23.50	23.38	22.39	23.12
			1	14	23.50	23.34	22.44	23.08
			8	0	22.50	22.27	21.89	22.04
			8	4	22.50	22.32	21.93	22.06
			8	7	22.50	22.32	21.93	22.04
			15	0	22.50	22.12	21.84	22.01
Band	Band Width	Modulation	RB Configuration		Tune-up (dBm)	Channel/Frequency(MHz)		
RB Size	RB Offset	18625/1852.5	18900/1880	19175/1907.5				
LTE Band 2	5MHz	QPSK	1	0	24.50	23.87	23.67	24.04
			1	12	24.50	23.79	23.55	24.02
			1	24	24.50	23.76	23.54	24.04
			12	0	23.00	22.92	22.67	22.95
			12	6	23.00	22.84	22.66	22.83
			12	11	23.00	22.86	22.70	22.95
			25	0	23.00	22.85	22.70	22.88
		16QAM	1	0	23.00	22.06	22.79	22.94
			1	12	23.00	21.91	22.82	22.89
			1	24	23.00	21.97	22.86	22.88
			12	0	22.00	21.99	21.76	21.88

Band	Band Width	Modulation	RB Configuration		Tune-up (dBm)	Channel/Frequency(MHz)		
			RB Size	RB Offset		18650/1855	18900/1880	19150/1905
			12	6	22.00	21.97	21.71	21.85
			12	11	22.00	21.97	21.77	21.82
			25	0	22.50	22.04	21.79	21.87
LTE Band 2	10MHz	QPSK	1	0	24.00	23.76	23.60	23.81
			1	24	24.00	23.73	23.63	23.80
			1	49	24.00	23.81	23.65	23.80
			25	0	23.00	22.82	22.73	22.94
			25	12	23.00	22.83	22.65	22.83
			25	24	23.00	22.83	22.73	22.89
		16QAM	1	0	24.00	23.13	22.54	23.63
			1	24	24.00	23.11	22.54	23.62
			1	49	24.00	23.07	22.55	23.62
			25	0	22.50	21.98	21.89	21.98
			25	12	22.50	21.92	21.92	22.03
			25	24	22.50	21.95	21.94	21.97
			50	0	22.50	21.99	21.77	22.01
			50	0	22.50	21.99	21.77	22.01
Band	Band Width	Modulation	RB Configuration		Tune-up (dBm)	Channel/Frequency(MHz)		
			RB Size	RB Offset		18675/1857.5	18900/1880	19125/1902.5
LTE Band 2	15MHz	QPSK	1	0	24.00	23.74	23.59	23.92
			1	37	24.00	23.72	23.52	23.87
			1	74	24.00	23.73	23.61	23.85
			36	0	23.00	22.92	22.70	22.87
			36	18	23.00	22.84	22.74	22.83
			36	37	23.00	22.86	22.72	22.93
		16QAM	75	0	23.00	22.73	22.72	22.89
			1	0	24.00	23.14	23.01	23.66
			1	37	24.00	23.03	23.01	23.64
			1	74	24.00	23.05	23.06	23.64
			36	0	22.50	22.05	21.72	21.96
			36	18	22.50	22.00	21.79	21.97
			36	37	22.50	22.06	21.87	21.99
			75	0	22.50	21.92	21.70	22.03
Band	Band Width	Modulation	RB Configuration		Tune-up (dBm)	Channel/Frequency(MHz)		
			RB Size	RB Offset		18700/1860	18900/1880	19100/1900
LTE Band 2	20MHz	QPSK	1	0	24.50	23.82	23.64	23.93
			1	49	24.50	23.81	23.69	24.11
			1	99	24.50	23.74	23.83	24.08
			50	0	23.00	22.85	22.71	22.92
			50	24	23.00	22.84	22.79	22.91
			50	49	23.00	22.74	22.80	22.91
		16QAM	100	0	23.00	22.83	22.65	22.83
			1	0	24.00	23.01	23.43	22.87
			1	49	24.00	22.94	23.42	22.98
			1	99	24.00	22.91	23.70	22.99
50	0	22.00	21.99	21.73	21.88			

			50	24	22.00	21.91	21.77	21.93
			50	49	22.00	21.96	21.76	21.99
			100	0	22.00	21.97	21.81	21.89

Band	Band Width	Modulation	RB Configuration		Tune-up (dBm)	Channel/Frequency(MHz)		
			RB Size	RB Offset		19957/1710.7	20175/1732.5	20393/1754.3
LTE Band 4	1.4MHz	QPSK	1	0	23.50	23.03	22.95	22.58
			1	2	23.50	23.03	22.98	22.63
			1	5	23.50	23.03	22.94	22.66
			3	0	23.50	23.08	22.89	22.60
			3	1	23.50	23.01	22.82	22.52
			3	2	23.50	23.05	22.92	22.56
			6	0	22.50	22.11	21.91	21.48
		16QAM	1	0	23.00	22.03	22.54	22.28
			1	2	23.00	22.01	22.62	22.26
			1	5	23.00	22.05	22.59	22.28
			3	0	22.50	21.98	22.05	21.19
			3	1	22.50	21.92	22.03	21.24
			3	2	22.50	21.96	22.06	21.22
			6	0	21.50	21.17	21.10	20.76
Band	Band Width	Modulation	RB Configuration		Tune-up (dBm)	Channel/Frequency(MHz)		
			RB Size	RB Offset		19965/1711.5	20175/1732.5	20385/1753.5
LTE Band 4	3MHz	QPSK	1	0	23.00	22.96	22.94	22.40
			1	7	23.00	22.94	22.87	22.42
			1	14	23.00	22.90	22.91	22.61
			8	0	22.50	22.05	21.90	21.51
			8	4	22.50	22.10	21.80	21.52
			8	7	22.50	21.95	21.80	21.59
			15	0	22.50	22.06	21.90	21.50
		16QAM	1	0	23.00	22.78	21.86	22.33
			1	7	23.00	22.84	21.85	22.28
			1	14	23.00	22.72	21.92	22.33
			8	0	21.50	21.32	21.09	20.70
			8	4	21.50	21.32	21.09	20.71
			8	7	21.50	21.26	21.10	20.74
			15	0	21.50	21.27	21.00	20.62
Band	Band Width	Modulation	RB Configuration		Tune-up (dBm)	Channel/Frequency(MHz)		
			RB Size	RB Offset		19975/1712.5	20175/1732.5	20375/1752.5
LTE Band 4	5MHz	QPSK	1	0	23.00	22.99	22.96	22.60
			1	12	23.00	22.94	22.71	22.53
			1	24	23.00	22.86	22.68	22.57
			12	0	22.50	22.08	21.93	21.56
			12	6	22.50	22.03	21.76	21.56
			12	11	22.50	22.06	21.79	21.49
			25	0	22.00	22.00	21.84	21.54
		16QAM	1	0	22.50	21.62	22.49	21.73
			1	12	22.50	21.56	22.48	21.79
			1	24	22.50	21.54	22.47	21.83

Band	Band Width	Modulation	RB Configuration		Tune-up (dBm)	Channel/Frequency(MHz)		
			RB Size	RB Offset		20000/1715	20175/1732.5	20350/1750
			12	0	21.50	21.19	20.91	20.43
			12	6	21.50	21.03	20.91	20.45
			12	11	21.50	21.06	20.92	20.43
			25	0	21.50	21.16	21.00	20.42
LTE Band 4	10MHz	QPSK	1	0	23.50	23.03	22.85	22.58
			1	24	23.50	22.98	22.76	22.53
			1	49	23.50	22.99	22.76	22.60
			25	0	22.50	22.02	21.92	21.45
			25	12	22.50	22.03	21.80	21.57
			25	24	22.50	22.03	21.84	21.53
			50	0	22.50	22.07	21.87	21.49
		16QAM	1	0	23.50	23.13	22.23	23.09
			1	24	23.50	23.03	22.17	23.04
			1	49	23.50	23.03	22.09	23.09
			25	0	21.50	21.09	21.09	20.65
			25	12	21.50	21.10	21.12	20.62
			25	24	21.50	21.17	21.06	20.66
			50	0	21.50	21.13	20.95	20.61
Band	Band Width	Modulation	RB Configuration		Tune-up (dBm)	Channel/Frequency(MHz)		
			RB Size	RB Offset		20025/1717.5	20175/1732.5	20325/1747.5
LTE Band 4	15MHz	QPSK	1	0	23.50	23.01	22.75	22.64
			1	37	23.50	22.97	22.71	22.56
			1	74	23.50	22.98	22.48	22.55
			36	0	22.50	21.94	21.85	21.60
			36	18	22.50	22.02	21.91	21.56
			36	37	22.50	21.98	21.83	21.57
			75	0	22.50	22.04	21.82	21.52
		16QAM	1	0	23.50	22.77	22.61	23.11
			1	37	23.50	22.77	22.55	23.09
			1	74	23.50	22.74	22.36	22.94
			36	0	21.50	21.23	21.04	20.72
			36	18	21.50	21.19	20.94	20.66
			36	37	21.50	21.12	20.80	20.54
			75	0	21.50	21.17	20.95	20.64
Band	Band Width	Modulation	RB Configuration		Tune-up (dBm)	Channel/Frequency(MHz)		
			RB Size	RB Offset		20050/1720	20175/1732.5	20300/1745
LTE Band 4	20MHz	QPSK	1	0	23.50	23.09	23.02	23.00
			1	49	23.50	23.04	22.85	22.89
			1	99	23.50	23.01	22.62	22.78
			50	0	22.50	22.01	21.94	21.58
			50	24	22.50	22.00	21.82	21.67
			50	49	22.50	21.91	21.72	21.57
			100	0	22.00	21.95	21.80	21.71
		16QAM	1	0	23.50	22.52	23.43	22.24
			1	49	23.50	22.47	23.24	22.11
			1	99	23.50	22.38	23.03	22.02

			50	0	21.50	21.13	20.97	20.74
			50	24	21.50	21.18	20.89	20.67
			50	49	21.50	21.11	20.77	20.49
			100	0	21.50	21.08	21.03	20.71

Band	Band Width	Modulation	RB Configuration		Tune-up (dBm)	Channel/Frequency(MHz)		
			RB Size	RB Offset		20407/824.7	20525/836.5	20643/848.3
LTE Band 5	1.4MHz	QPSK	1	0	23.50	23.40	23.33	22.99
			1	2	23.50	23.42	23.30	22.98
			1	5	23.50	23.34	23.34	22.90
			3	0	23.50	23.45	23.26	23.12
			3	1	23.50	23.30	23.34	23.12
			3	2	23.50	23.34	23.32	23.00
		16QAM	1	0	23.00	22.44	22.93	22.61
			1	2	23.00	22.40	22.92	22.59
			1	5	23.00	22.41	22.96	22.57
			3	0	22.50	22.25	22.30	21.83
			3	1	22.50	22.29	22.30	21.87
			3	2	22.50	22.17	22.39	21.83
			6	0	21.50	21.47	21.47	21.20
Band	Band Width	Modulation	RB Configuration		Tune-up (dBm)	Channel/Frequency(MHz)		
			RB Size	RB Offset		20415/825.5	20525/836.5	20635/847.5
LTE Band 5	3MHz	QPSK	1	0	23.50	23.35	23.36	23.13
			1	7	23.50	23.31	23.29	23.11
			1	14	23.50	23.37	23.25	23.14
			8	0	22.50	22.41	22.30	21.95
			8	4	22.50	22.44	22.24	21.94
			8	7	22.50	22.39	22.33	21.97
			15	0	22.50	22.46	22.26	22.08
		16QAM	1	0	23.50	23.32	22.33	22.97
			1	7	23.50	23.24	22.30	22.97
			1	14	23.50	23.24	22.31	22.94
			8	0	22.00	21.71	21.47	21.12
			8	4	22.00	21.72	21.48	21.10
			8	7	22.00	21.72	21.50	21.16
			15	0	22.00	21.52	21.43	21.04
Band	Band Width	Modulation	RB Configuration		Tune-up (dBm)	Channel/Frequency(MHz)		
			RB Size	RB Offset		20425/826.5	20525/836.5	20625/846.5
LTE Band 5	5MHz	QPSK	1	0	23.50	23.35	23.32	23.17
			1	12	23.50	23.23	23.11	23.06
			1	24	23.50	23.30	23.10	23.03
			12	0	22.50	22.35	22.32	21.96
			12	6	22.50	22.28	22.26	21.92
			12	11	22.50	22.37	22.35	21.94
			25	0	22.50	22.45	22.25	22.06
		16QAM	1	0	23.00	22.04	22.86	22.54
			1	12	23.00	22.03	22.82	22.51
			1	24	23.00	22.05	22.87	22.44

Band	Band Width	Modulation	RB Configuration		Tune-up (dBm)	Channel/Frequency(MHz)		
			RB Size	RB Offset		20450/829	20525/836.5	20600/844
LTE Band 5	10MHz	QPSK	12	0	21.50	21.40	21.24	20.97
			12	6	21.50	21.40	21.35	20.94
			12	11	21.50	21.36	21.32	20.90
			25	0	21.50	21.46	21.37	20.98
			1	0	23.50	23.36	23.36	23.11
			1	24	23.50	23.39	23.19	22.98
		16QAM	1	49	23.50	23.40	23.05	22.93
			25	0	22.50	22.35	22.35	22.11
			25	12	22.50	22.29	22.21	22.01
			25	24	22.50	22.38	22.17	21.94
			50	0	22.50	22.20	22.37	22.02
			1	0	23.50	23.39	22.71	23.40
			1	24	23.50	23.26	22.56	23.32
			1	49	23.50	23.26	22.49	23.16
			25	0	21.50	21.41	21.37	21.28
			25	12	21.50	21.32	21.46	21.09
25	24	21.50	21.40	21.42	21.02			
50	0	21.50	21.34	21.37	21.10			

Band	Band Width	Modulation	RB Configuration		Tune-up (dBm)	Channel/Frequency(MHz)		
			RB Size	RB Offset		20775/2502.5	21100/2535	21425/2567.5
LTE Band 7	5MHz	QPSK	1	0	22.00	21.26	21.46	21.09
			1	12	22.00	21.27	21.41	21.05
			1	24	22.00	21.50	21.44	21.14
			12	0	21.00	20.53	20.49	20.04
			12	6	21.00	20.38	20.43	20.03
			12	11	21.00	20.53	20.39	20.18
		16QAM	25	0	20.50	20.49	20.46	20.15
			1	0	21.50	21.11	20.98	19.83
			1	12	21.50	21.08	20.89	19.78
			1	24	21.50	21.15	20.95	19.83
			12	0	20.00	19.58	19.53	19.13
			12	6	20.00	19.57	19.55	19.15
			12	11	20.00	19.57	19.69	19.11
			25	0	20.00	19.65	19.62	19.21

Band	Band Width	Modulation	RB Configuration		Tune-up (dBm)	Channel/Frequency(MHz)		
			RB Size	RB Offset		20800/2505	21100/2535	21400/2565
LTE Band 7	10MHz	QPSK	1	0	21.50	21.40	21.44	21.20
			1	24	21.50	21.42	21.42	21.22
			1	49	21.50	21.42	21.44	21.19
			25	0	21.00	20.58	20.51	20.12
			25	12	21.00	20.54	20.52	20.10
			25	24	21.00	20.42	20.58	20.12
		16QAM	50	0	21.00	20.54	20.55	20.12
			1	0	21.50	21.42	20.47	20.79
			1	24	21.50	21.45	20.45	20.78
			1	49	21.50	21.47	20.42	20.78

Band	Band Width	Modulation	RB Configuration		Tune-up (dBm)	Channel/Frequency(MHz)		
			RB Size	RB Offset		20825/2507.5	21100/2535	21375/2562.5
			25	0	20.00	19.63	19.73	19.35
			25	12	20.00	19.64	19.70	19.36
			25	24	20.00	19.72	19.73	19.27
			50	0	20.00	19.62	19.56	19.38
LTE Band 7	15MHz	QPSK	1	0	21.50	21.28	21.37	21.19
			1	37	21.50	21.34	21.36	21.21
			1	74	21.50	21.37	21.42	21.13
			36	0	21.00	20.49	20.56	20.18
			36	18	21.00	20.49	20.47	20.22
			36	37	21.00	20.50	20.37	20.12
			75	0	21.00	20.56	20.50	20.24
		16QAM	1	0	21.50	21.38	21.38	20.95
			1	37	21.50	21.37	21.43	20.91
			1	74	21.50	21.39	21.35	21.46
			36	0	20.00	19.60	19.57	19.24
			36	18	20.00	19.62	19.55	19.24
			36	37	20.00	19.74	19.55	19.24
			75	0	20.00	19.51	19.59	19.28
			RB Configuration		Tune-up (dBm)	Channel/Frequency(MHz)		
			RB Size	RB Offset		20850/2510	21100/2535	21350/2560
LTE Band 7	20MHz	QPSK	1	0	21.50	21.30	21.39	21.42
			1	49	21.50	21.33	21.45	21.44
			1	99	21.50	21.39	21.42	21.36
			50	0	21.00	20.37	20.42	20.31
			50	24	21.00	20.48	20.54	20.24
			50	49	21.00	20.54	20.42	20.22
			100	0	20.50	20.37	20.44	20.30
		16QAM	1	0	22.00	20.79	21.81	21.04
			1	49	22.00	20.90	21.82	21.05
			1	99	22.00	21.01	21.78	20.98
			50	0	20.00	19.64	19.58	19.33
			50	24	20.00	19.67	19.53	19.41
			50	49	20.00	19.67	19.54	19.34
			100	0	20.00	19.54	19.63	19.26

Band	Band Width	Modulation	RB Configuration		Tune-up (dBm)	Channel/Frequency(MHz)		
			RB Size	RB Offset		23017/699.7	23095/707.5	23173/715.3
LTE Band 12	1.4MHz	QPSK	1	0	24.50	23.96	23.70	23.60
			1	2	24.50	24.00	23.75	23.60
			1	5	24.50	24.05	23.71	23.58
			3	0	24.00	23.98	23.80	23.58
			3	1	24.00	23.99	23.79	23.52
			3	2	24.00	23.92	23.81	23.59
			6	0	23.00	22.94	22.64	22.53
		16QAM	1	0	23.50	23.12	22.70	22.11
			1	2	23.50	23.13	22.83	22.08
			1	5	23.50	23.18	22.81	22.01

Band	Band Width	Modulation	RB Configuration		Tune-up (dBm)	Channel/Frequency(MHz)		
			RB Size	RB Offset		23025/700.5	23095/707.5	23165/714.5
			3	0	23.50	23.04	22.53	22.17
			3	1	23.50	22.99	22.57	22.18
			3	2	23.50	22.97	22.47	22.30
			6	0	22.50	22.23	21.72	21.65
LTE Band 12	3MHz	QPSK	1	0	24.00	23.87	23.71	23.70
			1	7	24.00	23.77	23.78	23.58
			1	14	24.00	23.87	23.70	23.60
			8	0	23.50	23.04	22.69	22.51
			8	4	23.50	22.95	22.69	22.51
			8	7	23.50	22.95	22.57	22.59
		16QAM	15	0	23.00	22.93	22.63	22.49
			1	0	23.50	23.05	22.22	23.42
			1	7	23.50	22.98	22.27	23.45
			1	14	23.50	22.99	22.09	23.45
			8	0	22.50	22.12	21.80	21.65
			8	4	22.50	22.08	21.86	21.63
			8	7	22.50	22.18	21.84	21.70
			15	0	22.00	21.98	21.75	21.60
Band	Band Width	Modulation	RB Configuration		Tune-up (dBm)	Channel/Frequency(MHz)		
			RB Size	RB Offset		23035/701.5	23095/707.5	23155/713.5
LTE Band 12	5MHz	QPSK	1	0	24.00	23.87	23.63	23.72
			1	12	24.00	23.80	23.59	23.63
			1	24	24.00	23.70	23.64	23.59
			12	0	23.00	22.84	22.80	22.66
			12	6	23.00	22.81	22.69	22.48
			12	11	23.00	22.91	22.57	22.50
		16QAM	25	0	23.00	22.84	22.78	22.60
			1	0	23.00	22.11	22.87	22.52
			1	12	23.00	22.04	22.71	22.45
			1	24	23.00	21.89	22.71	22.47
			12	0	22.00	21.91	21.68	21.44
			12	6	22.00	21.86	21.72	21.41
			12	11	22.00	21.81	21.64	21.42
			25	0	22.50	22.02	21.74	21.48
Band	Band Width	Modulation	RB Configuration		Tune-up (dBm)	Channel/Frequency(MHz)		
			RB Size	RB Offset		23060/704	23095/707.5	23130/711
LTE Band 12	10MHz	QPSK	1	0	24.00	23.88	23.84	23.76
			1	24	24.00	23.75	23.71	23.59
			1	49	24.00	23.64	23.61	23.68
			25	0	23.00	22.79	22.89	22.61
			25	12	23.00	22.72	22.69	22.55
			25	24	23.00	22.80	22.80	22.62
			50	0	23.00	22.79	22.66	22.69
		16QAM	1	0	23.50	23.27	22.53	22.74
			1	24	23.50	23.15	22.32	22.74
			1	49	23.50	23.10	22.12	22.68
			25	0	22.00	21.91	21.93	21.79
			25	12	22.00	21.72	21.82	21.75

			25	24	22.00	21.78	21.84	21.72
			50	0	22.00	21.74	21.75	21.78

Band	Band Width	Modulation	RB Configuration		Tune-up (dBm)	Channel/Frequency(MHz)		
			RB Size	RB Offset		23755/706.5	23790/710	23825/713.5
LTE Band 17	5MHz	QPSK	1	0	24.00	23.79	23.72	23.59
			1	12	24.00	23.57	23.68	23.50
			1	24	24.00	23.56	23.68	23.45
			12	0	23.00	22.79	22.69	22.54
			12	6	23.00	22.85	22.75	22.49
			12	11	23.00	22.69	22.67	22.39
			25	0	23.00	22.77	22.58	22.59
		16QAM	1	0	23.00	22.70	22.45	21.75
			1	12	23.00	22.74	22.37	21.69
			1	24	23.00	22.35	22.39	21.66
			12	0	22.00	21.81	21.50	21.55
			12	6	22.00	21.73	21.55	21.49
			12	11	22.00	21.74	21.58	21.53
			25	0	22.00	21.72	21.51	21.65

Band	Band Width	Modulation	RB Configuration		Tune-up (dBm)	Channel/Frequency(MHz)		
			RB Size	RB Offset		23780/709	23790/710	23800/711
LTE Band 17	10MHz	QPSK	1	0	24.00	23.68	23.60	23.76
			1	24	24.00	23.61	23.54	23.58
			1	49	24.00	23.63	23.51	23.59
			25	0	23.00	22.65	22.67	22.60
			25	12	23.00	22.70	22.74	22.55
			25	24	23.00	22.66	22.69	22.61
			50	0	23.00	22.54	22.76	22.68
		16QAM	1	0	23.50	22.72	22.38	23.45
			1	24	23.50	22.68	22.32	23.30
			1	49	23.50	22.72	22.22	23.28
			25	0	22.00	21.74	21.90	21.75
			25	12	22.00	21.58	21.77	21.60
			25	24	22.00	21.66	21.86	21.70
			50	0	22.00	21.61	21.71	21.62

Band	Band Width	Modulation	RB Configuration		Tune-up (dBm)	Channel/Frequency(MHz)		
			RB Size	RB Offset		26697/814.7	26740/819	26783/823.3
LTE Band 26a	1.4MHz	QPSK	1	0	24.00	23.69	23.55	22.87
			1	2	24.00	23.64	23.49	22.84
			1	5	24.00	22.03	23.53	23.45
			3	0	23.00	21.96	22.60	22.53
			3	1	23.00	21.95	22.07	22.56
			3	2	23.00	21.12	22.59	21.94
			6	0	21.50	21.11	21.04	20.85
		16QAM	1	0	23.00	21.03	22.57	21.98
			1	2	23.00	21.03	22.52	22.01
			1	5	23.00	21.11	22.37	22.40
			3	0	22.50	21.01	21.81	22.06

Band	Band Width	Modulation	RB Configuration		Tune-up (dBm)	Channel/Frequency(MHz)		
			RB Size	RB Offset		26705/818.5	26740/819	26775/822.5
			3	1	22.50	21.06	21.97	20.92
			3	2	22.50	22.05	21.60	21.87
			6	0	21.50	21.21	21.20	20.95
LTE Band 26a	3MHz	QPSK	1	0	24.00	23.58	23.47	23.32
			1	7	24.00	23.65	23.50	23.45
			1	14	24.00	23.61	23.54	23.37
			8	0	21.50	21.09	21.00	20.87
			8	4	21.50	21.03	20.94	20.91
			8	7	21.50	21.06	20.93	20.83
		16QAM	15	0	21.50	20.95	21.05	20.90
			1	0	23.50	22.70	22.50	23.01
			1	7	23.50	23.26	23.12	22.37
			1	14	23.50	23.38	23.29	23.21
			8	0	21.50	21.27	21.11	21.07
			8	4	21.50	21.13	21.13	21.02
			8	7	21.50	21.10	20.97	21.20
			15	0	21.50	21.07	20.98	21.02
Band	Band Width	Modulation	RB Configuration		Tune-up (dBm)	Channel/Frequency(MHz)		
			RB Size	RB Offset		26715/816.5	26740/819	26765/821.5
LTE Band 26a	5MHz	QPSK	1	0	24.00	23.47	23.48	23.50
			1	12	24.00	23.49	23.38	23.38
			1	24	24.00	23.33	23.36	23.15
			12	0	21.50	21.10	20.96	20.96
			12	6	21.50	21.04	20.87	20.81
			12	11	21.50	20.91	20.98	20.91
		16QAM	25	0	21.00	20.96	20.84	20.85
			1	0	23.00	22.87	22.14	22.66
			1	12	23.00	22.68	22.93	21.96
			1	24	23.00	22.11	22.63	22.74
			12	0	21.00	20.96	20.94	20.94
			12	6	21.00	21.00	20.94	20.84
			12	11	21.00	20.93	20.95	20.96
			25	0	21.50	21.01	21.01	20.91
Band	Band Width	Modulation	RB Configuration		Tune-up (dBm)	Channel/Frequency(MHz)		
			RB Size	RB Offset		/	26740/819	/
LTE Band 26a	10MHz	QPSK	1	0	24.00	/	23.54	/
			1	24	24.00	/	23.33	/
			1	49	24.00	/	23.34	/
			25	0	22.00	/	21.58	/
			25	12	22.00	/	21.46	/
			25	24	22.00	/	21.43	/
			50	0	21.50	/	21.42	/
		16QAM	1	0	23.50	/	23.15	/
			1	24	23.50	/	22.99	/
			1	49	23.50	/	22.56	/
			25	0	22.00	/	21.58	/
			25	12	22.00	/	21.48	/
			25	24	22.00	/	21.63	/

			50	0	21.50	/	21.42	/
--	--	--	----	---	-------	---	-------	---

Band	Band Width	Modulation	RB Configuration		Tune-up (dBm)	Channel/Frequency(MHz)		
			RB Size	RB Offset		26797/824.7	26915/836.5	27033/848.3
LTE Band 26b	1.4MHz	QPSK	1	0	23.50	21.95	23.28	21.52
			1	2	23.50	21.87	23.19	21.51
			1	5	23.50	21.75	23.24	23.02
			3	0	23.00	21.82	22.72	22.53
			3	1	23.00	21.80	22.89	22.55
			3	2	23.00	21.79	22.75	21.47
		16QAM	1	0	23.00	21.86	22.89	21.45
			1	2	23.00	21.85	22.82	22.63
			1	5	23.00	21.80	22.96	22.07
			3	0	22.00	20.73	21.80	20.46
			3	1	22.00	21.77	21.56	21.52
			3	2	22.00	21.80	21.52	21.29
			6	0	21.00	20.89	20.83	20.46
Band	Band Width	Modulation	RB Configuration		Tune-up (dBm)	Channel/Frequency(MHz)		
			RB Size	RB Offset		26805/825.5	26915/836.5	27025/847.5
LTE Band 26b	3MHz	QPSK	1	0	23.50	23.48	23.24	23.15
			1	7	23.50	23.32	23.20	22.96
			1	14	23.50	23.46	23.31	23.04
			8	0	21.00	20.79	20.70	20.54
			8	4	21.00	20.80	20.81	20.50
			8	7	21.00	20.85	20.78	20.43
		16QAM	15	0	21.00	20.78	20.68	20.45
			1	0	23.00	22.99	22.92	22.81
			1	7	23.00	22.43	22.30	22.97
			1	14	23.00	22.95	22.85	22.00
			8	0	21.50	21.03	20.87	20.69
			8	4	21.50	20.98	20.92	20.57
			8	7	21.50	21.18	21.02	20.68
			15	0	21.00	20.94	20.87	20.57
Band	Band Width	Modulation	RB Configuration		Tune-up (dBm)	Channel/Frequency(MHz)		
			RB Size	RB Offset		26815/826.5	26915/836.5	27015/846.5
LTE Band 26b	5MHz	QPSK	1	0	23.50	23.35	23.38	23.01
			1	12	23.50	23.28	23.21	23.00
			1	24	23.50	23.38	23.04	22.95
			12	0	21.00	20.74	20.62	20.51
			12	6	21.00	20.78	20.75	20.52
			12	11	21.00	20.77	20.65	20.50
			25	0	21.00	20.86	20.76	20.47
		16QAM	1	0	23.00	22.04	22.47	22.47
			1	12	23.00	22.72	21.88	22.27
			1	24	23.00	22.55	22.66	21.53
			12	0	21.00	20.90	20.72	20.57
			12	6	21.00	20.84	20.70	20.57
			12	11	21.00	20.81	20.76	20.52

Band	Band Width	Modulation	RB Configuration		Tune-up (dBm)	Channel/Frequency(MHz)		
			RB Size	RB Offset		26840/829	26915/836.5	26990/844
			25	0		21.00	20.91	20.80
LTE Band 26b	10MHz	QPSK	1	0	23.50	23.39	23.19	23.07
			1	24	23.50	23.28	23.16	22.96
			1	49	23.50	23.30	22.98	22.86
			25	0	21.50	21.33	21.24	21.17
			25	12	21.50	21.29	21.18	21.07
			25	24	21.50	21.24	21.05	21.01
			50	0	21.50	21.21	21.26	21.09
		16QAM	1	0	23.50	23.03	22.60	23.33
			1	24	23.50	22.95	23.14	23.21
			1	49	23.50	23.37	23.31	23.20
			25	0	21.50	21.37	21.42	21.18
			25	12	21.50	21.32	21.24	21.09
			25	24	21.50	21.22	21.26	21.02
			50	0	21.50	21.27	21.26	21.03
Band	Band Width	Modulation	RB Configuration		Tune-up (dBm)	Channel/Frequency(MHz)		
			RB Size	RB Offset		26865/831.5	26915/836.5	26965/841.5
			1	0		23.50	23.38	23.17
LTE Band 26b	15MHz	QPSK	1	37	23.50	23.25	23.02	22.97
			1	74	23.50	23.18	22.86	23.03
			36	0	21.50	21.28	21.25	21.08
			36	18	21.50	21.20	21.28	21.12
			36	37	21.50	21.14	21.22	21.05
			75	0	21.50	21.18	21.26	21.17
			16QAM	1	0	23.50	23.26	23.01
		1		37	23.50	23.14	22.89	23.27
		1		74	23.50	23.18	22.81	23.19
		36		0	21.50	21.29	21.21	21.14
		36		18	21.50	21.23	21.26	21.13
		36		37	21.50	21.22	21.21	21.02
		75		0	21.50	21.18	21.36	21.19

Band	Band Width	Modulation	RB Configuration		Tune-up (dBm)	Channel/Frequency(MHz)		
			RB Size	RB Offset		39675/2498.5	40620/2593	41565/2687.5
			1	0		22.50	21.41	21.09
LTE Band 41	5MHz	QPSK	1	12	22.50	21.76	20.92	22.06
			1	24	22.50	21.71	20.82	21.77
			12	0	21.00	20.75	20.30	21.00
			12	6	21.00	20.71	20.09	20.77
			12	11	21.00	20.85	20.10	20.83
			25	0	21.50	20.79	20.25	21.01
			16QAM	1	0	22.00	21.30	20.95
		1		12	22.00	21.34	21.15	21.34
		1		24	22.00	21.10	21.59	21.45
		12		0	20.00	19.84	19.04	19.94
		12		6	20.00	19.79	19.09	19.99
		12		11	20.00	19.67	19.02	19.80

Band	Band Width	Modulation	RB Configuration		Tune-up (dBm)	Channel/Frequency(MHz)		
			RB Size	RB Offset		39700/2501	40620/2593	41540/2685
			25	0		20.50	19.77	19.44
LTE Band 41	10MHz	QPSK	1	0	22.00	21.79	21.17	21.64
			1	24	22.00	21.72	21.08	21.75
			1	49	22.00	21.64	20.86	21.73
			25	0	21.50	20.82	20.07	20.93
			25	12	21.50	20.84	20.30	21.01
			25	24	21.50	20.69	20.08	20.99
			50	0	21.00	20.72	20.27	20.97
		16QAM	1	0	22.50	21.26	20.86	22.07
			1	24	22.50	21.04	20.96	22.25
			1	49	22.50	21.09	21.24	22.25
			25	0	20.50	19.86	19.59	19.83
			25	12	20.50	19.85	19.59	19.83
			25	24	20.50	19.94	19.58	20.09
			50	0	20.50	19.83	19.04	20.17
Band	Band Width	Modulation	RB Configuration		Tune-up (dBm)	Channel/Frequency(MHz)		
			RB Size	RB Offset		39725/2503.5	40620/2593	41515/2682.5
			1	0		22.00	21.76	20.93
LTE Band 41	15MHz	QPSK	1	37	22.00	21.60	20.97	21.91
			1	74	22.00	21.51	21.09	21.71
			36	0	21.50	20.68	20.25	20.98
			36	18	21.50	20.64	20.10	20.80
			36	37	21.50	20.74	20.26	21.01
			75	0	21.00	20.82	20.14	20.81
			75	0	21.00	20.82	20.14	20.81
		16QAM	1	0	22.50	21.21	20.80	22.16
			1	37	22.50	21.27	20.76	22.14
			1	74	22.50	21.15	20.98	22.18
			36	0	20.50	19.77	19.35	19.88
			36	18	20.50	19.76	19.17	19.89
			36	37	20.50	19.78	19.20	20.10
			75	0	20.50	19.85	19.38	20.09
Band	Band Width	Modulation	RB Configuration		Tune-up (dBm)	Channel/Frequency(MHz)		
			RB Size	RB Offset		39750/2506	40620/2593	41490/2680
			1	0		22.00	21.56	21.28
LTE Band 41	20MHz	QPSK	1	49	22.00	21.51	21.36	21.85
			1	99	22.00	21.38	21.28	21.84
			50	0	21.00	20.68	20.25	20.65
			50	24	21.00	20.78	20.07	20.79
			50	49	21.00	20.56	20.12	20.99
			100	0	21.00	20.67	20.25	20.99
			100	0	21.00	20.67	20.25	20.99
		16QAM	1	0	22.50	22.28	21.47	20.80
			1	49	22.50	21.86	20.93	21.41
			1	99	22.50	22.08	20.92	21.19
			50	0	20.50	19.89	19.35	19.98
			50	24	20.50	19.98	19.25	19.84
			50	49	20.50	19.76	19.45	20.08
			100	0	20.00	19.78	19.23	19.77

Band	Band Width	Modulation	RB Configuration		Tune-up (dBm)	Channel/Frequency(MHz)		
			RB Size	RB Offset		131979/1710.7	132322/1745	132665/1779.3
LTE Band 66	1.4MHz	QPSK	1	0	23.50	23.31	22.96	23.20
			1	2	23.50	23.35	23.16	23.26
			1	5	23.50	23.36	23.00	23.27
			3	0	23.50	23.45	23.04	23.30
			3	1	23.50	23.39	23.10	23.29
			3	2	23.50	23.41	23.06	23.20
		16QAM	6	0	22.50	22.35	22.08	22.20
			1	0	23.00	22.09	22.30	22.71
			1	2	23.00	22.08	22.25	22.69
			1	5	23.00	22.06	22.27	22.70
			3	0	23.00	22.61	21.92	22.10
			3	1	23.00	22.28	21.95	22.14
			3	2	23.00	22.32	21.88	22.16
			6	0	22.00	21.58	21.37	21.36
Band	Band Width	Modulation	RB Configuration		Tune-up (dBm)	Channel/Frequency(MHz)		
			RB Size	RB Offset		131987/1711.5	132322/1745	132657/1778.5
LTE Band 66	3MHz	QPSK	1	0	23.50	23.35	23.16	23.32
			1	7	23.50	23.34	23.23	23.37
			1	14	23.50	23.36	23.18	23.40
			8	0	22.50	22.36	22.07	22.19
			8	4	22.50	22.42	22.12	22.30
			8	7	22.50	22.40	22.07	22.29
			15	0	22.50	22.37	22.09	22.25
		16QAM	1	0	23.00	22.31	22.26	22.91
			1	7	23.00	22.30	22.28	22.39
			1	14	23.00	22.29	22.16	22.37
			8	0	22.00	21.73	21.34	21.52
			8	4	22.00	21.77	21.27	21.66
			8	7	22.00	21.76	21.32	21.62
			15	0	22.00	21.58	21.17	21.47
Band	Band Width	Modulation	RB Configuration		Tune-up (dBm)	Channel/Frequency(MHz)		
			RB Size	RB Offset		131997/1712.5	132322/1745	132647/1777.5
LTE Band 66	5MHz	QPSK	1	0	23.50	23.37	23.20	23.16
			1	12	23.50	23.36	22.97	23.15
			1	24	23.50	23.35	22.91	23.34
			12	0	23.00	22.43	21.97	22.16
			12	6	23.00	22.45	22.00	22.15
			12	11	23.00	22.53	22.03	22.24
			25	0	22.50	22.48	22.09	22.11
		16QAM	1	0	22.50	22.01	22.37	22.23
			1	12	22.50	22.03	22.34	22.22
			1	24	22.50	21.86	22.31	22.37
			12	0	22.00	21.52	21.07	21.17
			12	6	22.00	21.51	21.09	21.16
			12	11	22.00	21.52	21.03	21.34

Band	Band Width	Modulation	RB Configuration		Tune-up (dBm)	Channel/Frequency(MHz)		
			RB Size	RB Offset		132022/1715	132322/1745	132622/1775
			25	0				
LTE Band 66	10MHz	QPSK	1	0	23.50	21.59	21.24	21.22
			1	24	23.50	23.47	23.26	23.10
			1	49	23.50	23.48	23.17	23.15
			25	0	22.50	23.40	23.11	23.26
			25	12	22.50	22.45	22.17	22.13
			25	24	22.50	22.48	22.13	22.18
			50	0	22.50	22.46	22.12	22.14
		16QAM	1	0	22.50	22.40	22.02	22.20
			1	24	22.50	22.31	22.25	22.28
			1	49	22.50	22.35	22.18	22.31
			1	49	22.50	22.29	22.07	22.42
			25	0	22.00	21.55	21.28	21.33
			25	12	22.00	21.53	21.27	21.32
			25	24	22.00	21.52	21.19	21.32
50	0	22.00	21.55	21.17	21.30			
Band	Band Width	Modulation	RB Configuration		Tune-up (dBm)	Channel/Frequency(MHz)		
			RB Size	RB Offset		132047/1717.5	132322/1745	132597/1772.5
			1	0				
LTE Band 66	15MHz	QPSK	1	0	23.50	23.44	23.17	23.06
			1	37	23.50	23.49	23.02	23.15
			1	74	23.50	23.48	22.90	23.28
			36	0	23.00	22.52	22.19	22.05
			36	18	23.00	22.49	22.17	22.17
			36	37	23.00	22.43	22.01	22.16
			75	0	22.50	22.48	22.04	22.18
		16QAM	1	0	23.00	22.44	22.44	22.82
			1	37	23.00	22.47	22.34	22.85
			1	74	23.00	22.49	22.42	22.95
			36	0	22.00	21.44	21.27	21.15
			36	18	22.00	21.64	21.16	21.14
			36	37	22.00	21.66	21.12	21.14
			75	0	22.00	21.64	21.14	21.28
Band	Band Width	Modulation	RB Configuration		Tune-up (dBm)	Channel/Frequency(MHz)		
			RB Size	RB Offset		132072/1720	132322/1745	132572/1770
			1	0				
LTE Band 66	20MHz	QPSK	1	0	23.50	23.47	23.37	23.14
			1	49	23.50	23.47	23.19	23.28
			1	99	23.50	23.38	23.10	23.44
			50	0	22.50	22.47	22.23	22.10
			50	24	22.50	22.48	22.14	22.11
			50	49	22.50	22.46	21.96	22.18
			100	0	22.50	22.42	22.21	22.07
		16QAM	1	0	23.00	22.48	22.83	22.30
			1	49	23.00	22.53	22.59	22.42
			1	99	23.00	22.53	22.48	22.65
			50	0	22.00	21.60	21.28	21.11
			50	24	22.00	21.62	21.19	21.25
			50	49	22.00	21.58	21.14	21.21



			100	0	22.00	21.57	21.31	21.08
--	--	--	-----	---	-------	-------	-------	-------

8.4. Wi-Fi & BT Output Power

Mode	Channel	Frequency (MHz)	Output Power(dBm)	Tune-up(dBm)
802.11b	1	2412	19.33	20.00
	6	2437	19.25	20.00
	11	2462	18.90	19.00
802.11g	1	2412	22.69	23.00
	6	2437	22.69	23.00
	11	2462	21.95	22.00
802.11n HT20	1	2412	22.78	23.00
	6	2437	22.63	23.00
	11	2462	21.91	22.00
802.11n HT40	3	2422	22.13	23.00
	6	2437	21.93	22.00
	9	2452	21.79	22.00

Mode	Frequency (MHz)	Output Power(dBm)	Tune-up(dBm)
802.11A	5180	7.87	7±1
	5200	7.62	7±1
	5240	7.55	7±1
802.11N20SISO	5180	8.00	8±1
	5200	7.34	7±1
	5240	7.55	7±1
802.11N40SISO	5190	8.10	8±1
	5230	6.82	6±1
802.11AC20SISO	5180	7.88	7±1
	5200	7.46	7±1
	5240	7.53	7±1
802.11AC40SISO	5190	7.85	7±1
	5230	7.30	7±1
802.11AC80SISO	5210	7.43	7±1

Mode	Frequency (MHz)	Output Power (dBm)	Tune-up
802.11A	5745	11.25	11±1
	5785	10.96	10±1
	5825	10.19	10±1
802.11N20SISO	5745	11.16	11±1
	5785	10.50	10±1
	5825	9.96	9±1
802.11N40SISO	5755	10.88	10±1
	5795	10.59	10±1
802.11AC20SISO	5745	10.98	10±1
	5785	11.02	11±1
	5825	9.76	9±1
802.11AC40SISO	5755	10.98	10±1
	5795	10.72	10±1
802.11AC80SISO	5775	10.64	10±1

Mode	Channel	Output Power (dBm)	Tune-up
DH5	Hop	2.73	2±1
2DH5	Hop	2.07	2±1
3DH5	Hop	2.07	2±1
LE1M	CH00	-4.33	-4±1

	CH19	-4.13	-4±1
	CH39	-4.11	-4±1

9. Antenna Location

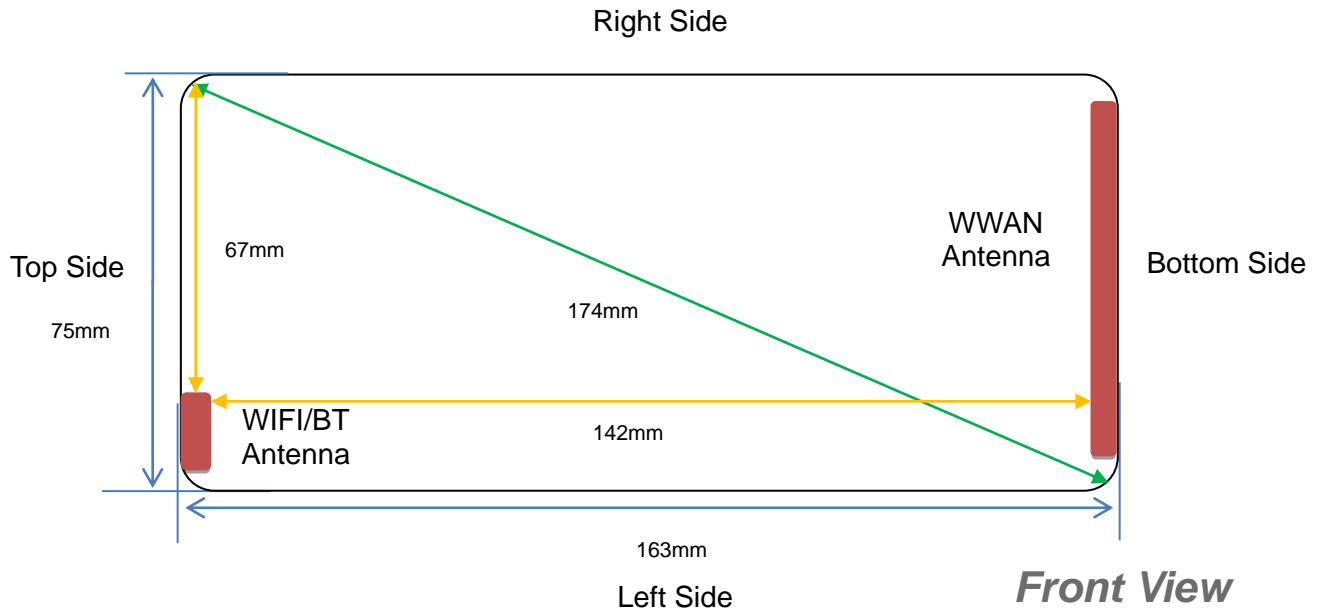

Antenna information:

Distance of The Antenna to the EUT surface and edge (mm)						
Antennas	Front Side	Back Side	Left Side	Right Side	Top Side	Bottom Side
BT/WLAN	≤25mm	≤25mm	≤25mm	>25mm	≤25mm	>25mm
WWAN	≤25mm	≤25mm	≤25mm	≤25mm	>25mm	≤25mm

Positions for SAR tests						
Antennas	Front Side	Back Side	Left Side	Right Side	Top Side	Bottom Side
BT/WLAN	Yes	Yes	Yes	NO	Yes	NO
WWAN	Yes	Yes	Yes	Yes	NO	Yes

10. Stand-alone SAR test exclusion

Refer to FCC KDB 447498D01, the 1-g SAR and 10-g SAR test exclusion thresholds for 100 MHz to 6 GHz at test separation distances ≤ 50 mm are determined by:

$[(\text{max. power of channel, including tune-up tolerance, mW})/(\text{min. test separation distance, mm})] \cdot [\sqrt{f(\text{GHz})}] \leq 3.0$ for 1-g SAR and ≤ 7.5 for 10-g extremity SAR, where:

- $f(\text{GHz})$ is the RF channel transmit frequency in GHz
- Power and distance are rounded to the nearest mW and mm before calculation
- The result is rounded to one decimal place for comparison

When the minimum test separation distance is < 5 mm, a distance of 5 mm is applied to determine SAR test exclusion.

Mode	Pmax (dBm)	Pmax (mW)	Distance (mm)	f (GHz)	Calculation Result	SAR Exclusion threshold	SAR test exclusion
Bluetooth	3.00	2.00	5	2.480	0.6	3	Yes

NOTE: Standalone SAR test exclusion for Bluetooth.

When standalone SAR test exclusion applies to an antenna that transmits simultaneously with other antennas, the standalone SAR must be estimated according to following to determine simultaneous transmission SAR test exclusion:

$[(\text{max. power of channel, including tune-up tolerance, mW})/(\text{min. test separation distance, mm})] \cdot [\sqrt{f(\text{GHz})}/x] \text{ W/kg}$ for test separation distances $\leq 50\text{mm}$, where $x = 7.5$ for 1-g SAR and $x = 18.75$ for 10-g SAR.

When the minimum test separation distance is < 5 mm, a distance of 5 mm is applied to determine SAR test exclusion.

Mode	Position	Pmax (dBm)	Pmax (mW)	Distance (mm)	f (GHz)	x	Estimated SAR (W/kg)
Bluetooth	Head	3.00	2.00	5	2.48	7.5	0.084
Bluetooth	Body	3.00	2.00	10	2.48	7.5	0.042
Bluetooth	Hotspot	3.00	2.00	10	2.48	7.5	0.042

NOTE: Estimated SAR calculation for Bluetooth

11. SAR Measurement Results

< GSM 850 >

Test Position	Test channel /Freq.	Test Mode	SAR Value (W/kg)		Power Drift (±5%)	Conducted power (dBm)	Tune-up power (dBm)	Scaled SAR 1g (W/Kg)	Date	Plot
			1g	10g						
Left Cheek	189/836.4	GPRS(GMSK 4TS)	0.325	0.240	4.41	29.19	29.50	0.349	2024/12/3	1#
Left Tilt 15 Degree	189/836.4	GPRS(GMSK 4TS)	0.190	0.139	-1.24	29.19	29.50	0.204	2024/12/3	
Right Cheek	189/836.4	GPRS(GMSK 4TS)	0.292	0.209	-1.73	29.19	29.50	0.314	2024/12/3	
Right Tilt 15 Degree	189/836.4	GPRS(GMSK 4TS)	0.133	0.095	-3.51	29.19	29.50	0.143	2024/12/3	

Test Position of Hotspot with 10mm	Test channel /Freq.	Test Mode	SAR Value (W/kg)		Power Drift (±5%)	Conducted power (dBm)	Tune-up power (dBm)	Scaled SAR 1g (W/Kg)	Date	Plot
			1g	10g						
Front Side	189/836.4	GPRS(GMSK 4TS)	0.420	0.341	-1.99	29.19	29.50	0.451	2024/12/3	
Back Side	189/836.4	GPRS(GMSK 4TS)	0.689	0.559	-1.15	29.19	29.50	0.740	2024/12/3	2#
Left Side	189/836.4	GPRS(GMSK 4TS)	0.207	0.165	0.42	29.19	29.50	0.222	2024/12/3	
Right Side	189/836.4	GPRS(GMSK 4TS)	0.216	0.175	1.99	29.19	29.50	0.232	2024/12/3	
Bottom Side	189/836.4	GPRS(GMSK 4TS)	0.350	0.278	3.09	29.19	29.50	0.376	2024/12/3	

< GSM 1900 >

Test Position	Test channel /Freq.	Test Mode	SAR Value (W/kg)		Power Drift (±5%)	Conducted power (dBm)	Tune-up power (dBm)	Scaled SAR 1g	Date	Plot
			1g	10g						

								(W/Kg)		
Left Cheek	661/1880	GPRS(GMSK 2TS)	0.281	0.119	0.94	29.20	29.50	0.301	2024/11/25	3#
Left Tilt 15 Degree	661/1880	GPRS(GMSK 2TS)	0.147	0.062	3.07	29.20	29.50	0.158	2024/11/25	
Right Cheek	661/1880	GPRS(GMSK 2TS)	0.245	0.100	-2.12	29.20	29.50	0.263	2024/11/25	
Right Tilt 15 Degree	661/1880	GPRS(GMSK 2TS)	0.117	0.049	-1.25	29.20	29.50	0.125	2024/11/25	

Test Position of Hotspot with 10mm	Test channel /Freq.	Test Mode	SAR Value (W/kg)		Power Drift (±5%)	Conducted power (dBm)	Tune-up power (dBm)	Scaled SAR 1g (W/Kg)	Date	Plot
			1g	10g						
Front Side	661/1880	GPRS(GMSK 2TS)	0.162	0.095	2.11	29.20	29.50	0.174	2024/11/25	
Back Side	661/1880	GPRS(GMSK 2TS)	0.236	0.145	-0.96	29.20	29.50	0.253	2024/11/25	4#
Left Side	661/1880	GPRS(GMSK 2TS)	0.072	0.043	2.58	29.20	29.50	0.077	2024/11/25	
Right Side	661/1880	GPRS(GMSK 2TS)	0.075	0.045	-3.32	29.20	29.50	0.080	2024/11/25	
Bottom Side	661/1880	GPRS(GMSK 2TS)	0.120	0.071	2.01	29.20	29.50	0.129	2024/11/25	

< WCDMA Band 2 >

Test Position	Test channel /Freq.	Test Mode	SAR Value (W/kg)		Power Drift (±5%)	Conducted power (dBm)	Tune-up power (dBm)	Scaled SAR 1g (W/Kg)	Date	Plot
			1g	10g						
Left Cheek	9400/1880	RMC12.2K	0.076	0.047	-2.82	24.51	25.00	0.085	2024/11/25	5#
Left Tilt 15 Degree	9400/1880	RMC12.2K	0.039	0.023	2.95	24.51	25.00	0.044	2024/11/25	
Right	9400/1880	RMC12.2K	0.070	0.043	-2.51	24.51	25.00	0.078	2024/11/25	

Cheek										
Right Tilt 15 Degree	9400/1880	RMC12.2K	0.033	0.020	-2.33	24.51	25.00	0.037	2024/11/25	

Test Position of Hotspot with 10mm	Test channel /Freq.	Test Mode	SAR Value (W/kg)		Power Drift (±5%)	Conducted power (dBm)	Tune-up power (dBm)	Scaled SAR 1g (W/Kg)	Date	Plot
			1g	10g						
Front Side	9400/1880	RMC12.2K	0.240	0.130	-2.20	24.51	25.00	0.269	2024/11/25	
Back Side	9400/1880	RMC12.2K	0.350	0.199	1.45	24.51	25.00	0.392	2024/11/25	6#
Left Side	9400/1880	RMC12.2K	0.108	0.060	2.43	24.51	25.00	0.121	2024/11/25	
Right Side	9400/1880	RMC12.2K	0.105	0.057	-1.60	24.51	25.00	0.118	2024/11/25	
Bottom Side	9400/1880	RMC12.2K	0.175	0.097	-2.11	24.51	25.00	0.196	2024/11/25	

< WCDMA Band 5 >

Test Position	Test channel /Freq.	Test Mode	SAR Value (W/kg)		Power Drift (±5%)	Conducted power (dBm)	Tune-up power (dBm)	Scaled SAR 1g (W/Kg)	Date	Plot
			1g	10g						
Left Cheek	4182/836.4	RMC12.2K	0.201	0.125	3.50	24.13	25.00	0.246	2024/12/3	7#
Left Tilt 15 Degree	4182/836.4	RMC12.2K	0.120	0.071	-0.53	24.13	25.00	0.147	2024/12/3	
Right Cheek	4182/836.4	RMC12.2K	0.179	0.107	-2.03	24.13	25.00	0.219	2024/12/3	
Right Tilt 15 Degree	4182/836.4	RMC12.2K	0.091	0.054	-0.13	24.13	25.00	0.111	2024/12/3	

Test Position	Test channel	Test Mode	SAR Value (W/kg)	Power Drift	Conducted power	Tune-up power	Scaled SAR	Date	Plot
---------------	--------------	-----------	------------------	-------------	-----------------	---------------	------------	------	------

of Hotspot with 10mm	/Freq.		1g	10g	(±5%)	(dBm)	(dBm)	1g (W/Kg)		
Front Side	4182/836.4	RMC12.2K	0.126	0.075	-1.69	24.13	25.00	0.154	2024/12/3	
Back Side	4182/836.4	RMC12.2K	0.207	0.127	2.37	24.13	25.00	0.253	2024/12/3	8#
Left Side	4182/836.4	RMC12.2K	0.063	0.038	3.44	24.13	25.00	0.077	2024/12/3	
Right Side	4182/836.4	RMC12.2K	0.062	0.037	-3.57	24.13	25.00	0.076	2024/12/3	
Bottom Side	4182/836.4	RMC12.2K	0.120	0.072	2.32	24.13	25.00	0.147	2024/12/3	

< LTE Band 2 >

Test Position	Test channel /Freq.	Test Mode	SAR Value (W/kg)		Power Drift (±5%)	Conducted power (dBm)	Tune-up power (dBm)	Scaled SAR 1g (W/Kg)	Date	Plot
			1g	10g						
1RB										
Left Cheek	18900/1880	20M QPSK(1,49)	0.302	0.185	-3.86	23.69	24.50	0.364	2024/11/25	15#
Left Tilt 15 Degree	18900/1880	20M QPSK(1,49)	0.158	0.096	3.28	23.69	24.50	0.190	2024/11/25	
Right Cheek	18900/1880	20M QPSK(1,49)	0.275	0.168	1.43	23.69	24.50	0.331	2024/11/25	
Right Tilt 15 Degree	18900/1880	20M QPSK(1,49)	0.139	0.083	3.14	23.69	24.50	0.167	2024/11/25	
50%RB										
Left Cheek	18900/1880	20M QPSK(50,0)	0.154	0.100	-1.02	22.71	23.00	0.165	2024/11/25	
Left Tilt 15 Degree	18900/1880	20M QPSK(50,0)	0.089	0.050	4.28	22.71	23.00	0.095	2024/11/25	
Right Cheek	18900/1880	20M QPSK(50,0)	0.142	0.090	-2.43	22.71	23.00	0.152	2024/11/25	
Right	18900/1880	20M QPSK(50,0)	0.070	0.048	4.35	22.71	23.00	0.075	2024/11/25	

Tilt 15 Degree										
----------------	--	--	--	--	--	--	--	--	--	--

Test Position of Hotspot with 10mm	Test channel /Freq.	Test Mode	SAR Value (W/kg)		Power Drift (±5%)	Conducted power (dBm)	Tune-up power (dBm)	Scaled SAR 1g (W/Kg)	Date	Plot
			1g	10g						
1RB										
Front Side	18900/1880	20M QPSK(1,49)	0.204	0.124	1.79	23.69	24.50	0.246	2024/11/25	
Back Side	18900/1880	20M QPSK(1,49)	0.328	0.203	4.11	23.69	24.50	0.395	2024/11/25	16#
Left Side	18900/1880	20M QPSK(1,49)	0.099	0.061	-0.15	23.69	24.50	0.119	2024/11/25	
Right Side	18900/1880	20M QPSK(1,49)	0.102	0.063	-0.14	23.69	24.50	0.123	2024/11/25	
Bottom Side	18900/1880	20M QPSK(1,49)	0.180	0.111	3.06	23.69	24.50	0.217	2024/11/25	
50%RB										
Front Side	18900/1880	20M QPSK(50,0)	0.111	0.064	-1.92	22.71	23.00	0.119	2024/11/25	
Back Side	18900/1880	20M QPSK(50,0)	0.192	0.116	-4.70	22.71	23.00	0.205	2024/11/25	
Left Side	18900/1880	20M QPSK(50,0)	0.052	0.031	0.46	22.71	23.00	0.056	2024/11/25	
Right Side	18900/1880	20M QPSK(50,0)	0.053	0.034	-2.89	22.71	23.00	0.057	2024/11/25	
Bottom Side	18900/1880	20M QPSK(50,0)	0.103	0.058	1.56	22.71	23.00	0.110	2024/11/25	

< LTE Band 4 >

Test Position	Test channel /Freq.	Test Mode	SAR Value (W/kg)		Power Drift (±5%)	Conducted power (dBm)	Tune-up power (dBm)	Scaled SAR 1g (W/Kg)	Date	Plot
			1g	10g						
1RB										
Left Cheek	20175/1732.5	20M QPSK(1,0)	0.310	0.188	1.22	23.02	23.50	0.346	2024/11/21	17#
Left Tilt	20175/1732.5	20M QPSK(1,0)	0.156	0.090	-2.72	23.02	23.50	0.174	2024/11/21	

15 Degree										
Right Cheek	20175/1732.5	20M QPSK(1,0)	0.291	0.168	0.71	23.02	23.50	0.325	2024/11/21	
Right Tilt 15 Degree	20175/1732.5	20M QPSK(1,0)	0.144	0.087	0.55	23.02	23.50	0.161	2024/11/21	
50%RB										
Left Cheek	20175/1732.5	20M QPSK(50,0)	0.183	0.103	-1.27	21.94	22.50	0.208	2024/11/21	
Left Tilt 15 Degree	20175/1732.5	20M QPSK(50,0)	0.087	0.050	0.37	21.94	22.50	0.099	2024/11/21	
Right Cheek	20175/1732.5	20M QPSK(50,0)	0.174	0.089	4.40	21.94	22.50	0.198	2024/11/21	
Right Tilt 15 Degree	20175/1732.5	20M QPSK(50,0)	0.085	0.051	0.79	21.94	22.50	0.097	2024/11/21	

Test Position of Hotspot with 10mm	Test channel /Freq.	Test Mode	SAR Value (W/kg)		Power Drift (±5%)	Conducted power (dBm)	Tune-up power (dBm)	Scaled SAR 1g (W/Kg)	Date	Plot
			1g	10g						
1RB										
Front Side	20175/1732.5	20M QPSK(1,0)	0.216	0.133	-0.53	23.02	23.50	0.241	2024/11/21	
Back Side	20175/1732.5	20M QPSK(1,0)	0.329	0.209	-2.36	23.02	23.50	0.367	2024/11/21	18#
Left Side	20175/1732.5	20M QPSK(1,0)	0.099	0.061	0.57	23.02	23.50	0.111	2024/11/21	
Right Side	20175/1732.5	20M QPSK(1,0)	0.097	0.060	3.40	23.02	23.50	0.108	2024/11/21	
Bottom Side	20175/1732.5	20M QPSK(1,0)	0.185	0.114	0.31	23.02	23.50	0.207	2024/11/21	
50%RB										
Front Side	20175/1732.5	20M QPSK(50,0)	0.113	0.074	1.30	21.94	22.50	0.129	2024/11/21	
Back Side	20175/1732.5	20M QPSK(50,0)	0.177	0.108	-0.23	21.94	22.50	0.201	2024/11/21	

Left Side	20175/1732.5	20M QPSK(50,0)	0.058	0.036	2.41	21.94	22.50	0.066	2024/11/21	
Right Side	20175/1732.5	20M QPSK(50,0)	0.053	0.034	4.08	21.94	22.50	0.060	2024/11/21	
Bottom Side	20175/1732.5	20M QPSK(50,0)	0.108	0.060	0.65	21.94	22.50	0.123	2024/11/21	

< LTE Band 5 >

Test Position	Test channel /Freq.	Test Mode	SAR Value (W/kg)		Power Drift (±5%)	Conducted power (dBm)	Tune-up power (dBm)	Scaled SAR 1g (W/Kg)	Date	Plot
			1g	10g						
1RB										
Left Cheek	20525/836.5	10M QPSK(1,49)	0.202	0.120	-1.16	23.05	23.50	0.224	2024/12/3	19#
Left Tilt 15 Degree	20525/836.5	10M QPSK(1,49)	0.113	0.064	-0.79	23.05	23.50	0.125	2024/12/3	
Right Cheek	20525/836.5	10M QPSK(1,49)	0.175	0.102	-1.52	23.05	23.50	0.194	2024/12/3	
Right Tilt 15 Degree	20525/836.5	10M QPSK(1,49)	0.089	0.051	-1.09	23.05	23.50	0.099	2024/12/3	
50%RB										
Left Cheek	20525/836.5	10M QPSK(25,24)	0.104	0.064	2.61	22.17	22.50	0.112	2024/12/3	
Left Tilt 15 Degree	20525/836.5	10M QPSK(25,24)	0.059	0.035	1.81	22.17	22.50	0.064	2024/12/3	
Right Cheek	20525/836.5	10M QPSK(25,24)	0.101	0.052	-1.34	22.17	22.50	0.109	2024/12/3	
Right Tilt 15 Degree	20525/836.5	10M QPSK(25,24)	0.046	0.026	3.16	22.17	22.50	0.050	2024/12/3	

Test Position of Hotspot with 10mm	Test channel /Freq.	Test Mode	SAR Value (W/kg)		Power Drift (±5%)	Conducted power (dBm)	Tune-up power (dBm)	Scaled SAR 1g (W/Kg)	Date	Plot
			1g	10g						

1RB										
Front Side	20525/836.5	10M QPSK(1,49)	0.138	0.076	-0.90	23.05	23.50	0.153	2024/12/3	
Back Side	20525/836.5	10M QPSK(1,49)	0.222	0.128	1.63	23.05	23.50	0.246	2024/12/3	20#
Left Side	20525/836.5	10M QPSK(1,49)	0.075	0.043	2.94	23.05	23.50	0.083	2024/12/3	
Right Side	20525/836.5	10M QPSK(1,49)	0.081	0.045	-3.35	23.05	23.50	0.090	2024/12/3	
Bottom Side	20525/836.5	10M QPSK(1,49)	0.135	0.074	1.65	23.05	23.50	0.150	2024/12/3	
50%RB										
Front Side	20525/836.5	10M QPSK(25,24)	0.081	0.042	-4.10	22.17	22.50	0.087	2024/12/3	
Back Side	20525/836.5	10M QPSK(25,24)	0.113	0.072	2.78	22.17	22.50	0.122	2024/12/3	
Left Side	20525/836.5	10M QPSK(25,24)	0.042	0.023	0.61	22.17	22.50	0.045	2024/12/3	
Right Side	20525/836.5	10M QPSK(25,24)	0.045	0.024	-0.45	22.17	22.50	0.049	2024/12/3	
Bottom Side	20525/836.5	10M QPSK(25,24)	0.073	0.044	-3.84	22.17	22.50	0.079	2024/12/3	

< LTE Band 7 >

Test Position	Test channel /Freq.	Test Mode	SAR Value (W/kg)		Power Drift (±5%)	Conducted power (dBm)	Tune-up power (dBm)	Scaled SAR 1g (W/Kg)	Date	Plot
			1g	10g						
1RB										
Left Cheek	21100/2535	20M QPSK(1,49)	0.052	0.033	3.37	21.45	21.50	0.053	2024/12/11	21#
Left Tilt 15 Degree	21100/2535	20M QPSK(1,49)	0.030	0.019	-1.46	21.45	21.50	0.030	2024/12/11	
Right Cheek	21100/2535	20M QPSK(1,49)	0.047	0.029	-0.36	21.45	21.50	0.048	2024/12/11	
Right Tilt 15 Degree	21100/2535	20M QPSK(1,49)	0.023	0.014	2.51	21.45	21.50	0.023	2024/12/11	
50%RB										

Left Cheek	21100/2535	20M QPSK(50,24)	0.026	0.018	0.17	20.54	21.00	0.029	2024/12/11	
Left Tilt 15 Degree	21100/2535	20M QPSK(50,24)	0.015	0.010	-0.58	20.54	21.00	0.017	2024/12/11	
Right Cheek	21100/2535	20M QPSK(50,24)	0.025	0.015	-1.53	20.54	21.00	0.028	2024/12/11	
Right Tilt 15 Degree	21100/2535	20M QPSK(50,24)	0.012	0.008	-0.79	20.54	21.00	0.013	2024/12/11	

Test Position of Hotspot with 10mm	Test channel /Freq.	Test Mode	SAR Value (W/kg)		Power Drift (±5%)	Conducted power (dBm)	Tune-up power (dBm)	Scaled SAR 1g (W/Kg)	Date	Plot
			1g	10g						
1RB										
Front Side	21100/2535	20M QPSK(1,49)	0.060	0.033	2.79	21.45	21.50	0.061	2024/12/11	
Back Side	21100/2535	20M QPSK(1,49)	0.096	0.055	1.21	21.45	21.50	0.097	2024/12/11	22#
Left Side	21100/2535	20M QPSK(1,49)	0.042	0.024	2.52	21.45	21.50	0.042	2024/12/11	
Right Side	21100/2535	20M QPSK(1,49)	0.040	0.022	3.94	21.45	21.50	0.040	2024/12/11	
Bottom Side	21100/2535	20M QPSK(1,49)	0.060	0.034	-1.10	21.45	21.50	0.061	2024/12/11	
50%RB										
Front Side	21100/2535	20M QPSK(50,24)	0.034	0.019	2.86	20.54	21.00	0.038	2024/12/11	
Back Side	21100/2535	20M QPSK(50,24)	0.051	0.032	-1.93	20.54	21.00	0.057	2024/12/11	
Left Side	21100/2535	20M QPSK(50,24)	0.025	0.012	-3.00	20.54	21.00	0.028	2024/12/11	
Right Side	21100/2535	20M QPSK(50,24)	0.023	0.011	4.94	20.54	21.00	0.026	2024/12/11	
Bottom Side	21100/2535	20M QPSK(50,24)	0.033	0.019	-4.05	20.54	21.00	0.037	2024/12/11	

< LTE Band 12 >

Test Position	Test channel /Freq.	Test Mode	SAR Value (W/kg)		Power Drift (±5%)	Conducted power (dBm)	Tune-up power (dBm)	Scaled SAR 1g (W/Kg)	Date	Plot
			1g	10g						
1RB										
Left Cheek	23095/707.5	10M QPSK(1,0)	0.121	0.097	0.93	23.84	24.00	0.126	2024/12/9	23#
Left Tilt 15 Degree	23095/707.5	10M QPSK(1,0)	0.064	0.049	-3.16	23.84	24.00	0.066	2024/12/9	
Right Cheek	23095/707.5	10M QPSK(1,0)	0.104	0.081	-2.92	23.84	24.00	0.108	2024/12/9	
Right Tilt 15 Degree	23095/707.5	10M QPSK(1,0)	0.051	0.040	2.92	23.84	24.00	0.053	2024/12/9	
50%RB										
Left Cheek	23095/707.5	10M QPSK(25,0)	0.064	0.052	-1.33	22.89	23.00	0.066	2024/12/9	
Left Tilt 15 Degree	23095/707.5	10M QPSK(25,0)	0.034	0.026	-2.09	22.89	23.00	0.035	2024/12/9	
Right Cheek	23095/707.5	10M QPSK(25,0)	0.059	0.046	4.60	22.89	23.00	0.061	2024/12/9	
Right Tilt 15 Degree	23095/707.5	10M QPSK(25,0)	0.030	0.024	1.42	22.89	23.00	0.031	2024/12/9	

Test Position of Hotspot with 10mm	Test channel /Freq.	Test Mode	SAR Value (W/kg)		Power Drift (±5%)	Conducted power (dBm)	Tune-up power (dBm)	Scaled SAR 1g (W/Kg)	Date	Plot
			1g	10g						
1RB										
Front Side	23095/707.5	10M QPSK(1,0)	0.216	0.108	-1.42	23.84	24.00	0.224	2024/12/9	
Back Side	23095/707.5	10M QPSK(1,0)	0.328	0.165	-3.67	23.84	24.00	0.340	2024/12/9	24#
Left	23095/707.5	10M QPSK(1,0)	0.102	0.049	0.06	23.84	24.00	0.106	2024/12/9	

Side										
Right Side	23095/707.5	10M QPSK(1,0)	0.103	0.050	1.93	23.84	24.00	0.107	2024/12/9	
Bottom Side	23095/707.5	10M QPSK(1,0)	0.180	0.091	-1.45	23.84	24.00	0.187	2024/12/9	
50%RB										
Front Side	23095/707.5	10M QPSK(25,0)	0.114	0.064	1.94	22.89	23.00	0.117	2024/12/9	
Back Side	23095/707.5	10M QPSK(25,0)	0.185	0.097	-3.54	22.89	23.00	0.190	2024/12/9	
Left Side	23095/707.5	10M QPSK(25,0)	0.061	0.025	-4.17	22.89	23.00	0.063	2024/12/9	
Right Side	23095/707.5	10M QPSK(25,0)	0.062	0.026	3.23	22.89	23.00	0.064	2024/12/9	
Bottom Side	23095/707.5	10M QPSK(25,0)	0.092	0.049	-3.13	22.89	23.00	0.094	2024/12/9	

< LTE Band 17 >

Test Position	Test channel /Freq.	Test Mode	SAR Value (W/kg)		Power Drift (±5%)	Conducted power (dBm)	Tune-up power (dBm)	Scaled SAR 1g (W/Kg)	Date	Plot
			1g	10g						
1RB										
Left Cheek	23790/710	10M QPSK(1,0)	0.508	0.303	-4.40	23.60	24.00	0.557	2024/12/9	25#
Left Tilt 15 Degree	23790/710	10M QPSK(1,0)	0.291	0.168	3.51	23.60	24.00	0.319	2024/12/9	
Right Cheek	23790/710	10M QPSK(1,0)	0.478	0.274	-1.87	23.60	24.00	0.524	2024/12/9	
Right Tilt 15 Degree	23790/710	10M QPSK(1,0)	0.232	0.133	1.63	23.60	24.00	0.254	2024/12/9	
50%RB										
Left Cheek	23790/710	10M QPSK(25,12)	0.274	0.169	1.88	22.74	23.00	0.291	2024/12/9	
Left Tilt 15 Degree	23790/710	10M QPSK(25,12)	0.165	0.088	-2.56	22.74	23.00	0.175	2024/12/9	
Right	23790/710	10M QPSK(25,12)	0.267	0.143	-3.63	22.74	23.00	0.283	2024/12/9	

Cheek										
Right Tilt 15 Degree	23790/710	10M QPSK(25,12)	0.135	0.077	-0.57	22.74	23.00	0.143	2024/12/9	

Test Position of Hotspot with 10mm	Test channel /Freq.	Test Mode	SAR Value (W/kg)		Power Drift (±5%)	Conducted power (dBm)	Tune-up power (dBm)	Scaled SAR 1g (W/Kg)	Date	Plot
			1g	10g						
1RB										
Front Side	23790/710	10M QPSK(1,0)	0.246	0.154	-0.01	23.60	24.00	0.270	2024/12/9	
Back Side	23790/710	10M QPSK(1,0)	0.392	0.259	-1.27	23.60	24.00	0.430	2024/12/9	26#
Left Side	23790/710	10M QPSK(1,0)	0.123	0.078	0.78	23.60	24.00	0.135	2024/12/9	
Right Side	23790/710	10M QPSK(1,0)	0.129	0.082	2.66	23.60	24.00	0.141	2024/12/9	
Bottom Side	23790/710	10M QPSK(1,0)	0.205	0.129	-1.40	23.60	24.00	0.225	2024/12/9	
50%RB										
Front Side	23790/710	10M QPSK(25,12)	0.137	0.079	3.20	22.74	23.00	0.145	2024/12/9	
Back Side	23790/710	10M QPSK(25,12)	0.209	0.136	-2.60	22.74	23.00	0.222	2024/12/9	
Left Side	23790/710	10M QPSK(25,12)	0.072	0.042	4.61	22.74	23.00	0.076	2024/12/9	
Right Side	23790/710	10M QPSK(25,12)	0.067	0.041	3.93	22.74	23.00	0.071	2024/12/9	
Bottom Side	23790/710	10M QPSK(25,12)	0.106	0.075	-0.98	22.74	23.00	0.113	2024/12/9	

< LTE Band 26A >

Test Position	Test channel /Freq.	Test Mode	SAR Value (W/kg)		Power Drift (±5%)	Conducted power (dBm)	Tune-up power (dBm)	Scaled SAR 1g (W/Kg)	Date	Plot
			1g	10g						
1RB										

Left Cheek	26740/819	10M QPSK(1,0)	0.156	0.119	-0.38	23.54	24.00	0.173	2024/12/3	31#
Left Tilt 15 Degree	26740/819	10M QPSK(1,0)	0.093	0.071	-0.71	23.54	24.00	0.103	2024/12/3	
Right Cheek	26740/819	10M QPSK(1,0)	0.147	0.110	-3.10	23.54	24.00	0.163	2024/12/3	
Right Tilt 15 Degree	26740/819	10M QPSK(1,0)	0.071	0.051	1.63	23.54	24.00	0.079	2024/12/3	

50%RB

Left Cheek	26740/819	10M QPSK(25,0)	0.089	0.067	2.79	21.58	22.00	0.098	2024/12/3	
Left Tilt 15 Degree	26740/819	10M QPSK(25,0)	0.047	0.037	0.15	21.58	22.00	0.052	2024/12/3	
Right Cheek	26740/819	10M QPSK(25,0)	0.084	0.056	3.62	21.58	22.00	0.093	2024/12/3	
Right Tilt 15 Degree	26740/819	10M QPSK(25,0)	0.040	0.028	1.76	21.58	22.00	0.044	2024/12/3	

Test Position of Hotspot with 10mm	Test channel /Freq.	Test Mode	SAR Value (W/kg)		Power Drift (±5%)	Conducted power (dBm)	Tune-up power (dBm)	Scaled SAR 1g (W/Kg)	Date	Plot
			1g	10g						

1RB

Front Side	26740/819	10M QPSK(1,0)	0.126	0.076	1.18	23.54	24.00	0.140	2024/12/3	
Back Side	26740/819	10M QPSK(1,0)	0.182	0.113	-0.20	23.54	24.00	0.202	2024/12/3	32#
Left Side	26740/819	10M QPSK(1,0)	0.069	0.042	-0.90	23.54	24.00	0.077	2024/12/3	
Right Side	26740/819	10M QPSK(1,0)	0.063	0.039	-2.24	23.54	24.00	0.070	2024/12/3	
Bottom Side	26740/819	10M QPSK(1,0)	0.110	0.068	2.49	23.54	24.00	0.122	2024/12/3	

50%RB

Front	26740/819	10M	0.064	0.043	0.24	21.58	22.00	0.070	2024/12/3	
-------	-----------	-----	-------	-------	------	-------	-------	-------	-----------	--

Side		QPSK(25,0)								
Back Side	26740/819	10M QPSK(25,0)	0.099	0.063	1.33	21.58	22.00	0.109	2024/12/3	
Left Side	26740/819	10M QPSK(25,0)	0.040	0.025	-3.87	21.58	22.00	0.044	2024/12/3	
Right Side	26740/819	10M QPSK(25,0)	0.033	0.022	-4.01	21.58	22.00	0.036	2024/12/3	
Bottom Side	26740/819	10M QPSK(25,0)	0.055	0.035	-2.10	21.58	22.00	0.061	2024/12/3	

< LTE Band 26B >

Test Position	Test channel /Freq.	Test Mode	SAR Value (W/kg)		Power Drift (±5%)	Conducted power (dBm)	Tune-up power (dBm)	Scaled SAR 1g (W/Kg)	Date	Plot
			1g	10g						
1RB										
Left Cheek	26865/831.5	15M QPSK(1,0)	0.086	0.067	0.70	23.17	23.50	0.093	2024/12/3	33#
Left Tilt 15 Degree	26865/831.5	15M QPSK(1,0)	0.045	0.033	1.89	23.17	23.50	0.049	2024/12/3	
Right Cheek	26865/831.5	15M QPSK(1,0)	0.078	0.060	-1.62	23.17	23.50	0.084	2024/12/3	
Right Tilt 15 Degree	26865/831.5	15M QPSK(1,0)	0.037	0.028	-1.95	23.17	23.50	0.040	2024/12/3	
50%RB										
Left Cheek	26865/831.5	15M QPSK(36,0)	0.047	0.034	4.60	21.25	21.50	0.050	2024/12/3	
Left Tilt 15 Degree	26865/831.5	15M QPSK(36,0)	0.023	0.019	4.62	21.25	21.50	0.024	2024/12/3	
Right Cheek	26865/831.5	15M QPSK(36,0)	0.045	0.036	1.72	21.25	21.50	0.048	2024/12/3	
Right Tilt 15 Degree	26865/831.5	15M QPSK(36,0)	0.019	0.015	-2.22	21.25	21.50	0.020	2024/12/3	

Test Position	Test channel /Freq.	Test Mode	SAR Value (W/kg)		Power Drift	Conducted power	Tune-up power	Scaled SAR	Date	Plot
---------------	---------------------	-----------	------------------	--	-------------	-----------------	---------------	------------	------	------

of Hotspot with 10mm			1g	10g	(±5%)	(dBm)	(dBm)	1g (W/Kg)		
1RB										
Front Side	26865/831.5	15M QPSK(1,0)	0.084	0.052	-2.94	23.17	23.50	0.091	2024/12/3	
Back Side	26865/831.5	15M QPSK(1,0)	0.098	0.063	0.37	23.17	23.50	0.106	2024/12/3	34#
Left Side	26865/831.5	15M QPSK(1,0)	0.036	0.023	-2.33	23.17	23.50	0.039	2024/12/3	
Right Side	26865/831.5	15M QPSK(1,0)	0.042	0.026	1.19	23.17	23.50	0.045	2024/12/3	
Bottom Side	26865/831.5	15M QPSK(1,0)	0.070	0.044	0.58	23.17	23.50	0.076	2024/12/3	
50%RB										
Front Side	26865/831.5	15M QPSK(36,0)	0.045	0.029	-2.10	21.25	21.50	0.048	2024/12/3	
Back Side	26865/831.5	15M QPSK(36,0)	0.056	0.034	1.14	21.25	21.50	0.059	2024/12/3	
Left Side	26865/831.5	15M QPSK(36,0)	0.018	0.012	-4.44	21.25	21.50	0.019	2024/12/3	
Right Side	26865/831.5	15M QPSK(36,0)	0.024	0.015	-1.72	21.25	21.50	0.025	2024/12/3	
Bottom Side	26865/831.5	15M QPSK(36,0)	0.038	0.025	-1.65	21.25	21.50	0.040	2024/12/3	

< LTE Band 41 >

Test Position	Test channel /Freq.	Test Mode	SAR Value (W/kg)		Power Drift (±5%)	Conducted power (dBm)	Tune-up power (dBm)	Scaled SAR 1g (W/Kg)	Date	Plot
			1g	10g						
1RB										
Left Cheek	40620/2593	20M QPSK(1,49)	0.671	0.468	1.11	21.36	22.00	0.778	2024/12/11	27#
Left Tilt 15 Degree	40620/2593	20M QPSK(1,49)	0.339	0.234	-0.07	21.36	22.00	0.393	2024/12/11	
Right Cheek	40620/2593	20M QPSK(1,49)	0.585	0.388	-1.01	21.36	22.00	0.678	2024/12/11	

Right Tilt 15 Degree	40620/2593	20M QPSK(1,49)	0.311	0.208	-1.89	21.36	22.00	0.360	2024/12/11	
50%RB										
Left Cheek	40620/2593	20M QPSK(50,49)	0.375	0.272	0.66	20.12	21.00	0.459	2024/12/11	
Left Tilt 15 Degree	40620/2593	20M QPSK(50,49)	0.176	0.132	1.62	20.12	21.00	0.216	2024/12/11	
Right Cheek	40620/2593	20M QPSK(50,49)	0.327	0.216	-2.66	20.12	21.00	0.400	2024/12/11	
Right Tilt 15 Degree	40620/2593	20M QPSK(50,49)	0.183	0.114	2.44	20.12	21.00	0.224	2024/12/11	

Test Position of Hotspot with 10mm	Test channel /Freq.	Test Mode	SAR Value (W/kg)		Power Drift (±5%)	Conducted power (dBm)	Tune-up power (dBm)	Scaled SAR 1g (W/Kg)	Date	Plot
			1g	10g						
1RB										
Front Side	40620/2593	20M QPSK(1,49)	0.366	0.208	-3.05	21.36	22.00	0.424	2024/12/11	
Back Side	40620/2593	20M QPSK(1,49)	0.605	0.351	-3.36	21.36	22.00	0.701	2024/12/11	28#
Left Side	40620/2593	20M QPSK(1,49)	0.183	0.102	-3.74	21.36	22.00	0.212	2024/12/11	
Right Side	40620/2593	20M QPSK(1,49)	0.192	0.109	2.32	21.36	22.00	0.222	2024/12/11	
Bottom Side	40620/2593	20M QPSK(1,49)	0.325	0.185	3.59	21.36	22.00	0.377	2024/12/11	
50%RB										
Front Side	40620/2593	20M QPSK(50,49)	0.207	0.124	-4.81	20.12	21.00	0.253	2024/12/11	
Back Side	40620/2593	20M QPSK(50,49)	0.330	0.187	3.84	20.12	21.00	0.404	2024/12/11	
Left Side	40620/2593	20M QPSK(50,49)	0.092	0.059	3.03	20.12	21.00	0.113	2024/12/11	
Right Side	40620/2593	20M QPSK(50,49)	0.105	0.063	-3.97	20.12	21.00	0.129	2024/12/11	

Bottom Side	40620/2593	20M QPSK(50,49)	0.192	0.094	2.46	20.12	21.00	0.235	2024/12/11	
-------------	------------	-----------------	-------	-------	------	-------	-------	-------	------------	--

< LTE Band 66 >

Test Position	Test channel /Freq.	Test Mode	SAR Value (W/kg)		Power Drift (±5%)	Conducted power (dBm)	Tune-up power (dBm)	Scaled SAR 1g (W/Kg)	Date	Plot
			1g	10g						
1RB										
Left Cheek	132322/1745	20M QPSK(1,0)	0.062	0.043	0.56	23.37	23.50	0.064	2024/11/21	29#
Left Tilt 15 Degree	132322/1745	20M QPSK(1,0)	0.036	0.024	3.37	23.37	23.50	0.037	2024/11/21	
Right Cheek	132322/1745	20M QPSK(1,0)	0.058	0.039	2.51	23.37	23.50	0.060	2024/11/21	
Right Tilt 15 Degree	132322/1745	20M QPSK(1,0)	0.029	0.019	-3.77	23.37	23.50	0.030	2024/11/21	
50%RB										
Left Cheek	132322/1745	20M QPSK(50,24)	0.037	0.022	3.88	22.14	22.50	0.040	2024/11/21	
Left Tilt 15 Degree	132322/1745	20M QPSK(50,24)	0.019	0.013	-4.84	22.14	22.50	0.021	2024/11/21	
Right Cheek	132322/1745	20M QPSK(50,24)	0.032	0.021	3.17	22.14	22.50	0.035	2024/11/21	
Right Tilt 15 Degree	132322/1745	20M QPSK(50,24)	0.016	0.010	-0.81	22.14	22.50	0.017	2024/11/21	

Test Position of Hotspot with 10mm	Test channel /Freq.	Test Mode	SAR Value (W/kg)		Power Drift (±5%)	Conducted power (dBm)	Tune-up power (dBm)	Scaled SAR 1g (W/Kg)	Date	Plot
			1g	10g						
1RB										
Front Side	132322/1745	20M QPSK(1,0)	0.252	0.142	-3.34	23.37	23.50	0.260	2024/11/21	

Back Side	132322/1745	20M QPSK(1,0)	0.375	0.222	1.28	23.37	23.50	0.386	2024/11/21	30#
Left Side	132322/1745	20M QPSK(1,0)	0.117	0.066	-2.73	23.37	23.50	0.121	2024/11/21	
Right Side	132322/1745	20M QPSK(1,0)	0.126	0.072	-3.04	23.37	23.50	0.130	2024/11/21	
Bottom Side	132322/1745	20M QPSK(1,0)	0.205	0.118	-3.86	23.37	23.50	0.211	2024/11/21	
50%RB										
Front Side	132322/1745	20M QPSK(50,24)	0.131	0.081	3.68	22.14	22.50	0.142	2024/11/21	
Back Side	132322/1745	20M QPSK(50,24)	0.192	0.128	-3.41	22.14	22.50	0.209	2024/11/21	
Left Side	132322/1745	20M QPSK(50,24)	0.064	0.038	3.09	22.14	22.50	0.070	2024/11/21	
Right Side	132322/1745	20M QPSK(50,24)	0.065	0.038	-1.42	22.14	22.50	0.071	2024/11/21	
Bottom Side	132322/1745	20M QPSK(50,24)	0.114	0.070	-0.77	22.14	22.50	0.124	2024/11/21	

< WiFi 2.4G >

Test Position	Test channel /Freq.	Test Mode	SAR Value (W/kg)		Power Drift (±5%)	Conducted power (dBm)	Tune-up power (dBm)	Scaled SAR 1g (W/Kg)	Date	Plot
			1g	10g						
Left Cheek	1/2412	802.11b	0.357	0.224	4.98	19.33	20.00	0.417	2024/11/28	13#
Left Cheek	1/2412	802.11n HT20	0.312	0.209	0.02	22.78	23.00	0.328	2024/11/28	
Left Tilt 15 Degree	1/2412	802.11b	0.190	0.116	0.65	19.33	20.00	0.222	2024/11/28	
Right Cheek	1/2412	802.11b	0.337	0.209	-1.43	19.33	20.00	0.393	2024/11/28	
Right Tilt 15 Degree	1/2412	802.11b	0.178	0.111	-2.47	19.33	20.00	0.208	2024/11/28	

Test Position	Test channel /Freq.	Test Mode	SAR Value (W/kg)	Power Drift	Conducted power	Tune-up power	Scaled SAR	Date	Plot
---------------	---------------------	-----------	------------------	-------------	-----------------	---------------	------------	------	------

of Hotspot with 10mm			1g	10g	(±5%)	(dBm)	(dBm)	1g (W/Kg)		
Front Side	1/2412	802.11b	0.120	0.081	-1.22	19.33	20.00	0.140	2024/11/28	
Back Side	1/2412	802.11b	0.191	0.136	4.92	19.33	20.00	0.223	2024/11/28	14#
Back Side	1/2412	802.11n HT20	0.174	0.120	1.02	22.78	23.00	0.183	2024/11/28	
Left Side	1/2412	802.11b	0.063	0.043	0.27	19.33	20.00	0.074	2024/11/28	
Top Side	1/2412	802.11b	0.069	0.047	3.24	19.33	20.00	0.081	2024/11/28	

< WiFi 5.2G >

Test Position	Test channel /Freq.	Test Mode	SAR Value (W/kg)		Power Drift (±5%)	Conducted power (dBm)	Tune-up power (dBm)	Scaled SAR 1g (W/Kg)	Date	Plot
			1g	10g						
Left Cheek	39/5190	802.11N40	0.427	0.367	4.05	8.10	8.50	0.468	2024/12/4	9#
Left Tilt 15 Degree	39/5190	802.11N40	0.248	0.202	0.83	8.10	8.50	0.272	2024/12/4	
Right Cheek	39/5190	802.11N40	0.365	0.304	-2.77	8.10	8.50	0.400	2024/12/4	
Right Tilt 15 Degree	39/5190	802.11N40	0.195	0.164	-0.93	8.10	8.50	0.214	2024/12/4	

Test Position of Hotspot with 10mm	Test channel /Freq.	Test Mode	SAR Value (W/kg)		Power Drift (±5%)	Conducted power (dBm)	Tune-up power (dBm)	Scaled SAR 1g (W/Kg)	Date	Plot
			1g	10g						
Front Side	39/5190	802.11N40	0.258	0.199	3.81	8.10	8.50	0.283	2024/12/4	
Back	39/5190	802.11N40	0.407	0.331	-0.03	8.10	8.50	0.446	2024/12/4	11#

Side										
Left Side	39/5190	802.11N40	0.132	0.102	-1.28	8.10	8.50	0.145	2024/12/4	
Top Side	39/5190	802.11N40	0.135	0.109	2.37	8.10	8.50	0.148	2024/12/4	

< WiFi 5.8G >

Test Position	Test channel /Freq.	Test Mode	SAR Value (W/kg)		Power Drift (±5%)	Conducted power (dBm)	Tune-up power (dBm)	Scaled SAR 1g (W/Kg)	Date	Plot
			1g	10g						
Left Cheek	149/5745	802.11a	0.533	0.400	-4.79	11.25	11.50	0.565	2024/12/5	10#
Left Tilt 15 Degree	149/5745	802.11a	0.283	0.202	-1.52	11.25	11.50	0.300	2024/12/5	
Right Cheek	149/5745	802.11a	0.466	0.332	-0.99	11.25	11.50	0.494	2024/12/5	
Right Tilt 15 Degree	149/5745	802.11a	0.237	0.169	-0.15	11.25	11.50	0.251	2024/12/5	

Test Position of Hotspot with 10mm	Test channel /Freq.	Test Mode	SAR Value (W/kg)		Power Drift (±5%)	Conducted power (dBm)	Tune-up power (dBm)	Scaled SAR 1g (W/Kg)	Date	Plot
			1g	10g						
Front Side	149/5745	802.11a	0.324	0.263	-1.30	11.25	11.50	0.343	2024/12/5	
Back Side	149/5745	802.11a	0.498	0.404	0.62	11.25	11.50	0.528	2024/12/5	12#
Left Side	149/5745	802.11a	0.156	0.127	2.74	11.25	11.50	0.165	2024/12/5	
Top Side	149/5745	802.11a	0.150	0.120	-3.82	11.25	11.50	0.159	2024/12/5	