

802.11be-EHT20 - Ant 0 (Nss = 2)

Channel 33 (6115MHz)

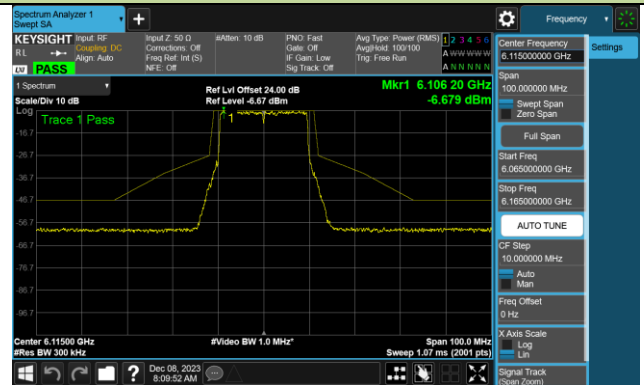

Channel 61 (6255MHz)

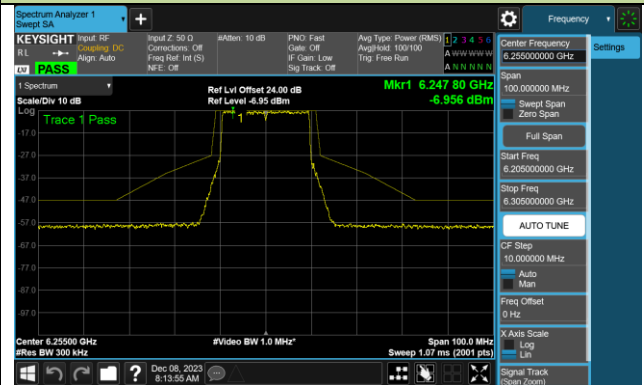

Channel 93 (6415MHz)

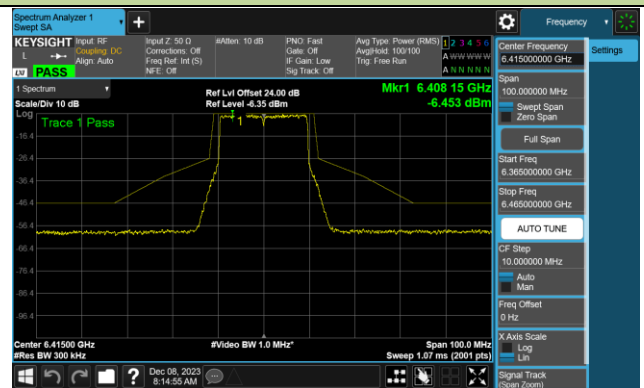

Channel 97 (6435MHz)

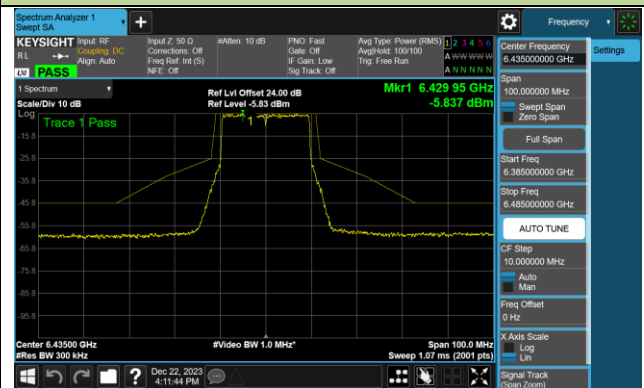

Channel 105 (6475MHz)

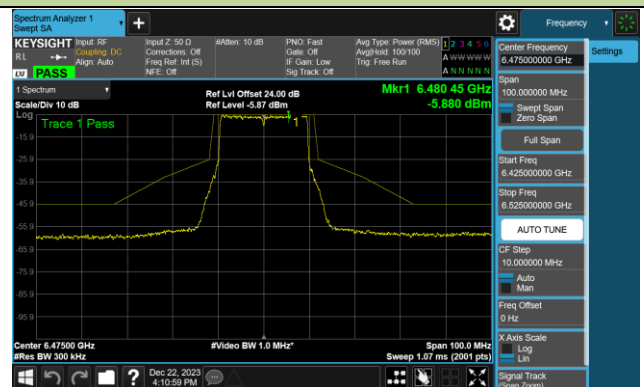

Channel 113 (6515MHz)

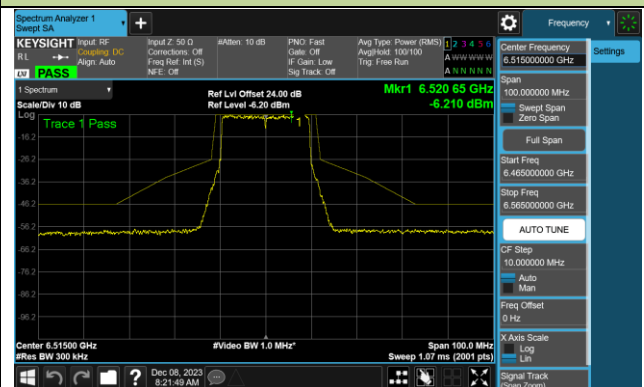

Channel 117 (6535MHz)

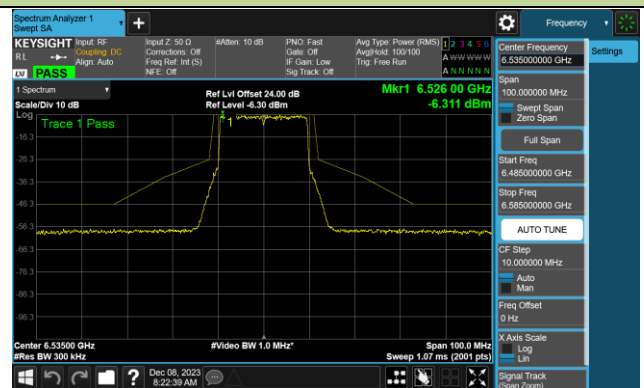

Channel 149 (6695MHz)

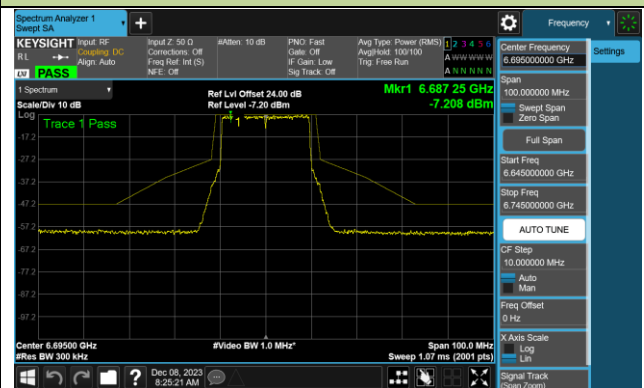

802.11be-EHT20 - Ant 0 (Nss = 2)

Channel 181 (6855MHz)

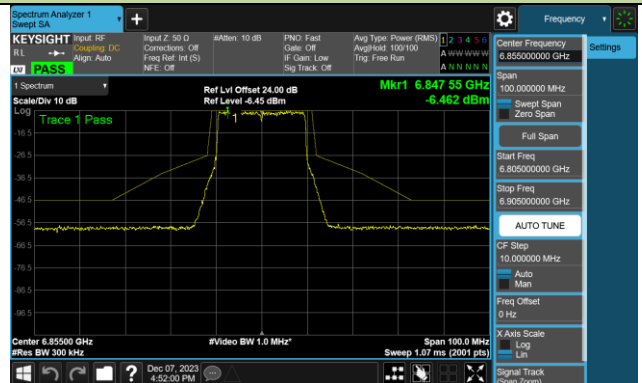

Channel 185 (6875MHz)

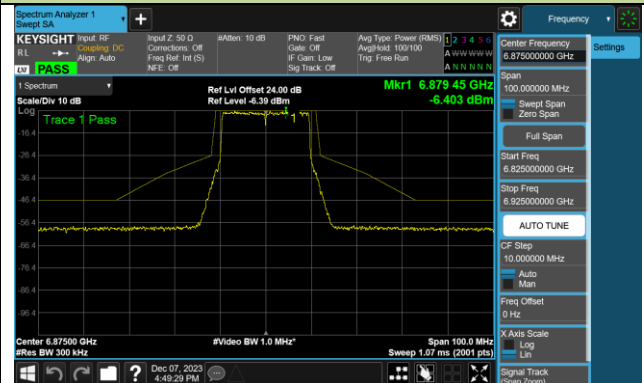

Channel 189 (6895MHz)

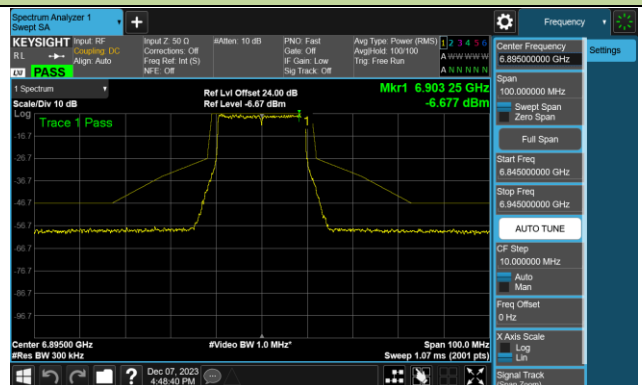

Channel 213 (7015MHz)

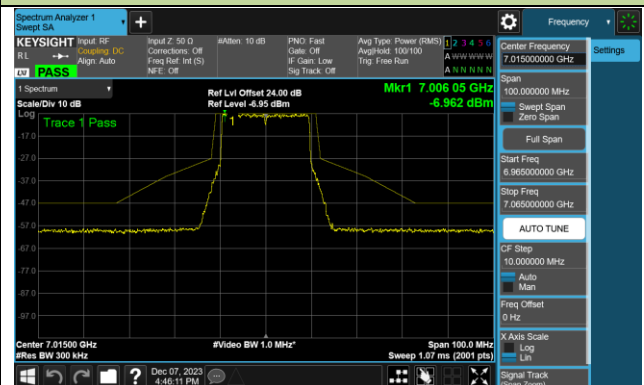

Channel 229 (7095MHz)

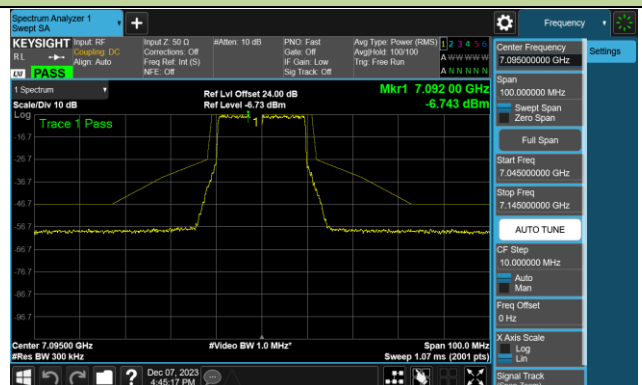

802.11be-EHT320 - Ant 0 (Nss = 2)

Channel 63 (6265MHz)



Channel 95 (6425MHz)

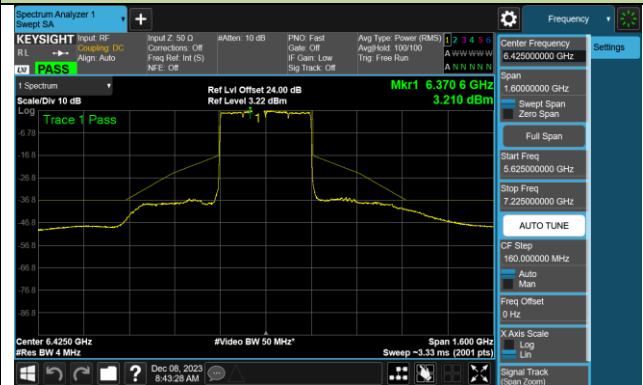

Channel 127 (6585MHz)



Channel 159 (6745MHz)

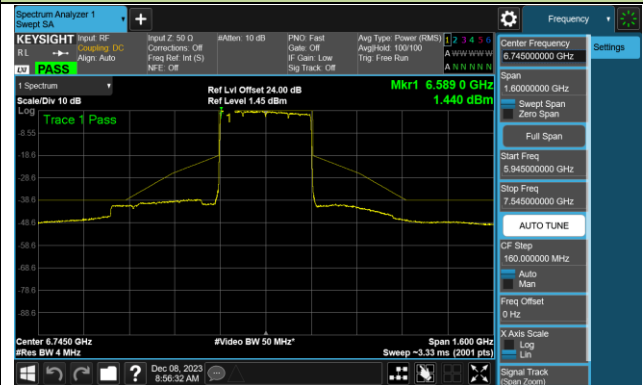

Channel 191 (6905MHz)



802.11ax-HE20 - Ant 1 (Nss = 2)

Channel 33 (6115MHz)

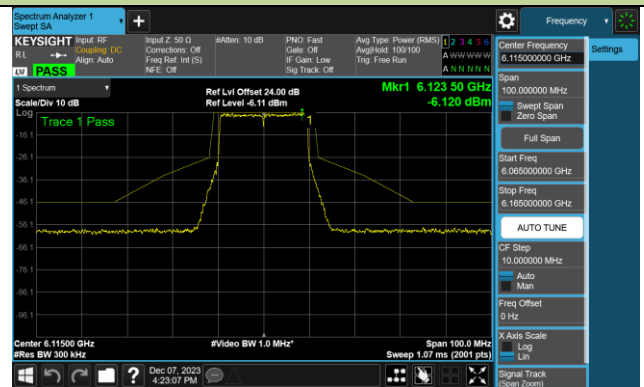

Channel 61 (6255MHz)

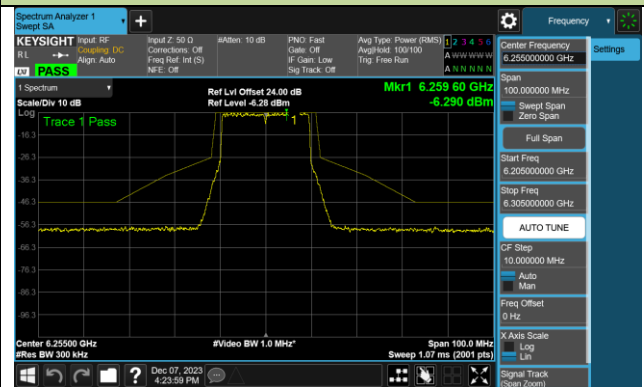

Channel 93 (6415MHz)

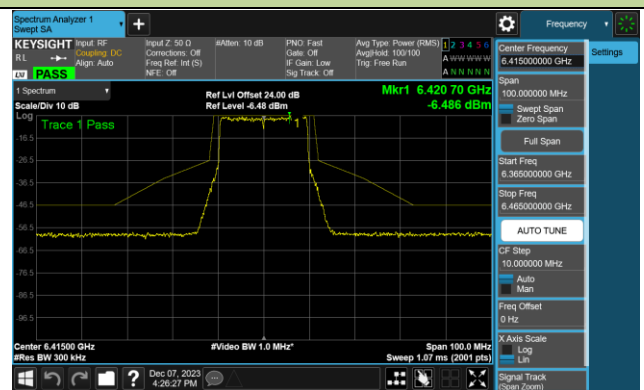

Channel 97 (6435MHz)

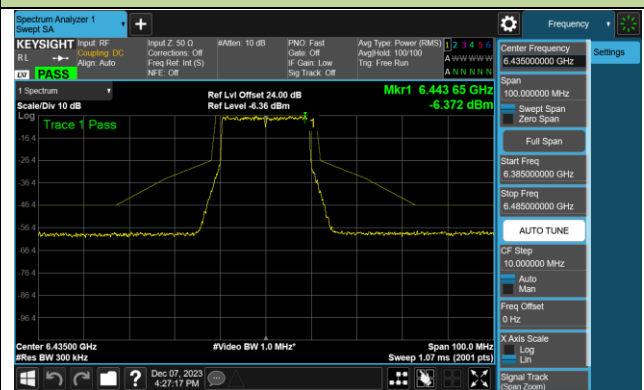

Channel 105 (6475MHz)

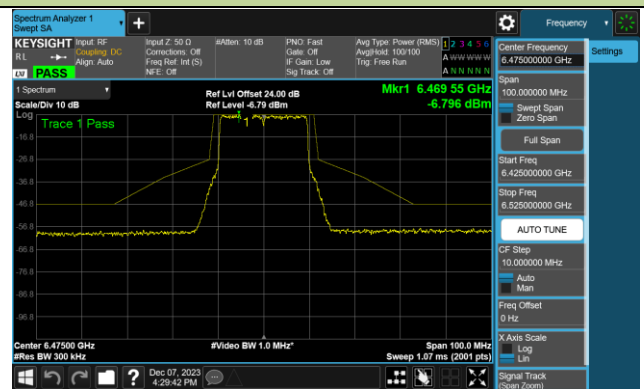

Channel 113 (6515MHz)

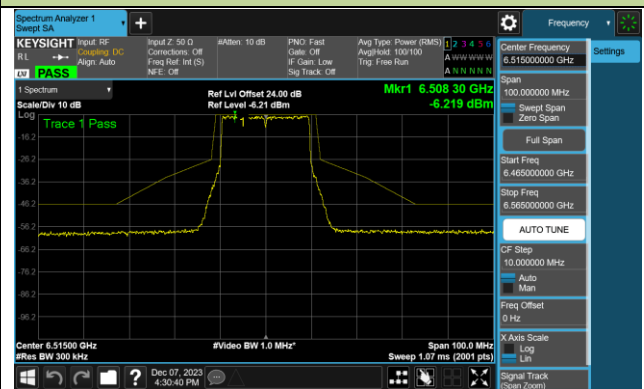

Channel 117 (6535MHz)

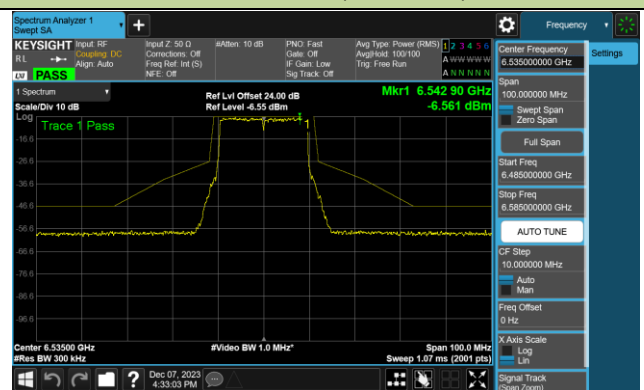

Channel 149 (6695MHz)

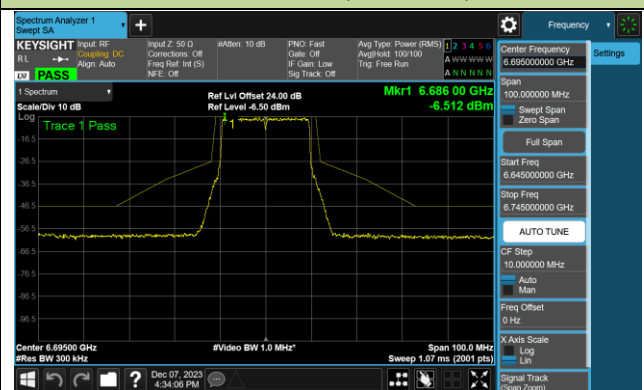

802.11ax-HE20 - Ant 1 (Nss = 2)

Channel 181 (6855MHz)

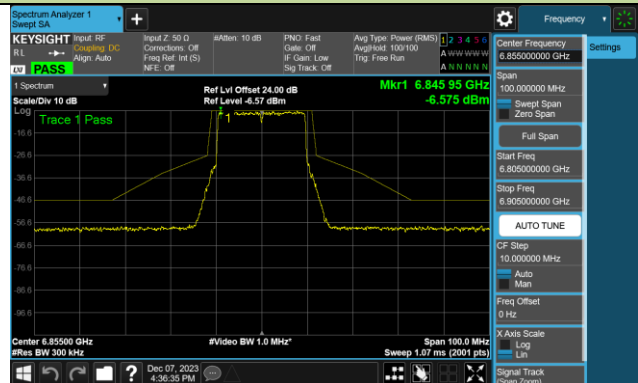

Channel 185 (6875MHz)

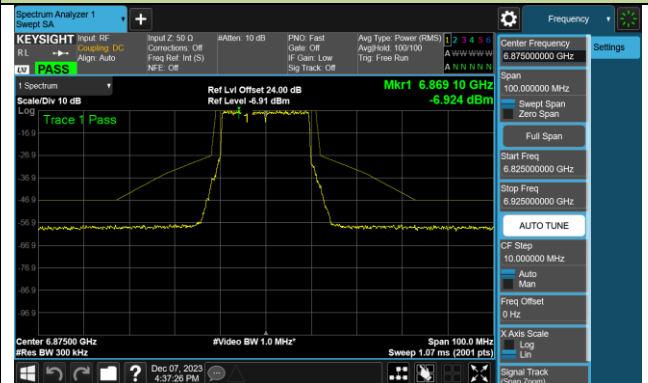

Channel 189 (6895MHz)

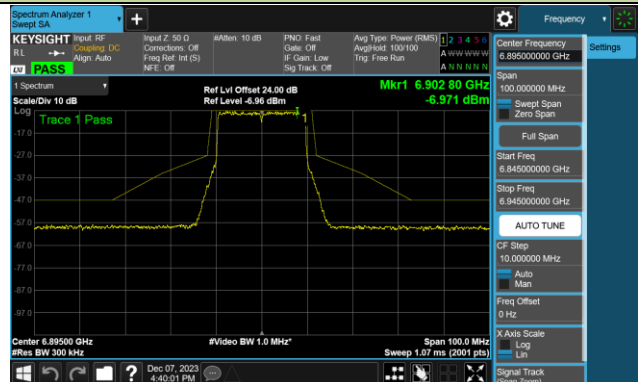

Channel 213 (7015MHz)

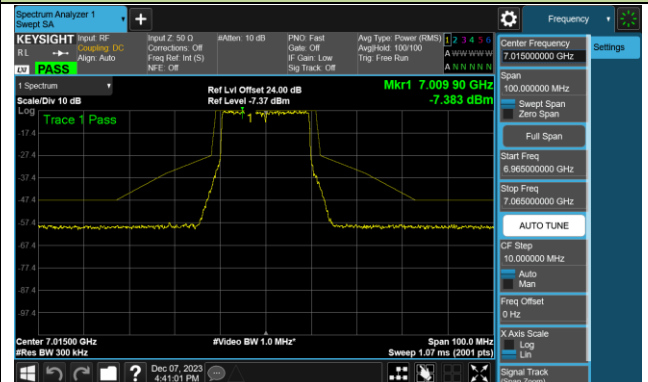

Channel 229 (7095MHz)

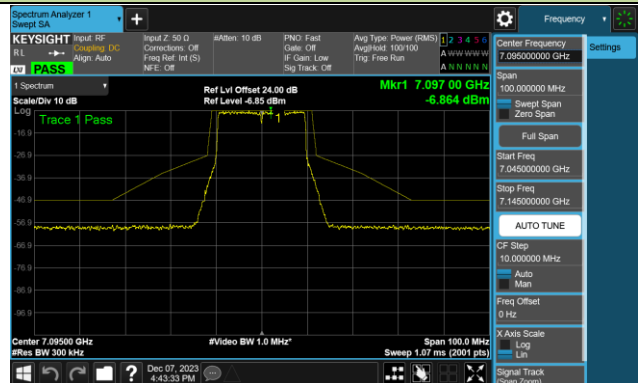

802.11be-EHT20 - Ant 1 (Nss = 2)

Channel 33 (6115MHz)

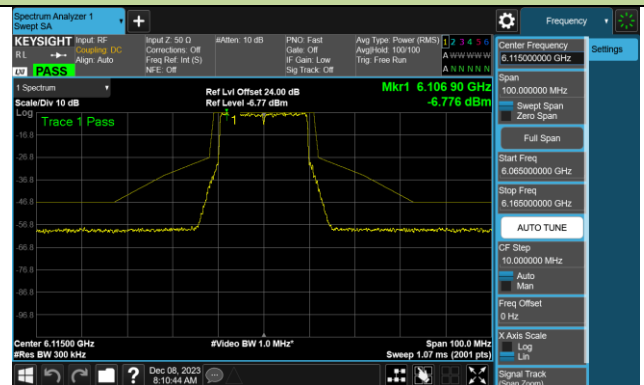

Channel 61 (6255MHz)

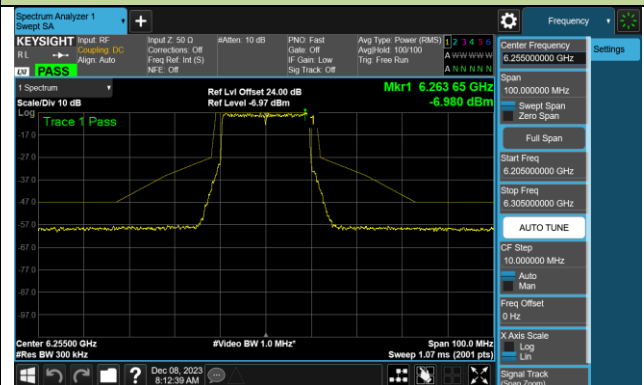

Channel 93 (6415MHz)

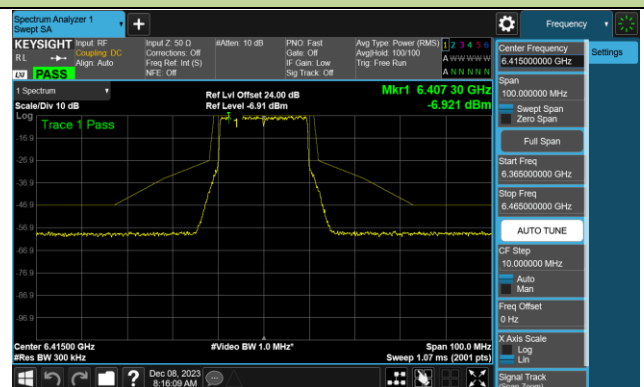

Channel 97 (6435MHz)

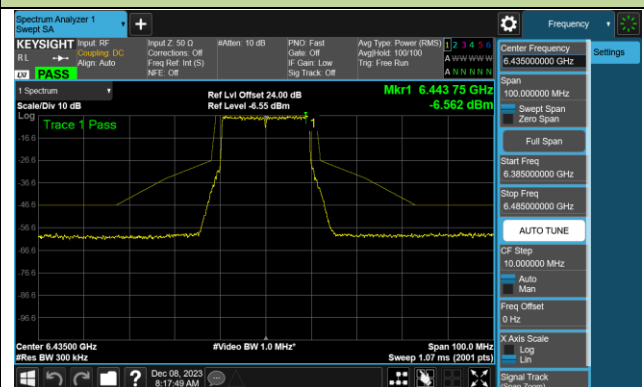

Channel 105 (6475MHz)

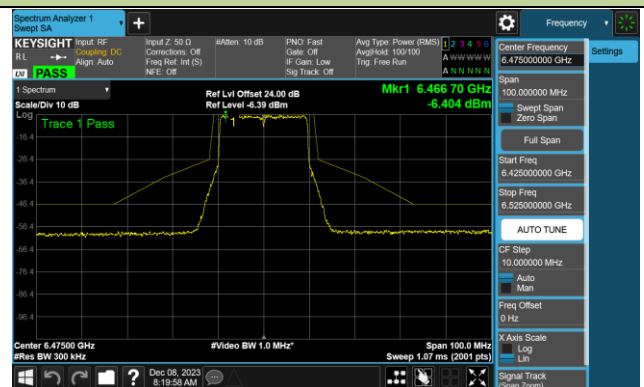

Channel 113 (6515MHz)

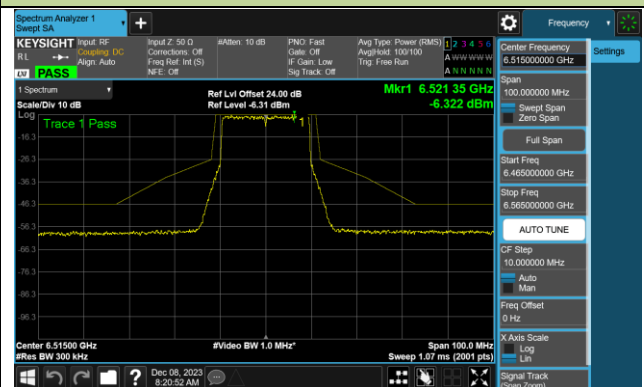

Channel 117 (6535MHz)

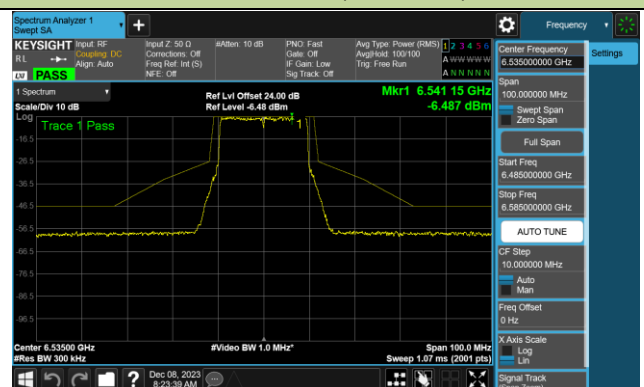

Channel 149 (6695MHz)

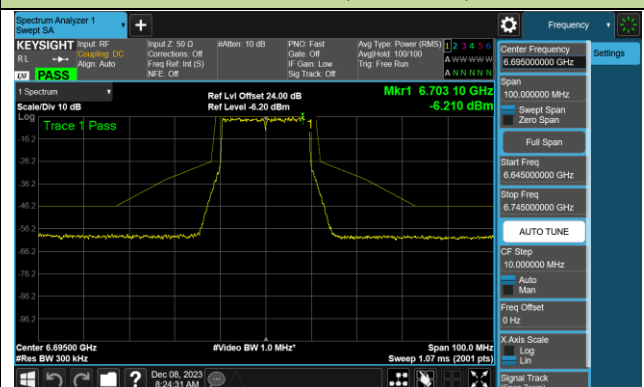

802.11be-EHT20 - Ant 1 (Nss = 2)

Channel 181 (6855MHz)

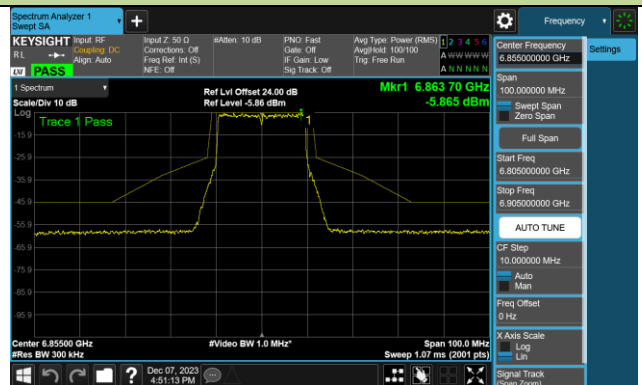

Channel 185 (6875MHz)

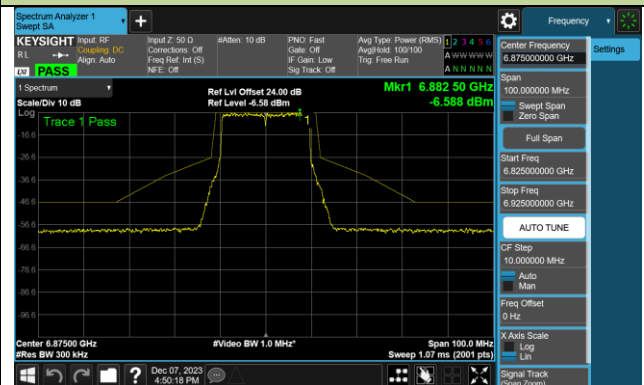

Channel 189 (6895MHz)

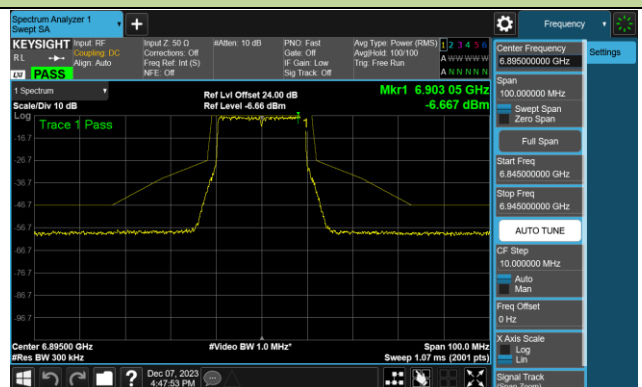

Channel 213 (7015MHz)

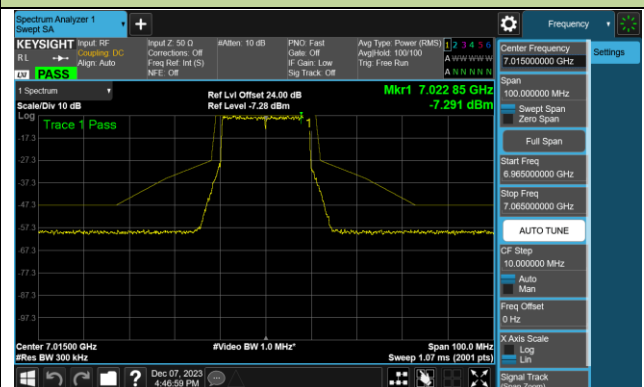

Channel 229 (7095MHz)

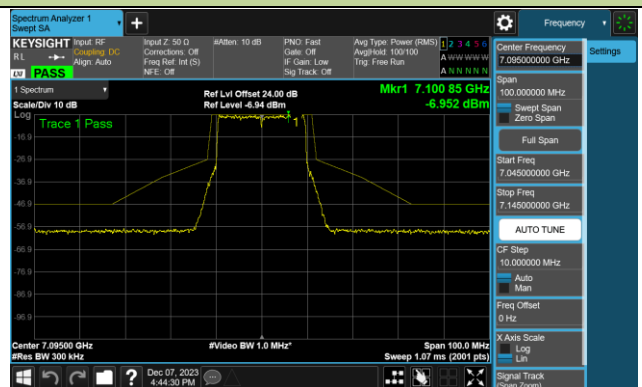

802.11be-EHT320 - Ant 1 (Nss = 2)

Channel 63 (6265MHz)



Channel 95 (6425MHz)

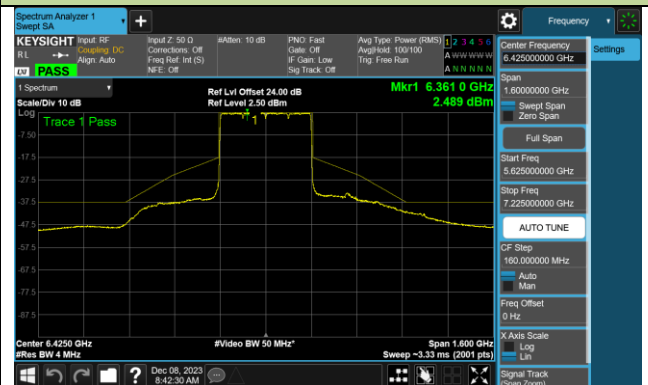

Channel 127 (6585MHz)

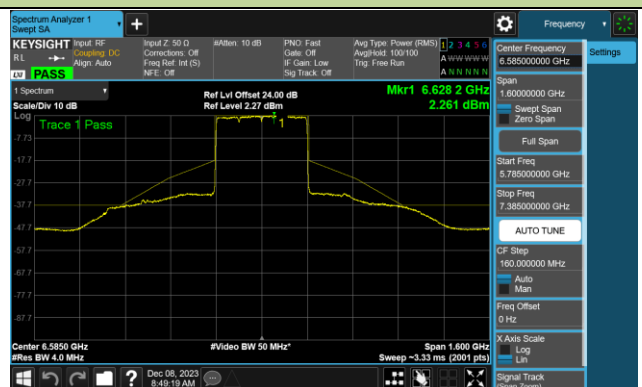

Channel 159 (6745MHz)

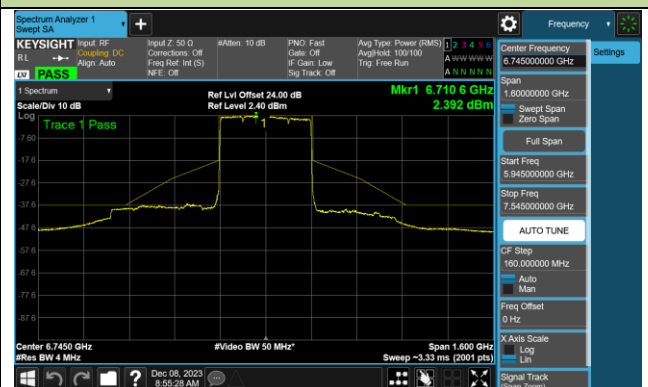

Channel 191 (6905MHz)

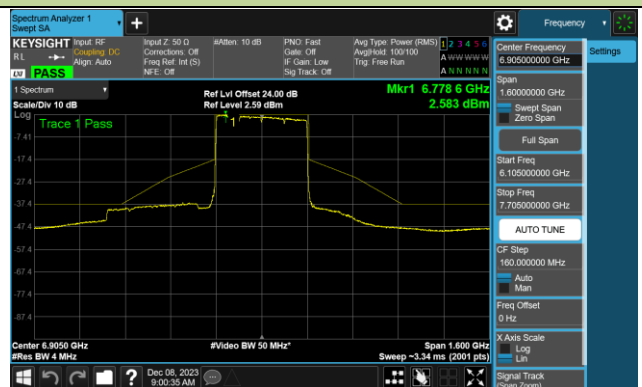

6.6. Frequency Stability Measurement

6.6.1. Test Limit

Manufacturers of U-NII devices are responsible for ensuring frequency stability such that an emission is maintained within the band of operation under all conditions of normal operation as specified in the user's manual.

6.6.2. Test Procedure

Frequency Stability Under Temperature Variations:

The equipment under test was connected to an external AC or DC power supply and input rated voltage. RF output was connected to a frequency counter or spectrum analyzer via feed through attenuators. The EUT was placed inside the temperature chamber. Set the spectrum analyzer RBW low enough to obtain the desired frequency resolution and measure EUT 20°C operating frequency as reference frequency. Turn EUT off and set the chamber temperature to highest. After the temperature stabilized for approximately 30 minutes recorded the frequency. Repeat step measure with 10°C decreased per stage until the lowest temperature reached.

Frequency Stability Under Voltage Variations:

Set chamber temperature to 20°C. Use a variable AC power supply / DC power source to power the EUT and set the voltage to rated voltage. Set the spectrum analyzer RBW low enough to obtain the desired frequency resolution and recorded the frequency.

Reduce the input voltage to specify extreme voltage variation ($\pm 15\%$) and endpoint, record the maximum frequency change.

6.6.3. Test Setup

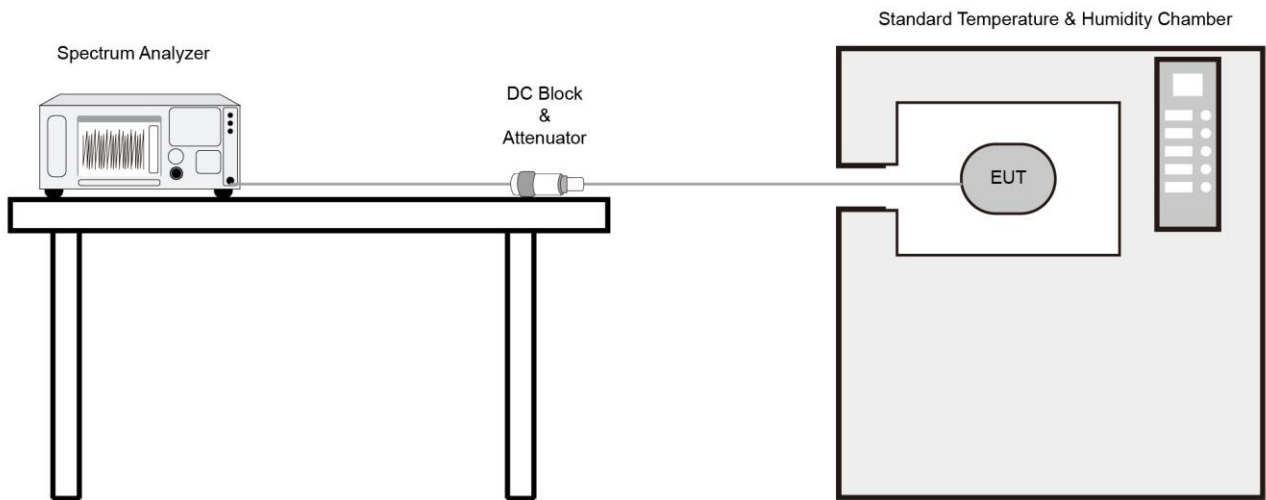

6.6.4. Test Result

Test Site	SR3	Test Engineer	Xuan
Test Date	2023/12/12		
Test Mode	6115MHz (Carrier Mode)		

Voltage (%)	Power (VAC)	Temp (°C)	Frequency Tolerance (ppm)			
			0 minutes	2 minutes	5 minutes	10 minutes
100	120	- 30	6.23	6.35	6.30	6.12
		- 20	9.21	9.11	8.99	8.91
		- 10	10.11	10.02	10.02	10.01
		0	8.65	8.60	8.50	8.49
		+ 10	7.16	6.74	6.44	6.18
		+ 20	-0.11	-0.21	-0.29	-0.34
		+ 30	-5.89	-5.79	-5.71	-5.63
		+ 40	-6.61	-6.49	-6.51	-6.54
		+ 50	-6.07	-6.31	-6.48	-6.62
115	138	+ 20	-0.44	-0.47	-0.51	-0.54
85	102	+ 20	-0.56	-0.57	-0.61	-0.62

Note: Frequency Tolerance (ppm) = {[Measured Frequency (Hz) - Declared Frequency (Hz)] / Declared Frequency (Hz)} *10⁶.

6.7. Contention Based Protocol

6.7.1. Test Limit

Unlicensed indoor low power device must detect co-channel radio frequency power that is at least -62dBm (The threshold is referenced to a 0dBi antenna gain.) or low.

Indoor low power device must detect an AWGN signal with 90% (or better) level of certainty.

6.7.2. Test Procedure Used

KDB 987594 D02v02r01- Section I

6.7.3. Test Setting

1. Configure the EUT to transmit with a constant duty cycle.
2. Set the operating parameters of the EUT including power level, operating frequency, modulation and bandwidth.
3. Set the signal analyzer center frequency to the nominal EUT channel center frequency. The span range of the signal analyzer shall be between two times and five times the OBW of the EUT.
Connect the output port of the EUT to the signal analyzer 2. Ensure that the attenuator 2 provides enough attenuation to not overload the signal analyzer 2 receiver.
4. Monitoring the signal analyzer 2, verify the EUT is operating and transmitting with the parameters set at step two.
5. Using an AWGN signal source, generate a 10 MHz-wide AWGN signal. Use Table 1 of KDB 987594 to determine the center frequency of the 10 MHz AWGN signal relative to the EUT's channel bandwidth and center frequency.
6. Set the AWGN signal power to an extremely low level. Connect the AWGN signal source, via a 3-dB splitter, to the signal analyzer 1 and the EUT as shown in below figure.
7. Transmit the AWGN signal (RF ON) and verify its characteristics on the signal analyzer 1.
8. Monitor the signal analyzer 2 to verify if the AWGN signal has been detected and the EUT has ceased transmission. If the EUT continues to transmit, then incrementally increase the AWGN signal power level until the EUT stops transmitting.

9. Determine and record the AWGN signal power level (at the EUT's antenna port) at which the EUT ceased transmission. Repeat the procedure at least 10 times to verify the EUT can detect an AWGN signal with 90% (or better) level of certainty.

10. Refer to Table 1 to determine number of times the detection threshold testing needs to be repeated. If testing is required more than once, then go back to step 5, choose a different center frequency for the AWGN signal and repeat the process.

6.7.4. Test Setup

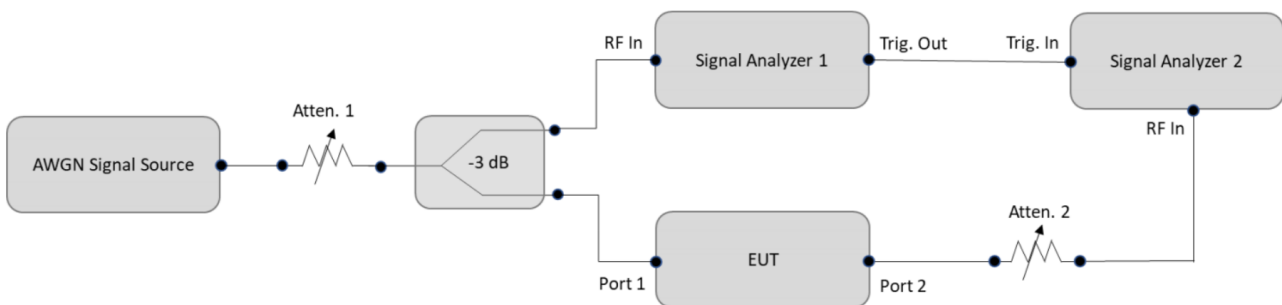

6.7.5. Test Result

Test Site	SR5	Test Engineer	Parker
Test Mode	6ID (Low-Power indoor AP)	Test Date	2024/1/2

Test Channel	Bandwidth (MHz)	Freq. (MHz)	AWGN Freq. (MHz)	AWGN Power (dBm)	Ant. Gain (dBi)	Adjust Power (dBm)	Detection Limit (dBm)	Detected Number	Detection Probability (%)	Limit (%)	Test Result
Operation Band: U-NII 5											
33	20	6115	6115	-62.00	3.00	-65.00	≤ -62.0	10	100	90	Pass
63	320	6265	6110	-62.00	3.00	-65.00	≤ -62.0	10	100	90	Pass
63	320	6265	6265	-59.00	3.00	-62.00	≤ -62.0	10	100	90	Pass
63	320	6265	6420	-59.00	3.00	-62.00	≤ -62.0	10	100	90	Pass
Operation Band: U-NII 6											
97	20	6435	6435	-59.00	3.00	-62.00	≤ -62.0	10	100	90	Pass
103	80	6465	6430	-59.00	3.00	-62.00	≤ -62.0	10	100	90	Pass
103	80	6465	6465	-59.00	3.00	-62.00	≤ -62.0	10	100	90	Pass
103	80	6465	6500	-59.00	3.00	-62.00	≤ -62.0	10	100	90	Pass
Operation Band: U-NII 7											
181	20	6855	6855	-59.00	3.00	-62.00	≤ -62.0	10	100	90	Pass
191	320	6905	6750	-59.00	3.00	-62.00	≤ -62.0	10	100	90	Pass
191	320	6905	6905	-59.00	3.00	-62.00	≤ -62.0	10	100	90	Pass
191	320	6905	7060	-59.00	3.00	-62.00	≤ -62.0	10	100	90	Pass
Operation Band: U-NII 8											
213	20	7015	7015	-59.00	3.00	-62.00	≤ -62.0	10	100	90	Pass
207	160	6985	6910	-62.00	3.00	-65.00	≤ -62.0	10	100	90	Pass
207	160	6985	6985	-59.00	3.00	-62.00	≤ -62.0	10	100	90	Pass
207	160	6985	7060	-59.00	3.00	-62.00	≤ -62.0	10	100	90	Pass

Note 1: Adjust Power (dBm) = AWGN Power (dBm) – Antenna Gain (dBi).

Note 2: Conducted measurements are used.

Bandwidth (MHz)	Freq. (MHz)	AWGN Freq. (MHz)	Adjust Power (dBm)	EUT Tx Status
Operation Band: U-NII 5				
20	6115	6115	-75	ON
			-63	Minimal
			-62	OFF
320	6265	6110	-75	ON
			-63	Minimal
			-62	OFF
320	6265	6265	-75	ON
			-60	Minimal
			-59	OFF
320	6265	6420	-75	ON
			-60	Minimal
			-59	OFF
Operation Band: U-NII 6				
20	6435	6435	-75	ON
			-60	Minimal
			-59	OFF
80	6465	6430	-75	ON
			-60	Minimal
			-59	OFF
80	6465	6465	-75	ON
			-60	Minimal
			-59	OFF
80	6465	6500	-75	ON
			-60	Minimal
			-59	OFF

Bandwidth (MHz)	Freq. (MHz)	AWGN Freq. (MHz)	Adjust Power (dBm)	EUT Status
Operation Band: U-NII 7				
20	6695	6695	-75	ON
			-60	Minimal
			-59	OFF
320	6905	6750	-75	ON
			-60	Minimal
			-59	OFF
320	6905	6905	-75	ON
			-60	Minimal
			-59	OFF
320	6905	7060	-75	ON
			-60	Minimal
			-59	OFF
Operation Band: U-NII 8				
20	7015	7015	-75	ON
			-60	Minimal
			-59	OFF
160	6985	6910	-75	ON
			-63	Minimal
			-62	OFF
160	6985	6985	-75	ON
			-60	Minimal
			-59	OFF
160	6985	7060	-75	ON
			-60	Minimal
			-59	OFF
Note: OFF: AWGN level at which no transmission is detected, consistently for a minimum period of 10 seconds Minimal: AWGN level at which the system begins to trigger the transmission switch-off, albeit not being kept off consistently ON: AWGN level at which no impact on the transmission is detected, consistently for a minimum period of 10 seconds				

AWGN Signal Level (at Antenna Port) Calibration Plots (NII-5 Band) _6ID (Low-Power indoor AP)

802.11be-HET20 / CH33

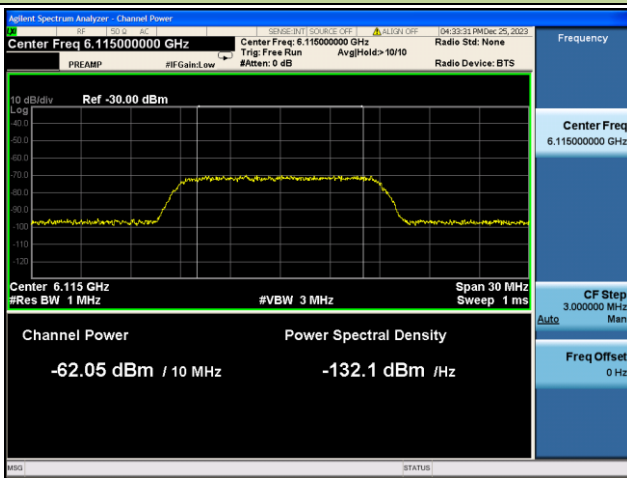

802.11 be-HET320 / CH63 (Low Edge)

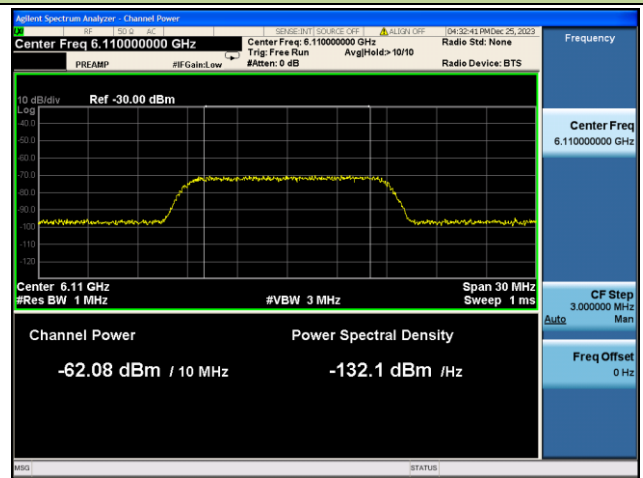

802.11 be-HET320 / CH63 (Middle)

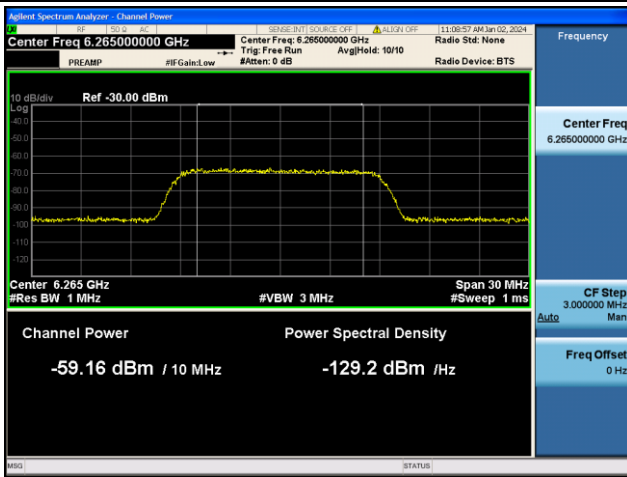

802.11 be-HET320 / CH63 (High Edge)

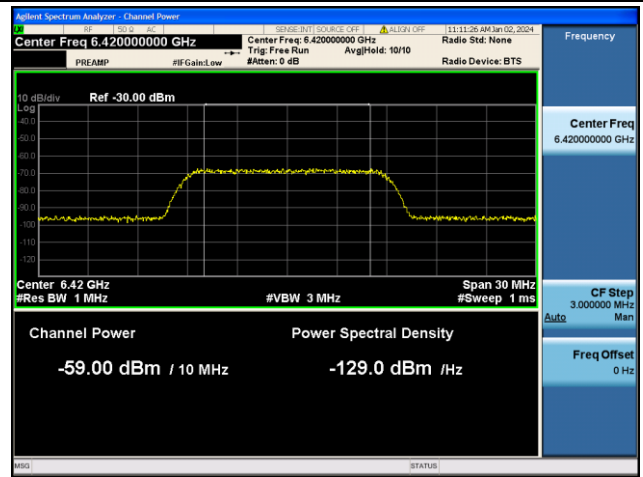

AWGN Signal Level (at Antenna Port) Calibration Plots (NII-6 Band) _6ID (Low-Power indoor AP)

802.11 be-HET20 / CH97

802.11 be-HET80 / CH103 (Low Edge)

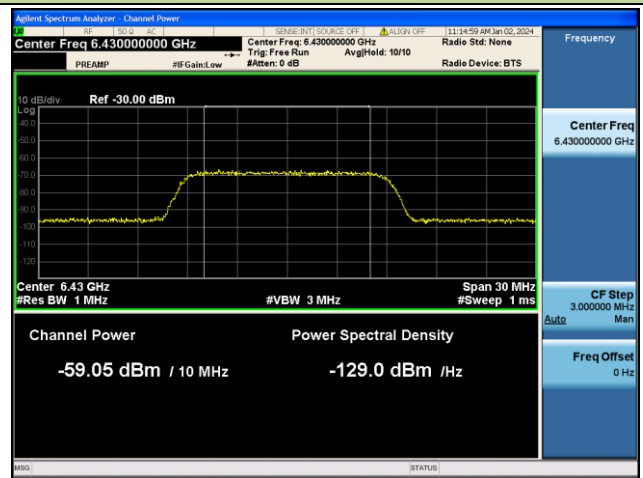
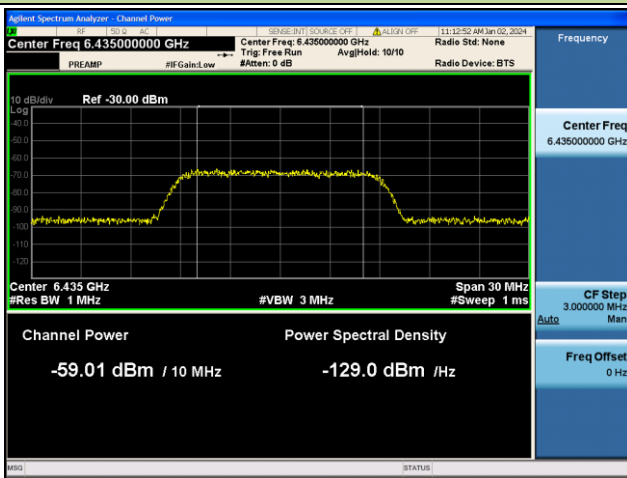

802.11 be-HET80 / CH103 (Middle)

802.11 be-HET80 / CH103 (High Edge)

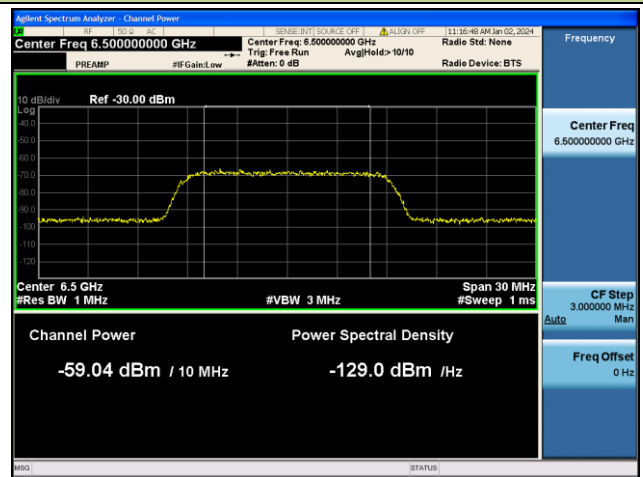
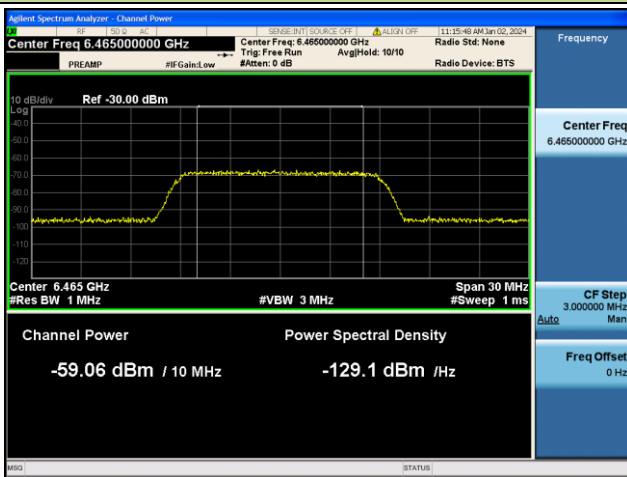

AWGN Signal Level (at Antenna Port) Calibration Plots (NII-7 Band) _6ID (Low-Power indoor AP)

802.11 be-HET20 / CH181

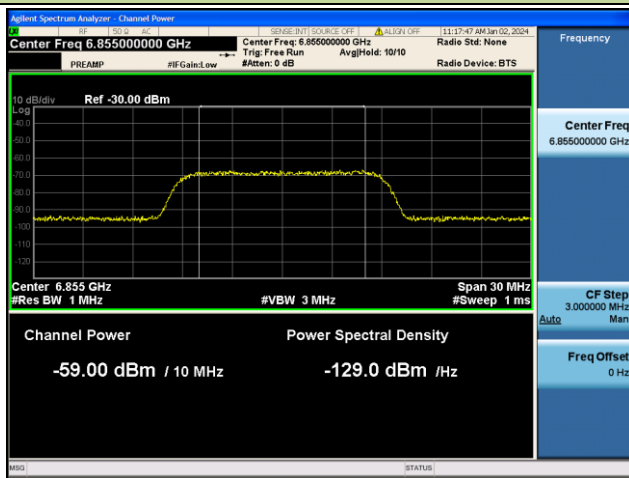

802.11 be-HET320 / CH191 (Low Edge)

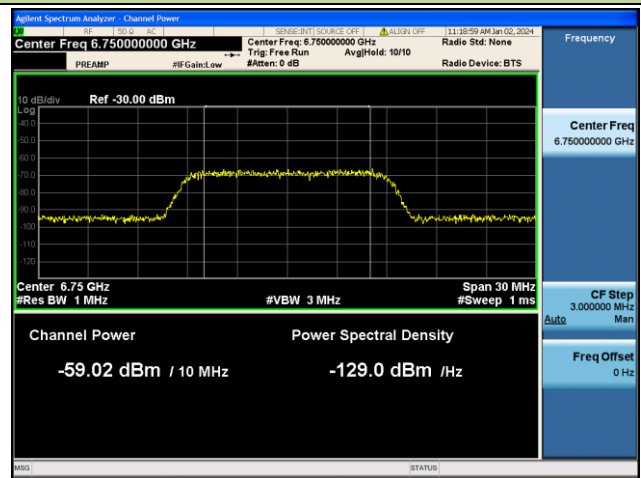

802.11 be-HET320 / CH191 (Middle)

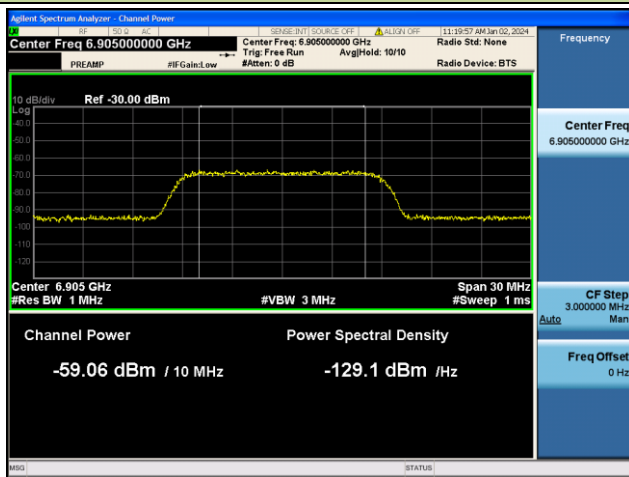

802.11 be-HET320 / CH191 (High Edge)

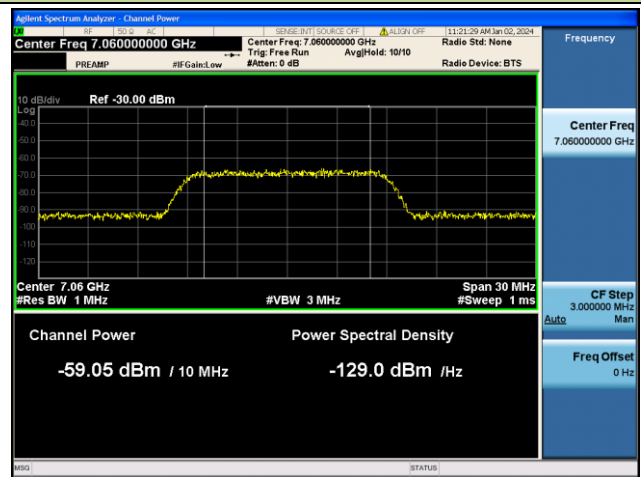

AWGN Signal Level (at Antenna Port) Calibration Plots (NII-8 Band) _6ID (Low-Power indoor AP)

802.11 be-HET20 / CH213

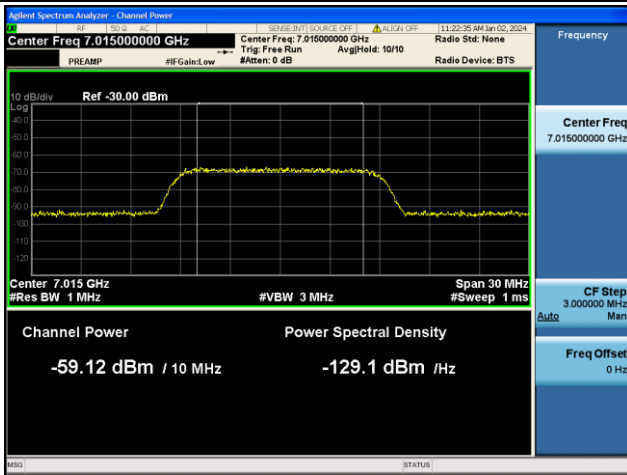

802.11 be-HET160 / CH191 (Low Edge)

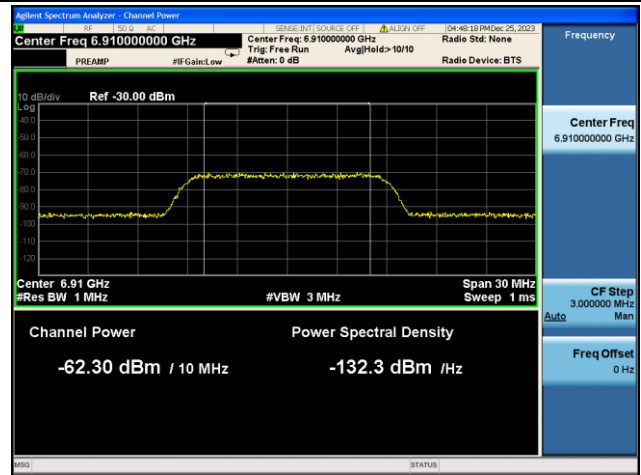

802.11 be-HET320 / CH191 (Middle)

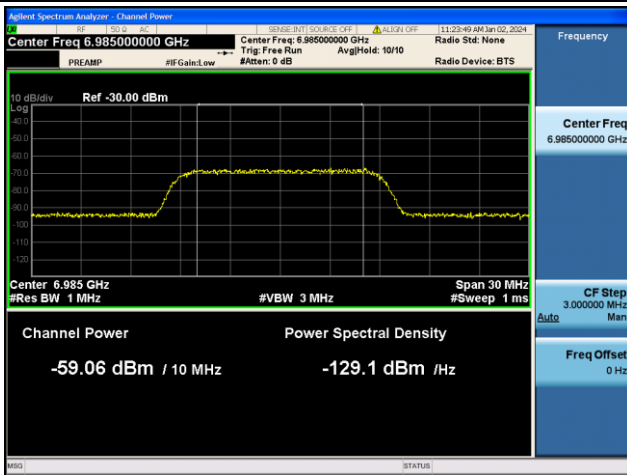

802.11 be-HET320 / CH191 (High Edge)

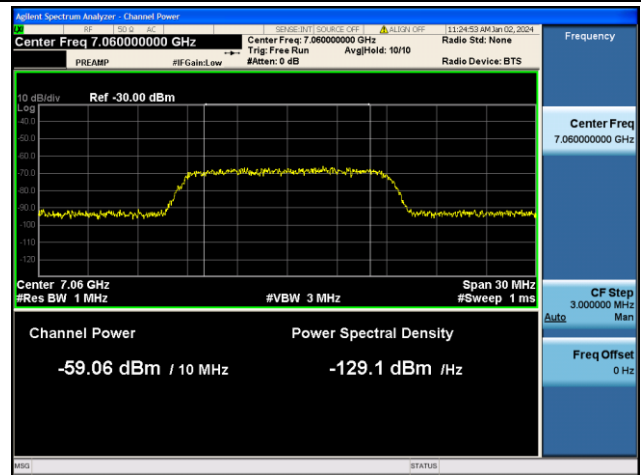

Test Result of EUT ceased transmission (NII-5 Band) _6ID (Low-Power indoor AP)

802.11 be-HET20 / CH33

802.11be-HET 320 / CH63 (Low Edge)

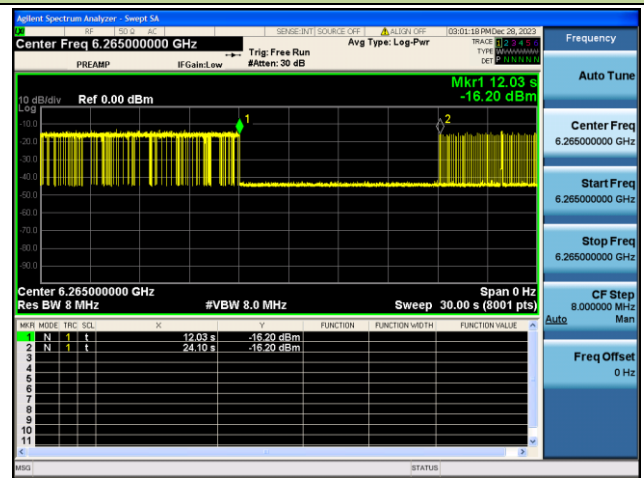
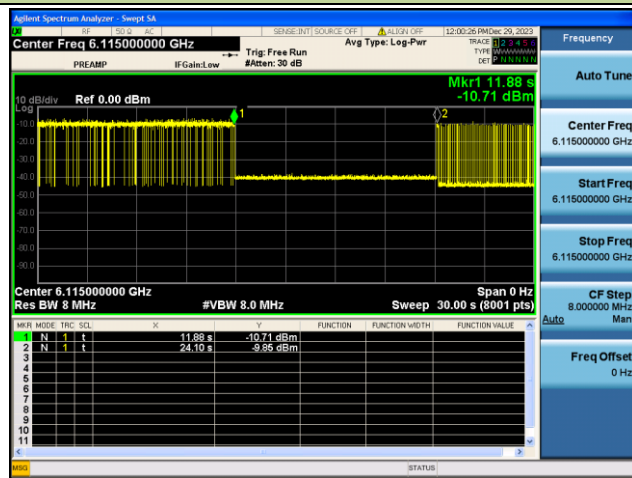

802.11be-HET320 / CH63 (Middle)

802.11be-HET320 / CH63 (High Edge)

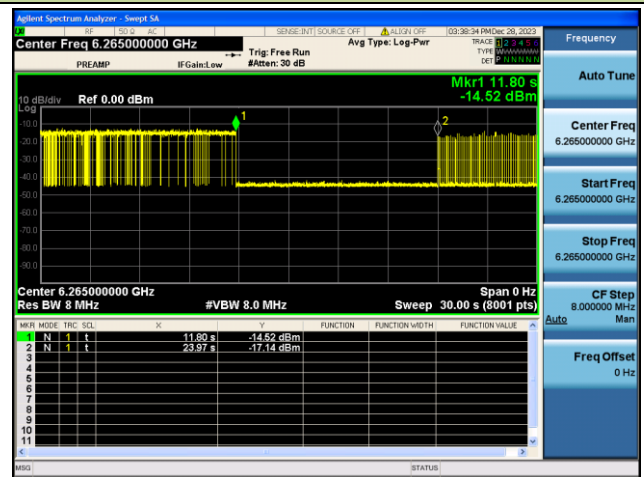
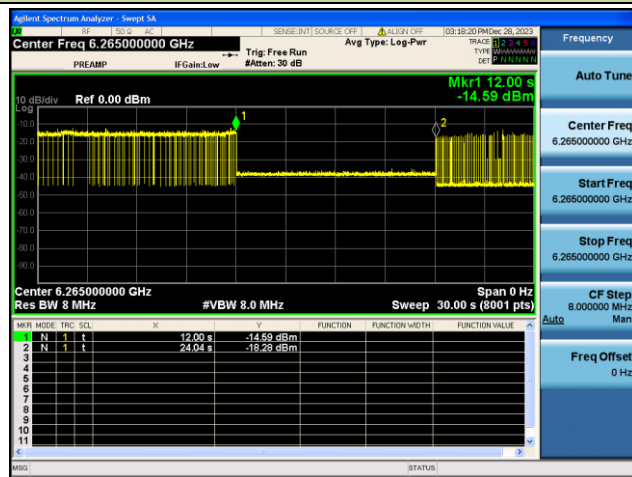

Note – M1: Injection of AWGN Signal, M2: Removal of AWGN Signal

Test Result of EUT ceased transmission (NII-6 Band) _6ID (Low-Power indoor AP)

802.11be-HET20 / CH97

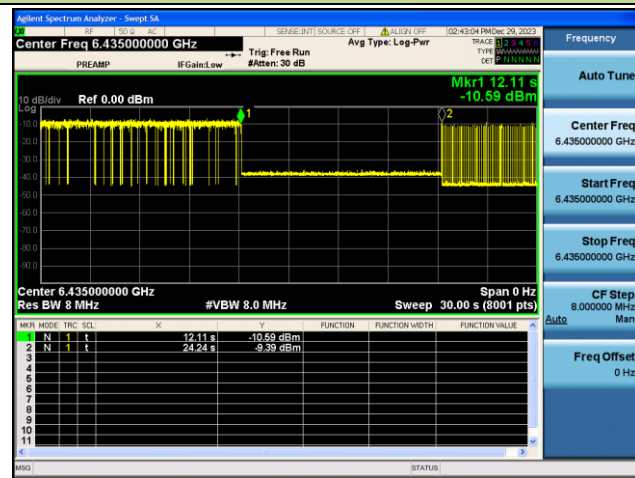

802.11be-HET80 / CH103 (Low Edge)

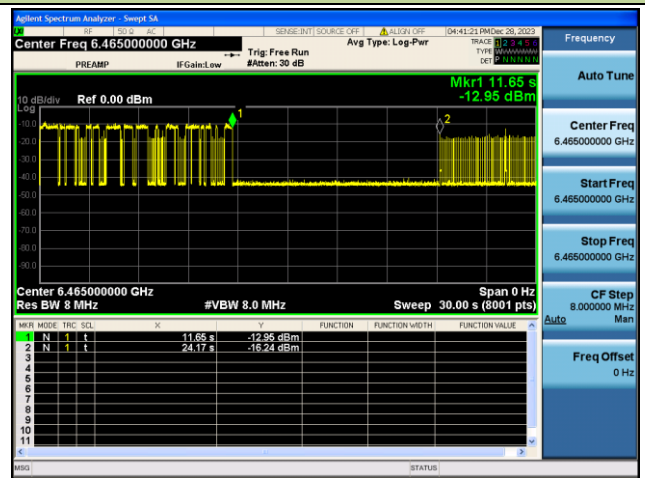

802.11be-HET80 / CH103 (Middle)

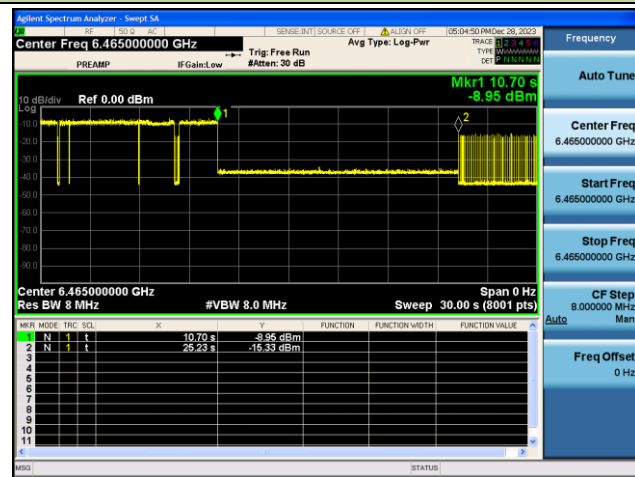

802.11be-HET80 / CH103 (High Edge)

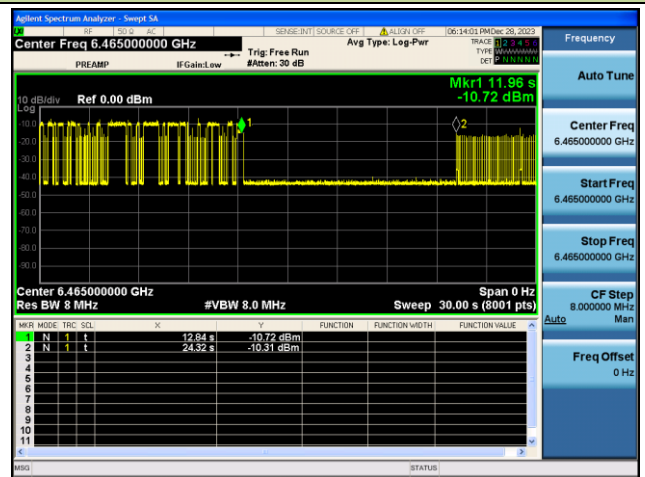

Note – M1: Injection of AWGN Signal, M2: Removal of AWGN Signal