

● Features

1. Surface Mounted Devices with a small dimension of 1.6 x 0.8 x 0.8mm meet future miniaturization trend.
2. Embedded and LTCC (low temperature co-fired ceramic) technology is able to integrate with system design as well as beautifying the housing of final product.
3. High stability and low tolerance.

● Applications

1. Bluetooth and Wireless LAN
2. ISM 2.4GHz in smart phone
3. PDA and other handheld devices.
4. ISM band 2.4GHz applications

● Dimensions (Unit: mm)

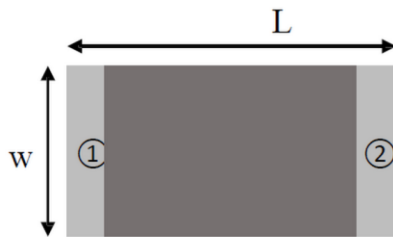

(Top View)

Number	Terminal Name
①	INPUT
②	NC

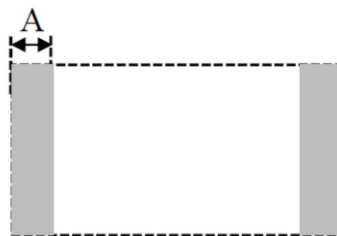

(Bottom View)



(Side View)

Symbols	L	W	T	A
Dimensions	1.60±0.20	0.80±0.20	0.80±0.10	0.30±0.10

SBR Communication has possession of proprietary information provided in this report and this proprietary information shall be kept in strict confidence and not disclosed to any person or firm without the prior written consent of SBR Communication Technology.

地址：深圳市宝安区西乡街道鹤州社区恒丰工业城B25栋二层

TEL: 0755-82790675, FAX: 0755-82809726 www.surbaner.com.cn

● Evaluation Board and Matching Circuits

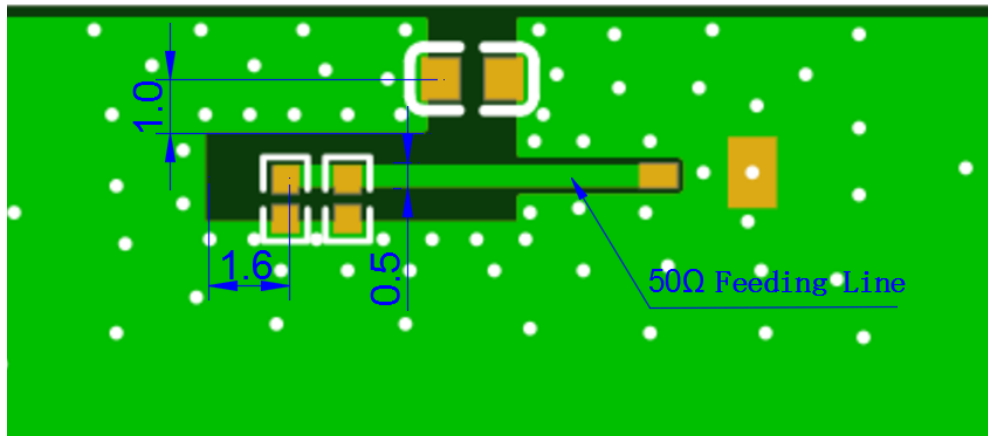
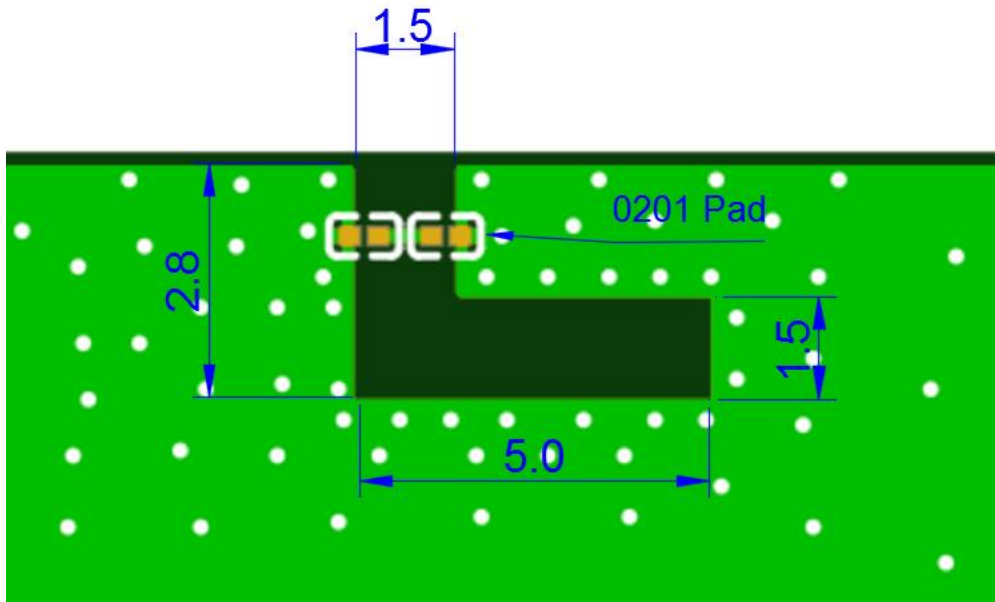

SBR Communication has possession of proprietary information provided in this report and this proprietary information shall be kept in strict confidence and not disclosed to any person or firm without the prior written consent of SBR Communication Technology.

地址：深圳市宝安区西乡街道鹤州社区恒丰工业城B25栋二层

TEL: 0755-82790675, FAX: 0755-82809726 www.surbaner.com.cn

● Electrical Characteristics

Item	Feature	Specification
1	Central frequency	2445MHz
2	Bandwidth	>100MHz
3	Peak gain	>3dBi
4	VSWR	<2
5	Polarization	Linear
6	Azimuth beamwidth	Omnidirectional
7	Impedance	50 Ω

NOTE: The specification is defined based on the test board dimension.

(1) Smith Chart

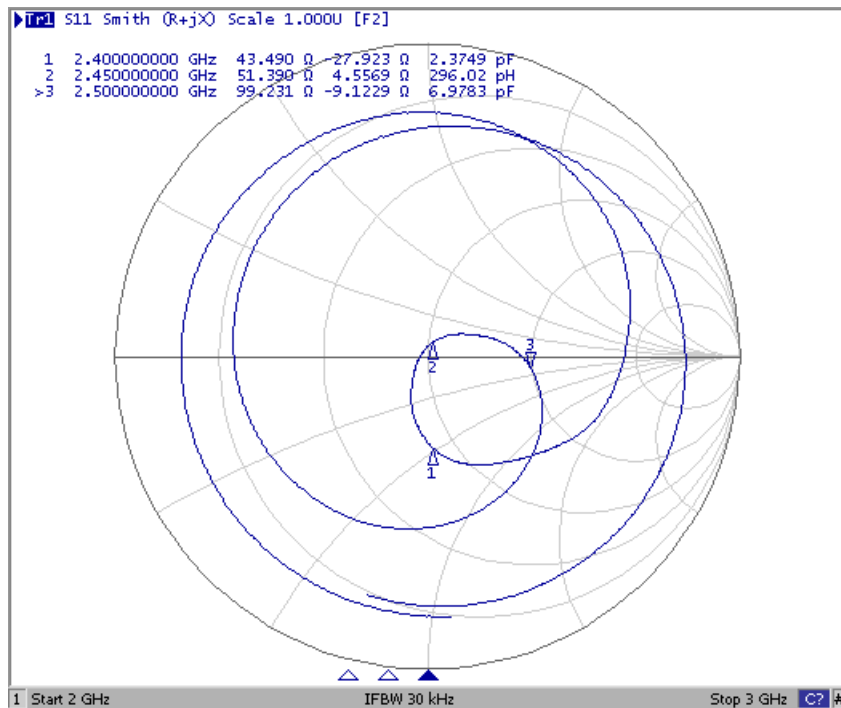

SBR Communication has possession of proprietary information provided in this report and this proprietary information shall be kept in strict confidence and not disclosed to any person or firm without the prior written consent of SBR Communication Technology.

地址：深圳市宝安区西乡街道鹤州社区恒丰工业城B25栋二层

TEL: 0755-82790675, FAX: 0755-82809726 www.surbaner.com.cn

(2) S-Parameter

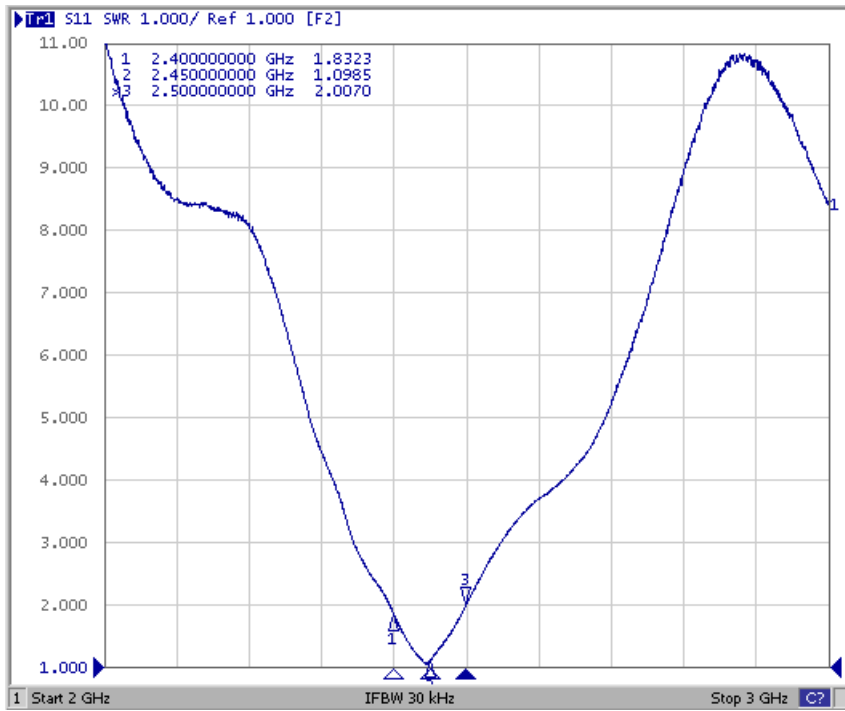

(3) Radiation Pattern



SBR Communication has possession of proprietary information provided in this report and this proprietary information shall be kept in strict confidence and not disclosed to any person or firm without the prior written consent of SBR Communication Technology.

地址：深圳市宝安区西乡街道鹤州社区恒丰工业城B25栋二层

TEL: 0755-82790675, FAX: 0755-82809726 www.surbaner.com.cn

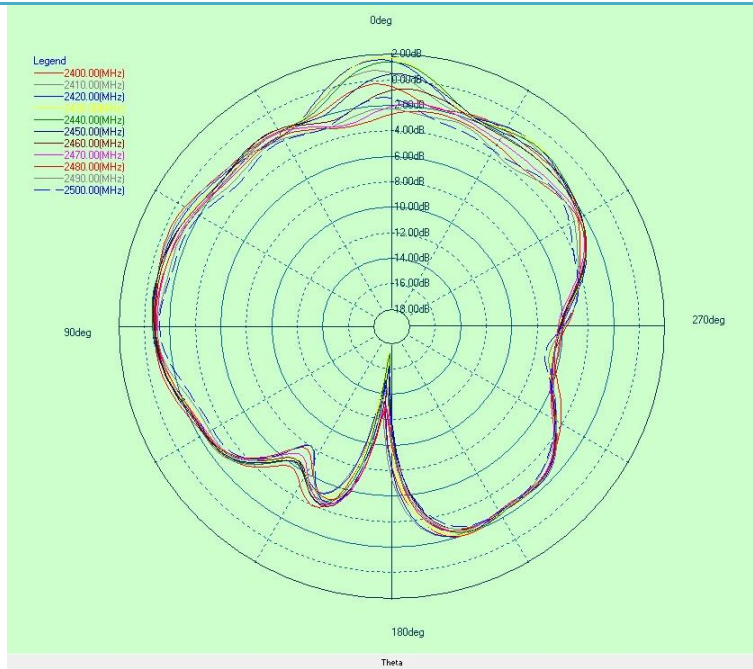

Y-Z Plane

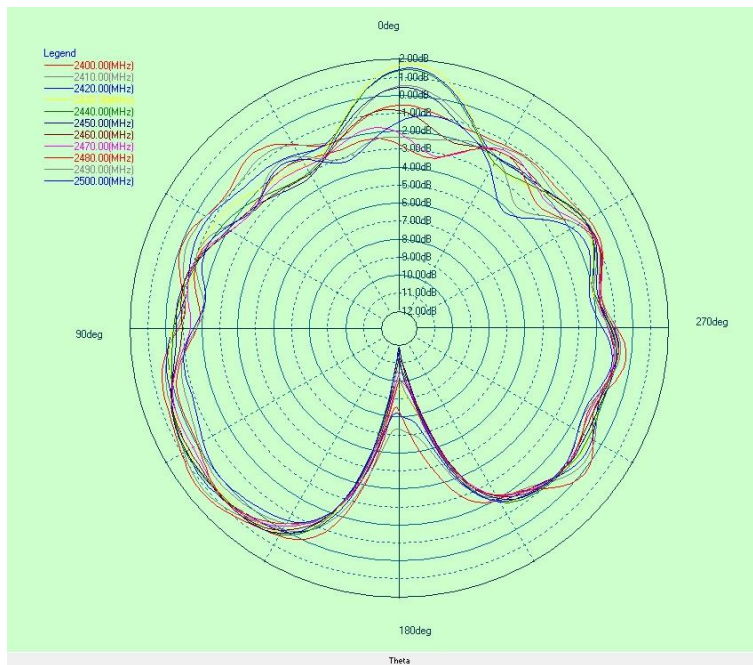

X-Z Plane

SBR Communication has possession of proprietary information provided in this report and this proprietary information shall be kept in strict confidence and not disclosed to any person or firm without the prior written consent of SBR Communication Technology.

地址：深圳市宝安区西乡街道鹤州社区恒丰工业城B25栋二层

TEL: 0755-82790675, FAX: 0755-82809726 www.surbaner.com.cn

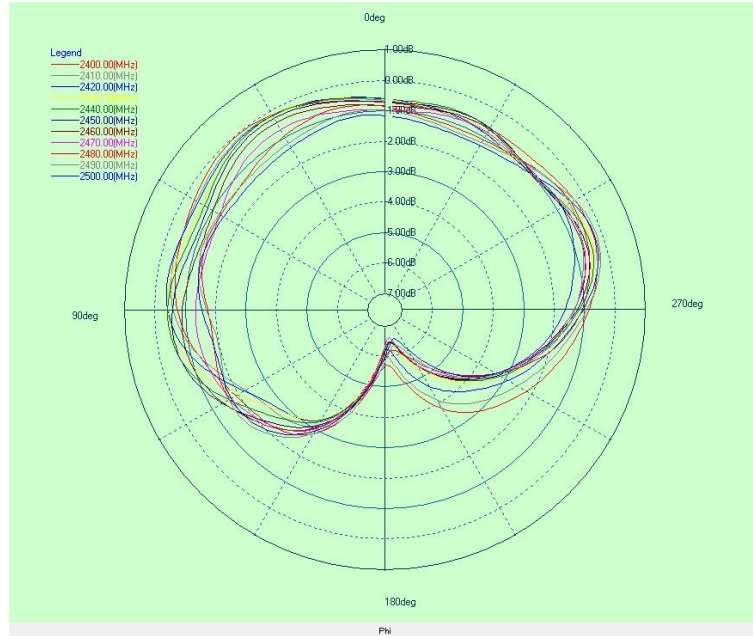

X-Y Plane

Frequency	2400MHz	2450MHz	2490MHz
Avg. gain	1.20	0.90	0.35
Peak gain	2.6	2.6	2.4
Efficiency	62%	55%	52%

● Dependability Test

Test Temperature	25°C±3°C
Operating Temperature	-25°C~+85°C
Temperature	5~+40°C
Relative Humidity	20~70%HR

SBR Communication has possession of proprietary information provided in this report and this proprietary information shall be kept in strict confidence and not disclosed to any person or firm without the prior written consent of SBR Communication Technology.

地址：深圳市宝安区西乡街道鹤州社区恒丰工业城B25栋二层

TEL: 0755-82790675, FAX: 0755-82809726 www.surbaner.com.cn