



3.3 LOWER DETECTION LIMIT

The lower detection limit was assessed using the same measurement set up as used for the linearity measurement. The required lower detection limit is 10 mW/kg.

3.4 ISOTROPY

The axial isotropy was evaluated by exposing the probe to a reference wave from a standard dipole with the dipole mounted under the flat phantom in the test configuration suggested for system validations and checks. The probe was rotated along its main axis from 0 to 360 degrees in 15-degree steps. The hemispherical isotropy is determined by inserting the probe in a thin plastic box filled with tissue-equivalent liquid, with the plastic box illuminated with the fields from a half wave dipole. The dipole is rotated about its axis (0°–180°) in 15° increments. At each step the probe is rotated about its axis (0°–360°).

3.1 BOUNDARY EFFECT

The boundary effect is defined as the deviation between the SAR measured data and the expected exponential decay in the liquid when the probe is oriented normal to the interface. To evaluate this effect, the liquid filled flat phantom is exposed to fields from either a reference dipole or waveguide. With the probe normal to the phantom surface, the peak spatial average SAR is measured and compared to the analytical value at the surface.

The boundary effect uncertainty can be estimated according to the following uncertainty approximation formula based on linear and exponential extrapolations between the surface and $d_{be} + d_{step}$ along lines that are approximately normal to the surface:

$$SAR_{uncertainty} [\%] = \Delta SAR_{be} \frac{(d_{be} + d_{step})^2}{2d_{step}} \frac{(e^{-d_{be}/\delta})^2}{\delta/2} \text{ for } (d_{be} + d_{step}) < 10 \text{ mm}$$

where

$SAR_{uncertainty}$	is the uncertainty in percent of the probe boundary effect
d_{be}	is the distance between the surface and the closest <i>zoom-scan</i> measurement point, in millimetre
Δ_{step}	is the separation distance between the first and second measurement points that are closest to the phantom surface, in millimetre, assuming the boundary effect at the second location is negligible
δ	is the minimum penetration depth in millimetres of the head tissue-equivalent liquids defined in this standard, i.e., $\delta \approx 14$ mm at 3 GHz;
ΔSAR_{be}	in percent of SAR is the deviation between the measured SAR value, at the distance d_{be} from the boundary, and the analytical SAR value.

The measured worst case boundary effect SAR uncertainty[%] for scanning distances larger than 4mm is 1.0% Limit ,2%).





COMOSAR E-FIELD PROBE CALIBRATION REPORT

Ref: ACR.180.4.42.BES.A

4 MEASUREMENT UNCERTAINTY

The guidelines outlined in the IEC/IEEE 62209-1528 and FCC KDB865664 D01 standards were followed to generate the measurement uncertainty associated with an E-field probe calibration using the waveguide technique. All uncertainties listed below represent an expanded uncertainty expressed at approximately the 95% confidence level using a coverage factor of $k=2$, traceable to the Internationally Accepted Guides to Measurement Uncertainty.

Uncertainty analysis of the probe calibration in waveguide					
ERROR SOURCES	Uncertainty value (%)	Probability Distribution	Divisor	ci	Standard Uncertainty (%)
Expanded uncertainty 95 % confidence level $k = 2$					14 %

5 CALIBRATION MEASUREMENT RESULTS

Calibration Parameters	
Liquid Temperature	20 +/- 1 °C
Lab Temperature	20 +/- 1 °C
Lab Humidity	30-70 %

5.1 SENSITIVITY IN AIR

Normx dipole 1 ($\mu\text{V}/(\text{V}/\text{m})^2$)	Normy dipole 2 ($\mu\text{V}/(\text{V}/\text{m})^2$)	Normz dipole 3 ($\mu\text{V}/(\text{V}/\text{m})^2$)
0.76	0.78	0.76

DCP dipole 1 (mV)	DCP dipole 2 (mV)	DCP dipole 3 (mV)
106	107	108

Calibration curves $e_i=f(V)$ ($i=1,2,3$) allow to obtain E-field value using the formula:

$$E = \sqrt{E_1^2 + E_2^2 + E_3^2}$$

Page: 6/11

Template_ACR.DDD.N.YY.MVGB.ISSUE_COMOSAR Probe vK

This document shall not be reproduced, except in full or in part, without the written approval of MVG. The information contained herein is to be used only for the purpose for which it is submitted and is not to be released in whole or part without written approval of MVG.





COMOSAR E-FIELD PROBE CALIBRATION REPORT

Ref: ACR.180.4.42.BES.A

Calibration curves

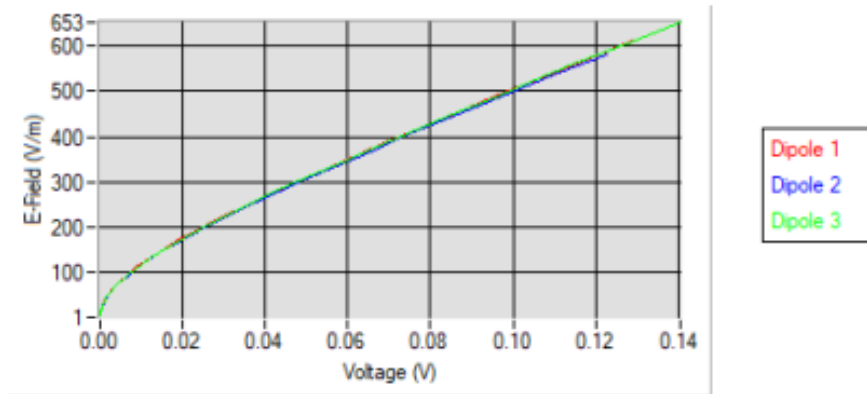

5.2 LINEARITY

Linearity

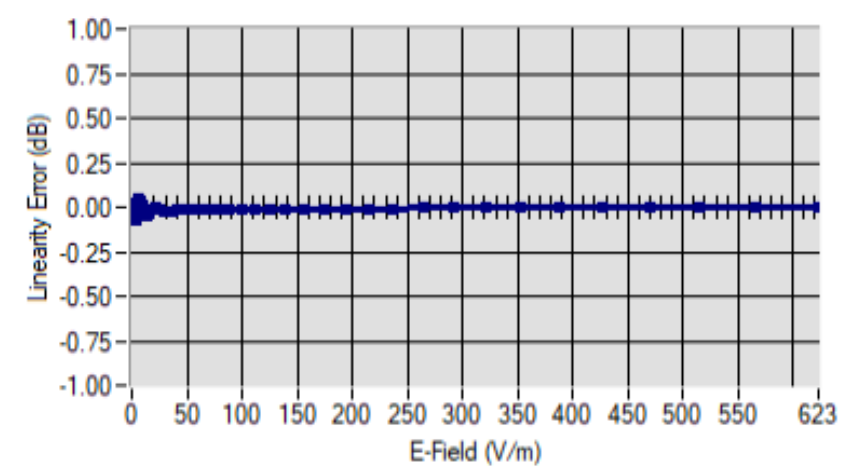

Linearity: +/-1.81% (+/-0.08dB)

Template_ACR.DDD.N.YY.MVGB.ISSUE_COMOSAR Probe vK

This document shall not be reproduced, except in full or in part, without the written approval of MVG. The information contained herein is to be used only for the purpose for which it is submitted and is not to be released in whole or part without written approval of MVG.





COMOSAR E-FIELD PROBE CALIBRATION REPORT

Ref: ACR.180.4.42.BES.A

5.3 SENSITIVITY IN LIQUID

Liquid	Frequency (MHz +/- 100MHz)	ConvF
HL450*	450*	1.74*
BL450*	450*	1.67*
HL750	750	1.69
BL750	750	1.73
HL850	835	1.75
BL850	835	1.80
HL900	900	1.87
BL900	900	1.85
HL1800	1800	2.09
BL1800	1800	2.15
HL1900	1900	2.14
BL1900	1900	2.27
HL2000	2000	2.31
BL2000	2000	2.34
HL2300	2300	2.46
BL2300	2300	2.51
HL2450	2450	2.60
BL2450	2450	2.70
HL2600	2600	2.39
BL2600	2600	2.50
HL5200	5200	1.85
BL5200	5200	1.81
HL5400	5400	2.07
BL5400	5400	2.00
HL5600	5600	2.19
BL5600	5600	2.11
HL5800	5800	2.01
BL5800	5800	1.97

* Frequency not cover by COFRAC scope, calibration not accredited

LOWER DETECTION LIMIT: 7mW/kg





COMOSAR E-FIELD PROBE CALIBRATION REPORT

Ref: ACR.180.4.42.BES.A

5.4 ISOTROPY

HL1800 MHz

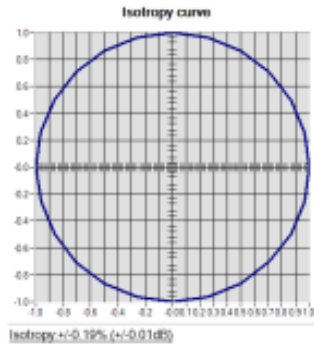



COMOSAR E-FIELD PROBE CALIBRATION REPORT

Ref: ACR.180.4.42.BES.A

6 LIST OF EQUIPMENT

Equipment Summary Sheet				
Equipment Description	Manufacturer / Model	Identification No.	Current Calibration Date	Next Calibration Date
CALIPROBE Test Bench	Version 2	NA	Validated. No cal required.	Validated. No cal required.
Network Analyzer	Rohde & Schwarz ZVM	100203	08/2021	08/2024
Network Analyzer	Agilent 8753ES	MY40003210	10/2022	10/2025
Network Analyzer – Calibration kit	HP 85033D	3423A08186	06/2021	06/2027
Multimeter	Keithley 2000	1160271	02/2023	02/2026
Signal Generator	Rohde & Schwarz SMB	106589	03/2022	03/2025
Amplifier	MVG	MODU-023-C-0002	Characterized prior to test. No cal required.	Characterized prior to test. No cal required.
Power Meter	NI-USB 5680	170100013	06/2021	06/2024
Power Meter	Rohde & Schwarz NRVD	832839-056	11/2022	11/2025
Directional Coupler	Krytar 158020	131467	Characterized prior to test. No cal required.	Characterized prior to test. No cal required.
Waveguide	MVG	SN 32/16 WG4_1	Validated. No cal required.	Validated. No cal required.
Liquid transition	MVG	SN 32/16 WGLIQ_0G900_1	Validated. No cal required.	Validated. No cal required.
Waveguide	MVG	SN 32/16 WG6_1	Validated. No cal required.	Validated. No cal required.
Liquid transition	MVG	SN 32/16 WGLIQ_1G500_1	Validated. No cal required.	Validated. No cal required.
Waveguide	MVG	SN 32/16 WG8_1	Validated. No cal required.	Validated. No cal required.
Liquid transition	MVG	SN 32/16 WGLIQ_1G800B_1	Validated. No cal required.	Validated. No cal required.
Liquid transition	MVG	SN 32/16 WGLIQ_1G800H_1	Validated. No cal required.	Validated. No cal required.
Waveguide	MVG	SN 32/16 WG10_1	Validated. No cal required.	Validated. No cal required.
Liquid transition	MVG	SN 32/16 WGLIQ_3G500_1	Validated. No cal required.	Validated. No cal required.
Waveguide	MVG	SN 32/16 WG12_1	Validated. No cal required.	Validated. No cal required.

Page: 10/11

Template_ACR.DDD.N.YY.MVGB.ISSUE_COMOSAR Probe vK

This document shall not be reproduced, except in full or in part, without the written approval of MVG. The information contained herein is to be used only for the purpose for which it is submitted and is not to be released in whole or part without written approval of MVG.





COMOSAR E-FIELD PROBE CALIBRATION REPORT

Ref: ACR.180.442.BES.A

Liquid transition	MVG	SN 32/16 WGLIQ_5G000_1	Validated. No cal required.	Validated. No cal required.
Temperature / Humidity Sensor	Testo 184 H1	44225320	06/2021	06/2024

Template_ACR.DDD.N.YY.MVGB.ISSUE_COMOSAR Probe vK

This document shall not be reproduced, except in full or in part, without the written approval of MVG. The information contained herein is to be used only for the purpose for which it is submitted and is not to be released in whole or part without written approval of MVG.





5.2 SID2450 Dipole Calibration Certificate



SAR Reference Dipole Calibration Report

Ref : ACR.287.8.14.SATU.A

**SHENZHEN LCS COMPLIANCE TESTING
LABORATORY LTD.**
1F., XINGYUAN INDUSTRIAL PARK, TONGDA ROAD,
BAO'AN BLVD
BAO'AN DISTRICT, SHENZHEN, GUANGDONG, CHINA
SATIMO COMOSAR REFERENCE DIPOLE
FREQUENCY: 2450 MHZ
SERIAL NO.: SN 07/14 DIP 2G450-306

Calibrated at SATIMO US
2105 Barrett Park Dr. - Kennesaw, GA 30144



09/29/2021

Summary:

This document presents the method and results from an accredited SAR reference dipole calibration performed in SATIMO USA using the COMOSAR test bench. All calibration results are traceable to national metrology institutions.





SAR REFERENCE DIPOLE CALIBRATION REPORT

Ref: ACR.287.8.14.SATU.A

	<i>Name</i>	<i>Function</i>	<i>Date</i>	<i>Signature</i>
<i>Prepared by :</i>	Jérôme LUC	Product Manager	10/12/2021	<i>JS</i>
<i>Checked by :</i>	Jérôme LUC	Product Manager	10/12/2021	<i>JS</i>
<i>Approved by :</i>	Kim RUTKOWSKI	Quality Manager	10/12/2021	<i>Kim Rutkowski</i>

	<i>Customer Name</i>
<i>Distribution :</i>	Shenzhen LCS Compliance Testing Laboratory Ltd.

<i>Issue</i>	<i>Date</i>	<i>Modifications</i>
A	10/12/2021	Initial release

This document shall not be reproduced, except in full or in part, without the written approval of SATIMO. The information contained herein is to be used only for the purpose for which it is submitted and is not to be released in whole or part without written approval of SATIMO.





TABLE OF CONTENTS

1 Introduction.....4

2 Device Under Test4

3 Product Description4

 3.1 General Information 4

4 Measurement Method5

 4.1 Return Loss Requirements 5

 4.2 Mechanical Requirements 5

5 Measurement Uncertainty.....5

 5.1 Return Loss 5

 5.2 Dimension Measurement 5

 5.3 Validation Measurement 5

6 Calibration Measurement Results6

 6.1 Return Loss and Impedance 6

 6.2 Mechanical Dimensions 6

7 Validation measurement7

 7.1 Head Liquid Measurement 7

 7.2 SAR Measurement Result With Head Liquid 7

 7.3 Body Liquid Measurement 9

 7.4 SAR Measurement Result With Body Liquid 9

8 List of Equipment 11

This document shall not be reproduced, except in full or in part, without the written approval of SATIMO. The information contained herein is to be used only for the purpose for which it is submitted and is not to be released in whole or part without written approval of SATIMO.



1 INTRODUCTION

This document contains a summary of the requirements set forth by the IEEE 1528, OET 65 Bulletin C and CEI/IEC 62209 standards for reference dipoles used for SAR measurement system validations and the measurements that were performed to verify that the product complies with the fore mentioned standards.

2 DEVICE UNDER TEST

Device Under Test	
Device Type	COMOSAR 2450 MHz REFERENCE DIPOLE
Manufacturer	Satimo
Model	SID2450
Serial Number	SN 07/14 DIP 2G450-306
Product Condition (new / used)	New

A yearly calibration interval is recommended.

3 PRODUCT DESCRIPTION

3.1 GENERAL INFORMATION

Satimo's COMOSAR Validation Dipoles are built in accordance to the IEEE 1528, OET 65 Bulletin C and CEI/IEC 62209 standards. The product is designed for use with the COMOSAR test bench only.



Figure 1 – Satimo COMOSAR Validation Dipole

Page: 4/11

This document shall not be reproduced, except in full or in part, without the written approval of SATIMO. The information contained herein is to be used only for the purpose for which it is submitted and is not to be released in whole or part without written approval of SATIMO.





4 MEASUREMENT METHOD

The IEEE 1528, OET 65 Bulletin C and CEI/IEC 62209 standards provide requirements for reference dipoles used for system validation measurements. The following measurements were performed to verify that the product complies with the fore mentioned standards.

4.1 RETURN LOSS REQUIREMENTS

The dipole used for SAR system validation measurements and checks must have a return loss of -20 dB or better. The return loss measurement shall be performed against a liquid filled flat phantom, with the phantom constructed as outlined in the fore mentioned standards.

4.2 MECHANICAL REQUIREMENTS

The IEEE Std. 1528 and CEI/IEC 62209 standards specify the mechanical components and dimensions of the validation dipoles, with the dimensions frequency and phantom shell thickness dependent. The COMOSAR test bench employs a 2 mm phantom shell thickness therefore the dipoles sold for use with the COMOSAR test bench comply with the requirements set forth for a 2 mm phantom shell thickness.

5 MEASUREMENT UNCERTAINTY

All uncertainties listed below represent an expanded uncertainty expressed at approximately the 95% confidence level using a coverage factor of k=2, traceable to the Internationally Accepted Guides to Measurement Uncertainty.

5.1 RETURN LOSS

The following uncertainties apply to the return loss measurement:

Table with 2 columns: Frequency band, Expanded Uncertainty on Return Loss. Row 1: 400-6000MHz, 0.1 dB

5.2 DIMENSION MEASUREMENT

The following uncertainties apply to the dimension measurements:

Table with 2 columns: Length (mm), Expanded Uncertainty on Length. Row 1: 3 - 300, 0.05 mm

5.3 VALIDATION MEASUREMENT

The guidelines outlined in the IEEE 1528, OET 65 Bulletin C, CENELEC EN50361 and CEI/IEC 62209 standards were followed to generate the measurement uncertainty for validation measurements.

Table with 2 columns: Scan Volume, Expanded Uncertainty. Row 1: 1 g, 20.3 %. Row 2: 10 g, 20.1 %

This document shall not be reproduced, except in full or in part, without the written approval of SATIMO. The information contained herein is to be used only for the purpose for which it is submitted and is not to be released in whole or part without written approval of SATIMO.





6 CALIBRATION MEASUREMENT RESULTS

6.1 RETURN LOSS AND IMPEDANCE

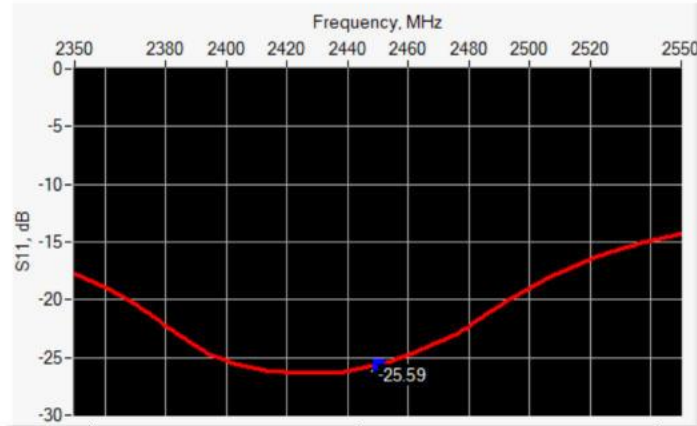

Frequency (MHz)	Return Loss (dB)	Requirement (dB)	Impedance
2450	-25.59	-20	44.7 Ω - 1.1 jΩ

6.2 MECHANICAL DIMENSIONS

Frequency MHz	L mm		h mm		d mm	
	required	measured	required	measured	required	measured
300	420.0 ±1 %.		250.0 ±1 %.		6.35 ±1 %.	
450	290.0 ±1 %.		166.7 ±1 %.		6.35 ±1 %.	
750	176.0 ±1 %.		100.0 ±1 %.		6.35 ±1 %.	
835	161.0 ±1 %.		89.8 ±1 %.		3.6 ±1 %.	
900	149.0 ±1 %.		83.3 ±1 %.		3.6 ±1 %.	
1450	89.1 ±1 %.		51.7 ±1 %.		3.6 ±1 %.	
1500	80.5 ±1 %.		50.0 ±1 %.		3.6 ±1 %.	
1640	79.0 ±1 %.		45.7 ±1 %.		3.6 ±1 %.	
1750	75.2 ±1 %.		42.9 ±1 %.		3.6 ±1 %.	
1800	72.0 ±1 %.		41.7 ±1 %.		3.6 ±1 %.	
1900	68.0 ±1 %.		39.5 ±1 %.		3.6 ±1 %.	
1950	66.3 ±1 %.		38.5 ±1 %.		3.6 ±1 %.	
2000	64.5 ±1 %.		37.5 ±1 %.		3.6 ±1 %.	
2100	61.0 ±1 %.		35.7 ±1 %.		3.6 ±1 %.	
2300	55.5 ±1 %.		32.6 ±1 %.		3.6 ±1 %.	
2450	51.5 ±1 %.	PASS	30.4 ±1 %.	PASS	3.6 ±1 %.	PASS
2600	48.5 ±1 %.		28.8 ±1 %.		3.6 ±1 %.	
3000	41.5 ±1 %.		25.0 ±1 %.		3.6 ±1 %.	
3500	37.0 ±1 %.		26.4 ±1 %.		3.6 ±1 %.	
3700	34.7 ±1 %.		26.4 ±1 %.		3.6 ±1 %.	

This document shall not be reproduced, except in full or in part, without the written approval of SATIMO. The information contained herein is to be used only for the purpose for which it is submitted and is not to be released in whole or part without written approval of SATIMO.





7 VALIDATION MEASUREMENT

The IEEE Std. 1528, OET 65 Bulletin C and CEI/IEC 62209 standards state that the system validation measurements must be performed using a reference dipole meeting the fore mentioned return loss and mechanical dimension requirements. The validation measurement must be performed against a liquid filled flat phantom, with the phantom constructed as outlined in the fore mentioned standards. Per the standards, the dipole shall be positioned below the bottom of the phantom, with the dipole length centered and parallel to the longest dimension of the flat phantom, with the top surface of the dipole at the described distance from the bottom surface of the phantom.

7.1 HEAD LIQUID MEASUREMENT

Table with 5 columns: Frequency MHz, Relative permittivity (εr) required/measured, and Conductivity (σ) S/m required/measured. Rows include frequencies from 300 to 3500 MHz.

7.2 SAR MEASUREMENT RESULT WITH HEAD LIQUID

The IEEE Std. 1528 and CEI/IEC 62209 standards state that the system validation measurements should produce the SAR values shown below (for phantom thickness of 2 mm), within the uncertainty for the system validation. All SAR values are normalized to 1 W forward power. In bracket, the measured SAR is given with the used input power.

Table with 2 columns: Parameter (Software, Phantom, Probe, Liquid, Distance between dipole center and liquid, Area scan resolution) and Value (OPENSAR V4, SN 20/09 SAM71, SN 18/11 EPG122, Head Liquid Values: eps: 39.0 sigma: 1.77, 10.0 mm, dx=8mm/dy=8mm).

This document shall not be reproduced, except in full or in part, without the written approval of SATIMO. The information contained herein is to be used only for the purpose for which it is submitted and is not to be released in whole or part without written approval of SATIMO.





SAR REFERENCE DIPOLE CALIBRATION REPORT

Ref: ACR.287.8.14.SATU.A

Zoon Scan Resolution	dx=8mm/dy=8m/dz=5mm
Frequency	2450 MHz
Input power	20 dBm
Liquid Temperature	21 °C
Lab Temperature	21 °C
Lab Humidity	45 %

Frequency MHz	1 g SAR (W/kg/W)		10 g SAR (W/kg/W)	
	required	measured	required	measured
300	2.85		1.94	
450	4.58		3.06	
750	8.49		5.55	
835	9.56		6.22	
900	10.9		6.99	
1450	29		16	
1500	30.5		16.8	
1640	34.2		18.4	
1750	36.4		19.3	
1800	38.4		20.1	
1900	39.7		20.5	
1950	40.5		20.9	
2000	41.1		21.1	
2100	43.6		21.9	
2300	48.7		23.3	
2450	52.4	53.89 (5.39)	24	24.15 (2.42)
2600	55.3		24.6	
3000	63.8		25.7	
3500	67.1		25	

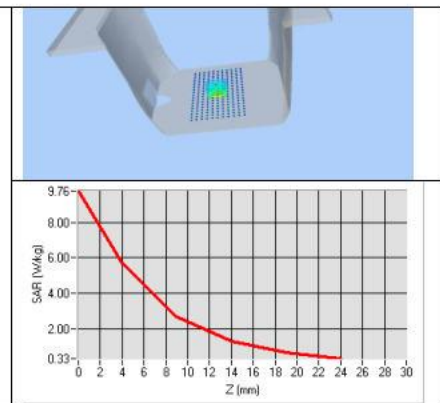
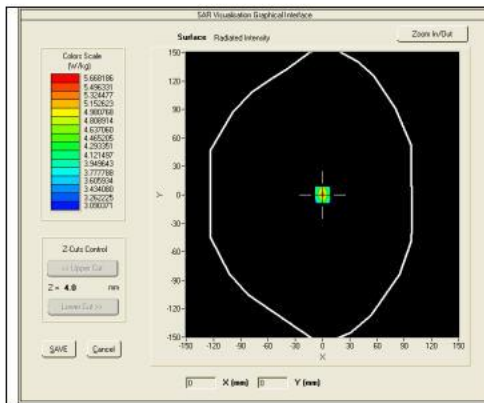

This document shall not be reproduced, except in full or in part, without the written approval of SATIMO.
 The information contained herein is to be used only for the purpose for which it is submitted and is not to be released in whole or part without written approval of SATIMO.





SAR REFERENCE DIPOLE CALIBRATION REPORT

Ref: ACR.287.8.14.SATU.A

7.3 BODY LIQUID MEASUREMENT

Frequency MHz	Relative permittivity (ϵ_r')		Conductivity (σ) S/m	
	required	measured	required	measured
150	61.9 \pm 5 %		0.80 \pm 5 %	
300	58.2 \pm 5 %		0.92 \pm 5 %	
450	56.7 \pm 5 %		0.94 \pm 5 %	
750	55.5 \pm 5 %		0.96 \pm 5 %	
835	55.2 \pm 5 %		0.97 \pm 5 %	
900	55.0 \pm 5 %		1.05 \pm 5 %	
915	55.0 \pm 5 %		1.06 \pm 5 %	
1450	54.0 \pm 5 %		1.30 \pm 5 %	
1610	53.8 \pm 5 %		1.40 \pm 5 %	
1800	53.3 \pm 5 %		1.52 \pm 5 %	
1900	53.3 \pm 5 %		1.52 \pm 5 %	
2000	53.3 \pm 5 %		1.52 \pm 5 %	
2100	53.2 \pm 5 %		1.62 \pm 5 %	
2450	52.7 \pm 5 %	PASS	1.95 \pm 5 %	PASS
2600	52.5 \pm 5 %		2.16 \pm 5 %	
3000	52.0 \pm 5 %		2.73 \pm 5 %	
3500	51.3 \pm 5 %		3.31 \pm 5 %	
5200	49.0 \pm 10 %		5.30 \pm 10 %	
5300	48.9 \pm 10 %		5.42 \pm 10 %	
5400	48.7 \pm 10 %		5.53 \pm 10 %	
5500	48.6 \pm 10 %		5.65 \pm 10 %	
5600	48.5 \pm 10 %		5.77 \pm 10 %	
5800	48.2 \pm 10 %		6.00 \pm 10 %	

7.4 SAR MEASUREMENT RESULT WITH BODY LIQUID

Software	OPENSAR V4
Phantom	SN 20/09 SAM71
Probe	SN 18/11 EPG122
Liquid	Body Liquid Values: ϵ_{ps}' : 53.0 sigma : 1.93
Distance between dipole center and liquid	10.0 mm
Area scan resolution	dx=8mm/dy=8mm
Zoon Scan Resolution	dx=8mm/dy=8m/dz=5mm
Frequency	2450 MHz
Input power	20 dBm
Liquid Temperature	21 °C
Lab Temperature	21 °C
Lab Humidity	45 %

Page: 9/11

*This document shall not be reproduced, except in full or in part, without the written approval of SATIMO.
The information contained herein is to be used only for the purpose for which it is submitted and is not to be released in whole or part without written approval of SATIMO.*





SAR REFERENCE DIPOLE CALIBRATION REPORT

Ref: ACR.287.8.14.SATU.A

Frequency MHz	1 g SAR (W/kg/W)	10 g SAR (W/kg/W)
	measured	measured
2450	54.65 (5.46)	24.58 (2.46)

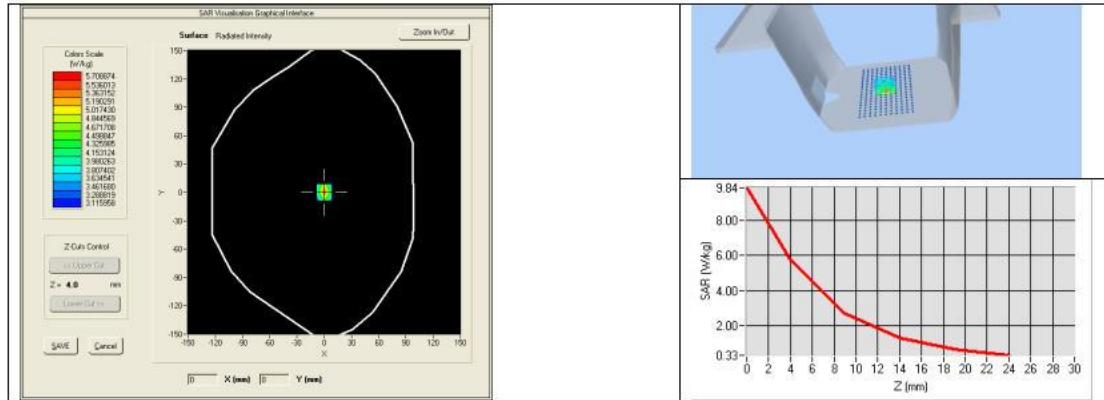



SAR REFERENCE DIPOLE CALIBRATION REPORT

Ref: ACR.287.8.14.SATU.A

Frequency MHz	1 g SAR (W/kg/W)	10 g SAR (W/kg/W)
	measured	measured
2450	54.65 (5.46)	24.58 (2.46)

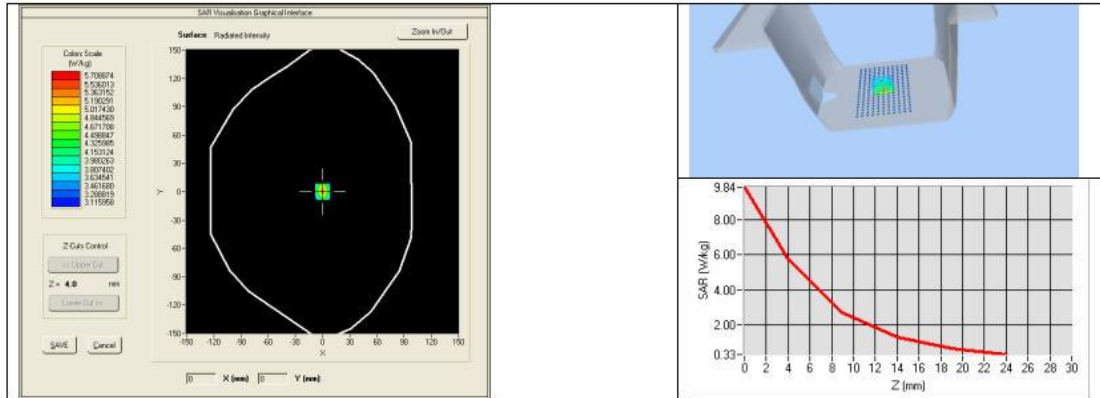



8 LIST OF EQUIPMENT

Equipment Summary Sheet				
Equipment Description	Manufacturer / Model	Identification No.	Current Calibration Date	Next Calibration Date
SAM Phantom	Satimo	SN-20/09-SAM71	Validated. No cal required.	Validated. No cal required.
COMOSAR Test Bench	Version 3	NA	Validated. No cal required.	Validated. No cal required.
Network Analyzer	Rhode & Schwarz ZVA	SN100132	02/2021	02/2024
Calipers	Carrera	CALIPER-01	12/2018	12/2021
Reference Probe	Satimo	EPG122 SN 18/11	10/2021	10/2022
Multimeter	Keithley 2000	1188656	12/2018	12/2021
Signal Generator	Agilent E4438C	MY49070581	12/2018	12/2021
Amplifier	Aethercomm	SN 046	Characterized prior to test. No cal required.	Characterized prior to test. No cal required.
Power Meter	HP E4418A	US38261498	12/2018	12/2021
Power Sensor	HP ECP-E26A	US37181460	12/2018	12/2021
Directional Coupler	Narda 4216-20	01386	Characterized prior to test. No cal required.	Characterized prior to test. No cal required.
Temperature and Humidity Sensor	Control Company	11-661-9	8/2021	8/2024

Page: 11/11

This document shall not be reproduced, except in full or in part, without the written approval of SATIMO. The information contained herein is to be used only for the purpose for which it is submitted and is not to be released in whole or part without written approval of SATIMO.





5.3 SID5-6G Dipole Calibration Certificate



SAR Reference Waveguide Calibration Report

Ref: ACR.273.5.18.SATU.A

**SHENZHEN LCS COMPLIANCE TESTING
LABORATORY LTD.**
**1F., XINGYUAN INDUSTRIAL PARK, TONGDA
ROAD, BAO'AN BLVD BAO'AN DISTRICT,
SHENZHEN, GUANGDONG, CHINA**
**MVG COMOSAR
REFERENCE WAVEGUIDE**
FREQUENCY: 5000-6000 MHZ
SERIAL NO.: SN 49/16 WGA 43

Calibrated at MVG US
2105 Barrett Park Dr. - Kennesaw, GA 30144



Calibration Date: 09/22/2021

Summary:

This document presents the method and results from an accredited SAR reference waveguide calibration performed in MVG USA using the COMOSAR test bench. All calibration results are traceable to national metrology institutions.





SAR REFERENCE WAVEGUIDE CALIBRATION REPORT

Ref: ACR.273.5.18.SATU.A

	<i>Name</i>	<i>Function</i>	<i>Date</i>	<i>Signature</i>
<i>Prepared by :</i>	Jérôme LUC	Product Manager	09/28/2021	<i>JS</i>
<i>Checked by :</i>	Jérôme LUC	Product Manager	09/28/2021	<i>JS</i>
<i>Approved by :</i>	Kim RUTKOWSKI	Quality Manager	09/28/2021	<i>Kim Rutkowski</i>

	<i>Customer Name</i>
<i>Distribution :</i>	Shenzhen LCS Compliance Testing Laboratory Ltd.

<i>Issue</i>	<i>Date</i>	<i>Modifications</i>
A	09/28/2021	Initial release

This document shall not be reproduced, except in full or in part, without the written approval of MVG. The information contained herein is to be used only for the purpose for which it is submitted and is not to be released in whole or part without written approval of MVG.





SAR REFERENCE WAVEGUIDE CALIBRATION REPORT

Ref: ACR.273.5.18.SATU.A

TABLE OF CONTENTS

1 Introduction.....4

2 Device Under Test4

3 Product Description4

 3.1 General Information 4

4 Measurement Method4

 4.1 Return Loss Requirements 4

 4.2 Mechanical Requirements 4

5 Measurement Uncertainty..... 5

 5.1 Return Loss 5

 5.2 Dimension Measurement 5

 5.3 Validation Measurement 5

6 Calibration Measurement Results 5

 6.1 Return Loss 5

 6.2 Mechanical Dimensions 6

7 Validation measurement 7

 7.1 Head Liquid Measurement 7

 7.2 Measurement Result 7

 7.3 Body Measurement Result 10

8 List of Equipment 13

This document shall not be reproduced, except in full or in part, without the written approval of MVG. The information contained herein is to be used only for the purpose for which it is submitted and is not to be released in whole or part without written approval of MVG.





1 INTRODUCTION

This document contains a summary of the requirements set forth by the IEEE 1528 and CEI/IEC 62209 standards for reference waveguides used for SAR measurement system validations and the measurements that were performed to verify that the product complies with the fore mentioned standards.

2 DEVICE UNDER TEST

Device Under Test	
Device Type	COMOSAR 5000-6000 MHz REFERENCE WAVEGUIDE
Manufacturer	MVG
Model	SWG5500
Serial Number	SN 49/16 WGA 43
Product Condition (new / used)	Used

A yearly calibration interval is recommended.

3 PRODUCT DESCRIPTION

3.1 GENERAL INFORMATION

MVG's COMOSAR Validation Waveguides are built in accordance to the IEEE 1528 and CEI/IEC 62209 standards.

4 MEASUREMENT METHOD

The IEEE 1528 and CEI/IEC 62209 standards provide requirements for reference waveguides used for system validation measurements. The following measurements were performed to verify that the product complies with the fore mentioned standards.

4.1 RETURN LOSS REQUIREMENTS

The waveguide used for SAR system validation measurements and checks must have a return loss of -8 dB or better. The return loss measurement shall be performed with matching layer placed in the open end of the waveguide, with the waveguide and matching layer in direct contact with the phantom shell as outlined in the fore mentioned standards.

4.2 MECHANICAL REQUIREMENTS

The IEEE 1528 and CEI/IEC 62209 standards specify the mechanical dimensions of the validation waveguide, the specified dimensions are as shown in Section 6.2. Figure 1 shows how the dimensions relate to the physical construction of the waveguide.

This document shall not be reproduced, except in full or in part, without the written approval of MVG. The information contained herein is to be used only for the purpose for which it is submitted and is not to be released in whole or part without written approval of MVG.





5 MEASUREMENT UNCERTAINTY

All uncertainties listed below represent an expanded uncertainty expressed at approximately the 95% confidence level using a coverage factor of k=2, traceable to the Internationally Accepted Guides to Measurement Uncertainty.

5.1 RETURN LOSS

The following uncertainties apply to the return loss measurement:

Frequency band	Expanded Uncertainty on Return Loss
400-6000MHz	0.1 dB

5.2 DIMENSION MEASUREMENT

The following uncertainties apply to the dimension measurements:

Length (mm)	Expanded Uncertainty on Length
3 - 300	0.05 mm

5.3 VALIDATION MEASUREMENT

The guidelines outlined in the IEEE 1528 and CEI/IEC 62209 standards were followed to generate the measurement uncertainty for validation measurements.

Scan Volume	Expanded Uncertainty
1 g	20.3 %
10 g	20.1 %

6 CALIBRATION MEASUREMENT RESULTS

6.1 RETURN LOSS IN HEAD LIQUID

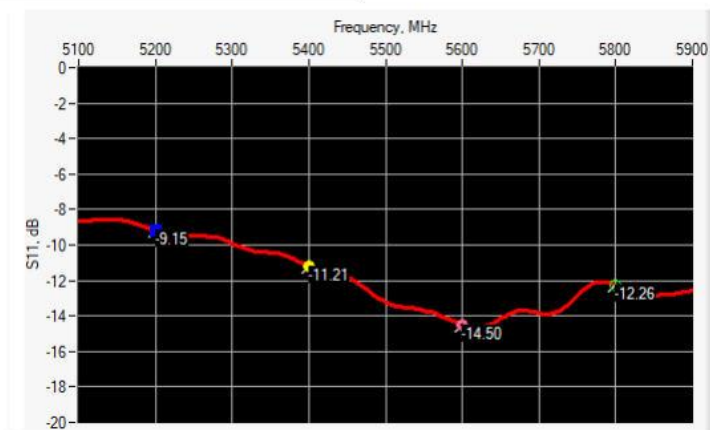

This document shall not be reproduced, except in full or in part, without the written approval of MVG. The information contained herein is to be used only for the purpose for which it is submitted and is not to be released in whole or part without written approval of MVG.





SAR REFERENCE WAVEGUIDE CALIBRATION REPORT

Ref: ACR.273.5.18.SATU.A

Frequency (MHz)	Return Loss (dB)	Requirement (dB)	Impedance
5200	-9.15	-8	20.57 Ω + 11.55 jΩ
5400	-11.21	-8	75.27 Ω + 4.08 jΩ
5600	-14.50	-8	33.91 Ω - 8.72 jΩ
5800	-12.26	-8	53.07 Ω + 23.41 jΩ

6.2 RETURN LOSS IN BODY LIQUID

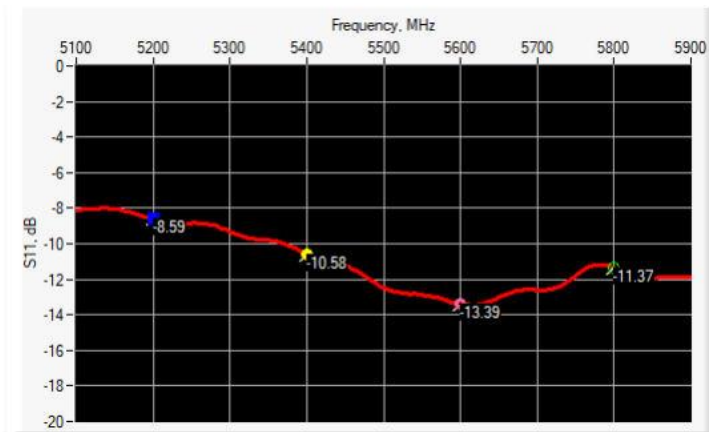

Frequency (MHz)	Return Loss (dB)	Requirement (dB)	Impedance
5200	-8.59	-8	19.38 Ω + 13.50 jΩ
5400	-10.58	-8	77.13 Ω + 1.81 jΩ
5600	-13.39	-8	30.95 Ω - 7.75 jΩ
5800	-11.37	-8	54.79 Ω + 25.47 jΩ

6.3 MECHANICAL DIMENSIONS

Frequency (MHz)	L (mm)		W (mm)		L _r (mm)		W _r (mm)		T (mm)	
	Required	Measured	Required	Measured	Required	Measured	Required	Measured	Required	Measured
5200	40.39 ± 0.13	PASS	20.19 ± 0.13	PASS	81.03 ± 0.13	PASS	61.98 ± 0.13	PASS	5.3*	PASS
5800	40.39 ± 0.13	PASS	20.19 ± 0.13	PASS	81.03 ± 0.13	PASS	61.98 ± 0.13	PASS	4.3*	PASS

* The tolerance for the matching layer is included in the return loss measurement.

This document shall not be reproduced, except in full or in part, without the written approval of MVG. The information contained herein is to be used only for the purpose for which it is submitted and is not to be released in whole or part without written approval of MVG.



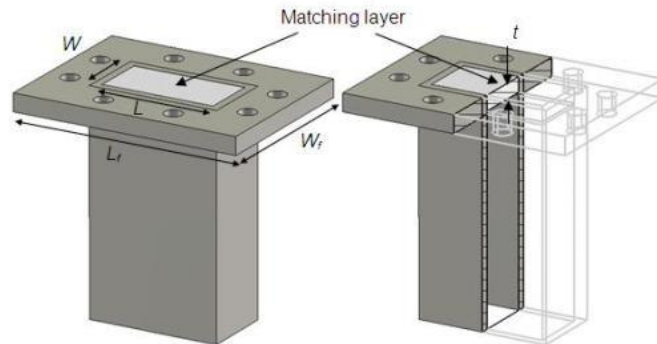

Figure 1: Validation Waveguide Dimensions

7 VALIDATION MEASUREMENT

The IEEE Std. 1528 and CEI/IEC 62209 standards state that the system validation measurements must be performed using a reference waveguide meeting the fore mentioned return loss and mechanical dimension requirements. The validation measurement must be performed with the matching layer placed in the open end of the waveguide, with the waveguide and matching layer in direct contact with the phantom shell.

7.1 HEAD LIQUID MEASUREMENT

Frequency MHz	Relative permittivity (ϵ_r')		Conductivity (σ) S/m	
	required	measured	required	measured
5000	36.2 \pm 10 %		4.45 \pm 10 %	
5100	36.1 \pm 10 %		4.56 \pm 10 %	
5200	36.0 \pm 10 %	PASS	4.66 \pm 10 %	PASS
5300	35.9 \pm 10 %		4.76 \pm 10 %	
5400	35.8 \pm 10 %	PASS	4.86 \pm 10 %	PASS
5500	35.6 \pm 10 %		4.97 \pm 10 %	
5600	35.5 \pm 10 %	PASS	5.07 \pm 10 %	PASS
5700	35.4 \pm 10 %		5.17 \pm 10 %	
5800	35.3 \pm 10 %	PASS	5.27 \pm 10 %	PASS
5900	35.2 \pm 10 %		5.38 \pm 10 %	
6000	35.1 \pm 10 %		5.48 \pm 10 %	

7.2 SAR MEASUREMENT RESULT WITH HEAD LIQUID

At those frequencies, the target SAR value can not be generic. Hereunder is the target SAR value defined by MVG, within the uncertainty for the system validation. All SAR values are normalized to 1 W net power. In bracket, the measured SAR is given with the used input power.

Page: 7/13

This document shall not be reproduced, except in full or in part, without the written approval of MVG. The information contained herein is to be used only for the purpose for which it is submitted and is not to be released in whole or part without written approval of MVG.





SAR REFERENCE WAVEGUIDE CALIBRATION REPORT

Ref: ACR.273.5.18.SATU.A

Software	OPENSAR V4
Phantom	SN 20/09 SAM71
Probe	SN 18/11 EPG122
Liquid	Head Liquid Values 5200 MHz: eps':35.64 sigma : 4.67 Head Liquid Values 5400 MHz: eps':36.44 sigma : 4.87 Head Liquid Values 5600 MHz: eps':36.66 sigma : 5.17 Head Liquid Values 5800 MHz: eps':35.31 sigma : 5.31
Distance between dipole waveguide and liquid	0 mm
Area scan resolution	dx=8mm/dy=8mm
Zoon Scan Resolution	dx=4mm/dy=4m/dz=2mm
Frequency	5200 MHz 5400 MHz 5600 MHz 5800 MHz
Input power	20 dBm
Liquid Temperature	21 °C
Lab Temperature	21 °C
Lab Humidity	45 %

Frequency (MHz)	1 g SAR (W/kg)		10 g SAR (W/kg)	
	required	measured	required	measured
5200	159.00	165.77 (16.58)	56.90	57.20 (5.72)
5400	166.40	173.20 (17.32)	58.43	59.22 (5.92)
5600	173.80	179.61 (17.96)	59.97	60.98 (6.10)
5800	181.20	186.77 (18.68)	61.50	62.84 (6.28)

SAR MEASUREMENT PLOTS @ 5200 MHz

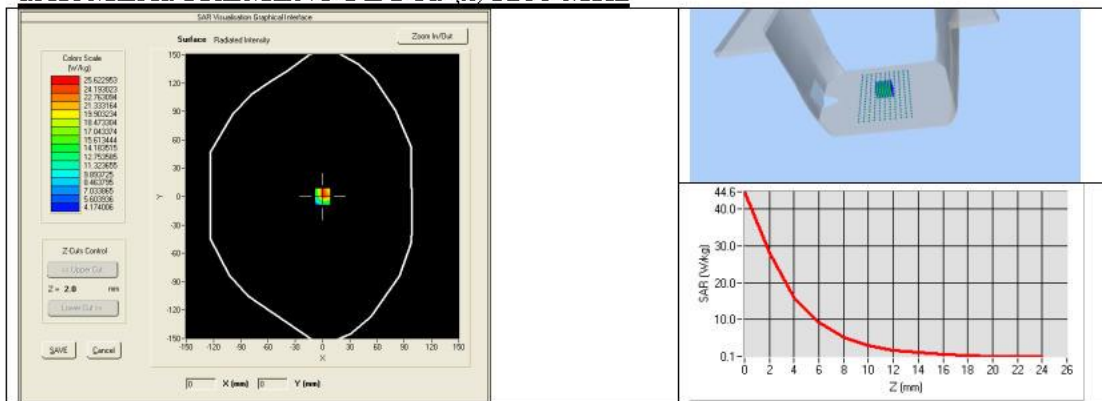

This document shall not be reproduced, except in full or in part, without the written approval of MVG. The information contained herein is to be used only for the purpose for which it is submitted and is not to be released in whole or part without written approval of MVG.





SAR REFERENCE WAVEGUIDE CALIBRATION REPORT

Ref: ACR.273.5.18.SATU.A

SAR MEASUREMENT PLOTS @ 5400 MHz

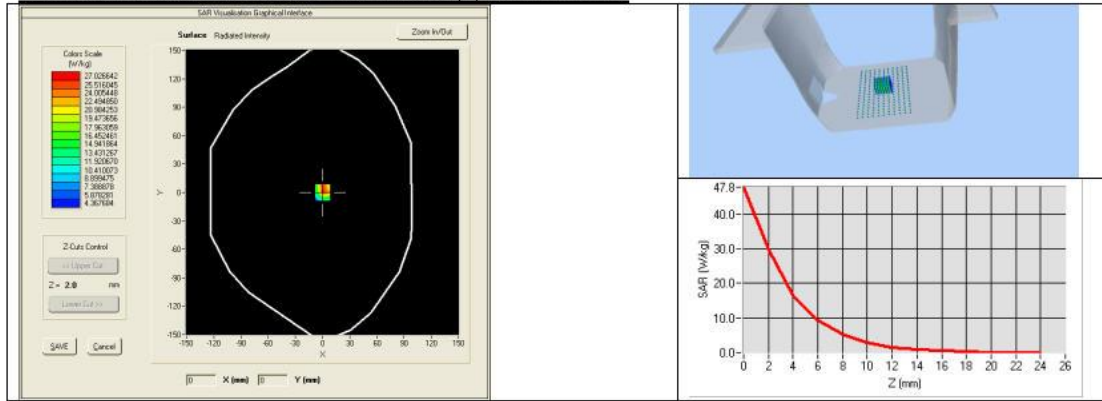

SAR MEASUREMENT PLOTS @ 5600 MHz

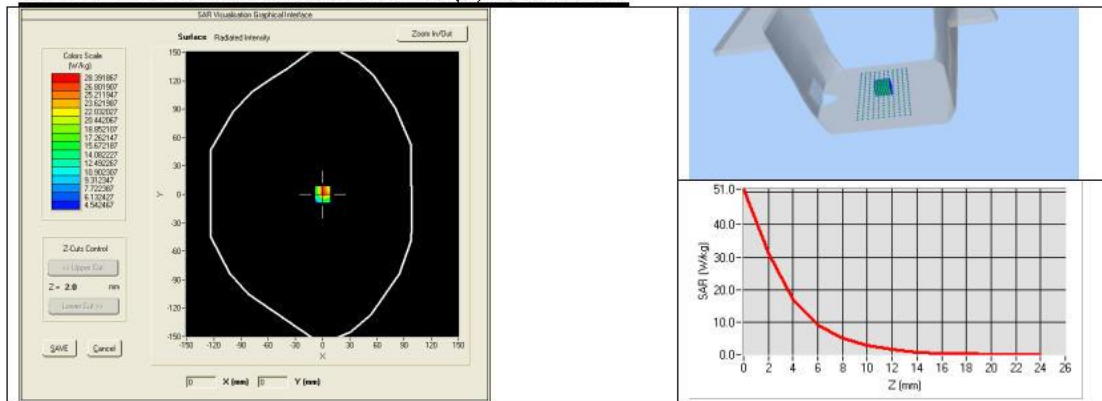

SAR MEASUREMENT PLOTS @ 5800 MHz

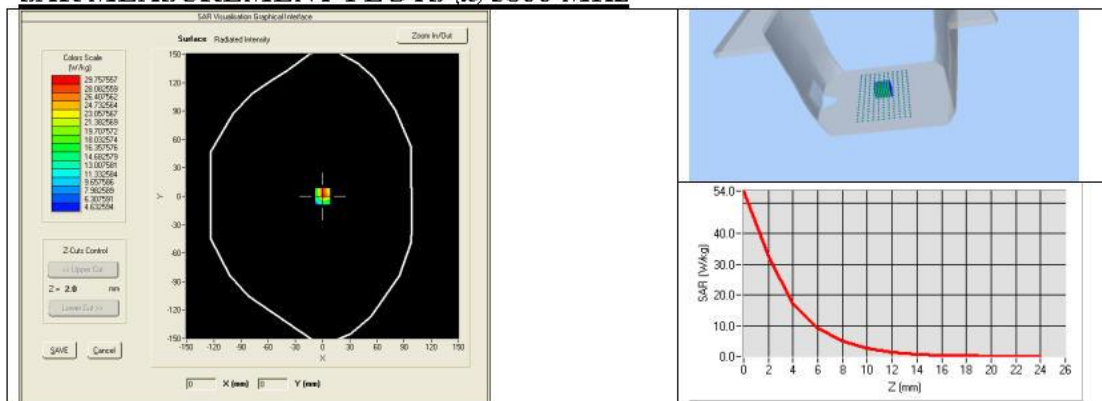

This document shall not be reproduced, except in full or in part, without the written approval of MVG. The information contained herein is to be used only for the purpose for which it is submitted and is not to be released in whole or part without written approval of MVG.





SAR REFERENCE WAVEGUIDE CALIBRATION REPORT

Ref: ACR.273.5.18.SATU.A

7.3 BODY LIQUID MEASUREMENT

Frequency MHz	Relative permittivity (ϵ_r')		Conductivity (σ) S/m	
	required	measured	required	measured
5200	49.0 \pm 10 %	PASS	5.30 \pm 10 %	PASS
5300	48.9 \pm 10 %		5.42 \pm 10 %	
5400	48.7 \pm 10 %	PASS	5.53 \pm 10 %	PASS
5500	48.6 \pm 10 %		5.65 \pm 10 %	
5600	48.5 \pm 10 %	PASS	5.77 \pm 10 %	PASS
5800	48.2 \pm 10 %	PASS	6.00 \pm 10 %	PASS

7.4 SAR MEASUREMENT RESULT WITH BODY LIQUID

Software	OPENSAR V4
Phantom	SN 20/09 SAM71
Probe	SN 18/11 EPG122
Liquid	Body Liquid Values 5200 MHz: ϵ_r' :48.64 sigma : 5.51 Body Liquid Values 5400 MHz: ϵ_r' :46.52 sigma : 5.77 Body Liquid Values 5600 MHz: ϵ_r' :46.79 sigma : 5.77 Body Liquid Values 5800 MHz: ϵ_r' :47.04 sigma : 6.10
Distance between dipole waveguide and liquid	0 mm
Area scan resolution	dx=8mm/dy=8mm
Zoon Sean Resolution	dx=4mm/dy=4m/dz=2mm
Frequency	5200 MHz 5400 MHz 5600 MHz 5800 MHz
Input power	20 dBm
Liquid Temperature	21 °C
Lab Temperature	21 °C
Lab Humidity	45 %

Frequency (MHz)	1 g SAR (W/kg)	10 g SAR (W/kg)
	measured	measured
5200	159.09 (15.91)	56.13 (5.61)
5400	164.56 (16.46)	57.31 (5.73)
5600	172.25 (17.23)	59.72 (5.97)
5800	177.77 (17.78)	61.06 (6.11)

Page: 10/13

This document shall not be reproduced, except in full or in part, without the written approval of MVG.
The information contained herein is to be used only for the purpose for which it is submitted and is not to be released in whole or part without written approval of MVG.





SAR REFERENCE WAVEGUIDE CALIBRATION REPORT

Ref: ACR.273.5.18.SATU.A

BODY SAR MEASUREMENT PLOTS @ 5200 MHz

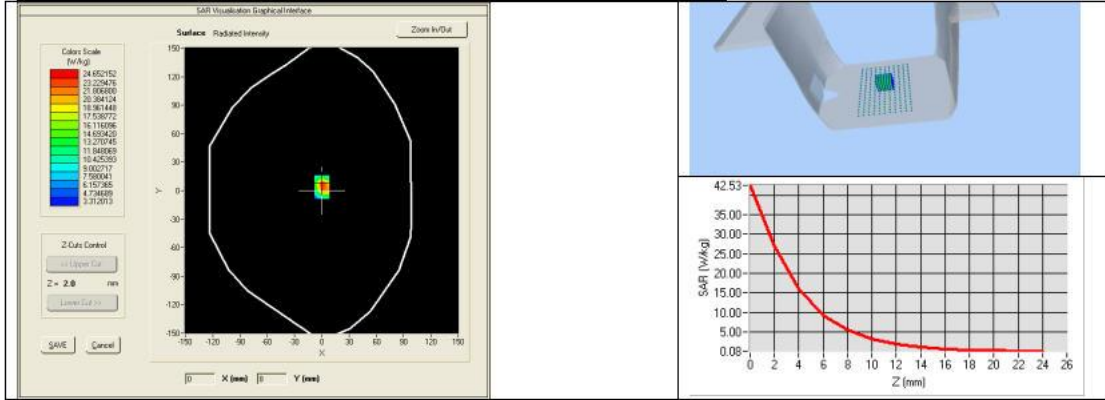

BODY SAR MEASUREMENT PLOTS @ 5400 MHz

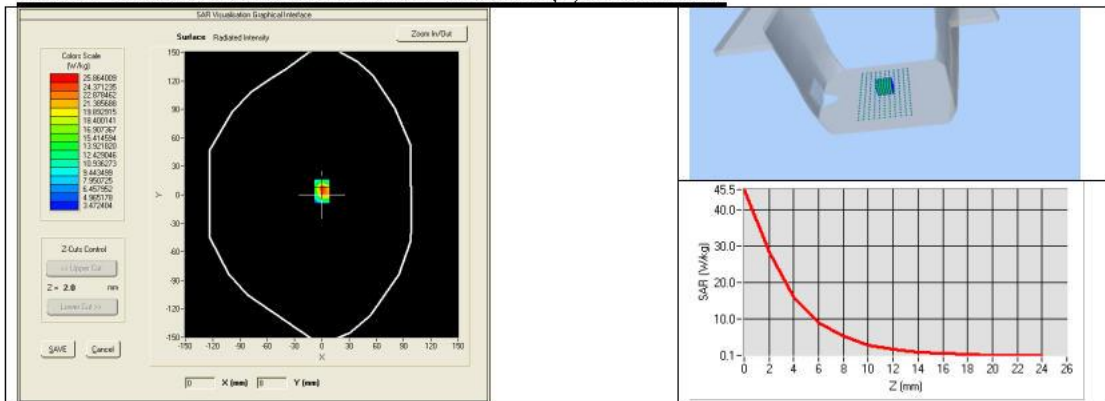

BODY SAR MEASUREMENT PLOTS @ 5600 MHz

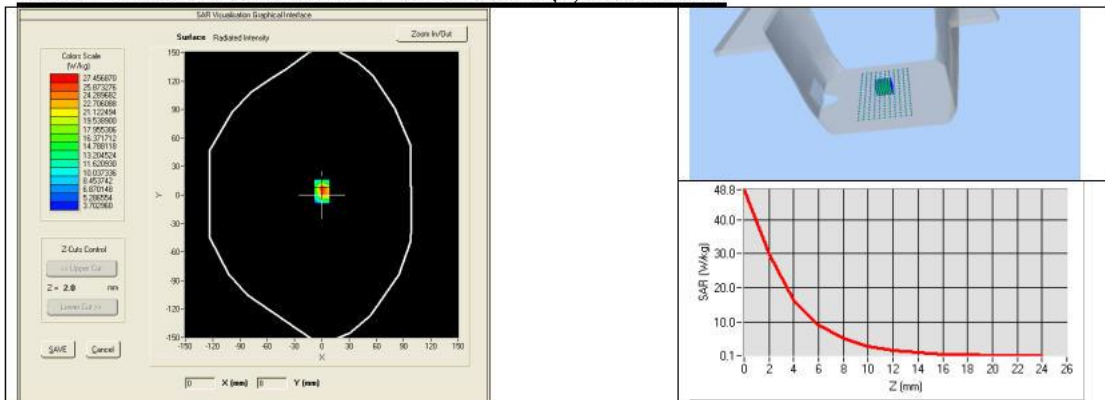

This document shall not be reproduced, except in full or in part, without the written approval of MVG. The information contained herein is to be used only for the purpose for which it is submitted and is not to be released in whole or part without written approval of MVG.





SAR REFERENCE WAVEGUIDE CALIBRATION REPORT

Ref: ACR.273.5.18.SAT.U.A

BODY SAR MEASUREMENT PLOTS @ 5800 MHz

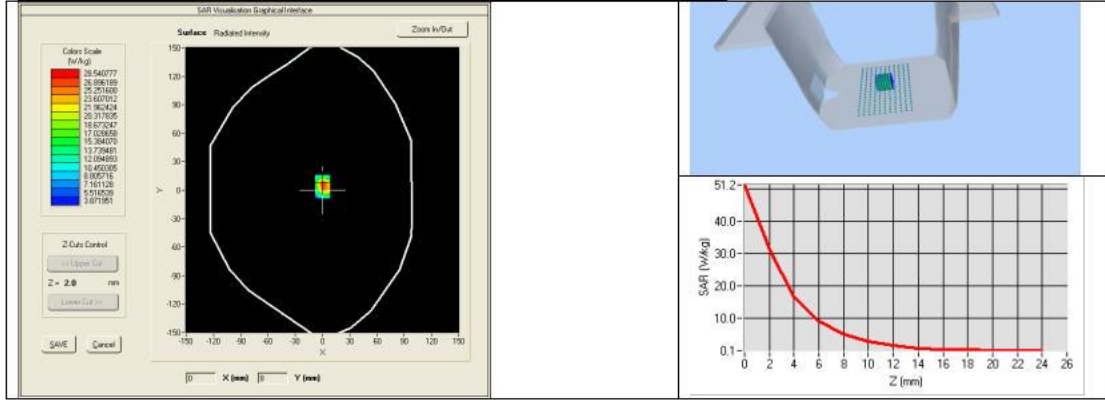

This document shall not be reproduced, except in full or in part, without the written approval of MVG. The information contained herein is to be used only for the purpose for which it is submitted and is not to be released in whole or part without written approval of MVG.





8 LIST OF EQUIPMENT

Equipment Summary Sheet					
Equipment Description	Manufacturer / Model	Identification No.	Current Calibration Date	Next Calibration Date	
Flat Phantom	MVG	SN-20/09-SAM71	Validated. No cal required.	Validated.	No cal required.
COMOSAR Test Bench	Version 3	NA	Validated. No cal required.	Validated.	No cal required.
Network Analyzer	Rhode & Schwarz ZVA	SN100132	06/2021	06/2024	
Calipers	Carrera	CALIPER-01	01/2020	01/2023	
Reference Probe	MVG	EPG122 SN 18/11	08/2021	08/2022	
Multimeter	Keithley 2000	1188656	01/2020	01/2023	
Signal Generator	Agilent E4438C	MY49070581	01/2020	01/2023	
Amplifier	Aethercomm	SN 046	Characterized prior to test. No cal required.	Characterized prior to test. No cal required.	
Power Meter	HP E4418A	US38261498	11/2020	11/2023	
Power Sensor	HP ECP-E26A	US37181460	01/2020	01/2023	
Directional Coupler	Narda 4216-20	01386	Characterized prior to test. No cal required.	Characterized prior to test. No cal required.	
Temperature and Humidity Sensor	Control Company	150798832	11/2020	11/2023	

Page: 13/13

*This document shall not be reproduced, except in full or in part, without the written approval of MVG.
The information contained herein is to be used only for the purpose for which it is submitted and is not to be released in whole or part without written approval of MVG.*





6. EUT TEST PHOTOGRAPHS

6.1 Photograph of liquid depth



Photograph of the depth in the Body Phantom (2450MHz, 15.8cm depth)

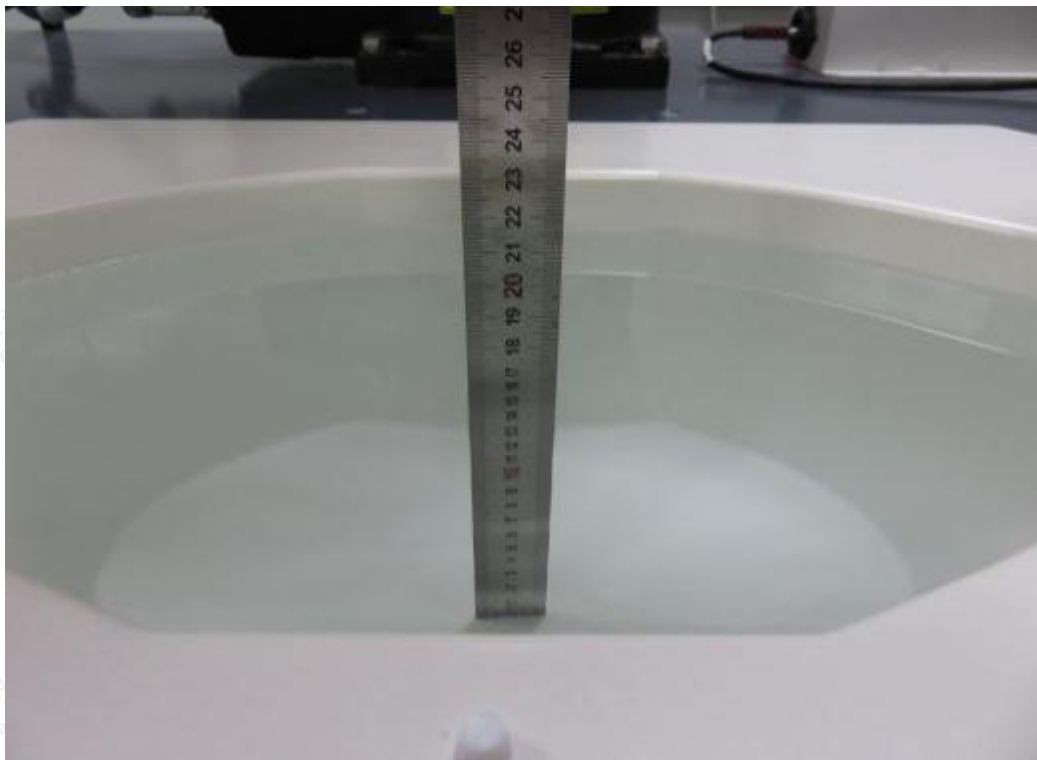

Photograph of the depth in the Body Phantom (5200MHz, 16.2cm depth)





Photograph of the depth in the Body Phantom (5300MHz, 16.1cm depth)

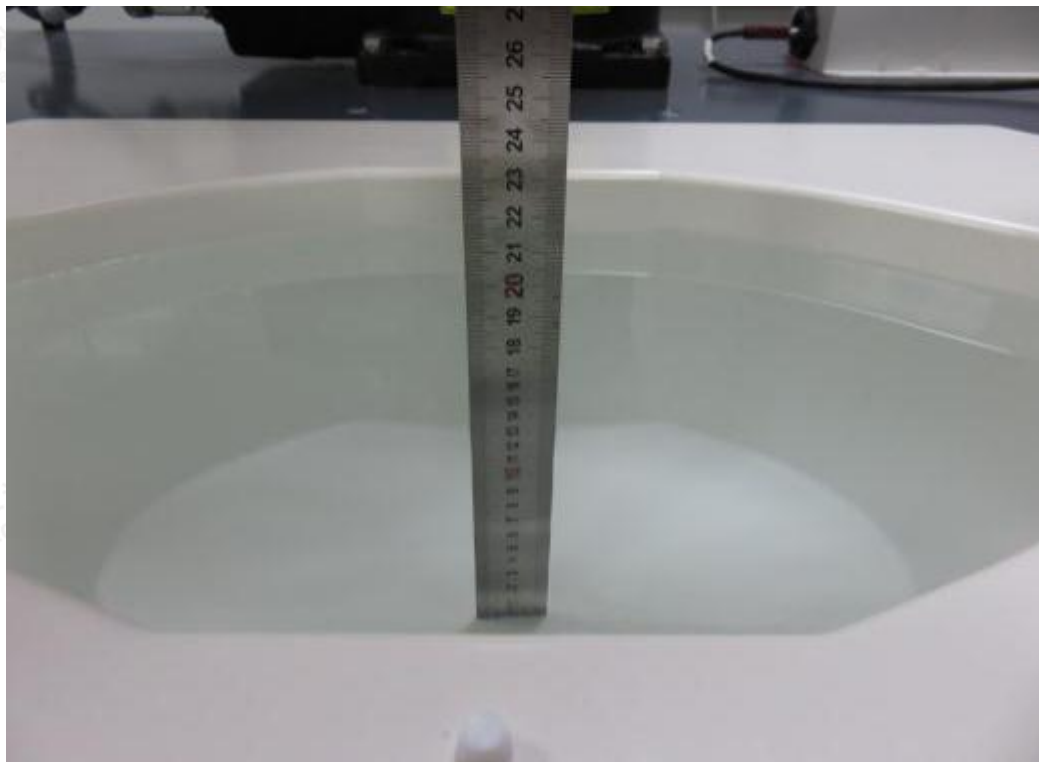

Photograph of the depth in the Body Phantom (5500MHz, 15.5cm depth)



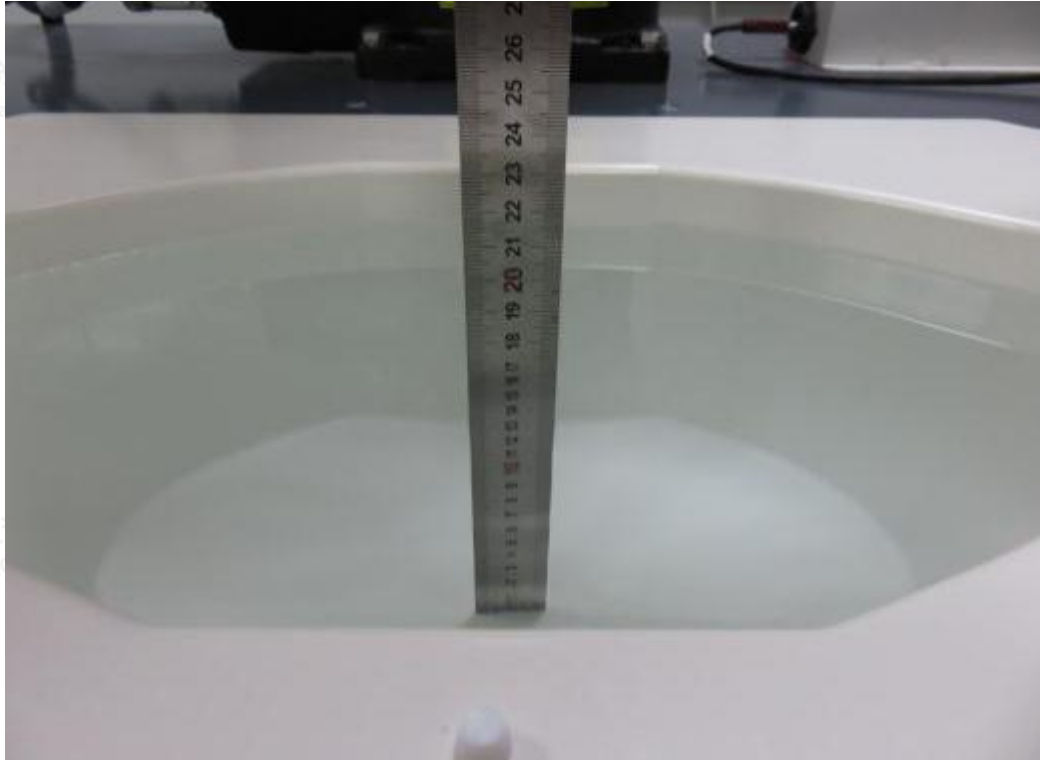

Photograph of the depth in the Body Phantom (5800MHz, 15.4cm depth)





7. PHOTOGRAPHS OF THE TEST

Please refer to separated files for Test Setup Photos of SAR.





8.EUT PHOTOGRAPHS

Please refer to separated files for Test Setup Photos of SAR.

.....**The End of Test Report**.....

