

Test Report No.: 2502050066-RF-US-01

**FCC Part 15, Subpart C
Test Report**

FCC ID: 2BBBF2407AB1

Applicant: Minami Acoustics Limited

Address: No.13, Maonan Road, Torch Development District, Zhongshan City,
Guangdong Province, P.R. China

Manufacturer: Minami Acoustics Limited

Address: No.13, Maonan Road, Torch Development District, Zhongshan City,
Guangdong Province, P.R. China

Product(s): Base speaker

Brand(s): N/A

Test Model(s): B12 SPK

Series Model(s): N/A

Test Date: Feb. 10, 2025 ~ Feb. 25, 2025

Issued Date: Feb. 26, 2025

Issued By: Hwa-Hsing (Dongguan) Testing Co., Ltd.

Address: No.101, Building N1, Yuyuan 2 Road, Yuyuan Industrial Park, HuangJiang
Town, Dongguan City, People's Republic of China

Test Firm Registration No.: 915896

Designation No.: CN1255

Standards: 47 CFR FCC Part 15, Subpart C (Section 15.247)
ANSI C63.10:2013

The above equipment has been tested by **Hwa-Hsing (Dongguan) Testing Co., Ltd.**, and found compliance with the requirement of the above standards. The test record, data evaluation & Equipment Under Test (EUT) configurations represented herein are true and accurate accounts of the measurements of the sample's EMC characteristics under the conditions specified in this report.

Prepared by :



Reviewed by :

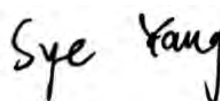

Wendy Lee

Sye Yang

Approved by :



Scott He

"This report is for your exclusive use. Any copying or replication of this report to or for any other person or entity, or use of our name or trademark, is permitted only with our prior written permission. This report sets forth our findings solely with respect to the test samples identified herein. Our report includes all the tests requested by you and the results thereof based upon the information that you provided to us. The report would be invalid without specific stamp of test institute and the signatures of tester and approver."

Lab: [Hwa-Hsing \(Dongguan\) Testing Co., Ltd.](#)Address: [No.101, Building N1, Yuyuan 2 Road, Yuyuan Industrial
Park, HuangJiang Town, Dongguan City, People's Republic
of China](#)Tel: [0769-83078199](#)Web.: [www.hwa-hsing.com](#)E-Mail: [customerservice.dg@hwa-hsing.com](#)

Release

[Ver. 1.5](#)

Table of Contents

Release Control Record	4
1 Summary of Test Results	5
1.1 Measurement Uncertainty	5
1.2 Modification Record	5
2 General Information	6
2.1 General Description of EUT	6
2.2 Description of Test Modes	7
2.3 Test Mode Applicability and Tested Channel Detail	8
2.4 Description of Support Units	10
2.5 Configuration of System under Test	11
3 Test Types and Results	12
3.1 Radiated Emission and Band-edge Measurement	12
3.1.1 Limits of Radiated Emission and Band-edge Measurement	12
3.1.2 Test Instruments	13
3.1.3 Test Procedures	14
3.1.4 Deviation from Test Standard	15
3.1.5 Test Setup	16
3.1.6 EUT Operating Conditions	17
3.1.7 Test Results	18
3.2 Conducted Emission Measurement	30
3.2.1 Limits of Conducted Emission Measurement	30
3.2.2 Test Instruments	30
3.2.3 Test Procedures	31
3.2.4 Test Setup	31
3.2.5 EUT Operating Condition	31
3.2.6 Deviation from Test Standard	31
3.2.7 Test Results	32
3.3 Number of Hopping Frequency Used	34
3.3.1 Limits of Hopping Frequency Used Measurement	34
3.3.2 Test Setup	34
3.3.3 Test Instruments	34
3.3.4 Test Procedure	34
3.3.5 Deviation from Test Standard	34
3.3.6 Test Results	35
3.4 Dwell Time on Each Channel	36
3.4.1 Limits of Dwell Time on Each Channel Measurement	36
3.4.2 Test Setup	36
3.4.3 Test Instruments	36
3.4.4 Test Procedures	36
3.4.5 Deviation from Test Standard	36
3.4.6 Test Results	37
3.5 Channel Bandwidth	39
3.5.1 Limits of Channel Bandwidth Measurement	39
3.5.2 Test Setup	39
3.5.3 Test Instruments	39
3.5.4 Test Procedure	39
3.5.5 Deviation from Test Standard	39
3.5.6 EUT Operating Condition	39
3.5.7 Test Results	40

Lab: [Hwa-Hsing \(Dongguan\) Testing Co., Ltd.](#)Address: [No.101, Building N1, Yuyuan 2 Road, Yuyuan Industrial Park, HuangJiang Town, Dongguan City, People's Republic of China](#)Tel: [0769-83078199](#)Web.: [www.hwa-hsing.com](#)E-Mail: [customerservice.dg@hwa-hsing.com](#)

Release

[Ver. 1.5](#)

Test Report No.: 2502050066-RF-US-01

3.6	Occupied Bandwidth Measurement.....	42
3.6.1	Test Setup.....	42
3.6.2	Test Instruments.....	42
3.6.3	Test Procedure.....	42
3.6.4	Deviation from Test Standard.....	42
3.6.5	EUT Operating Conditions.....	42
3.6.6	Test Results.....	43
3.7	Hopping Channel Separation.....	45
3.7.1	Limits of Hopping Channel Separation Measurement.....	45
3.7.2	Test Setup.....	45
3.7.3	Test Instruments.....	45
3.7.4	Test Procedure.....	45
3.7.5	Deviation from Test Standard.....	45
3.7.6	Test Results.....	46
3.8	Maximum Output Power.....	47
3.8.1	Limits of Maximum Output Power Measurement.....	47
3.8.2	Test Setup.....	47
3.8.3	Test Instruments.....	47
3.8.4	Test Procedure.....	47
3.8.5	Deviation from Test Standard.....	49
3.8.6	EUT Operating Condition.....	49
3.8.7	Test Results.....	50
3.9	Conducted Out of Band Emission Measurement.....	52
3.9.1	Limits of Conducted Out of Band Emission Measurement.....	52
3.9.2	Test Setup.....	52
3.9.3	Test Instruments.....	52
3.9.4	Test Procedure.....	53
3.9.5	Deviation from Test Standard.....	53
3.9.6	EUT Operating Condition.....	53
3.9.7	Test Results.....	54
4	Pictures of Test Arrangements.....	59
5	Test Instruments.....	60
	Appendix – Information on the Testing Laboratories.....	61

Lab: [Hwa-Hsing \(Dongguan\) Testing Co., Ltd.](#)Address: [No.101, Building N1, Yuyuan 2 Road, Yuyuan Industrial Park, HuangJiang Town, Dongguan City, People's Republic of China](#)Tel: [0769-83078199](tel:0769-83078199)Web.: www.hwa-hsing.comE-Mail: customerservice.dg@hwa-hsing.com

Release

[Ver. 1.5](#)

Test Report No.: 2502050066-RF-US-01

Release Control Record

Issue No.	Description	Date Issued
2502050066-RF-US-01	Original Release	Feb. 26, 2025

Lab: [Hwa-Hsing \(Dongguan\) Testing Co., Ltd.](#)Address: [No.101, Building N1, Yuyuan 2 Road, Yuyuan Industrial Park, HuangJiang Town, Dongguan City, People's Republic of China](#)Tel: [0769-83078199](#)Web.: [www.hwa-hsing.com](#)E-Mail: customerservice.dg@hwa-hsing.comRelease
Ver. 1.5

1 Summary of Test Results

47 CFR FCC Part 15, Subpart C (Section 15.247) KDB 558074 D01 15.247 Meas Guidance v05r02 ANSI C63.10:2013;			
FCC Clause	Test Item	Result	Remarks
15.207	AC Power Conducted Emission	Pass	Meet the requirement of limit.
15.247(a)(1) (iii)	Number of Hopping Frequency Used	Pass	Meet the requirement of limit.
15.247(a)(1) (iii)	Dwell Time on Each Channel	Pass	Meet the requirement of limit.
15.247(a)(1)	1. Hopping Channel Separation 2. Spectrum Bandwidth of a Frequency Hopping Sequence Spread Spectrum System	Pass	Meet the requirement of limit.
15.247(b)	Maximum Peak Output Power	Pass	Meet the requirement of limit.
---	Occupied Bandwidth Measurement	Pass	Reference only
15.205 & 209	Radiated Emissions	Pass	Meet the requirement of limit.
15.247(d)	Band Edge Measurement	Pass	Meet the requirement of limit.
15.247(d)	Antenna Port Emission	Pass	Meet the requirement of limit.
15.203	Antenna Requirement	Pass	No antenna connector is used.

Note

- If the Frequency Hopping System operating in 2400-2483.5MHz band and the output power less than 125mW. The hopping channel carrier frequencies separated by a minimum of 25kHz or two-thirds of the 20dB bandwidth of hopping channel whichever is greater.
- The EUT has been verified to comply with the requirements of FCC Part 15, Subpart B, Class B (sDoC). The test report has been issued separately.

1.1 Measurement Uncertainty

Where relevant, the following measurement uncertainty levels have been estimated for tests performed on the EUTas specified in CISPR 16-4-2:

The listed uncertainties are the worst-case uncertainty for the entire range of measurement. Please note that the uncertainty values are provided for informational purposes only and are not used in determining the PASS/FAIL results.

Measurement	Frequency	Expanded Uncertainty (k=2) (±)
Radiated Emissions up to 1 GHz	9KHz ~ 30MHz	2.16 dB
	30MHz ~ 1000MHz	3.56 dB
Radiated Emissions above 1 GHz	1GHz ~ 6GHz	4.71 dB
	6GHz~18GHz	4.84 dB
	18GHz ~ 40GHz	5.73 dB

Note: This uncertainty represents an expanded uncertainty expressed at approximately the 95% confidence level using a coverage factor of k = 2.

1.2 Modification Record

There were no modifications required for compliance.

Lab: [Hwa-Hsing \(Dongguan\) Testing Co., Ltd.](#)

Address: [No.101, Building N1, Yuyuan 2 Road, Yuyuan Industrial Park, HuangJiang Town, Dongguan City, People's Republic of China](#)

Tel: [0769-83078199](tel:0769-83078199)

Web.: www.hwa-hsing.com

E-Mail: customerservice.dg@hwa-hsing.com

Release

[Ver. 1.5](#)

2 General Information

2.1 General Description of EUT

Product(s)	Base speaker
Test Model(s)	B12 SPK
Sample No.	HS2502050066-S002
Series Model(s)	N/A
Status of EUT	Engineering Prototype
Power Supply Rating	Input: 29.0Vdc 3.0A from adapter
Modulation Type	GFSK, $\pi/4$ DQPSK, 8DPSK
Transfer Rate	1Mbps, 2Mbps, 3Mbps
Operating Frequency	2402 ~ 2480MHz
Number of Channel	79
Max. Output Power	0.02dBm-Peak
Antenna Type and Antenna Gain	PIFA Antenna; 2.79dBi Gain
Antenna Connector	N/A
Accessory Device	1* AC/DC Switching power supply

Note:

1. Please refer to the EUT photo document (Reference No.: 2502050066-01&02) for detailed product photo.
2. The above EUT information is declared by manufacturer and for more detailed features description, please refer to the manufacturer's specifications or User's Manual.
3. For the test results, the EUT had been tested with all conditions, and only the worst case was shown in the test report.
4. The EUT is powered by adapter as list as below:

Adapter (fixed plug)	
Brand:	N/A
Model:	W87RA07-290030
Input:	100-240V~ 4.0A 50/60Hz
Output:	29.0Vdc 3.0A 87.0W
DC Line:	Unshielded, Detachable, 80cm
AC Line:	Unshielded, Detachable, 240cm

2.2 Description of Test Modes

79 channels are provided to this EUT:

Channel	Freq. (MHz)	Channel	Freq. (MHz)	Channel	Freq. (MHz)	Channel	Freq. (MHz)
0	2402	20	2422	40	2442	60	2462
1	2403	21	2423	41	2443	61	2463
2	2404	22	2424	42	2444	62	2464
3	2405	23	2425	43	2445	63	2465
4	2406	24	2426	44	2446	64	2466
5	2407	25	2427	45	2447	65	2467
6	2408	26	2428	46	2448	66	2468
7	2409	27	2429	47	2449	67	2469
8	2410	28	2430	48	2450	68	2470
9	2411	29	2431	49	2451	69	2471
10	2412	30	2432	50	2452	70	2472
11	2413	31	2433	51	2453	71	2473
12	2414	32	2434	52	2454	72	2474
13	2415	33	2435	53	2455	73	2475
14	2416	34	2436	54	2456	74	2476
15	2417	35	2437	55	2457	75	2477
16	2418	36	2438	56	2458	76	2478
17	2419	37	2439	57	2459	77	2479
18	2420	38	2440	58	2460	78	2480
19	2421	39	2441	59	2461	-	-

2.3 Test Mode Applicability and Tested Channel Detail

EUT Configure Mode	Applicable test items	X-Axis	Y-Axis	Z-Axis	Voltage Supply
Conducted	AC Power Conducted Emission	N/A	N/A	N/A	AC120V 60Hz
Radiated	Radiated Emissions	√	√	√	AC120V 60Hz
Antenna Port Conducted Measurement	Number of Hopping Frequency Used	N/A	N/A	N/A	
	Dwell Time on Each Channel	N/A	N/A	N/A	
	Band Edge Measurement	N/A	N/A	N/A	
	Antenna Port Emission	N/A	N/A	N/A	
	Conducted power	N/A	N/A	N/A	
	Hopping Channel Separation	N/A	N/A	N/A	
	Spectrum Bandwidth of a Frequency Hopping Sequence Spread Spectrum System	N/A	N/A	N/A	

- *: The EUT had been pre-tested on the positioned of each 3 Axis. The worst case was found when positioned on **X-plane**.
- "N/A" means no effect.

Evaluation of difference data rate:

Applicable test items	Modulation Type			The Worst-case modes recording in report
	GFSK	$\pi/4$ DQPSK	8DPSK	
Radiated Emissions	√	-	√	GFSK& $\pi/8$ DPSK
Antenna Port Conducted Measurement	√	-	√	GFSK& $\pi/8$ DPSK

Test Condition:

Applicable test items	Environmental Conditions	Test Date	Tested by
Radiated Emissions	24.0deg. C, 55%RH	Feb. 13, 2025 ~ Feb. 22, 2025	Hua
Antenna Port Conducted Measurement	25.5deg. C, 58%RH	Feb. 13, 2025	Sye Yang

- Pre-Scan has been conducted to determine the worst-case mode from all possible combinations between available modulations, data rates and antenna ports (if EUT with antenna diversity architecture). Following channel(s) was (were) selected for the final test as listed below.

Radiated Emission Test (Above 1 GHz):

EUT Configure Mode	Available Channel	Tested Channel	Modulation Technology	Modulation Type	Packet Type
-	0 to 78	0, 39, 78	FHSS	GFSK	DH5
-	0 to 78	0, 39, 78	FHSS	8DPSK	3DH5

Radiated Emission Test (Below 1 GHz):

EUT Configure Mode	Available Channel	Tested Channel	Modulation Technology	Modulation Type	Packet Type
-	0 to 78	0	FHSS	GFSK	DH5
-	0 to 78	0	FHSS	8DPSK	3DH5

Power Line Conducted Emission Test:

EUT Configure Mode	Available Channel	Tested Channel	Modulation Technology	Modulation Type	Packet Type
-	0 to 78	39	FHSS	GFSK	DH5

Antenna Port Conducted Measurement:

This item includes all test value of each mode, but only includes spectrum plot of worst value of each mode.

EUT Configure Mode	Available Channel	Tested Channel	Modulation Technology	Modulation Type	Packet Type
-	0 to 78	0, 39, 78	FHSS	GFSK	DH5
-	0 to 78	0, 39, 78	FHSS	8DPSK	3DH5

Test Report No.: 2502050066-RF-US-01

2.4 Description of Support Units

The EUT has been tested as an independent unit together with other necessary accessories or support units. The following support units or accessories were used to form a representative test configuration during the tests.

No.	Product	Brand	Model No.	Serial No.	FCC ID
1	Notebook	HUAWEI	NbD-WFH9	EUEPM21725002655	N/A
2	Notebook	DELL	Inspiron 14R Aluminum Edition	6WPG9-63PV4-RBPF2-T6RHW-W9GBP	N/A

No.	Signal Cable Description of The Above Support Units
1	USB extension cord: Unshielded, Detachable 1.2m;

Lab: [Hwa-Hsing \(Dongguan\) Testing Co., Ltd.](#)Address: [No.101, Building N1, Yuyuan 2 Road, Yuyuan Industrial Park, HuangJiang Town, Dongguan City, People's Republic of China](#)Tel: [0769-83078199](#)Web.: [www.hwa-hsing.com](#)E-Mail: [customerservice.dg@hwa-hsing.com](#)Release
[Ver. 1.5](#)

2.5 Configuration of System under Test

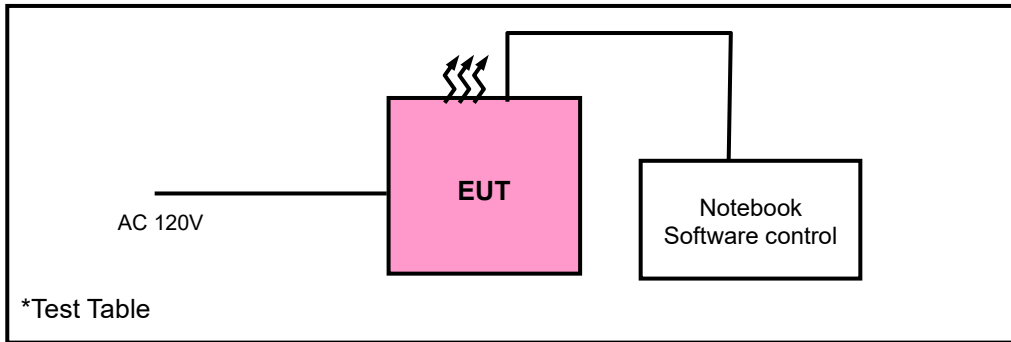

3 Test Types and Results**3.1 Radiated Emission and Band-edge Measurement**

3.1.1 Limits of Radiated Emission and Band-edge Measurement

Radiated emissions which fall in the restricted bands must comply with the radiated emission limits specified as below table. Other emissions shall be at least 20 dB below the highest level of the desired power:

Frequencies (MHz)	Field Strength (microvolts/meter)	Measurement Distance (meters)
0.009 ~ 0.490	2400/F(kHz)	300
0.490 ~ 1.705	24000/F(kHz)	30
1.705 ~ 30.0	30	30
30 ~ 88	100	3
88 ~ 216	150	3
216 ~ 960	200	3
Above 960	500	3

* DTS emissions in non-restricted frequency bands Subclause 11.11 of ANSI C63.10 is applicable.

* DTS emissions in restricted frequency bands Subclause 11.12 of ANSI C63.10 is applicable.

Note:

1. The lower limit shall apply at the transition frequencies.
2. Emission level (dBuV/m) = 20 log Emission level (uV/m).
3. For frequencies above 1000 MHz, the field strength limits are based on average detector, however, the peak field strength of any emission shall not exceed the maximum permitted average limits, specified above by more than 20 dB under any condition of modulation.

3.1.2 Test Instruments

Radiated emission below 30MHz:

Equipment	Manufacturer	Model No.	Serial No.	Next Cal.
EMI Test Receiver	Rohde&Schwarz	ESR7	100962	2025-07-25
3m Semi-anechoic Chamber	MAORUI	9m*6m*6m	NSEMC003	2026-03-12*
Test software	FARAD	FARAD	EZ EMCV1.1.4.2	N/A
Loop Antenna	EMCI	HLA 6121	56735	2025-05-03
Antenna Tower	MF	MFA-440H	NA	NA
Turn Table	MF	MFT-201SS	NA	NA
Antenna Tower&Turn Table Controller	MF	MF-7802	NA	NA

Frequency Range below 1GHz:

Equipment	Manufacturer	Model No.	Serial No.	Next Cal.
EMI Test Receiver (9kHz~3GHz)	Rohde&Schwarz	ESPI 7	101978	2025-07-25
Broadband antenna (25MHz~2500MHz)	Schwarzbeck	VULB 9168	937	2025-07-25
3m Semi-anechoic Chamber	MAORUI	9m*6m*6m	HS-2018037	2026-03-12*
Signal Amplifier (30MHz~1000MHz)	Com-power	PAM-103	18020051	2025-07-25
Attenuator	R&S	TS2GA-6dB	18101101	N/A
Test software	FARAD	EZ EMC V1.1.4.2	N/A	N/A
Broadcast test system	R&S	SFU	100410	2025-07-25

Frequency Range above 1GHz:

Equipment	Manufacturer	Model No.	Serial No.	Next Cal.
EMI Test Receiver	Rohde&Schwarz	ESPI 7	101978	2025-07-25
3m Semi-anechoic Chamber	MAORUI	9m*6m*6m	NSEMC003	2026-03-12*
Test software	FARAD	EZ EMCV1.1.4.2	N/A	N/A
Digital Multimeter	FLUKE	15B+	43512617WS	2025-07-25
Horn Antenna	Schwarzbeck	BBHA 9120 D	1959	2025-08-15
Spectrum Analyzer	Rohde&Schwarz	FSV-40N	101783	2025-07-25
Broadband Coaxial Pre-amplifier	Schwarzbeck	BBV 9718	25	2025-07-25
Pre-Amplifier	EMCI	EMC 184045SE	9870709	2025-07-25
Spectrum	Keysight	N9020A	MY51240612	2025-07-25
Broadcast test system	R&S	SFU	100410	2025-07-25
Antenna Tower	MF	MFA-440H	NA	NA
Turn Table	MF	MFT-201SS	NA	NA
Antenna Tower&Turn Table Controller	MF	MF-7802	NA	NA

Note:

1. The calibration interval of the above test instruments is 12 months or 36 months (*).
2. The test was performed in 966.

3.1.3 Test Procedures

a. Peak emission levels are measured by setting the instrument as follow:

- 1) RBW&VBWsetting as a function of frequency:

Frequency	RBW	VBW
9kHz~150kHz	200Hz	600Hz
0.15MHz~30MHz	9kHz	30kHz
30MHz~1000MHz	120kHz	300kHz
>1000MHz	1MHz	3MHz

- 2) Detector = peak.
- 3) Sweep time = auto.
- 4) Trace mode = max hold.
- 5) Allow sweeps to continue until the trace stabilizes. (Note that the required measurement time may be lengthened for low-duty-cycle applications.)

Note: If the peak-detected amplitude can be shown to comply with the average limit, then it is not necessary to perform a separate average measurement

b. Average emission levels are measured by setting the instrument as follow:

- **Trace averaging with continuous EUT transmission at full power**

If the EUT can be configured or modified to transmit continuously ($D \geq 98\%$), then the average emission levels shall be measured using the following method (with EUT transmitting continuously):

- 1) RBW=1 MHz (unless otherwise specified).
- 2) $VBW \geq 3 * RBW$.
- 3) Detector =RMS
- 4) Sweep time = auto.
- 5) Perform a trace average of at least 100 traces.

- **Trace averaging across ON and OFF times of the EUT transmissions followed by duty cycle correction**

If continuous transmission of the EUT ($D \geq 98\%$) cannot be achieved and the duty cycle is constant (duty cycle variations are less than $\pm 2\%$), then the following procedure shall be used

- 1) The EUT shall be configured to operate at the maximum achievable duty cycle.
- 2) Measure the duty cycle D of the transmitter output signal as described in 11.6.
- 3) RBW=1 MHz (unless otherwise specified).
- 4) $VBW \geq 3 * RBW$.
- 5) Detector =RMS
- 6) Sweep time = auto.
- 7) Perform a trace average of at least 100 traces.

A correction factor shall be added to the measurement results prior to comparing with the emission limit to compute the emission level that would have been measured had the test been performed at 100% duty cycle. The correction factor is computed as follows:

*If power averaging (rms) mode was used in step 5), then the applicable correction factor is $[10 \log(1/D)]$, where D is the duty cycle.

**If linear voltage averaging mode was used in step f), then the applicable correction factor is $[20 \log(1/D)]$, where D is the duty cycle.

***If a specific emission is demonstrated to be continuous ($D > 98\%$) rather than turning ON and OFF with the transmit cycle, then no duty cycle correction is required for that.

Test Report No.: 2502050066-RF-US-01

● Reduced VBW Averaging across ON and OFF times of the EUT transmissions with max hold

If continuous transmission of the EUT ($D > 98\%$) cannot be achieved and the duty cycle is not constant (duty cycle variations exceed $\pm 2\%$), then the following procedure shall be used:

- 1) RBW = 1 MHz.
 - 2) $VBW \geq 1/T$.
 - 3) Detector = peak
 - 4) Sweep time = auto.
 - 5) Trace mode = max hold.
 - 6) Allow max hold to run for at least $[50 \times (1/D)]$ traces
- c. The EUT was placed on the top of a rotating table 0.8 meters (below 1GHz) / 1.5 meters (Above 1GHz) above the reference ground. The table was rotated 360 degrees to determine the position of the highest radiation.
- d. The EUT was set 3 meters away from the interference-receiving antenna (Below 1GHz) & (Above 1GHz), which was mounted on the top of a variable-height antenna tower.
- e. The height of antenna is varied from one meter to four meters above the ground to determine the maximum value of the field strength. Both horizontal and vertical polarizations of the antenna are set to make the measurement.
- f. For each suspected emission, the EUT was arranged to its worst case and then the antenna was tuned to heights from 1 meter to 4 meters and the rotatable table was turned from 0 degrees to 360 degrees to find the maximum reading.
- g. The test-receiver system was set to quasi-peak detect function and specified bandwidth with maximum hold mode when the test frequency is below 1 GHz.
- h. The test-receiver system was set to peak and average detected function and specified bandwidth with maximum hold mode when the test frequency is above 1 GHz. If the peak reading value also meets average limit, measurement with the average detector is unnecessary.

Note:

1. Test procedures for measuring FHSS device: The use of a duty cycle correction factor (DCCF) is permitted for calculating average radiated field strength emission levels for an FHSS device in 15.247. This DCCF can be applied when the unwanted emission limit is subject to an average field strength limit (e.g., within a Government Restricted band) and the conditions specified in Section 15.35(c) can be satisfied. The average radiated field strength is calculated by subtracting the DCCF from the maximum radiated field strength level as determined through measurement. The maximum radiated field strength level represents the worst-case (maximum amplitude) RMS measurement of the emission(s) during continuous transmission (i.e., not including any time intervals during which the transmitter is off or is transmitting at a reduced power level). It is also acceptable to apply the DCCF to a measurement performed with a peak detector instead of the specified RMS power averaging detector. Note that Section 15.35(c) specifies that the DCCF shall represent the worst-case (greatest duty cycle) over any 100 msec transmission period. Subclause 7.5 of ANSI C63.10 provides additional measurement guidance applicable to determination of the DCCF.
2. All modes of operation were investigated and the worst-case emissions are reported.

3.1.4 Deviation from Test Standard

No deviation.

Lab: [Hwa-Hsing \(Dongguan\) Testing Co., Ltd.](#)Address: [No.101, Building N1, Yuyuan 2 Road, Yuyuan Industrial Park, HuangJiang Town, Dongguan City, People's Republic of China](#)Tel: [0769-83078199](#)Web.: [www.hwa-hsing.com](#)E-Mail: customerservice.dg@hwa-hsing.comRelease
[Ver. 1.5](#)

3.1.5 Test Setup

Radiated emission below 30MHz:

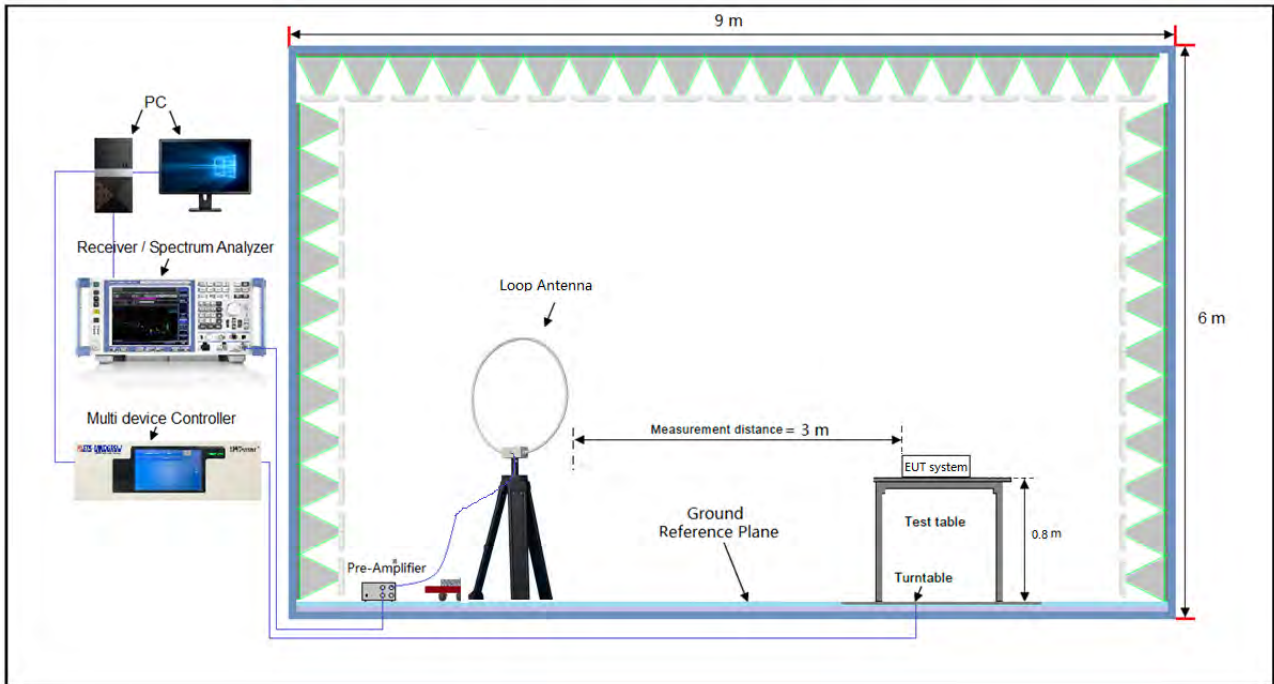

Frequency Range below 1GHz:

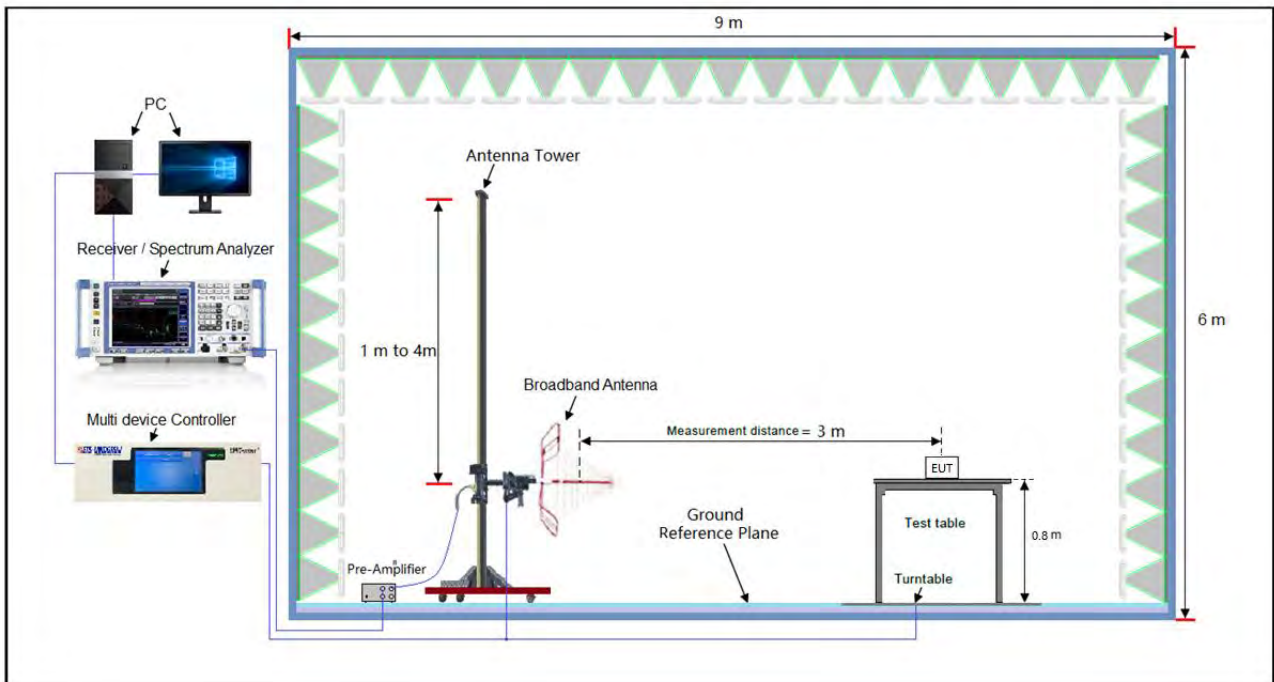

Frequency Range above 1GHz:

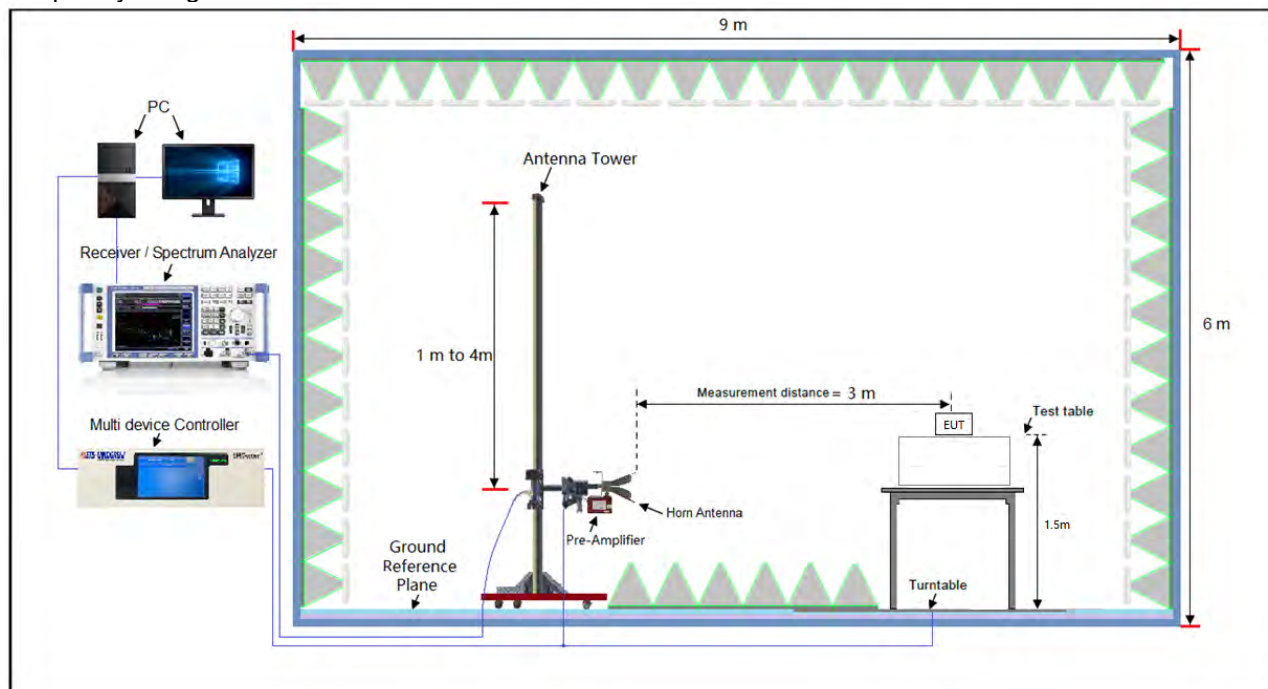

*For the actual test configuration, please refer to the attached file (Test Setup Photo).

3.1.6 EUT Operating Conditions

Set the EUT under transmission condition continuously at specific channel frequency.

Test Report No.: 2502050066-RF-US-01

3.1.7 Test Results

9 kHz ~ 30 MHz Data:

The amplitude of spurious emissions attenuated more than 20 dB below the permissible value is not required to be report.

30 MHz ~ 1GHz Worst-Case Data:

Frequency Range	30MHz ~ 1GHz	Detector Function	Peak (PK) Quasi-peak (QP)
Test Channel	Channel 0		

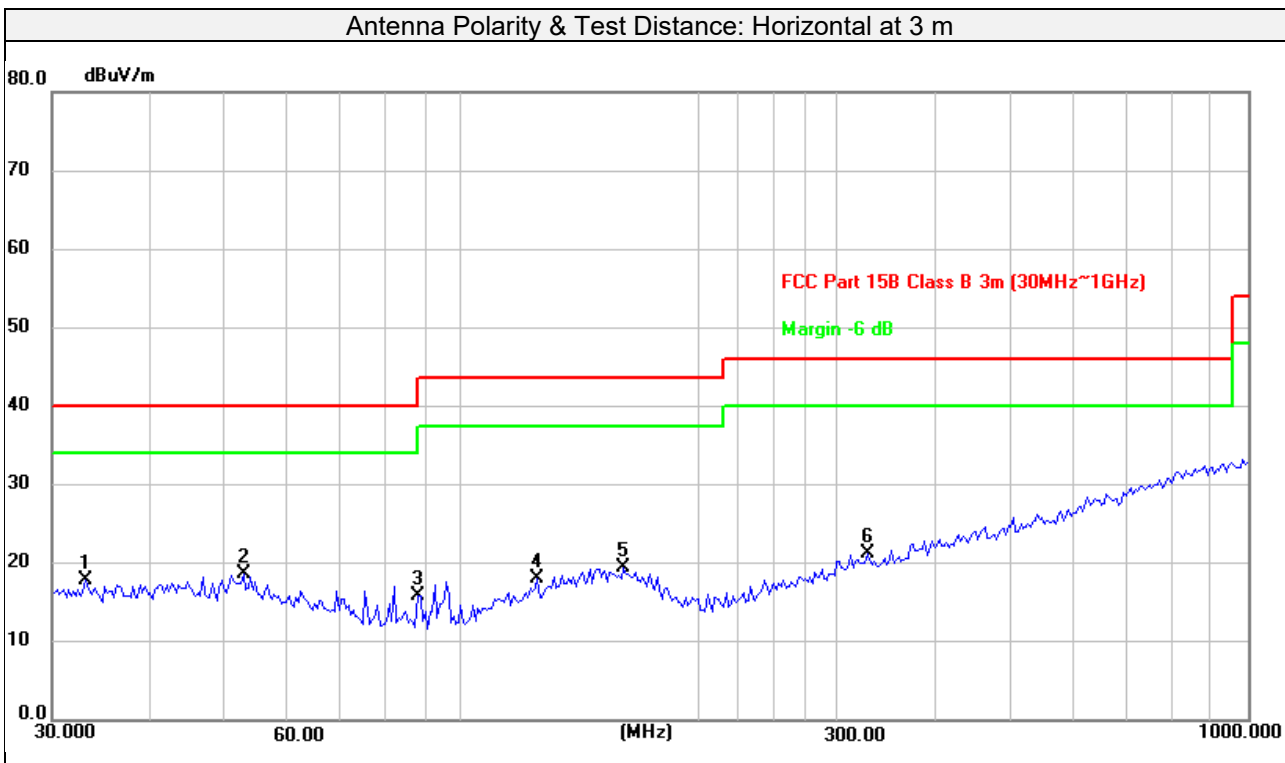

No.	Frequency (MHz)	Reading (dBuV)	Factor (dB)	Emission Level (dBuV/m)	Limit (dBuV/m)	Margin (dB)	Det.	Antenna Height (cm)	Table Angle (Degree)
1	33.0950	34.47	-16.55	17.92	40.00	-22.08	peak	358	67
2	52.5753	33.69	-15.12	18.57	40.00	-21.43	peak	223	198
3	87.7248	35.34	-19.42	15.92	40.00	-24.08	peak	354	191
4	124.5690	33.53	-15.42	18.11	43.50	-25.39	peak	210	163
5	160.3456	32.94	-13.45	19.49	43.50	-24.01	peak	145	37
6	327.8873	32.72	-11.40	21.32	46.00	-24.68	peak	222	220

Remarks:

- 1.Emission Level = Read Level + Factor (Antenna Factor + Cable Loss - Preamp Factor)
- 2.Margin value = Emission level – Limit value

Lab: [Hwa-Hsing \(Dongguan\) Testing Co., Ltd.](#)

Address: [No.101, Building N1, Yuyuan 2 Road, Yuyuan Industrial Park, HuangJiang Town, Dongguan City, People's Republic of China](#)

Tel: [0769-83078199](tel:0769-83078199)

Web.: www.hwa-hsing.com

E-Mail: customerservice.dg@hwa-hsing.com

Release

[Ver. 1.5](#)

SS

Frequency Range	30MHz ~ 1GHz	Detector Function	Peak (PK) Quasi-peak (QP)
Test Channel	Channel 0		

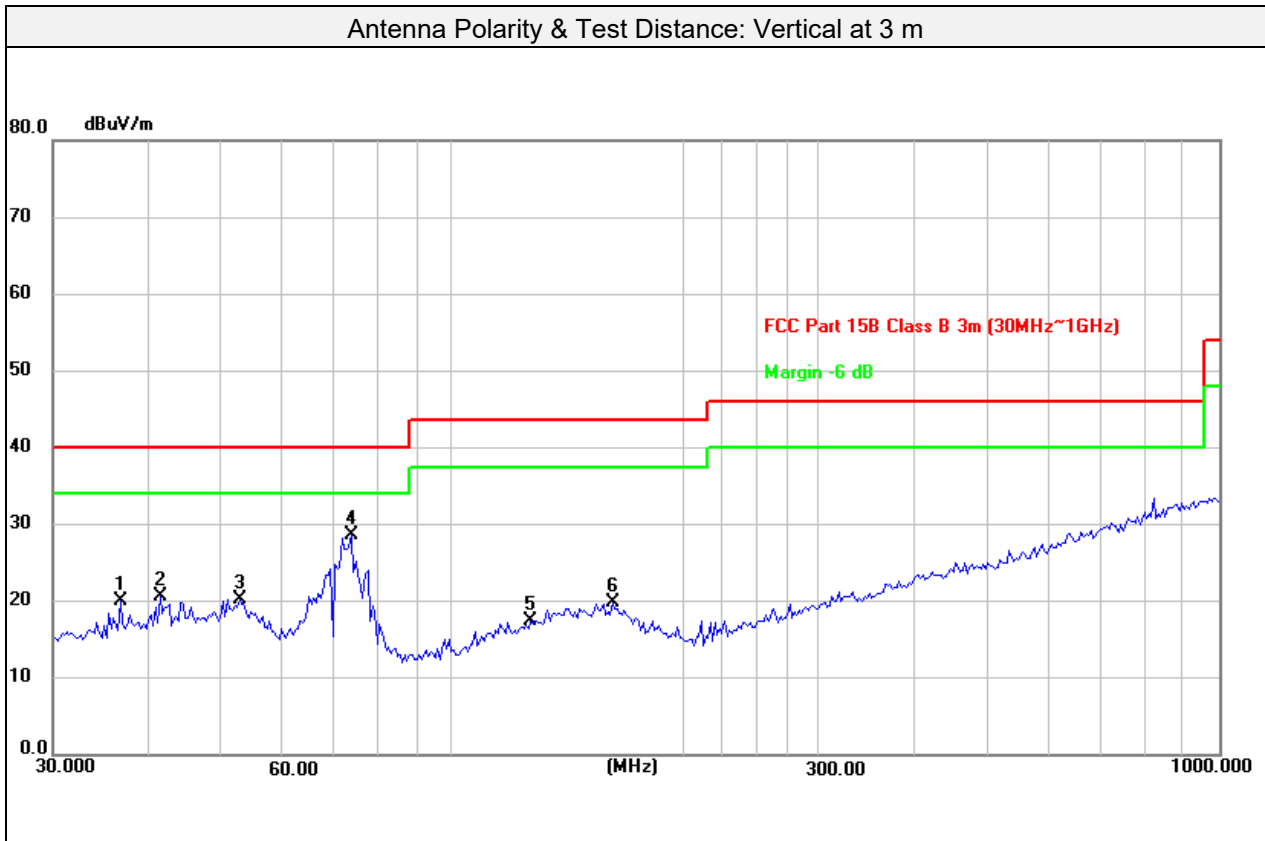

No.	Frequency (MHz)	Reading (dBuV)	Factor (dB)	Emission Level (dBuV/m)	Limit (dBuV/m)	Margin (dB)	Det.	Antenna Height (cm)	Table Angle (Degree)
1	36.7662	36.03	-15.91	20.12	40.00	-19.88	peak	344	26
2	41.4215	35.97	-15.29	20.68	40.00	-19.32	peak	234	245
3	52.5753	35.44	-15.12	20.32	40.00	-19.68	peak	283	47
4	73.6170	47.54	-18.84	28.70	40.00	-11.30	peak	177	40
5	126.3286	32.61	-15.23	17.38	43.50	-26.12	peak	244	46
6	161.4742	33.34	-13.50	19.84	43.50	-23.66	peak	392	62

Remarks:

1. Emission Level = Read Level + Factor (Antenna Factor + Cable Loss - Preamp Factor)
2. Margin value = Emission level – Limit value

Above 1GHz Data:

GFSK

Frequency Range	1GHz ~ 25GHz	Detector Function	Peak (PK) Average (AVG)
Test Channel	Channel 0		

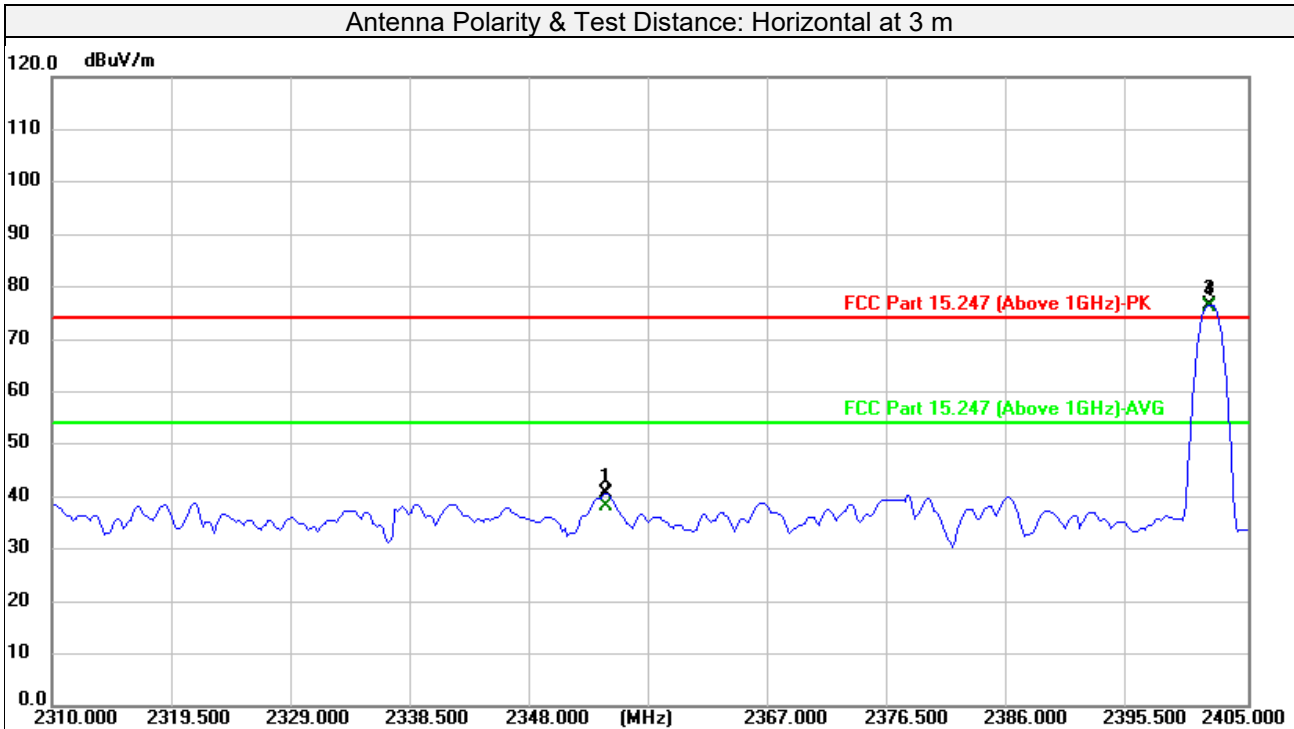

No.	Frequency (MHz)	Reading (dBuV)	Factor (dB)	Emission Level (dBuV/m)	Limit (dBuV/m)	Margin (dB)	Det.	Antenna Height (cm)	Table Angle (Degree)
1	2353.978	42.11	-1.52	40.59	74.00	-33.41	peak	100	184
2	2353.978	39.82	-1.52	38.30	54.00	-15.70	AVG	100	184
3#	2401.954	77.80	-1.22	76.58			peak	100	184
4#	2401.954	77.49	-1.22	76.27			AVG	100	184
5	4804.000	46.93	2.45	49.38	74.00	-24.62	peak	100	245
6	4804.000	45.55	2.45	48.00	74.00	-26.00	peak	100	245
7	7206.000	33.54	9.90	43.44	74.00	-30.56	peak	100	186
8	7206.000	24.32	9.90	34.22	54.00	-19.78	AVG	100	186

Remarks:

- Emission Level = Read Level + Factor (Antenna Factor + Cable Loss - Preamp Factor)
Margin value = Emission level – Limit value
- #2402MHz: Fundamental frequency.
- The amplitude of spurious emissions attenuated more than 20 dB below the permissible value is not required to be report.

Lab: [Hwa-Hsing \(Dongguan\) Testing Co., Ltd.](#)

Address: [No.101, Building N1, Yuyuan 2 Road, Yuyuan Industrial Park, HuangJiang Town, Dongguan City, People's Republic of China](#)

Tel: [0769-83078199](tel:0769-83078199)

Web.: www.hwa-hsing.com

E-Mail: customerservice.dg@hwa-hsing.com

Release

[Ver. 1.5](#)

Test Report No.: 2502050066-RF-US-01

Frequency Range	1GHz ~ 25GHz	Detector Function	Peak (PK) Average (AVG)
Test Channel	Channel 0		

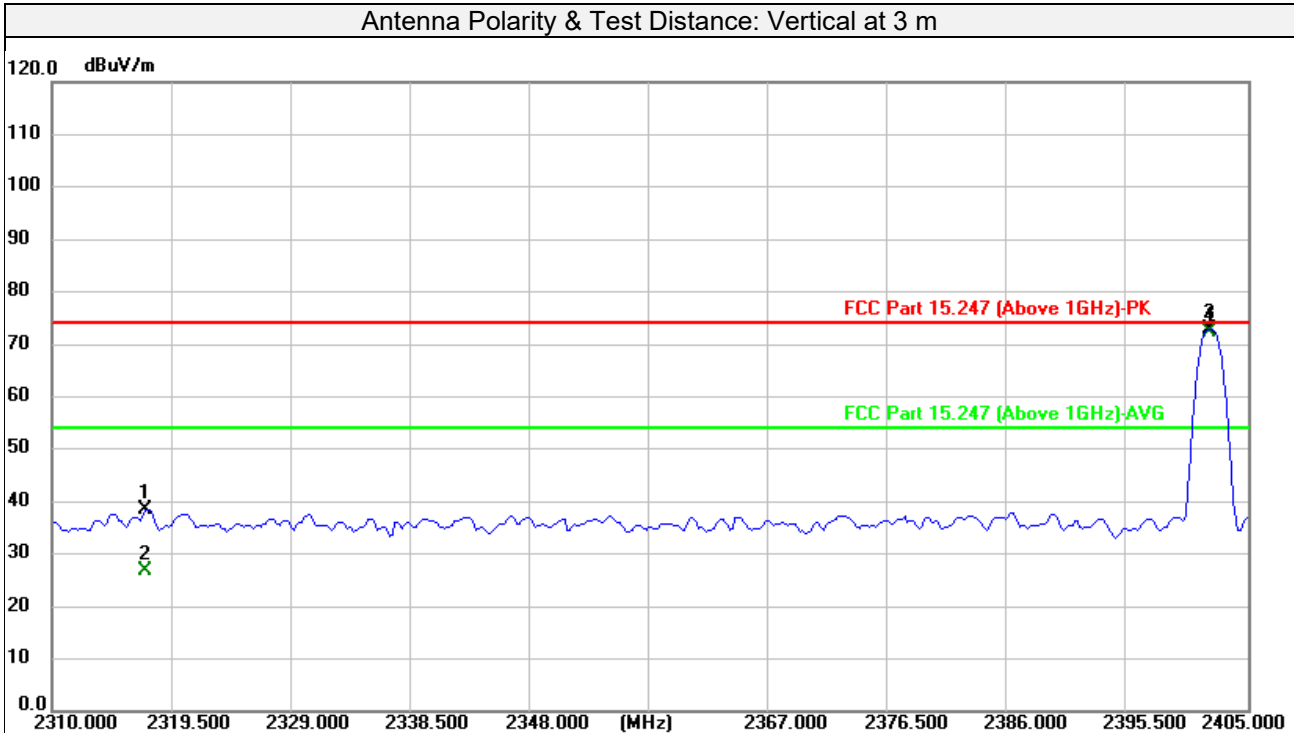

No.	Frequency (MHz)	Reading (dBuV)	Factor (dB)	Emission Level (dBuV/m)	Limit (dBuV/m)	Margin (dB)	Det.	Antenna Height (cm)	Table Angle (Degree)
1	2317.615	40.30	-1.75	38.55	74.00	-35.45	peak	400	63
2	2317.615	28.63	-1.75	26.88	54.00	-27.12	AVG	400	63
3#	2402.144	74.01	-1.22	72.79			peak	400	63
4#	2402.144	73.57	-1.22	72.35			AVG	400	63
5	4804.000	49.21	2.45	51.66	74.00	-22.34	peak	400	344
6	4804.000	47.18	2.45	49.63	74.00	-24.37	peak	400	344
7	7206.000	33.87	9.90	43.77	74.00	-30.23	peak	100	312
8	7206.000	24.60	9.90	34.50	54.00	-19.50	AVG	100	312

Remarks:

- Emission Level = Read Level + Factor (Antenna Factor + Cable Loss - Preamp Factor)
Margin value = Emission level – Limit value
- #2402MHz: Fundamental frequency.
- The amplitude of spurious emissions attenuated more than 20 dB below the permissible value is not required to be report.

Frequency Range	1GHz ~ 25GHz	Detector Function	Peak (PK) Average (AVG)
Test Channel	Channel 39		

Antenna Polarity & Test Distance: Horizontal at 3 m									
No.	Frequency (MHz)	Reading (dBuV)	Factor (dB)	Emission Level (dBuV/m)	Limit (dBuV/m)	Margin (dB)	Det.	Antenna Height (cm)	Table Angle (Degree)
1 #	2441.000	75.96	-0.96	75.00			peak	100	191
2 #	2441.000	75.87	-0.96	74.91			AVG	100	191
3	4882.000	39.26	2.64	41.90	74.00	-32.10	peak	100	332
4	4882.000	45.40	2.64	48.04	74.00	-25.96	peak	100	332
5	7323.000	41.04	10.21	51.25	74.00	-22.75	peak	122	115
6	7323.000	29.65	10.21	39.86	54.00	-14.14	AVG	122	115
Antenna Polarity & Test Distance: Vertical at 3 m									
No.	Frequency (MHz)	Reading (dBuV)	Factor (dB)	Emission Level (dBuV/m)	Limit (dBuV/m)	Margin (dB)	Det.	Antenna Height (cm)	Table Angle (Degree)
1 #	2441.000	69.00	-0.96	68.04			peak	100	16
2 #	2441.000	68.86	-0.96	67.90			AVG	100	16
3	4882.000	40.77	2.64	43.41	74.00	-30.59	peak	120	173
4	4882.000	46.91	2.64	49.55	74.00	-24.45	peak	120	173
5	7323.000	39.94	10.21	50.15	74.00	-23.85	peak	157	204
6	7323.000	29.71	10.21	39.92	54.00	-14.08	AVG	157	204

Remarks:

- Emission Level = Read Level + Factor (Antenna Factor + Cable Loss - Preamp Factor)
Margin value = Emission level – Limit value
- #2441MHz: Fundamental frequency.
- The amplitude of spurious emissions attenuated more than 20 dB below the permissible value is not required to be report.

Frequency Range	1GHz ~ 25GHz	Detector Function	Peak (PK) Average (AVG)
Test Channel	Channel 78		

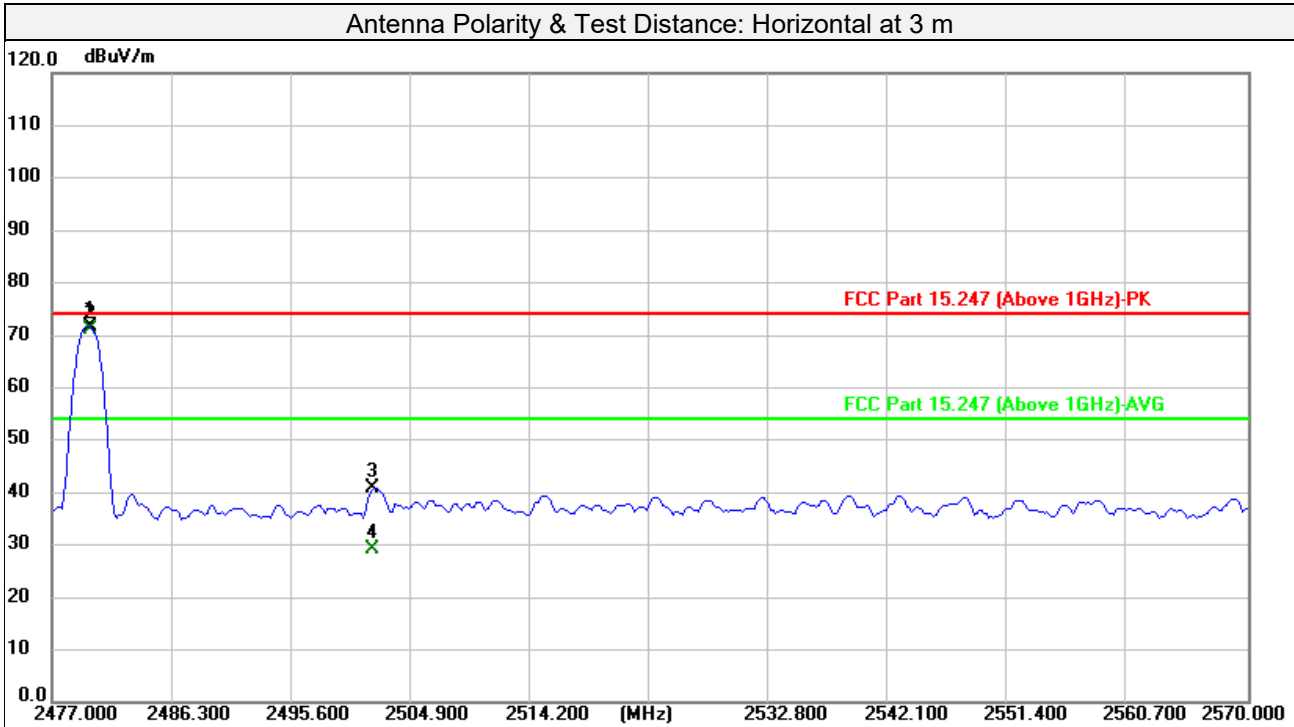

No.	Frequency (MHz)	Reading (dBuV)	Factor (dB)	Emission Level (dBuV/m)	Limit (dBuV/m)	Margin (dB)	Det.	Antenna Height (cm)	Table Angle (Degree)
1#	2479.982	72.33	-0.72	71.61			peak	100	191
2#	2479.982	71.92	-0.72	71.20			AVG	100	191
3	2502.160	41.33	-0.59	40.74	74.00	-33.26	peak	100	191
4	2502.160	29.87	-0.59	29.28	54.00	-24.72	AVG	100	191
5	4960.000	41.54	2.82	44.36	74.00	-29.64	peak	100	339
6	4960.000	34.92	2.82	37.74	74.00	-36.26	peak	100	339
7	7440.000	39.96	10.51	50.47	74.00	-23.53	peak	120	255
8	7440.000	29.45	10.51	39.96	54.00	-14.04	AVG	120	255

Remarks:

- Emission Level = Read Level + Factor (Antenna Factor + Cable Loss - Preamp Factor)
Margin value = Emission level – Limit value
- #2480MHz: Fundamental frequency.
- The amplitude of spurious emissions attenuated more than 20 dB below the permissible value is not required to be report.

Lab: [Hwa-Hsing \(Dongguan\) Testing Co., Ltd.](#)

Address: [No.101, Building N1, Yuyuan 2 Road, Yuyuan Industrial Park, HuangJiang Town, Dongguan City, People's Republic of China](#)

Tel: [0769-83078199](tel:0769-83078199)

Web.: www.hwa-hsing.com

E-Mail: customerservice.dg@hwa-hsing.com

Release

[Ver. 1.5](#)

Frequency Range	1GHz ~ 25GHz	Detector Function	Peak (PK) Average (AVG)
Test Channel	Channel 78		

Antenna Polarity & Test Distance: Vertical at 3 m

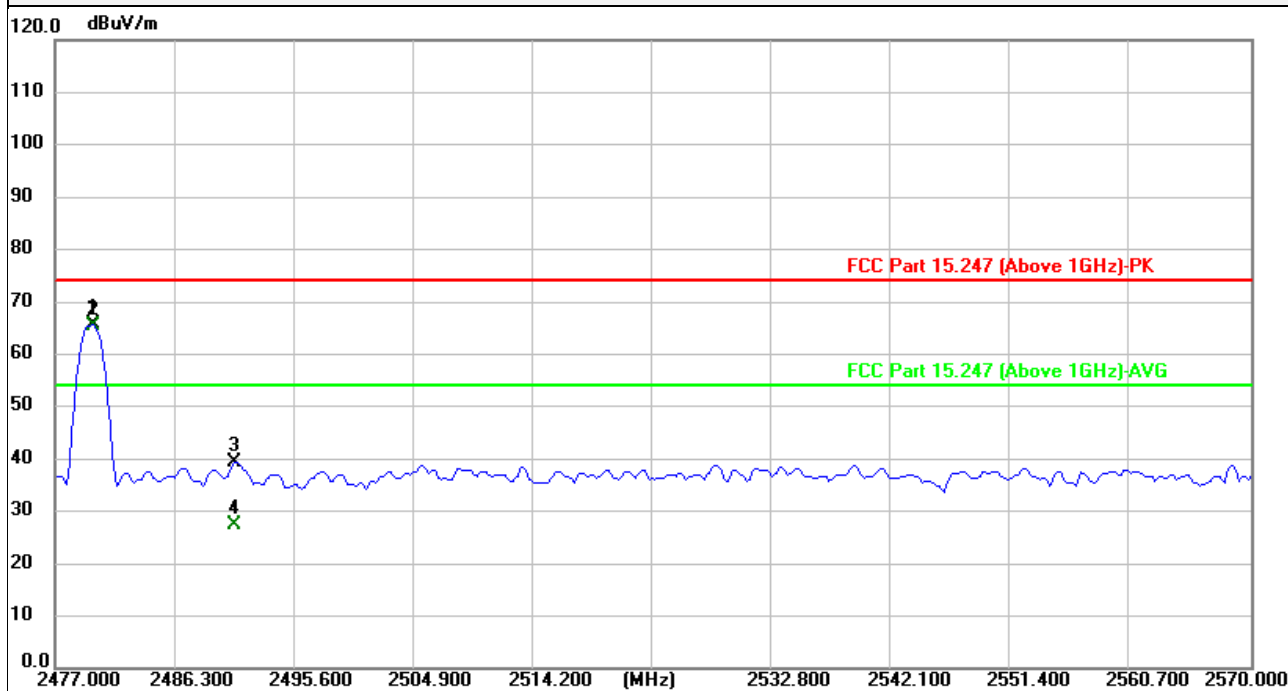

No.	Frequency (MHz)	Reading (dBuV)	Factor (dB)	Emission Level (dBuV/m)	Limit (dBuV/m)	Margin (dB)	Det.	Antenna Height (cm)	Table Angle (Degree)
1#	2479.982	66.33	-0.72	65.61			peak	100	121
2#	2479.982	66.01	-0.72	65.29			AVG	100	121
3	2491.164	39.97	-0.64	39.33	74.00	-34.67	peak	100	121
4	2491.164	28.01	-0.64	27.37	54.00	-26.63	AVG	100	121
5	4960.000	43.96	2.82	46.78	74.00	-27.22	peak	100	218
6	4960.000	36.21	2.82	39.03	74.00	-34.97	peak	100	218
7	7440.000	40.12	10.51	50.63	74.00	-23.37	peak	108	261
8	7440.000	29.54	10.51	40.05	54.00	-13.95	AVG	108	261

Remarks:

- Emission Level = Read Level + Factor (Antenna Factor + Cable Loss - Preamp Factor)
Margin value = Emission level – Limit value
- #2480MHz: Fundamental frequency.
- The amplitude of spurious emissions attenuated more than 20 dB below the permissible value is not required to be report.

Lab: [Hwa-Hsing \(Dongguan\) Testing Co., Ltd.](#)

Address: [No.101, Building N1, Yuyuan 2 Road, Yuyuan Industrial Park, HuangJiang Town, Dongguan City, People's Republic of China](#)

Tel: [0769-83078199](tel:0769-83078199)

Web.: www.hwa-hsing.com

E-Mail: customerservice.dg@hwa-hsing.com

Release
Ver. 1.5

8DPSK

Frequency Range	1GHz ~ 25GHz	Detector Function	Peak (PK) Average (AVG)
Test Channel	Channel 0		

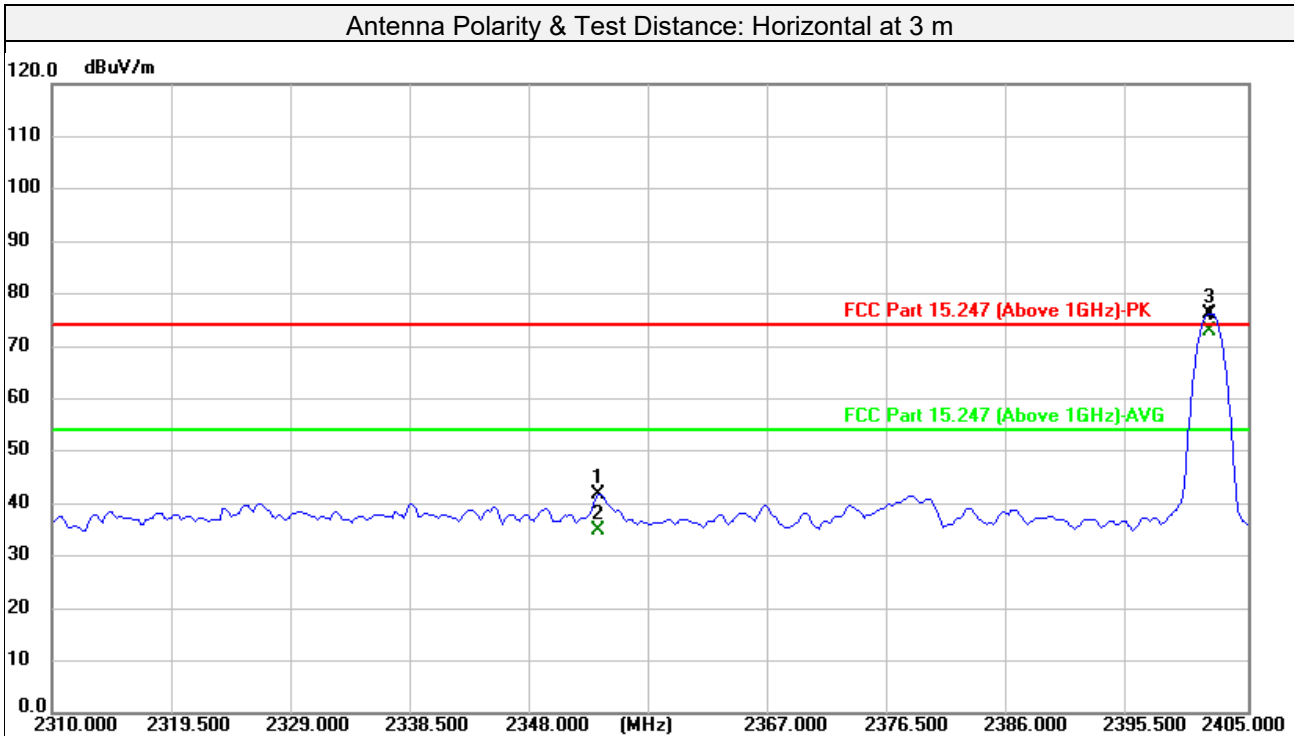

No.	Frequency (MHz)	Reading (dBuV)	Factor (dB)	Emission Level (dBuV/m)	Limit (dBuV/m)	Margin (dB)	Det.	Antenna Height (cm)	Table Angle (Degree)
1	2353.597	43.22	-1.53	41.69	74.00	-32.31	peak	100	184
2	2353.597	36.44	-1.53	34.91	54.00	-19.09	AVG	100	184
3#	2402.144	77.44	-1.22	76.22			peak	100	184
4#	2402.144	74.22	-1.22	73.00			AVG	100	184
5	4804.000	48.53	2.45	50.98	74.00	-23.02	peak	100	237
6	4804.000	41.24	2.45	43.69	74.00	-30.31	peak	100	237
7	7206.000	39.47	9.90	49.37	74.00	-24.63	peak	134	211
8	7206.000	29.95	9.90	39.85	54.00	-14.15	AVG	134	211

Remarks:

- Emission Level = Read Level + Factor (Antenna Factor + Cable Loss - Preamp Factor)
Margin value = Emission level – Limit value
- #2402MHz: Fundamental frequency.
- The amplitude of spurious emissions attenuated more than 20 dB below the permissible value is not required to be report.

Lab: [Hwa-Hsing \(Dongguan\) Testing Co., Ltd.](#)

Address: [No.101, Building N1, Yuyuan 2 Road, Yuyuan Industrial Park, HuangJiang Town, Dongguan City, People's Republic of China](#)

Tel: [0769-83078199](tel:0769-83078199)

Web.: www.hwa-hsing.com

E-Mail: customerservice.dg@hwa-hsing.com

Release

[Ver. 1.5](#)

Frequency Range	1GHz ~ 25GHz	Detector Function	Peak (PK) Average (AVG)
Test Channel	Channel 0		

Antenna Polarity & Test Distance: Vertical at 3 m

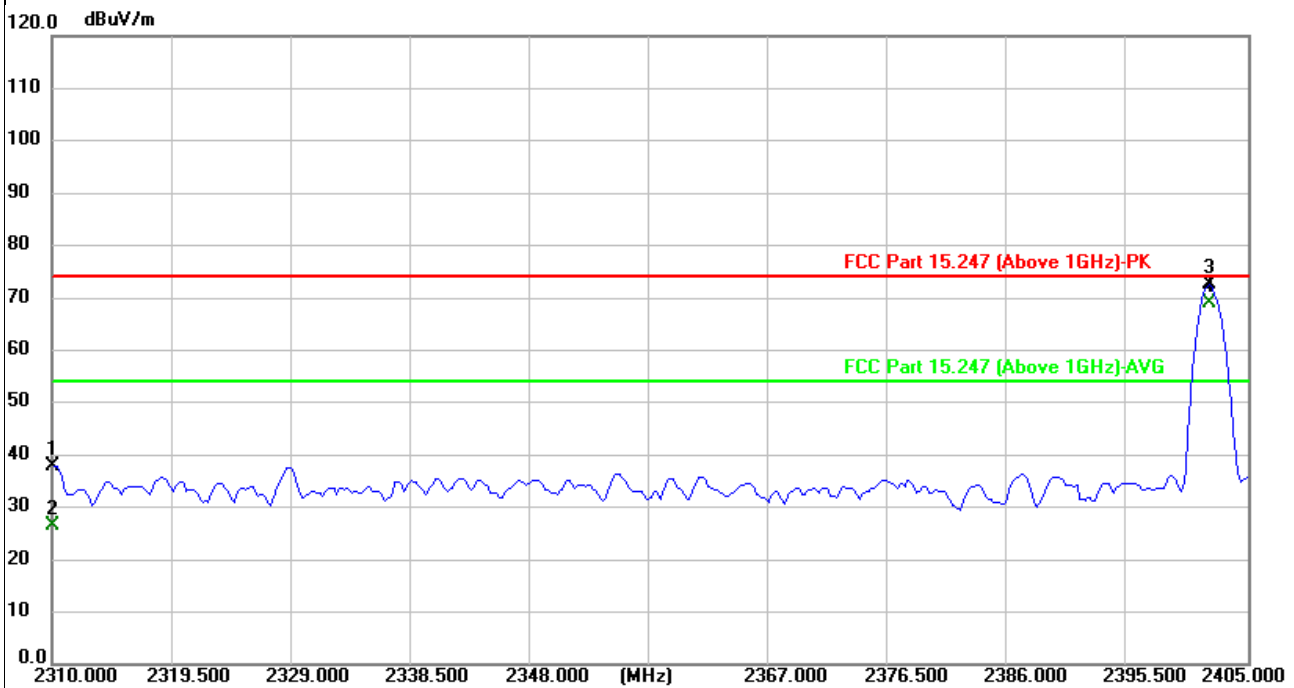

No.	Frequency (MHz)	Reading (dBuV)	Factor (dB)	Emission Level (dBuV/m)	Limit (dBuV/m)	Margin (dB)	Det.	Antenna Height (cm)	Table Angle (Degree)
1	2310.190	39.72	-1.80	37.92	74.00	-36.08	peak	400	62
2	2310.190	28.23	-1.80	26.43	54.00	-27.57	AVG	400	62
3#	2401.954	73.64	-1.22	72.42			peak	400	62
4#	2401.954	70.24	-1.22	69.02			AVG	400	62
5	4804.000	47.71	2.45	50.16	74.00	-23.84	peak	100	172
6	4804.000	40.59	2.45	43.04	74.00	-30.96	peak	100	172
7	7206.000	40.41	9.90	50.31	74.00	-23.69	peak	124	295
8	7206.000	29.45	9.90	39.35	54.00	-14.65	AVG	124	295

Remarks:

- Emission Level = Read Level + Factor (Antenna Factor + Cable Loss - Preamp Factor)
Margin value = Emission level – Limit value
- #2402MHz: Fundamental frequency.
- The amplitude of spurious emissions attenuated more than 20 dB below the permissible value is not required to be report.

Lab: [Hwa-Hsing \(Dongguan\) Testing Co., Ltd.](#)

Address: [No.101, Building N1, Yuyuan 2 Road, Yuyuan Industrial Park, HuangJiang Town, Dongguan City, People's Republic of China](#)

Tel: [0769-83078199](tel:0769-83078199)

Web.: www.hwa-hsing.com

E-Mail: customerservice.dg@hwa-hsing.com

Release

Ver. 1.5

Test Report No.: 2502050066-RF-US-01

Frequency Range	1GHz ~ 25GHz	Detector Function	Peak (PK) Average (AVG)
Test Channel	Channel 39		

Antenna Polarity & Test Distance: Horizontal at 3 m

No.	Frequency (MHz)	Reading (dBuV)	Factor (dB)	Emission Level (dBuV/m)	Limit (dBuV/m)	Margin (dB)	Det.	Antenna Height (cm)	Table Angle (Degree)
1#	2441.000	75.75	-0.96	74.79			peak	100	191
2#	2441.000	72.49	-0.96	71.53			AVG	100	191
3	4882.000	35.61	2.64	38.25	74.00	-35.75	peak	100	338
4	4882.000	43.36	2.64	46.00	74.00	-28.00	peak	100	338
5	7323.000	39.49	10.21	49.70	74.00	-24.30	peak	104	18
6	7323.000	29.59	10.21	39.80	54.00	-14.20	AVG	104	18

Antenna Polarity & Test Distance: Vertical at 3 m

No.	Frequency (MHz)	Reading (dBuV)	Factor (dB)	Emission Level (dBuV/m)	Limit (dBuV/m)	Margin (dB)	Det.	Antenna Height (cm)	Table Angle (Degree)
1#	2441.000	68.89	-0.96	67.93			peak	100	15
2#	2441.000	65.86	-0.96	64.90			AVG	100	15
3	4882.000	36.53	2.64	39.17	74.00	-34.83	peak	100	177
4	4882.000	44.05	2.64	46.69	74.00	-27.31	peak	100	177
5	7323.000	39.23	10.21	49.44	74.00	-24.56	peak	188	202
6	7323.000	29.69	10.21	39.90	54.00	-14.10	AVG	188	202

Remarks:

- Emission Level = Read Level + Factor (Antenna Factor + Cable Loss - Preamp Factor)
Margin value = Emission level – Limit value
- #2441MHz: Fundamental frequency.
- The amplitude of spurious emissions attenuated more than 20 dB below the permissible value is not required to be report.

Lab: [Hwa-Hsing \(Dongguan\) Testing Co., Ltd.](#)

Address: [No.101, Building N1, Yuyuan 2 Road, Yuyuan Industrial Park, HuangJiang Town, Dongguan City, People's Republic of China](#)

Tel: [0769-83078199](tel:0769-83078199)

Web.: www.hwa-hsing.com

E-Mail: customerservice.dg@hwa-hsing.com

Release

[Ver. 1.5](#)

Frequency Range	1GHz ~ 25GHz	Detector Function	Peak (PK) Average (AVG)
Test Channel	Channel 78		

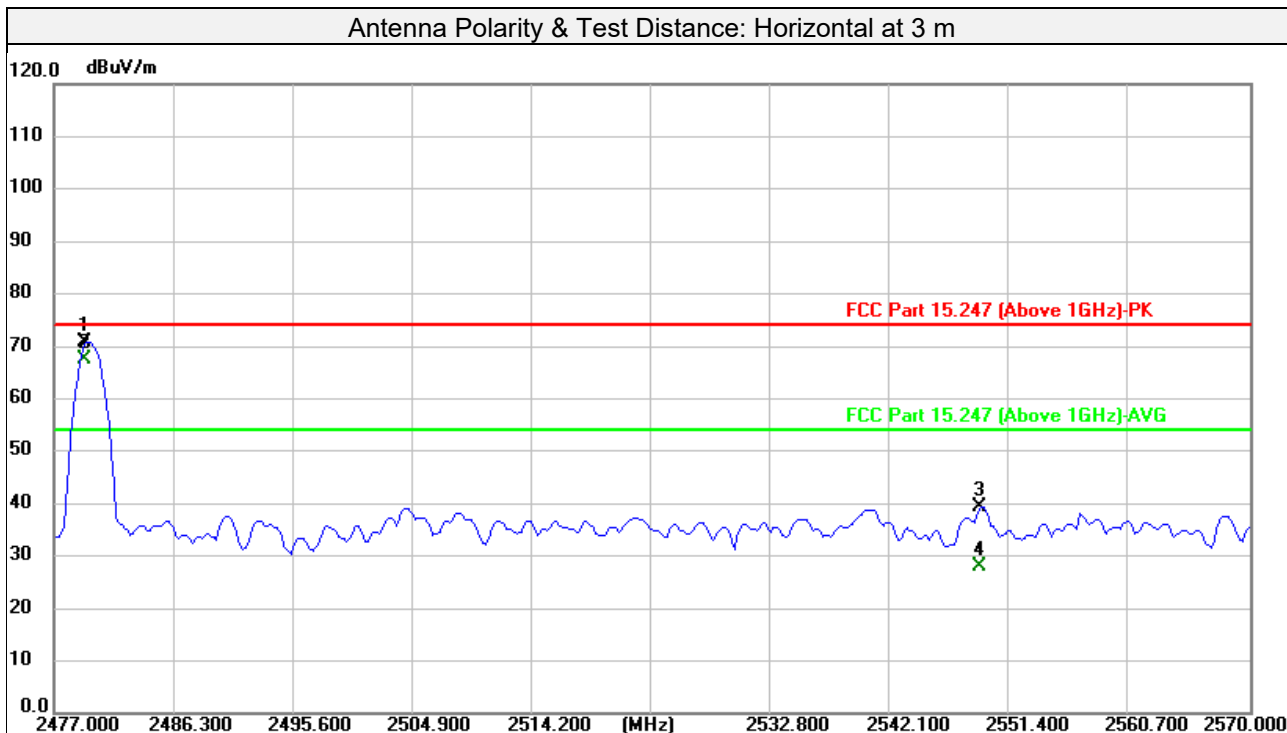

No.	Frequency (MHz)	Reading (dBuV)	Factor (dB)	Emission Level (dBuV/m)	Limit (dBuV/m)	Margin (dB)	Det.	Antenna Height (cm)	Table Angle (Degree)
1#	2479.609	71.63	-0.72	70.91			peak	100	190
2#	2479.609	68.19	-0.72	67.47			AVG	100	190
3	2549.126	39.76	-0.46	39.30	74.00	-34.70	peak	100	190
4	2549.126	28.37	-0.46	27.91	54.00	-26.09	AVG	100	190
5	4960.000	41.81	2.82	44.63	74.00	-29.37	peak	100	6
6	4960.000	31.07	2.82	33.89	74.00	-40.11	peak	100	6
7	7440.000	39.41	10.51	49.92	74.00	-24.08	peak	118	204
8	7440.000	29.42	10.51	39.93	54.00	-14.07	AVG	118	204

Remarks:

- Emission Level = Read Level + Factor (Antenna Factor + Cable Loss - Preamp Factor)
Margin value = Emission level – Limit value
- #2480MHz: Fundamental frequency.
- The amplitude of spurious emissions attenuated more than 20 dB below the permissible value is not required to be report.

Lab: [Hwa-Hsing \(Dongguan\) Testing Co., Ltd.](#)

Address: [No.101, Building N1, Yuyuan 2 Road, Yuyuan Industrial Park, HuangJiang Town, Dongguan City, People's Republic of China](#)

Tel: [0769-83078199](tel:0769-83078199)

Web.: www.hwa-hsing.com

E-Mail: customerservice.dg@hwa-hsing.com

Release

[Ver. 1.5](#)

Frequency Range	1GHz ~ 25GHz	Detector Function	Peak (PK) Average (AVG)
Test Channel	Channel 78		

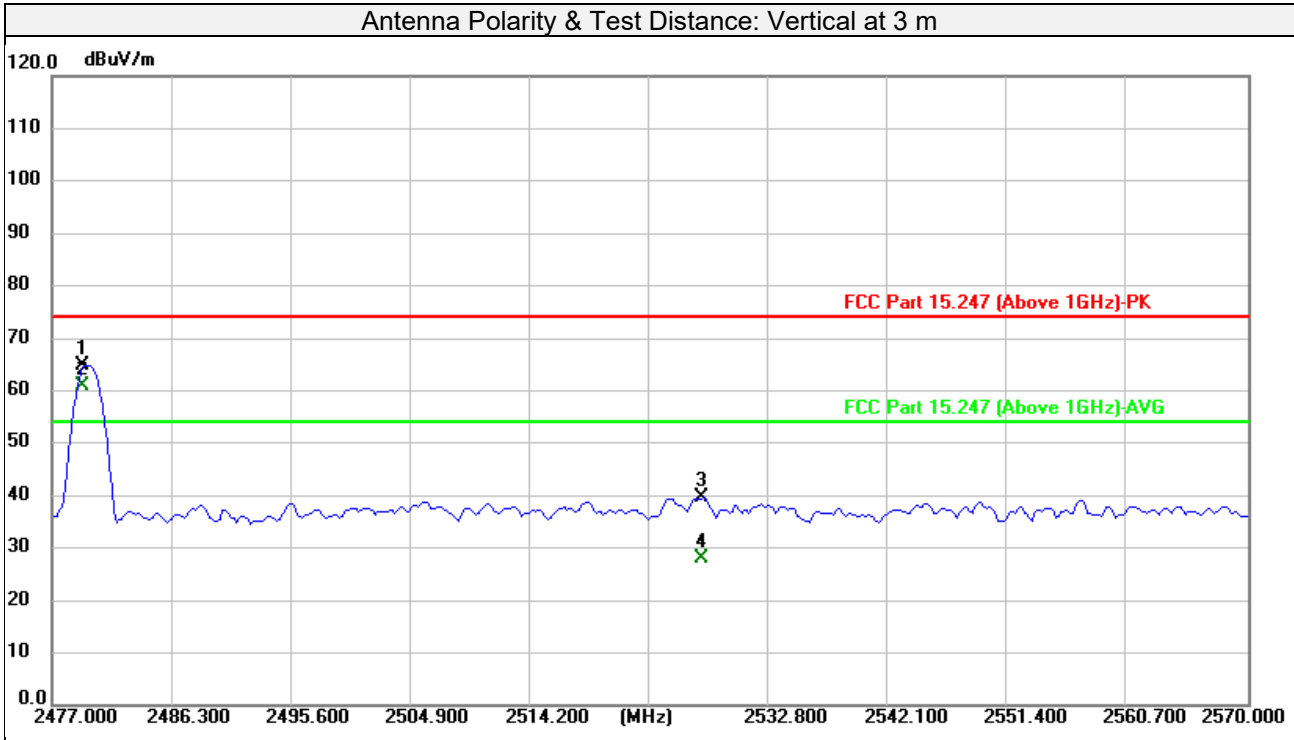

No.	Frequency (MHz)	Reading (dBuV)	Factor (dB)	Emission Level (dBuV/m)	Limit (dBuV/m)	Margin (dB)	Det.	Antenna Height (cm)	Table Angle (Degree)
1#	2479.609	65.65	-0.72	64.93			peak	100	120
2#	2479.609	61.55	-0.72	60.83			AVG	100	120
3	2527.693	40.06	-0.51	39.55	74.00	-34.45	peak	100	120
4	2527.693	28.43	-0.51	27.92	54.00	-26.08	AVG	100	120
5	4960.000	42.66	2.82	45.48	74.00	-28.52	peak	100	214
6	4960.000	32.82	2.82	35.64	74.00	-38.36	peak	100	214
7	7440.000	40.66	10.51	51.17	74.00	-22.83	peak	216	226
8	7440.000	29.47	10.51	39.98	54.00	-14.02	AVG	216	226

Remarks:

- Emission Level = Read Level + Factor (Antenna Factor + Cable Loss - Preamp Factor)
Margin value = Emission level – Limit value
- #2480MHz: Fundamental frequency.
- The amplitude of spurious emissions attenuated more than 20 dB below the permissible value is not required to be report.

Lab: [Hwa-Hsing \(Dongguan\) Testing Co., Ltd.](#)

Address: [No.101, Building N1, Yuyuan 2 Road, Yuyuan Industrial Park, HuangJiang Town, Dongguan City, People's Republic of China](#)

Tel: [0769-83078199](tel:0769-83078199)

Web.: www.hwa-hsing.com

E-Mail: customerservice.dg@hwa-hsing.com

Release

[Ver. 1.5](#)

Test Report No.: 2502050066-RF-US-01

3.2 Conducted Emission Measurement

3.2.1 Limits of Conducted Emission Measurement

Frequency (MHz)	Conducted Limit (dBuV)	
	Quasi-peak	Average
0.15 - 0.5	66 - 56	56 - 46
0.50 - 5.0	56	46
5.0 - 30.0	60	50

- Note: 1. The lower limit shall apply at the transition frequencies.
2. The limit decreases in line with the logarithm of the frequency in the range of 0.15 to 0.50MHz.

3.2.2 Test Instruments

Equipment	Manufacturer	Model No.	Serial No.	Next Cal. Date
EMI Test Receiver (10kHz~7GHz)	Rohde&Schwarz	ESR7	101961	2025-07-25
2 Line V-Network LISN	Rohde&Schwarz	ENV216	3560.6550.15	2025-07-25
Test software	FARAD	EZ_EMV V1.1.4.2	N/A	N/A
Broadcast test system	R&S	SFU	100410	2025-07-25

Note:

1. The calibration interval of the above test instruments is 12 months and calibrated by LISAI/CHINA.
2. The test was performed in Shielded Room 743.

Lab: [Hwa-Hsing \(Dongguan\) Testing Co., Ltd.](#)Address: [No.101, Building N1, Yuyuan 2 Road, Yuyuan Industrial Park, HuangJiang Town, Dongguan City, People's Republic of China](#)Tel: [0769-83078199](tel:0769-83078199)Web.: www.hwa-hsing.comE-Mail: customerservice.dg@hwa-hsing.comRelease
[Ver. 1.5](#)

Test Report No.: 2502050066-RF-US-01

3.2.3 Test Procedures

- a. The EUT was placed 0.4 meters from the conducting wall of the shielded room with EUT being connected to the power mains through a line impedance stabilization network (LISN). Other support units were connected to the power mains through another LISN. The two LISNs provide 50 ohm/ 50uH of coupling impedance for the measuring instrument.
- b. Both lines of the power mains connected to the EUT were checked for maximum conducted interference.
- c. The frequency range from 150kHz to 30MHz was searched. Emission levels under (Limit – 20dB) was not recorded.

Note: All modes of operation were investigated and the worst-case emissions are reported.

3.2.4 Test Setup

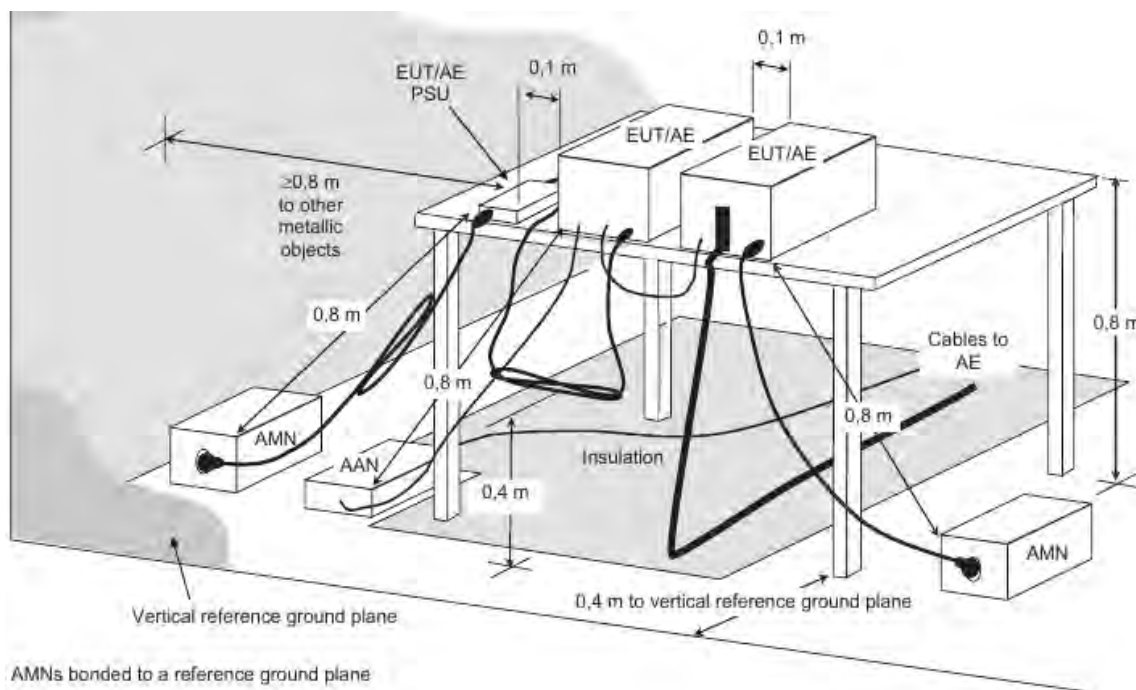

For the actual test configuration, please refer to the attached file (Test Setup Photo).

3.2.5 EUT Operating Condition

Set the EUT under transmission condition continuously at specific channel frequency.

3.2.6 Deviation from Test Standard

No deviation.

Lab: [Hwa-Hsing \(Dongguan\) Testing Co., Ltd.](#)

Address: [No.101, Building N1, Yuyuan 2 Road, Yuyuan Industrial Park, HuangJiang Town, Dongguan City, People's Republic of China](#)

Tel: [0769-83078199](tel:0769-83078199)

Web.: www.hwa-hsing.com

E-Mail: customerservice.dg@hwa-hsing.com

Release
Ver. 1.5

3.2.7 Test Results

Frequency Range	150kHz ~ 30MHz	Detector Function & Resolution bandwidth	Quasi-Peak (QP) / Average (AV), 9kHz
-----------------	----------------	--	--------------------------------------

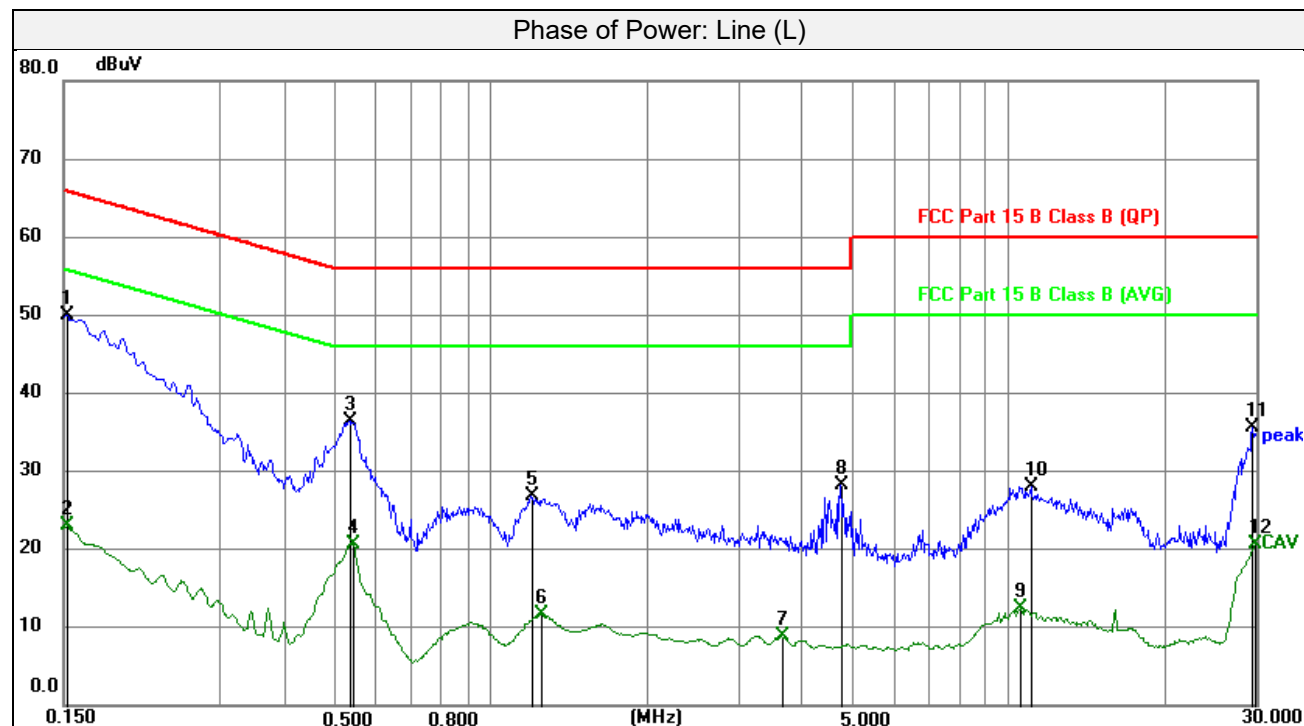

No.	Frequency (MHz)	Reading (dBuV)	Correct Factor (dB)	Emission Level (dBuV)	Limit (dBuV)	Margin (dB)	Remark
1	0.1522	39.90	10.11	50.01	65.88	-15.87	peak
2	0.1522	12.97	10.11	23.08	55.88	-32.80	AVG
3	0.5370	26.42	10.04	36.46	56.00	-19.54	peak
4	0.5415	10.62	10.04	20.66	46.00	-25.34	AVG
5	1.2030	16.79	10.04	26.83	56.00	-29.17	peak
6	1.2503	1.63	10.04	11.67	46.00	-34.33	AVG
7	3.6488	-1.14	10.06	8.92	46.00	-37.08	AVG
8	4.7333	18.24	10.04	28.28	56.00	-27.72	peak
9	10.5248	2.36	10.03	12.39	50.00	-37.61	AVG
10	11.0333	18.02	10.03	28.05	60.00	-31.95	peak
11	29.6655	25.48	10.17	35.65	60.00	-24.35	peak
12	29.9670	10.48	10.17	20.65	50.00	-29.35	AVG

Remarks:

1. Q.P. and AV. are abbreviations of quasi-peak and average individually.
2. The emission levels of other frequencies were very low against the limit.
3. Margin value = Emission level - Limit value
4. Correction factor = Insertion loss + Cable loss
5. Emission Level = Correction Factor + Reading Value.

Lab: [Hwa-Hsing \(Dongguan\) Testing Co., Ltd.](#)

Address: [No.101, Building N1, Yuyuan 2 Road, Yuyuan Industrial Park, HuangJiang Town, Dongguan City, People's Republic of China](#)

Tel: [0769-83078199](tel:0769-83078199)

Web.: www.hwa-hsing.com

E-Mail: customerservice.dg@hwa-hsing.com

Release

Ver. 1.5

Frequency Range	150kHz ~ 30MHz	Detector Function & Resolution bandwidth	Quasi-Peak (QP) / Average (AV), 9kHz
-----------------	----------------	--	--------------------------------------

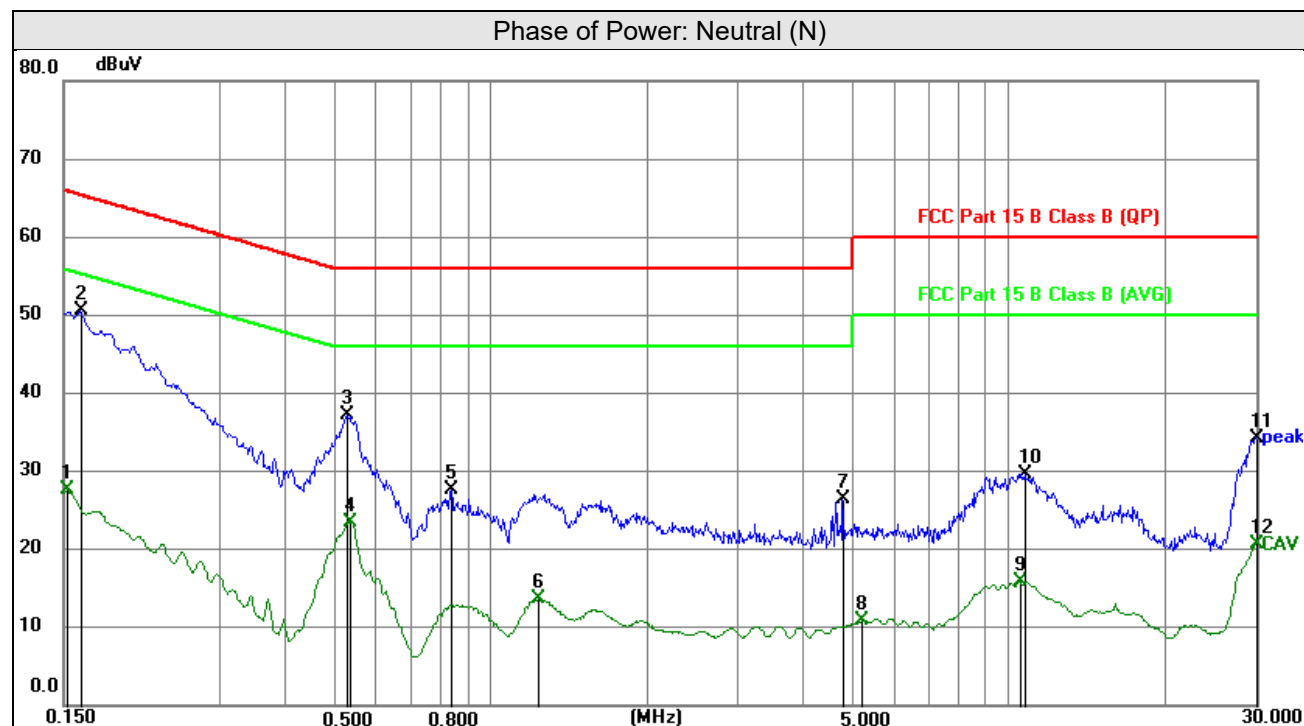

No.	Frequency (MHz)	Reading (dBuV)	Correct Factor (dB)	Emission Level (dBuV)	Limit (dBuV)	Margin (dB)	Remark
1	0.1522	17.58	10.11	27.69	55.88	-28.19	AVG
2	0.1613	40.41	10.10	50.51	65.40	-14.89	peak
3	0.5302	27.06	10.05	37.11	56.00	-18.89	peak
4	0.5370	13.41	10.05	23.46	46.00	-22.54	AVG
5	0.8407	17.53	10.03	27.56	56.00	-28.44	peak
6	1.2390	3.52	10.05	13.57	46.00	-32.43	AVG
7	4.7963	16.48	10.03	26.51	56.00	-29.49	peak
8	5.2305	0.85	10.02	10.87	50.00	-39.13	AVG
9	10.5023	5.76	10.04	15.80	50.00	-34.20	AVG
10	10.7880	19.65	10.05	29.70	60.00	-30.30	peak
11	29.9828	24.11	10.20	34.31	60.00	-25.69	peak
12	29.9828	10.40	10.20	20.60	50.00	-29.40	AVG

Remarks:

1. Q.P. and AV. are abbreviations of quasi-peak and average individually.
2. The emission levels of other frequencies were very low against the limit.
3. Margin value = Emission level - Limit value
4. Correction factor = Insertion loss + Cable loss
5. Emission Level = Correction Factor + Reading Value.

Lab: [Hwa-Hsing \(Dongguan\) Testing Co., Ltd.](#)

Address: [No.101, Building N1, Yuyuan 2 Road, Yuyuan Industrial Park, HuangJiang Town, Dongguan City, People's Republic of China](#)

Tel: [0769-83078199](tel:0769-83078199)

Web.: www.hwa-hsing.com

E-Mail: customerservice.dg@hwa-hsing.com

Release

[Ver. 1.5](#)

3.3 Number of Hopping Frequency Used

3.3.1 Limits of Hopping Frequency Used Measurement

At least 15 channels frequencies, and should be equally spaced.

3.3.2 Test Setup

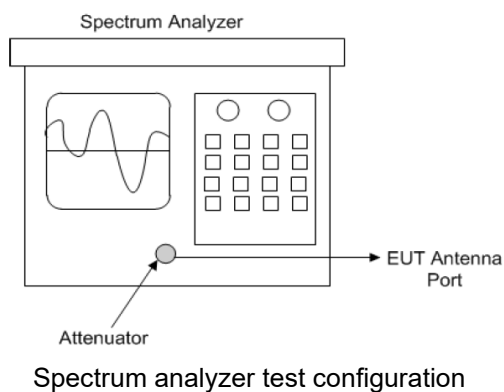

3.3.3 Test Instruments

Refer to section 5 to get information of above instrument.

3.3.4 Test Procedure

- Check the calibration of the measuring instrument (SA) using either an internal calibrator or a known signal from an external generator.
- Turn on the EUT and connect its antenna terminal to measurement via a low loss cable. Then set it to any one measured frequency within its operating range and make sure the instrument is operated in its linear range.
- Set the SA on MaxHold Mode, and then keep the EUT in hopping mode. Record all the signals from each channel until each one has been recorded.
- Set the SA on View mode and then plot the result on SA screen.
- Repeat above procedures until all frequencies measured were complete.

3.3.5 Deviation from Test Standard

No deviation.

Test Report No.: 2502050066-RF-US-01

3.3.6 Test Results

There are 79 hopping frequencies in the hopping mode. Please refer to next page for the test result. On the plots, it shows that the hopping frequencies are equally spaced.

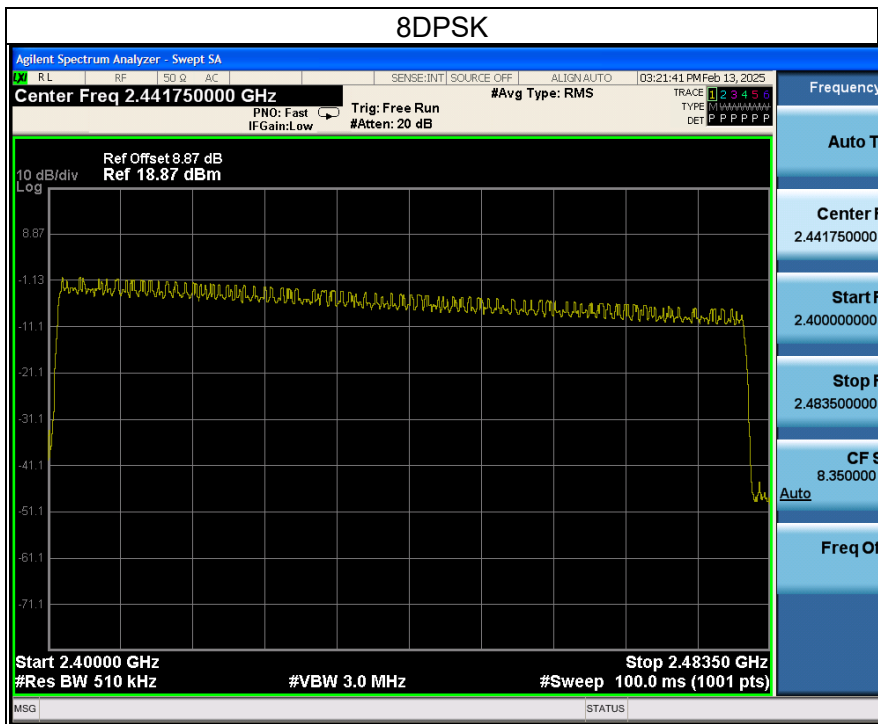
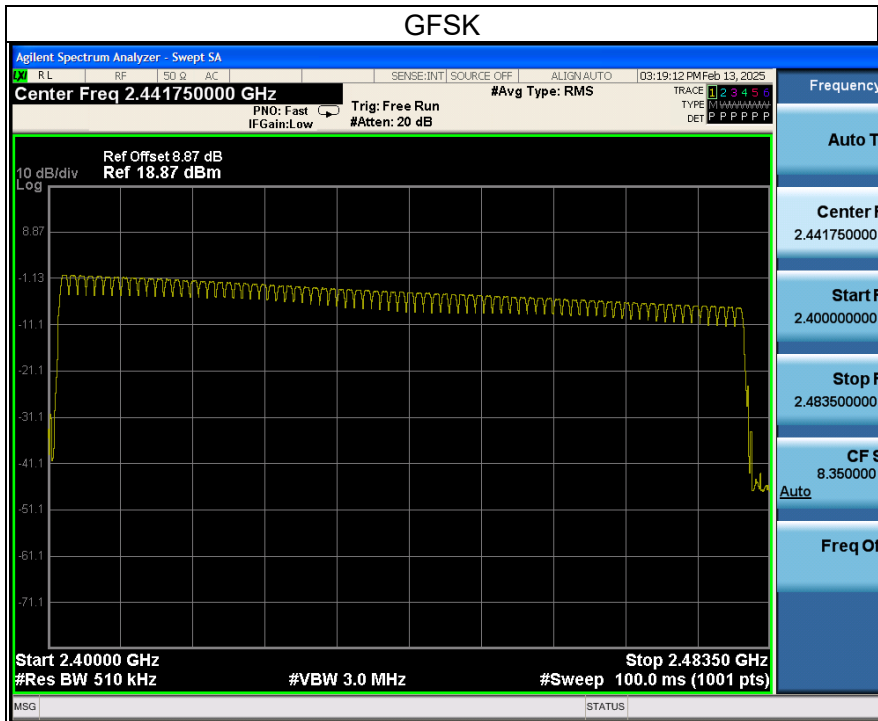

3.4 Dwell Time on Each Channel

3.4.1 Limits of Dwell Time on Each Channel Measurement

The average time of occupancy on any channel shall not be greater than 0.4 seconds within a period of 0.4 seconds multiplied by the number of hopping channels employed.

3.4.2 Test Setup

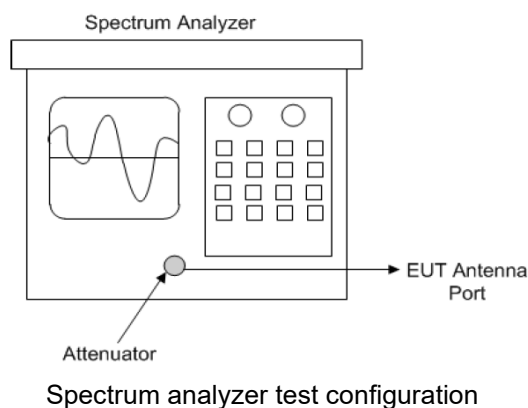

3.4.3 Test Instruments

Refer to section 5 to get information of above instrument.

3.4.4 Test Procedures

- Check the calibration of the measuring instrument (SA) using either an internal calibrator or a known signal from an external generator.
- Turn on the EUT and connect its antenna terminal to measurement via a low loss cable. Then set it to any one measured frequency within its operating range and make sure the instrument is operated in its linear range.
- Adjust the center frequency of SA on any frequency be measured and set SA to zero span mode. And then, set RBW and VBW of spectrum analyzer to proper value.
- Measure the time duration of one transmission on the measured frequency. And then plot the result with time difference of this time duration.
- Repeat above procedures until all different time-slot modes have been completed.

3.4.5 Deviation from Test Standard

No deviation.

Test Report No.: 2502050066-RF-US-01

3.4.6 Test Results

GFSK

Test Mode	Channel	Burst Width [ms]	Total Hops [Num]	Result[s]	Limit[s]	Verdict
DH1	Hop	0.36	320	0.115	≤0.4	PASS
DH3	Hop	1.62	160	0.259	≤0.4	PASS
DH5	Hop	2.87	106.67	0.306	≤0.4	PASS

Note: Test plots of the transmitting time slot are shown as below.**8DPSK**

Test Mode	Channel	Burst Width [ms]	Total Hops [Num]	Result[s]	Limit[s]	Verdict
3DH1	Hop	0.36	320	0.115	≤0.4	PASS
3DH3	Hop	1.61	160	0.258	≤0.4	PASS
3DH5	Hop	2.86	106.67	0.305	≤0.4	PASS

Note: Test plots of the transmitting time slot are shown as below.

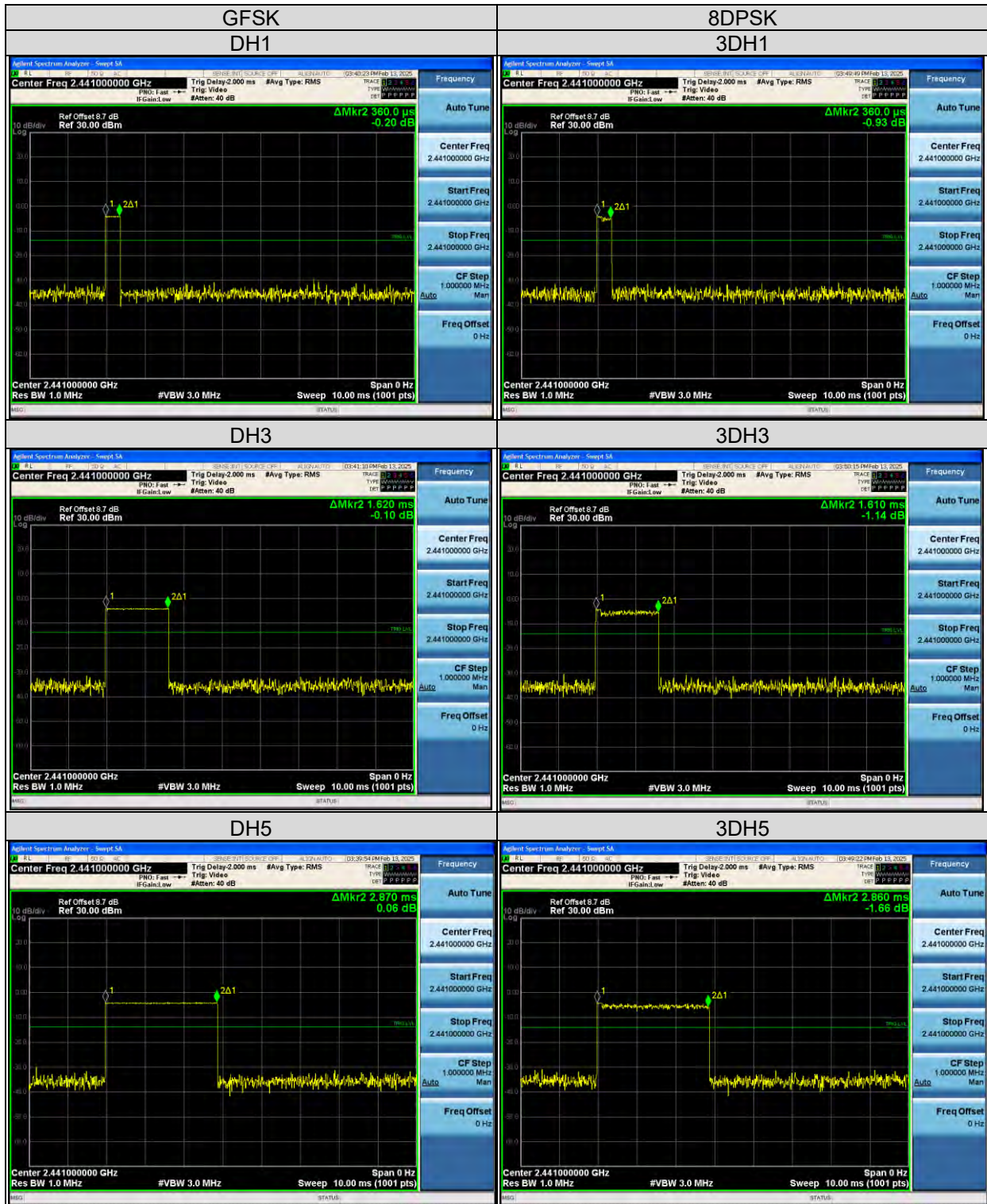

3.5 Channel Bandwidth

3.5.1 Limits of Channel Bandwidth Measurement

For frequency hopping system operating in the 2400-2483.5 MHz, if the 20 dB bandwidth of hopping channel is greater than 25 kHz, two-thirds 20 dB bandwidth of hopping channel shall be a minimum limit for the hopping channel separation.

3.5.2 Test Setup

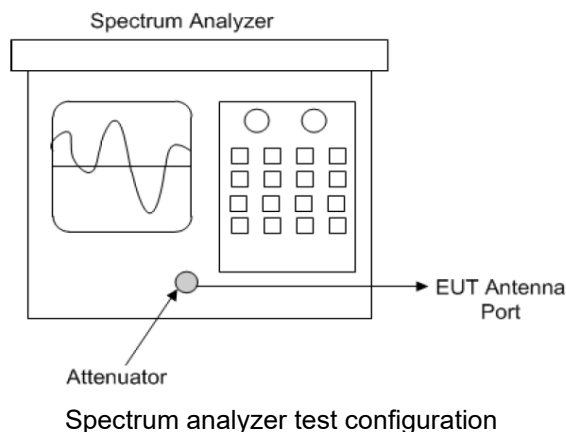

3.5.3 Test Instruments

Refer to section 5 to get information of above instrument.

3.5.4 Test Procedure

- Check the calibration of the measuring instrument using either an internal calibrator or a known signal from an external generator.
- Turn on the EUT and connect it to measurement instrument. Then set it to any one convenient frequency within its operating range. Set a reference level on the instrument equal to the highest peak value.
- Measure the frequency difference of two frequencies that were attenuated 20 dB from the reference level. Record the frequency difference as the emission bandwidth.
- Repeat above procedures until all frequencies measured were complete.

3.5.5 Deviation from Test Standard

No deviation.

3.5.6 EUT Operating Condition

The software provided by client enabled the EUT to transmit and receive data at lowest, middle and highest channel frequencies individually.

Test Report No.: 2502050066-RF-US-01

3.5.7 Test Results

Channel	Frequency (MHz)	20dB Bandwidth (MHz)	
		GFSK	8DPSK
0	2402	0.975	1.314
39	2441	1.017	1.275
78	2480	0.960	1.332

Lab: [Hwa-Hsing \(Dongguan\) Testing Co., Ltd.](#)Address: [No.101, Building N1, Yuyuan 2 Road, Yuyuan Industrial Park, HuangJiang Town, Dongguan City, People's Republic of China](#)Tel: [0769-83078199](tel:0769-83078199)Web.: www.hwa-hsing.comE-Mail: customerservice.dg@hwa-hsing.com

Release

[Ver. 1.5](#)



3.6 Occupied Bandwidth Measurement

3.6.1 Test Setup

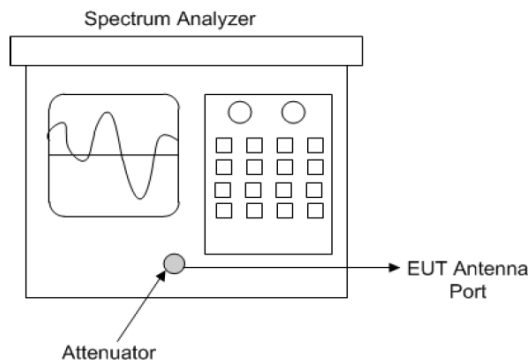

Spectrum analyzer test configuration

3.6.2 Test Instruments

Refer to section 5 to get information of above instrument.

3.6.3 Test Procedure

The transmitter output was connected to the spectrum analyzer through an attenuator. The bandwidth of the fundamental frequency was measured by spectrum analyzer with resolution bandwidth in the range of 1% to 5% of the anticipated emission bandwidth, and a video bandwidth at least 3x the resolution bandwidth and set the detector to PEAK. The width of a frequency band such that, below the lower and above the upper frequency limits, the mean powers emitted are each equal to a specified percentage 0.5% of the total mean power of a given emission.

3.6.4 Deviation from Test Standard

No deviation.

3.6.5 EUT Operating Conditions

The software provided by client to enable the EUT under transmission condition continuously at lowest, middle and highest channel frequencies individually.

Test Report No.: 2502050066-RF-US-01

3.6.6 Test Results

Channel	Frequency (MHz)	Occupied Bandwidth (MHz)	
		GFSK	8DPSK
0	2402	0.85957	1.1952
39	2441	0.86206	1.1925
78	2480	0.87906	1.1966

Lab: [Hwa-Hsing \(Dongguan\) Testing Co., Ltd.](#)Address: [No.101, Building N1, Yuyuan 2 Road, Yuyuan Industrial Park, HuangJiang Town, Dongguan City, People's Republic of China](#)Tel: [0769-83078199](tel:0769-83078199)Web.: www.hwa-hsing.comE-Mail: customerservice.dg@hwa-hsing.com

Release

[Ver. 1.5](#)



Test Report No.: 2502050066-RF-US-01

3.7 Hopping Channel Separation

3.7.1 Limits of Hopping Channel Separation Measurement

At least 25 kHz or two-third of 20 dB hopping channel bandwidth (whichever is greater).

3.7.2 Test Setup

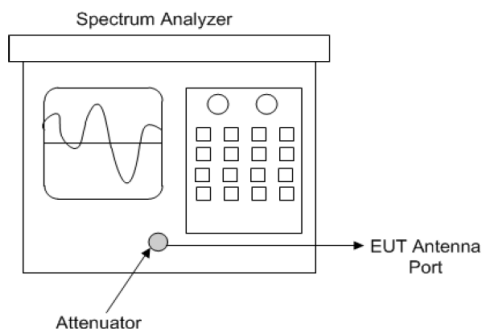

3.7.3 Test Instruments

Refer to section 5 to get information of above instrument.

3.7.4 Test Procedure

- Check the calibration of the measuring instrument using either an internal calibrator or a known signal from an external generator.
- Turn on the EUT and connect it to measurement instrument. Then set it to any one convenient frequency within its operating range.
- By using the MaxHold function record the separation of two adjacent channels.
- Measure the frequency difference of these two adjacent channels by SA MARK function. And then plot the result on SA screen.
- Repeat above procedures until all frequencies measured were complete.

3.7.5 Deviation from Test Standard

No deviation.

Lab: [Hwa-Hsing \(Dongguan\) Testing Co., Ltd.](#)

Address: [No.101, Building N1, Yuyuan 2 Road, Yuyuan Industrial Park, HuangJiang Town, Dongguan City, People's Republic of China](#)

Tel: [0769-83078199](#)

Web.: [www.hwa-hsing.com](#)

E-Mail: customerservice.dg@hwa-hsing.com

Release
Ver. 1.5

3.7.6 Test Results

Test Mode	Channel No.	Channel Separation (MHz)	Minimum Limit (MHz)	Pass / Fail
DH5	Hop	0.886	≥0.678	Pass
3DH5	Hop	0.996	≥0.888	Pass

Note: The minimum limit is two-third 20 dB bandwidth.

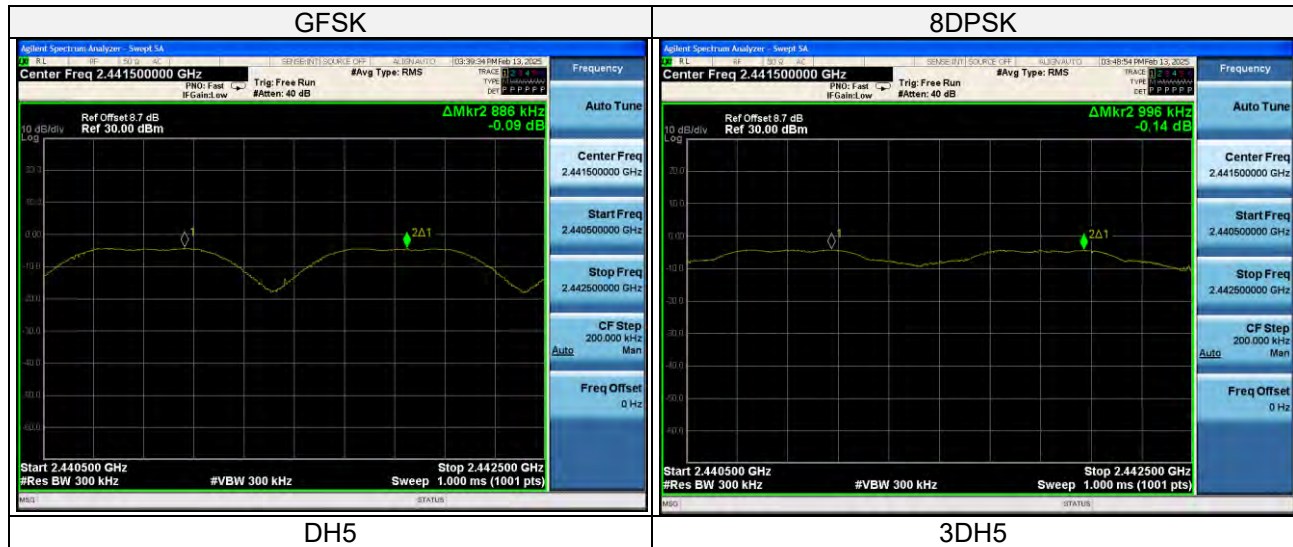

Test Report No.: 2502050066-RF-US-01

3.8 Maximum Output Power

3.8.1 Limits of Maximum Output Power Measurement

The Maximum Output Power Measurement is 125mW.

3.8.2 Test Setup

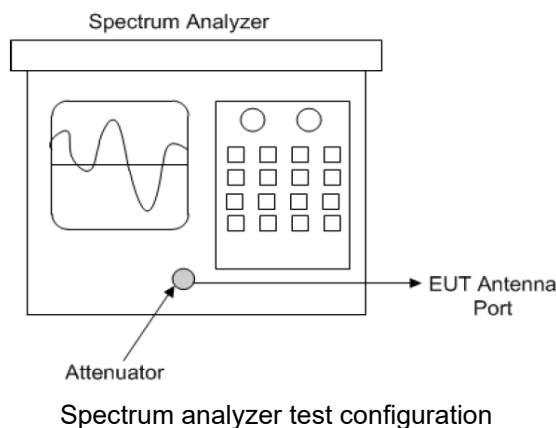

3.8.3 Test Instruments

Refer to section 5 to get information of above instrument.

3.8.4 Test Procedure

Measurement using a spectrum analyzer (SA), Selection of test method:

The proper test method is selected based on the following criteria:

- a) **Method AVGSA-1 or method AVGSA-1A (alternative)** shall be applied if either of the following conditions can be satisfied:
 - 1) The EUT transmits continuously (or with a D> 98%).
 - 2) Sweep triggering can be implemented in such a way that the device transmits at the maximum power control level throughout the duration of each of the instrument sweeps to be averaged. This condition can generally be achieved by triggering the instrument's sweep if the duration of the sweep (with the instrument configured as in method AVGSA-1) is equal to or shorter than the duration T of each transmission from the EUT, and if those transmissions exhibit full power throughout their durations.
- b) **Method AVGSA-2 or method AVGSA-2A (alternative)** shall be applied if the conditions of the preceding item a) cannot be achieved and the transmissions exhibit a constant duty cycle during the measurement duration. Duty cycle will be considered to be constant if variations are less than +2%.
- c) **Method AVGSA-3 or method AVGSA-3A (alternative)** shall be applied if the conditions of the preceding item a) and item b) cannot be achieved.

Lab: [Hwa-Hsing \(Dongguan\) Testing Co., Ltd.](#)

Address: [No.101, Building N1, Yuyuan 2 Road, Yuyuan Industrial Park, HuangJiang Town, Dongguan City, People's Republic of China](#)

Tel: [0769-83078199](#)

Web.: [www.hwa-hsing.com](#)

E-Mail: customerservice.dg@hwa-hsing.com

Release
Ver. 1.5

Test Report No.: 2502050066-RF-US-01

Measurement using a spectrum analyzer (SA), Selection of test method:

Maximum peak conducted output power

The following procedure shall be used when an instrument with a resolution bandwidth that is greater than the DTS bandwidth is available to perform the measurement:

- a) Set the RBW > DTS bandwidth.
- b) Set VBW > [3 x RBW]
- c) Set span > [3 x RBW]
- d) Sweep time = auto couple.
- e) Detector = peak
- f) Trace mode = max hold.
- g) Allow trace to fully stabilize.
- h) Use peak marker function to determine the peak amplitude level.

Lab: [Hwa-Hsing \(Dongguan\) Testing Co., Ltd.](#)

Address: [No.101, Building N1, Yuyuan 2 Road, Yuyuan Industrial Park, HuangJiang Town, Dongguan City, People's Republic of China](#)

Tel: [0769-83078199](#)

Web.: [www.hwa-hsing.com](#)

E-Mail: customerservice.dg@hwa-hsing.com

Release
Ver. 1.5

Test Report No.: 2502050066-RF-US-01

 Maximum conducted (average) output power(Method AVGSA-2):

- a) Check the calibration of the measuring instrument using either an internal calibrator or a known signal from an external generator.
- b) Turn on the EUT and connect it to measurement instrument. Then set it to any one convenient frequency within its operating range. Set a reference level on the measuring instrument equal to the highest peak value.
- c) SA Setting:
 - 1)* Set span to at least 1.5 times the OBW
 - 2)* Set sweep trigger to "free run."
 - 3)* Set RBW= 1% to 5% of the OBW. not to exceed 1MHz.
 - 4)* Set VBW $\geq 3 \times$ RBW
 - 5)* Number of points in sweep $\geq 2 \times$ span /RBW. (This gives bin-to-bin spacing \leq RBW / 2. so that narrowband signals are not lost between frequency bins).
 - 6)* Sweep time \leq (number of points in sweep) x T. where T is defined in 11.6. If this gives a sweep time less than the auto sweep time of the instrument. then method AVGSA-3 shall not be used (use AVGSA-3A). The purpose of this step is so that the averaging time in each bin is less than or equal to the minimum time of a transmission.
 - 7)* Detector =RMS (power averaging).
 - 8)* Trace mode =Max hold.
 - 9)* Allow max hold to run for at least 60 s or longer as needed to allow the trace to stabilize.
 - 10)* Compute power by integrating the spectrum across the OBW of the signal using the instrument's band power measurement function with band limits set equal to the OBW band edges. If the instrument does not have a band power function. then sum the spectrum levels (in power units) at intervals equal to the RBW extending across the entire OBW.
- d. Measure the captured power within the band and recording the plot.
- e. Repeat above procedures until all frequencies required were complete.

3.8.5 Deviation from Test Standard

No deviation.

3.8.6 EUT Operating Condition

The software provided by client enabled the EUT to transmit and receive data at lowest, middle and highest channel frequencies individually.

Lab: [Hwa-Hsing \(Dongguan\) Testing Co., Ltd.](#)

Address: [No.101, Building N1, Yuyuan 2 Road, Yuyuan Industrial Park, HuangJiang Town, Dongguan City, People's Republic of China](#)

Tel: [0769-83078199](tel:0769-83078199)

Web.: www.hwa-hsing.com

E-Mail: customerservice.dg@hwa-hsing.com

Release
Ver. 1.5

3.8.7 Test Results

Peak power

Channel No.	Freq. (MHz)	Output Power (dBm)		Output Power (mW)		Power Limit (mW)	Pass / Fail
		GFSK	8DPSK	GFSK	8DPSK		
0	2402	-0.22	0.02	0.951	1.005	125	Pass
39	2441	-4.13	-3.85	0.386	0.412	125	Pass
78	2480	-7.46	-7.18	0.179	0.191	125	Pass

Peak Power Spectrum Plot

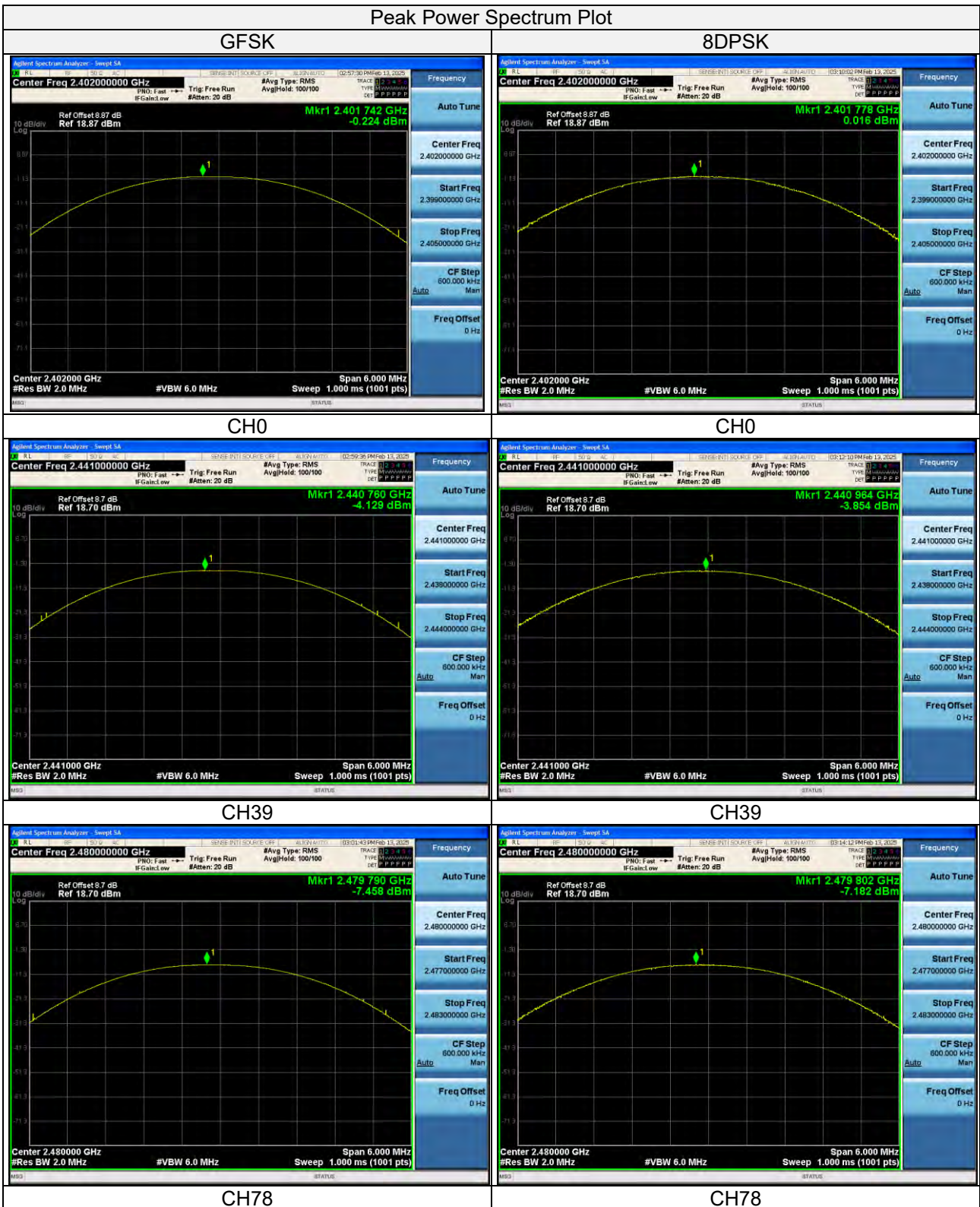

Lab: [Hwa-Hsing \(Dongguan\) Testing Co., Ltd.](#)
 Address: [No.101, Building N1, Yuyuan 2 Road, Yuyuan Industrial Park, HuangJiang Town, Dongguan City, People's Republic of China](#)

Tel: [0769-83078199](tel:0769-83078199)
 Web: www.hwa-hsing.com
 E-Mail: customerservice.dg@hwa-hsing.com

Release
 Ver. 1.5

3.9 Conducted Out of Band Emission Measurement

3.9.1 Limits of Conducted Out of Band Emission Measurement

- a. **If the maximum peak conducted output power procedure was used to determine compliance as described in 11.9.1**, then the peak output power measured in any 100 kHz bandwidth outside of the authorized frequency band shall be attenuated by at least 20 dB relative to the maximum in-band peak PSD level in 100 kHz (i.e., 20 dBc).
- b. **If maximum conducted (average) output power was used to determine compliance as described in 11.9.2**, then the peak power in any 100 kHz bandwidth outside of the authorized frequency band shall be attenuated by at least 30 dB relative to the maximum in-band peak PSD level in 100 kHz (i.e., 30 dBc)

3.9.2 Test Setup

- DTS emissions in non-restricted frequency bands Subclause 11.11 of ANSI C63.10 is applicable.
- DTS emissions in restricted frequency bands Subclause 11.12 of ANSI C63.10 is applicable.

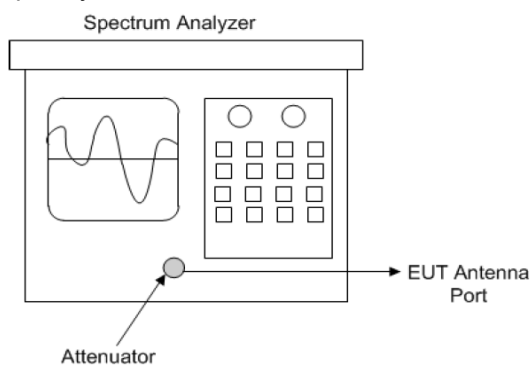

Spectrum analyzer test configuration

3.9.3 Test Instruments

Refer to section 5 to get information of above instrument.

Test Report No.: 2502050066-RF-US-01

3.9.4 Test Procedure

a. Establish a reference level by using the following procedure:

- 1) Set instrument center frequency to DTS channel center frequency.
- 2) Set the span to 21.5 times the DTS bandwidth)
- 3) Set the RBW= 100 kHz)
- 4) Set the VBW $\geq 3 \times$ RBW
- 5) Detector = peak
- 6) Sweep time = auto coupling
- 7) Trace mode =max hold
- 8) Allow trace to fully stabilize
- 9) Use the peak marker function to determine the maximum PSD level.

Note that the channel found to contain the maximum PSD level can be used to establish the reference level.

b. Establish an emission level by using the following procedure:

- 1) Set the center frequency and span to encompass frequency range to be measured.
- 2) Set the RBW = 100 kHz
- 3) Set the VBW ≥ 300 kHz.
- 4) Detector = peak.
- 5) Sweep time = auto couple.
- 6) Trace mode = max hold.
- 7) Allow trace to fully stabilize.
- 8) Use the peak marker function to determine the maximum power level in any 100 kHz band segment within the fundamental EBW.

3.9.5 Deviation from Test Standard

No deviation.

3.9.6 EUT Operating Condition

The software provided by client enabled the EUT to transmit and receive data at lowest, middle and highest channel frequencies individually.

Lab: [Hwa-Hsing \(Dongguan\) Testing Co., Ltd.](#)

Address: [No.101, Building N1, Yuyuan 2 Road, Yuyuan Industrial Park, HuangJiang Town, Dongguan City, People's Republic of China](#)

Tel: [0769-83078199](#)

Web.: [www.hwa-hsing.com](#)

E-Mail: customerservice.dg@hwa-hsing.com

Release
Ver. 1.5

3.9.7 Test Results

The spectrum plots are attached on the following images. D1 line indicates the highest level, D2 line indicates the 20dB offset below D1. It shows compliance with the requirement.

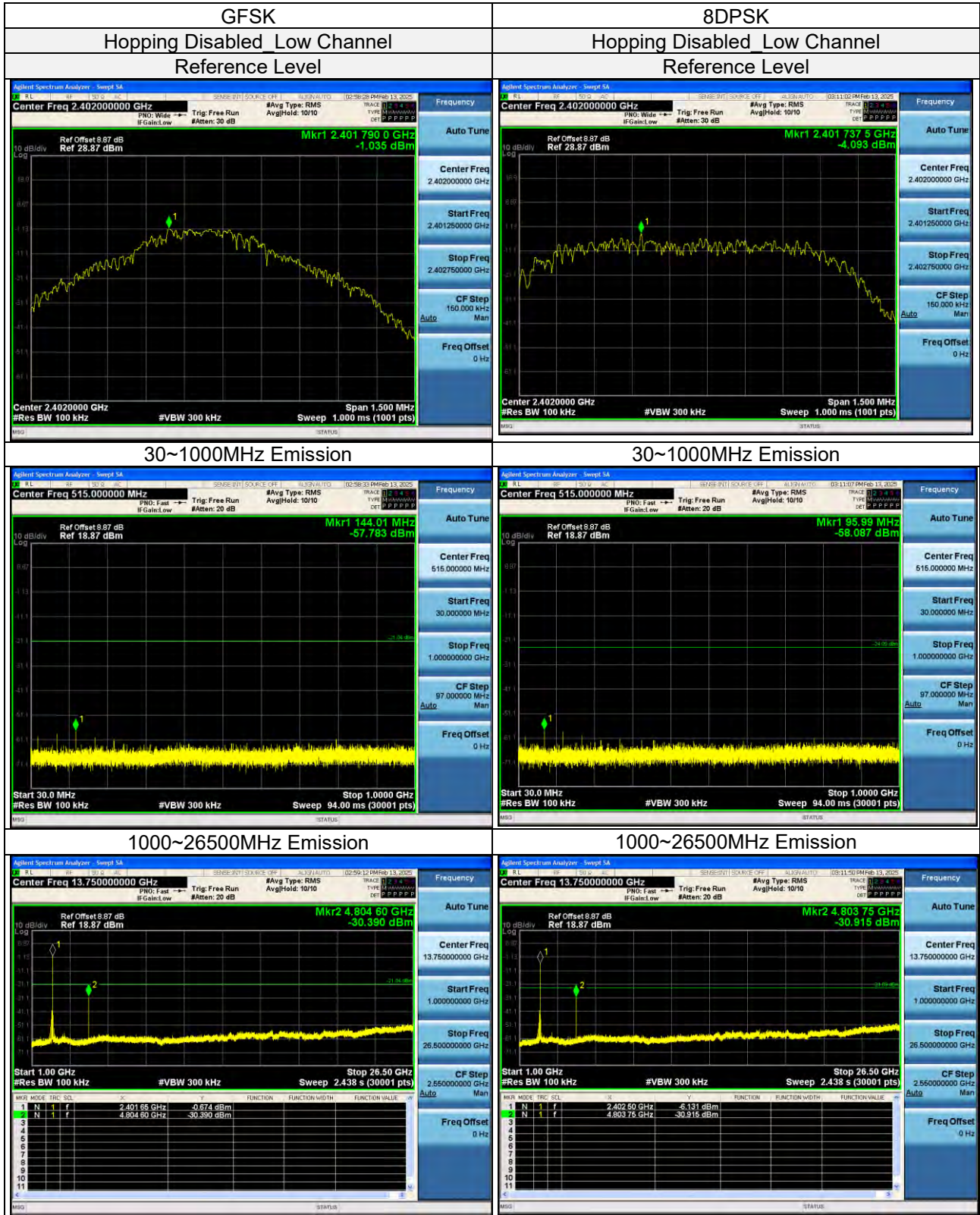

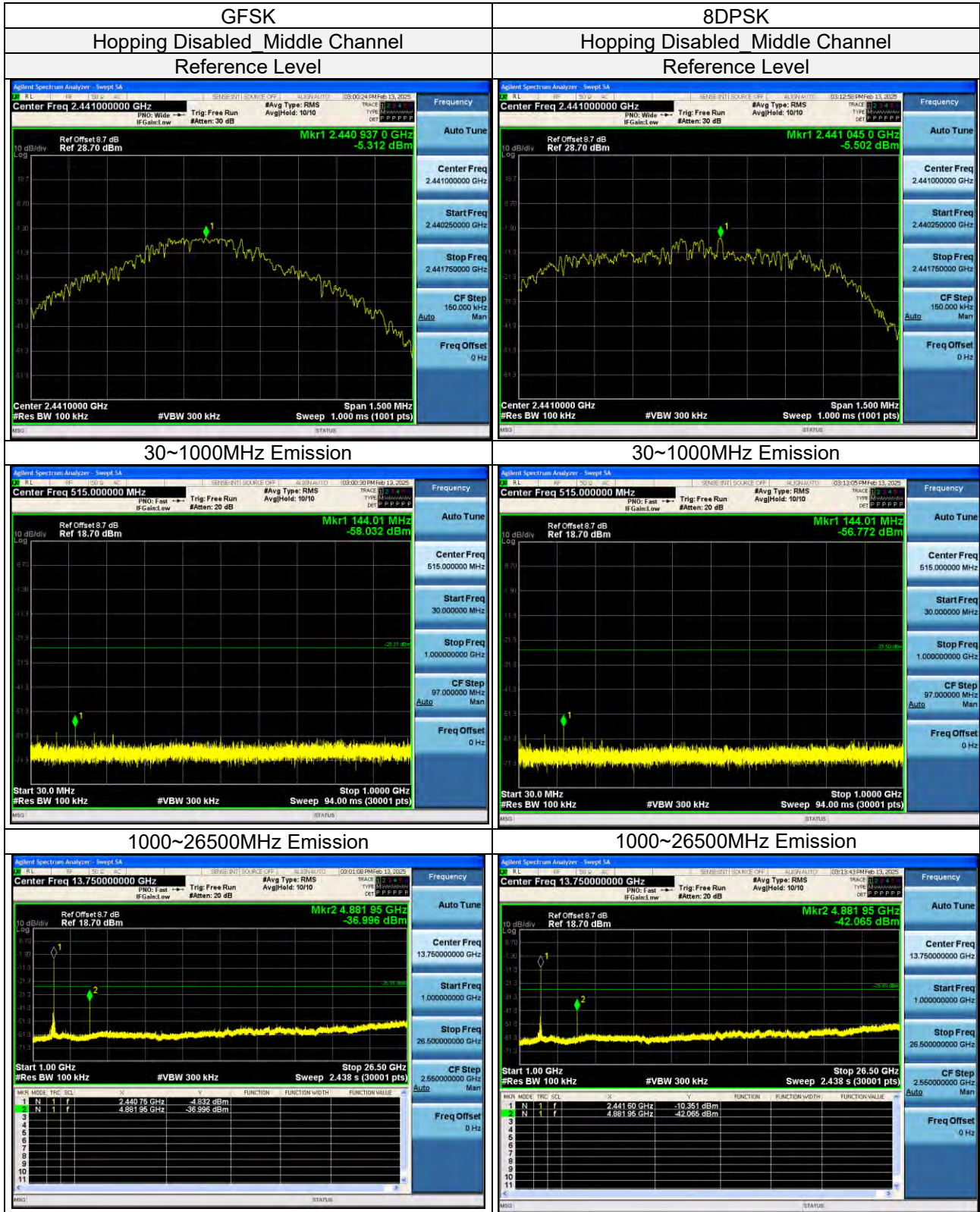

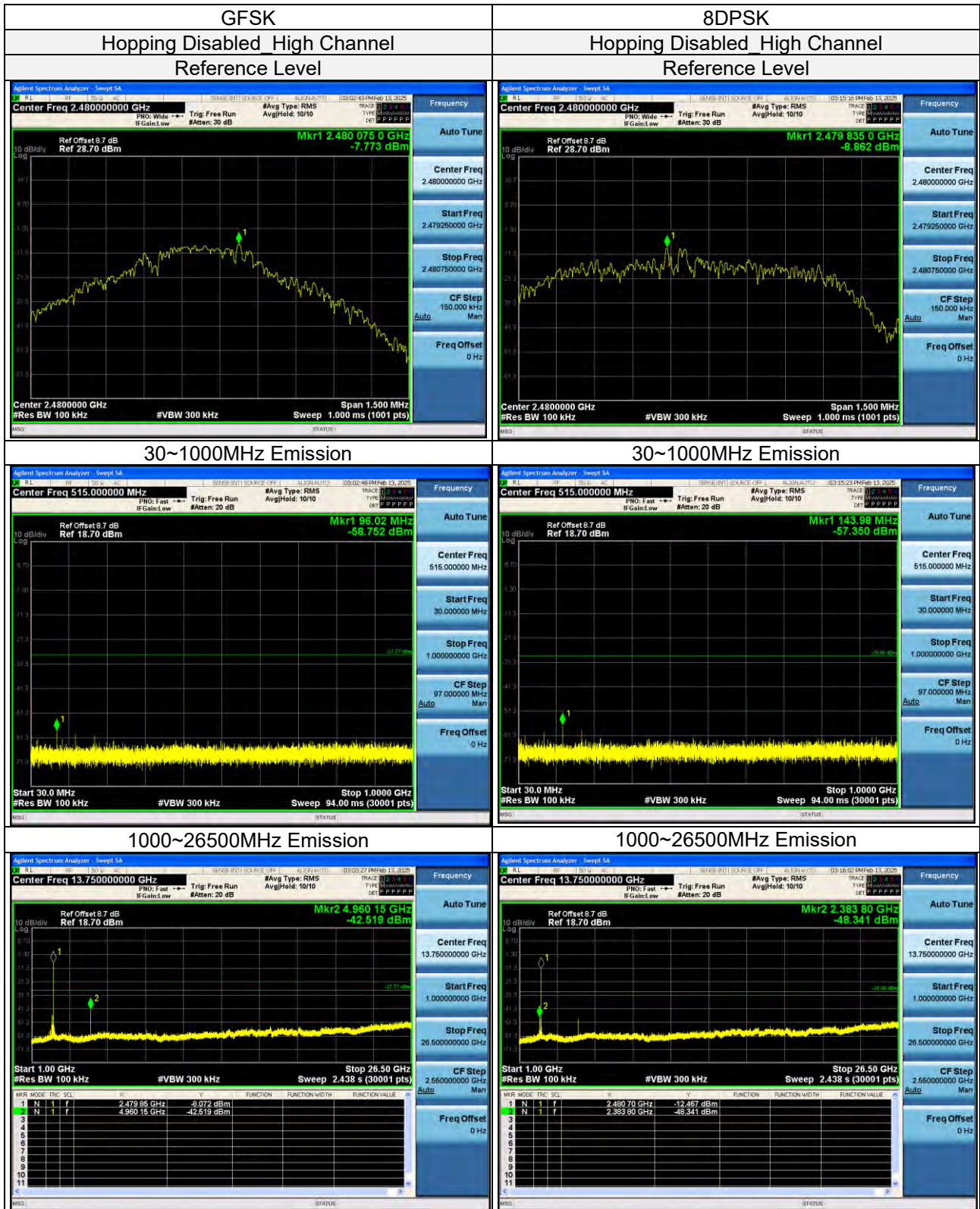

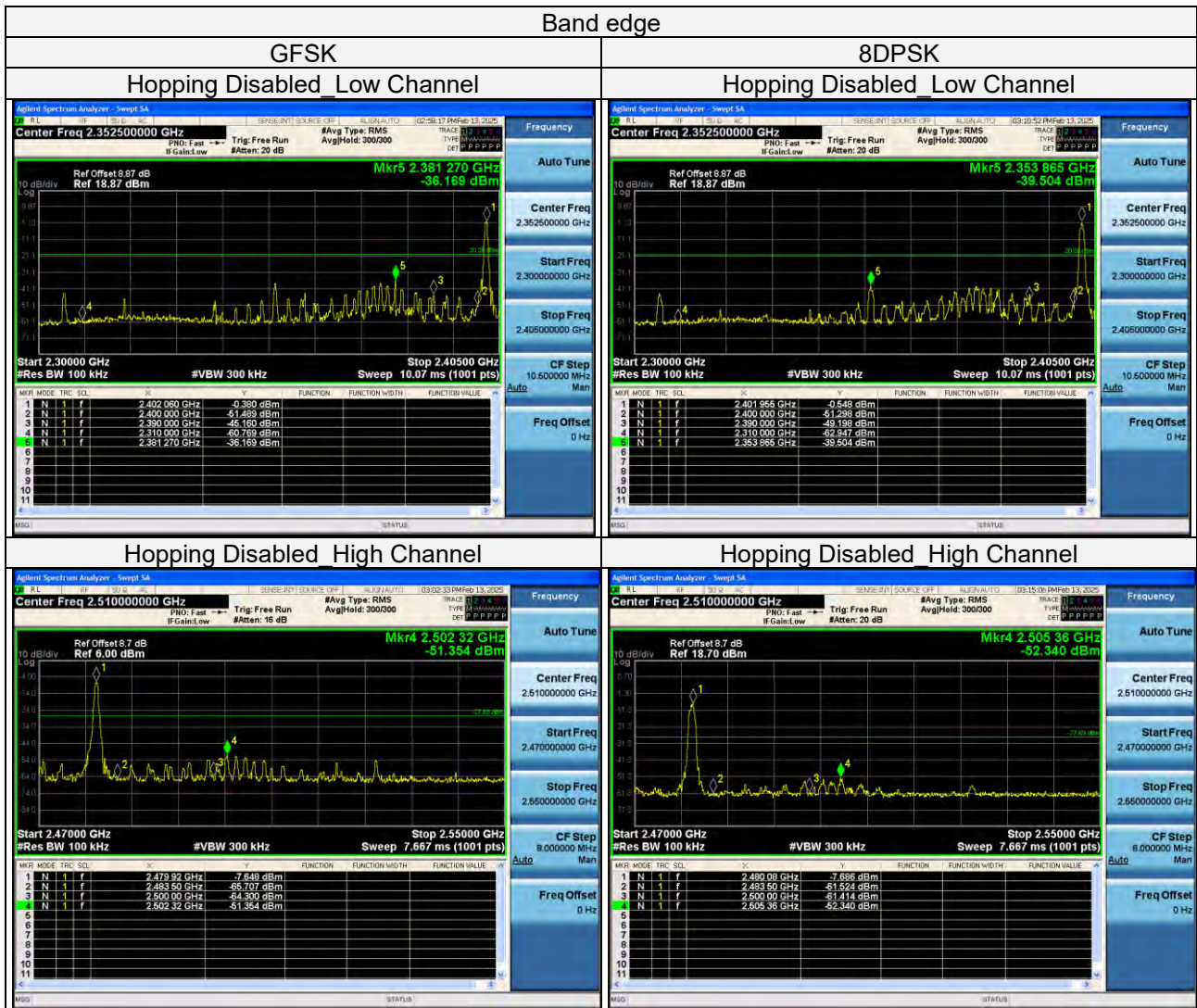



Test Report No.: 2502050066-RF-US-01

4 Pictures of Test Arrangements

Please refer to the attached file (Test Setup Photo).

Lab: [Hwa-Hsing \(Dongguan\) Testing Co., Ltd.](#)

Address: [No.101, Building N1, Yuyuan 2 Road, Yuyuan Industrial Park, HuangJiang Town, Dongguan City, People's Republic of China](#)

Tel: [0769-83078199](tel:0769-83078199)

Web.: www.hwa-hsing.com

E-Mail: customerservice.dg@hwa-hsing.com

Release
[Ver. 1.5](#)

5 Test Instruments

Equipment	Manufacturer	Model No.	Serial No.	Next Cal.Date
Spectrum	Keysight	N9020A	MY51240612	2025-07-25
Spectrum Analyzer	Rohde&Schwarz	FSV-40N	101783	2025-07-25
Power Meter 10Hz~18GHz	Tonscend	JS0806-2	188060126	2025-07-25
Signal generator	Keysight	E4421B	GB40051020	2025-05-16
Universal Switch Control Unit	Rohde&Schwarz	CMW500	12010002k50	2025-07-25
Test Software	Tonscend	JS0806-2	NA	NA
Humidity tester	Jingchuang	GSP-8A	CMA22B000592	2025-07-29

Note: 1. The calibration interval of the above test instruments is 12 months.
2. The test was performed in RF Chamber.

Test Report No.: 2502050066-RF-US-01

Appendix – Information on the Testing Laboratories

We, [Hwa-Hsing \(Dongguan\) Testing Co., Ltd.](#), A global provider of TESTING and CERTIFICATION services for consumer products, electronic products and wireless information technology products. Adhering to the core values “HONEST and TRUSTWORTHY, OBJECTIVE and IMPARTIALITY, RIGOROUS and AFFICIENT”, commitment to provide professional, perfect and efficient comprehensive ONE-STOP solution of TESTING and CERTIFICATION services for Manufacturers, Buyers, Traders, Brands, Retailers. Assist client to better manage risk, protect their brands, reduce costs and cut time to over 150 markets in global. Our laboratories are FCC recognized accredited test firms and accredited and approved according to ISO/IEC 17025.

If you have any comments, please feel free to contact us at the following:

Lab Address: [No.101, Building N1, Yuyuan 2 Road, Yuyuan Industrial Park, HuangJiang Town, Dongguan City, People's Republic of China](#)

Contact Tel: [0769-83078199](tel:0769-83078199)

Email: Customerservice.dg@hwa-hsing.com

Web Site: www.hwa-hsing.com

The address and road map of all our labs can be found in our web site also.

--- END ---