



MEASUREMENT REPORT

FCC PART 15.247 Bluetooth-LE

Report No.: S202307034506E12

Issue Date: 01-10-2024

Applicant: BDStar Intelligent & Connected Vehicle Technology Co.,Ltd.

Address: No. 2, Building 81, Tonggui Avenue, Yufengshan Town, Yubei District, Chongqing P.R. China

FCC ID: 2BAQL-CFDLMMI001

Product: Motorcycle Media Players

Model No.: CFDLMMI001

FCC Classification: Digital Transmission System (DTS)

FCC Rule Part(s): Part 15 Subpart C (15.247)

Test Procedure(s): ANSI C63.10-2013, KDB 558074 D01v05r02

Result: Pass

Item Receipt Date: Jul 05, 2023

Test Date: Jul 22, 2023

Compiled By Amos Xia
(Amos Xia)
Senior Test Engineer

Approved By Line Chen
(Line Chen)
Engineer Manager

The test results relate only to the samples tested.

This equipment has been shown to be capable of compliance with the applicable technical standards as indicated in the measurement report and was tested in accordance with the measurement procedures specified in ANSI C63.4-2014. Test results reported herein relate only to the item(s) tested.

The test report shall not be reproduced except in full without the written approval of Fanguang Inspection & Testing Co., Ltd. Wuxi Branch

The test report must not be used by the client to claim product certifications, approval, or endorsement by NVLAP, NIST or any agency of U.S. Government.



Revision History

Report No.	Version	Description	Issue Date
S202307034506E12	Rev. 01	/	01-10-2024

CONTENTS

Description	Page
§2.1033 General Information	5
1. INTRODUCTION	6
1.1. Scope	6
1.2. Fangguang Test Location	6
2. PRODUCT INFORMATION	7
2.1. Equipment Description.....	7
2.2. Product Specification Subjective to this Report.....	7
2.3. Operation Frequency / Channel List	8
2.4. Device Capabilities	8
2.5. Description of Test Software.....	8
2.6. Test Mode	8
2.7. Test Configuration	9
2.8. EMI Suppression Device(s)/Modifications.....	9
2.9. Labeling Requirements.....	9
2.10. Calculation with all conversion and correction factors used	9
3. DESCRIPTION OF TEST	10
3.1. Evaluation Procedure	10
3.2. AC Line Conducted Emissions	10
3.3. Radiated Emissions	11
4. ANTENNA REQUIREMENTS.....	12
5. TEST EQUIPMENT CALIBRATION DATE.....	13
6. MEASUREMENT UNCERTAINTY.....	14
7. TEST RESULT	15
7.1. Summary	15
7.2. 6dB Bandwidth Measurement.....	16
7.2.1. Test Limit	16
7.2.2. Test Procedure used.....	16
7.2.3. Test Setting.....	16
7.2.4. Test Setup.....	16
7.2.5. Test Result.....	17
7.3. Output Power Measurement.....	19
7.3.1. Test Limit	19

7.3.2.	Test Procedure Used	19
7.3.3.	Test Setting.....	19
7.3.4.	Test Setup.....	20
7.3.5.	Test Result.....	20
7.4.	Power Spectral Density Measurement.....	22
7.4.1.	Test Limit	22
7.4.2.	Test Procedure Used	22
7.4.3.	Test Setting.....	22
7.4.4.	Test Setup.....	23
7.4.5.	Test Result.....	24
7.5.	Conducted Band Edge and Out-of-Band Emissions.....	26
7.5.1.	Test Limit	26
7.5.2.	Test Procedure Used	26
7.5.3.	Test Setting.....	26
7.5.4.	Test Setup.....	26
7.5.5.	Test Result.....	27
7.6.	Radiated Spurious Emission Measurement	34
7.6.1.	Test Limit	34
7.6.2.	Test Procedure Used	34
7.6.3.	Test Setting.....	34
7.6.4.	Test Setup.....	36
7.6.5.	Test Result.....	38
7.7.	Restricted Band Edge Measurement	43
7.7.1.	Test Limit	43
7.7.2.	Test Procedure Used	46
7.7.3.	Test Setting.....	46
7.7.4.	Test Setup.....	47
7.7.5.	Test Result.....	48
7.8.	AC Conducted Emissions Measurement.....	51
7.8.1.	Test Limit	51
7.8.2.	Test Setup.....	51
7.8.3.	Test Result.....	51
8.	CONCLUSION.....	52

§2.1033 General Information

Applicant:	BDStar Intelligent & Connected Vehicle Technology Co.,Ltd.
Applicant Address:	No. 2, Building 81, Tonggui Avenue, Yufengshan Town, Yubei District, Chongqing P.R. China
Manufacturer:	BDStar Intelligent & Connected Vehicle Technology Co.,Ltd.
Manufacturer Address:	No. 2, Building 81, Tonggui Avenue, Yufengshan Town, Yubei District, Chongqing P.R. China
Test Site:	Fanguang Inspection & Testing Co., Ltd.
LAB ID:	CN5037
Test Site Address:	G9 Building, China Sensor Network International Innovation Park No.200, Linghu Avenue Wuxi, Jiangsu 214000 China
FCC Rule Part(s):	Part 15 Subpart C (15.247)
FCC ID:	2BAQL-CFDLMMI001
Test Device Serial No.:	S/N.:/ <input type="checkbox"/> Production <input checked="" type="checkbox"/> Pre-Production <input type="checkbox"/> Engineering
FCC Classification:	Digital Transmission System (DTS)

1. INTRODUCTION

1.1. Scope

Measurement and determination of electromagnetic emissions (EMC) of radio frequency devices including intentional and/or unintentional radiators for compliance with the technical rules and regulations of the Federal Communications Commission and the Innovation, Science and Economic Development Canada.

1.2. Fangguang Test Location

These measurement tests were performed at the Fangguang Inspection and testing Co.,LTD located at 200 Linghu Avenue, Xinwu District, Wuxi City. The detailed description of the measurement facility was found to be in compliance with the requirements of ANSI C63.4-2014.

2. PRODUCT INFORMATION

2.1. Equipment Description

Product Name:	Motorcycle Media Players						
Model Name:	CFDLMMI001						
Additional Model:	CFDLMMI001,CFDLMMI002,CFDLMMI003,CFDLMMI004,CFDLMMI005,CFDLMMI006,CFDLMMI007						
Model Description:	They are have the same technical construction including circuit diagram, PCB LAYOUT, hardware version and software version identical. the difference refer the below table.						
	Model	Size	RG440: Wifi+BT	BE470:BT	FM/AM	GP S	USB
	CFDLMMI001	12.3 “	√	√	√	√	√
	CFDLMMI002	12.3 “	√	√	×	√	√
	CFDLMMI003	12.3 “	√	√	√	×	√
	CFDLMMI004	12.3 “	√	√	√	√	×
	CFDLMMI005	12.3 “	√	√	×	×	√
	CFDLMMI006	12.3 “	√	√	√	×	×
CFDLMMI007	12.3 “	√	√	×	√	×	
Input Voltage Range:	DC: 13.5V						
Bluetooth Version:	5.0						

2.2. Product Specification Subjective to this Report

Bluetooth Frequency	2402~2480MHz
Channel Number:	40
Type of modulation	GFSK
Data Rate	1Mbps
Antenna Type:	PCB Antenna
Antenna Gain:	2.7dBi

2.3. Operation Frequency / Channel List

Channel	Frequency	Channel	Frequency	Channel	Frequency
00	2402 MHz	01	2404 MHz	02	2406 MHz
03	2408 MHz	04	2410 MHz	05	2412 MHz
06	2414 MHz	07	2416 MHz	08	2418 MHz
09	2420 MHz	10	2422 MHz	11	2424 MHz
12	2426 MHz	13	2428 MHz	14	2430 MHz
15	2432 MHz	16	2434 MHz	17	2436 MHz
18	2438 MHz	19	2440 MHz	20	2442 MHz
21	2444 MHz	22	2446 MHz	23	2448 MHz
24	2450 MHz	25	2452 MHz	26	2454 MHz
27	2456 MHz	28	2458 MHz	29	2460 MHz
30	2462 MHz	31	2464 MHz	32	2466 MHz
33	2468 MHz	34	2470 MHz	35	2472 MHz
36	2474 MHz	37	2476 MHz	38	2478 MHz
39	2480 MHz	--	--	--	--

2.4. Device Capabilities

This device contains the following capabilities:Bluetooth (5.0)

Note: The maximum achievable duty cycle was determined based on measurements performed on a spectrum analyzer in zero-span mode with RBW = 8MHz, VBW =8MHz. The RBW and VBW were both greater than 50/T, where T is the minimum transmission duration, and the number of sweep points across T was greater than 100. The duty cycles of BLE_1M are 100%.

2.5. Description of Test Software

The test utility software used during testing was “BlueTool”, and the emission setting value is the software default value.

2.6. Test Mode

Test Mode	Mode 1: Transmit by BLE_1M
-----------	----------------------------

2.7. Test Configuration

The EUT was tested per the guidance of KDB 558074 D01 v05r02. ANSI C63.10-2013 was used to reference the appropriate EUT setup for radiated spurious emissions testing and AC line conducted testing.

2.8. EMI Suppression Device(s)/Modifications

No EMI suppression device(s) were added and/or no modifications were made during testing.

2.9. Labeling Requirements

Per 2.1074 & 15.19; Docket 95-19

The label shall be permanently affixed at a conspicuous location on the device; instruction manual or pamphlet supplied to the user and be readily visible to the purchaser at the time of purchase.

However, when the device is so small wherein placement of the label with specified statement is not practical, only the FCC ID must be displayed on the device per Section 15.19(a)(5). Please see attachment for FCC ID label and label location.

2.10. Calculation with all conversion and correction factors used

For AC Line Conducted Emissions Test:

Measure Level (dB μ V) = Reading Level (dB μ V) + Factor (dB)

Factor (dB) = Cable Loss (dB) + LISN Factor (dB)

For Radiated Emissions Below 1GHz Test:

Measure Level (dB μ V/m) = Reading Level (dB μ V) + Factor (dB)

Factor (dB) = Cable Loss (dB) + Antenna Factor (dB/m).

For Radiated Emissions Above 1GHz Test:

Measure Level (dB μ V/m) = Reading Level (dB μ V) + Factor (dB)

Factor (dB) = Cable Loss (dB) + Antenna Factor (dB/m) - Pre_Amplifier Gain (dB).

3. DESCRIPTION OF TEST

3.1. Evaluation Procedure

The measurement procedures described in the American National Standard for Testing Unlicensed Wireless Devices (ANSI C63.10-2013), and the guidance provided in KDB 558074 D01 v05r02 were used in the measurement of the EUT.

Deviation from measurement procedure.....None

3.2. AC Line Conducted Emissions

The line-conducted facility is located inside an 8'x4'x4' shielded enclosure. A 1m x 2m wooden table 80cm high is placed 40cm away from the vertical wall and 80cm away from the sidewall of the shielded room. Two 10kHz-30MHz, 50Ω/50uH Line-Impedance Stabilization Networks (LISNs) are bonded to the shielded room floor. Power to the LISNs is filtered by external high-current high-insertion loss power line filters. These filters attenuate ambient signal noise from entering the measurement lines. These filters are also bonded to the shielded enclosure.

The EUT is powered from one LISN and the support equipment is powered from the second LISN. All interconnecting cables more than 1 meter were shortened to a 1 meter length by non-inductive bundling (serpentine fashion) and draped over the back edge of the test table. All cables were at least 40cm above the horizontal reference ground-plane. Power cables for support equipment were routed down to the second LISN while ensuring that that cables were not draped over the second LISN.

Sufficient time for the EUT, support equipment, and test equipment was allowed in order for them to warm up to their normal operating condition. The RF output of the LISN was connected to the receiver and exploratory measurements were made to determine the frequencies producing the maximum emission from the EUT. The receiver was scanned from 150kHz to 30MHz. The detector function was set to peak mode for exploratory measurements while the bandwidth of the analyzer was set to 9kHz. The EUT, support equipment, and interconnecting cables were arranged and manipulated to maximize each emission. Each emission was also maximized by varying: power lines, the mode of operation or data exchange speed, or support equipment whichever determined the worst-case emission. Once the worst case emissions have been identified, the one EUT cable configuration/arrangement and mode of operation that produced these emissions are used for final measurements on the same test site. The analyzer is set to CISPR quasi-peak and average detectors with a 9kHz resolution bandwidth for final measurements.

An extension cord was used to connect to a single LISN which powered by EUT. The extension cord was calibrated with LISN, the impedance and insertion loss are compliance with the requirements as stated in ANSI C63.10-2013.

3.3. Radiated Emissions

The radiated test facilities consisted of an indoor 3 meter semi-anechoic chamber used for final measurements and exploratory measurements, when necessary. The measurement area is contained within the semi-anechoic chamber which is shielded from any ambient interference. For measurements above 1GHz absorbers are arranged on the floor between the turn table and the antenna mast in such a way so as to maximize the reduction of reflections. For measurements below 1GHz, the absorbers are removed. The turntable is used for radiated measurement. It is a continuously rotatable, remote controlled, metallic turntable and 2 meters (6.56 ft.) in diameter. The turn table is flush with the raised floor of the chamber in order to maintain its function as a ground plane. An 80cm high PVC support structure is placed on top of the turntable.

For all measurements, the spectrum was scanned through all EUT azimuths and from 1 to 4 meter receive antenna height using a broadband antenna from 30MHz up to the upper frequency shown in 15.33(b)(1) depending on the highest frequency generated or used in the device or on which the device operates or tunes. For frequencies above 1GHz, linearly polarized double ridge horn antennas were used. For frequencies below 30MHz, a calibrated loop antenna was used. When exploratory measurements were necessary, they were performed at 1 meter test distance inside the semi-anechoic chamber using broadband antennas, broadband amplifiers, and spectrum analyzers to determine the frequencies and modes producing the maximum emissions. Sufficient time for the EUT, support equipment, and test equipment was allowed in order for them to warm up to their normal operating condition. The test set-up for frequencies below 1GHz was placed on top of the 0.8 meter high, 1 x 1.5 meter table; and test set-up for frequencies 1-25GHz was placed on top of the 1.5 meter high, 1 x 1.5 meter table. The EUT, support equipment, and interconnecting cables were arranged and manipulated to maximize each emission. Appropriate precaution was taken to ensure that all emissions from the EUT were maximized and investigated. The system configuration, clock speed, mode of operation or video resolution, if applicable, turntable azimuth, and receive antenna height was noted for each frequency found.

Final measurements were made in the semi-anechoic chamber using calibrated, linearly polarized broadband and horn antennas. The test setup was configured to the setup that produced the worst case emissions. The spectrum analyzer was set to investigate all frequencies required for testing to compare the highest radiated disturbances with respect to the specified limits. The turntable containing the EUT was rotated through 360 degrees and the height of the receive antenna was varied 1 to 4 meters and stopped at the azimuth and height producing the maximum emission. Each emission was maximized by changing the orientation of the EUT through three orthogonal planes and changing the polarity of the receive antenna, whichever produced the worst-case emissions. According to 3dB Beam-Width of horn antenna, the horn antenna should be always directed to the EUT when rising height.

4. ANTENNA REQUIREMENTS

Excerpt from §15.203 of the FCC Rules/Regulations:

“An intentional radiator antenna shall be designed to ensure that no antenna other than that furnished by the responsible party can be used with the device. The use of a permanently attached antenna or of an antenna that uses a unique coupling to the intentional radiator shall be considered sufficient to comply with the provisions of this section.”

- Use a unique coupling to the intentional radiator.

5. TEST EQUIPMENT CALIBRATION DATE

Conducted Emissions

Instrument	Manufacturer	Type No.	Asset No.	Cali. Interval	Cali. Due Date
EMI Test Receiver	R&S	ESR3	FWXGJC-2016-181	1 year	2024/03/14
Two-Line V-Network	R&S	ENV 216	FWXGJC-2016-182	1 year	2024/05/14
Thermohygrometer	Yuhuaze	HTC-1	FWXDA-2016-385	1 year	2024/03/21

Radiated Emission

Instrument	Manufacturer	Type No.	Asset No.	Cali. Interval	Cali. Due Date
Loop Antenna	Schwarzbeck	FMZB 1519B	FWXGJC-2018-015	3 year	2024/08/13
Bi-Log Antenna	R&S	HL562E	FWXGJC-2016-267-06	1 year	2024/03/10
Broadband Horn Antenna	R&S	HF907	FWXGJC-2016-267-07	1 year	2024/03/02
Broadband Horn Antenna	Schwarzbeck	BBHA9170	FWXGJC-2018-016	3 year	2024/06/04
EMI Receiver	R&S	ESR26	FWXGJC-2016-267-01	1 year	2023/11/08
Pre-Amplifier	R&S	SCU-18D	FWXGJC-2016-267-05	1 year	2023/11/17
Pre-Amplifier	R&S	EMC184055 SE	FWXGJC-2018-018	3 year	2025/04/13
Thermohygrometer	Yuhuaze	HTC-1	FWXDA-2016-386	1 year	2023/11/21
Anechoic Chamber	Aimuke	EMCCT-3	FWXGJC-2016-270	3 year	2025/06/07

Conducted Test Equipment

Instrument	Manufacturer	Type No.	Asset No.	Cali. Interval	Cali. Due Date
EXA Signal Analyzer	Keysight	N9010B	FWXGJC-2018-010	1 year	2024/03/13
RF Control Unit	Toncend	JS0806-2	FWXGJC-2018-013	1 year	2024/05/14
Thermohygrometer	Yuhuaze	HTC-1	FWXDA-2016-385	1 year	2024/03/21

Test Software	Manufacturer	Version	Asset No.	Function
EMI Test Software	tonscend	V2.5.2.4	FWXWA-2018-004	Emission Test
RF Test Software	Toncend	3.3.10	/	/

6. MEASUREMENT UNCERTAINTY

Where relevant, the following test uncertainty levels have been estimated for tests performed on the EUT as specified in CISPR 16-4-2. This uncertainty represents an expanded uncertainty expressed at approximately the 95% confidence level using a coverage factor of $k = 2$.

AC Conducted Emission Measurement
Measuring Uncertainty for a Level of Confidence of 95% ($U=2Uc(y)$): 2.05dB
Radiated Emission Measurement
Measuring Uncertainty for a Level of Confidence of 95% ($U=2Uc(y)$): 30MHz-1GHz: 3.06dB 1GHz-12.75GHz: 4.13dB
Spurious Emissions, Conducted
Measuring Uncertainty for a Level of Confidence of 95% ($U=2Uc(y)$): 30MHz-1GHz: 1.00 dB 1GHz-26.5GHz: 1.30 dB
Output Power
Measuring Uncertainty for a Level of Confidence of 95% ($U=2Uc(y)$): 0.60dB
Power Spectrum Density
Measuring Uncertainty for a Level of Confidence of 95% ($U=2Uc(y)$): 0.80dB
Occupied Bandwidth
Measuring Uncertainty for a Level of Confidence of 95% ($U=2Uc(y)$): 0.20MHz

7. TEST RESULT

7.1. Summary

FCC Part Section(s)	Test Description	Test Limit	Test Condition	Test Result	Reference
15.247(a)(2)	6dB Bandwidth	$\geq 500\text{kHz}$	Conducted	Pass	Section 7.2
15.247(b)(3)	Output Power	$\leq 30\text{dBm}$		Pass	Section 7.3
15.247(e)	Power Spectral Density	$\leq 8\text{dBm}/3\text{kHz}$		Pass	Section 7.4
15.247(d)	Band Edge	$\geq 20\text{dBc}$		Pass	Section 7.5
15.247(d)	Out-of-Band Emissions	$\geq 20\text{dBc}$		Pass	Section 7.5
15.205	Restricted Bands	Emissions in restricted bands must meet the radiated limits detailed in 15.205		Pass	Section 7.7
15.209	General Field Strength Limits (Radiated Emission Limits)	Radiated Emission must meet the radiated limits detailed in 15.209 (RSS GEN [8.9])	Radiated	Pass	Section 7.6
15.207	AC Conducted Emissions 150kHz - 30MHz	< FCC 15.207 limits (RSS GEN [8.8])	Line Conducted	N/A	Section 7.8

Notes:

- 1) All modes of operation and data rates were investigated. For radiated emission test, every axis (X, Y, Z) was also verified. The test results shown in the following sections represent the worst case emissions.
- 2) The analyzer plots shown in this section were all taken with a correction table loaded into the analyzer. The correction table was used to account for the losses of the cables and attenuators used as part of the system to connect the EUT to the analyzer at all frequencies of interest.
- 3) All antenna port conducted emissions testing was performed on a test bench with the antenna port of the EUT connected to the spectrum analyzer through calibrated cables and attenuators.

7.2. 6dB Bandwidth Measurement

7.2.1. Test Limit

The minimum permissible 6dB bandwidth is 500 kHz.

7.2.2. Test Procedure used

ANSI C63.10-2013 Section 11.8.2 Option 1

KDB 558074 D01 v05r02 – Section 8.2

7.2.3. Test Setting

1. Set RBW = 100 kHz
2. VBW $\geq 3 \times$ RBW
3. Detector = peak
4. Trace mode = max hold
5. Sweep = auto couple
6. Allow the trace was allowed to stabilize
7. Measure the maximum width of the emission that is constrained by the frequencies associated with the two outermost amplitude points (upper and lower frequencies) that are attenuated by 6 dB relative to the maximum level measured in the fundamental emission.

7.2.4. Test Setup

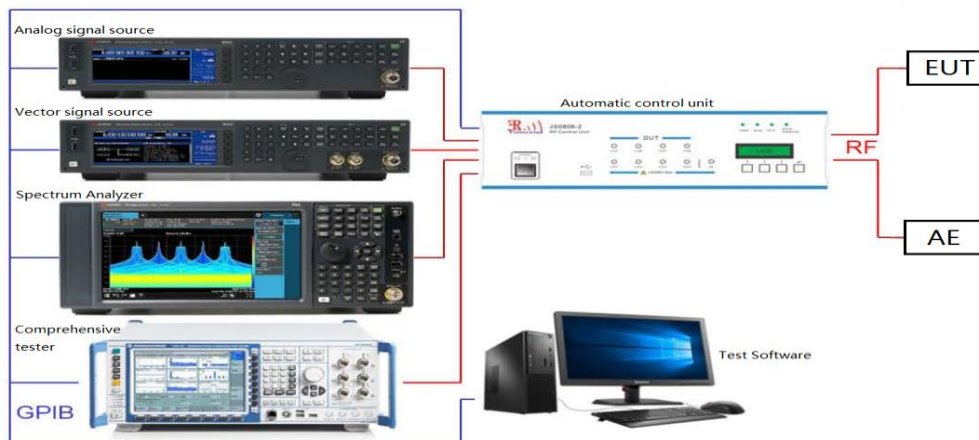

7.2.5. Test Result

Test Mode	Antenna	Channel	DTS BW [MHz]	FL[MHz]	FH[MHz]	Limit[MHz]	99% BW[MHz]	Verdict
BLE_1M	Ant1	2402	0.708	2401.620	2402.328	≥0.5	1.0421	PASS
		2440	0.676	2439.644	2440.320	≥0.5	1.0437	PASS
		2480	0.680	2479.640	2480.320	≥0.5	1.0411	PASS

Test Graphs





7.3. Output Power Measurement

7.3.1. Test Limit

The maximum permissible conducted output power is 1 Watt (30dBm). And for antenna gain greater than 6dBi the limit shall reduce by the amount in dB that the directional gain of the antenna exceeds 6 dBi.

7.3.2. Test Procedure Used

ANSI C63.10-2013 – Section 11.9.1.1

KDB 558074 D01 v05r02 – Section 8.3.1.2

7.3.3. Test Setting

1. Set the RBW \geq DTS bandwidth.
2. Set the VBW \geq [3 \times RBW].
3. Set the span \geq [3 \times RBW].
4. Detector = peak.
5. Sweep time = auto couple.
6. Trace mode = max hold.
7. Allow trace to fully stabilize.
8. Use peak marker function to determine the peak amplitude level.

7.3.4. Test Setup

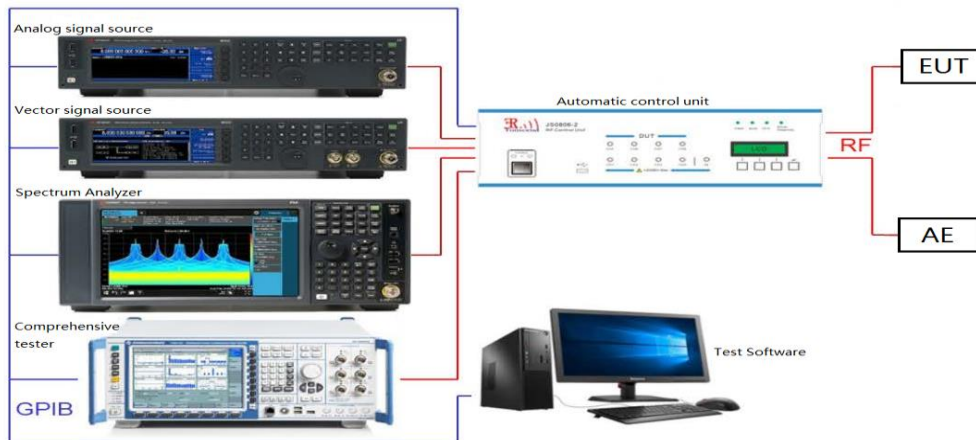

7.3.5. Test Result

Test Mode	Antenna	Channel	Result[dBm]	Limit[dBm]	Verdict
BLE_1M	Ant1	2402	5.89	≤30	PASS
		2440	6.01	≤30	PASS
		2480	5.28	≤30	PASS

Test Graphs



BLE_1M_Ant1_2440

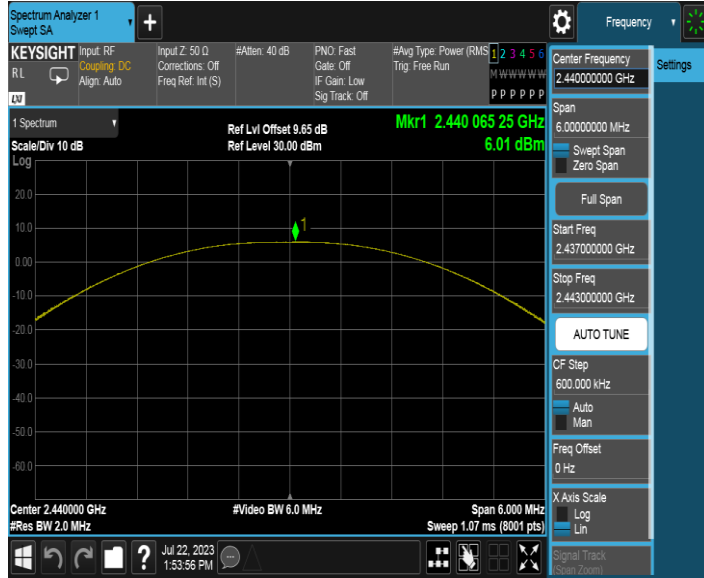

BLE_1M_Ant1_2480

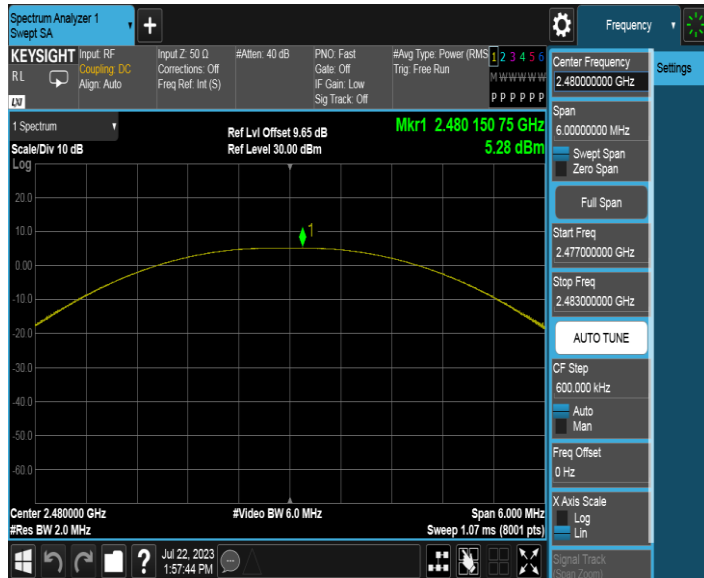

7.4. Power Spectral Density Measurement

7.4.1. Test Limit

The maximum permissible power spectral density is 8dBm in any 3 kHz band. And for antenna gain greater than 6dBi the limit shall reduce by the amount in dB that the directional gain of the antenna exceeds 6 dBi.

7.4.2. Test Procedure Used

KDB 558074 D01 v05r02 - Section 8.4

ANSI C63.10 – Section 11.10.2

7.4.3. Test Setting

1. Set analyzer center frequency to DTS channel center frequency.
2. Set the span to 1.5 times the DTS bandwidth.
3. Set the RBW to $3 \text{ kHz} \leq \text{RBW} \leq 100 \text{ kHz}$.
4. Set the VBW $\geq [3 \times \text{RBW}]$.
5. Detector = peak.
6. Sweep time = auto couple.
7. Trace mode = max hold.
8. Allow trace to fully stabilize.

7.4.4. Test Setup

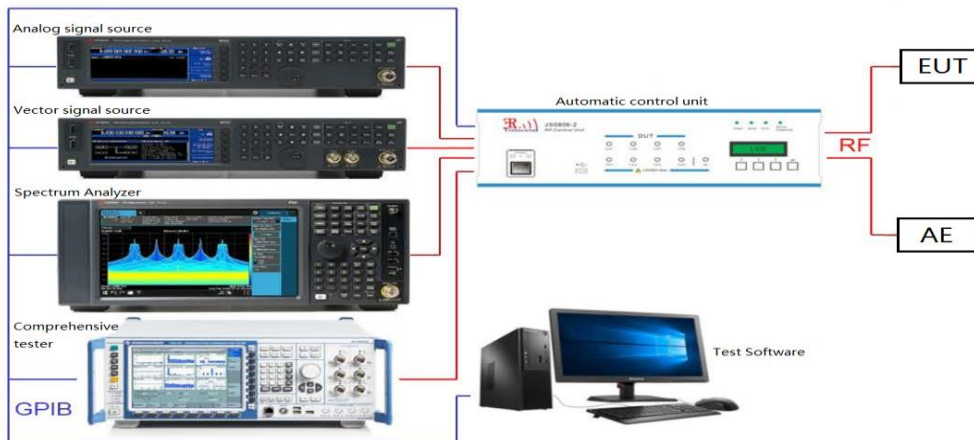

7.4.5. Test Result

Test Mode	Antenna	Channel	Result[dBm/3kHz]	Limit[dBm/3kHz]	Verdict
BLE_1M	Ant1	2402	-8.30	≤8.00	PASS
		2440	-8.12	≤8.00	PASS
		2480	-9.00	≤8.00	PASS

Test Graphs

BLE_1M_Ant1_2402

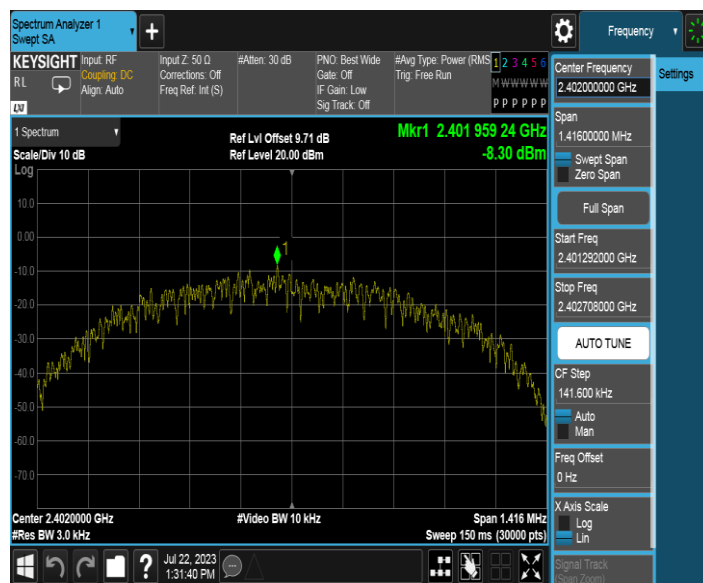

BLE_1M_Ant1_2440

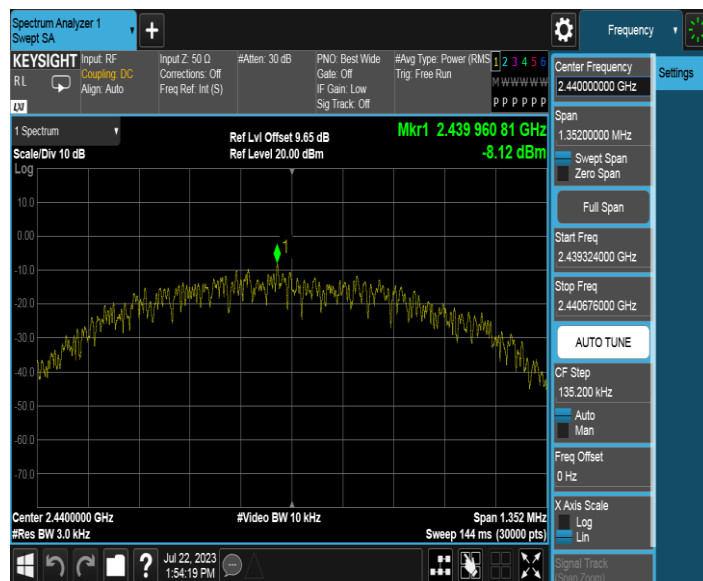

BLE_1M_Ant1_2480

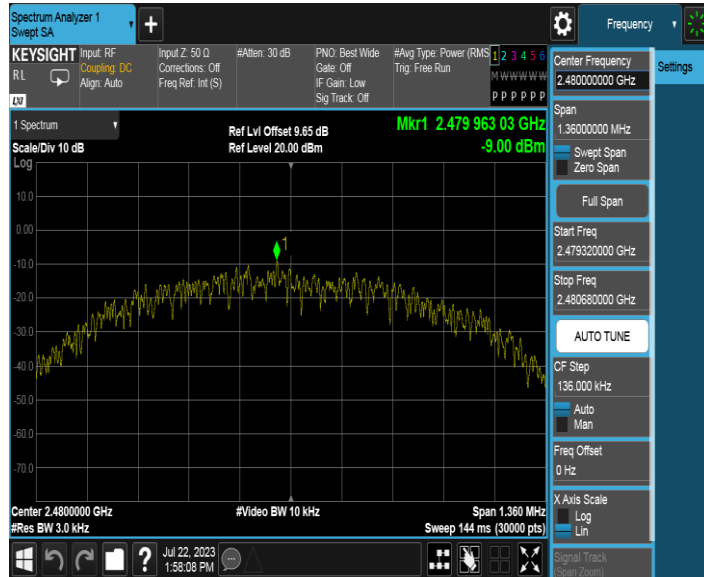

7.5. Conducted Band Edge and Out-of-Band Emissions

7.5.1. Test Limit

The limit for out-of-band spurious emissions at the band edge is 20dB below the fundamental emission level, as determined from the in-band power measurement of the DTS channel performed in a 100 kHz bandwidth per the PSD procedure.

7.5.2. Test Procedure Used

KDB 558074 D01 v05r02 - Section 8.5 & Section 8.6

ANSI C63.10 – Section 11.11&11.12

7.5.3. Test Setting

- (a) Set the center frequency and span to encompass frequency range to be measured
- (b) RBW = 100kHz
- (c) VBW = 300kHz
- (d) Detector = Peak
- (e) Trace mode = max hold
- (f) Sweep time = auto couple
- (g) The trace was allowed to stabilize

7.5.4. Test Setup

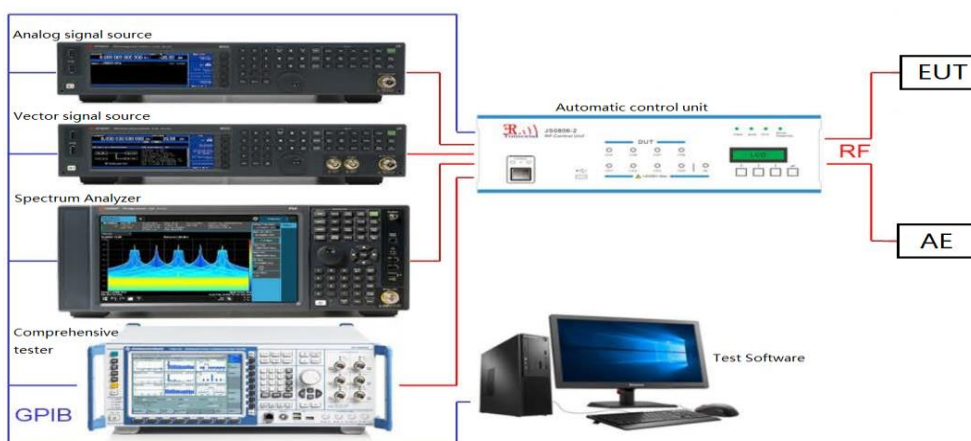

7.5.5. Test Result

Test Mode	Antenna	Channel	FreqRange [MHz]	RefLevel [dBm]	Result[dBm]	Limit[dBm]	Verdict
BLE_1M	Ant1	2402	Reference	5.03	5.03	---	PASS
			30~1000	5.03	-60.66	≤-14.97	PASS
			1000~26500	5.03	-44.25	≤-14.97	PASS
		2440	Reference	5.21	5.21	---	PASS
			30~1000	5.21	-60.54	≤-14.79	PASS
			1000~26500	5.21	-42.62	≤-14.79	PASS
		2480	Reference	4.44	4.44	---	PASS
			30~1000	4.44	-60.63	≤-15.56	PASS
			1000~26500	4.44	-45.89	≤-15.56	PASS

Test Graphs

BLE_1M_Ant1_Low_2402

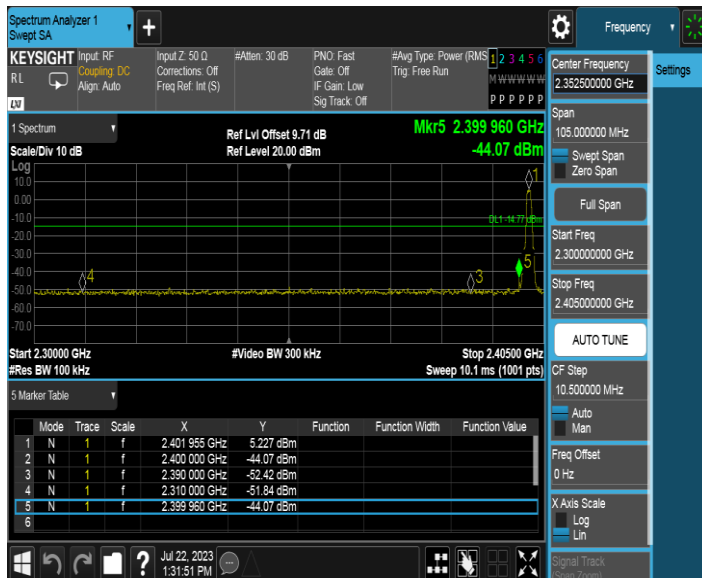

BLE_1M_Ant1_High_2480

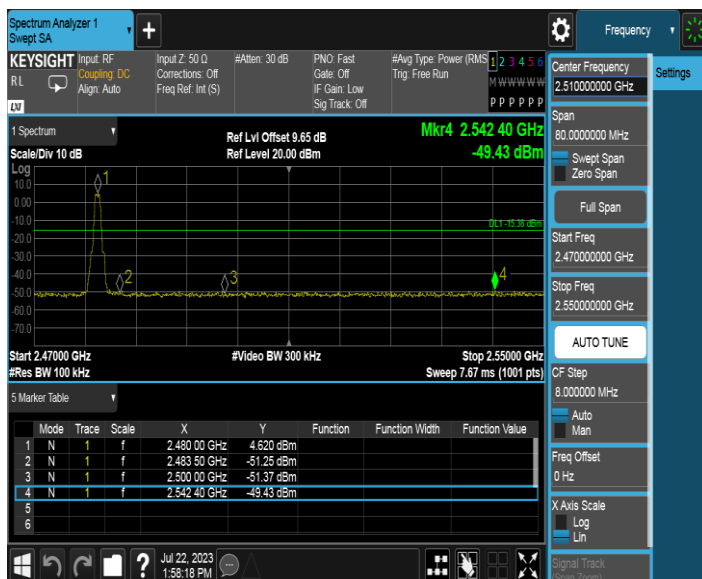

BLE_1M_Ant1_2402_0~Reference



BLE_1M_Ant1_2402_30~1000

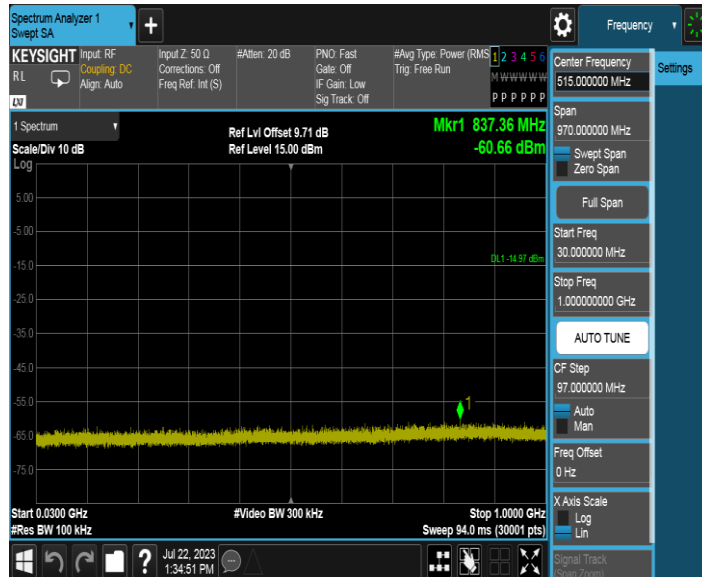

BLE_1M_Ant1_2402_1000~26500

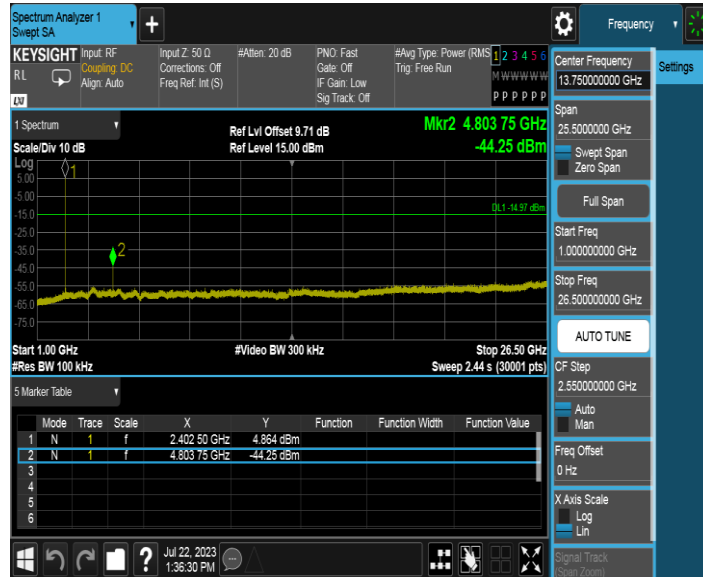

BLE_1M_Ant1_2440_0~Reference



BLE_1M_Ant1_2440_30~1000

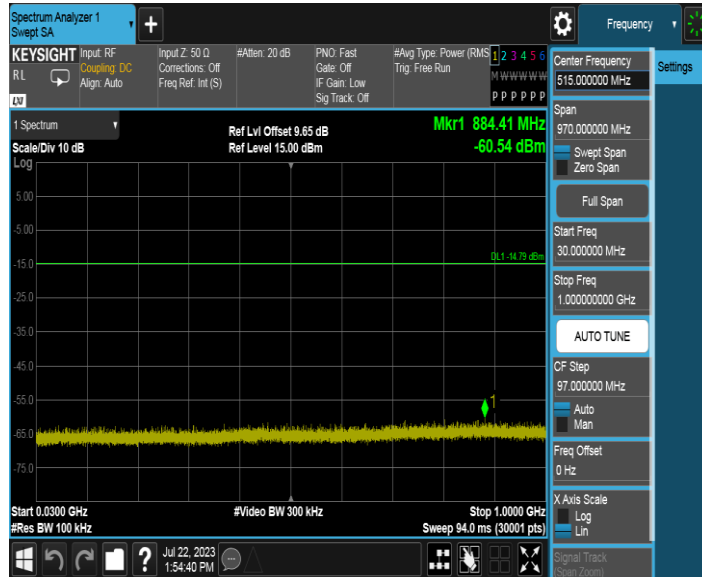

BLE_1M_Ant1_2440_1000~26500



BLE_1M_Ant1_2480_0~Reference



BLE_1M_Ant1_2480_30~1000

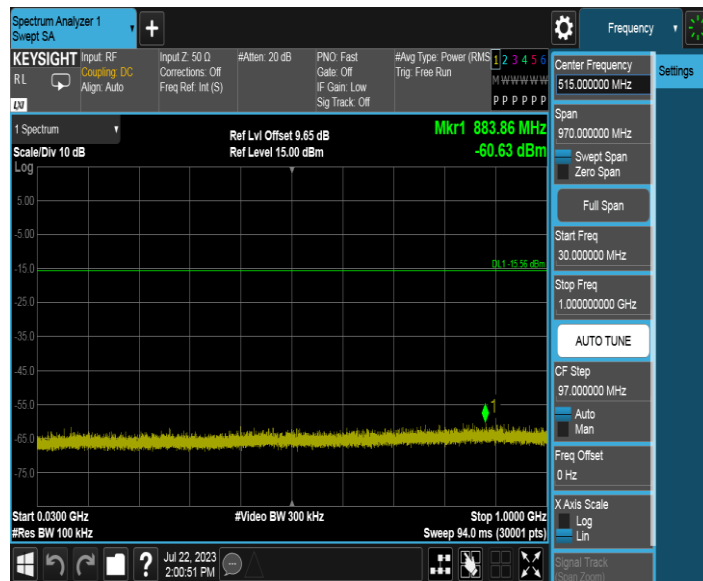

BLE_1M_Ant1_2480_1000~26500

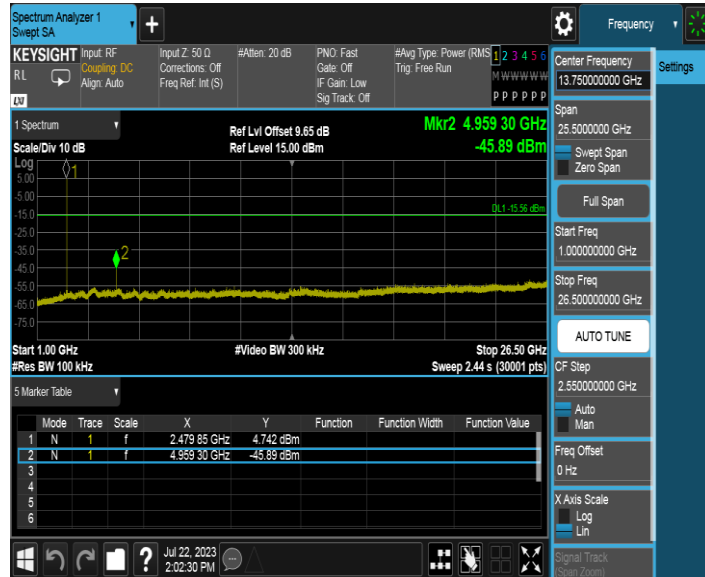

7.6. Radiated Spurious Emission Measurement

7.6.1. Test Limit

All out of band emissions appearing in a restricted band as specified in Section 15.205 of the Title 47 CFR must not exceed the limits shown in Table per Section 15.209.

FCC Part 15 Subpart C Paragraph 15.209		
Frequency [MHz]	Field Strength [uV/m]	Measured Distance [Meters]
0.009 – 0.490	2400/F (kHz)	300
0.490 – 1.705	24000/F (kHz)	30
1.705 - 30	30	30
30 - 88	100	3
88 - 216	150	3
216 - 960	200	3
Above 960	500	3

7.6.2. Test Procedure Used

ANSI C63.10-2013 – Section 6.6.4.3

7.6.3. Test Setting

Peak Field Strength Measurements

1. Analyzer center frequency was set to the frequency of the radiated spurious emission of interest
2. RBW = as specified in Table 1
3. VBW = 3MHz
4. Detector = peak
5. Sweep time = auto couple
6. Trace mode = max hold
7. Trace was allowed to stabilize

Table 1 - RBW as a function of frequency

Frequency	RBW
9 ~ 150 kHz	200 ~ 300 Hz
0.15 ~ 30 MHz	9 ~ 10 kHz
30 ~ 1000 MHz	100 ~ 120 kHz
> 1000 MHz	1 MHz

Average Field Strength Measurements

1. Analyzer center frequency was set to the frequency of the radiated spurious emission of interest
2. RBW = 1MHz
3. VBW = 3MHz
4. Detector = Power Average (RMS)
5. Number of sweep point = 2001 (Number of sweep points must be $\geq 2 \times \text{span} / \text{RBW}$)
6. Sweep time = auto
7. Trace (RMS) averaging was performed over at least 100 traces.

7.6.4. Test Setup

9kHz ~ 30MHz Test Setup:

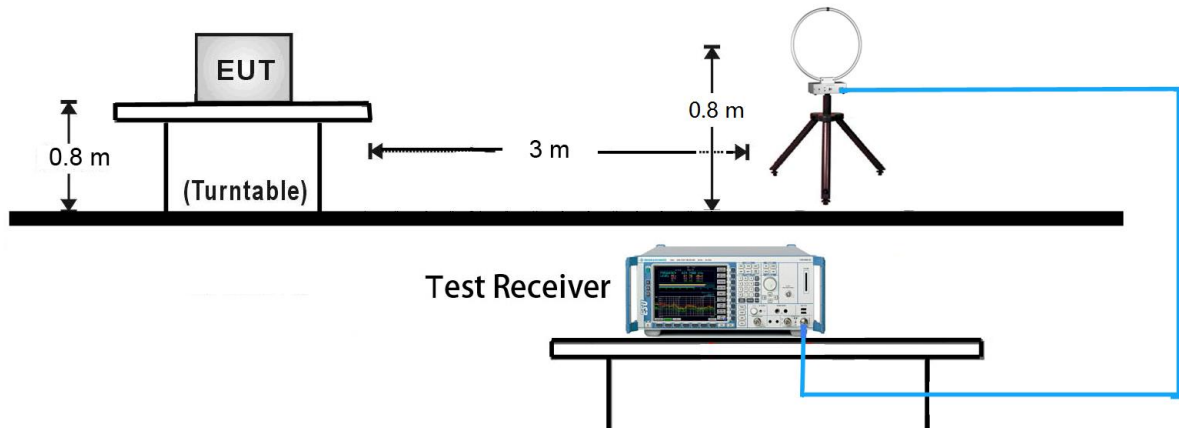

30MHz ~ 1GHz Test Setup:

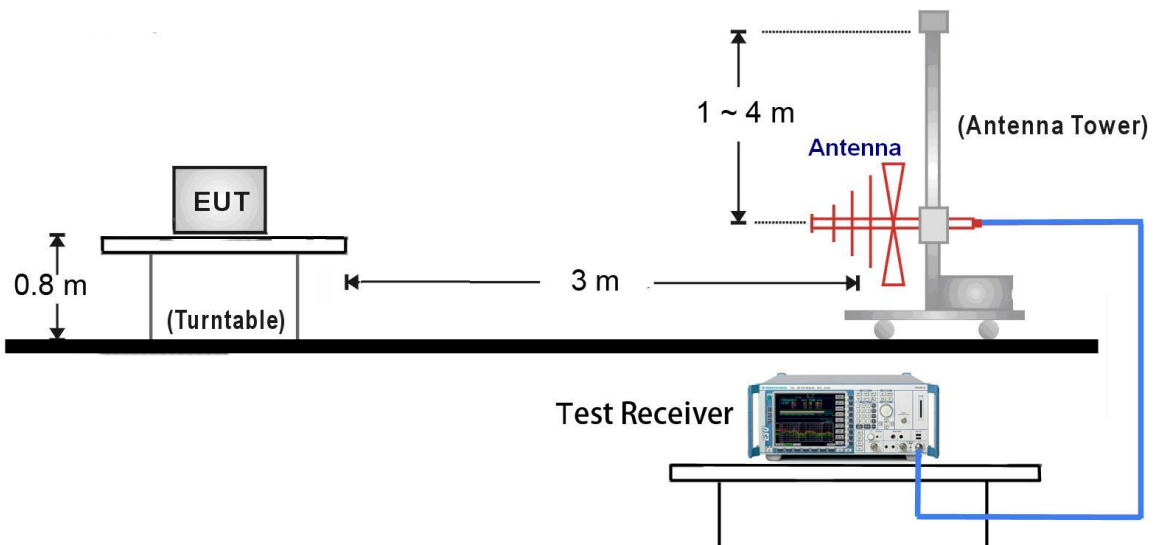

1GHz ~ 18GHz Test Setup:

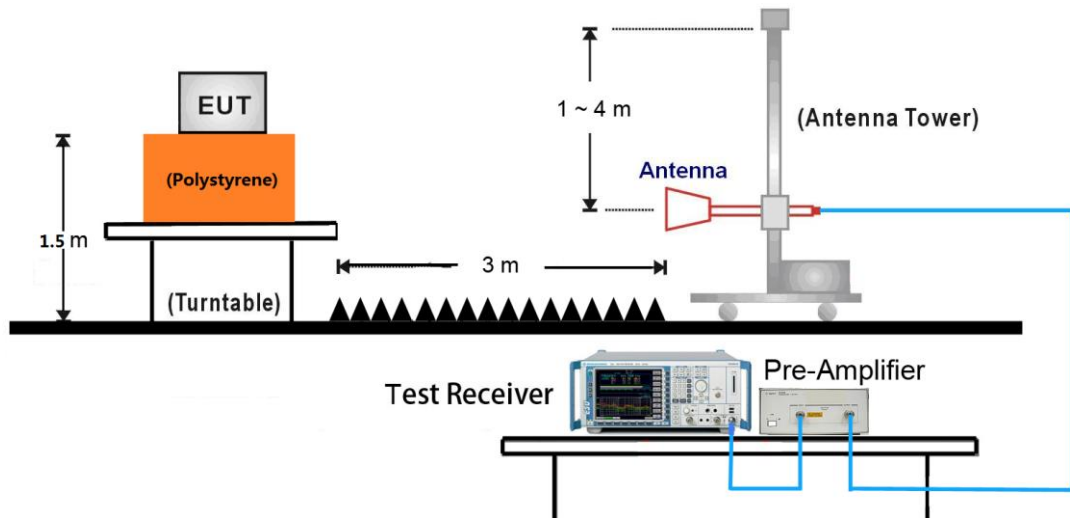

18GHz ~ 26.5GHz Test Setup:

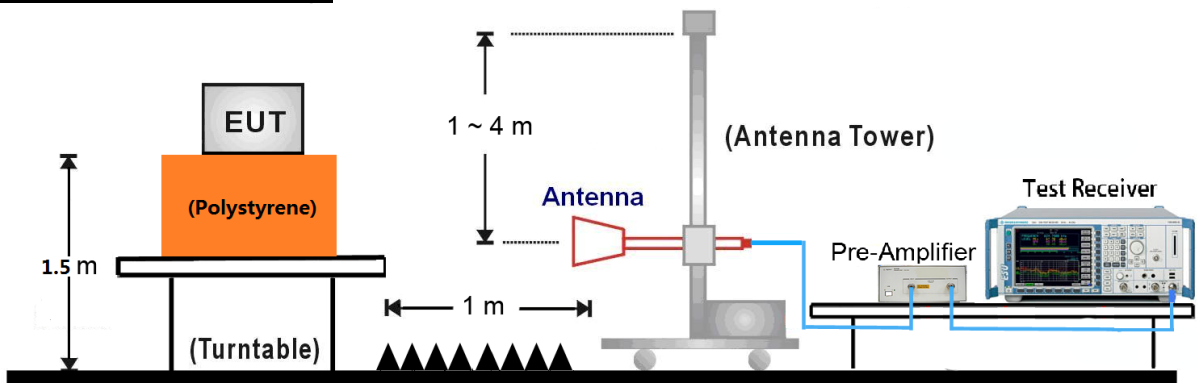

7.6.5. Test Result

Test Mode:	BLE_1M	Test Date:	2023-07-22
Test Channel:	00	Test Engineer:	Amos Xia
Remark:	Average measurement was not performed if peak level lower than average limit. Other frequency was 20dB below limit line within 1-18GHz, there is not show in the report.		

Frequency (MHz)	Level (dB μ V/m)	Factor (dB)	Limit (dB μ V/m)	Margin (dB)	Detector	Polarization
4305.0000	42.32	6.01	74.00	31.68	Peak	Horizontal
4525.0000	43.03	7.04	74.00	30.97	Peak	Horizontal
6300.0000	46.93	11.89	74.00	27.07	Peak	Horizontal
8185.0000	51.81	15.18	74.00	22.19	Peak	Horizontal
3840.0000	41.44	4.63	74.00	32.56	Peak	Vertical
4505.0000	42.99	6.99	74.00	31.01	Peak	Vertical
6300.0000	47.13	11.89	74.00	26.87	Peak	Vertical
7955.0000	51.81	15.62	74.00	22.19	Peak	Vertical

Test Mode:	BLE_1M	Test Date:	2023-07-22
Test Channel:	19	Test Engineer:	Amos Xia
Remark:	Average measurement was not performed if peak level lower than average limit. Other frequency was 20dB below limit line within 1-18GHz, there is not show in the report.		

Frequency (MHz)	Level (dB μ V/m)	Factor (dB)	Limit (dB μ V/m)	Margin (dB)	Detector	Polarization
3645.0000	41.27	4.08	74.00	32.73	Peak	Horizontal
4800.0000	43.81	7.11	74.00	30.19	Peak	Horizontal
6375.0000	47.03	12.24	74.00	26.97	Peak	Horizontal
7085.0000	48.50	14.31	74.00	25.50	Peak	Horizontal
3685.0000	40.78	4.12	74.00	33.22	Peak	Vertical
4840.0000	43.17	7.09	74.00	30.83	Peak	Vertical
6360.0000	47.26	12.18	74.00	26.74	Peak	Vertical
7945.0000	50.53	15.59	74.00	23.47	Peak	Vertical

Test Mode:	BLE_1M	Test Date:	2023-07-22
Test Channel:	39	Test Engineer:	Amos Xia
Remark:	Average measurement was not performed if peak level lower than average limit. Other frequency was 20dB below limit line within 1-18GHz, there is not show in the report.		

Frequency (MHz)	Level (dB μ V/m)	Factor (dB)	Limit (dB μ V/m)	Margin (dB)	Detector	Polarization
3810.0000	41.44	4.50	74.00	32.56	Peak	Horizontal
4855.0000	42.83	7.11	74.00	31.17	Peak	Horizontal
6835.0000	47.89	13.74	74.00	26.11	Peak	Horizontal
7945.0000	50.74	15.59	74.00	23.26	Peak	Horizontal
3820.0000	41.59	4.55	74.00	32.41	Peak	Vertical
4795.0000	43.48	7.10	74.00	30.52	Peak	Vertical
6190.0000	47.81	11.32	74.00	26.19	Peak	Vertical
7930.0000	50.34	15.38	74.00	23.66	Peak	Vertical

The worst case of Radiated Emission below 1GHz:

30MHz – 1GHz Test Data

EUT:	Motorcycle Media Players	Polarity:	Horizontal
Model:	CFDLMMI001	SN:	N/A
Mode:	Transmit at BLE_1M Channel 00	Voltage:	DC 13.5V
Environment:	Temp: 22°C; Humi:52%	Engineer:	Amos Xia

Test Graph

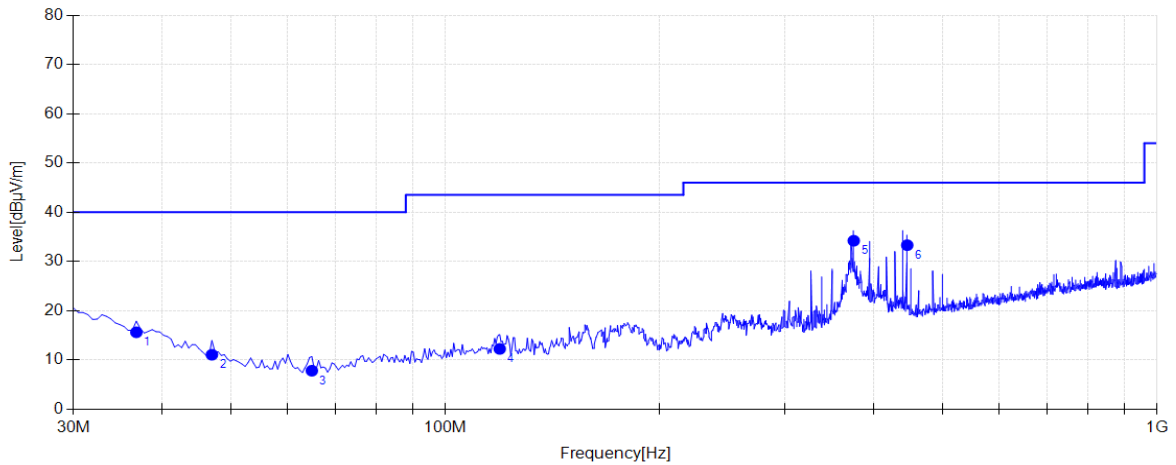

Final Data List								
NO.	Freq. [MHz]	Factor [dB]	QP Value [dBµV/m]	QP Limit [dBµV/m]	QP Margin [dB]	Height [cm]	Angle [°]	Polarity
1	36.7900	16.27	15.64	40.00	24.36	200	78	Horizontal
2	46.9750	11.07	11.07	40.00	28.93	200	105	Horizontal
3	64.9200	7.67	7.83	40.00	32.17	200	251	Horizontal
4	119.240	11.64	12.26	43.50	31.24	200	300	Horizontal
5	374.835	15.33	34.22	46.00	11.78	100	330	Horizontal
6	445.645	17.44	33.32	46.00	12.68	100	0	Horizontal

Note 1: The test trace is same as the ambient noise and the amplitude of the emissions are attenuated more than 20dB below the permissible (the test frequency range: 9kHz ~ 30MHz, 18GHz ~ 26.5GHz), therefore no data appear in the report.

EUT:	Motorcycle Media Players	Polarity:	Vertical
Model:	CFDLMMI001	SN:	N/A
Mode:	Transmit at BLE_1M Channel 00	Voltage:	DC 13.5V
Environment:	Temp: 22°C; Humi:52%	Engineer:	Amos Xia

Test Graph

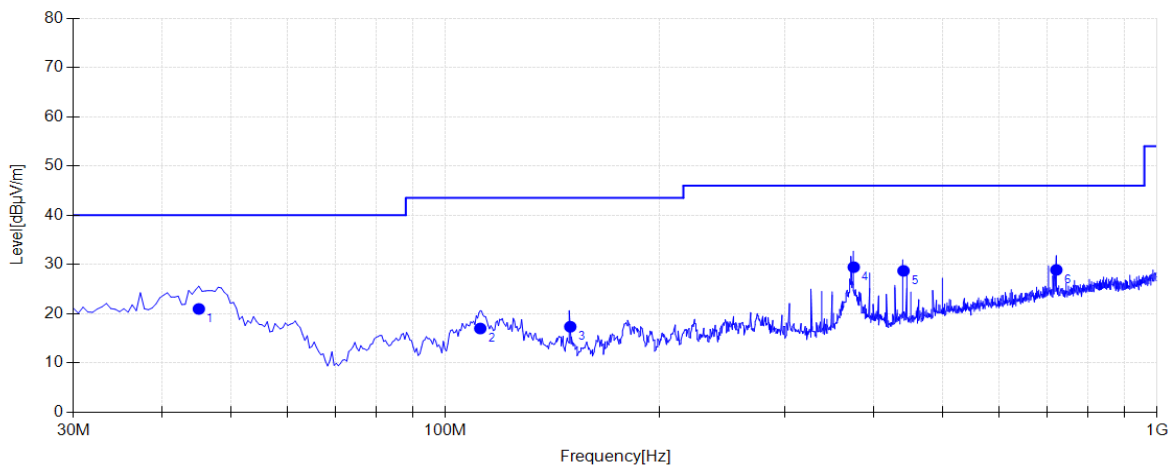

Final Data List								
NO.	Freq. [MHz]	Factor [dB]	QP Value [dBµV/m]	QP Limit [dBµV/m]	QP Margin [dB]	Height [cm]	Angle [°]	Polarity
1	45.0350	12.06	20.98	40.00	19.02	100	217	Vertical
2	111.965	11.49	17.01	43.50	26.49	100	320	Vertical
3	149.795	10.84	17.37	43.50	26.13	200	0	Vertical
4	374.835	15.33	29.46	46.00	16.54	200	213	Vertical
5	440.310	17.24	28.72	46.00	17.28	200	213	Vertical
6	722.095	22.16	28.90	46.00	17.10	200	47	Vertical

Note 1: The test trace is same as the ambient noise and the amplitude of the emissions are attenuated more than 20dB below the permissible (the test frequency range: 9kHz ~ 30MHz, 18GHz ~ 26.5GHz), therefore no data appear in the report.

7.7. Restricted Band Edge Measurement

7.7.1. Test Limit

For 15.205 requirement:

Radiated emissions which fall in the restricted bands, as defined in Section 15.205(a) of FCC part 15, must also comply with the radiated emission limits specified in Section 15.209(a).

Frequency (MHz)	Frequency (MHz)	Frequency (MHz)	Frequency (GHz)
0.090 - 0.110	16.42 - 16.423	399.9 - 410	4.5 - 5.15
¹ 0.495 - 0.505	16.69475 - 16.69525	608 - 614	5.35 - 5.46
2.1735 - 2.1905	16.80425 - 16.80475	960 - 1240	7.25 - 7.75
4.125 - 4.128	25.5 - 25.67	1300 - 1427	8.25 - 8.5
4.17725 - 4.17775	37.5 - 38.25	1435 - 1626.5	9.0 - 9.2
4.20725 - 4.20775	73 - 74.6	1645.5 - 1646.5	9.3 - 9.5
6.215 - 6.218	74.8 - 75.2	1660 - 1710	10.6 - 12.7
6.26775 - 6.26825	108 - 121.94	1718.8 - 1722.2	13.25 - 13.4
6.31175 - 6.31225	123 - 138	2200 - 2300	14.47 - 14.5
8.291 - 8.294	149.9 - 150.05	2310 - 2390	15.35 - 16.2
8.362 - 8.366	156.52475 - 156.525	2483.5 - 2500	17.7 - 21.4
8.37625 - 8.38675	156.7 - 156.9	2690 - 2900	22.01 - 23.12
8.41425 - 8.41475	162.0125 - 167.17	3260 - 3267	23.6 - 24.0
12.29 - 12.293	167.72 - 173.2	3332 - 3339	31.2 - 31.8
12.51975 - 12.52025	240 - 285	3345.8 - 3358	36.43 - 36.5
12.57675 - 12.57725	322 - 335.4	3600 - 4400	(²)
13.36 - 13.41	--	--	--

All out of band emissions appearing in a restricted band as specified in Section 15.205 of the Title 47CFR must not exceed the limits shown in Table per Section 15.209.

FCC Part 15 Subpart C Paragraph 15.209		
Frequency [MHz]	Field Strength [uV/m]	Measured Distance [Meters]
0.009 - 0.490	2400/F (kHz)	300
0.490 - 1.705	24000/F (kHz)	30
1.705 - 30	30	30
30 - 88	100	3
88 - 216	150	3
216 - 960	200	3
Above 960	500	3

For RSS-Gen Section 8.10 requirement:

Radiated emissions which fall in the restricted bands, as defined in Section 8.10 of RSS-Gen, must also comply with the radiated emission limits specified in Section 8.9.

Frequency (MHz)	Frequency (MHz)	Frequency (GHz)
0.009 - 0.110	240 - 285	9.0 - 9.2
2.1735 - 2.1905	322 - 335.4	9.3 - 9.5
3.020 - 3.026	399.9 - 410	10.6 - 12.7
4.125 - 4.128	608 - 614	13.25 - 13.4
4.17725 - 4.17775	960 - 1427	14.47 - 14.5
4.20725 - 4.20775	1435 - 1626.5	15.35 - 16.2
5.677 - 5.683	1645.5 - 1646.5	17.7 - 21.4
6.215 - 6.218	1660 - 1710	22.01 - 23.12
6.26775 - 6.26825	1718.8 - 1722.2	23.6 - 24.0
6.31175 - 6.31225	2200 - 2300	31.2 - 31.8
8.291 - 8.294	2310 - 2390	36.43 - 36.5
8.362 - 8.366	2655 - 2900	Above 38.6
8.37625 - 8.38675	3260 - 3267	--
8.41425 - 8.41475	3332 - 3339	
12.29 - 12.293	334.5 - 3358	
12.51975 - 12.52025	3500 - 4400	
12.57675 - 12.57725	4500 - 5150	
13.36 - 13.41	5350 - 5460	
16.42 - 16.423	7250 - 7750	
16.69475 - 16.69525	8025 - 8500	
16.80425 - 16.80475	--	
25.5 - 25.67		
37.5 - 38.25		
73 - 74.6		
74.8 - 75.2		
108 - 138		
156.52475 - 156.525225		
156.7 - 156.9		

All out of band emissions appearing in a restricted band as specified in Section 8.10 of the RSS-Gen must not exceed the limits shown in Table per Section 8.9.

RSS-Gen Section 8.9		
Frequency [MHz]	Field Strength [uV/m]	Measured Distance [Meters]
0.009 - 0.490	2400/F (kHz)	300
0.490 - 1.705	24000/F (kHz)	30
1.705 - 30	30	30
30 - 88	100	3
88 - 216	150	3
216 - 960	200	3
Above 960	500	3

7.7.2. Test Procedure Used

ANSI C63.10 Section 6.3 (General Requirements)

ANSI C63.10 Section 6.6 (Standard test method above 1GHz)

7.7.3. Test Setting

Peak Field Strength Measurements

1. Analyzer center frequency was set to the frequency of the radiated spurious emission of interest
2. RBW = 1MHz
3. VBW = 3MHz
4. Detector = peak
5. Sweep time = auto couple
6. Trace mode = max hold
7. Trace was allowed to stabilize

Average Field Strength Measurements

1. Analyzer center frequency was set to the frequency of the radiated spurious emission of interest
2. RBW = 1MHz
3. VBW = 3MHz
4. Detector = Power Average (RMS)
5. Number of sweep point = 2001 (Number of sweep points must be $\geq 2 \times \text{span} / \text{RBW}$)
6. Sweep time = auto
7. Trace (RMS) averaging was performed over at least 100 traces.

7.7.4. Test Setup

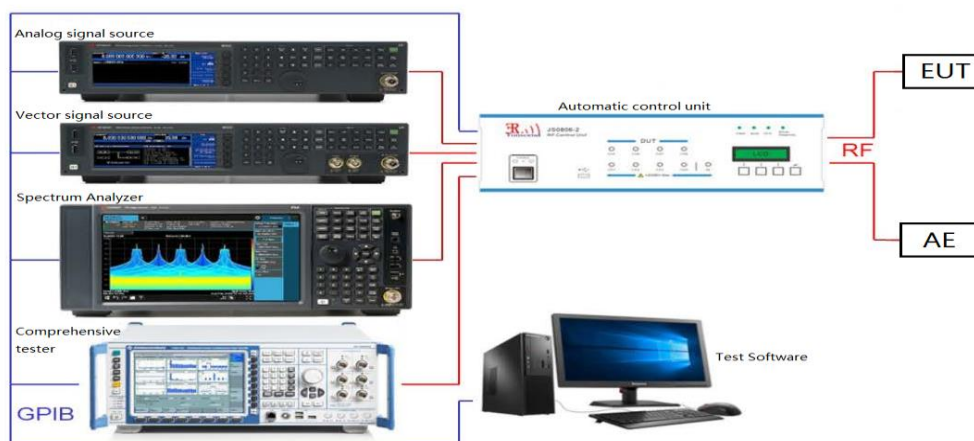

7.7.5. Test Result

Test Mode	Antenna	Channel	Detector	Freq [MHz]	Result [dBm]	Limit [dBm]	Result [dBuV/m]	Limit [dBuV/m]	Verdict
BLE_1M	Ant1	2402	AV	2310.000	-48.15	≤-41.20	47.05	≤54	PASS
			AV	2388.935	-47.32	≤-41.20	47.88	≤54	PASS
			AV	2390.000	-47.74	≤-41.20	47.46	≤54	PASS
			Peak	2310.000	-38.55	≤-21.20	56.65	≤74	PASS
			Peak	2388.095	-36.05	≤-21.20	59.15	≤74	PASS
			Peak	2390.000	-38.26	≤-21.20	56.94	≤74	PASS
		2480	AV	2483.500	-46.95	≤-41.20	48.25	≤54	PASS
			AV	2483.520	-46.95	≤-41.20	48.25	≤54	PASS
			AV	2500.000	-47.75	≤-41.20	47.45	≤54	PASS
			Peak	2483.500	-35.08	≤-21.20	60.12	≤74	PASS
			Peak	2483.760	-33.86	≤-21.20	61.34	≤74	PASS
			Peak	2500.000	-36.84	≤-21.20	58.36	≤74	PASS

Note:

1. The Antenna Gain is compensated in the graph.
2. The limit in dBm for average detector is conversion from 54dBuV/m, according to 15.209(a).
The limit in dBm for peak detector is 20dB above the limit of average detector in dBm.

Test Graphs

BLE_1M_Ant1_Low_2402_AV

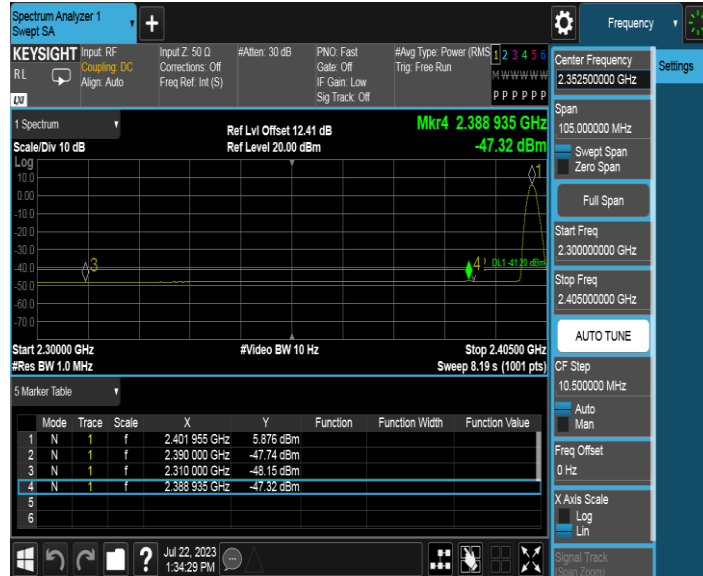

BLE_1M_Ant1_Low_2402_Peak

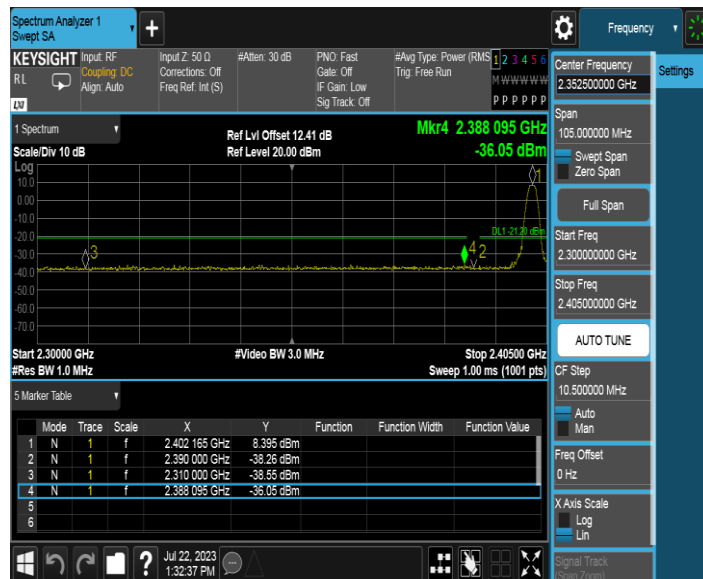

BLE_1M_Ant1_High_2480_AV

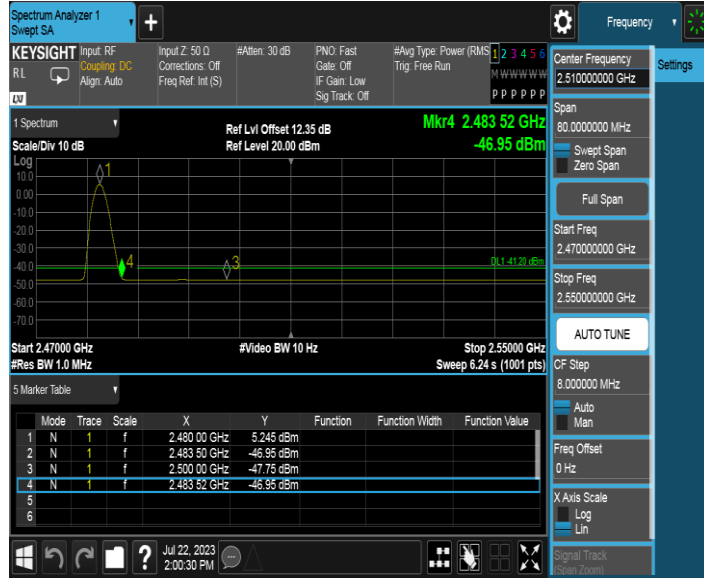

BLE_1M_Ant1_High_2480_Peak

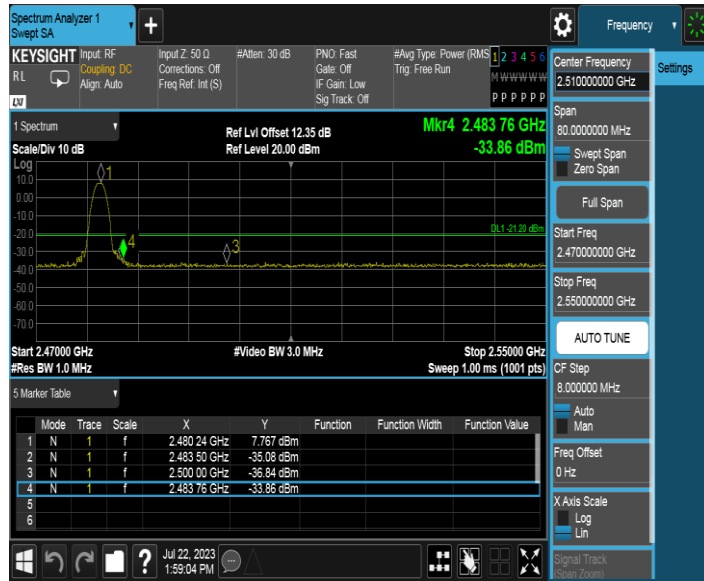

7.8. AC Conducted Emissions Measurement

7.8.1. Test Limit

FCC Part 15 Subpart C Paragraph 15.207 Limits		
Frequency (MHz)	QP (dBuV)	AV (dBuV)
0.15 - 0.50	66 - 56	56 - 46
0.50 - 5.0	56	46
5.0 - 30	60	50

Note 1: The lower limit shall apply at the transition frequencies.

Note 2: The limit decreases linearly with the logarithm of the frequency in the range 0.15MHz to 0.5MHz.

7.8.2. Test Setup

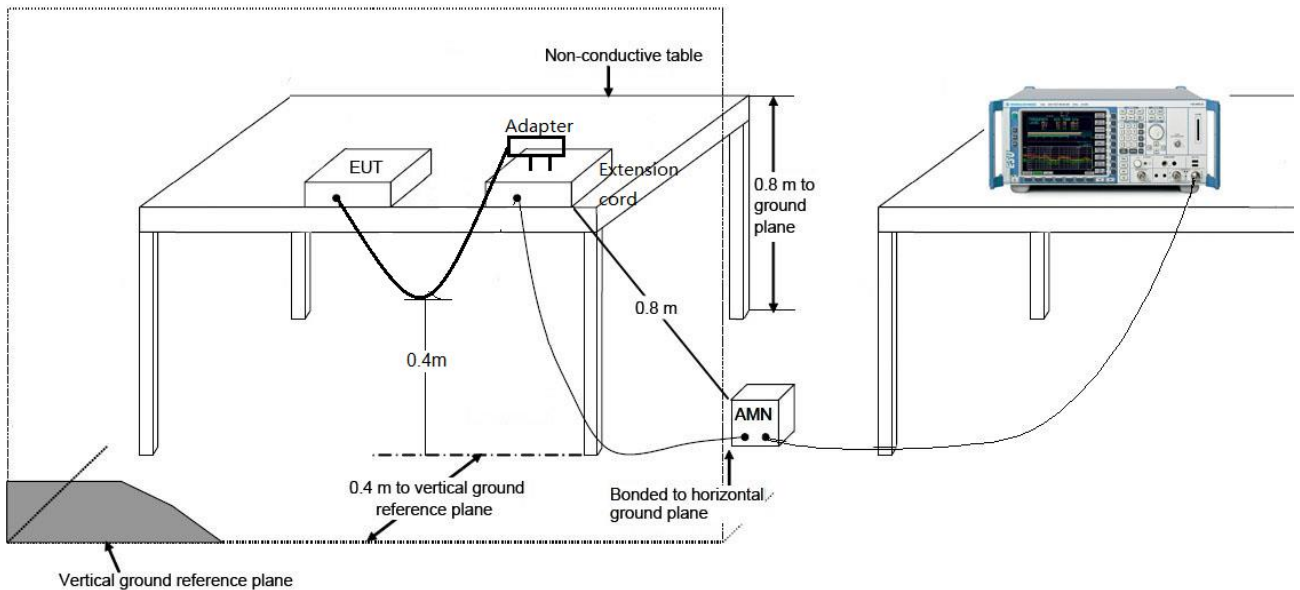

7.8.3. Test Result

Not applicable.

8. CONCLUSION

The data collected relate only the item(s) tested and show that the **Motorcycle Media Players** is in compliance with Part 15C of the FCC Rules.

_____ The End _____