

TEST REPORT

Product Name : SMART PHONE
Brand Name : SIRAGON
Model : SP-7260
Series Model : N/A
FCC ID : 2BACG-SP-7260
Applicant : **Siragon Corporate**
Address : CR MANZANA A LOCAL SHED NRO 1-4 VALLE ALTO
GUAYABAL, NAGUANAGUA CARABOBO ZIP 2005. IVORY
STORE
Manufacturer : **Shenzhen KEP Technology CO., LTD**
Address : #101, #201 and #301, building B, 1st/ 2nd/3rd floor, Building A,
FenghuangGang First Industrial Area, FenghuangGang
Community, Xixiang Street, Bao an District, Shenzhen
Standard(s) : FCC CFR Title 47 Part 15 Subpart C Section 15.247
Date of Receipt : Mar. 13, 2025
Date of Test : Mar. 14, 2025~ Mar. 31, 2025
Issued Date : Apr. 03, 2025

Issued By: **Guangdong Asia Hongke Test Technology Limited**
B1/F, Building 11, Junfeng Industrial Park, Chongqing Road, Heping Community, Fuhai Street,
Bao'an District, Shenzhen, Guangdong, China
Tel.: +86 0755-230967639 Fax.: +86 0755-230967639

Reviewed by: Leon Yi
Leon.yi

Approved by: Sean She
Sean She



Note: This device has been tested and found to comply with the standard(s) listed, this test report merely corresponds to the test sample. It is not permitted to copy extracts of these test result without the written permission of the test laboratory. This report shall not be reproduced except in full, without the written approval of Guangdong Asia Hongke Test Technology Limited. If there is a need to alter or revise this document, the right belongs to Guangdong Asia Hongke Test Technology Limited, and it should give a prior written notice of the revision document. This test report must not be used by the client to claim product endorsement.



Report Revise Record

Report Version	Issued Date	Notes
M1	Apr. 03, 2025	Initial Release

Contents

1	TEST SUMMARY	4
1.1	TEST STANDARDS	4
1.2	TEST SUMMARY	4
1.3	TEST FACILITY	5
1.4	MEASUREMENT UNCERTAINTY	5
2	GENERAL INFORMATION	6
2.1	ENVIRONMENTAL CONDITIONS	6
2.2	GENERAL DESCRIPTION OF EUT	6
2.3	DESCRIPTION OF TEST MODES AND TEST FREQUENCY.....	7
2.4	SPECIAL ACCESSORIES	8
2.5	EQUIPMENT LIST FOR THE TEST	8
3	TEST CONDITIONS AND RESULTS	10
3.1	CONDUCTED EMISSIONS TEST	10
3.2	RADIATED EMISSIONS AND BAND EDGE	13
3.3	MAXIMUM PEAK OUTPUT POWER.....	20
3.4	20dB BANDWIDTH.....	21
3.5	OCCUPIED BANDWIDTH.....	22
3.6	FREQUENCY SEPARATION	23
3.7	NUMBER OF HOPPING FREQUENCY.....	24
3.8	TIME OF OCCUPANCY (DWELL TIME).....	25
3.9	OUT-OF-BAND EMISSIONS	26
3.10	PSEUDORANDOM FREQUENCY HOPPING SEQUENCE.....	27
3.11	ANTENNA REQUIREMENT.....	28
4	TEST SETUP PHOTOGRAPHS OF EUT	29
5	PHOTOS OF EUT	30

1 TEST SUMMARY

1.1 Test Standards

The tests were performed according to following standards:

[FCC Rules Part 15.247](#): Frequency Hopping, Direct Spread Spectrum and Hybrid Systems that are in operation within the bands of 902-928 MHz, 2400-2483.5 MHz, and 5725-5850 MHz

[ANSI C63.10: 2013](#): American National Standard for Testing Unlicensed Wireless Devices

[KDB558074 D01 15.247 Meas Guidance v05r02](#): Guidance for Compliance Measurements on Digital Transmission System, Frequency Hopping Spread Spectrum System, and Hybrid System Devices Operating Under Section 15.247 of the FCC Rules

1.2 Test Summary

Test Item	Section in 47 CFR	Result
Maximum Conducted Output Power	§15.247(b)	Pass
20dB Bandwidth	§15.247(a)	Pass
Frequency Separation	§15.247(a)	Pass
Number Of Hopping Frequency	§15.247(a)	Pass
Time Of Occupancy (Dwell Time)	§15.247(a)	Pass
Conducted Spurious Emissions and Band Edges Emissions	§15.205, §15.247(d)	Pass
Radiated Spurious Emissions	§15.209, §15.247(d)	Pass
Emissions at Restricted Band	§15.205	Pass
AC Mains Conducted Emissions	§15.207(a)	Pass
Antenna Requirements	§15.203	Pass

1.3 Test Facility

Test Laboratory:

Guangdong Asia Hongke Test Technology Limited

B1/F, Building 11, Junfeng Industrial Park, Chongqing Road, Heping Community, Fuhai Street, Bao'an District, Shenzhen, Guangdong, China

The test facility is recognized, certified or accredited by the following organizations:

FCC-Registration No.: 251906 Designation Number: CN1376

Guangdong Asia Hongke Test Technology Limited has been registered and fully described in a report filed with the (FCC) Federal Communications Commission. The acceptance letter from the FCC is maintained in our files.

IC —Registration No.: 31737 CAB identifier: CN0165

The 3m Semi-anechoic chamber of Guangdong Asia Hongke Test Technology Limited has been registered by Certification and Engineering Bureau of Industry Canada for radio equipment testing with Registration No.: 31737

A2LA-Lab Cert. No.: 7133.01

Guangdong Asia Hongke Test Technology Limited has been accredited by A2LA for technical competence in the field of electrical testing, and proved to be in compliance with ISO/IEC 17025: 2017 General Requirements for the Competence of Testing and Calibration Laboratories and any additional program requirements in the identified field of testing.

1.4 Measurement uncertainty

The data and results referenced in this document are true and accurate. The reader is cautioned that there may be errors within the calibration limits of the equipment and facilities. The measurement uncertainty was calculated for all measurements listed in this test report according to CISPR 16 - 4 “Specification for radio disturbance and immunity measuring apparatus and methods – Part 4: Uncertainty in EMC Measurements” and is documented in the Guangdong Asia Hongke Test Technology Limited’s quality system according to DIN EN ISO/IEC 17025. Furthermore, component and process variability of devices similar to that tested may result in additional deviation. The manufacturer has the sole responsibility of continued compliance of the device.

Hereafter the best measurement capability for Asia Hongke laboratory is reported:

Test	Measurement Uncertainty	Notes
Power Line Conducted Emission	9KHz~30MHz ± 1.20 dB	(1)
Radiated Emission	9KHz~30MHz ± 3.10 dB	(1)
Radiated Emission	30MHz~1GHz ± 3.75 dB	(1)
Radiated Emission	1GHz~18GHz ± 3.88 dB	(1)
Radiated Emission	18GHz~40GHz ± 3.88 dB	(1)
RF power, conducted	30MHz~6GHz ± 0.16 dB	(1)
RF power density, conducted	± 0.24 dB	(1)
Spurious emissions, conducted	± 0.21 dB	(1)
Temperature	$\pm 1^{\circ}$ C	(1)
Humidity	$\pm 3\%$	(1)
DC and low frequency voltages	$\pm 1.5\%$	(1)
Time	$\pm 2\%$	(1)
Duty cycle	$\pm 2\%$	(1)

The report uncertainty of measurement $y \pm U$, where expanded uncertainty U is based on a standard uncertainty Multiplied by a coverage factor of $k=2$, providing a level of confidence of approximately 95%.

2 GENERAL INFORMATION

2.1 Environmental conditions

During the measurement the environmental conditions were within the listed ranges:

Normal Temperature:	25°C
Relative Humidity:	55 %
Air Pressure:	101 kPa

2.2 General Description of EUT

Product Name:	SMART PHONE
Model/Type reference:	SP-7260
Serial Model:	N/A
Power Supply:	Input: DC 5V/2A DC 3.87V 4900mAh 18.97Wh Rechargeable Li-ion battery
Adapter information:	Model: ES568E-U050200XYF Input: 100-240V~ 50/60Hz 0.5A Output: 5.0V=2000mA
Hardware Version:	N/A
Software Version:	N/A
Sample(s) Status:	AiTSZ-250313013-1(Normal sample) AiTSZ-250313013-2(Engineer sample)
Bluetooth :	
Supported type:	Bluetooth BR/EDR
Modulation:	GFSK, $\pi/4$ DQPSK, 8DPSK
Operation frequency:	2402MHz~2480MHz
Channel number:	79
Channel separation:	1MHz
Antenna type:	FPC antenna
Antenna gain:	2.17 dBi
Remark: The above DUT's information was declared by manufacturer. For more detailed features description, please refer to the manufacturer's specifications or the User's Manual..	

2.3 Description of Test Modes and Test Frequency

There are 79 channels provided to the EUT and Channel 00/39/78 were selected to test.

Operation Frequency List:

Channel	Frequency (MHz)
00	2402
01	2403
⋮	⋮
38	2440
39	2441
40	2442
⋮	⋮
77	2479
78	2480

Note: The line display in grey were the channel selected for testing

Exploratory testing was performed under each mode combination test channel; only the final measurement of the worst combination was made and recorded in this report.

Test case	Exploratory measurement			Final measurement Recorded In Report		
	Mode	Date rate	Channel	Mode	Date rate	Channel
Frequency Separation	GFSK Π/4DQPSK 8DPSK	DH1/DH3/DH5 2DH1/2DH3/2DH5 3DH1/3DH3/3DH5	<input checked="" type="checkbox"/> Lowest <input checked="" type="checkbox"/> Middle <input checked="" type="checkbox"/> Highest	GFSK Π/4DQPSK 8DPSK	DH5 2DH5 3DH5	<input checked="" type="checkbox"/> Middle
Number Of Hopping Frequency	GFSK Π/4DQPSK 8DPSK	DH1/DH3/DH5 2DH1/2DH3/2DH5 3DH1/3DH3/3DH5	<input checked="" type="checkbox"/> Full	GFSK Π/4DQPSK 8DPSK	DH5 2DH5 3DH5	<input checked="" type="checkbox"/> Full
Time of Occupancy (dwell time)	GFSK Π/4DQPSK 8DPSK	DH1/DH3/DH5 2DH1/2DH3/2DH5 3DH1/3DH3/3DH5	<input checked="" type="checkbox"/> Lowest <input checked="" type="checkbox"/> Middle <input checked="" type="checkbox"/> Highest	GFSK Π/4DQPSK 8DPSK	DH1/DH3/DH5 2DH1/2DH3/2DH5 3DH1/3DH3/3DH5	<input checked="" type="checkbox"/> Middle
20dB bandwidth	GFSK Π/4DQPSK 8DPSK	DH1/DH3/DH5 2DH1/2DH3/2DH5 3DH1/3DH3/3DH5	<input checked="" type="checkbox"/> Lowest <input checked="" type="checkbox"/> Middle <input checked="" type="checkbox"/> Highest	GFSK Π/4DQPSK 8DPSK	DH5 2DH5 3DH5	<input checked="" type="checkbox"/> Lowest <input checked="" type="checkbox"/> Middle <input checked="" type="checkbox"/> Highest
Maximum Conducted Output Power	GFSK Π/4DQPSK 8DPSK	DH1/DH3/DH5 2DH1/2DH3/2DH5 3DH1/3DH3/3DH5	<input checked="" type="checkbox"/> Lowest <input checked="" type="checkbox"/> Middle <input checked="" type="checkbox"/> Highest	GFSK Π/4DQPSK 8DPSK	DH5 2DH5 3DH5	<input checked="" type="checkbox"/> Lowest <input checked="" type="checkbox"/> Middle <input checked="" type="checkbox"/> Highest
Conducted Band edge	GFSK Π/4DQPSK 8DPSK	DH1/DH3/DH5 2DH1/2DH3/2DH5 3DH1/3DH3/3DH5	<input checked="" type="checkbox"/> Lowest <input checked="" type="checkbox"/> Highest	GFSK Π/4DQPSK 8DPSK	DH5 2DH5 3DH5	<input checked="" type="checkbox"/> Lowest <input checked="" type="checkbox"/> Highest
Radiated Band edge	GFSK Π/4DQPSK 8DPSK	DH1/DH3/DH5 2DH1/2DH3/2DH5 3DH1/3DH3/3DH5	<input checked="" type="checkbox"/> Lowest <input checked="" type="checkbox"/> Highest	GFSK	DH5	<input checked="" type="checkbox"/> Lowest <input checked="" type="checkbox"/> Highest
Conducted Spurious Emissions	GFSK Π/4DQPSK 8DPSK	DH1/DH3/DH5 2DH1/2DH3/2DH5 3DH1/3DH3/3DH5	<input checked="" type="checkbox"/> Lowest <input checked="" type="checkbox"/> Middle <input checked="" type="checkbox"/> Highest	GFSK Π/4DQPSK 8DPSK	DH5 2DH5 3DH5	<input checked="" type="checkbox"/> Lowest <input checked="" type="checkbox"/> Middle <input checked="" type="checkbox"/> Highest
Radiated Spurious Emissions Above 1GHz	GFSK Π/4DQPSK 8DPSK	DH1/DH3/DH5 2DH1/2DH3/2DH5 3DH1/3DH3/3DH5	<input checked="" type="checkbox"/> Lowest <input checked="" type="checkbox"/> Middle <input checked="" type="checkbox"/> Highest	GFSK	DH5	<input checked="" type="checkbox"/> Lowest <input checked="" type="checkbox"/> Middle <input checked="" type="checkbox"/> Highest
Radiated Spurious Emissions Below 1GHz	GFSK Π/4DQPSK 8DPSK	DH1/DH3/DH5 2DH1/2DH3/2DH5 3DH1/3DH3/3DH5	<input checked="" type="checkbox"/> Lowest <input checked="" type="checkbox"/> Middle <input checked="" type="checkbox"/> Highest	GFSK	DH5	<input checked="" type="checkbox"/> Middle
Conducted Emissions 9KHz-30 MHz	GFSK Π/4DQPSK 8DPSK	DH1/DH3/DH5 2DH1/2DH3/2DH5 3DH1/3DH3/3DH5	<input checked="" type="checkbox"/> Lowest <input checked="" type="checkbox"/> Middle <input checked="" type="checkbox"/> Highest	GFSK	DH5	<input checked="" type="checkbox"/> Middle

Power setting during the test:

During testing, Channel & Power Controlling Software provided by the customer was used to control the operating channel as well as the output power level. The RF output power selection is for the setting of RF output power expected by the customer and is going to be fixed on the firmware of the final end product.

Power Parameters:

Test Software Version	Engineering Mode		
Frequency	2402MHz	2441MHz	2480MHz
BR/EDR	Default	Default	Default

2.4 Special Accessories

Follow auxiliary equipment(s) test with EUT that provided by the manufacturer or laboratory is listed as follow:

Description	Manufacturer	Model	Serial No.	Provided by	Other
/	/	/	/	/	/
/	/	/	/	/	/

2.5 Equipment List for the Test

No	Test Equipment	Manufacturer	Model No	Serial No	Cal. Date	Cal. Due Date
1	EMI Measuring Receiver	R&S	ESR	101160	2024.09.25	2025.09.24
2	Spectrum Analyzer	R&S	FSV40	101470	2024.09.23	2025.09.22
3	Low Noise Pre Amplifier	SCHWARZBECK	BBV 9745	00282	2024.09.25	2025.09.24
4	Low Noise Pre Amplifier	CESHENG	CSKJLNA231016A	CSKJLNA231016A	2024.09.25	2025.09.24
5	Passive Loop	ETS	6512	00165355	2024.08.29	2027.08.28
6	TRILOG Super Broadband test Antenna	SCHWARZBECK	VULB9168	01434	2024.08.29	2027.08.28
7	Broadband Horn Antenna	Schwarzbeck	BBHA 9120D	452	2024.08.29	2027.08.28
8	Horn Antenna 15-40GHZ	SCHWARZBECK	BBHA9170	BBHA9170367	2024.08.28	2027.08.27
9	6dB Attenuator	JFW	50FPE-006	4360846-949-1	2024.09.24	2025.09.23
10	EMI Test Receiver	R&S	ESPI	100771	2024.09.25	2025.09.24
11	LISN	R&S	NNLK 8129	8130179	2024.09.24	2025.09.23
12	LISN	R&S	ESH3-Z5	892785/016	2024.09.23	2025.09.22
13	Pulse Limiter	R&S	ESH3-Z2	102789	2024.09.24	2025.09.23
14	RF Automatic Test system	TST	TSTPASS	21033016	2024.09.25	2025.09.24
15	Vector Signal Generator	Agilent	N5182A	MY50143009	2024.09.25	2025.09.24
16	Analog signal generator	Agilent	E8257	MY51554256	2024.09.25	2025.09.24
17	Spectrum Analyzer	Agilent	N9020A	MY51289843	2024.09.25	2025.09.24
18	Spectrum Analyzer	Agilent	N9020A	MY53421570	2024.09.25	2025.09.24

19	Power Sensor	Agilent	8481A	MY41097697	2024.09.25	2025.09.24
20	Wideband Radio communication tester	R&S	CMW500	1201.0002K50	2024.09.24	2025.09.23
21	DC power supply	ZHAOXIN	RXN-305D-2	28070002559	2024.09.24	2025.09.23
22	RE Software	EZ	EZ-EMC_RE	Ver.AIT-03A	N/A	N/A
23	CE Software	EZ	EZ-EMC_CE	Ver.AIT-03A	N/A	N/A
24	RF Software	TST	TSTPASS	Version 2.0	N/A	N/A
25	RF Software	cesheng	WCS-WCN	Version 2024.6.20	N/A	N/A
26	temporary antenna connector(Note)	NTS	R001	N/A	N/A	N/A
<p>Note: The temporary antenna connector is soldered on the PCB board in order to perform conducted tests and this temporary antenna connector is listed in the equipment list.</p>						

3 TEST CONDITIONS AND RESULTS

3.1 Conducted Emissions Test

LIMIT

Frequency range (MHz)	Limit (dBuV)	
	Quasi-peak	Average
0.15-0.5	66 to 56*	56 to 46*
0.5-5	56	46
5-30	60	50

* Decreases with the logarithm of the frequency.

TEST CONFIGURATION

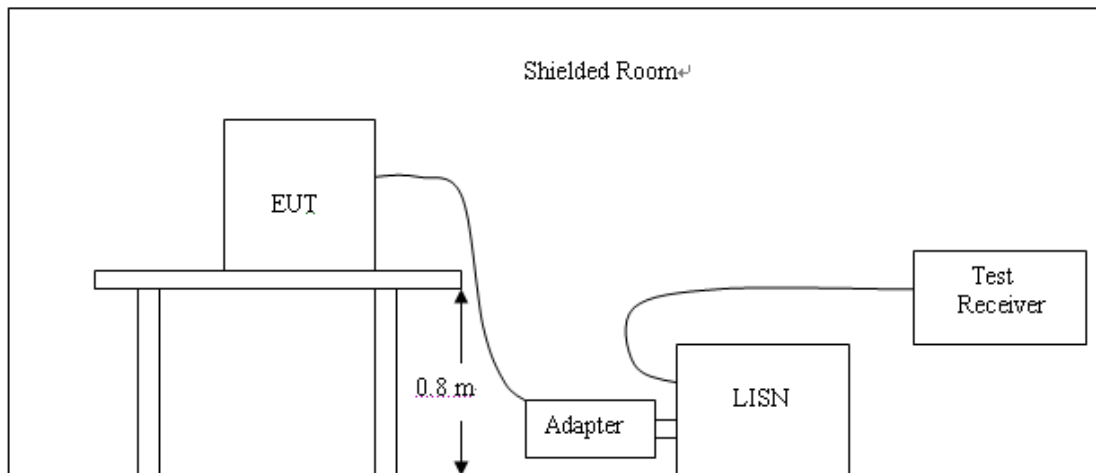

TEST PROCEDURE

1. The equipment was set up as per the test configuration to simulate typical actual usage per the user’s manual. The EUT is a tabletop system; a wooden table with a height of 0.8 meters is used and is placed on the ground plane as per ANSI C63.10:2013.
2. Support equipment, if needed, was placed as per ANSI C63.10:2013.
3. All I/O cables were positioned to simulate typical actual usage as per ANSI C63.10:2013.
4. The adapter received AC120V/60Hz power through a Line Impedance Stabilization Network (LISN) which supplied power source and was grounded to the ground plane.
5. All support equipments received AC power from a second LISN, if any.
6. The EUT test program was started. Emissions were measured on each current carrying line of the EUT using a spectrum Analyzer / Receiver connected to the LISN powering the EUT. The LISN has two monitoring points: Line 1 (Hot Side) and Line 2 (Neutral Side). Two scans were taken: one with Line 1 connected to Analyzer / Receiver and Line 2 connected to a 50 ohm load; the second scan had Line 1 connected to a 50 ohm load and Line 2 connected to the Analyzer / Receiver.
7. Analyzer / Receiver scanned from 150 KHz to 30MHz for emissions in each of the test modes.
8. During the above scans, the emissions were maximized by cable manipulation.

TEST RESULTS

Remark: Both 120 VAC, 50/60 Hz and 240 VAC, 50/60 Hz power supply have been tested, only the worst result of 120 VAC, 60 Hz was reported as below:

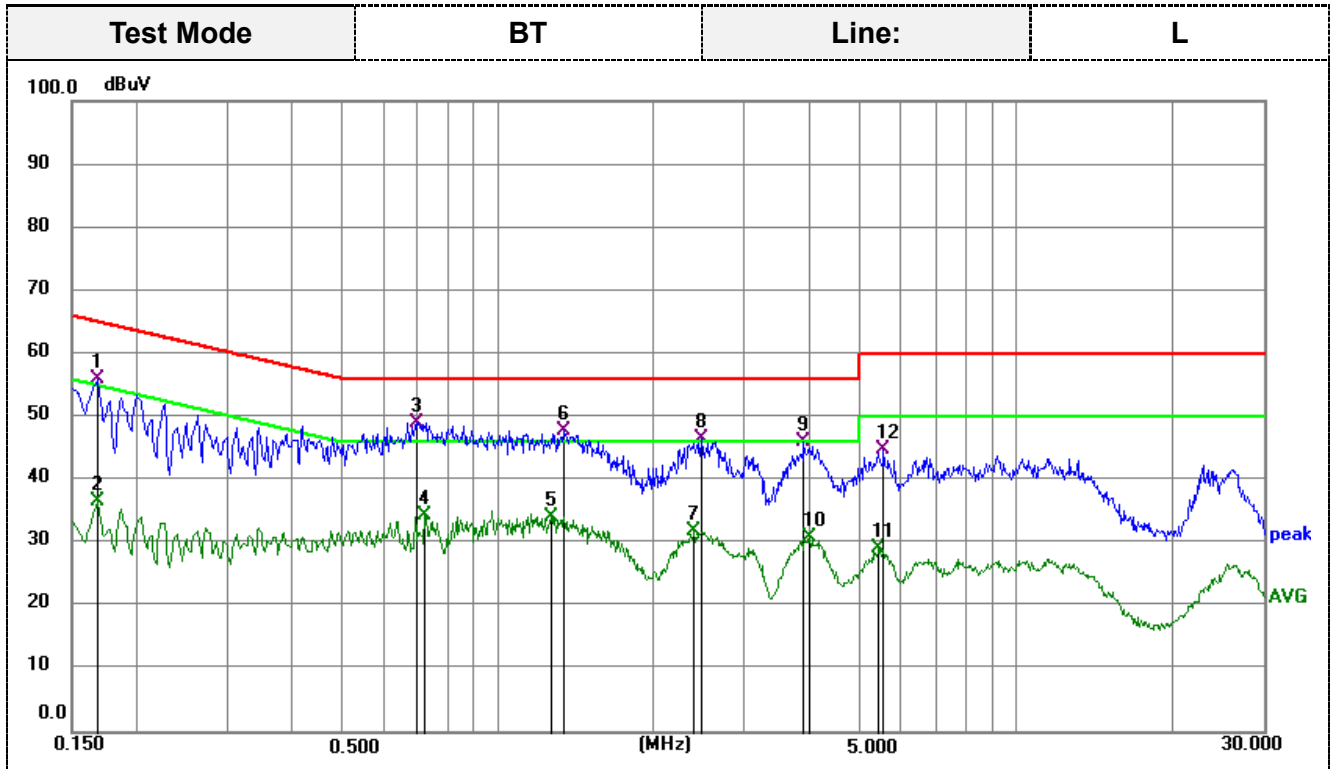

Remark: Correct Factor = Insertion loss of LISN + Cable loss + Insertion loss of Pulse Limiter;
 Measurement Result = Reading Level +Correct Factor;
 Margin = Measurement Result- Limit

No.	Frequency (MHz)	Reading (dBuV)	Correct (dB)	Result (dBuV)	Limit (dBuV)	Margin (dB)	Remark
1	0.1680	45.24	10.67	55.91	65.06	-9.15	QP
2	0.1680	25.94	10.67	36.61	55.06	-18.45	AVG
3	0.6945	38.43	10.68	49.11	56.00	-6.89	QP
4	0.7215	23.78	10.67	34.45	46.00	-11.55	AVG
5	1.2660	23.47	10.68	34.15	46.00	-11.85	AVG
6	1.3380	37.18	10.69	47.87	56.00	-8.13	QP
7	2.3955	20.98	10.79	31.77	46.00	-14.23	AVG
8	2.4630	35.76	10.79	46.55	56.00	-9.45	QP
9	3.8850	35.01	11.01	46.02	56.00	-9.98	QP
10	3.9885	19.95	11.00	30.95	46.00	-15.05	AVG
11	5.4375	18.15	11.03	29.18	50.00	-20.82	AVG
12	5.5635	33.74	11.03	44.77	60.00	-15.23	QP

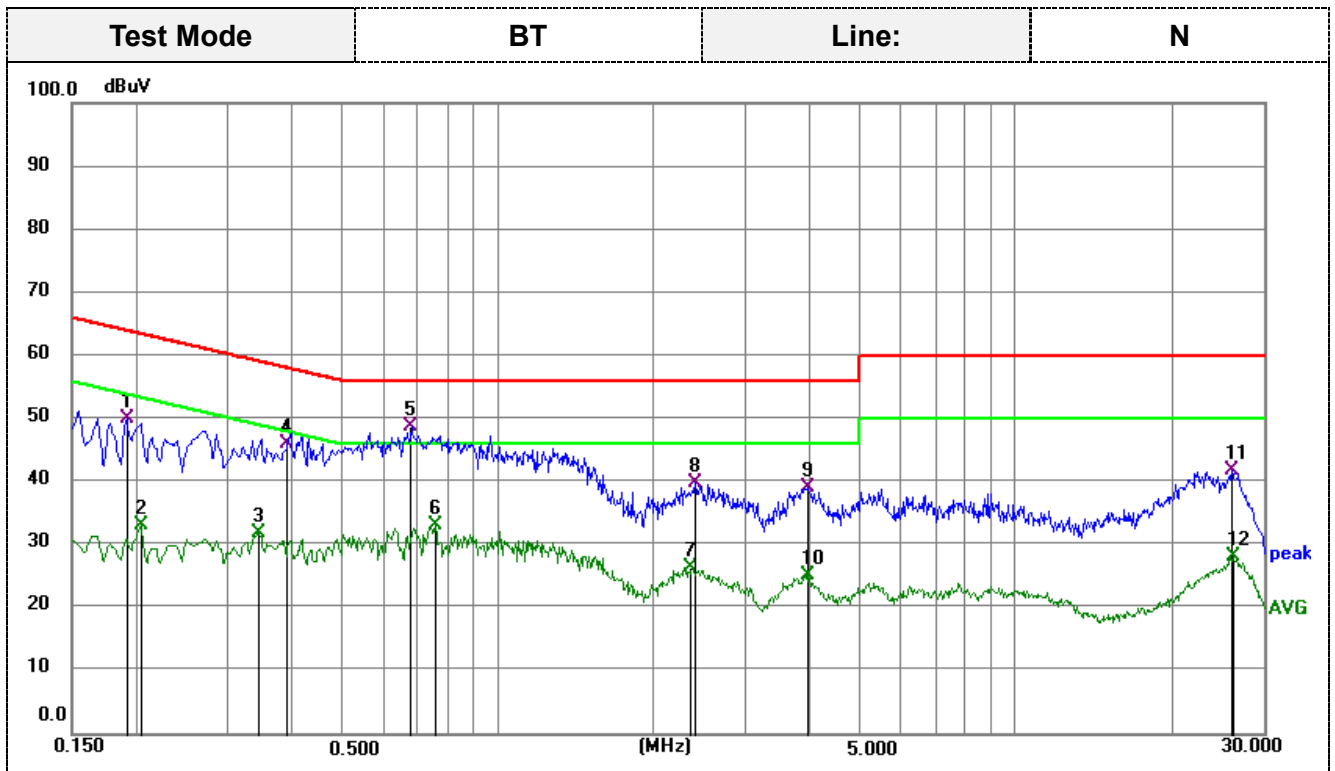

Remark: Correct Factor = Insertion loss of LISN + Cable loss + Insertion loss of Pulse Limiter;
 Measurement Result = Reading Level + Correct Factor;
 Margin = Measurement Result - Limit

No.	Frequency (MHz)	Reading (dBuV)	Correct (dB)	Result (dBuV)	Limit (dBuV)	Margin (dB)	Remark
1	0.1905	39.21	10.69	49.90	64.01	-14.11	QP
2	0.2040	22.39	10.69	33.08	53.45	-20.37	AVG
3	0.3435	21.15	10.69	31.84	49.12	-17.28	AVG
4	0.3914	35.29	10.69	45.98	58.03	-12.05	QP
5	0.6809	38.02	10.67	48.69	56.00	-7.31	QP
6	0.7575	22.35	10.66	33.01	46.00	-12.99	AVG
7	2.3594	15.76	10.78	26.54	46.00	-19.46	AVG
8	2.4045	29.06	10.78	39.84	56.00	-16.16	QP
9	3.9480	28.11	10.99	39.10	56.00	-16.90	QP
10	3.9660	14.11	10.99	25.10	46.00	-20.90	AVG
11	26.0970	30.06	11.70	41.76	60.00	-18.24	QP
12	26.1825	16.53	11.69	28.22	50.00	-21.78	AVG

3.2 Radiated Emissions and Band Edge

Limit

For intentional device, according to § 15.209(a), the general requirement of field strength of radiated emission out of authorized band shall not exceed the following table at a 3 meters measurement distance.

In addition, radiated emissions which fall in the restricted bands, as defined in §15.205(a), must also comply with the radiated emission limits specified in §15.209(a)

Radiated emission limits

Frequency (MHz)	Distance (Meters)	Radiated (dBµV/m)	Radiated (µV/m)
0.009-0.49	3	$20\log(2400/F(\text{KHz}))+40\log(300/3)$	$2400/F(\text{KHz})$
0.49-1.705	3	$20\log(24000/F(\text{KHz}))+40\log(30/3)$	$24000/F(\text{KHz})$
1.705-30	3	$20\log(30)+40\log(30/3)$	30
30-88	3	40.0	100
88-216	3	43.5	150
216-960	3	46.0	200
Above 960	3	54.0	500

TEST CONFIGURATION

(A) Radiated Emission Test Set-Up, Frequency Below 30MHz

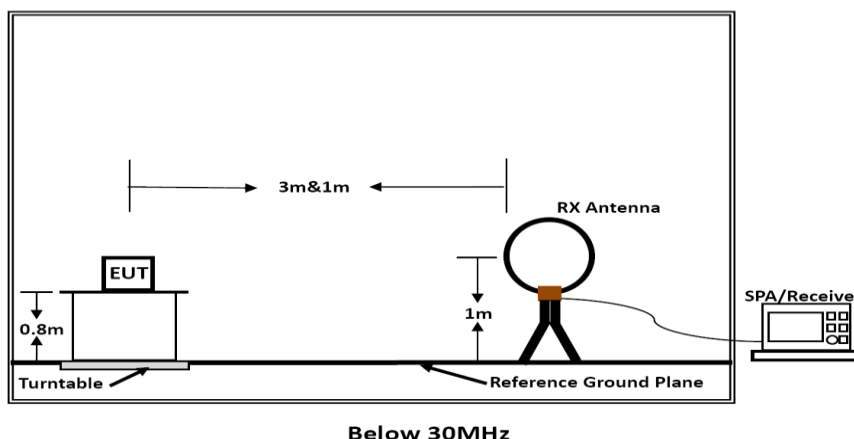

(B) Radiated Emission Test Set-Up, Frequency below 1000MHz

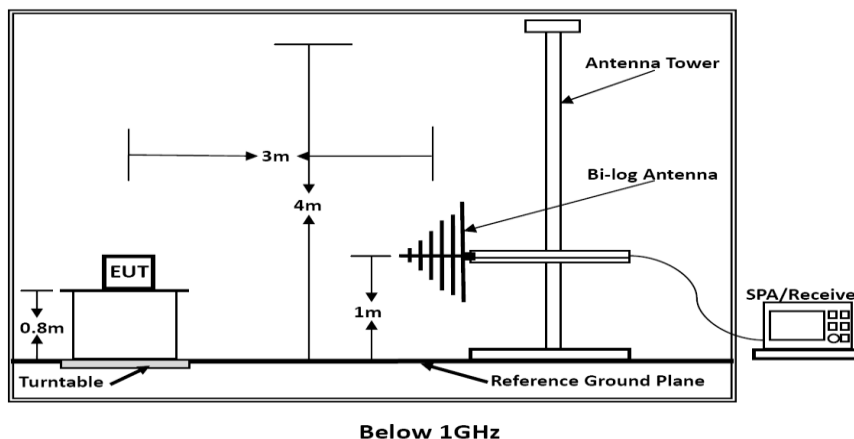

(C) Radiated Emission Test Set-Up, Frequency above 1000MHz

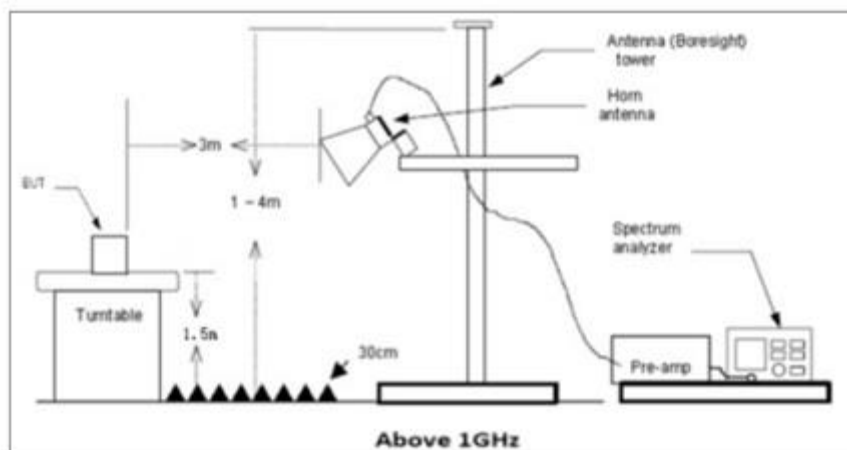
Test Procedure

- Below 1GHz measurement the EUT is placed on a turntable which is 0.8m above ground plane, and above 1GHz measurement EUT was placed on a low permittivity and low loss tangent turn table which is 1.5m above ground plane.
- Maximum procedure was performed by raising the receiving antenna from 1m to 4m and rotating the turn table from 0° to 360° to acquire the highest emissions from EUT
- And also, each emission was to be maximized by changing the polarization of receiving antenna both horizontal and vertical.
- Repeat above procedures until all frequency measurements have been completed.
- Radiated emission test frequency band from 9KHz to 25GHz.
- The distance between test antenna and EUT as following table states:

Test Frequency range	Test Antenna Type	Test Distance
9KHz-30MHz	Active Loop Antenna	3
30MHz-1GHz	Bilog Antenna	3
1GHz-18GHz	Horn Antenna	3
18GHz-25GHz	Horn Antenna	1

- Setting test receiver/spectrum as following table states:

Test Frequency range	Test Receiver/Spectrum Setting	Detector
9KHz-150KHz	RBW=200Hz/VBW=3KHz, Sweep time=Auto	QP
150KHz-30MHz	RBW=9KHz/VBW=100KHz, Sweep time=Auto	QP
30MHz-1GHz	RBW=120KHz/VBW=1000KHz, Sweep time=Auto	QP
1GHz-40GHz	Peak Value: RBW=1MHz/VBW=3MHz, Sweep time=Auto Average Value: RBW=1MHz/VBW=10Hz, Sweep time=Auto	Peak

TEST RESULTS

Remark:

- All GFSK, $\pi/4$ DQPSK and 8DPSK mode were measured from 9 KHz to 25GHz and recorded worst case at GFSK DH5 mode.
- For below 1GHz testing recorded worst at GFSK DH5 middle channel.
- Radiated emission test from 9 KHz to 10th harmonic of fundamental was verified, and The emission levels from 9kHz to 30MHz are attenuated 20dB below the limit and not recorded in report.

For 30MHz-1GHz

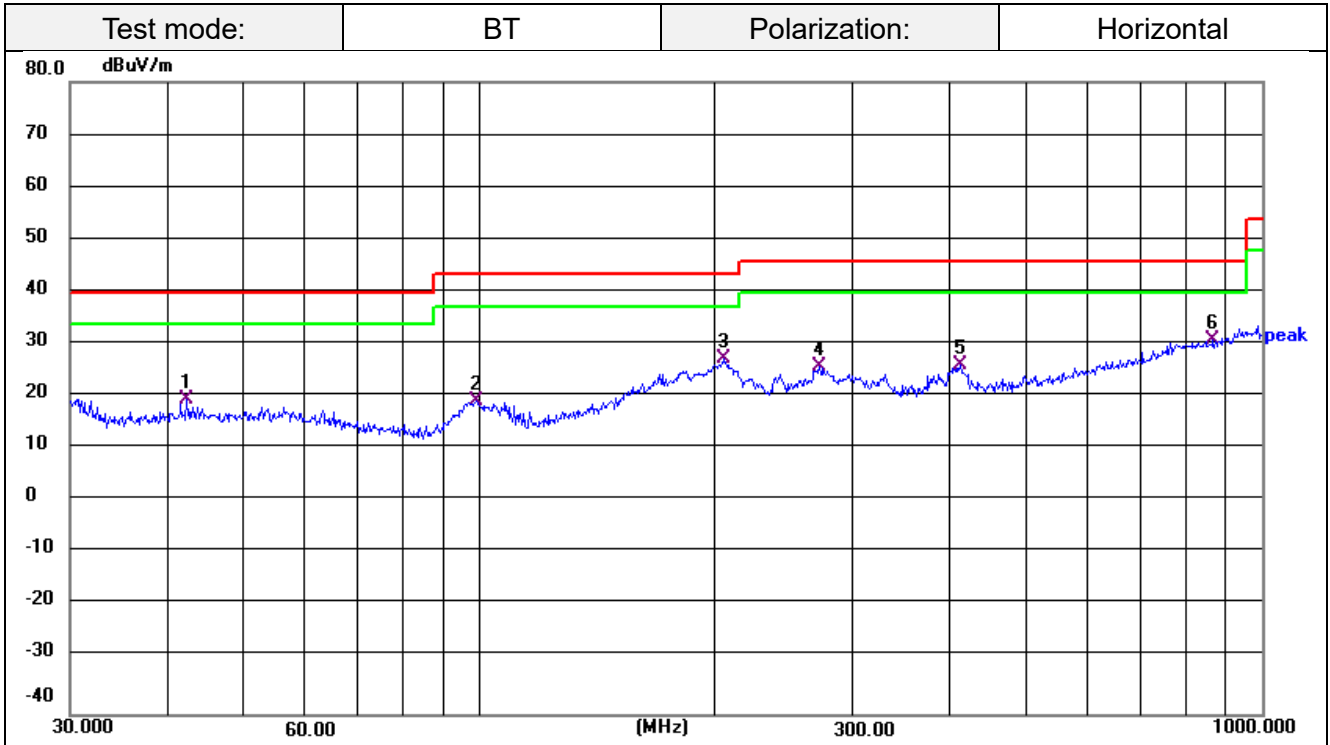

Remark:

Emission Level = Reading + Factor;
 Factor = Antenna Factor + Cable Loss – Pre-amplifier;
 Margin= Emission Level - Limit.

No.	Frequency (MHz)	Reading (dBuV)	Factor (dB/m)	Level (dBuV/m)	Limit (dBuV/m)	Margin (dB)	Det.
1	42.3022	36.31	-16.57	19.74	40.00	-20.26	QP
2	99.1797	40.02	-20.38	19.64	43.50	-23.86	QP
3	204.9551	47.72	-20.18	27.54	43.50	-15.96	QP
4	272.2776	43.81	-17.75	26.06	46.00	-19.94	QP
5	411.8240	40.54	-14.26	26.28	46.00	-19.72	QP
6	866.0879	36.23	-5.21	31.02	46.00	-14.98	QP

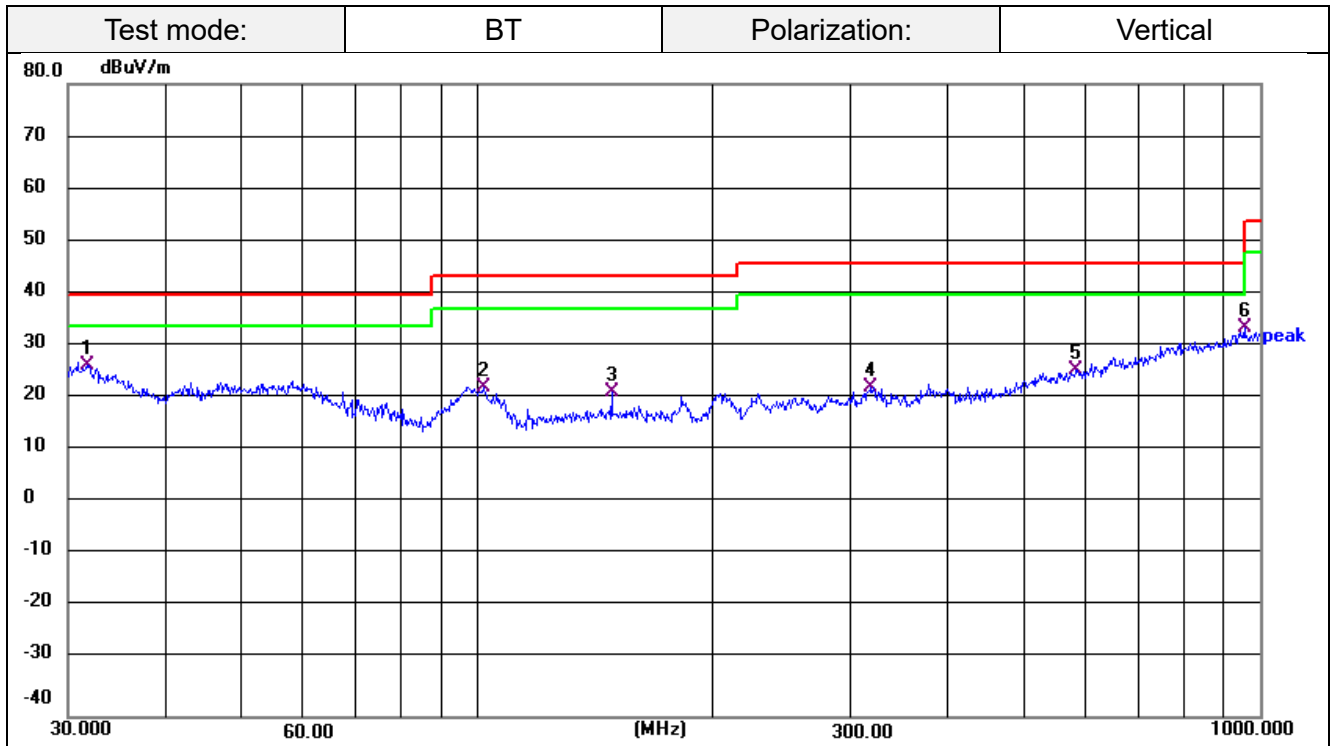

Remark:
 Emission Level = Reading + Factor;
 Factor = Antenna Factor + Cable Loss – Pre-amplifier;
 Margin= Emission Level - Limit.

No.	Frequency (MHz)	Reading (dBuV)	Factor (dB/m)	Level (dBuV/m)	Limit (dBuV/m)	Margin (dB)	Det.
1	31.7313	44.25	-17.45	26.80	40.00	-13.20	QP
2	102.0014	42.64	-20.15	22.49	43.50	-21.01	QP
3	148.4410	38.36	-16.63	21.73	43.50	-21.77	QP
4	318.8170	39.02	-16.41	22.61	46.00	-23.39	QP
5	582.7425	36.07	-10.18	25.89	46.00	-20.11	QP
6	955.4381	37.16	-3.49	33.67	46.00	-12.33	QP

For 1GHz to 25GHz

Note:GFSK, Pi/4 DQPSK and 8DPSK all have been tested, only worse case GFSK is reported as bellow:

GFSK (above 1GHz)

Frequency(MHz):		2402		Polarity:	Horizontal	
Frequency	Meter Reading	Factor	Emission Level	Limits	Margin	Detector Type
(MHz)	(dBµV)	(dB/m)	(dBµV/m)	(dBµV/m)	(dB)	
4803.95	54.79	-7.55	47.24	74	-26.76	PEAK
--	--	--	--	--	--	AVG
7206.35	48.32	-1.63	46.69	74	-27.31	PEAK
--	--	--	--	--	--	AVG

Frequency(MHz):		2402		Polarity:	VERTICAL	
Frequency	Meter Reading	Factor	Emission Level	Limits	Margin	Detector Type
(MHz)	(dBµV)	(dB/m)	(dBµV/m)	(dBµV/m)	(dB)	
4803.95	55.46	-7.55	47.91	74	-26.09	PEAK
--	--	--	--	--	--	AVG
7206.35	49.35	-1.63	47.72	74	-26.28	PEAK
--	--	--	--	--	--	AVG

Frequency(MHz):		2441		Polarity:	Horizontal	
Frequency	Meter Reading	Factor	Emission Level	Limits	Margin	Detector Type
(MHz)	(dBµV)	(dB/m)	(dBµV/m)	(dBµV/m)	(dB)	
4882.15	52.59	-6.73	45.86	74	-28.14	PEAK
--	--	--	--	--	--	AVG
7323.00	45.31	-0.5	44.81	74	-29.19	PEAK
--	--	--	--	--	--	AVG

Frequency(MHz):		2441		Polarity:	VERTICAL	
Frequency	Meter Reading	Factor	Emission Level	Limits	Margin	Detector Type
(MHz)	(dBµV)	(dB/m)	(dBµV/m)	(dBµV/m)	(dB)	
4882.15	53.70	-6.73	46.97	74	-27.03	PEAK
--	--	--	--	--	--	AVG
7323.00	45.55	-0.5	45.05	74	-28.95	PEAK
--	--	--	--	--	--	AVG

Frequency(MHz):		2480		Polarity:	Horizontal	
Frequency	Meter Reading	Factor	Emission Level	Limits	Margin	Detector Type
(MHz)	(dBμV)	(dB/m)	(dBμV/m)	(dBμV/m)	(dB)	
4959.70	47.02	-5.77	47.79	74	-26.21	PEAK
--	--	--	--	--	--	AVG
7439.70	46.47	-0.51	45.64	74	-28.36	PEAK
--	--	--	--	--	--	AVG

Frequency(MHz):		2480		Polarity:	VERTICAL	
Frequency	Meter Reading	Factor	Emission Level	Limits	Margin	Detector Type
(MHz)	(dBμV)	(dB/m)	(dBμV/m)	(dBμV/m)	(dB)	
4959.70	45.63	-5.77	48.89	74	-25.11	PEAK
--	--	--	--	--	--	AVG
7439.70	45.02	-0.51	46.21	74	-27.79	PEAK
--	--	--	--	--	--	AVG

REMARKS:

1. Emission level (dBuV/m) = Reading (dBuV)+ Factor (dB/m)
2. Factor (dB/m) = Antenna Factor (dB/m)+Cable Factor (dB)-Pre-amplifier Factor
3. Margin value = Emission level- Limit value.
4. -- Mean the PK detector measured value is below average limit.
5. Other emission levels are attenuated 20dB below the limit and not recorded in report.
6. RBW1MHz VBW3MHz Peak detector is for PK value; RBW 1MHz VBW10Hz Peak detector is for AV value.

Radiation Restricted band

Note: GFSK, Pi/4 DQPSK and 8DPSK all have been tested, only worse case GFSK is reported as below:

Frequency(MHz):		2402		Polarity:	Horizontal	
Frequency	Meter Reading	Factor	Emission Level	Limits	Margin	Detector Type
(MHz)	(dBµV)	(dB/m)	(dBµV/m)	(dBµV/m)	(dB)	
2388.46	52.80	-4.08	48.72	74	-25.28	PEAK
--	--	--	--	--	--	AVG
2390.00	40.62	-4.10	45.60	74	-28.40	PEAK
--	--	--	--	--	--	AVG

Frequency(MHz):		2402		Polarity:	Vertical	
Frequency	Meter Reading	Factor	Emission Level	Limits	Margin	Detector Type
(MHz)	(dBµV)	(dB/m)	(dBµV/m)	(dBµV/m)	(dB)	
2389.45	53.82	-4.09	49.73	74	-24.27	PEAK
--	--	--	--	--	--	AVG
2390.00	49.79	-4.10	45.69	74	-28.31	PEAK
--	--	--	--	--	--	AVG

Frequency(MHz):		2480		Polarity:	Horizontal	
Frequency	Meter Reading	Factor	Emission Level	Limits	Margin	Detector Type
(MHz)	(dBµV)	(dB/m)	(dBµV/m)	(dBµV/m)	(dB)	
2483.50	51.92	-3.09	48.83	74	-25.17	PEAK
--	--	--	--	--	--	AVG
2483.78	48.79	-3.09	45.70	74	-28.30	PEAK
--	--	--	--	--	--	AVG

Frequency(MHz):		2480		Polarity:	Vertical	
Frequency	Meter Reading	Factor	Emission Level	Limits	Margin	Detector Type
(MHz)	(dBµV)	(dB/m)	(dBµV/m)	(dBµV/m)	(dB)	
2483.50	52.77	-3.09	49.68	74	-24.32	PEAK
--	--	--	--	--	--	AVG
2483.98	49.18	-3.09	46.09	74	-27.91	PEAK
--	--	--	--	--	--	AVG

REMARKS:

1. Emission level (dBuV/m) = Reading (dBuV)+ Factor (dB/m)
2. Factor (dB/m) = Antenna Factor (dB/m)+Cable Factor (dB)-Pre-amplifier Factor
3. Margin value = Emission level- Limit value.
4. -- Mean the PK detector measured value is below average limit.
5. Other emission levels are attenuated 20dB below the limit and not recorded in report.
6. RBW1MHz VBW3MHz Peak detector is for PK value; RBW 1MHz VBW10Hz Peak detector is for AV value.

3.3 Maximum Peak Output Power

Limit

For frequency hopping systems operating in the 2400-2483.5 MHz band employing at least 75 non-overlapping hopping channels: 1 watt.

For all other frequency hopping systems in the 2400-2483.5 MHz band: 0.125 watts.

Test Procedure

The transmitter output (antenna port) was connected to the spectrum analyzer. According to ANSI C63.10:2013 Output power test procedure for frequency-hopping spread-spectrum (FHSS) devices; this is an RF-conducted test to evaluate maximum peak output power. Use a direct connection between the antenna port of the unlicensed wireless device and the spectrum analyzer, through suitable attenuation. The hopping shall be disabled for this test:

- a) Use the following spectrum analyzer settings:
 - 1) Span: Approximately five times the 20 dB bandwidth, centered on a hopping channel.
 - 2) RBW > 20 dB bandwidth of the emission being measured.
 - 3) VBW ≥ RBW.
 - 4) Sweep: Auto.
 - 5) Detector function: Peak.
 - 6) Trace: Max hold.
- b) Allow trace to stabilize.
- c) Use the marker-to-peak function to set the marker to the peak of the emission.
- d) The indicated level is the peak output power, after any corrections for external attenuators and cables.

Test Configuration

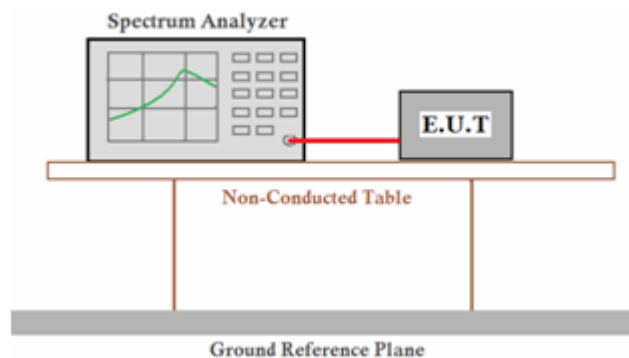

Test Results

Pass Not Applicable

Note:

For test data, please refer to Appendix RF test data for BT.

3.4 20dB Bandwidth

Limit

For frequency hopping systems operating in the 2400MHz-2483.5MHz no limit for 20dB bandwidth.

Test Procedure

Remove the antenna from the EUT and then connect a low loss RF cable from the antenna port to the Spectrum Analyzer. Place the EUT on the table and set it in transmitting mode.

Use the following spectrum analyzer settings:

- 1) Span = approximately 2 to 3 times the 20 dB bandwidth, centered on a hopping channel.
- 2) RBW \geq 1% of the 20 dB bandwidth, VBW \geq RBW.
- 3) Detector function = peak.
- 4) Trace = max hold.

The 20dB bandwidth is defined as the total spectrum the power of which is higher than peak power minus 20dB.

Test Configuration

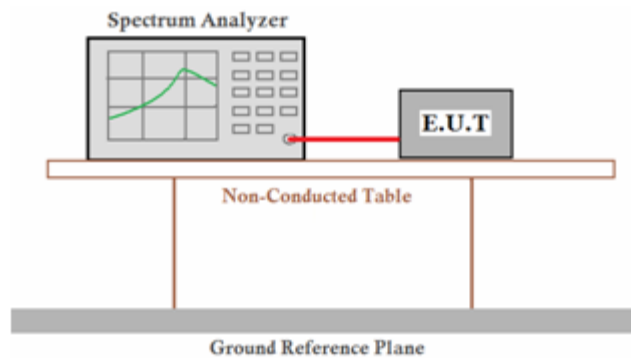

Test Results

Pass Not Applicable

Note:

For test data, please refer to Appendix RF test data for BT.

3.5 Occupied Bandwidth

Limit

N/A

Test Procedure

The occupied bandwidth is the frequency bandwidth such that, below its lower and above its upper frequency limits, the mean powers are each equal to 0.5% of the total mean power of the given emission. The following procedure shall be used for measuring 99% power bandwidth:

RBW=1% to 5% of the OBW

VBW=approximately 3 X RBW

Detector=Peak

Trace Mode: Max Hold

Use the 99% power bandwidth function of the instrument to measure the Occupied Bandwidth and recorded.

Test Configuration

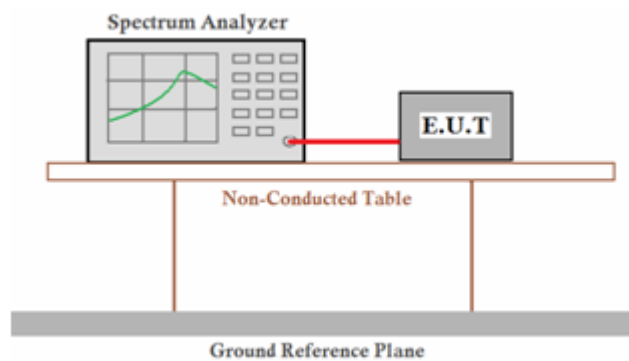

Test Results

Pass **Not Applicable**

Note:
For test data, please refer to Appendix RF test data for BT.

3.6 Frequency Separation

LIMIT

According to 15.247(a)(1), frequency hopping systems shall have hopping channel carrier frequencies separated by minimum of 25KHz or the $\frac{2}{3} \times 20\text{dB}$ bandwidth of the hopping channel, whichever is greater.

Test Procedure

Remove the antenna from the EUT and then connect a low loss RF cable from the antenna port to the Spectrum Analyzer. Place the EUT on the table and set it in transmitting mode.

Use the following spectrum analyzer settings:

- 1) Set center frequency of Spectrum Analyzer = middle of hopping channel.
- 2) Set the Spectrum Analyzer as RBW = 100 kHz, VBW = 300 kHz, Span = wide enough to capture the peaks of two adjacent channels, Sweep = auto.
- 3) Max hold, mark 2 peaks of hopping channel and record the 2 peaks frequency.

TEST CONFIGURATION

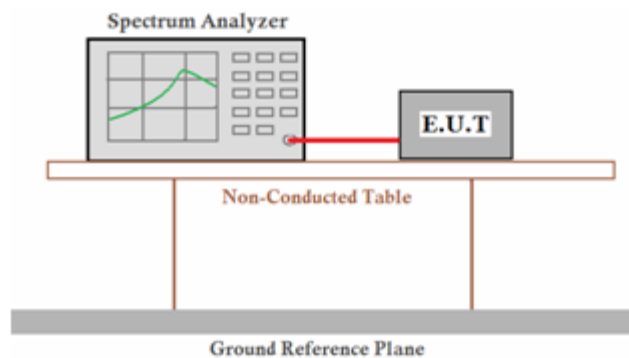

TEST RESULTS

Pass Not Applicable

Note:
For test data, please refer to Appendix RF test data for BT.

3.7 Number of hopping frequency

Limit

Frequency hopping systems in the 2400–2483.5 MHz band shall use at least 15 channels.

Test Procedure

Remove the antenna from the EUT and then connect a low loss RF cable from the antenna port to the Spectrum Analyzer. Place the EUT on the table and set it in transmitting mode.

Use the following spectrum analyzer settings:

- 1) Set Spectrum Analyzer Start=2400MHz, Stop = 2483.5MHz, Sweep = auto.
- 2) Set the Spectrum Analyzer as RBW/VBW=100KHz/300KHz.
- 3) Max hold, view and count how many channel in the band.

Test Configuration

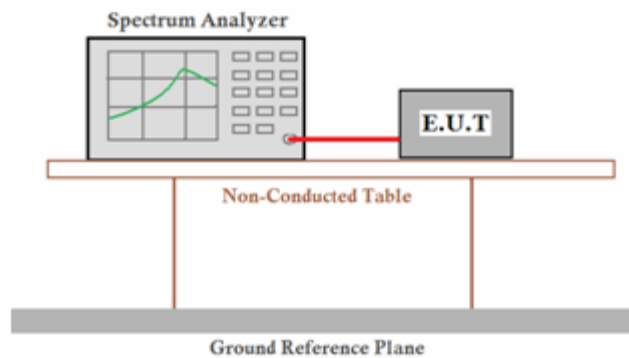

Test Results

Pass Not Applicable

Note:

For test data, please refer to Appendix RF test data for BT.

3.8 Time of Occupancy (Dwell Time)

Limit

The average time of occupancy on any channel shall not be greater than 0.4 seconds within a period of 0.4 seconds multiplied by the number of hopping channels employed.

Test Procedure

Remove the antenna from the EUT and then connect a low loss RF cable from the antenna port to the Spectrum Analyzer. Place the EUT on the table and set it in transmitting mode.

Use the following spectrum analyzer settings:

- 1) Set center frequency of Spectrum Analyzer = operating frequency.
- 2) Set the Spectrum Analyzer as RBW=1MHz, VBW=3MHz, Span = 0Hz, Sweep = auto.
- 3) Repeat above procedures until all frequency measured was complete.

Test Configuration

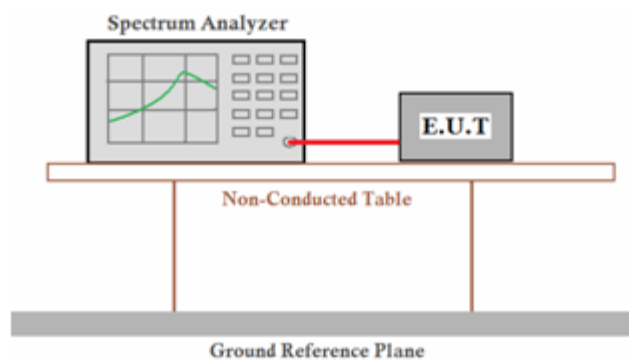

Test Results

Pass Not Applicable

Note:
For test data, please refer to Appendix RF test data for BT.

3.9 Out-of-band Emissions

Limit

In any 100 kHz bandwidth outside the frequency band in which the spread spectrum or digitally modulated intentional radiator is operating, the radio frequency power that is produced by the intentional radiator shall be at least 20 dB below that in the 100 kHz bandwidth within the band that contains the highest level of the desired power, based on either an RF conducted or a radiated measurement, provided the transmitter demonstrates compliance with the peak conducted power limits. If the transmitter complies with the conducted power limits based on the use of RMS averaging over a time interval, as permitted under paragraph (b)(3) of this section, the attenuation required under this paragraph shall be 30 dB instead of 20 dB. Attenuation below the general limits specified in §15.209(a) is not required.

Test Procedure

Connect the transmitter output to spectrum analyzer using a low loss RF cable, and set the spectrum analyzer to RBW=100 kHz, VBW= 300 kHz, peak detector, and max hold. Measurements utilizing these settings are made of the in-band reference level, bandedge and out-of-band emissions.

Test Configuration

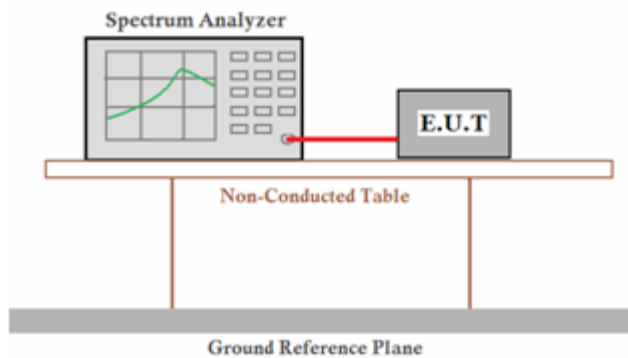

Test Results

Pass **Not Applicable**

Note:
For test data, please refer to Appendix RF test data for BT.

3.10 Pseudorandom Frequency Hopping Sequence

TEST APPLICABLE

For 47 CFR Part 15C section 15.247 (a) (1) RSS-247§5.1 requirement:

Frequency hopping systems shall have hopping channel carrier frequencies separated by a minimum of 25 kHz or the 20 dB bandwidth of the hop-ping channel, whichever is greater. Alternatively, frequency hopping systems operating in the 2400–2483.5 MHz band may have hopping channel carrier frequencies that are separated by 25 kHz or two-thirds of the 20 dB bandwidth of the hopping channel, whichever is greater, provided the systems operate with an output power no greater than 125 mW. The system shall hop to channel frequencies that are selected at the system hopping rate from a pseudo randomly ordered list of hopping frequencies. Each frequency must be used equally on the average by each transmitter. The system receivers shall have input bandwidths that match the hop-ping channel bandwidths of their corresponding transmitters and shall shift frequencies in synchronization with the transmitted signals.

EUT Pseudorandom Frequency Hopping Sequence Requirement

The pseudorandom frequency hopping sequence may be generated in a nine-stage shift register whose 5th and 9th stage outputs are added in a modulo-two addition stage. And the result is fed back to the input of the first stage. The sequence begins with the first one of 9 consecutive ones, for example: the shift register is initialized with nine ones.

- Number of shift register stages:9
- Length of pseudo-random sequence:29-1=511 bits
- Longest sequence of zeros:8(non-inverted signal)

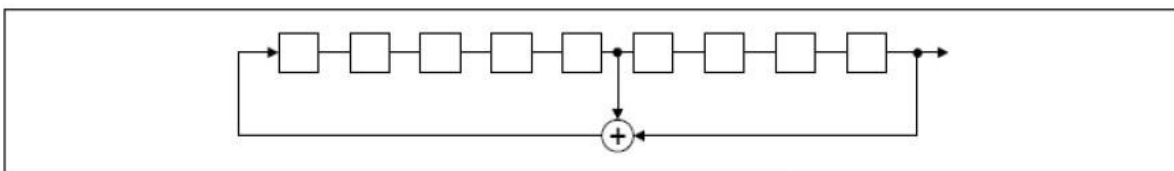

Linear Feedback Shift Register for Generation of the PRBS sequence

An example of pseudorandom frequency hopping sequence as follows:

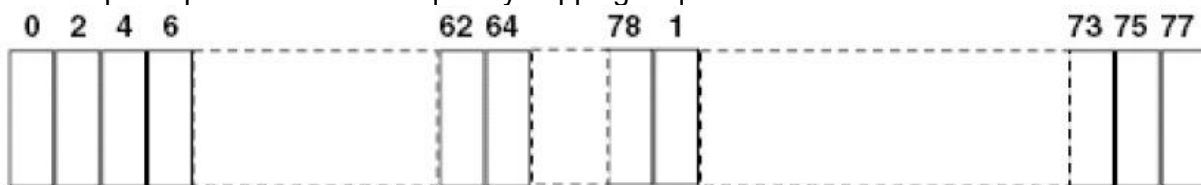

Each frequency used equally one the average by each transmitter.

The system receiver has input bandwidths that match the hopping channel bandwidths of their corresponding transmitter and shift frequencies in synchronization with the transmitted signals.

3.11 Antenna Requirement

Standard Applicable

For intentional device, according to FCC 47 CFR Section 15.203:

An intentional radiator shall be designed to ensure that no antenna other than that furnished by the responsible party shall be used with the device. The use of a permanently attached antenna or of an antenna that uses a unique coupling to the intentional radiator, the manufacturer may design the unit so that a broken antenna can be replaced by the user, but the use of a standard antenna jack or electrical connector is prohibited

FCC CFR Title 47 Part 15 Subpart C Section 15.247(b) (4):

(4) The conducted output power limit specified in paragraph (b) of this section is based on the use of antennas with directional gains that do not exceed 6 dBi. Except as shown in paragraph (c) of this section, if transmitting antennas of directional gain greater than 6 dBi are used, the conducted output power from the intentional radiator shall be reduced below the stated values in paragraphs (b)(1), (b)(2), and (b)(3) of this section, as appropriate, by the amount in dB that the directional gain of the antenna exceeds 6 dBi.

Test Result

The maximum gain of antenna was 2.17dBi with impedance 50Ω.

4 Test Setup Photographs of EUT

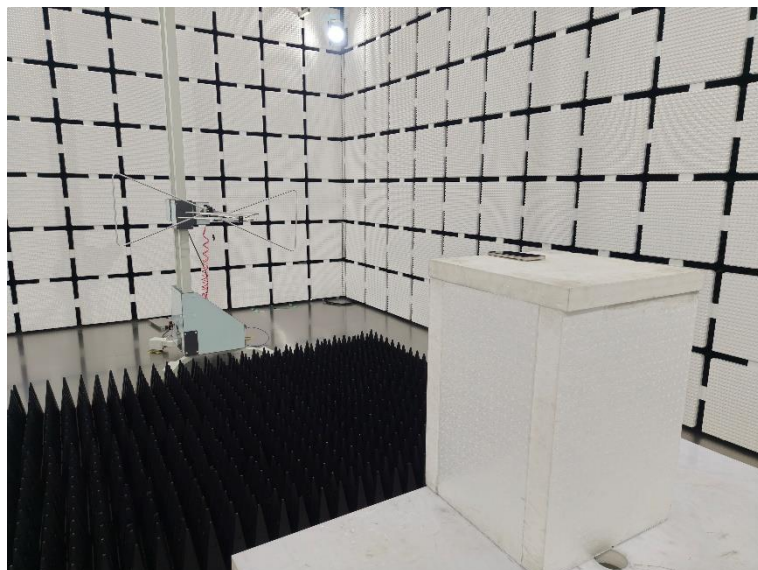
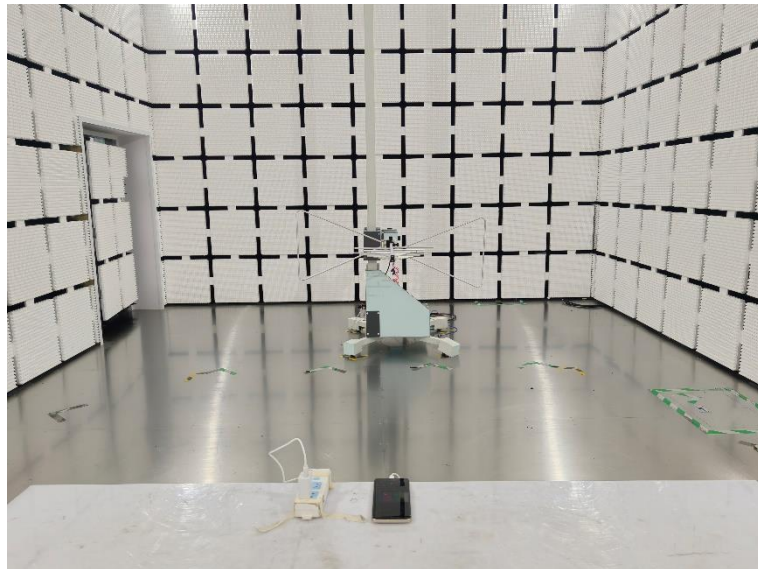

5 Photos of EUT

External Photos

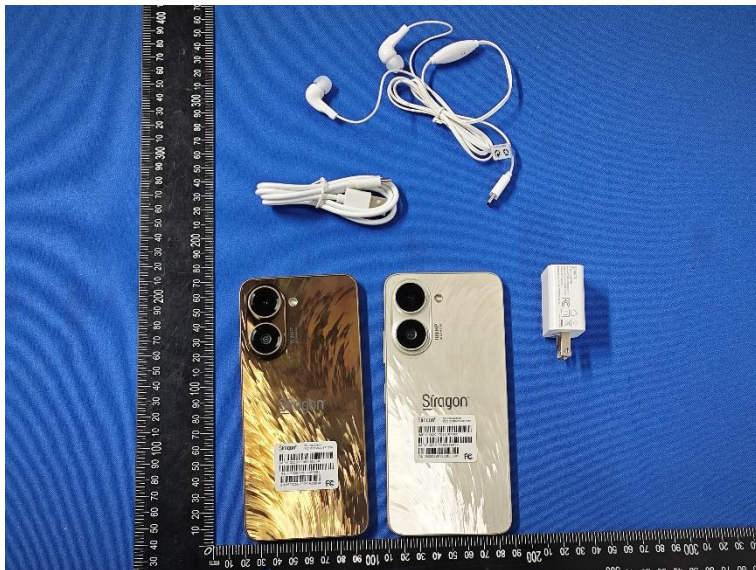

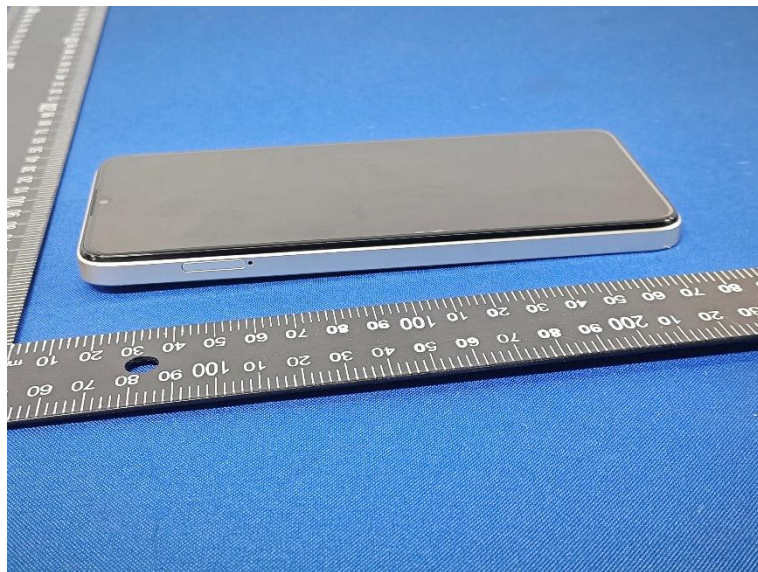
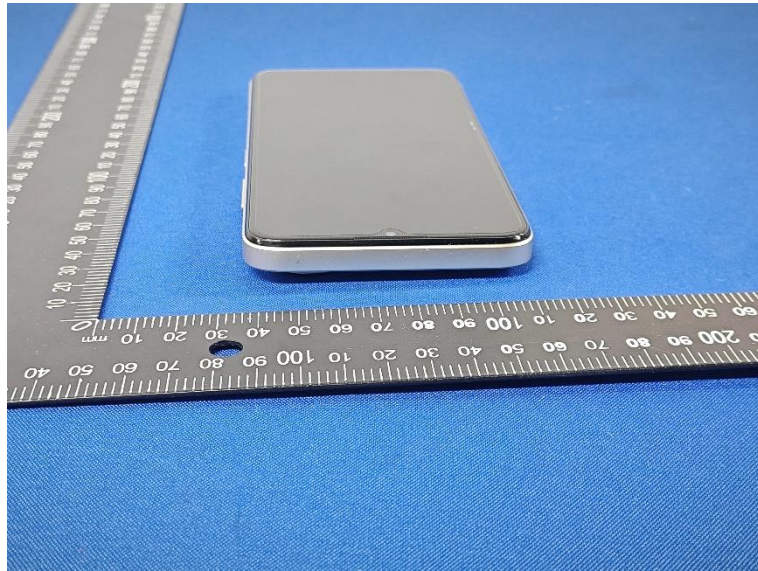
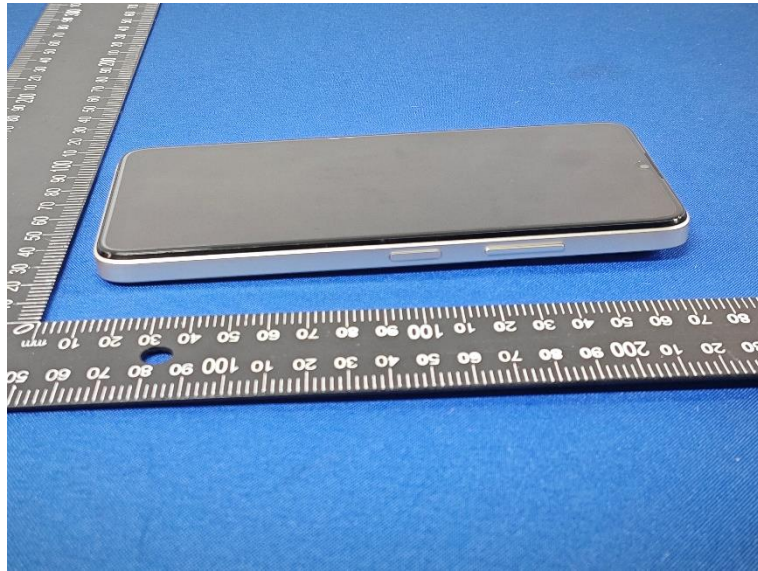

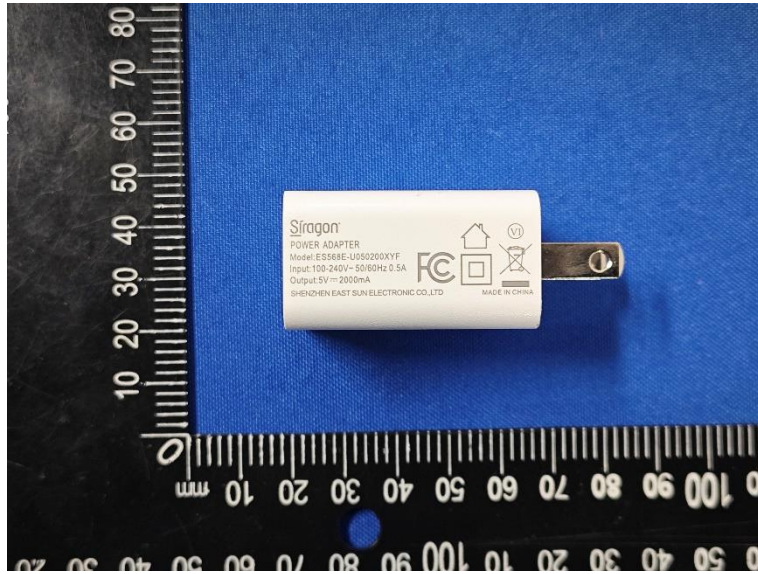
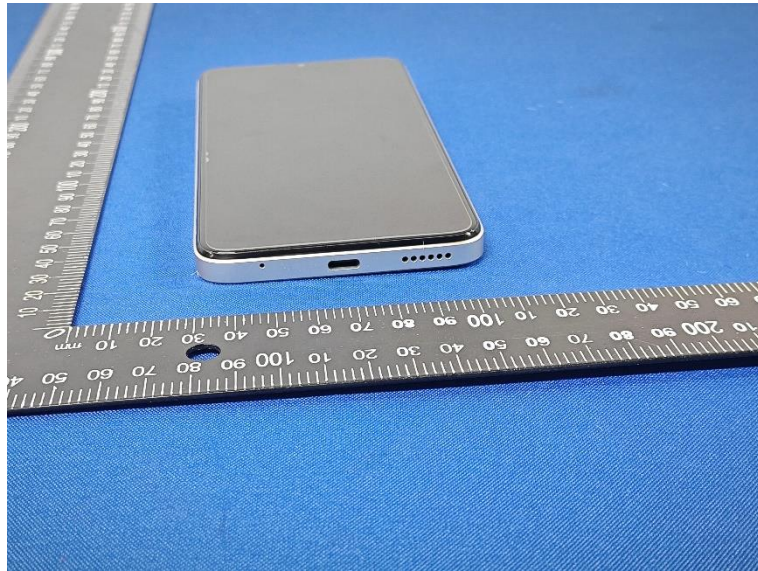

Internal photos



WWAN DVI ANT WLAN ANT

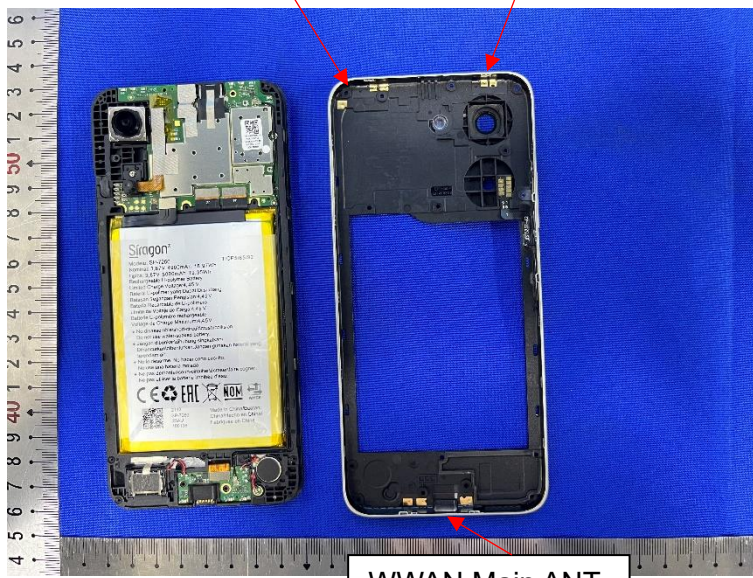

WWAN Main ANT



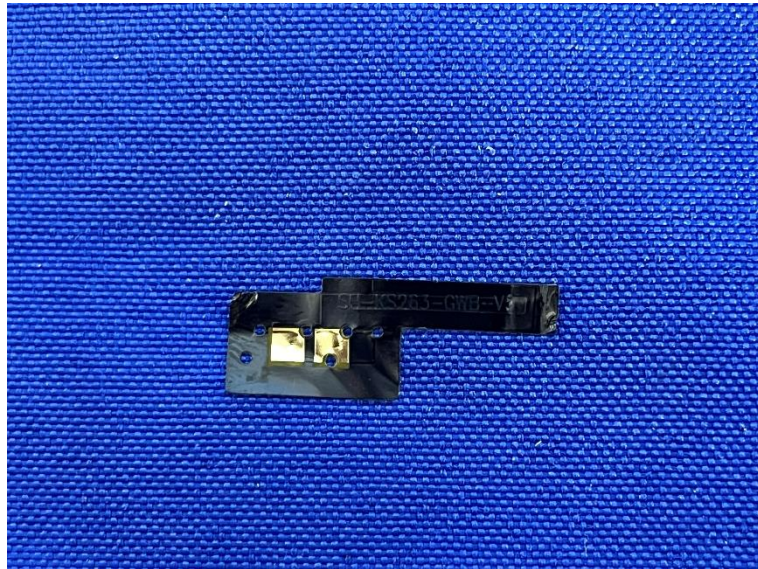

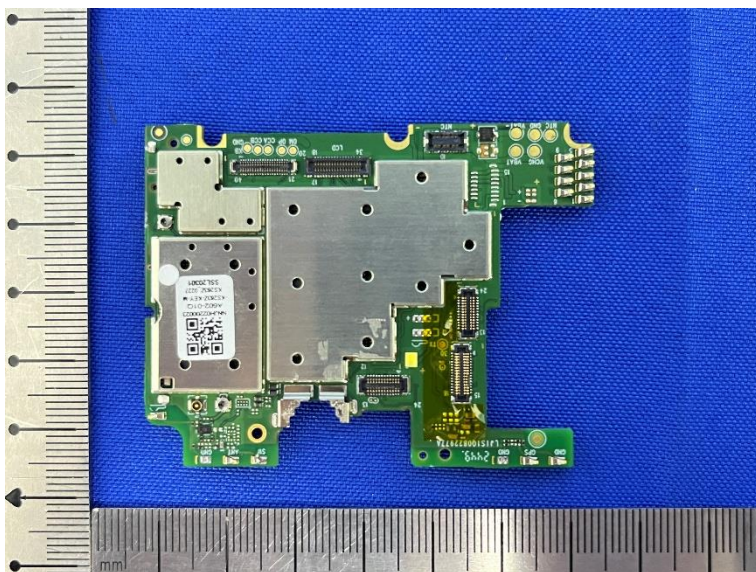
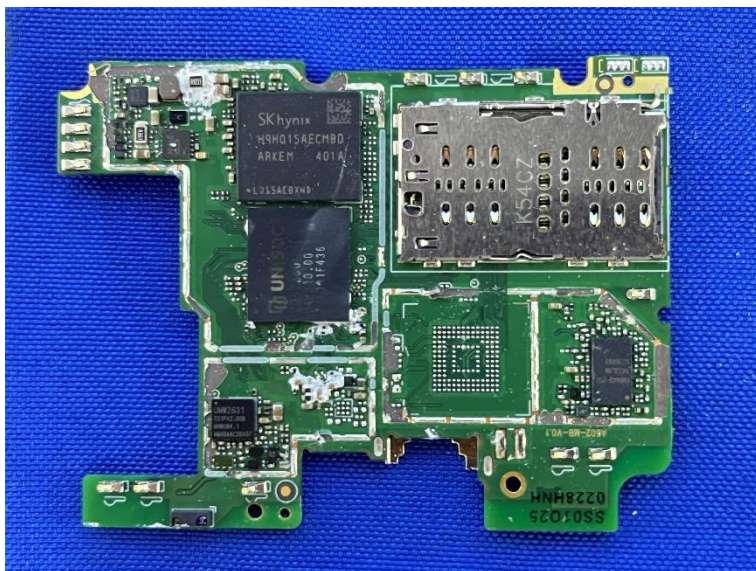
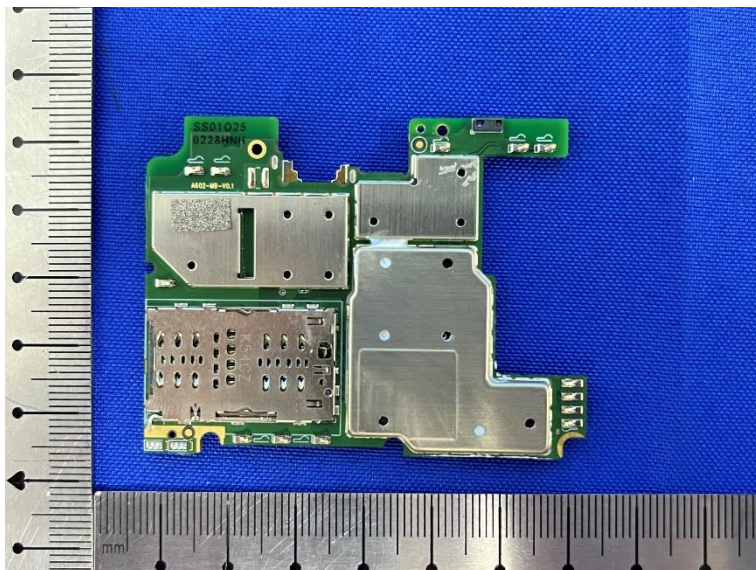

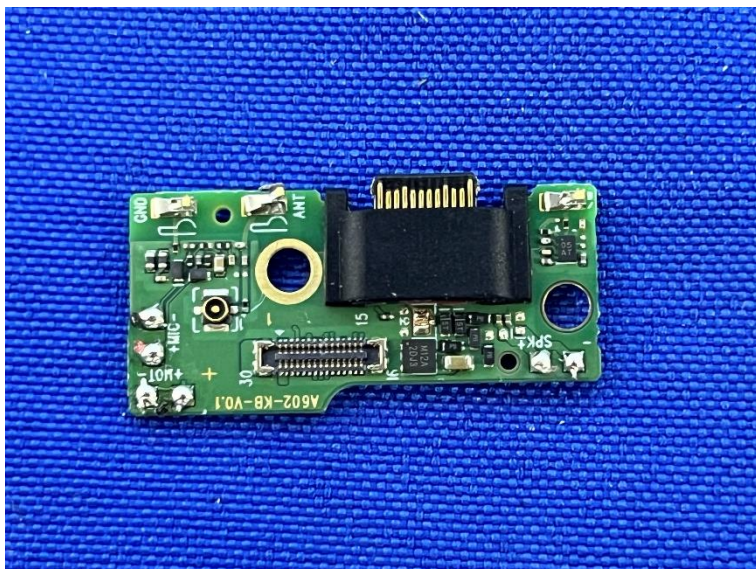
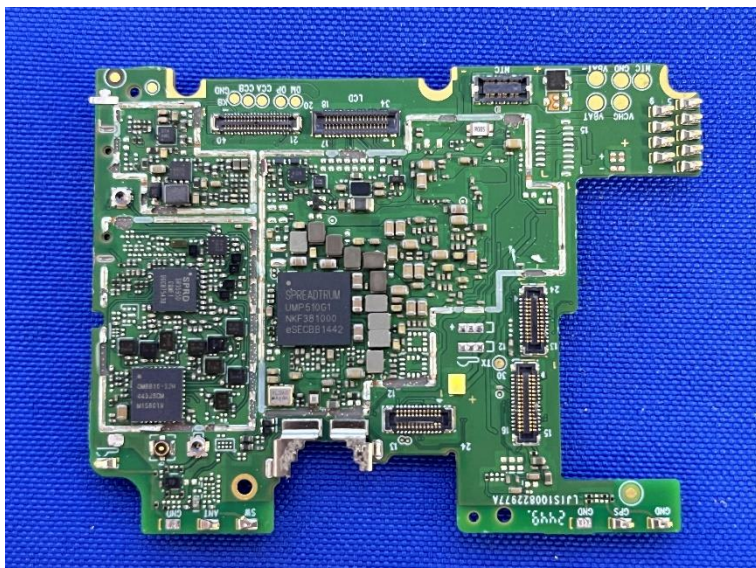



***** End of Report *****