

FCC SAR EVALUATION REPORT

**In accordance with the requirements of
FCC 47 CFR Part 2(2.1093) and
IEEE Std 1528-2013**

Product Name: Smart Phone

Model No.: SP-6300

Serial Model: N/A

Brand Name: SIRAGON

Report No.: AiTSZ-250424009FW7

FCC ID: 2BACG-SP-6300

Prepared for

Siragon Corporate

CR MANZANA A LOCAL SHED NRO 1-4VALLE ALTO GUAYABAL NAGUANAGUA
CARABOBO ZIP 2005.IVORY STORE.Venezuela

Prepared by

Guangdong Asia Hongke Test Technology Limited

B1/F, Building 11, Junfeng Industrial Park, Chongqing Road, Heping Community, Fuhai
Street, Bao'an District, Shenzhen, Guangdong, China

Tel.: +86 0755-230967639 Fax.: +86 0755-230967639

TEST RESULT CERTIFICATION

Applicant's name: Siragon Corporate
CR MANZANA A LOCAL SHED NRO 1-4VALLE ALTO
Address: GUAYABAL NAGUANAGUA CARABOBO ZIP 2005.IVORY
STORE.Venezuela
Manufacturer's Name: Shenzhen Tugao Intelligent Co., Ltd
NO.801,802,1001,1002,BldgA,Jingang Science & Technology
Address: Park, Fuhai Street, Qiaotou Community, Baoan District,
Shenzhen, China

Product description

Product name: Smart Phone
Trademark: SIRAGON
Model and/or type reference ..: SP-6300
Serial Model.....: N/A
FCC 47 CFR Part 2(2.1093)

Standards: IEEE Std 1528-2013
Published RF exposure KDB procedures

This device described above has been tested by Guangdong Asia Hongke Test Technology Limited. In accordance with the measurement methods and procedures specified in IEEE Std 1528-2013 and KDB 865664 D01. Testing has shown that this device is capable of compliance with localized specific absorption rate (SAR) specified in FCC 47 CFR Part 2(2.1093). The test results in this report apply only to the tested sample of the stated device/equipment. Other similar device/equipment will not necessarily produce the same results due to production tolerance and measurement uncertainties.

This report shall not be reproduced except in full, without the written approval of Guangdong Asia Hongke Test Technology Limited, this document may be altered or revised by Guangdong Asia Hongke Test Technology Limited, personal only, and shall be noted in the revision of the document.

Date of Test

Date (s) of performance of tests: Apr. 25, 2025 ~ May 05, 2025
Date of Issue.....: May 14, 2025
Test Result: **Pass**

Reviewed by: 

Simba Huang

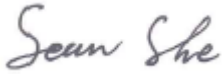
Approved by: 

Sean She

※ ※ Revision History ※ ※

REV.	DESCRIPTION	ISSUED DATE	REMARK
Rev.1.0	Initial Test Report Release	May 14, 2025	Sean She

TABLE OF CONTENTS

1. General Information	6
1.1. RF exposure limits	6
1.2. Statement of Compliance	7
1.3. EUT Description	8
1.4. Test specification(s).....	10
1.5. Ambient Condition.....	10
1.6. Test Facility.....	10
2. SAR Measurement System.....	11
2.1. SATIMO SAR Measurement Set-up Diagram	11
2.2. Robot	12
2.3. Probe.....	13
2.3.1. E-Field Probe Calibration	13
2.4. Phantoms.....	14
2.5. Technical Data.....	15
2.6. Device Holder.....	16
2.7. Test Equipment List.....	17
3. SAR Measurement Procedures	19
3.1. Power Reference.....	19
3.2. Area scan & Zoom scan.....	19
3.3. Description of interpolation/extrapolation scheme	21
3.4. Volumetric Scan	21
3.5. Power Drift.....	21
4. System Verification Procedure.....	22
4.1. Tissue Verification.....	22
4.1.1. Tissue Dielectric Parameter Check Results	23
4.2. System Verification Procedure	24
4.2.1. System Verification Results	25
5. SAR measurement variability.....	26
6. SAR Measurement Uncertainty	27
7. RF Exposure Positions	28
7.1. Ear and handset reference point	28
7.2. Definition of the cheek position	28
7.3. Definition of the tilt position	30
7.4. Body Worn Accessory	30
7.5. Wireless Router Devices.....	31
8. RF Output Power.....	32
8.1. GSM Conducted Power	32
8.2. WCDMA Conducted Power	33
8.3. LTE Conducted Power	35

8.4. Wi-Fi & BT Output Power	43
9. Antenna Location	45
10. Stand-alone SAR test exclusion.....	46
11. SAR Measurement Results.....	47
12. Simultaneous Transmission Analysis	59
Appendix A. Photo documentation	60
Appendix B. System Check Plots	61
Appendix C. SAR Test Plots.....	76
Appendix D. Calibration Certificate	121
Appendix E. Justification of the extended calibration.....	182

1. General Information

1.1. RF exposure limits

(A).Limits for Occupational/Controlled Exposure (W/kg)

Whole-Body	Partial-Body	Hands, Wrists, Feet and Ankles
0.4	8.0	20.0

(B).Limits for General Population/Uncontrolled Exposure (W/kg)

Whole-Body	Partial-Body	Hands, Wrists, Feet and Ankles
0.08	1.6	4.0

NOTE: **Whole-Body SAR** is averaged over the entire body, **partial-body SAR** is averaged over any 1 gram of tissue defined as a tissue volume in the shape of a cube. **SAR for hands, wrists, feet and ankles** is averaged over any 10 grams of tissue defined as a tissue volume in the shape of a cube.

Occupational/Controlled Environments:

Are defined as locations where there is exposure that may be incurred by people who are aware of the potential for exposure, (i.e. as a result of employment or occupation).

General Population/Uncontrolled Environments:

Are defined as locations where there is the exposure of individuals who have no knowledge or control of their exposure.

NOTE
 HEAD AND TRUNK LIMIT
 1.6 W/kg
 APPLIED TO THIS EUT

1.2. Statement of Compliance

The maximum results of Specific Absorption Rate (SAR) found during testing as follows.

Band	Max SAR Value Reported(W/kg)		Max SAR Summation
	1-g Head (Separation distance of 0mm)	1-g Body&Hotspot (Separation distance of 5mm)	
GSM850	0.203	0.194	Head: 1.144 Body: 1.108 Hotspot: 1.108
GSM1900	0.418	0.380	
WCDMA Band II	0.461	0.356	
WCDMA Band V	0.249	0.199	
LTE band 2	0.533	0.493	
LTE band 4	0.501	0.276	
LTE band 5	0.376	0.272	
LTE band 7	0.609	0.478	
2.4GHz WLAN	0.321	0.341	
5.2GHz WLAN	0.378	0.615	
5.8GHz WLAN	0.535	0.562	

NOTE: The Max SAR Summation is calculated based on the same configuration and test position.

This device is in compliance with Specific Absorption Rate (SAR) for general population/uncontrolled exposure limits (1.6 W/kg) specified in FCC 47 CFR Part 2(2.1093), and had been tested in accordance with the measurement methods and procedures specified in IEEE Std 1528-2013 & KDB 865664 D01.

1.3. EUT Description

Device Information			
Product Name	Smart Phone		
Model Name	SP-6300		
Family Model	N/A		
Device Phase	Identical Prototype		
Exposure Category	General population / Uncontrolled environment		
Antenna Type	PIFA Antenna		
Power rating:	DC 3.87V 5160mAh/19.96Wh Rechargeable Li-ion battery		
Hardware version	3368N-UF-V11		
Software version	N/A		
Device Operating Configurations			
Supporting Mode(s)	GSM850/1900,WCDMABand2/5,LTEBand2/4/5/7, WLAN 2.4G/5.2G/5.8G, Bluetooth		
Test Modulation	GSM(GMSK/8PSK), WCDMA(QPSK), LTE(QPSK/16QAM), WLAN(DSSS/OFDM), Bluetooth(GFSK, $\pi/4$ -DQPSK, 8DPSK)		
Device Class	B		
Operating Frequency Range(s)	Band	Tx (MHz)	Rx (MHz)
	GSM 850	824-849	869-894
	GSM 1900	1850-1910	1930-1990
	WCDMA Band 2	1850-1910	1930-1990
	WCDMA Band 5	824-849	869-894
	LTE Band 2	1850-1910	1930-1990
	LTE Band 4	1710-1755	2110-2155
	LTE Band 5	824-849	869-894
	LTE Band 7	2500-2570	2620-2690
	WLAN 2.4G	2412-2462	
	WLAN 5.2G	5180-5240	
	WLAN 5.8G	5745-5825	
	Bluetooth	2402-2480	
	GPRS Multislot Class(12)	Max Number of Timeslots in Uplink	
Max Number of Timeslots in Downlink		4	
Max Total Timeslot		5	
EGPRS Multislot Class(12)	Max Number of Timeslots in Uplink		4
	Max Number of Timeslots in Downlink		4
	Max Total Timeslot		5
Power Class	4, tested with power level 5(GSM 850)		
	1, tested with power level 0(GSM 1900)		
	3, tested with power control "all 1"(WCDMA Band 2)		



	3, tested with power control "all 1"(WCDMA Band 5)
	3, tested with power control all Max.(LTE Band 2)
	3, tested with power control all Max.(LTE Band 4)
	3, tested with power control all Max.(LTE Band 5)
	3, tested with power control all Max.(LTE Band 7)

1.4. Test specification(s)

FCC 47 CFR Part 2(2.1093)
IEEE Std 1528-2013
KDB 865664 D01 SAR measurement 100 MHz to 6 GHz
KDB 865664 D02 RF Exposure Reporting
KDB 447498 D01 General RF Exposure Guidance
KDB 248227 D01 802.11 Wi-Fi SAR
KDB 941225 D01 3G SAR Procedures
KDB 941225 D05 SAR for LTE Devices
KDB 941225 D06 Hotspot SAR
KDB 648474 D04 Handset SAR

1.5. Ambient Condition

Ambient temperature	20°C – 24°C
Relative Humidity	30% – 70%

1.6. Test Facility

Test Laboratory:

Guangdong Asia Hongke Test Technology Limited

B1/F, Building 11, Junfeng Industrial Park, Chongqing Road, Heping Community, Fuhai Street, Bao'an District, Shenzhen, Guangdong, China

The test facility is recognized, certified or accredited by the following organizations:

FCC-Registration No.: 251906 Designation Number: CN1376

Guangdong Asia Hongke Test Technology Limited has been registered and fully described in a report filed with the (FCC) Federal Communications Commission. The acceptance letter from the FCC is maintained in our files.

IC —Registration No.: 31737 CAB identifier: CN0165

The 3m Semi-anechoic chamber of Guangdong Asia Hongke Test Technology Limited has been registered by Certification and Engineering Bureau of Industry Canada for radio equipment testing with Registration No.: 31737

A2LA-Lab Cert. No.: 7133.01

Guangdong Asia Hongke Test Technology Limited has been accredited by A2LA for technical competence in the field of electrical testing, and proved to be in compliance with ISO/IEC 17025: 2017 General Requirements for the Competence of Testing and Calibration Laboratories and any additional program requirements in the identified field of testing.

2. SAR Measurement System

2.1. SATIMO SAR Measurement Set-up Diagram

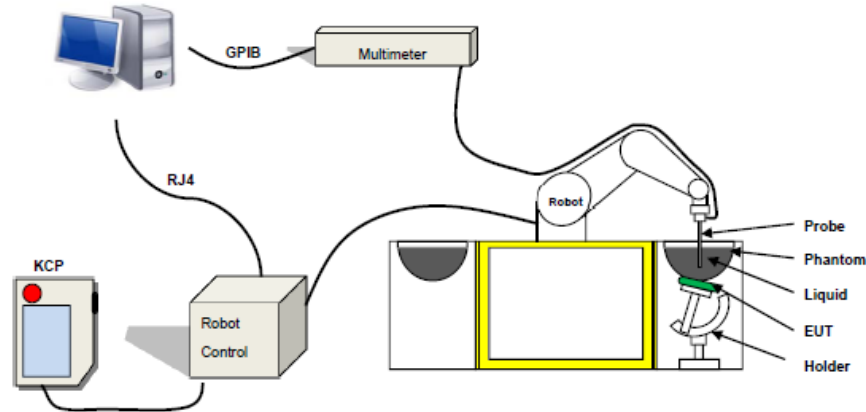

These measurements were performed with the automated near-field scanning system OPENSAR from SATIMO. The system is based on a high precision robot (working range: 901 mm), which positions the probes with a positional repeatability of better than ± 0.03 mm. The SAR measurements were conducted with dosimetric probe (manufactured by SATIMO), designed in the classical triangular configuration and optimized for dosimetric evaluation.

The first step of the field measurement is the evaluation of the voltages induced on the probe by the device under test. Probe diode detectors are nonlinear. Below the diode compression point, the output voltage is proportional to the square of the applied E-field; above the diode compression point, it is linear to the applied E-field. The compression point depends on the diode, and a calibration procedure is necessary for each sensor of the probe.

The Keithley multimeter reads the voltage of each sensor and send these three values to the PC. The corresponding E field value is calculated using the probe calibration factors, which are stored in the working directory. This evaluation includes linearization of the diode characteristics. The field calculation is done separately for each sensor. Each component of the E field is displayed on the "Dipole Area Scan Interface" and the total E field is displayed on the "3D Interface"

2.2. Robot

The SATIMO SAR system uses the high precision robots from KUKA. For the 6-axis controller system, the robot controller version (KUKA) from KUKA is used. The KUKA robot series have many features that are important for our application:



- High precision (repeatability ± 0.03 mm)
- High reliability (industrial design)
- Jerk-free straight movements
- Low ELF interference (the closed metallic construction shields against motor control fields)

2.3. Probe

This E-field detection probe is composed of three orthogonal dipoles linked to special Schottky diodes with low detection thresholds. The probe allows the measurement of electric fields in liquids such as the one defined in the IEEE and CENELEC standards.

For the measurements the Specific Dosimetric E-Field Probe EPGO 0523-403 with following specifications is used.



- Probe Length: 330 mm
- Length of Individual Dipoles: 2 mm
- Maximum external diameter: 8 mm
- Probe Tip External Diameter: 2.5 mm
- Distance between dipole/probe extremity: 1 mm
- Dynamic range: 0.01-100 W/kg
- Probe linearity: 3%
- Axial Isotropy: < 0.10 dB
- Spherical Isotropy: < 0.10 dB
- Calibration range: 150 MHz to 6 GHz for head & body simulating liquid.
- Angle between probe axis (evaluation axis) and surface normal line: less than 30°

2.3.1. E-Field Probe Calibration

Each probe needs to be calibrated according to a dosimetric assessment procedure with accuracy better than $\pm 10\%$. The spherical isotropy shall be evaluated and within $\pm 0.25\text{dB}$. The sensitivity parameters (Norm X, Norm Y, and Norm Z), the diode compression parameter (DCP) and the conversion factor (Conv F) of the probe are tested. The calibration data can be referred to appendix D of this report.

2.4. Phantoms

For the measurements the Specific Anthropomorphic Mannequin (SAM) defined by the IEEE SCC-34/SC2 group is used. The phantom is a polyurethane shell integrated in a wooden table. The thickness of the phantom amounts to 2mm +/- 0.2mm. It enables the dosimetric evaluation of left and right phone usage and includes an additional flat phantom part for the simplified performance check. The phantom set-up includes a cover, which prevents the evaporation of the liquid.



SAM

2.5. Technical Data

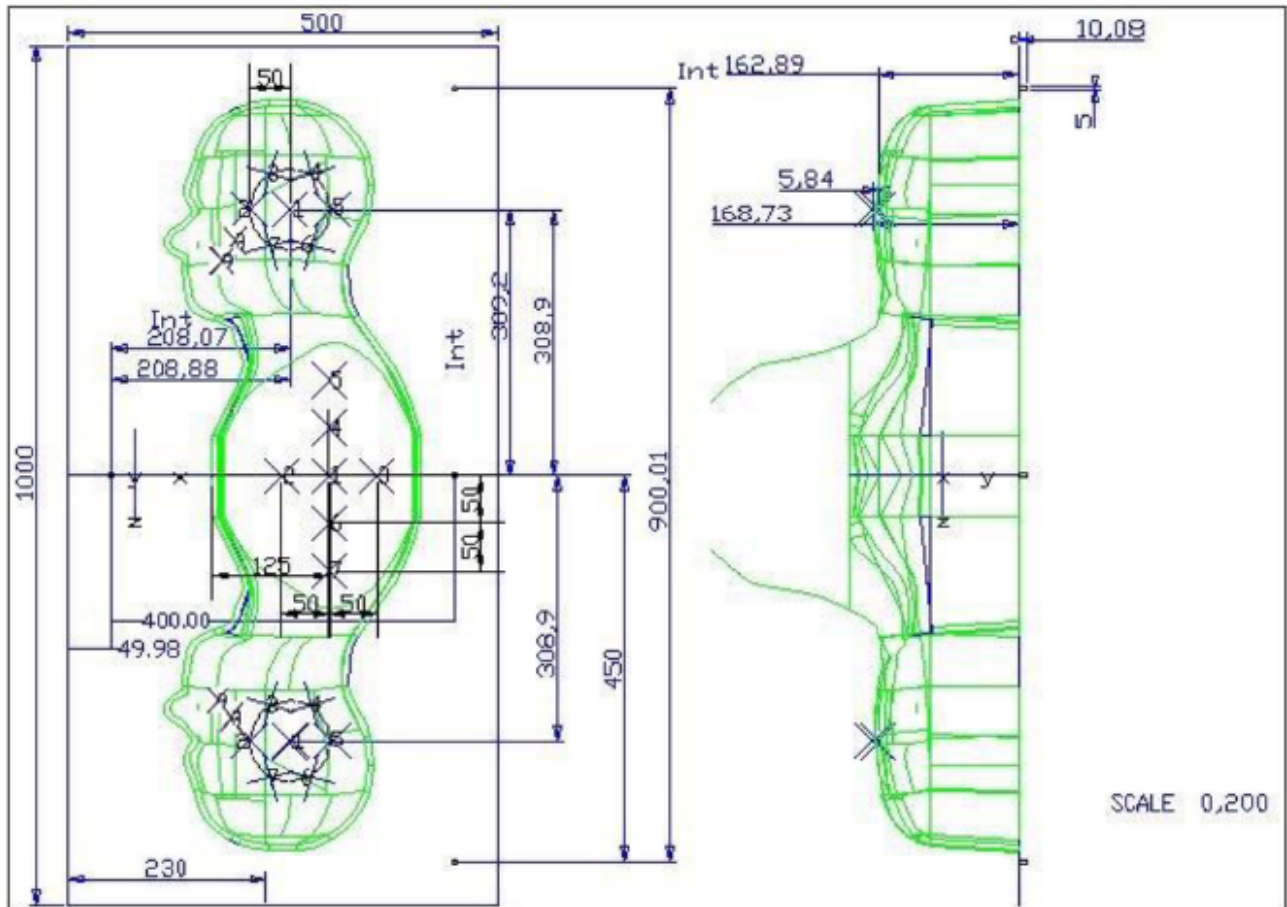

Left Head(mm)		Right Head(mm)		Flat Part(mm)	
2	2.02	2	2.08	1	2.09
3	2.05	3	2.06	2	2.06
4	2.07	4	2.07	3	2.08
5	2.08	5	2.08	4	2.10
6	2.05	6	2.07	5	2.10
7	2.05	7	2.05	6	2.07
8	2.07	8	2.06	7	2.07
9	2.08	9	2.06	-	-

The test, based on ultrasonic system, allows measuring the thickness with an accuracy of 10 µm.

2.6. Device Holder

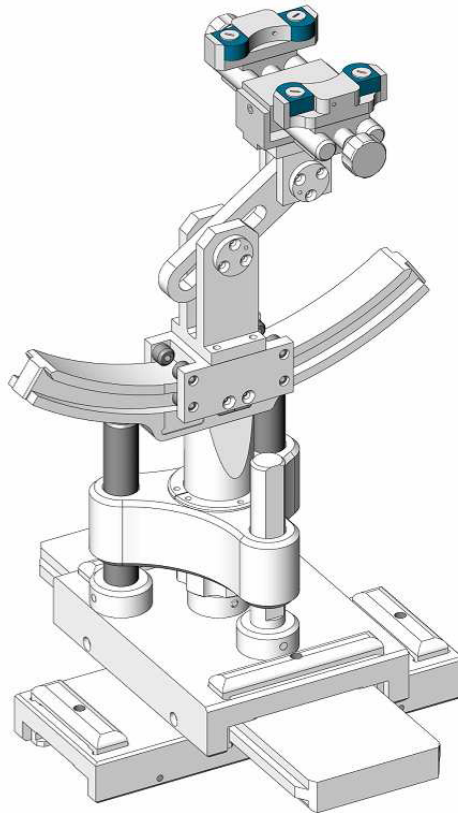

The SAR in the phantom is approximately inversely proportional to the square of the distance between the source and the liquid surface. For a source at 5 mm distance, a positioning uncertainty of ± 0.5 mm would produce a SAR uncertainty of ± 20 %. Accurate device positioning is therefore crucial for accurate and repeatable measurements. The positions in which the devices must be measured are defined by the standards.

2.7. Test Equipment List

This table gives a complete overview of the SAR measurement equipment.

Devices used during the test described are marked

	Manufacturer	Name of Equipment	Type/Model	Serial Number	Calibration	
					Last Cal.	Due Date
<input checked="" type="checkbox"/>	MVG	E FIELD PROBE	SSE2	EPGO 0523-403	Sep. 11, 2024	Sep. 10, 2025
<input type="checkbox"/>	MVG	750 MHz Dipole	SID750	SN 03/15 DIP 0G750-355	Feb. 21, 2024	Feb. 20, 2027
<input checked="" type="checkbox"/>	MVG	835 MHz Dipole	SID835	SN 03/15 DIP 0G835-347	Feb. 21, 2024	Feb. 20, 2027
<input type="checkbox"/>	MVG	900 MHz Dipole	SID900	SN 03/15 DI P 0G900-348	Feb. 21, 2024	Feb. 20, 2027
<input checked="" type="checkbox"/>	MVG	1800 MHz Dipole	SID1800	SN 03/15 DIP 1G800-349	Feb. 21, 2024	Feb. 20, 2027
<input checked="" type="checkbox"/>	MVG	1900 MHz Dipole	SID1900	SN 03/15 DIP 1G900-350	Feb. 21, 2024	Feb. 20, 2027
<input type="checkbox"/>	MVG	2000 MHz Dipole	SID2000	SN 03/15 DIP 2G000-351	Feb. 21, 2024	Feb. 20, 2027
<input type="checkbox"/>	MVG	2300 MHz Dipole	SID2300	SN 03/16 DIP 2G300-358	Feb. 21, 2024	Feb. 20, 2027
<input checked="" type="checkbox"/>	MVG	2450 MHz Dipole	SID2450	SN 03/15 DIP 2G450-352	Feb. 21, 2024	Feb. 20, 2027
<input checked="" type="checkbox"/>	MVG	2600 MHz Dipole	SID2600	SN 03/15 DIP 2G600-356	Feb. 21, 2024	Feb. 20, 2027
<input checked="" type="checkbox"/>	MVG	5000 MHz Dipole	SWG5500	SN 13/14 WGA 33	Feb. 21, 2024	Feb. 20, 2027
<input checked="" type="checkbox"/>	MVG	Liquid measurement Kit	SCLMP	SN 21/15 OCPG 72	Jul. 01, 2024	Jun. 30, 2025
<input checked="" type="checkbox"/>	MVG	Power Amplifier	N.A	AMPLISAR_28/14_003	NCR	NCR
<input checked="" type="checkbox"/>	KEITHLEY	Millivoltmeter	2000	4072790	Jul. 01, 2024	Jun. 30, 2025
<input checked="" type="checkbox"/>	R&S	Universal radio communication tester	CMU200	117858	Jul. 01, 2024	Jun. 30, 2025
<input checked="" type="checkbox"/>	R&S	Wideband radio communication tester	CMW500	116581	Jul. 01, 2024	Jun. 30, 2025
<input checked="" type="checkbox"/>	HP	Network Analyzer	8753D	3410J01136	Jul. 01, 2024	Jun. 30, 2025

<input checked="" type="checkbox"/>	Agilent	PSG Analog Signal Generator	E8257D	MY51110112	Jul. 01, 2024	Jun. 30, 2025
<input checked="" type="checkbox"/>	Agilent	Power meter	E4419B	MY45102538	Jul. 01, 2024	Jun. 30, 2025
<input checked="" type="checkbox"/>	Agilent	Power meter	E4419B	MY45102140	Jul. 01, 2024	Jun. 30, 2025
<input checked="" type="checkbox"/>	Agilent	Power meter	E4419B	MY45102215	Jul. 01, 2024	Jun. 30, 2025
<input checked="" type="checkbox"/>	JFW	attenuator	50FPE-006	4360846-494-4	Jul. 01, 2024	Jun. 30, 2025
<input checked="" type="checkbox"/>	JFW	attenuator	50FPE-006	4360846-492-1	Jul. 01, 2024	Jun. 30, 2025
<input checked="" type="checkbox"/>	JFW	attenuator	50FPE-006	4360846-490-6	Jul. 01, 2024	Jun. 30, 2025
<input checked="" type="checkbox"/>	Agilent	Power sensor	E9301A	MY41495644	Jul. 01, 2024	Jun. 30, 2025
<input checked="" type="checkbox"/>	Agilent	Power sensor	E9301A	US39212148	Jul. 01, 2024	Jun. 30, 2025
<input checked="" type="checkbox"/>	MCLI/USA	Directional Coupler	CB11-20	0D2L51502	Jul. 17, 2024	Jul. 16, 2027
<input checked="" type="checkbox"/>	MVG	SAR Phantom	SSM2	SN 24/11 SAM87	NCR	NCR
<input checked="" type="checkbox"/>	MVG	Device Holder	SMPPD	SN 24/11 MSH73	NCR	NCR

3. SAR Measurement Procedures

The measurement procedures are as follows:

<Conducted power measurement>

- (a) For WWAN power measurement, use base station simulator to configure EUT WWAN transmission in conducted connection with RF cable, at maximum power in each supported wireless interface and frequency band.
- (b) Read the WWAN RF power level from the base station simulator.
- (c) For Wi-Fi/BT power measurement, use engineering software to configure EUT Wi-Fi/BT continuously transmission, at maximum RF power in each supported wireless interface and frequency band.
- (d) Connect EUT RF port through RF cable to the power meter, and measure Wi-Fi/BT output power.

<SAR measurement>

- (a) Use base station simulator to configure EUT WWAN transmission in radiated connection, and engineering software to configure EUT Wi-Fi/BT continuously transmission, at maximum RF power, in the highest power channel.
- (b) Place the EUT in the positions as Appendix A demonstrates.
- (c) Set scan area, grid size and other setting on the OPENSAR software.
- (d) Measure SAR results for the highest power channel on each testing position.
- (e) Find out the largest SAR result on these testing positions of each band.
- (f) Measure SAR results for other channels in worst SAR testing position if the reported SAR of highest power channel is larger than 0.8 W/kg.

According to the test standard, the recommended procedure for assessing the peak spatial-average SAR value consists of the following steps:

- (a) Power reference measurement
- (b) Area scan
- (c) Zoom scan
- (d) Power drift measurement

3.1. Power Reference

The Power Reference Measurement and Power Drift Measurements are for monitoring the power drift of the device under test in the batch process. The minimum distance of probe sensors to surface determines the closest measurement point to phantom surface. This distance cannot be smaller than the distance of sensor calibration points to probe tip as defined in the probe properties.

3.2. Area scan & Zoom scan

The area scan is a 2D scan to find the hot spot location on the DUT. The zoom scan is a 3D scan

above the hot spot to calculate the 1g and 10g SAR value.

Measurement of the SAR distribution with a grid of 8 to 16 mm * 8 to 16 mm and a constant distance to the inner surface of the phantom. Since the sensors cannot directly measure at the inner phantom surface, the values between the sensors and the inner phantom surface are extrapolated. With these values the area of the maximum SAR is calculated by an interpolation scheme. Around this point, a cube of 30 * 30 * 30 mm or 32 * 32 * 32 mm is assessed by measuring 5 or 8 * 5 or 8 * 4 or 5 mm. With these data, the peak spatial-average SAR value can be calculated.

From the scanned SAR distribution, identify the position of the maximum SAR value, in addition identify the positions of any local maxima with SAR values within 2 dB of the maximum value that will not be within the zoom scan of other peaks; additional peaks shall be measured only when the primary peak is within 2 dB of the SAR compliance limit (e.g., 1 W/kg for 1,6 W/kg 1 g limit, or 1,26 W/kg for 2 W/kg, 10 g limit).

Area scan & Zoom scan scan parameters extracted from FCC KDB 865664 D01 SAR measurement 100 MHz to 6 GHz.

		≤ 3 GHz	> 3 GHz
Maximum distance from closest measurement point (geometric center of probe sensors) to phantom surface		5 ± 1 mm	$\frac{1}{2} \cdot \delta \cdot \ln(2) \pm 0.5$ mm
Maximum probe angle from probe axis to phantom surface normal at the measurement location		30° ± 1°	20° ± 1°
Maximum area scan spatial resolution: Δx_{Area} , Δy_{Area}		≤ 2 GHz: ≤ 15 mm 2 – 3 GHz: ≤ 12 mm	3 – 4 GHz: ≤ 12 mm 4 – 6 GHz: ≤ 10 mm
		When the x or y dimension of the test device, in the measurement plane orientation, is smaller than the above, the measurement resolution must be ≤ the corresponding x or y dimension of the test device with at least one measurement point on the test device.	
Maximum zoom scan spatial resolution: Δx_{Zoom} , Δy_{Zoom}		≤ 2 GHz: ≤ 8 mm 2 – 3 GHz: ≤ 5 mm*	3 – 4 GHz: ≤ 5 mm* 4 – 6 GHz: ≤ 4 mm*
Maximum zoom scan spatial resolution, normal to phantom surface	uniform grid: $\Delta z_{Zoom}(n)$	≤ 5 mm	3 – 4 GHz: ≤ 4 mm 4 – 5 GHz: ≤ 3 mm 5 – 6 GHz: ≤ 2 mm
	graded grid	$\Delta z_{Zoom}(1)$: between 1 st two points closest to phantom surface	≤ 4 mm 3 – 4 GHz: ≤ 3 mm 4 – 5 GHz: ≤ 2.5 mm 5 – 6 GHz: ≤ 2 mm
		$\Delta z_{Zoom}(n>1)$: between subsequent points	≤ 1.5 · $\Delta z_{Zoom}(n-1)$
Minimum zoom scan volume	x, y, z	≥ 30 mm	3 – 4 GHz: ≥ 28 mm 4 – 5 GHz: ≥ 25 mm 5 – 6 GHz: ≥ 22 mm
Note: δ is the penetration depth of a plane-wave at normal incidence to the tissue medium; see draft standard IEEE P1528-2011 for details. * When zoom scan is required and the <i>reported</i> SAR from the <i>area scan based 1-g SAR estimation</i> procedures of KDB 447498 is ≤ 1.4 W/kg, ≤ 8 mm, ≤ 7 mm and ≤ 5 mm zoom scan resolution may be applied, respectively, for 2 GHz to 3 GHz, 3 GHz to 4 GHz and 4 GHz to 6 GHz.			

3.3. Description of interpolation/extrapolation scheme

The local SAR inside the phantom is measured using small dipole sensing elements inside a probe body. The probe tip must not be in contact with the phantom surface in order to minimise measurements errors, but the highest local SAR will occur at the surface of the phantom.

An extrapolation is used to determine these highest local SAR values. The extrapolation is based on a fourth-order least-square polynomial fit of measured data. The local SAR value is then extrapolated from the liquid surface with a 1 mm step.

The measurements have to be performed over a limited time (due to the duration of the battery) so the step of measurement is high. It could vary between 5 and 8 mm. To obtain an accurate assessment of the maximum SAR averaged over 10 grams and 1 gram requires a very fine resolution in the three dimensional scanned data array.

3.4. Volumetric Scan

The volumetric scan consists of a full 3D scan over a specific area. This 3D scan is useful for multi Tx SAR measurement. Indeed, it is possible with OpenSAR to add, point by point, several volumetric scans to calculate the SAR value of the combined measurement as it is defined in the standard IEEE1528 and IEC62209.

3.5. Power Drift

All SAR testing is under the EUT installed with a full charged battery and transmit maximum output power. In OpenSAR measurement software, the power reference measurement and power drift measurement procedures are used for monitoring the power drift of EUT during SAR test. Both these procedures measure the field at a specified reference position before and after the SAR testing. The software will calculate the field difference in V/m. If the power drifts more than $\pm 5\%$, the SAR will be retested.

4. System Verification Procedure

4.1. Tissue Verification

The following tissue formulations are provided for reference only as some of the parameters have not been thoroughly verified. The composition of ingredients may be modified accordingly to achieve the desired target tissue parameters required for routine SAR evaluation.

Ingredients (% of weight)	Head Tissue									
	750	835	900	1800	1900	2000	2450	2600	5200	5800
Frequency Band (MHz)	750	835	900	1800	1900	2000	2450	2600	5200	5800
Water	34.40	34.40	34.40	55.36	55.36	57.87	57.87	57.87	65.53	65.53
NaCl	0.79	0.79	0.79	0.35	0.35	0.16	0.16	0.16	0.00	0.00
1,2-Propanediol	64.81	64.81	64.81	0.00	0.00	0.00	0.00	0.00	0.00	0.00
Triton X-100	0.00	0.00	0.00	30.45	30.45	19.97	19.97	19.97	24.24	24.24
DGBE	0.00	0.00	0.00	13.84	13.84	22.00	22.00	22.00	10.23	10.23

For SAR measurement of the field distribution inside the phantom, the phantom must be filled with homogeneous tissue simulating liquid to a depth of at least 15 cm. For head SAR testing, the liquid depth from the ear reference point (ERP) of the phantom to the liquid top surface is larger than 15 cm.



4.1.1. Tissue Dielectric Parameter Check Results

The simulating liquids should be checked at the beginning of a series of SAR measurements to determine if the dielectric parameter are within the tolerances of the specified target values. The measured conductivity and relative permittivity should be within $\pm 5\%$ of the target values.

Tissue Type	Measured Frequency (MHz)	Target Tissue		Measured Tissue		Liquid Temp.	Test Date
		ϵ_r ($\pm 5\%$)	σ (S/m) ($\pm 5\%$)	ϵ_r	σ (S/m)		
Head 850	835	41.50 (39.43~43.58)	0.90 (0.86~0.95)	42.01	0.94	21.4 °C	Apr. 25, 2025
Head 1800	1800	40.00 (38.00~42.00)	1.40 (1.33~1.47)	39.61	1.41	21.2 °C	Apr. 28, 2025
Head 1900	1900	40.00 (38.00~42.00)	1.40 (1.33~1.47)	41.42	1.39	21.3 °C	Apr. 29, 2025
Head 2450	2450	39.20 (37.24~41.16)	1.80 (1.71~1.89)	40.41	1.82	21.4 °C	Apr. 30, 2025
Head 2600	2600	39.01 (37.06~40.96)	1.96 (1.86~2.06)	39.43	1.99	21.6 °C	May 01, 2025
Head 5200	5200	36.00 (34.20~37.80)	4.66 (4.43~4.89)	37.40	4.51	21.7 °C	May 02, 2025
Head 5800	5800	35.30 (33.54~37.07)	5.27 (5.01~5.53)	35.30	5.27	21.0 °C	May 05, 2025

NOTE: The dielectric parameters of the tissue-equivalent liquid should be measured under similar ambient conditions and within 2 °C of the conditions expected during the SAR evaluation to satisfy protocol requirements.

4.2. System Verification Procedure

The system verification is performed for verifying the accuracy of the complete measurement system and performance of the software. The dipole is connected to the signal source consisting of signal generator and amplifier via a directional coupler, N-connector cable and adaption to SMA. It is fed with a power of 100mW (below 5GHz) or 100mW (above 5GHz). To adjust this power a power meter is used. The power sensor is connected to the cable before the system verification to measure the power at this point and do adjustments at the signal generator. At the outputs of the directional coupler both return loss as well as forward power are controlled during the system verification to make sure that emitted power at the dipole is kept constant. This can also be checked by the power drift measurement after the test (result on plot).

The system verification is shown as below picture:

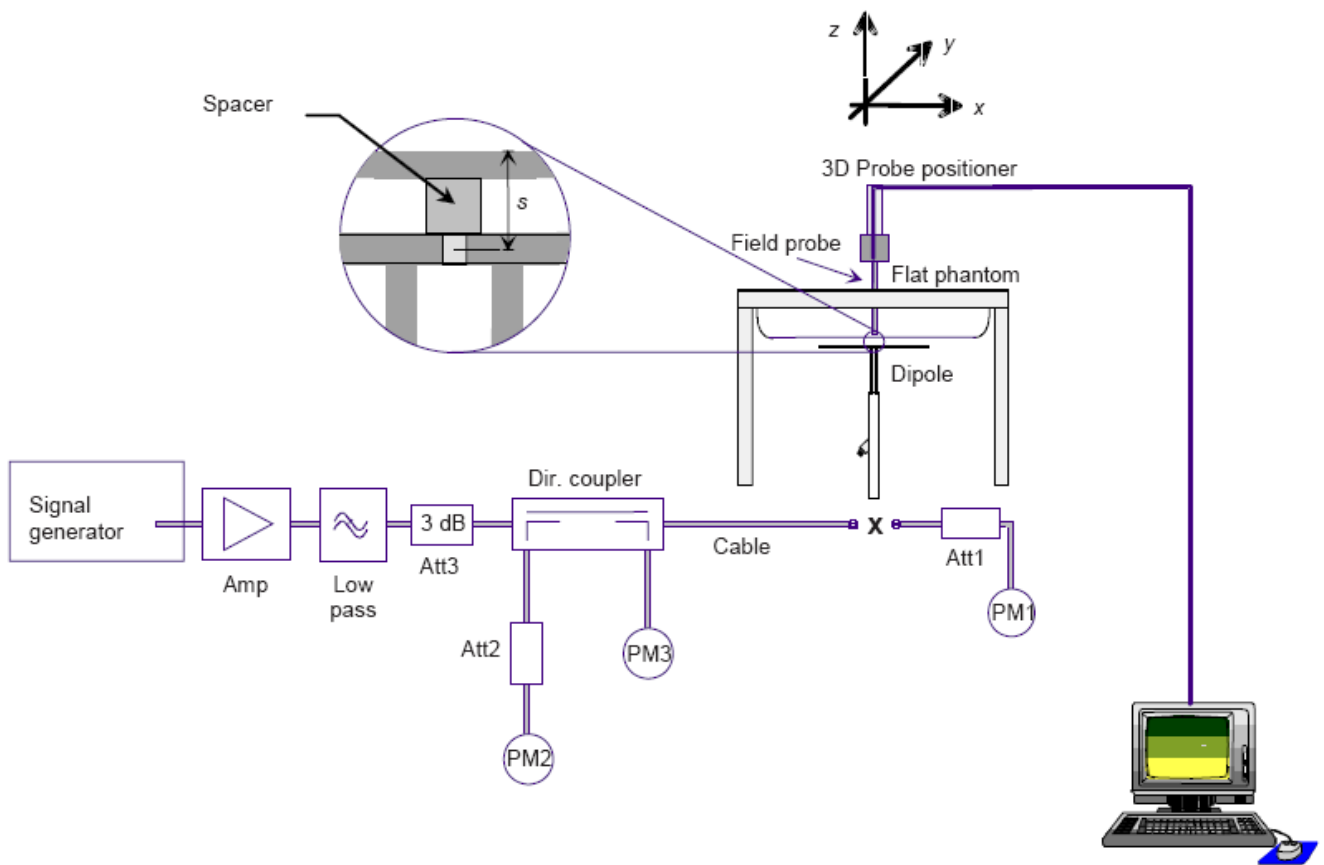

4.2.1. System Verification Results

Comparing to the original SAR value provided by SATIMO, the verification data should be within its specification of $\pm 10\%$. Below table shows the target SAR and measured SAR after normalized to 1W input power. The table below indicates the system performance verification can meet the variation criterion and the plots can be referred to Appendix B of this report.

System Verification	Power fed to reference dipole (mW)	Measured SAR Value		Measured SAR (Normalized to 1W)		Target SAR Value (1W)		Deviation (%)		Test Date
		1-g (W/Kg)	10-g (W/Kg)	1-g (W/Kg)	10-g (W/Kg)	1-g (W/Kg)	10-g (W/Kg)	1-g (W/Kg)	10-g (W/Kg)	
835MHz	100	1.011	0.612	10.11	6.12	9.40	6.28	7.55%	-2.55%	Apr. 25, 2025
1800MHz	100	3.832	2.025	38.32	20.25	37.06	20.01	3.40%	1.20%	Apr. 28, 2025
1900MHz	100	4.154	2.153	41.54	21.53	39.69	20.92	4.66%	2.92%	Apr. 29, 2025
2450MHz	100	5.184	2.359	51.84	23.59	50.05	23.80	3.58%	-0.88%	Apr. 30, 2025
2600MHz	100	5.433	2.523	54.33	25.23	54.16	24.85	0.31%	1.53%	May 01, 2025
5200MHz	100	14.712	5.212	147.12	52.12	162.59	56.21	-9.51%	-7.28%	May 02, 2025
5800MHz	100	16.421	5.623	164.21	56.23	182.2	61.32	-9.87%	-8.30%	May 05, 2025

5. SAR measurement variability

Per KDB865664 D01 SAR measurement 100 MHz to 6 GHz, SAR measurement variability must be assessed for each frequency band, which is determined by the SAR probe calibration point and tissue-equivalent medium used for the device measurements. The additional measurements are repeated after the completion of all measurements requiring the same head or body tissue-equivalent medium in a frequency band. The test device should be returned to ambient conditions (normal room temperature) with the battery fully charged before it is re-mounted on the device holder for the repeated measurement(s) to minimize any unexpected variations in the repeated results.

1) Repeated measurement is not required when the original highest measured SAR is < 0.80 W/kg; steps 2) through 4) do not apply.

2) When the original highest measured SAR is ≥ 0.80 W/kg, repeat that measurement once.

3) Perform a second repeated measurement only if the ratio of largest to smallest SAR for the original and first repeated measurements is > 1.20 or when the original or repeated measurement is ≥ 1.45 W/kg (~ 10% from the 1-g SAR limit).

4) Perform a third repeated measurement only if the original, first or second repeated measurement is ≥ 1.5 W/kg and the ratio of largest to smallest SAR for the original, first and second repeated measurements is > 1.20 .

6. SAR Measurement Uncertainty

Per KDB865664 D01 SAR Measurement 100 MHz to 6 GHz, when the highest measured 1-g SAR within a frequency band is < 1.5 W/kg, the extensive SAR measurement uncertainty analysis described in IEEE Std 1528-2013 is not required in SAR reports submitted for equipment approval. The equivalent ratio (1.5/1.6) is applied to extremity and occupational exposure conditions.

7. RF Exposure Positions

7.1. Ear and handset reference point

Figure 7.1.1 shows the front, back, and side views of the SAM phantom. The center-of-mouth reference point is labeled “M”, the left ear reference point (ERP) is marked “LE”, and the right ERP is marked “RE”.



Fig 7.1.1 Front, back, and side views of SAM phantom

7.2. Definition of the cheek position

1. Define two imaginary lines on the handset, the vertical centerline and the horizontal line. The vertical centerline passes through two points on the front side of the handset: the midpoint of the width w_t of the handset at the level of the acoustic output (point A in Figure 7.2.1 and Figure 7.2.2), and the midpoint of the width w_b of the bottom of the handset (point B). The horizontal line is perpendicular to the vertical centerline and passes through the center of the acoustic output (see Figure 7.2.1). The two lines intersect at point A. Note that for many handsets, point A coincides with the center of the acoustic output; however, the acoustic output may be located elsewhere on the horizontal line. Also note that the vertical centerline is not necessarily parallel to the front face of the handset (see Figure 7.2.2), especially for clamshell handsets, handsets with flip covers, and other irregularly-shaped handsets.
2. Position the handset close to the surface of the phantom such that point A is on the (virtual) extension of the line passing through points RE and LE on the phantom (see Figure 7.2.3), such that the plane defined by the vertical centerline and the horizontal line of the handset is approximately parallel to the sagittal plane of the phantom.
3. Translate the handset towards the phantom along the line passing through RE and LE until handset point A touches the pinna at the ERP
4. While maintaining the handset in this plane, rotate it around the LE-RE line until the vertical centerline is in the plane normal to the plane containing B-M and N-F lines, i.e., the Reference Plane.
5. Rotate the handset around the vertical centerline until the handset (horizontal line) is parallel to the N-F line.
6. While maintaining the vertical centerline in the Reference Plane, keeping point A on the line

passing through RE and LE, and maintaining the handset contact with the pinna, rotate the handset about the N-F line until any point on the handset is in contact with a phantom point below the pinna on the cheek. See Figure 7.2.3. The actual rotation angles should be documented in the test report.

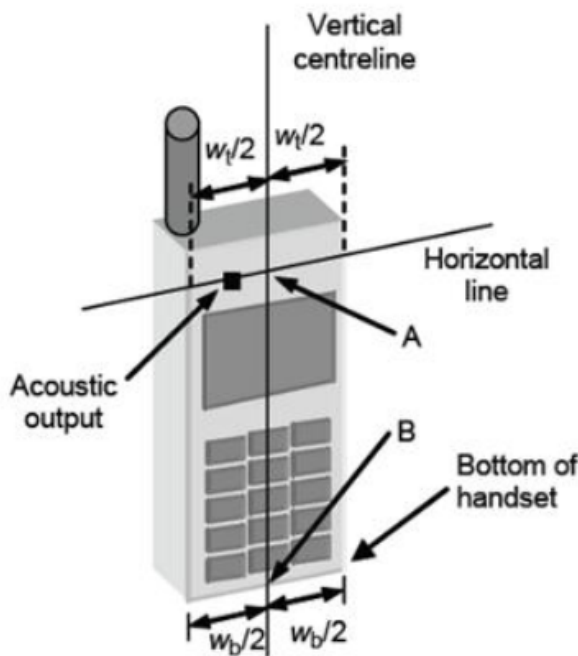

Fig 7.2.1 Handset vertical and horizontal reference lines—fixed case

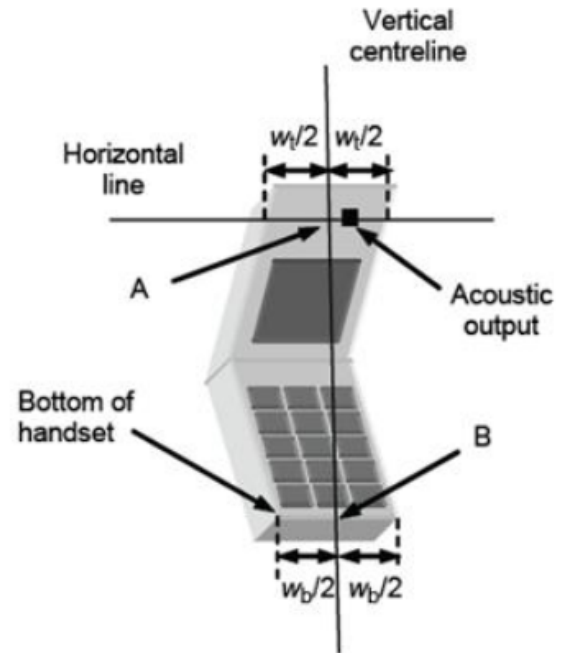

Fig 7.2.2 Handset vertical and horizontal reference lines—“clam-shell case”

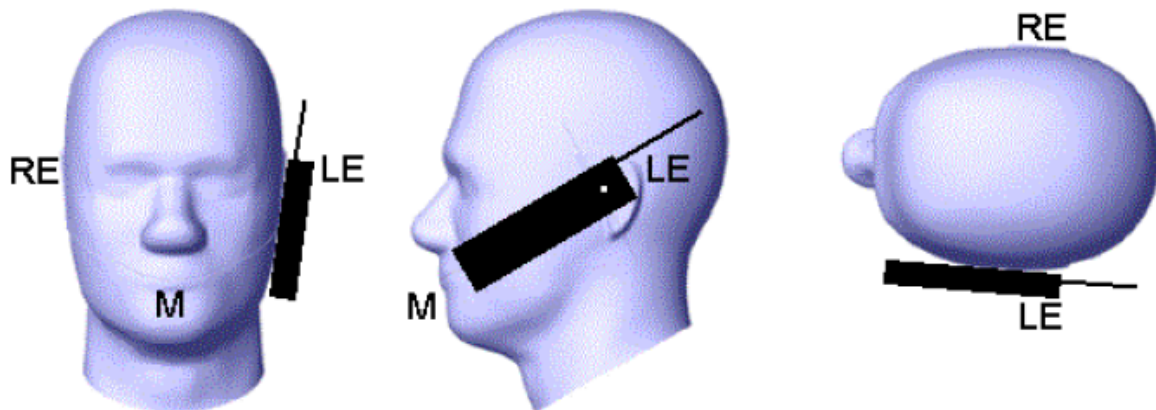

Fig 7.2.3 cheek or touch position. The reference points for the right ear (RE), left ear (LE), and mouth (M), which establish the Reference Plane for handset positioning, are indicated.

7.3. Definition of the tilt position

1. While maintaining the orientation of the handset, retract the handset parallel to the reference plane far enough away from the phantom to enable a rotation of the device by 15 degree.
2. Rotate the Handset around the horizontal line by 15 degree (see Figure 7.3.1).
3. While maintaining the orientation of the handset, move the handset towards the phantom on a line passing through RE and LE until any part of the handset touches the ear. The tilt position is obtained when the contact is on the pinna. If the contact is at any location other than the pinna, e.g., the antenna with the back of the phantom head, the angle of the handset shall be reduced. In this case, the tilt position is obtained if any part of the handset is in contact with the pinna as well as a second part of the handset is in contact with the phantom, e.g., the antenna with the back of the head.

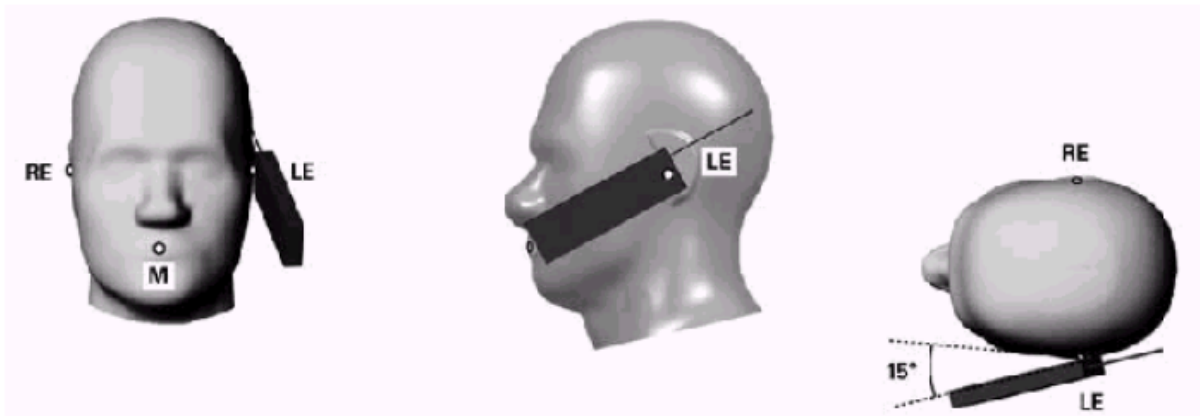

Figure 7.3.1 – Tilt position of the wireless device on the left side of SAM

7.4. Body Worn Accessory

1. Body-worn operating configurations are tested with the belt-clips and holsters attached to the device and positioned against a flat phantom in a normal use configuration (see Figure 7.4.1). Per KDB 648474 D04, body-worn accessory exposure is typically related to voice mode operations when handsets are carried in body-worn accessories. The body-worn accessory procedures in FCC KDB 447498 D01 should be used to test for body-worn accessory SAR compliance, without a headset connected to it. This enables the test results for such configuration to be compatible with that required for hotspot mode when the body-worn accessory test separation distance is greater than or equal to that required for hotspot mode, when applicable. When the reported SAR for body-worn accessory, measured without a headset connected to the handset is $< 1.2 \text{ W/kg}$, the highest reported SAR configuration for that wireless mode and frequency band should be repeated for that body-worn accessory with a headset attached to the handset.
2. Accessories for body-worn operation configurations are divided into two categories: those that do

not contain metallic components and those that do contain metallic components and those that do contain metallic components. When multiple accessories that do not contain metallic components are supplied with the device, the device is tested with only the accessory that dictates the closest spacing to the body. Then multiple accessories that contain metallic components are test with the device with each accessory. If multiple accessories share an identical metallic component (i.e. the same metallic belt-chip used with different holsters with no other metallic components) only the accessory that dictates the closest spacing to the body is tested.

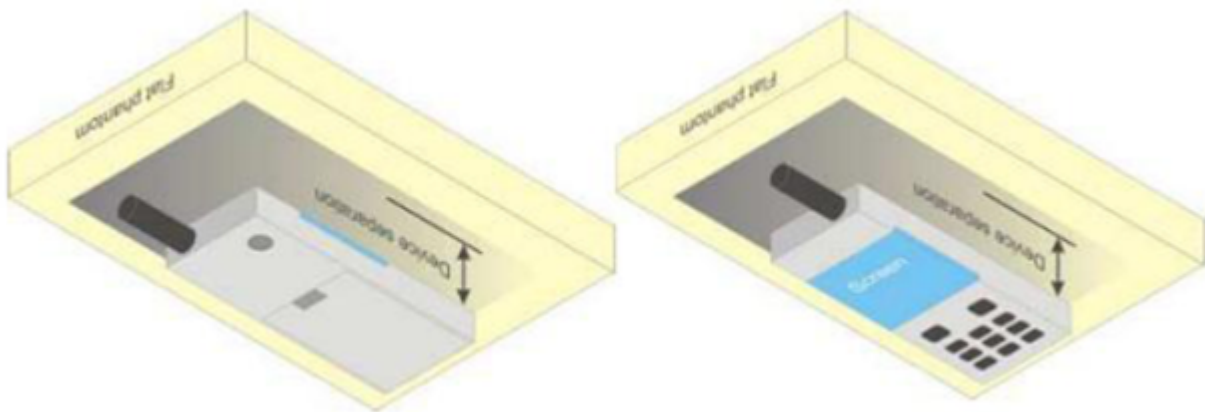

Figure 7.4.1 – Test positions for body-worn devices

7.5. Wireless Router Devices

Some battery-operated handsets have the capability to transmit and receive user through simultaneous transmission of WLAN simultaneously with a separate licensed transmitter. The FCC has provided guidance in FCC KDB Publication 941225 D06 where SAR test considerations for handsets ($L \times W \geq 9 \text{ cm} \times 5 \text{ cm}$) are based on a composite test separation distance of 10mm from the front, back and edges of the device containing transmitting antennas within 2.5cm of their edges, determined from general mixed use conditions for this type of devices. Since the hotspot SAR results may overlap with the body-worn accessory SAR requirements, the more conservative configurations can be considered, thus excluding some body-worn accessory SAR tests.

When the user enables the personal wireless router functions for the handset, actual operations include simultaneous transmission of both the WLAN transmitter and another licensed transmitter. Both transmitters often do not transmit at the same transmitting frequency and thus cannot be evaluated for SAR under actual use conditions due to the limitations of the SAR assessment probes. Therefore, SAR must be evaluated for each frequency transmission and mode separately and spatially summed with the WLAN transmitter according to FCC KDB Publication 447498 D01 publication procedures. The —Portable Hotspot! feature on the handset was NOT activated during SAR assessments, to ensure the SAR measurements were evaluated for a single transmission frequency RF signal at a time.

8. RF Output Power

8.1. GSM Conducted Power

Band GSM850		Burst-Averaged output Power (dBm)				Factor	Frame-Averaged output Power (dBm)			
Tx Channel	Tune-up (dBm)	128	189	251	Tune-up		128	189	251	
Frequency (MHz)		824.2	836.4	848.8		824.2	836.4	848.8		
GSM (GMSK)	34.00	33.44	33.55	33.52	/	/	/	/	/	
GPRS(GMSK,1 Tx slot)	34.00	33.47	33.58	33.52	-9.03	24.97	24.44	24.55	24.49	
GPRS(GMSK,2 Tx slot)	31.50	31.44	31.41	31.34	-6.02	25.48	25.42	25.39	25.32	
GPRS(GMSK,3 Tx slot)	29.50	29.41	29.37	29.30	-4.26	25.24	25.15	25.11	25.04	
GPRS(GMSK,4 Tx slot)	27.50	27.27	27.31	27.24	-3.01	24.49	24.26	24.30	24.23	
GPRS(EDGE,1 Tx slot)	27.50	26.34	26.65	27.25	-9.03	18.47	17.31	17.62	18.22	
GPRS(EDGE,2 Tx slot)	26/28/26	25.34	27.44	25.81	-6.02	19.98/21.98/ 19.98	19.32	21.42	19.79	
GPRS(EDGE,3 Tx slot)	24.00	23.62	23.27	23.95	-4.26	19.74	19.36	19.01	19.69	
GPRS(EDGE,4 Tx slot)	22.50	22.31	21.46	21.66	-3.01	19.49	19.30	18.45	18.65	

Band GSM1900		Burst-Averaged output Power (dBm)				Factor	Frame-Averaged output Power (dBm)			
Tx Channel	Tune-up (dBm)	512	661	810	Tune-up		512	661	810	
Frequency (MHz)		1850.2	1880	1909.8		1850.2	1880	1909.8		
GSM (GMSK)	30.50	30.16	30.06	30.26	/	/	/	/	/	
GPRS(GMSK,1 Tx slot)	30.50	30.17	30.03	30.20	-9.03	21.47	21.14	21.00	21.17	
GPRS(GMSK,2 Tx slot)	28.00	27.81	27.52	27.55	-6.02	21.98	21.79	21.50	21.53	
GPRS(GMSK,3 Tx slot)	26.50	26.15	25.95	25.94	-4.26	22.24	21.89	21.69	21.68	
GPRS(GMSK,4 Tx slot)	24.50	24.08	23.78	23.84	-3.01	21.49	21.07	20.77	20.83	
GPRS(EDGE,1 Tx slot)	27.00	26.71	26.84	26.32	-9.03	17.97	17.68	17.81	17.29	
GPRS(EDGE,2 Tx slot)	25.50	25.01	25.04	24.98	-6.02	19.48	18.99	19.02	18.96	
GPRS(EDGE,3 Tx slot)	22.50	22.39	22.19	22.13	-4.26	18.24	18.13	17.93	17.87	
GPRS(EDGE,4 Tx slot)	20.50	20.44	20.38	20.40	-3.01	17.49	17.43	17.37	17.39	

Note:

Remark: GPRS, CS4 coding scheme. EGPRS, MCS5 coding scheme.

Multi-Slot Class 8, Support Max 4 downlink, 1 uplink, 5 working link

Multi-Slot Class 10, Support Max 4 downlink, 2 uplink, 5 working link

Multi-Slot Class 12, Support Max 4 downlink, 4 uplink, 5 working link

SAR testing was performed on the maximum frame-averaged power mode.

The frame-averaged power is linearly proportion to the slot number configured and it is linearly scaled the maximum

Burst-averaged power based on time slots. The calculated method is shown as below:

Frame-averaged power = Burst averaged power (1 TX Slot) – 9.03 dB

Frame-averaged power = Burst averaged power (2 TX Slots) – 6.02 dB

Frame-averaged power = Burst averaged power (3 TX Slots) - 4.26 dB

Frame-averaged power = Burst averaged power (4 TX Slots) – 3.01 dB

8.2. WCDMA Conducted Power

The following tests were conducted according to the test requirements outlines in 3GPP TS 34.121 specification. A summary of these settings are illustrated below:

1. Release99 Setup Configuration

Mode	Subtest	Rel99
WCDMA General Settings	Loopback Mode	Test Mode 1
	Rel99 RMC	12.2kbps RMC
	Power Control Algorithm	Algorithm1
	β_c/β_d	8/15

2. HSDPA Setup Configuration

	Mode	HSDPA	HSDPA	HSDPA	HSDPA
	Subtest	1	2	3	4
WCDMA General Settings	Loopback Mode	Test Mode 1			
	Rel99 RMC	12.2kbps RMC			
	HSDPA FRC	H-Set1			
	Power Control Algorithm	Algorithm 2			
	β_c	2/15	12/15	15/15	15/15
	β_d	15/15	15/15	8/15	4/15
	Bd (SF)	64			
	β_c/β_d	2/15	12/15	15/8	15/4
	β_{hs}	4/15	24/15	30/15	30/15
HSDPA Specific Settings	D_{ACK}	8			
	D_{NAK}	8			
	DCQI	8			
	Ack-Nack repetition factor	3			
	CQI Feedback (Table 5.2B.4)	4ms			
	CQI Repetition Factor (Table 5.2B.4)	2			
	$A_{hs} = \beta_{hs}/\beta_c$	30/15			

3. HSUPA Setup Configuration

	Mode	HSUPA	HSUPA	HSUPA	HSUPA	HSUPA
	Subtest	1	2	3	4	5
WCDMA General Settings	Loopback Mode	Test Mode 1				
	Rel99 RMC	12.2kbps RMC				
	HSDPA FRC	H-Set1				
	HSUPA Test	HSUPA Loopback				
	Power Control Algorithm	Algorithm1				
	β_c	11/15	6/15	15/15	2/15	15/15
	β_d	15/15	15/15	9/15	15/15	15/15
	β_{ec}	209/225	12/15	30/15	2/15	24/15
	β_c/β_d	11/15	6/15	15/9	2/15	15/15
	β_{hs}	22/15	12/15	30/15	4/15	30/15
	β_{ed}	1309/225	94/75	47/15 47/15	56/75	134/15
	CM (dB)	1.0	3.0	2.0	3.0	1.0
HSDPA Specific Settings	D_{ACK}	8				
	D_{NAK}	8				
	DCQI	8				
	Ack-Nack repetition factor	3				
	CQI Feedback (Table 5.2B.4)	4ms				

HSUPA Specific Settings	CQI Repetition Factor (Table 5.2B.4)	2				
	Ahs = β hs/ β c	30/15				
	D E-DPCCH	6	8	8	5	7
	DHARQ	0	0	0	0	0
	AG Index	20	12	15	17	21
	ETFCI (from 34.121 Table C.11.1.3)	75	67	92	71	81
Associated Max UL Data Rate kbps	242.1	174.9	482.8	205.8	308.9	

4. WCDMA Conducted Power Results

Choose the highest output power mode RMC 12.2Kbps for Band VIII/I at middle channel to test SAR and determine the worst configuration for further high/low channel test.

WCDMA Band II	Burst-Averaged output Power (dBm)			
Tx Channel	Tune-up (dBm)	9262	9400	9538
Frequency (MHz)		1852.4	1880	1907.6
RMC12.2K	23.50	23.42	23.15	23.31
HSDPA Sub 1	23.50	23.02	22.67	22.79
HSDPA Sub 2	23.50	23.02	22.68	22.77
HSDPA Sub 3	23.00	22.93	22.69	22.79
HSDPA Sub 4	23.00	22.96	22.67	22.77
HSUPA Sub 1	21.00	20.55	20.12	20.31
HSUPA Sub 2	21.50	21.03	20.58	20.32
HSUPA Sub 3	21.00	20.85	20.30	20.32
HSUPA Sub 4	21.00	20.79	20.28	20.30
HSUPA Sub 5	21.00	20.79	20.13	20.12

WCDMA Band V	Burst-Averaged output Power (dBm)			
Tx Channel	Tune-up (dBm)	4132	4182	4233
Frequency (MHz)		826.4	836.4	846.6
RMC12.2K	23.50	23.39	23.35	23.30
HSDPA Sub 1	23.50	23.14	23.09	23.26
HSDPA Sub 2	23.50	23.13	23.09	23.26
HSDPA Sub 3	23.50	23.05	23.08	23.26
HSDPA Sub 4	23.50	23.02	23.06	23.23
HSUPA Sub 1	21.50	20.41	21.25	20.78
HSUPA Sub 2	21.50	20.37	21.08	21.10
HSUPA Sub 3	21.00	20.61	20.78	20.60
HSUPA Sub 4	21.50	20.93	21.04	20.77
HSUPA Sub 5	21.50	20.62	21.25	21.08

8.3. LTE Conducted Power

1. The following tests were conducted according to the test requirements outlines in 3GPP TS 36.521-1 specification. A summary of these configurations are illustrated below:

Test Parameters for Channel Bandwidths				
Ch BW	Downlink Configuration	Uplink Configuration		
	N/A for Max UE output power testing	Mod'n	RB allocation	
			FDD	TDD
1.4MHz		QPSK	1	1
1.4MHz		QPSK	5	5
3MHz		QPSK	1	1
3MHz		QPSK	4	4
5MHz		QPSK	1	1
5MHz		QPSK	8	8
10MHz		QPSK	1	1
10MHz		QPSK	12	12
15MHz		QPSK	1	1
15MHz		QPSK	16	16
20MHz		QPSK	1	1
20MHz		QPSK	18	18

Note 1: Test Channel Bandwidths are checked separately for each E-UTRA band, the applicable channel bandwidths are specified in Table 5.4.2.1-1.

Note 2: For E-UTRA bands not applied with Note 2 in Table 6.2.2.3-1:

- The 1 RB allocation shall be tested at RB#0 for low and mid range, RB #max for high range test frequency.
- The RBstart of non-1RB allocation shall be RB #0 for low and mid range, RB# (max +1 - RB allocation) for high range test frequency.

Note 3: For E-UTRA bands applied with Note 2 in Table 6.2.2.3-1:

- If the test channel bandwidth is larger than 4MHz, then the 1 RB allocation shall be tested at both RB #0 and RB #max.
- If the test channel bandwidth is smaller or equal to 4MHz, then the 1 RB allocation shall be tested at RB #0.
- If the test channel bandwidth = (FUL_high - FUL_low) specified by the operating band, then only one frequency range shall be tested and the 1 RB allocation shall be tested at RB #0, RB # $\lceil N_{RB}^{UL} / 2 \rceil$ and RB #max.
- For non-1RB allocation, test frequency is middle range, and the RBstart shall be RB #0.

2. LTE Conducted Power Results

LTE output list

Band	Band Width	Modulation	RB Configuration		Tune-up (dBm)	Channel/Frequency(MHz)		
			RB Size	RB Offset		18607/1850.7	18900/1880	19193/1909.3
LTE Band 2	1.4MHz	QPSK	1	0	24.50	23.97	23.85	23.79
			1	2	24.50	24.10	23.80	23.84
			1	5	24.50	24.15	23.84	23.82
			3	0	24.50	24.08	23.88	23.79
			3	1	24.50	24.03	23.85	23.81
			3	2	24.50	24.06	23.86	23.79
		16QAM	6	0	23.50	23.01	22.95	22.80
			1	0	24.00	23.71	23.40	23.10
			1	2	24.00	23.58	23.38	23.14
			1	5	24.00	23.61	23.32	23.06
			3	0	23.00	22.72	22.56	22.39
			3	1	23.00	22.77	22.58	22.45
			3	2	23.00	22.67	22.51	22.41
			6	0	22.50	22.13	21.89	21.86
Band	Band Width	Modulation	RB Configuration		Tune-up (dBm)	Channel/Frequency(MHz)		
			RB Size	RB Offset		18615/1851.5	18900/1880	19185/1908.5
LTE Band 2	3MHz	QPSK	1	0	23.50	23.15	22.99	22.82
			1	7	23.50	23.11	22.98	22.80
			1	14	23.50	23.08	22.97	22.80
			8	0	23.50	23.06	22.97	22.80
			8	4	23.50	23.05	22.97	22.80
			8	7	23.50	23.06	22.97	22.79
		16QAM	15	0	23.50	23.16	22.97	22.79
			1	0	23.50	23.15	22.97	22.79
			1	7	23.50	23.14	22.96	22.79
			1	14	23.50	23.14	22.96	22.79
			8	0	23.50	23.14	22.96	22.79
			8	4	23.50	23.14	22.96	22.79
			8	7	23.50	23.13	22.96	22.78
			15	0	23.50	23.13	22.96	22.78
Band	Band Width	Modulation	RB Configuration		Tune-up (dBm)	Channel/Frequency(MHz)		
			RB Size	RB Offset		18625/1852.5	18900/1880	19175/1907.5
LTE Band 2	5MHz	QPSK	1	0	24.50	24.09	24.01	23.95
			1	12	24.50	24.03	23.82	23.89
			1	24	24.50	24.01	23.82	23.92
			12	0	23.50	23.17	22.92	22.94
			12	6	23.50	23.18	22.98	22.93
			12	11	23.50	23.23	22.93	22.80
			25	0	23.50	23.21	22.93	22.83
		16QAM	1	0	24.00	23.16	23.38	23.50
			1	12	24.00	23.17	23.35	23.41
			1	24	24.00	23.19	23.39	23.42
			12	0	22.50	22.08	22.09	21.76
			12	6	22.50	22.13	22.07	21.75

Band	Band Width	Modulation	RB Configuration		Tune-up (dBm)	Channel/Frequency(MHz)		
			RB Size	RB Offset		18650/1855	18900/1880	19150/1905
			12	11		22.50	22.21	22.04
			25	0	22.50	22.14	22.09	21.86
LTE Band 2	10MHz	QPSK	1	0	24.50	24.07	23.94	24.03
			1	24	24.50	24.02	23.92	23.98
			1	49	24.50	24.10	23.87	23.91
			25	0	23.50	23.20	23.01	22.97
			25	12	23.50	23.03	22.89	22.75
			25	24	23.50	23.11	22.81	22.95
		16QAM	50	0	23.50	23.21	22.95	22.82
			1	0	24.00	23.23	23.62	23.90
			1	24	24.00	23.32	23.57	23.85
			1	49	24.00	23.39	23.63	23.85
			25	0	22.50	22.14	22.00	21.95
			25	12	22.50	22.05	22.05	21.93
			25	24	22.50	22.11	22.06	21.99
			50	0	22.50	22.08	21.99	21.85
Band	Band Width	Modulation	RB Configuration		Tune-up (dBm)	Channel/Frequency(MHz)		
			RB Size	RB Offset		18675/1857.5	18900/1880	19125/1902.5
			1	0		24.50	24.17	23.98
LTE Band 2	15MHz	QPSK	1	37	24.50	24.12	23.85	23.98
			1	74	24.50	24.11	23.80	23.89
			36	0	23.50	23.11	22.88	22.94
			36	18	23.50	23.06	23.01	22.83
			36	37	23.50	23.16	22.90	22.89
			75	0	23.50	23.13	22.88	22.92
			16QAM	1	0	24.00	23.36	23.26
		1		37	24.00	23.51	23.10	23.86
		1		74	24.00	23.52	23.09	23.75
		36		0	22.50	22.08	21.92	21.91
		36		18	22.50	22.07	21.99	21.88
		36		37	22.50	22.05	21.94	21.90
		75		0	22.50	22.15	22.06	21.94
		Band	Band Width	Modulation	RB Configuration		Tune-up (dBm)	Channel/Frequency(MHz)
RB Size	RB Offset				18700/1860	18900/1880		19100/1900
1	0				24.50	24.04		23.97
LTE Band 2	20MHz	QPSK	1	49	24.50	24.15	23.97	24.20
			1	99	24.50	24.17	24.07	24.13
			50	0	23.50	23.06	22.93	23.01
			50	24	23.50	23.06	22.96	23.09
			50	49	23.50	23.07	22.96	22.83
			100	0	23.50	23.21	22.93	22.95
			16QAM	1	0	24.00	23.81	23.71
		1		49	24.00	23.81	23.61	23.31
		1		99	24.00	23.81	23.71	23.17
		50		0	22.50	22.19	21.90	21.95
		50		24	22.50	22.20	21.96	22.03
		50		49	22.50	22.13	21.91	21.90
		100		0	22.50	22.08	22.00	21.97

Band	Band Width	Modulation	RB Configuration		Tune-up (dBm)	Channel/Frequency(MHz)		
			RB Size	RB Offset		19957/1710.7	20175/1732.5	20393/1754.3
LTE Band 4	1.4MHz	QPSK	1	0	24.50	23.89	24.16	23.99
			1	2	24.50	23.86	24.12	24.01
			1	5	24.50	23.96	24.11	24.07
			3	0	24.00	23.90	23.94	23.94
			3	1	24.00	23.86	24.00	24.00
			3	2	24.00	23.81	23.94	23.93
		16QAM	6	0	23.00	22.91	22.96	22.95
			1	0	24.00	23.19	23.41	23.54
			1	2	24.00	23.18	23.45	23.51
			1	5	24.00	23.14	23.46	23.55
			3	0	23.00	22.53	22.92	22.45
			3	1	23.00	22.55	22.93	22.38
LTE Band 4	3MHz	QPSK	3	2	23.00	22.57	22.99	22.30
			6	0	22.50	21.91	22.16	21.91
			1	0	24.50	23.75	23.99	23.93
			1	7	24.50	23.84	24.00	23.89
			1	14	24.50	23.75	24.12	23.94
			8	0	23.50	22.78	22.96	22.86
		16QAM	8	4	23.50	22.87	23.04	22.86
			8	7	23.50	22.84	23.02	22.99
			15	0	23.00	22.81	22.98	22.84
			1	0	23.50	23.05	23.37	23.37
			1	7	23.50	23.06	23.33	23.40
			1	14	23.50	22.92	23.32	23.45
LTE Band 4	5MHz	QPSK	8	0	22.50	21.82	22.02	21.98
			8	4	22.50	21.78	22.12	21.95
			8	7	22.50	21.77	22.14	21.98
			15	0	22.50	21.74	22.07	21.99
			1	0	24.50	23.80	24.01	23.93
			1	12	24.50	23.76	23.84	23.88
		16QAM	1	24	24.50	23.74	23.86	23.94
			12	0	23.50	22.83	22.98	23.01
			12	6	23.50	22.79	22.96	22.95
			12	11	23.50	22.82	22.92	22.91
			25	0	23.50	22.79	23.04	22.96
			1	0	24.00	22.90	23.44	23.27
LTE Band 4	5MHz	16QAM	1	12	24.00	22.83	23.41	23.24
			1	24	24.00	22.87	23.51	23.26
			12	0	22.50	21.78	22.10	21.77
			12	6	22.50	21.79	22.01	21.74
			12	11	22.50	21.76	22.01	21.87
			12	11	22.50	21.76	22.01	21.87

Band	Band Width	Modulation	RB Configuration		Tune-up (dBm)	Channel/Frequency(MHz)		
			RB Size	RB Offset		20000/1715	20175/1732.5	20350/1750
			25	0		22.00	21.80	21.98
LTE Band 4	10MHz	QPSK	1	0	24.50	23.84	23.88	24.07
			1	24	24.50	23.86	24.01	24.02
			1	49	24.50	23.91	23.98	24.03
			25	0	23.50	22.80	23.04	22.86
			25	12	23.50	22.87	23.00	22.86
			25	24	23.50	22.82	22.98	22.95
			50	0	23.00	22.90	22.97	22.95
		16QAM	1	0	24.50	23.14	23.54	24.09
			1	24	24.50	23.18	23.63	24.06
			1	49	24.50	23.23	23.69	24.10
			25	0	22.50	21.80	21.98	21.93
			25	12	22.50	21.76	22.08	21.93
			25	24	22.50	21.91	22.11	21.93
			50	0	22.50	21.79	22.03	21.97
Band	Band Width	Modulation	RB Configuration		Tune-up (dBm)	Channel/Frequency(MHz)		
			RB Size	RB Offset		20025/1717.5	20175/1732.5	20325/1747.5
			1	0		24.50	23.76	23.74
LTE Band 4	15MHz	QPSK	1	37	24.50	23.86	23.90	24.00
			1	74	24.50	23.77	23.93	24.03
			36	0	23.00	22.87	22.94	22.97
			36	18	23.00	22.90	22.93	22.86
			36	37	23.00	22.87	22.93	22.89
			75	0	23.50	22.80	23.02	22.89
			75	0	23.50	22.80	23.02	22.89
		16QAM	1	0	24.50	22.98	23.17	24.15
			1	37	24.50	23.05	23.27	24.07
			1	74	24.50	22.97	23.28	24.06
			36	0	22.50	21.87	21.85	21.90
			36	18	22.50	21.87	22.01	21.86
			36	37	22.50	21.92	22.04	21.86
			75	0	22.00	21.98	21.95	21.88
Band	Band Width	Modulation	RB Configuration		Tune-up (dBm)	Channel/Frequency(MHz)		
			RB Size	RB Offset		20050/1720	20175/1732.5	20300/1745
			1	0		24.50	23.90	23.97
LTE Band 4	20MHz	QPSK	1	49	24.50	23.92	24.08	24.25
			1	99	24.50	23.97	24.05	24.24
			50	0	23.50	22.86	23.00	22.97
			50	24	23.50	22.84	23.04	23.05
			50	49	23.50	22.91	22.93	23.01
			100	0	23.50	22.78	23.01	22.87
			100	0	23.50	22.78	23.01	22.87
		16QAM	1	0	24.00	23.36	23.66	23.08
			1	49	24.00	23.48	23.85	23.14
			1	99	24.00	23.46	23.87	23.20
			50	0	22.00	21.94	21.87	21.97
			50	24	22.00	21.90	21.95	21.99
			50	49	22.00	21.87	22.00	21.94
			50	49	22.00	21.87	22.00	21.94

			100	0	22.50	21.87	22.01	21.87
--	--	--	-----	---	-------	-------	-------	-------

Band	Band Width	Modulation	RB Configuration		Tune-up (dBm)	Channel/Frequency(MHz)		
			RB Size	RB Offset		20407/824.7	20525/836.5	20643/848.3
LTE Band 5	1.4MHz	QPSK	1	0	25.00	24.56	24.42	24.29
			1	2	25.00	24.56	24.32	24.37
			1	5	25.00	24.54	24.35	24.32
			3	0	25.00	24.53	24.01	24.31
			3	1	25.00	24.53	24.20	24.42
			3	2	25.00	24.44	24.27	24.39
		16QAM	6	0	23.50	23.48	23.24	23.27
			1	0	23.50	23.20	23.22	23.35
			1	2	23.50	23.32	23.23	23.46
			1	5	23.50	23.26	23.31	23.43
			3	0	23.50	23.22	23.15	22.88
			3	1	23.50	23.21	23.13	22.91
			3	2	23.50	23.17	23.19	22.84
			6	0	23.00	22.60	22.36	22.80
Band	Band Width	Modulation	RB Configuration		Tune-up (dBm)	Channel/Frequency(MHz)		
			RB Size	RB Offset		20415/825.5	20525/836.5	20635/847.5
LTE Band 5	3MHz	QPSK	1	0	24.50	24.48	24.40	24.46
			1	7	24.50	24.46	24.33	24.45
			1	14	24.50	24.44	24.33	24.43
			8	0	24.00	23.60	23.36	23.32
			8	4	24.00	23.58	23.20	23.28
			8	7	24.00	23.39	23.37	23.27
		16QAM	15	0	23.50	23.42	23.23	23.27
			1	0	24.00	22.98	23.08	23.51
			1	7	24.00	22.99	23.15	23.51
			1	14	24.00	22.95	23.18	23.43
			8	0	23.50	22.56	23.03	22.34
			8	4	23.50	22.54	22.63	22.31
			8	7	23.50	22.98	22.58	22.78
			15	0	22.50	22.42	22.41	22.39
Band	Band Width	Modulation	RB Configuration		Tune-up (dBm)	Channel/Frequency(MHz)		
			RB Size	RB Offset		20425/826.5	20525/836.5	20625/846.5
LTE Band 5	5MHz	QPSK	1	0	24.50	24.43	24.31	24.27
			1	12	24.50	24.40	24.10	24.32
			1	24	24.50	24.41	24.25	24.31
			12	0	23.50	23.48	23.39	23.44
			12	6	23.50	23.44	23.33	23.34
			12	11	23.50	23.43	23.32	23.38
		16QAM	25	0	23.50	23.40	23.34	23.39
			1	0	23.50	23.02	23.28	23.40
			1	12	23.50	22.97	23.23	23.42
			1	24	23.50	23.01	23.28	23.40
			12	0	23.00	22.43	22.97	22.19
			12	6	23.00	22.93	22.48	22.25
			12	11	23.00	22.91	22.52	22.24
			25	0	23.00	22.92	22.60	22.26

Band	Band Width	Modulation	RB Configuration		Tune-up (dBm)	Channel/Frequency(MHz)		
			RB Size	RB Offset		20450/829	20525/836.5	20600/844
LTE Band 5	10MHz	QPSK	1	0	25.00	24.55	24.34	24.33
			1	24	25.00	24.55	24.18	24.30
			1	49	25.00	24.50	24.41	24.38
			25	0	24.00	23.45	23.39	23.41
			25	12	24.00	23.50	23.31	23.39
			25	24	24.00	23.83	23.33	23.37
			50	0	24.00	23.54	23.37	23.34
		16QAM	1	0	24.00	23.29	23.89	23.77
			1	24	24.00	23.21	23.46	23.88
			1	49	24.00	23.14	23.58	23.82
			25	0	23.00	22.82	22.91	22.40
			25	12	23.00	22.48	22.48	22.85
			25	24	23.00	22.77	22.88	22.37
			50	0	23.00	22.43	22.38	22.80

Band	Band Width	Modulation	RB Configuration		Tune-up (dBm)	Channel/Frequency(MHz)		
			RB Size	RB Offset		20775/2502.5	21100/2535	21425/2567.5
LTE Band 7	5MHz	QPSK	1	0	24.00	23.74	23.75	23.59
			1	12	24.00	23.67	23.67	23.61
			1	24	24.00	23.81	23.72	23.63
			12	0	23.00	22.98	22.82	22.62
			12	6	23.00	22.81	22.72	22.59
			12	11	23.00	22.85	22.77	22.57
			25	0	23.00	22.83	22.79	22.71
		16QAM	1	0	23.00	22.80	22.79	21.94
			1	12	23.00	22.85	22.80	22.00
			1	24	23.00	22.80	22.82	21.94
			12	0	22.50	22.00	21.66	21.56
			12	6	22.50	22.08	21.72	21.56
			12	11	22.50	22.24	21.87	21.54
			25	0	22.50	22.01	21.55	21.68

Band	Band Width	Modulation	RB Configuration		Tune-up (dBm)	Channel/Frequency(MHz)		
			RB Size	RB Offset		20800/2505	21100/2535	21400/2565
LTE Band 7	10MHz	QPSK	1	0	24.00	23.88	23.79	23.72
			1	24	24.00	23.87	23.86	23.74
			1	49	24.00	23.86	23.85	23.75
			25	0	23.00	22.78	22.78	22.66
			25	12	23.00	22.80	22.78	22.59
			25	24	23.00	22.96	22.75	22.62
			50	0	23.00	22.98	22.67	22.68
		16QAM	1	0	23.00	22.43	22.46	22.47
			1	24	23.00	22.42	22.54	22.48
			1	49	23.00	22.43	22.60	22.48
			25	0	22.00	21.91	21.76	21.85
			25	12	22.00	21.90	21.80	21.70
			25	24	22.00	21.90	21.85	21.83
			50	0	22.00	21.96	21.75	21.69

Band	Band Width	Modulation	RB Configuration		Tune-up (dBm)	Channel/Frequency(MHz)		
			RB Size	RB Offset		20825/2507.5	21100/2535	21375/2562.5
LTE Band 7	15MHz	QPSK	1	0	24.00	23.78	23.82	23.69
			1	37	24.00	23.84	23.78	23.69
			1	74	24.00	23.85	23.80	23.75
			36	0	23.00	22.89	22.80	22.73
			36	18	23.00	22.92	22.69	22.62
			36	37	23.00	22.94	22.82	22.67
			75	0	23.00	22.91	22.72	22.67
		16QAM	1	0	23.00	22.45	22.57	22.61
			1	37	23.00	22.36	22.55	22.60
			1	74	23.00	22.41	22.61	22.71
			36	0	22.00	21.90	21.80	21.66
			36	18	22.00	21.90	21.77	21.60
			36	37	22.00	21.93	21.88	21.68
			75	0	22.00	21.95	21.84	21.66
Band	Band Width	Modulation	RB Configuration		Tune-up (dBm)	Channel/Frequency(MHz)		
			RB Size	RB Offset		20850/2510	21100/2535	21350/2560
LTE Band 7	20MHz	QPSK	1	0	24.00	23.73	23.88	23.87
			1	49	24.00	23.72	23.79	23.96
			1	99	24.00	23.79	23.77	23.94
			50	0	23.00	22.83	22.74	22.68
			50	24	23.00	22.82	22.77	22.62
			50	49	23.00	22.88	22.79	22.62
			100	0	23.00	22.79	22.73	22.64
		16QAM	1	0	23.50	22.73	23.10	22.56
			1	49	23.50	22.83	23.08	22.64
			1	99	23.50	22.88	23.10	22.69
			50	0	22.00	21.83	21.69	21.69
			50	24	22.00	21.97	21.73	21.72
			50	49	22.00	21.89	21.74	21.64
			100	0	22.00	21.77	21.80	21.62

8.4. Wi-Fi & BT Output Power

Mode	Channel	Frequency (MHz)	Tune-up (dBm)	Output Power (dBm)
802.11b	1	2412	15.50	15.28
	6	2437	15.50	14.32
	11	2462	15.50	13.86
802.11g	1	2412	17.00	15.85
	6	2437	17.00	16.86
	11	2462	17.00	16.09
802.11n HT20	1	2412	16.50	15.02
	6	2437	16.50	16.11
	11	2462	16.50	15.32
802.11n HT40	3	2422	14.50	14.47
	6	2437	16.50	16.03
	9	2452	15.00	14.64

Mode	Channel	Frequency (MHz)	Tune-up (dBm)	Output Power (dBm)
802.11a	36	5180	11.00	10.72
	40	5200	11.00	10.55
	48	5240	11.00	9.94
802.11n HT20	36	5180	10.50	10.43
	40	5200	10.50	10.23
	48	5240	10.50	10.00
802.11n HT40	38	5190	10.50	10.09
	46	5230	10.50	9.84
802.11ac VHT20	36	5180	11.00	10.70
	40	5200	11.00	10.49
	48	5240	11.00	10.08
802.11ac VHT40	38	5190	11.00	10.70
	46	5230	11.00	10.46
802.11ac VHT80	42	5210	10.50	10.23

Mode	Channel	Frequency (MHz)	Tune-up (dBm)	Output Power (dBm)
802.11a	149	5745	14.50	13.27
	157	5785	14.50	13.66
	165	5825	14.50	14.06
802.11n HT20	149	5745	14.50	13.39
	157	5785	14.50	13.90
	165	5825	14.50	14.04

802.11n HT40	151	5755	14.00	13.11
	159	5795	14.00	13.68
802.11ac VHT20	149	5745	14.50	14.03
	157	5785	10.50	10.48
	165	5825	11.00	10.81
802.11ac VHT40	151	5755	14.50	13.77
	159	5795	14.50	14.29
802.11ac VHT80	155	5775	14.00	13.77

BR+EDR	Output Power (dBm)				
	Channel	Tune-up (dBm)	Data Rates		
			1M	2M	3M
	0CH	2.00	0.83	1.20	1.81
39CH	3.00	1.04	2.00	2.68	
78CH	5.00	3.22	3.78	4.36	

Mode	Channel	Tune-up (dBm)	Output Power (dBm)
BLE1M	CH00	-3.00	-3.57
	CH19	-3.00	-3.07
	CH39	0.00	-0.78
BLE2M	CH00	-3.00	-3.46
	CH19	-3.00	-3.04
	CH39	0.00	-0.75

9. Antenna Location

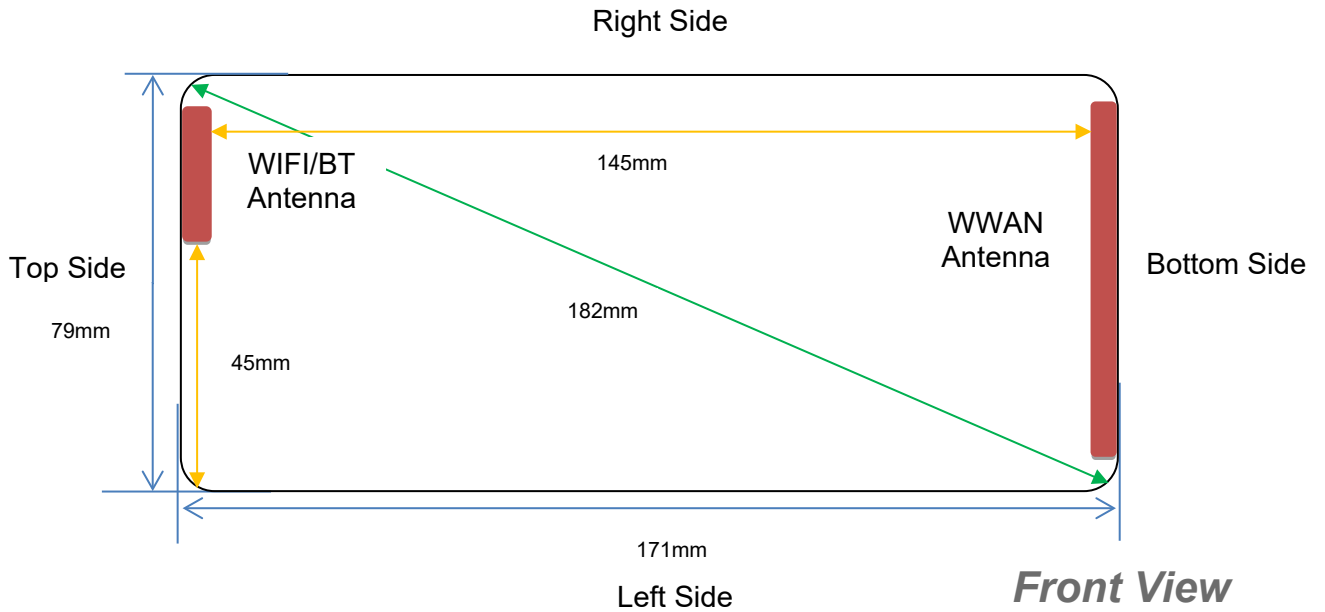

Antenna information:

Distance of The Antenna to the EUT surface and edge (mm)						
Antennas	Front Side	Back Side	Left Side	Right Side	Top Side	Bottom Side
BT/WLAN	≤25mm	≤25mm	>25mm	≤25mm	≤25mm	>25mm
WWAN	≤25mm	≤25mm	≤25mm	≤25mm	>25mm	≤25mm

Positions for SAR tests						
Antennas	Front Side	Back Side	Left Side	Right Side	Top Side	Bottom Side
BT/WLAN	Yes	Yes	NO	Yes	Yes	NO
WWAN	Yes	Yes	Yes	Yes	NO	Yes

10. Stand-alone SAR test exclusion

Refer to FCC KDB 447498D01, the 1-g SAR and 10-g SAR test exclusion thresholds for 100 MHz to 6 GHz at test separation distances ≤ 50 mm are determined by:

$[(\text{max. power of channel, including tune-up tolerance, mW})/(\text{min. test separation distance, mm})] \cdot [\sqrt{f(\text{GHz})}] \leq 3.0$ for 1-g SAR and ≤ 7.5 for 10-g extremity SAR, where:

- $f(\text{GHz})$ is the RF channel transmit frequency in GHz
- Power and distance are rounded to the nearest mW and mm before calculation
- The result is rounded to one decimal place for comparison

When the minimum test separation distance is < 5 mm, a distance of 5 mm is applied to determine SAR test exclusion.

Mode	Pmax (dBm)	Pmax (mW)	Distance (mm)	f (GHz)	Calculation Result	SAR Exclusion threshold	SAR test exclusion
Bluetooth	5.00	3.16	5	2.480	1	3	Yes

NOTE: Standalone SAR test exclusion for Bluetooth.

When standalone SAR test exclusion applies to an antenna that transmits simultaneously with other antennas, the standalone SAR must be estimated according to following to determine simultaneous transmission SAR test exclusion:

$[(\text{max. power of channel, including tune-up tolerance, mW})/(\text{min. test separation distance, mm})] \cdot [\sqrt{f(\text{GHz})/x}] \text{ W/kg}$ for test separation distances $\leq 50\text{mm}$, where $x = 7.5$ for 1-g SAR and $x = 18.75$ for 10-g SAR.

When the minimum test separation distance is < 5 mm, a distance of 5 mm is applied to determine SAR test exclusion.

Mode	Position	Pmax (dBm)	Pmax (mW)	Distance (mm)	f (GHz)	x	Estimated SAR (W/kg)
Bluetooth	Head	5.00	3.16	5	2.48	7.5	0.132
Bluetooth	Body	5.00	3.16	5	2.48	7.5	0.132
Bluetooth	Hotspot	5.00	3.16	5	2.48	7.5	0.132

NOTE: Estimated SAR calculation for Bluetooth

11. SAR Measurement Results

< GSM 850 >

Test Position	Test channel /Freq.	Test Mode	SAR Value (W/kg)		Power Drift (±5%)	Conducted power (dBm)	Tune-up power (dBm)	Scaled SAR 1g (W/Kg)	Date	Plot
			1g	10g						
Left Cheek	189/836.4	GPRS(GMSK 2TS)	0.199	0.154	-1.74	31.41	31.50	0.203	2025/4/25	1#
Left Tilt 15 Degree	189/836.4	GPRS(GMSK 2TS)	0.102	0.076	1.88	31.41	31.50	0.104	2025/4/25	
Right Cheek	189/836.4	GPRS(GMSK 2TS)	0.188	0.138	-1.84	31.41	31.50	0.192	2025/4/25	
Right Tilt 15 Degree	189/836.4	GPRS(GMSK 2TS)	0.091	0.068	2.62	31.41	31.50	0.093	2025/4/25	

Test Position of Hotspot with 5mm	Test channel /Freq.	Test Mode	SAR Value (W/kg)		Power Drift (±5%)	Conducted power (dBm)	Tune-up power (dBm)	Scaled SAR 1g (W/Kg)	Date	Plot
			1g	10g						
Front Side	189/836.4	GPRS(GMSK 2TS)	0.132	0.075	0.45	31.41	31.50	0.135	2025/4/25	
Back Side	189/836.4	GPRS(GMSK 2TS)	0.190	0.113	-4.61	31.41	31.50	0.194	2025/4/25	2#
Left Side	189/836.4	GPRS(GMSK 2TS)	0.066	0.037	-3.71	31.41	31.50	0.067	2025/4/25	
Right Side	189/836.4	GPRS(GMSK 2TS)	0.063	0.036	-1.22	31.41	31.50	0.064	2025/4/25	
Bottom Side	189/836.4	GPRS(GMSK 2TS)	0.110	0.065	3.04	31.41	31.50	0.112	2025/4/25	

< GSM 1900 >

Test Position	Test channel /Freq.	Test Mode	SAR Value (W/kg)		Power Drift (±5%)	Conducted power (dBm)	Tune-up power (dBm)	Scaled SAR 1g	Date	Plot
			1g	10g						

								(W/Kg)		
Left Cheek	661/1880	GPRS(GMSK 3TS)	0.368	0.313	4.12	25.95	26.50	0.418	2025/4/29	3#
Left Tilt 15 Degree	661/1880	GPRS(GMSK 3TS)	0.202	0.165	1.94	25.95	26.50	0.229	2025/4/29	
Right Cheek	661/1880	GPRS(GMSK 3TS)	0.321	0.268	0.67	25.95	26.50	0.364	2025/4/29	
Right Tilt 15 Degree	661/1880	GPRS(GMSK 3TS)	0.160	0.133	-3.01	25.95	26.50	0.182	2025/4/29	

Test Position of Hotspot with 5mm	Test channel /Freq.	Test Mode	SAR Value (W/kg)		Power Drift (±5%)	Conducted power (dBm)	Tune-up power (dBm)	Scaled SAR 1g (W/Kg)	Date	Plot
			1g	10g						
Front Side	661/1880	GPRS(GMSK 3TS)	0.216	0.165	-1.73	25.95	26.50	0.245	2025/4/29	
Back Side	661/1880	GPRS(GMSK 3TS)	0.335	0.258	1.54	25.95	26.50	0.380	2025/4/29	4#
Left Side	661/1880	GPRS(GMSK 3TS)	0.108	0.080	0.37	25.95	26.50	0.123	2025/4/29	
Right Side	661/1880	GPRS(GMSK 3TS)	0.114	0.088	2.29	25.95	26.50	0.129	2025/4/29	
Bottom Side	661/1880	GPRS(GMSK 3TS)	0.170	0.131	-1.60	25.95	26.50	0.193	2025/4/29	

< WCDMA Band 2 >

Test Position	Test channel /Freq.	Test Mode	SAR Value (W/kg)		Power Drift (±5%)	Conducted power (dBm)	Tune-up power (dBm)	Scaled SAR 1g (W/Kg)	Date	Plot
			1g	10g						
Left Cheek	9400/1880	RMC12.2K	0.425	0.318	-0.83	23.15	23.50	0.461	2025/4/29	5#
Left Tilt 15 Degree	9400/1880	RMC12.2K	0.242	0.176	-3.03	23.15	23.50	0.262	2025/4/29	
Right	9400/1880	RMC12.2K	0.400	0.290	-1.08	23.15	23.50	0.434	2025/4/29	

Cheek										
Right Tilt 15 Degree	9400/1880	RMC12.2K	0.180	0.128	-3.90	23.15	23.50	0.195	2025/4/29	

Test Position of Hotspot with 5mm	Test channel /Freq.	Test Mode	SAR Value (W/kg)		Power Drift (±5%)	Conducted power (dBm)	Tune-up power (dBm)	Scaled SAR 1g (W/Kg)	Date	Plot
			1g	10g						
Front Side	9400/1880	RMC12.2K	0.222	0.159	3.21	23.15	23.50	0.241	2025/4/29	
Back Side	9400/1880	RMC12.2K	0.328	0.242	2.19	23.15	23.50	0.356	2025/4/29	6#
Left Side	9400/1880	RMC12.2K	0.105	0.076	0.46	23.15	23.50	0.114	2025/4/29	
Right Side	9400/1880	RMC12.2K	0.102	0.075	-1.47	23.15	23.50	0.111	2025/4/29	
Bottom Side	9400/1880	RMC12.2K	0.170	0.119	-2.94	23.15	23.50	0.184	2025/4/29	

< WCDMA Band 5 >

Test Position	Test channel /Freq.	Test Mode	SAR Value (W/kg)		Power Drift (±5%)	Conducted power (dBm)	Tune-up power (dBm)	Scaled SAR 1g (W/Kg)	Date	Plot
			1g	10g						
Left Cheek	4182/836.4	RMC12.2K	0.241	0.189	-0.25	23.35	23.50	0.249	2025/4/25	7#
Left Tilt 15 Degree	4182/836.4	RMC12.2K	0.130	0.101	2.54	23.35	23.50	0.135	2025/4/25	
Right Cheek	4182/836.4	RMC12.2K	0.208	0.163	-2.28	23.35	23.50	0.215	2025/4/25	
Right Tilt 15 Degree	4182/836.4	RMC12.2K	0.102	0.078	0.77	23.35	23.50	0.106	2025/4/25	

Test Position	Test channel	Test Mode	SAR Value (W/kg)	Power Drift	Conducted power	Tune-up power	Scaled SAR	Date	Plot
---------------	--------------	-----------	------------------	-------------	-----------------	---------------	------------	------	------

of Hotspot with 5mm	/Freq.		1g	10g	(±5%)	(dBm)	(dBm)	1g (W/Kg)		
Front Side	4182/836.4	RMC12.2K	0.126	0.105	-2.71	23.35	23.50	0.130	2025/4/25	
Back Side	4182/836.4	RMC12.2K	0.192	0.166	-4.87	23.35	23.50	0.199	2025/4/25	8#
Left Side	4182/836.4	RMC12.2K	0.066	0.056	-3.44	23.35	23.50	0.068	2025/4/25	
Right Side	4182/836.4	RMC12.2K	0.072	0.062	2.43	23.35	23.50	0.075	2025/4/25	
Bottom Side	4182/836.4	RMC12.2K	0.110	0.093	3.18	23.35	23.50	0.114	2025/4/25	

< LTE Band 2 >

Test Position	Test channel /Freq.	Test Mode	SAR Value (W/kg)		Power Drift (±5%)	Conducted power (dBm)	Tune-up power (dBm)	Scaled SAR 1g (W/Kg)	Date	Plot
			1g	10g						
1RB										
Left Cheek	18900/1880	20M QPSK(1,49)	0.472	0.346	-0.86	23.97	24.50	0.533	2025/4/29	15#
Left Tilt 15 Degree	18900/1880	20M QPSK(1,49)	0.237	0.165	-2.24	23.97	24.50	0.268	2025/4/29	
Right Cheek	18900/1880	20M QPSK(1,49)	0.433	0.314	2.15	23.97	24.50	0.489	2025/4/29	
Right Tilt 15 Degree	18900/1880	20M QPSK(1,49)	0.204	0.147	-2.63	23.97	24.50	0.230	2025/4/29	
50%RB										
Left Cheek	18900/1880	20M QPSK(50,24)	0.245	0.200	4.40	22.96	23.50	0.277	2025/4/29	
Left Tilt 15 Degree	18900/1880	20M QPSK(50,24)	0.127	0.089	3.97	22.96	23.50	0.144	2025/4/29	
Right Cheek	18900/1880	20M QPSK(50,24)	0.239	0.164	3.35	22.96	23.50	0.271	2025/4/29	
Right	18900/1880	20M QPSK(50,24)	0.120	0.080	-4.04	22.96	23.50	0.136	2025/4/29	

Tilt 15 Degree										
----------------	--	--	--	--	--	--	--	--	--	--

Test Position of Hotspot with 5mm	Test channel /Freq.	Test Mode	SAR Value (W/kg)		Power Drift (±5%)	Conducted power (dBm)	Tune-up power (dBm)	Scaled SAR 1g (W/Kg)	Date	Plot
			1g	10g						
1RB										
Front Side	18900/1880	20M QPSK(1,49)	0.264	0.176	-2.05	23.97	24.50	0.298	2025/4/29	
Back Side	18900/1880	20M QPSK(1,49)	0.436	0.303	-2.99	23.97	24.50	0.493	2025/4/29	16#
Left Side	18900/1880	20M QPSK(1,49)	0.135	0.091	3.30	23.97	24.50	0.153	2025/4/29	
Right Side	18900/1880	20M QPSK(1,49)	0.144	0.100	0.81	23.97	24.50	0.163	2025/4/29	
Bottom Side	18900/1880	20M QPSK(1,49)	0.220	0.150	0.38	23.97	24.50	0.249	2025/4/29	
50%RB										
Front Side	18900/1880	20M QPSK(50,24)	0.137	0.104	4.95	22.96	23.50	0.155	2025/4/29	
Back Side	18900/1880	20M QPSK(50,24)	0.243	0.163	-2.00	22.96	23.50	0.275	2025/4/29	
Left Side	18900/1880	20M QPSK(50,24)	0.072	0.051	-3.96	22.96	23.50	0.082	2025/4/29	
Right Side	18900/1880	20M QPSK(50,24)	0.079	0.054	-4.60	22.96	23.50	0.089	2025/4/29	
Bottom Side	18900/1880	20M QPSK(50,24)	0.121	0.078	-2.30	22.96	23.50	0.137	2025/4/29	

< LTE Band 4 >

Test Position	Test channel /Freq.	Test Mode	SAR Value (W/kg)		Power Drift (±5%)	Conducted power (dBm)	Tune-up power (dBm)	Scaled SAR 1g (W/Kg)	Date	Plot
			1g	10g						
1RB										
Left Cheek	20175/1732.5	20M QPSK(1,49)	0.455	0.345	-4.48	24.08	24.50	0.501	2025/4/28	17#
Left Tilt	20175/1732.5	20M QPSK(1,49)	0.253	0.184	3.82	24.08	24.50	0.279	2025/4/28	

15 Degree										
Right Cheek	20175/1732.5	20M QPSK(1,49)	0.428	0.312	-0.55	24.08	24.50	0.471	2025/4/28	
Right Tilt 15 Degree	20175/1732.5	20M QPSK(1,49)	0.226	0.165	2.20	24.08	24.50	0.249	2025/4/28	
50%RB										
Left Cheek	20175/1732.5	20M QPSK(50,24)	0.240	0.206	-4.16	23.04	23.50	0.267	2025/4/28	
Left Tilt 15 Degree	20175/1732.5	20M QPSK(50,24)	0.128	0.100	-4.82	23.04	23.50	0.142	2025/4/28	
Right Cheek	20175/1732.5	20M QPSK(50,24)	0.218	0.169	-1.12	23.04	23.50	0.242	2025/4/28	
Right Tilt 15 Degree	20175/1732.5	20M QPSK(50,24)	0.126	0.098	3.18	23.04	23.50	0.140	2025/4/28	

Test Position of Hotspot with 5mm	Test channel /Freq.	Test Mode	SAR Value (W/kg)		Power Drift (±5%)	Conducted power (dBm)	Tune-up power (dBm)	Scaled SAR 1g (W/Kg)	Date	Plot
			1g	10g						
1RB										
Front Side	20175/1732.5	20M QPSK(1,49)	0.168	0.120	3.87	24.08	24.50	0.185	2025/4/28	
Back Side	20175/1732.5	20M QPSK(1,49)	0.251	0.181	-0.90	24.08	24.50	0.276	2025/4/28	18#
Left Side	20175/1732.5	20M QPSK(1,49)	0.087	0.061	-1.75	24.08	24.50	0.096	2025/4/28	
Right Side	20175/1732.5	20M QPSK(1,49)	0.090	0.062	-3.54	24.08	24.50	0.099	2025/4/28	
Bottom Side	20175/1732.5	20M QPSK(1,49)	0.135	0.092	-3.33	24.08	24.50	0.149	2025/4/28	
50%RB										
Front Side	20175/1732.5	20M QPSK(50,24)	0.097	0.069	-3.14	23.04	23.50	0.108	2025/4/28	
Back Side	20175/1732.5	20M QPSK(50,24)	0.145	0.106	1.16	23.04	23.50	0.161	2025/4/28	

Left Side	20175/1732.5	20M QPSK(50,24)	0.048	0.032	-3.21	23.04	23.50	0.053	2025/4/28	
Right Side	20175/1732.5	20M QPSK(50,24)	0.046	0.032	0.99	23.04	23.50	0.051	2025/4/28	
Bottom Side	20175/1732.5	20M QPSK(50,24)	0.078	0.050	-3.48	23.04	23.50	0.087	2025/4/28	

< LTE Band 5 >

Test Position	Test channel /Freq.	Test Mode	SAR Value (W/kg)		Power Drift (±5%)	Conducted power (dBm)	Tune-up power (dBm)	Scaled SAR 1g (W/Kg)	Date	Plot
			1g	10g						
1RB										
Left Cheek	20525/836.5	10M QPSK(1,0)	0.323	0.264	0.07	24.34	25.00	0.376	2025/4/25	19#
Left Tilt 15 Degree	20525/836.5	10M QPSK(1,0)	0.184	0.149	-1.54	24.34	25.00	0.214	2025/4/25	
Right Cheek	20525/836.5	10M QPSK(1,0)	0.275	0.218	0.59	24.34	25.00	0.320	2025/4/25	
Right Tilt 15 Degree	20525/836.5	10M QPSK(1,0)	0.138	0.112	0.69	24.34	25.00	0.161	2025/4/25	
50%RB										
Left Cheek	20525/836.5	10M QPSK(25,24)	0.173	0.135	-2.97	23.33	24.00	0.202	2025/4/25	
Left Tilt 15 Degree	20525/836.5	10M QPSK(25,24)	0.096	0.084	-3.96	23.33	24.00	0.112	2025/4/25	
Right Cheek	20525/836.5	10M QPSK(25,24)	0.164	0.129	-4.79	23.33	24.00	0.191	2025/4/25	
Right Tilt 15 Degree	20525/836.5	10M QPSK(25,24)	0.079	0.067	3.41	23.33	24.00	0.092	2025/4/25	

Test Position of Hotspot with 5mm	Test channel /Freq.	Test Mode	SAR Value (W/kg)		Power Drift (±5%)	Conducted power (dBm)	Tune-up power (dBm)	Scaled SAR 1g (W/Kg)	Date	Plot
			1g	10g						

1RB										
Front Side	20525/836.5	10M QPSK(1,0)	0.162	0.127	-1.21	24.34	25.00	0.189	2025/4/25	
Back Side	20525/836.5	10M QPSK(1,0)	0.234	0.191	0.61	24.34	25.00	0.272	2025/4/25	20#
Left Side	20525/836.5	10M QPSK(1,0)	0.072	0.057	3.86	24.34	25.00	0.084	2025/4/25	
Right Side	20525/836.5	10M QPSK(1,0)	0.084	0.068	0.32	24.34	25.00	0.098	2025/4/25	
Bottom Side	20525/836.5	10M QPSK(1,0)	0.130	0.102	-2.88	24.34	25.00	0.151	2025/4/25	
50%RB										
Front Side	20525/836.5	10M QPSK(25,24)	0.085	0.070	3.05	23.33	24.00	0.099	2025/4/25	
Back Side	20525/836.5	10M QPSK(25,24)	0.136	0.102	-0.16	23.33	24.00	0.159	2025/4/25	
Left Side	20525/836.5	10M QPSK(25,24)	0.042	0.033	-4.98	23.33	24.00	0.049	2025/4/25	
Right Side	20525/836.5	10M QPSK(25,24)	0.050	0.035	-2.55	23.33	24.00	0.058	2025/4/25	
Bottom Side	20525/836.5	10M QPSK(25,24)	0.075	0.056	1.92	23.33	24.00	0.088	2025/4/25	

< LTE Band 7 >

Test Position	Test channel /Freq.	Test Mode	SAR Value (W/kg)		Power Drift (±5%)	Conducted power (dBm)	Tune-up power (dBm)	Scaled SAR 1g (W/Kg)	Date	Plot
			1g	10g						
1RB										
Left Cheek	21100/2535	20M QPSK(1,49)	0.580	0.383	-1.80	23.79	24.00	0.609	2025/5/1	21#
Left Tilt 15 Degree	21100/2535	20M QPSK(1,49)	0.326	0.213	1.19	23.79	24.00	0.342	2025/5/1	
Right Cheek	21100/2535	20M QPSK(1,49)	0.511	0.327	0.42	23.79	24.00	0.536	2025/5/1	
Right Tilt 15 Degree	21100/2535	20M QPSK(1,49)	0.272	0.171	-1.55	23.79	24.00	0.285	2025/5/1	
50%RB										

Left Cheek	21100/2535	20M QPSK(50,49)	0.300	0.216	-1.43	22.79	23.00	0.315	2025/5/1	
Left Tilt 15 Degree	21100/2535	20M QPSK(50,49)	0.182	0.118	-4.82	22.79	23.00	0.191	2025/5/1	
Right Cheek	21100/2535	20M QPSK(50,49)	0.264	0.187	-4.81	22.79	23.00	0.277	2025/5/1	
Right Tilt 15 Degree	21100/2535	20M QPSK(50,49)	0.145	0.099	-0.25	22.79	23.00	0.152	2025/5/1	

Test Position of Hotspot with 5mm	Test channel /Freq.	Test Mode	SAR Value (W/kg)		Power Drift (±5%)	Conducted power (dBm)	Tune-up power (dBm)	Scaled SAR 1g (W/Kg)	Date	Plot
			1g	10g						
1RB										
Front Side	21100/2535	20M QPSK(1,49)	0.300	0.201	-1.19	23.79	24.00	0.315	2025/5/1	
Back Side	21100/2535	20M QPSK(1,49)	0.455	0.308	0.18	23.79	24.00	0.478	2025/5/1	22#
Left Side	21100/2535	20M QPSK(1,49)	0.144	0.094	-2.14	23.79	24.00	0.151	2025/5/1	
Right Side	21100/2535	20M QPSK(1,49)	0.141	0.092	3.69	23.79	24.00	0.148	2025/5/1	
Bottom Side	21100/2535	20M QPSK(1,49)	0.245	0.161	3.26	23.79	24.00	0.257	2025/5/1	
50%RB										
Front Side	21100/2535	20M QPSK(50,49)	0.154	0.111	3.46	22.79	23.00	0.162	2025/5/1	
Back Side	21100/2535	20M QPSK(50,49)	0.272	0.163	2.49	22.79	23.00	0.285	2025/5/1	
Left Side	21100/2535	20M QPSK(50,49)	0.074	0.048	0.13	22.79	23.00	0.078	2025/5/1	
Right Side	21100/2535	20M QPSK(50,49)	0.078	0.051	-4.24	22.79	23.00	0.082	2025/5/1	
Bottom Side	21100/2535	20M QPSK(50,49)	0.145	0.093	0.17	22.79	23.00	0.152	2025/5/1	

< WiFi 2.4G >

Test Position	Test channel /Freq.	Test Mode	SAR Value (W/kg)		Power Drift (±5%)	Conducted power (dBm)	Tune-up power (dBm)	Scaled SAR 1g (W/Kg)	Date	Plot
			1g	10g						
Left Cheek	1/2412	802.11b	0.305	0.216	-3.59	15.28	15.50	0.321	2025/4/30	13#
Left Cheek	6/2437	802.11g	0.291	0.205	1.20	16.86	17.00	0.301	2025/4/30	
Left Tilt 15 Degree	1/2412	802.11b	0.177	0.120	3.77	15.28	15.50	0.186	2025/4/30	
Right Cheek	1/2412	802.11b	0.264	0.179	0.44	15.28	15.50	0.278	2025/4/30	
Right Tilt 15 Degree	1/2412	802.11b	0.140	0.095	2.26	15.28	15.50	0.147	2025/4/30	

Test Position of Hotspot with 5mm	Test channel /Freq.	Test Mode	SAR Value (W/kg)		Power Drift (±5%)	Conducted power (dBm)	Tune-up power (dBm)	Scaled SAR 1g (W/Kg)	Date	Plot
			1g	10g						
Front Side	1/2412	802.11b	0.198	0.125	-1.60	15.28	15.50	0.208	2025/4/30	
Back Side	1/2412	802.11b	0.324	0.211	-1.97	15.28	15.50	0.341	2025/4/30	14#
Back Side	6/2437	802.11g	0.317	0.208	2.05	16.86	17.00	0.327	2025/4/30	
Right Side	1/2412	802.11b	0.102	0.064	3.35	15.28	15.50	0.107	2025/4/30	
Top Side	1/2412	802.11b	0.105	0.066	1.79	15.28	15.50	0.110	2025/4/30	

< WiFi 5.2G >

Test Position	Test channel /Freq.	Test Mode	SAR Value (W/kg)	Power Drift	Conducted power	Tune-up power	Scaled SAR	Date	Plot
---------------	---------------------	-----------	------------------	-------------	-----------------	---------------	------------	------	------

			1g	10g	(±5%)	(dBm)	(dBm)	1g (W/Kg)		
Left Cheek	36/5180	802.11a	0.354	0.264	-0.56	10.72	11.00	0.378	2025/5/2	9#
Left Tilt 15 Degree	36/5180	802.11a	0.197	0.145	0.18	10.72	11.00	0.210	2025/5/2	
Right Cheek	36/5180	802.11a	0.308	0.223	1.72	10.72	11.00	0.329	2025/5/2	
Right Tilt 15 Degree	36/5180	802.11a	0.151	0.108	-0.11	10.72	11.00	0.161	2025/5/2	

Test Position of Hotspot with 5mm	Test channel /Freq.	Test Mode	SAR Value (W/kg)		Power Drift (±5%)	Conducted power (dBm)	Tune-up power (dBm)	Scaled SAR 1g (W/Kg)	Date	Plot
			1g	10g						
Front Side	36/5180	802.11a	0.354	0.256	-0.28	10.72	11.00	0.378	2025/5/2	
Back Side	36/5180	802.11a	0.577	0.430	0.88	10.72	11.00	0.615	2025/5/2	11#
Right Side	36/5180	802.11a	0.186	0.137	3.02	10.72	11.00	0.198	2025/5/2	
Top Side	36/5180	802.11a	0.189	0.139	2.15	10.72	11.00	0.202	2025/5/2	

< WiFi 5.8G >

Test Position	Test channel /Freq.	Test Mode	SAR Value (W/kg)		Power Drift (±5%)	Conducted power (dBm)	Tune-up power (dBm)	Scaled SAR 1g (W/Kg)	Date	Plot
			1g	10g						
Left Cheek	159/5795	802.11ac VHT40	0.510	0.360	-3.50	14.29	14.50	0.535	2025/5/5	10#
Left Tilt 15 Degree	159/5795	802.11ac VHT40	0.270	0.191	0.29	14.29	14.50	0.283	2025/5/5	
Right Cheek	159/5795	802.11ac VHT40	0.460	0.315	3.06	14.29	14.50	0.483	2025/5/5	

Right Tilt 15 Degree	159/5795	802.11ac VHT40	0.246	0.170	-2.69	14.29	14.50	0.258	2025/5/5	
----------------------	----------	----------------	-------	-------	-------	-------	-------	-------	----------	--

Test Position of Hotspot with 5mm	Test channel /Freq.	Test Mode	SAR Value (W/kg)		Power Drift (±5%)	Conducted power (dBm)	Tune-up power (dBm)	Scaled SAR 1g (W/Kg)	Date	Plot
			1g	10g						
Front Side	159/5795	802.11ac VHT40	0.336	0.228	-0.49	14.29	14.50	0.353	2025/5/5	
Back Side	159/5795	802.11ac VHT40	0.535	0.363	3.20	14.29	14.50	0.562	2025/5/5	12#
Right Side	159/5795	802.11ac VHT40	0.174	0.118	3.49	14.29	14.50	0.183	2025/5/5	
Top Side	159/5795	802.11ac VHT40	0.162	0.106	2.51	14.29	14.50	0.170	2025/5/5	

12. Simultaneous Transmission Analysis

Per KDB 447498 D01, simultaneous transmission SAR is compliant if,

1) Scalar SAR summation < 1.6W/kg.

2) $SPLSR = \frac{(SAR_1 + SAR_2)^{1.5}}{\text{(min. separation distance, mm)}}$, and the peak separation distance is

determined from the square root of $[(x_1-x_2)^2 + (y_1-y_2)^2 + (z_1-z_2)^2]$, where

(x_1, y_1, z_1) and (x_2, y_2, z_2) are the coordinates of the extrapolated peak SAR locations in the zoom scan.

If $SPLSR \leq 0.04$, simultaneously transmission SAR measurement is not necessary.

No.	Simultaneous Tx	Head	Body-worn	Hotspot
1	WWAN+WLAN	Yes	Yes	Yes
2	WWAN+Bluetooth	Yes	Yes	Yes

Note : WiFi and Bluetooth use the same antenna and cannot be transmitted at the same time.

Exposure Position		WWAN Band	NII/DTS/DSS Band	Simultaneous Tx SAR(W/Kg)
		SAR(W/Kg)	SAR(W/Kg)	
Head	Left Cheek	0.609	0.535	1.144
	Left Tilt 15 Degree	0.342	0.283	0.625
	Right Cheek	0.536	0.483	1.019
	Right Tilt 15 Degree	0.285	0.258	0.543
Body&Hotspot	Front Side	0.315	0.378	0.693
	Back Side	0.493	0.615	1.108
	Left Side	0.153	/	0.153
	Right Side	0.163	0.198	0.361
	Top Side	/	0.202	0.202
	Bottom Side	0.257	/	0.257

Note : The Simultaneous Tx is calculated based on the same configuration and test position.

Appendix A. Photo documentation

Refer to appendix Test Setup photo---SAR

Appendix B. System Check Plots

Table of contents
MEASUREMENT 1 System Performance Check - 850MHz
MEASUREMENT 2 System Performance Check - 1800MHz
MEASUREMENT 3 System Performance Check - 1900MHz
MEASUREMENT 4 System Performance Check - 2450MHz
MEASUREMENT 5 System Performance Check - 2600MHz
MEASUREMENT 6 System Performance Check - 5200MHz
MEASUREMENT 7 System Performance Check - 5800MHz

MEASUREMENT 1

Date of measurement: 25/4/2025

A. Experimental conditions.

Area Scan	<u>dx=15mm dy=15mm, h= 5.00 mm</u>
ZoomScan	<u>5x5x7, dx=8mm dy=8mm dz=5mm</u>
Phantom	<u>Validation plane</u>
Device Position	<u>Dipole</u>
Band	<u>CW835</u>
Channels	<u>Middle</u>
Signal	<u>CW (Crest factor: 1.0)</u>
ConvF	<u>1.66</u>

B. SAR Measurement Results

Frequency (MHz)	835.000000
Relative permittivity (real part)	42.012031
Relative permittivity (imaginary part)	19.131021
Conductivity (S/m)	0.941030
Variation (%)	0.310000

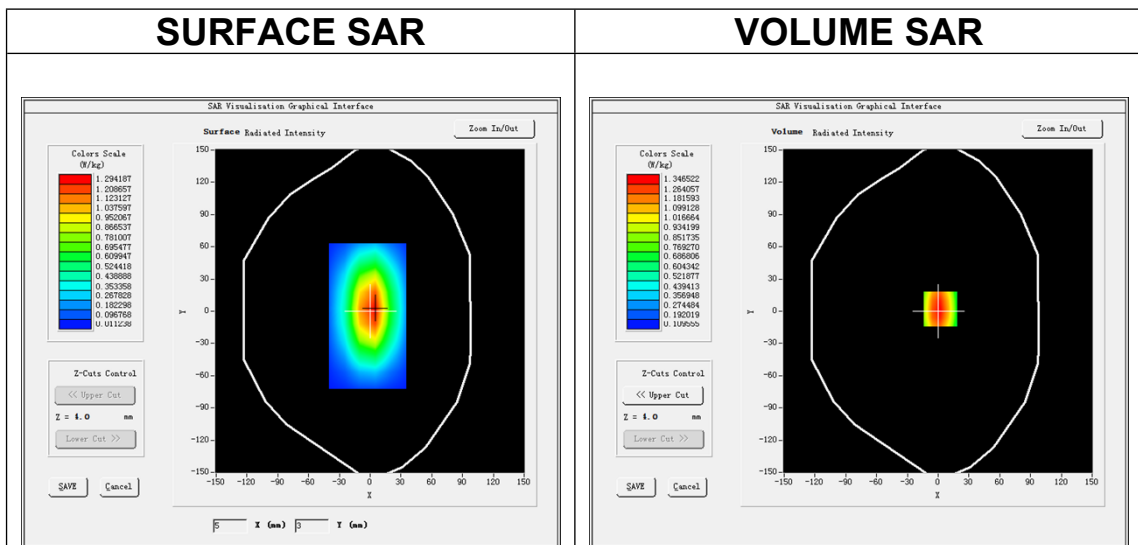

Maximum location: X=2.00, Y=2.00
SAR Peak: 1.87 W/kg

SAR 10g (W/Kg)	0.612031
SAR 1g (W/Kg)	1.011231

Z (mm)	0.00	4.00	9.00	14.00	19.00	24.00	29.00
SAR (W/Kg)	1.2821	0.9559	0.6532	0.4562	0.3263	0.2309	0.1726

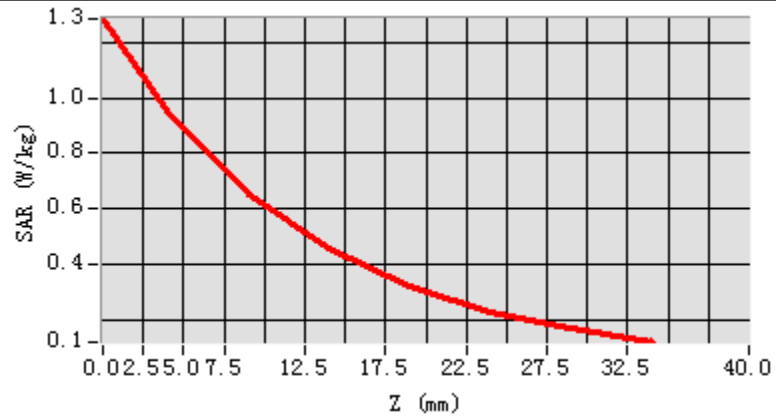

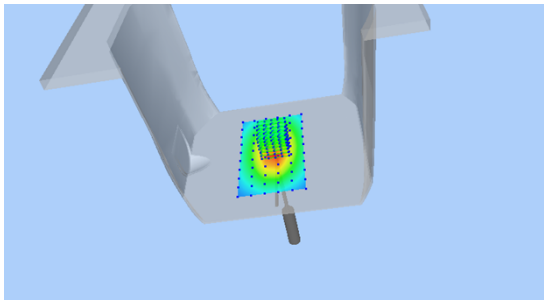
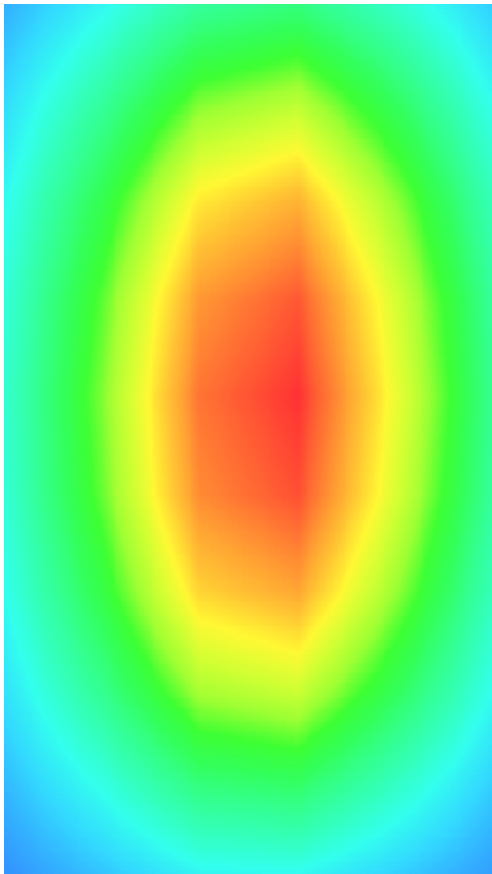
3D screen shot	Hot spot position
 <p>A 3D perspective view of a grey, L-shaped device. A small, multi-colored grid is overlaid on the device's surface, representing the SAR hot spot. The colors range from blue (low SAR) to red (high SAR), with the highest intensity concentrated in the center of the grid.</p>	 <p>A 2D heatmap showing the spatial distribution of the SAR hot spot. The color scale transitions from blue (low SAR) at the edges to red (high SAR) in the center, forming an oval shape. The highest intensity is concentrated in the central region.</p>

MEASUREMENT 2

Date of measurement: 28/4/2025

A. Experimental conditions.

Area Scan	<u>dx=15mm dy=15mm, h= 5.00 mm</u>
ZoomScan	<u>5x5x7, dx=8mm dy=8mm dz=5mm</u>
Phantom	<u>Validation plane</u>
Device Position	<u>Dipole</u>
Band	<u>CW1800</u>
Channels	<u>Middle</u>
Signal	<u>CW (Crest factor: 1.0)</u>
ConvF	<u>2.05</u>

B. SAR Measurement Results

Frequency (MHz)	1800.000000
Relative permittivity (real part)	39.606403
Relative permittivity (imaginary part)	14.067180
Conductivity (S/m)	1.406718
Variation (%)	-0.140000

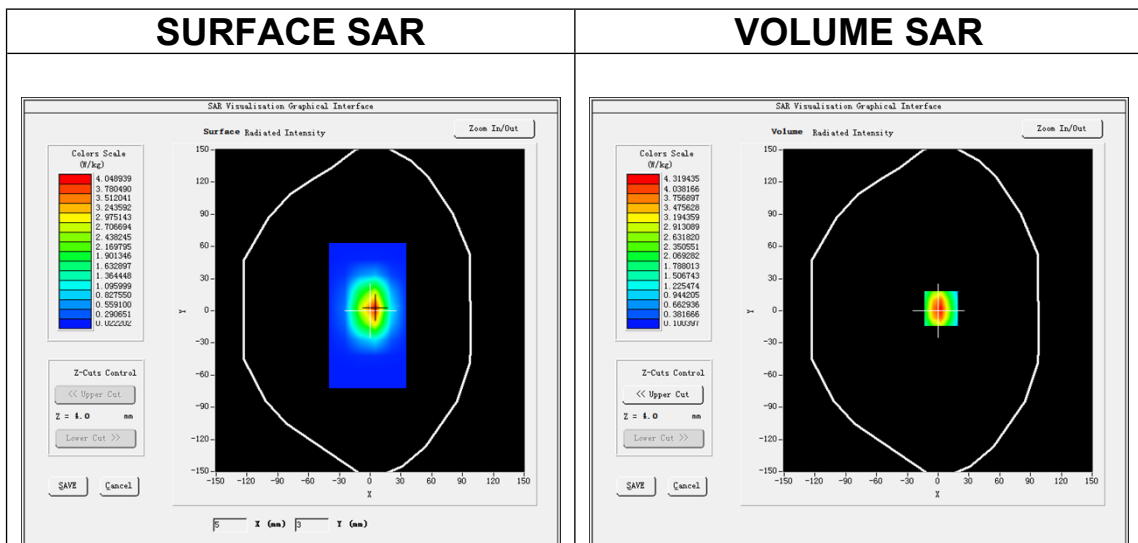

Maximum location: X=3.00, Y=2.00
SAR Peak: 6.82 W/kg

SAR 10g (W/Kg)	2.024557
SAR 1g (W/Kg)	3.832112

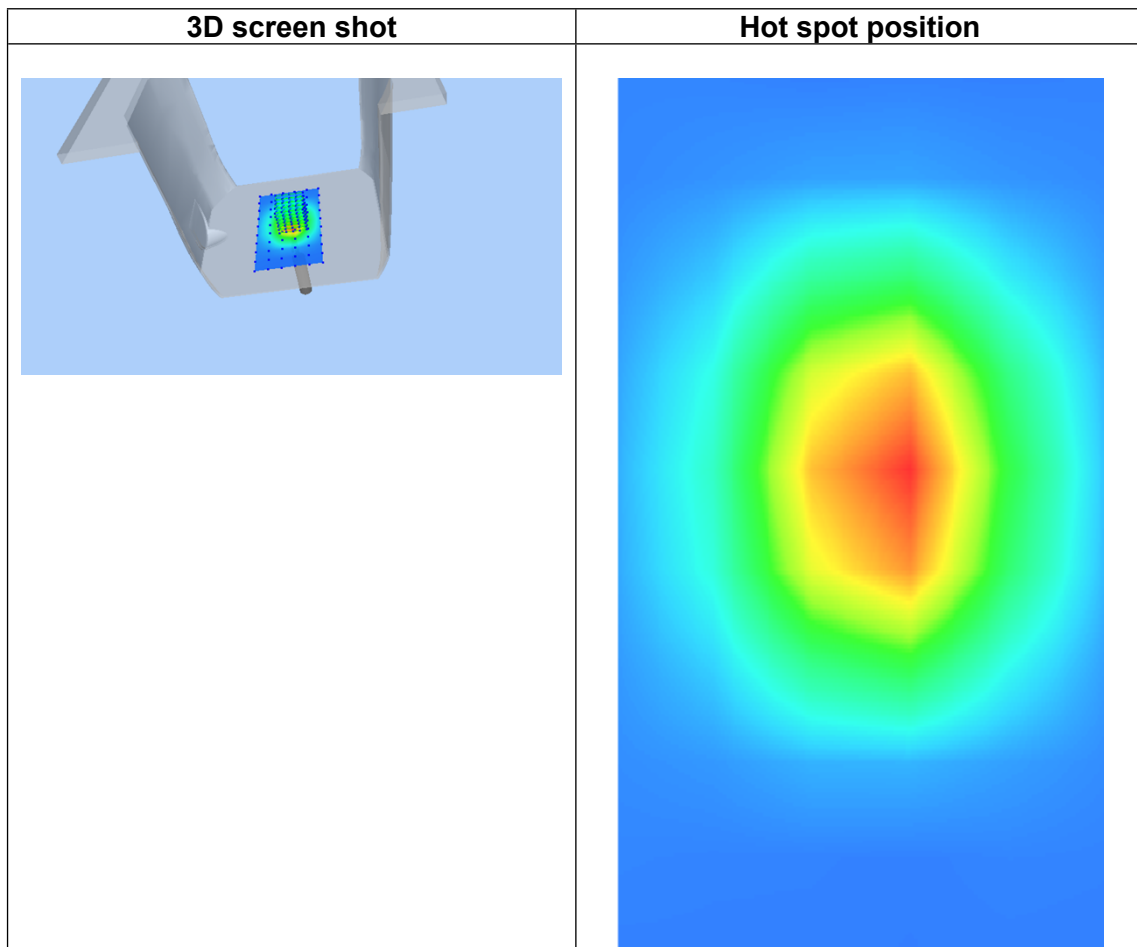
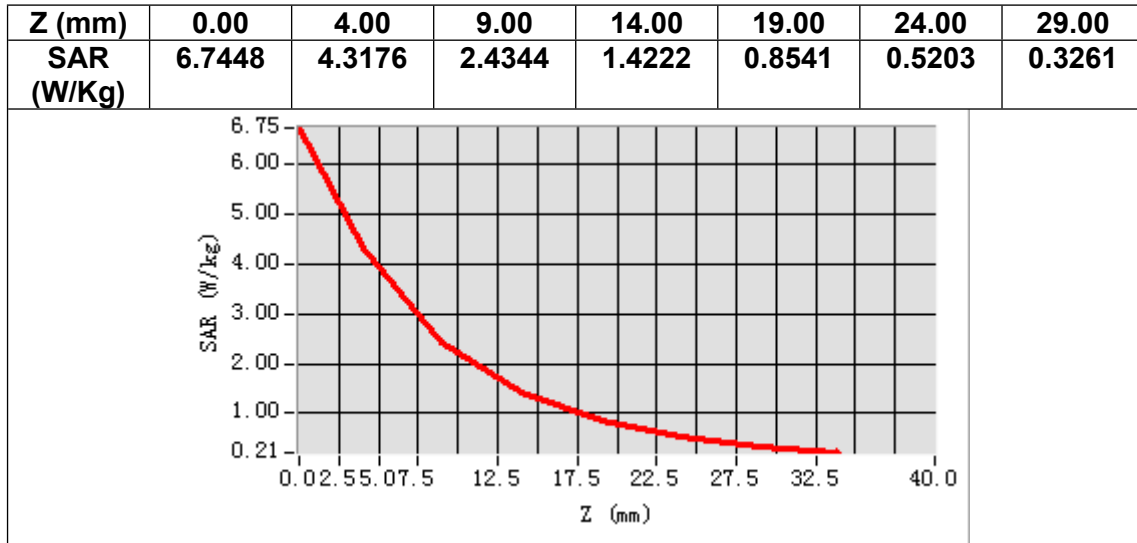

MEASUREMENT 3

Date of measurement: 29/4/2025

A. Experimental conditions.

Area Scan	<u>dx=15mm dy=15mm, h= 5.00 mm</u>
ZoomScan	<u>5x5x7, dx=8mm dy=8mm dz=5mm</u>
Phantom	<u>Validation plane</u>
Device Position	<u>Dipole</u>
Band	<u>CW1900</u>
Channels	<u>Middle</u>
Signal	<u>CW (Crest factor: 1.0)</u>
ConvF	<u>2.05</u>

B. SAR Measurement Results

Frequency (MHz)	1900.000000
Relative permittivity (real part)	41.420140
Relative permittivity (imaginary part)	12.570123
Conductivity (S/m)	1.390503
Variation (%)	-0.440000

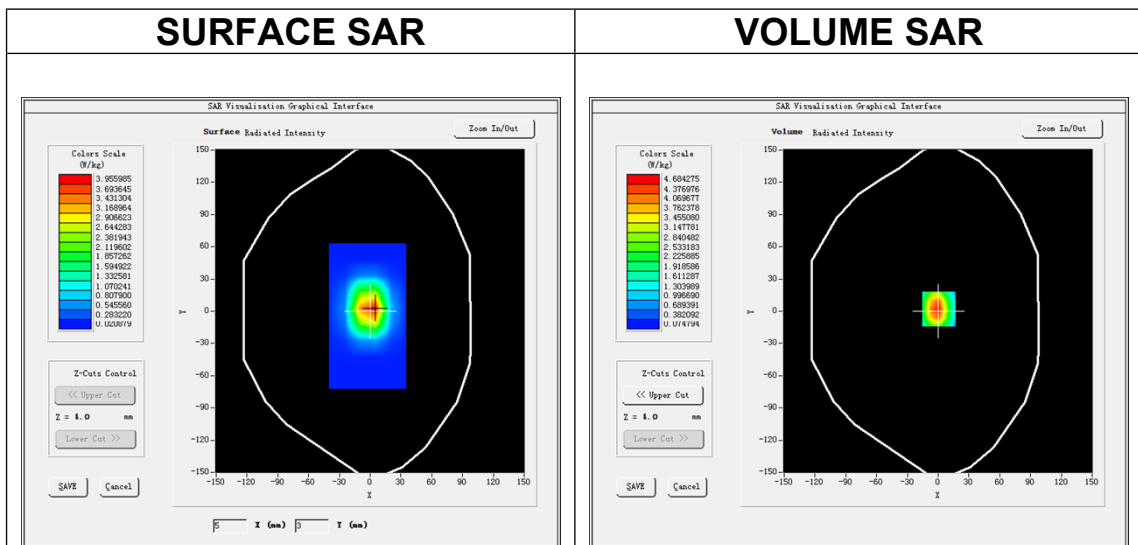

Maximum location: X=1.00, Y=2.00

SAR Peak: 7.65 W/kg

SAR 10g (W/Kg)	2.153165
SAR 1g (W/Kg)	4.153568

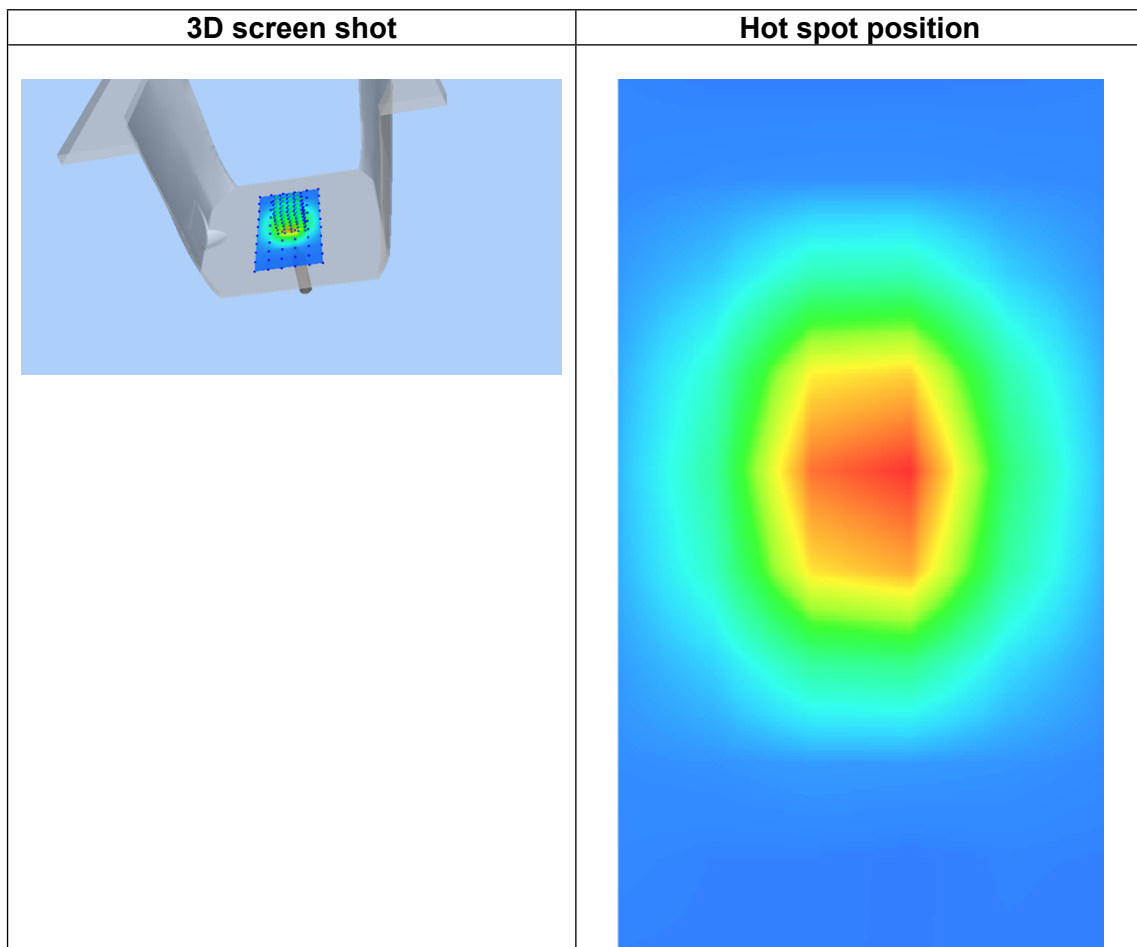
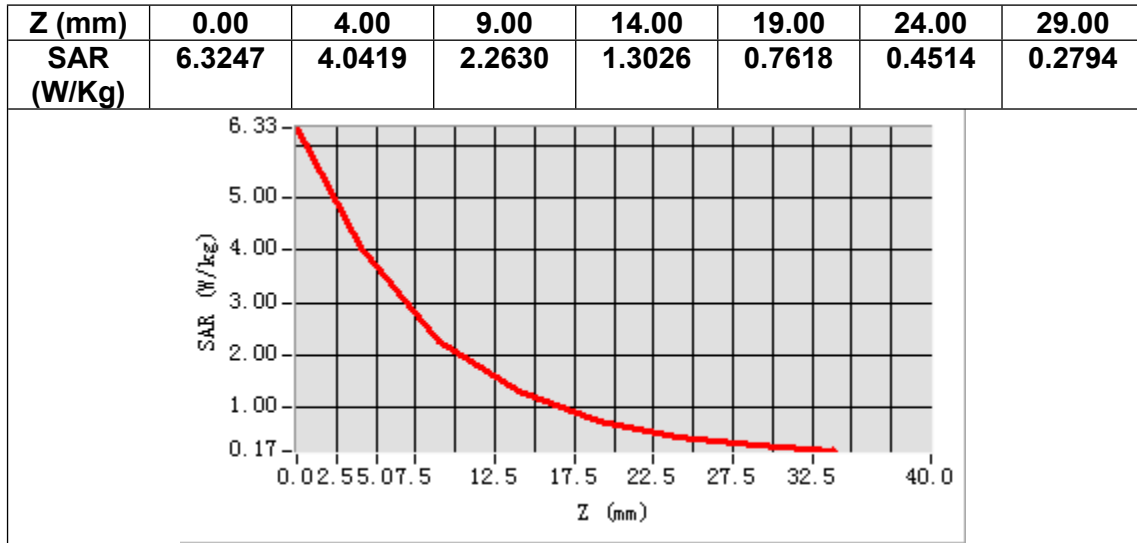

MEASUREMENT 4

Date of measurement: 30/4/2025

A. Experimental conditions.

Area Scan	<u>dx=12mm dy=12mm, h= 5.00 mm</u>
ZoomScan	<u>7x7x7, dx=5mm dy=5mm dz=5mm</u>
Phantom	<u>Validation plane</u>
Device Position	<u>Dipole</u>
Band	<u>CW2450</u>
Channels	<u>Middle</u>
Signal	<u>CW (Crest factor: 1.0)</u>
ConvF	<u>2.38</u>

B. SAR Measurement Results

Frequency (MHz)	2450.000000
Relative permittivity (real part)	40.408511
Relative permittivity (imaginary part)	13.399264
Conductivity (S/m)	1.823789
Variation (%)	-1.250000

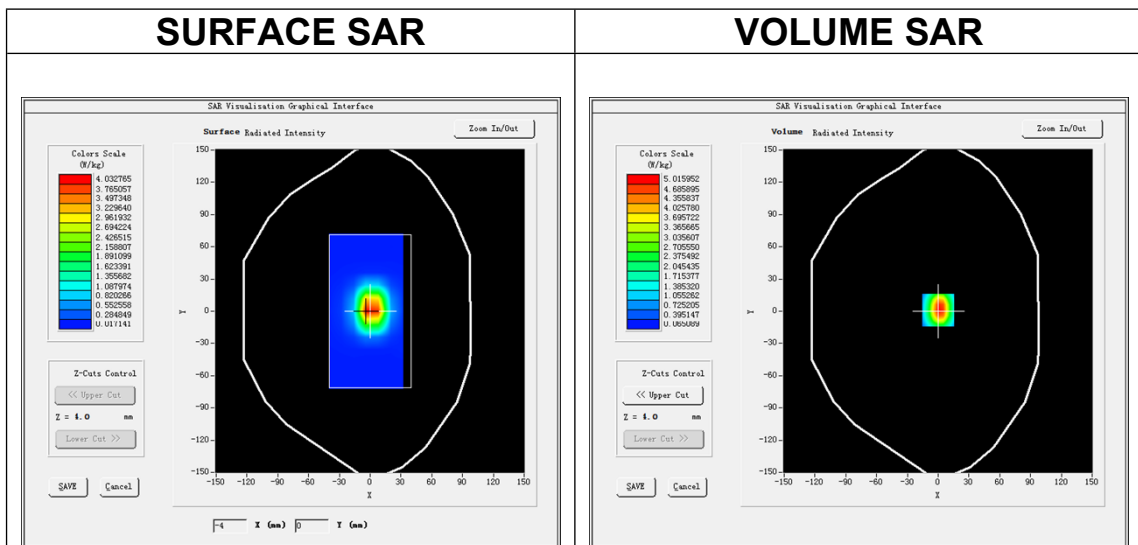

Maximum location: X=0.00, Y=1.00
SAR Peak: 8.14 W/kg

SAR 10g (W/Kg)	2.359425
SAR 1g (W/Kg)	5.183642

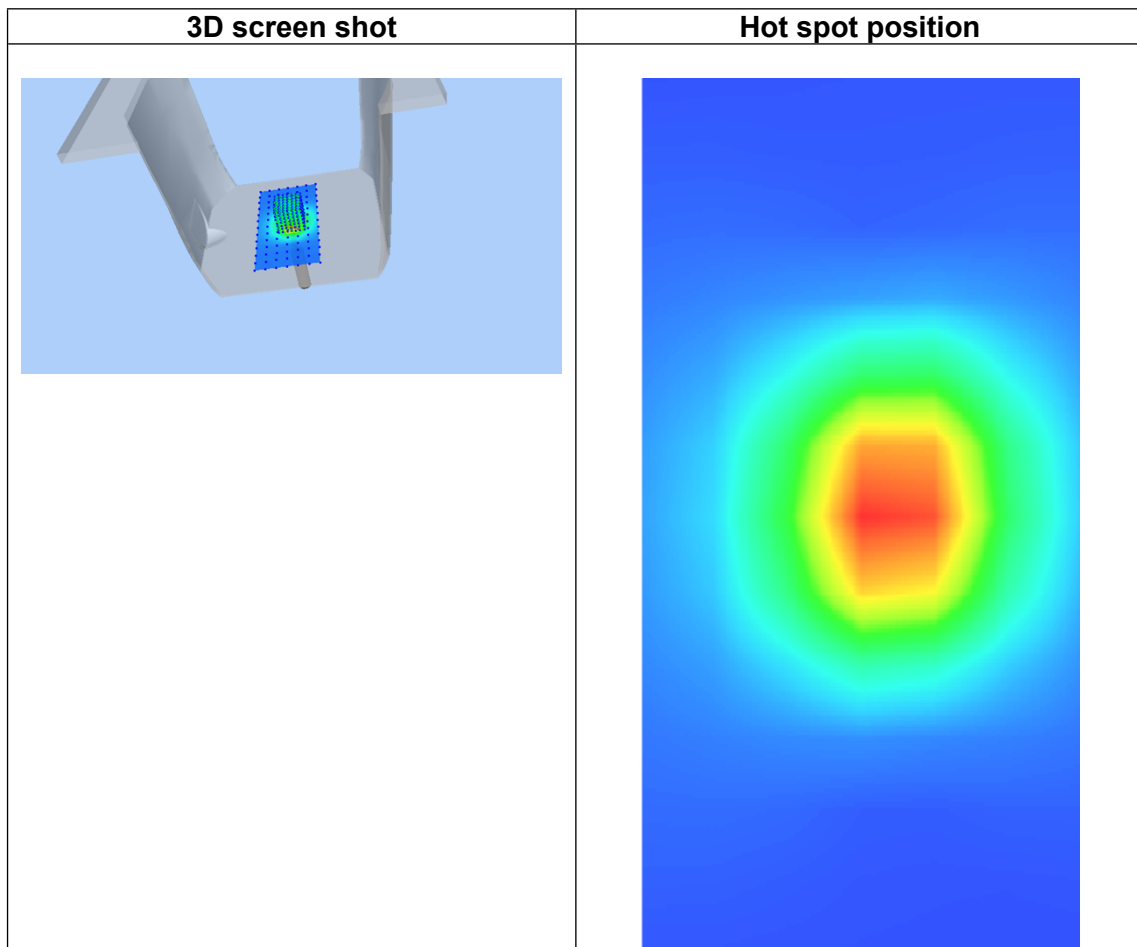
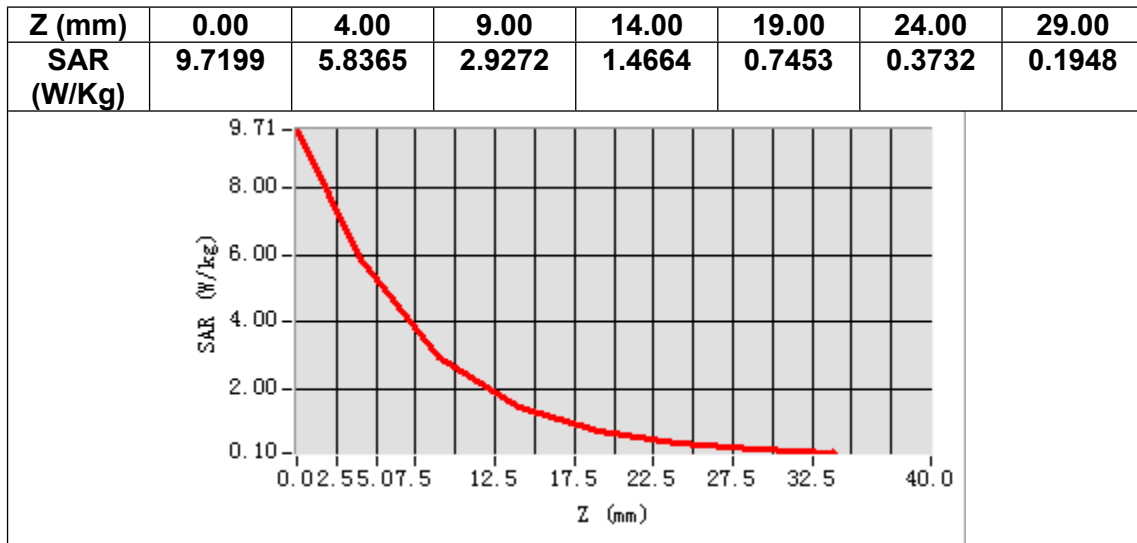

MEASUREMENT 5

Date of measurement: 1/5/2025

A. Experimental conditions.

Area Scan	<u>dx=12mm dy=12mm, h= 5.00 mm</u>
ZoomScan	<u>7x7x7, dx=5mm dy=5mm dz=5mm</u>
Phantom	<u>Validation plane</u>
Device Position	<u>Dipole</u>
Band	<u>CW2600</u>
Channels	<u>Middle</u>
Signal	<u>CW (Crest factor: 1.0)</u>
ConvF	<u>2.35</u>

B. SAR Measurement Results

Frequency (MHz)	2600.000000
Relative permittivity (real part)	39.432362
Relative permittivity (imaginary part)	13.768602
Conductivity (S/m)	1.988798
Variation (%)	-3.980000

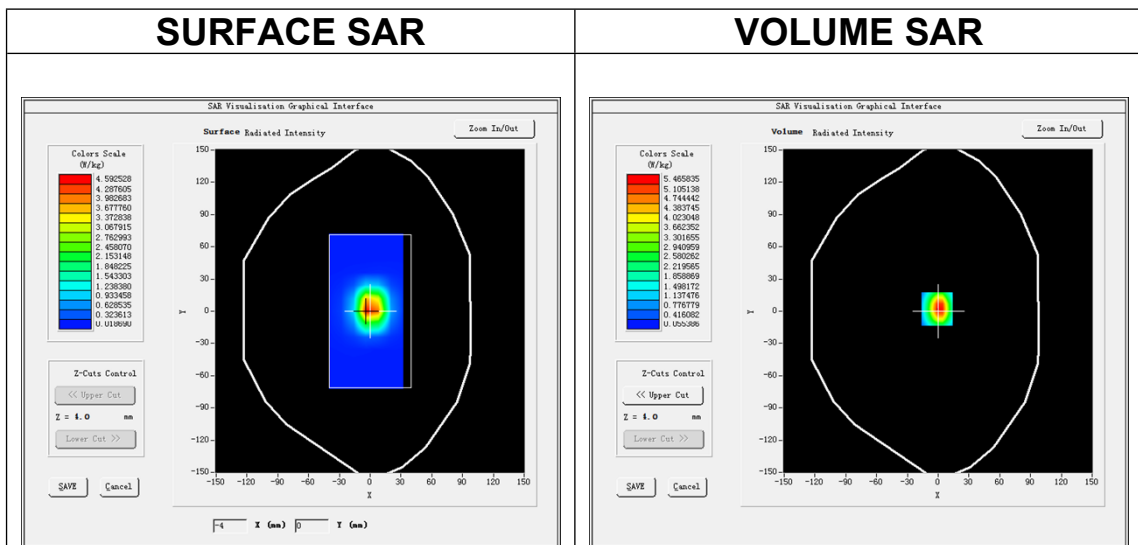

Maximum location: X=-1.00, Y=2.00
SAR Peak: 9.07 W/kg

SAR 10g (W/Kg)	2.523157
SAR 1g (W/Kg)	5.432595

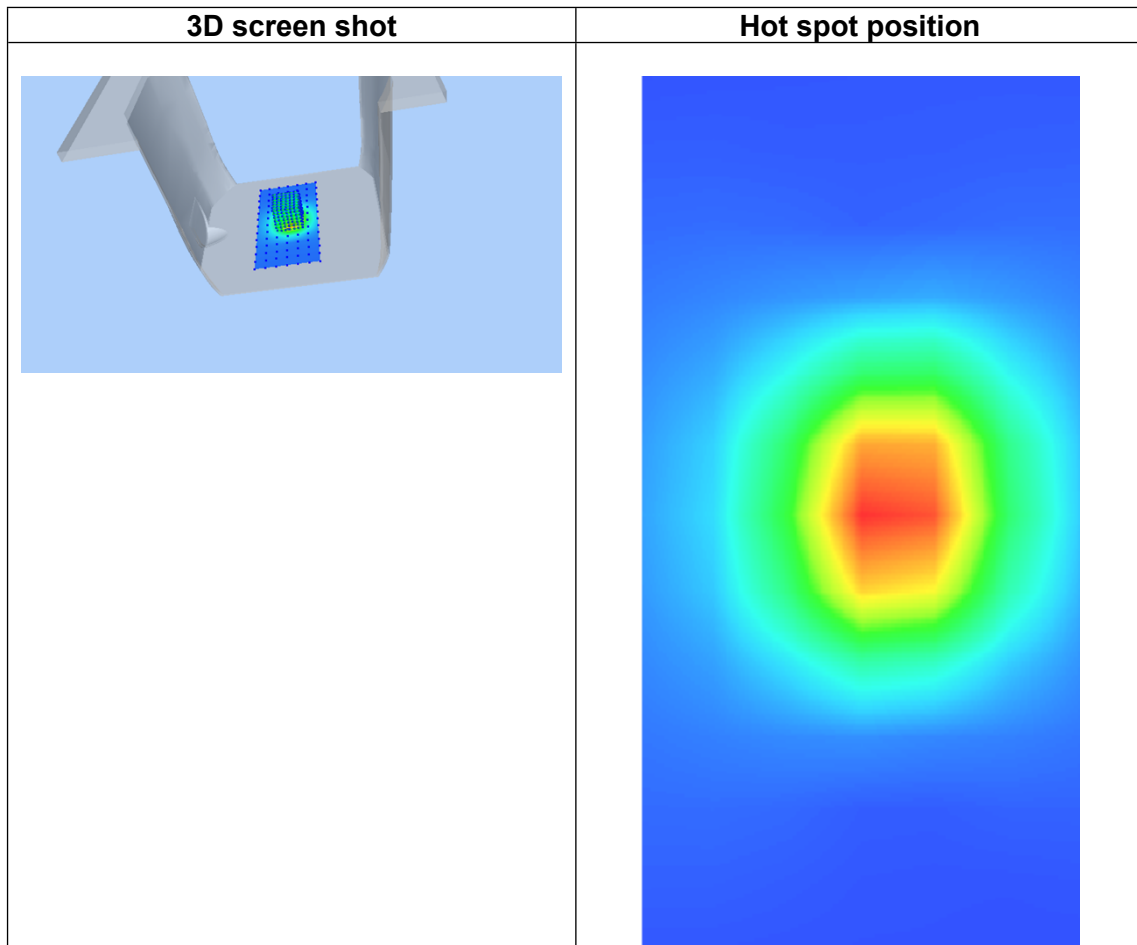
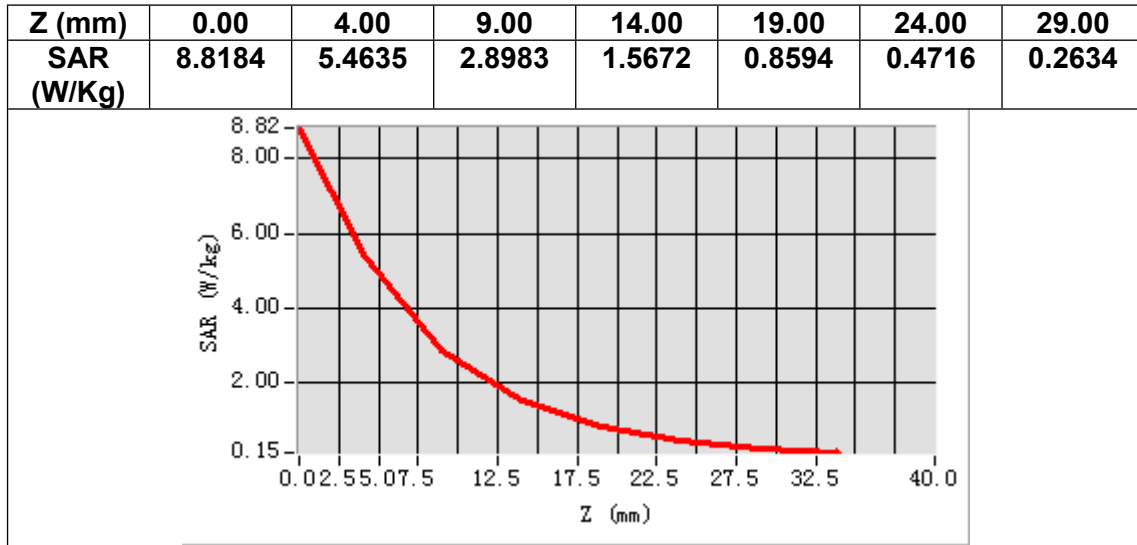

MEASUREMENT 6

Date of measurement: 2/5/2025

A. Experimental conditions.

Area Scan	<u>dx=10mm dy=10mm, h= 2.00 mm</u>
ZoomScan	<u>7x7x12,dx=4mm dy=4mm dz=2mm</u>
Phantom	<u>Validation plane</u>
Device Position	<u>Dipole</u>
Band	<u>CW5200</u>
Channels	<u>Middle</u>
Signal	<u>CW (Crest factor: 1.0)</u>
ConvF	<u>2.30</u>

B. SAR Measurement Results

Frequency (MHz)	5200.000000
Relative permittivity (real part)	37.400000
Relative permittivity (imaginary part)	16.129999
Conductivity (S/m)	4.510778
Variation (%)	-4.570000

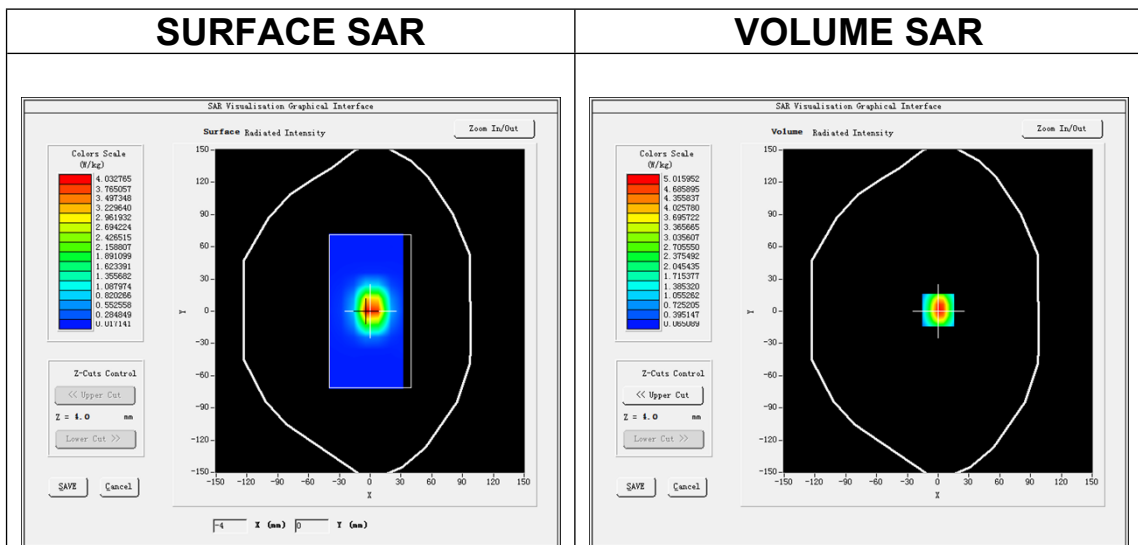

Maximum location: X=0.00, Y=1.00

SAR Peak: 15.14 W/kg

SAR 10g (W/Kg)	5.212361
SAR 1g (W/Kg)	14.712032

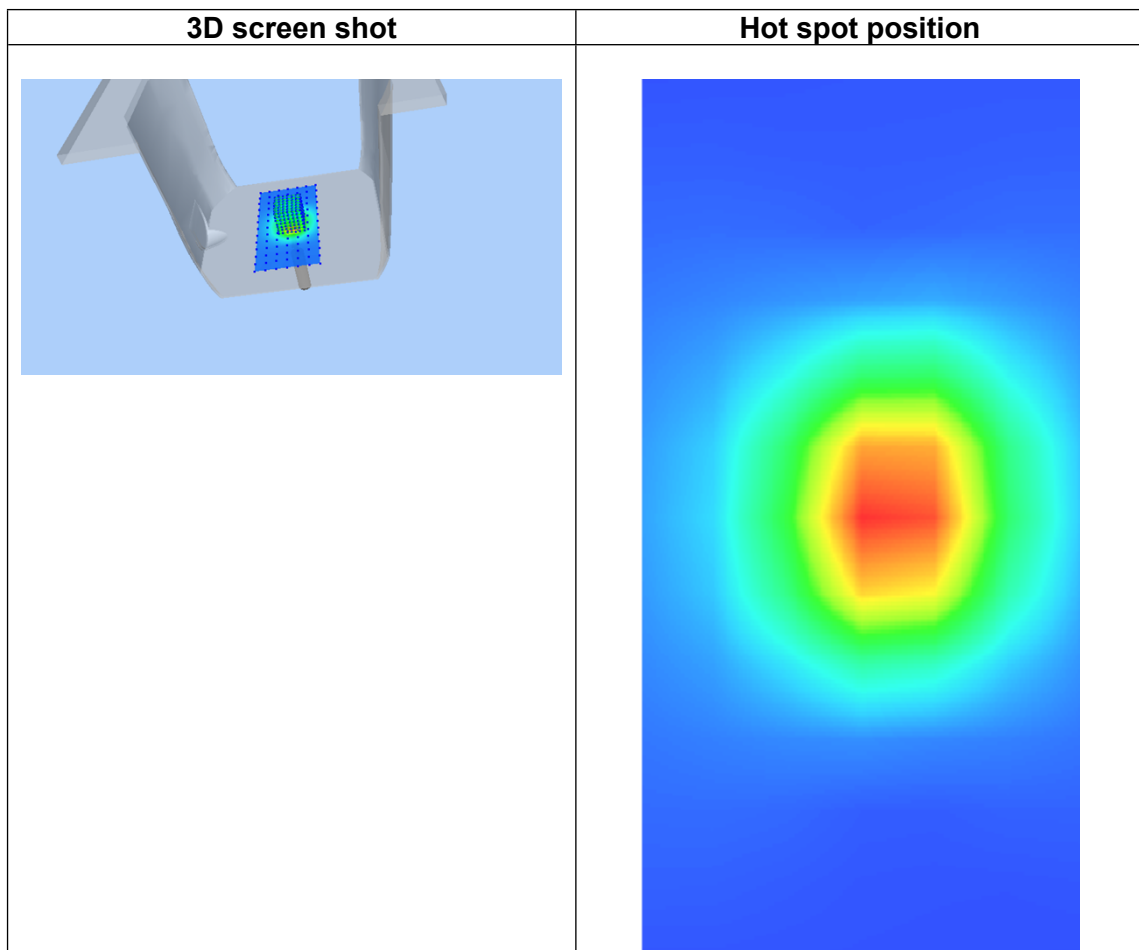
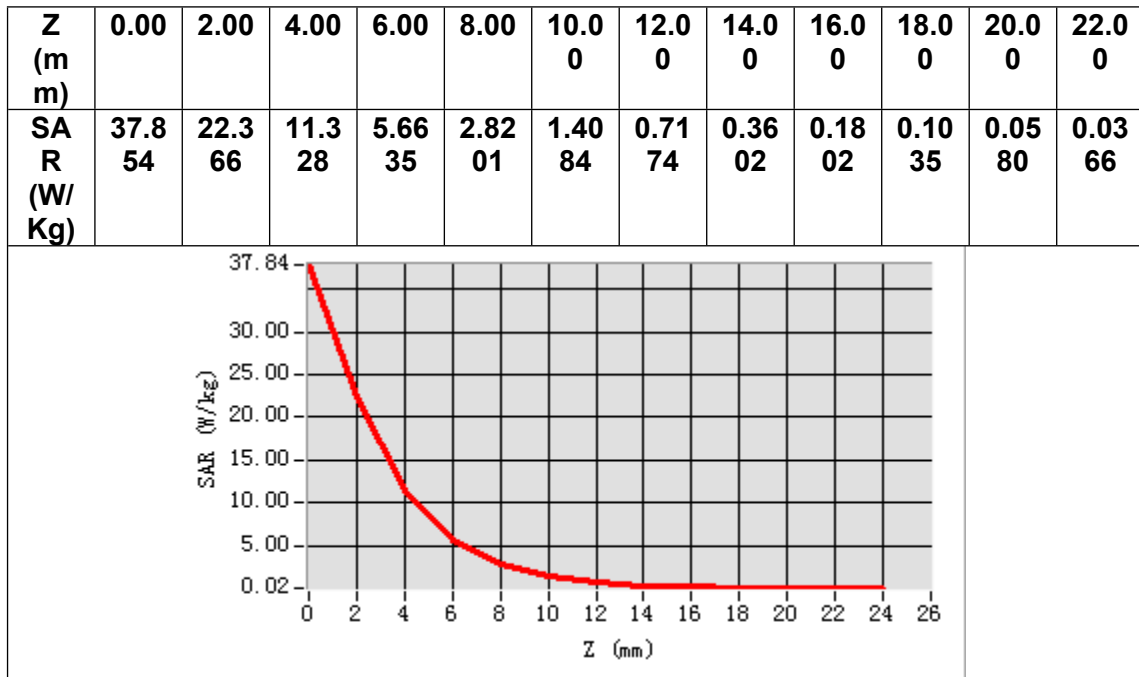

MEASUREMENT 7

Date of measurement: 5/5/2025

A. Experimental conditions.

Area Scan	<u>dx=10mm dy=10mm, h= 2.00 mm</u>
ZoomScan	<u>7x7x12,dx=4mm dy=4mm dz=2mm</u>
Phantom	<u>Validation plane</u>
Device Position	<u>Dipole</u>
Band	<u>CW5800</u>
Channels	<u>Middle</u>
Signal	<u>CW (Crest factor: 1.0)</u>
ConvF	<u>2.27</u>

B. SAR Measurement Results

Frequency (MHz)	5800.000000
Relative permittivity (real part)	35.299999
Relative permittivity (imaginary part)	16.360001
Conductivity (S/m)	5.271556
Variation (%)	-2.480000

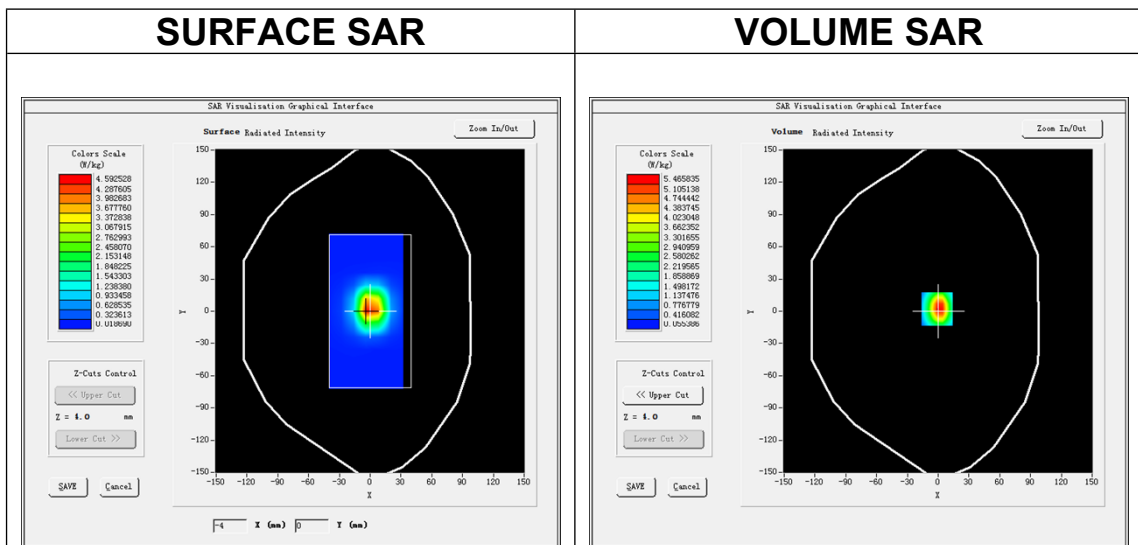

Maximum location: X=-1.00, Y=2.00
SAR Peak: 17.07 W/kg

SAR 10g (W/Kg)	5.623106
SAR 1g (W/Kg)	16.421035

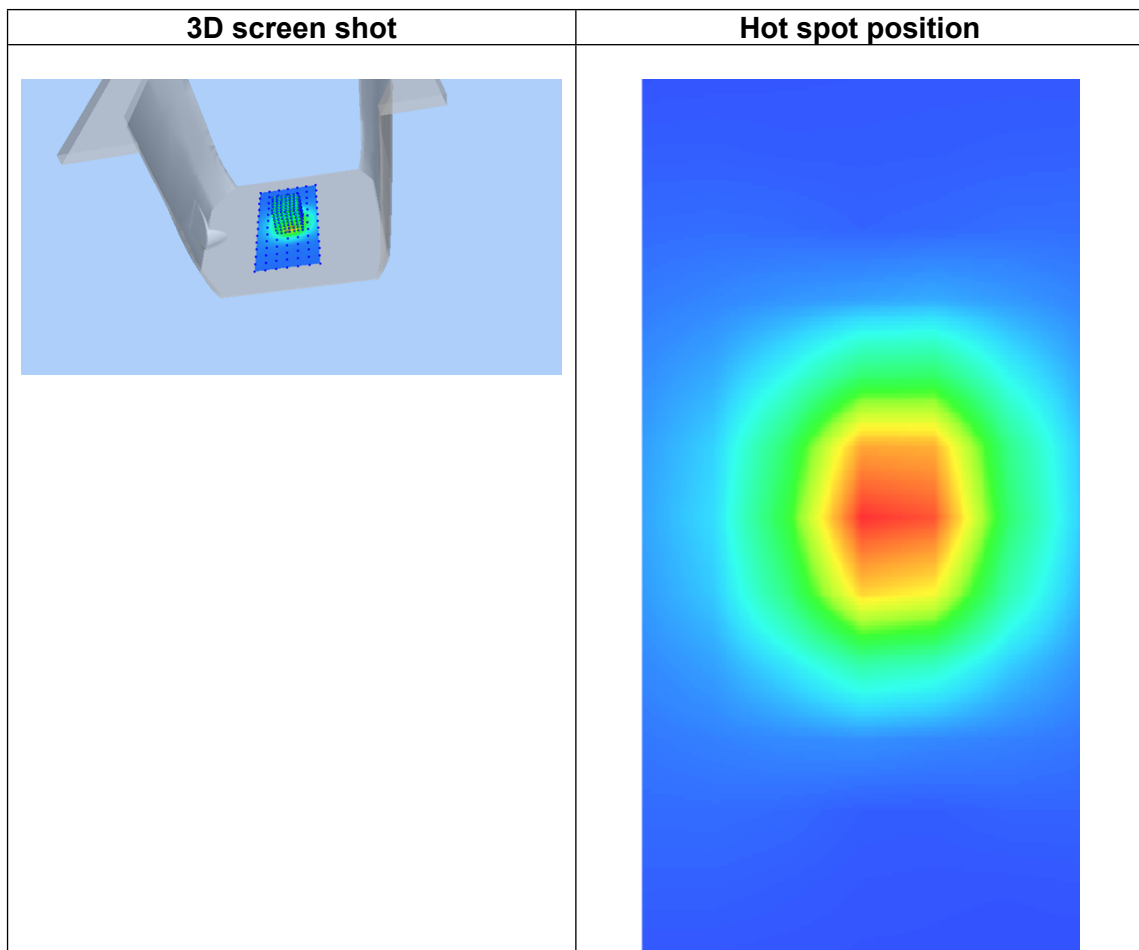
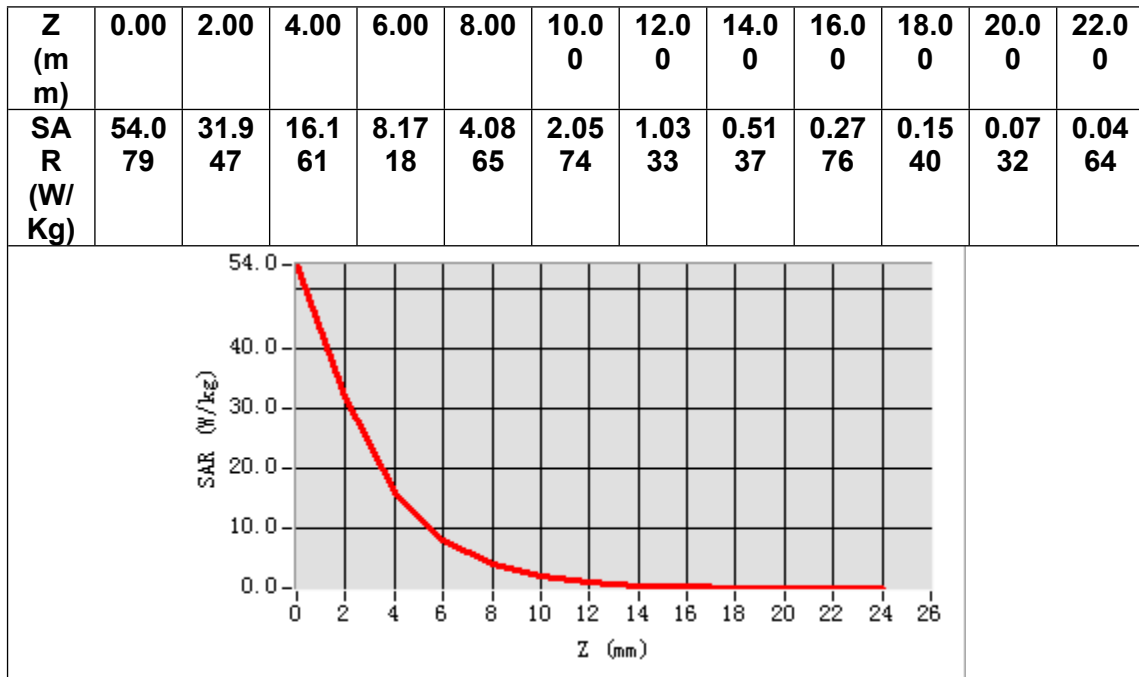

Appendix C. SAR Test Plots

Table of contents
MEASUREMENT 1 GSM 850 Head
MEASUREMENT 2 GSM 850 Body
MEASUREMENT 3 GSM 1900 Head
MEASUREMENT 4 GSM 1900 Body
MEASUREMENT 5 WCDMA Band 2 Head
MEASUREMENT 6 WCDMA Band 2 Body
MEASUREMENT 7 WCDMA Band 5 Head
MEASUREMENT 8 WCDMA Band 5 Body
MEASUREMENT 9 WALN 5.2G Head
MEASUREMENT 10 WALN 5.8G Head
MEASUREMENT 11 WALN 5.2G Body
MEASUREMENT 12 WALN 5.8G Body
MEASUREMENT 13 WALN 2.4G Head
MEASUREMENT 14 WALN 2.4G Body
MEASUREMENT 15 LTE Band 2 Head
MEASUREMENT 16 LTE Band 2 Body
MEASUREMENT 17 LTE Band 4 Head
MEASUREMENT 18 LTE Band 4 Body
MEASUREMENT 19 LTE Band 5 Head
MEASUREMENT 20 LTE Band 5 Body
MEASUREMENT 21 LTE Band 7 Head
MEASUREMENT 22 LTE Band 7 Body

MEASUREMENT 1

Date of measurement: 25/4/2025

A. Experimental conditions.

Area Scan	<u>dx=15mm dy=15mm, h= 5.00 mm</u>
ZoomScan	<u>5x5x7,dx=8mm dy=8mm dz=5mm</u>
Phantom	<u>Left head</u>
Device Position	<u>Cheek</u>
Band	<u>GSM850</u>
Channels	<u>Middle</u>
Signal	<u>TDMA (Crest factor: 4.0)</u>
ConvF	<u>1.66</u>

B. SAR Measurement Results

Frequency (MHz)	836.400024
Relative permittivity (real part)	41.500000
Relative permittivity (imaginary part)	19.400000
Conductivity (S/m)	0.901453
Variation (%)	-1.740000

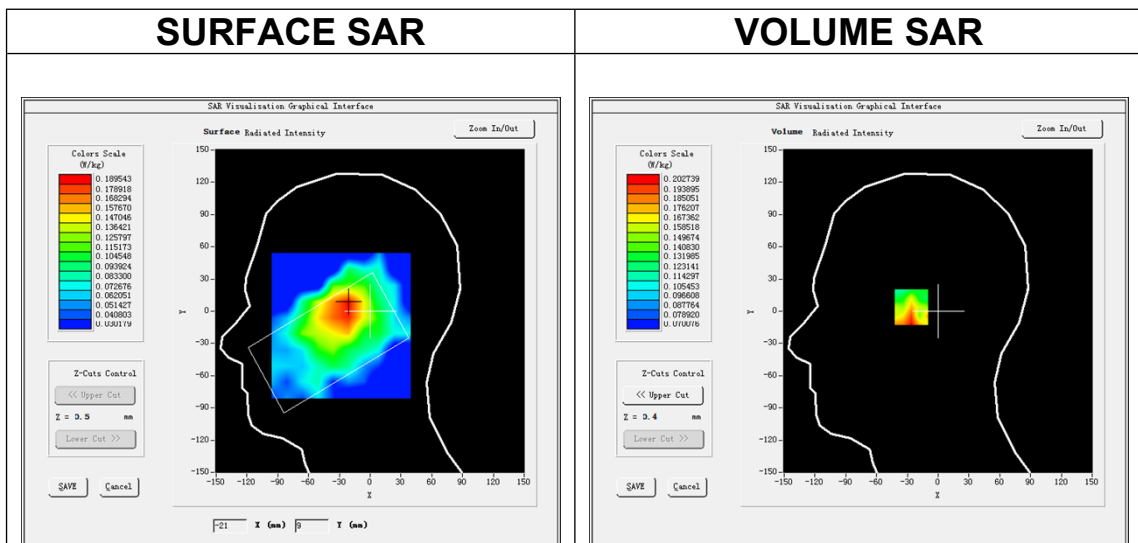

Maximum location: X=-23.00, Y=5.00
SAR Peak: 0.36 W/kg

SAR 10g (W/Kg)	0.154444
SAR 1g (W/Kg)	0.198576

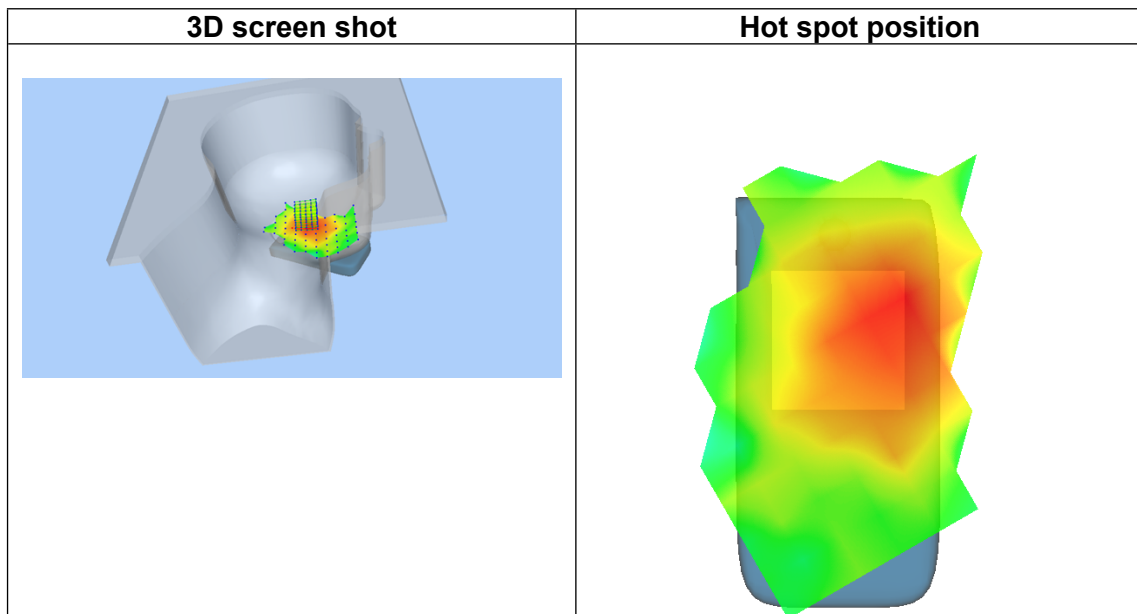
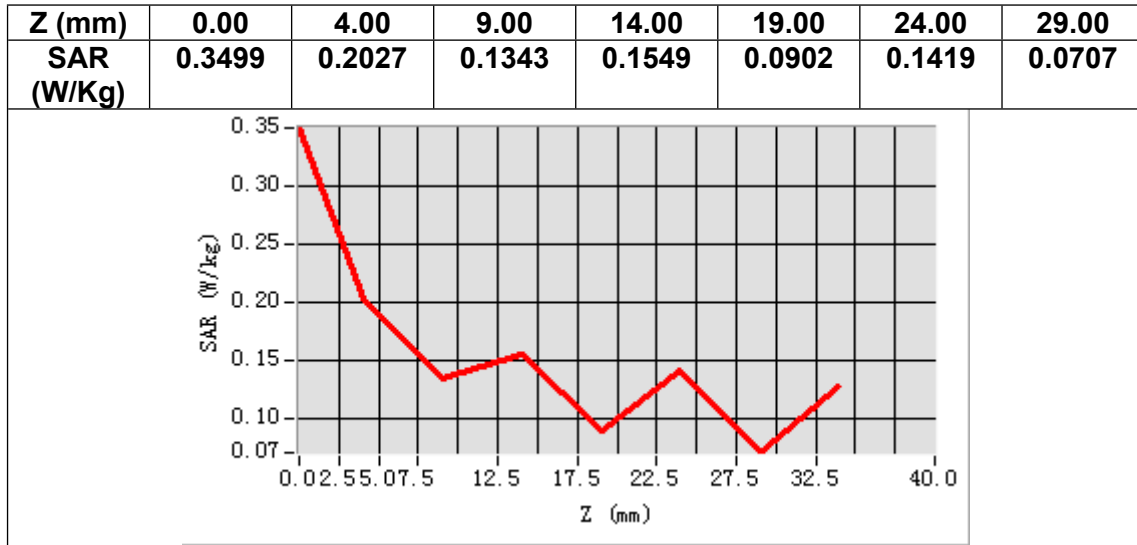

MEASUREMENT 2

Date of measurement: 25/4/2025

A. Experimental conditions.

Area Scan	<u>dx=15mm dy=15mm, h= 5.00 mm</u>
ZoomScan	<u>5x5x7, dx=8mm dy=8mm dz=5mm</u>
Phantom	<u>Validation plane</u>
Device Position	<u>Body</u>
Band	<u>GSM850</u>
Channels	<u>Middle</u>
Signal	<u>TDMA (Crest factor: 4.0)</u>
ConvF	<u>1.66</u>

B. SAR Measurement Results

Frequency (MHz)	836.400024
Relative permittivity (real part)	41.500000
Relative permittivity (imaginary part)	19.400000
Conductivity (S/m)	0.901453
Variation (%)	-4.610000

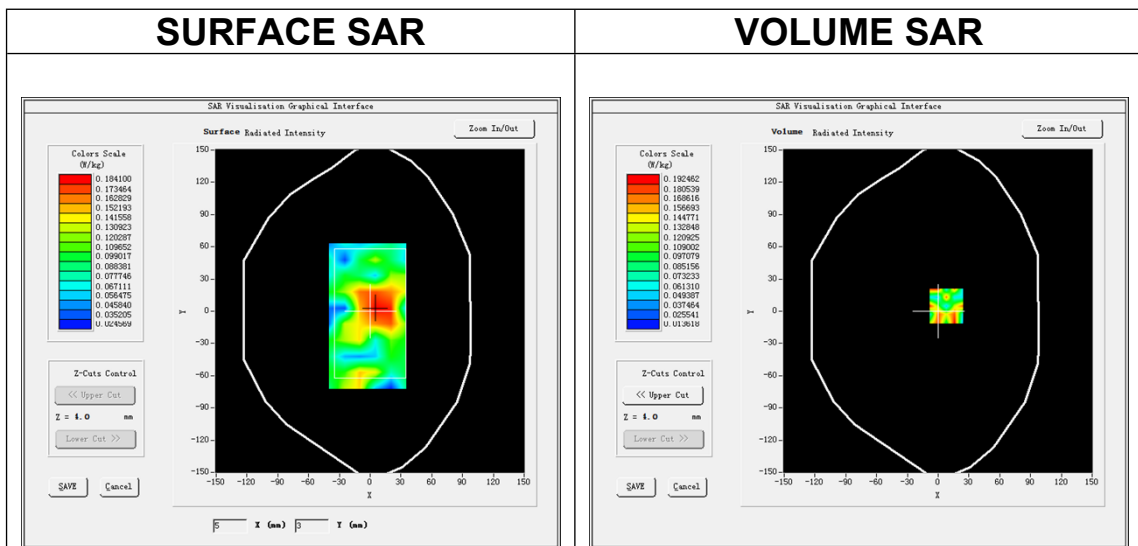

Maximum location: X=8.00, Y=5.00
SAR Peak: 0.53 W/kg

SAR 10g (W/Kg)	0.113049
SAR 1g (W/Kg)	0.189934

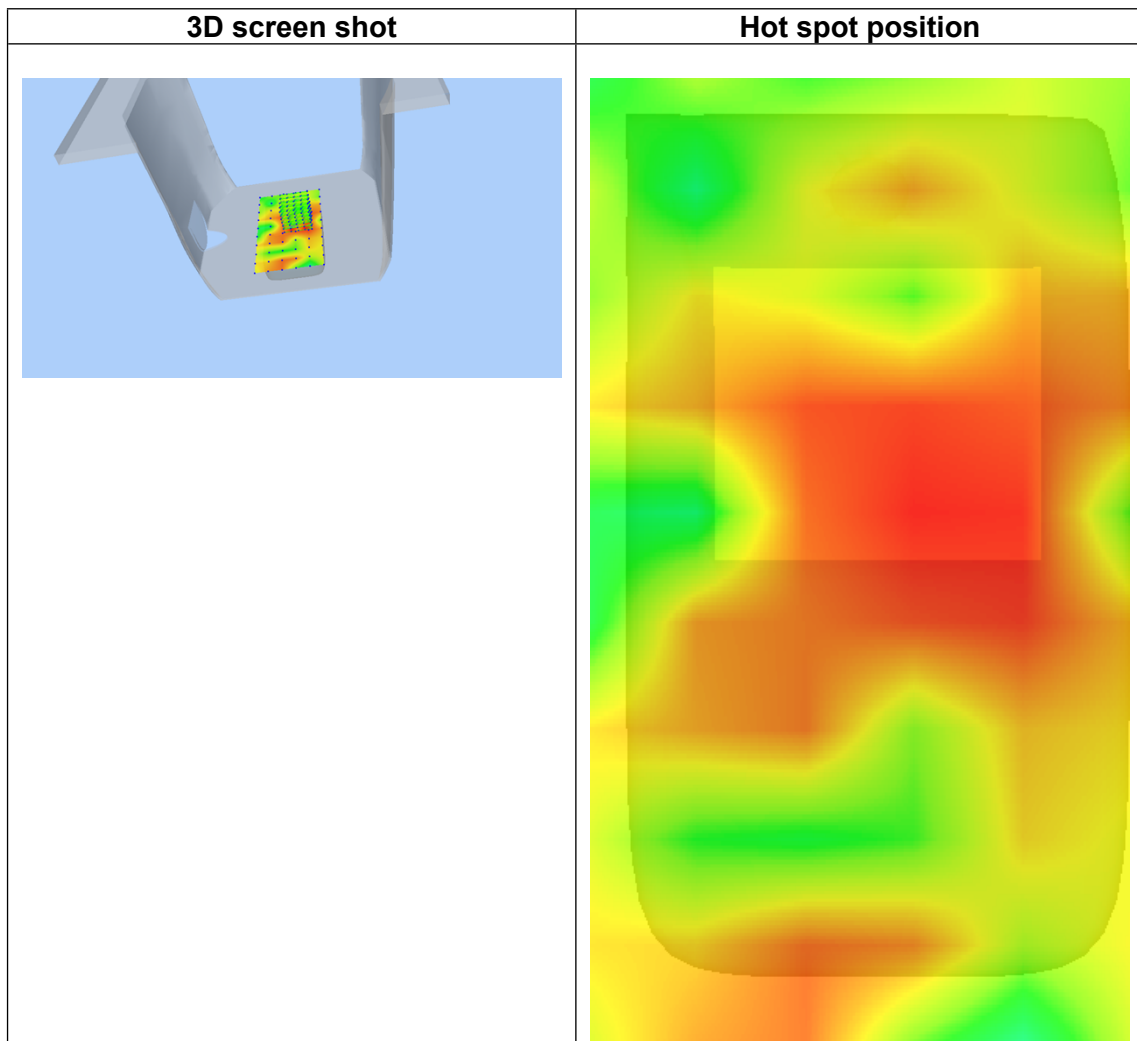
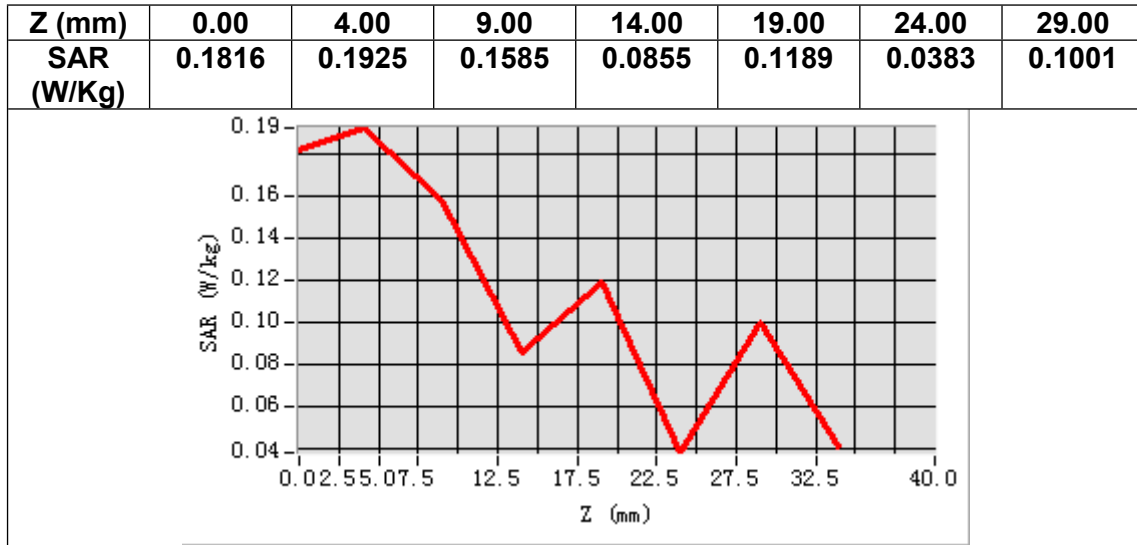

MEASUREMENT 3

Date of measurement: 29/4/2025

A. Experimental conditions.

Area Scan	<u>dx=15mm dy=15mm, h= 5.00 mm</u>
ZoomScan	<u>5x5x7,dx=8mm dy=8mm dz=5mm</u>
Phantom	<u>Left head</u>
Device Position	<u>Cheek</u>
Band	<u>GSM1900</u>
Channels	<u>Middle</u>
Signal	<u>TDMA (Crest factor: 2.7)</u>
ConvF	<u>2.05</u>

B. SAR Measurement Results

Frequency (MHz)	1880.000000
Relative permittivity (real part)	40.000000
Relative permittivity (imaginary part)	13.408000
Conductivity (S/m)	1.400391
Variation (%)	4.120000

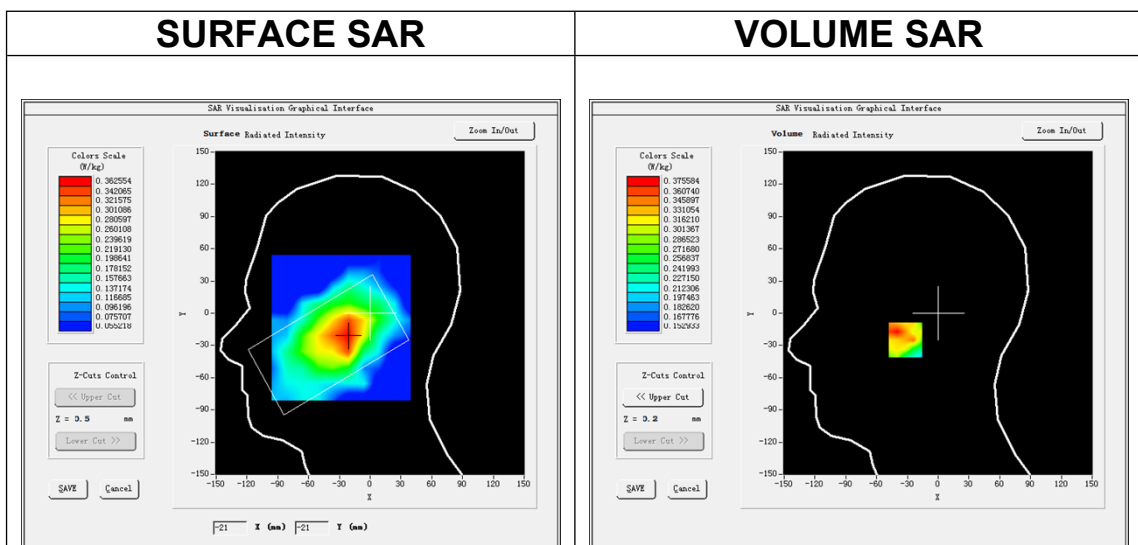

Maximum location: X=-24.00, Y=-25.00
SAR Peak: 0.45 W/kg

SAR 10g (W/Kg)	0.312915
SAR 1g (W/Kg)	0.367882

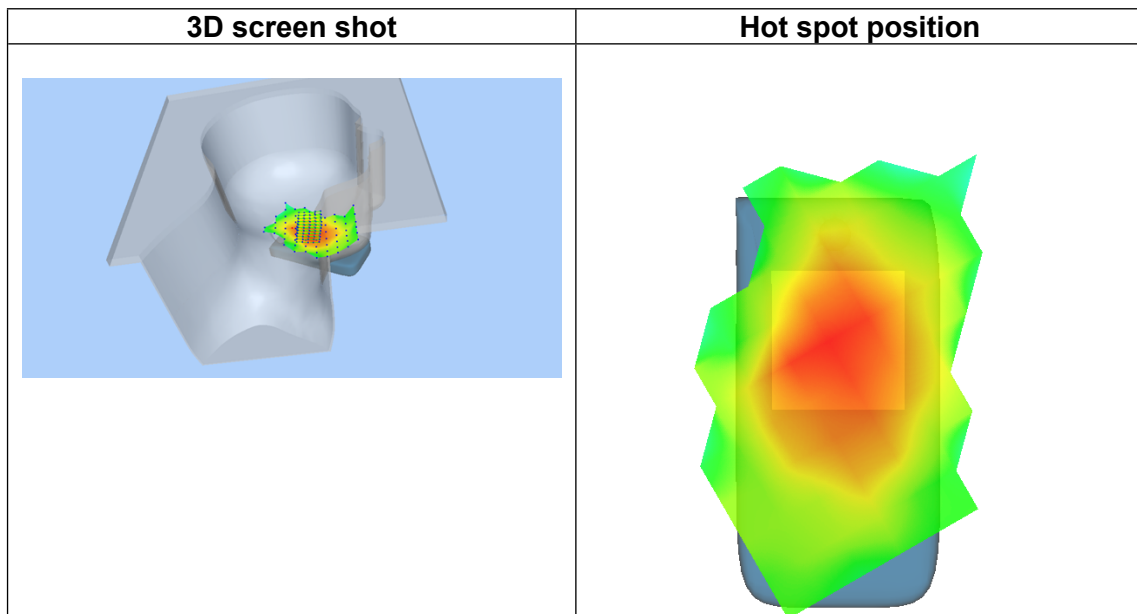
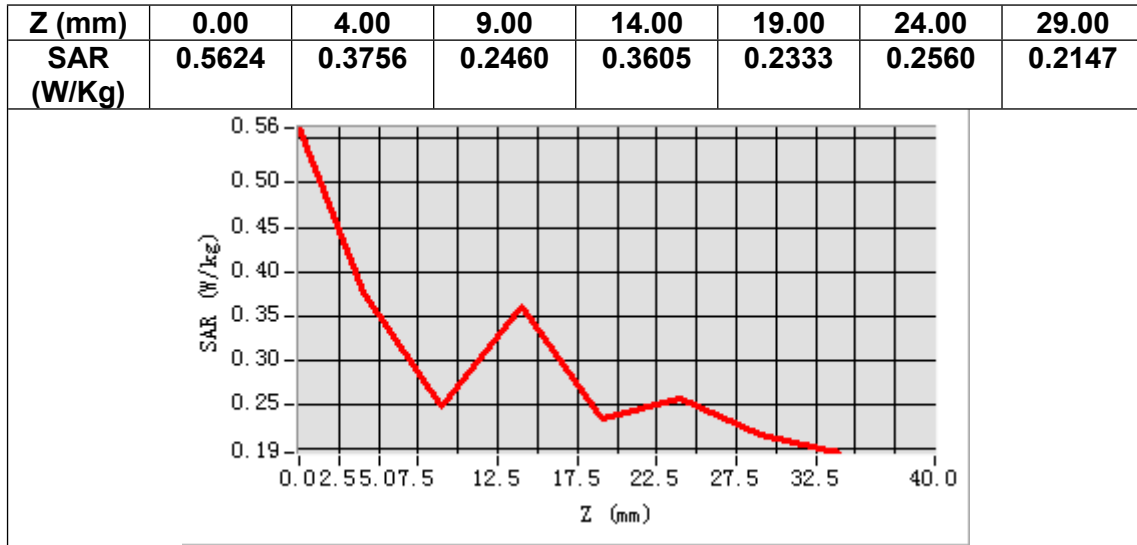

MEASUREMENT 4

Date of measurement: 29/4/2025

A. Experimental conditions.

Area Scan	<u>dx=15mm dy=15mm, h= 5.00 mm</u>
ZoomScan	<u>5x5x7, dx=8mm dy=8mm dz=5mm</u>
Phantom	<u>Validation plane</u>
Device Position	<u>Body</u>
Band	<u>GSM1900</u>
Channels	<u>Middle</u>
Signal	<u>TDMA (Crest factor: 2.7)</u>
ConvF	<u>2.05</u>

B. SAR Measurement Results

Frequency (MHz)	1880.000000
Relative permittivity (real part)	40.000000
Relative permittivity (imaginary part)	13.408000
Conductivity (S/m)	1.400391
Variation (%)	1.540000

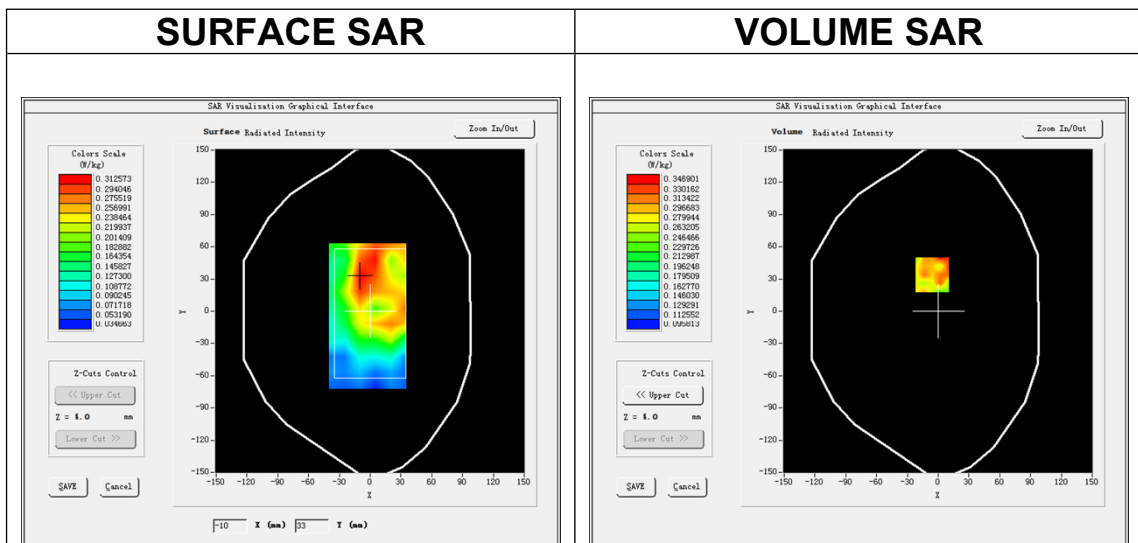

Maximum location: X=-6.00, Y=34.00
SAR Peak: 0.53 W/kg

SAR 10g (W/Kg)	0.257982
SAR 1g (W/Kg)	0.335390

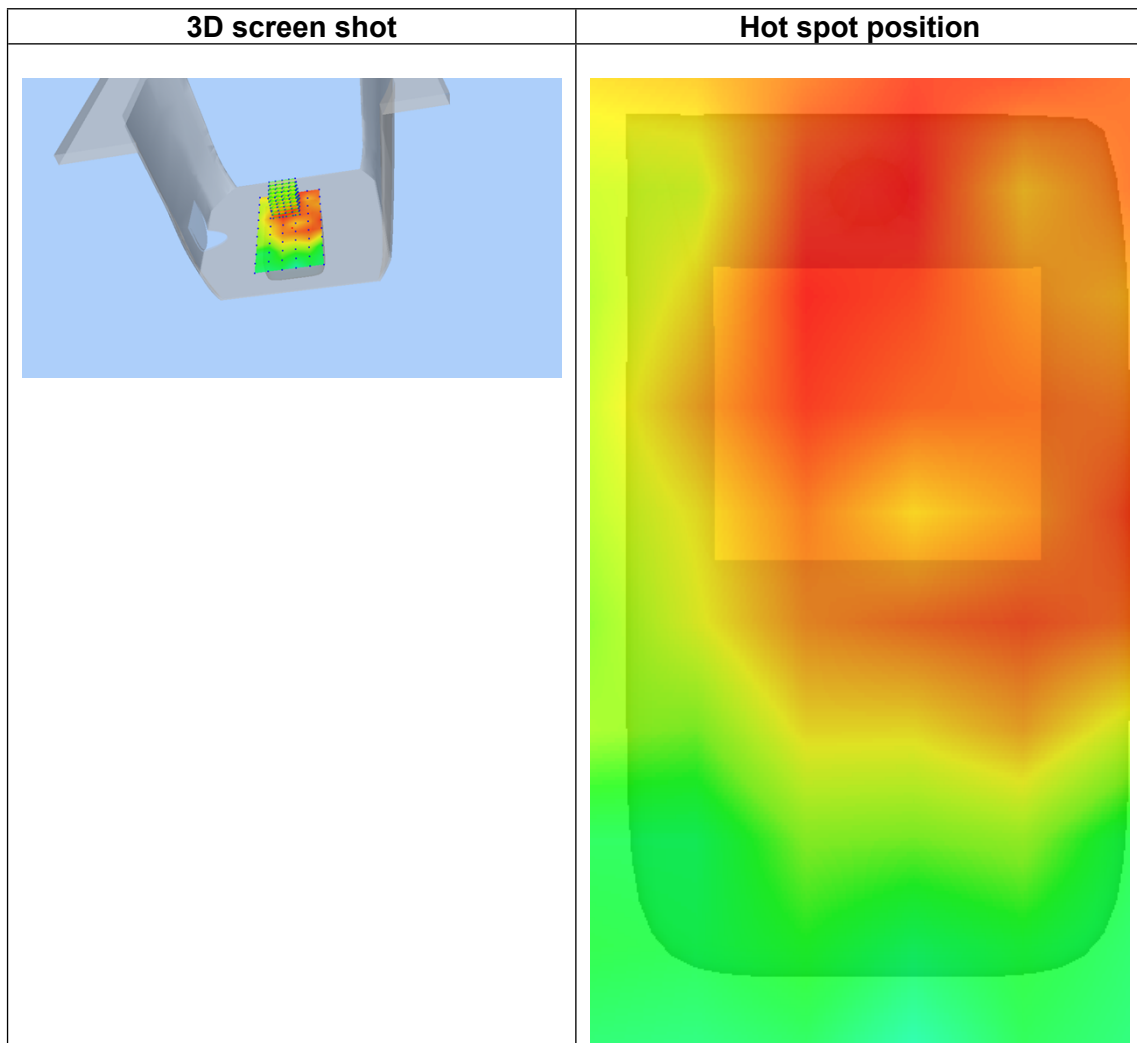
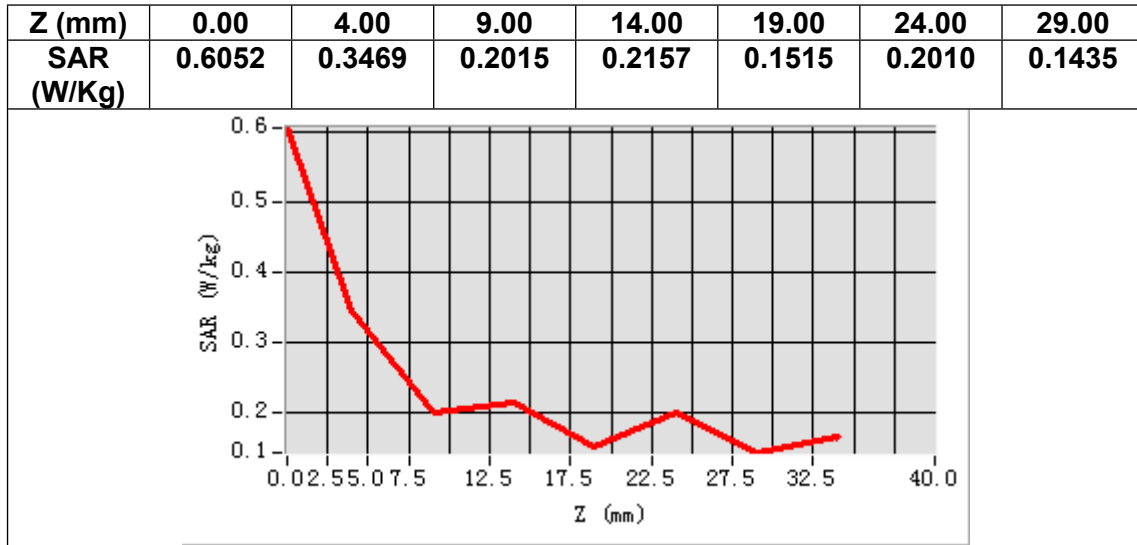

MEASUREMENT 5

Date of measurement: 29/4/2025

A. Experimental conditions.

Area Scan	<u>dx=15mm dy=15mm, h= 5.00 mm</u>
ZoomScan	<u>5x5x7,dx=8mm dy=8mm dz=5mm</u>
Phantom	<u>Left head</u>
Device Position	<u>Cheek</u>
Band	<u>Band2_WCDMA1900</u>
Channels	<u>Middle</u>
Signal	<u>WCDMA (Crest factor: 1.0)</u>
ConvF	<u>2.05</u>

B. SAR Measurement Results

Frequency (MHz)	1880.000000
Relative permittivity (real part)	40.000000
Relative permittivity (imaginary part)	13.408000
Conductivity (S/m)	1.400391
Variation (%)	-0.830000

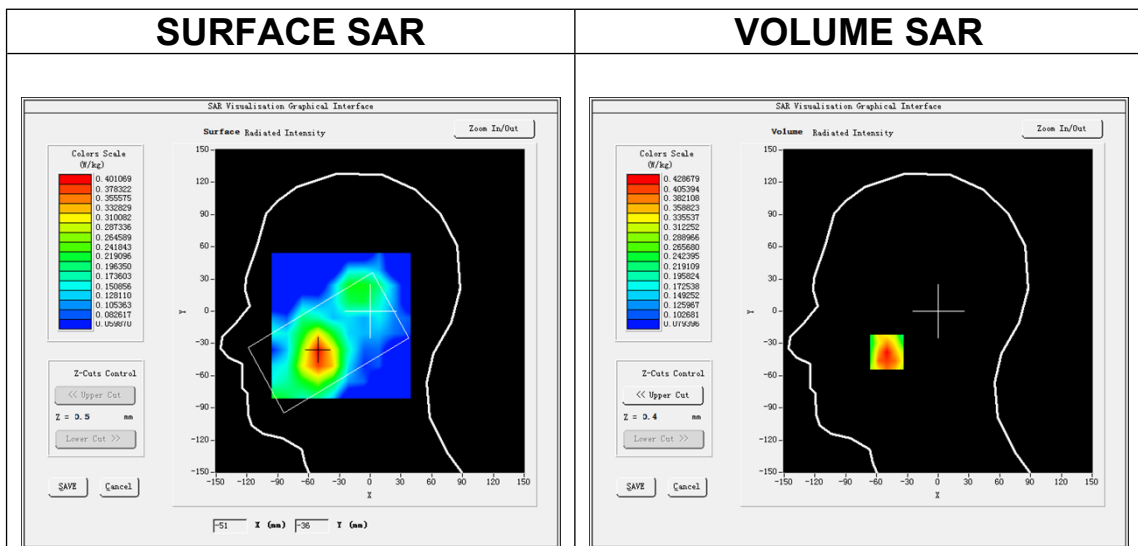

Maximum location: X=-50.00, Y=-38.00
SAR Peak: 0.58 W/kg

SAR 10g (W/Kg)	0.317932
SAR 1g (W/Kg)	0.424885

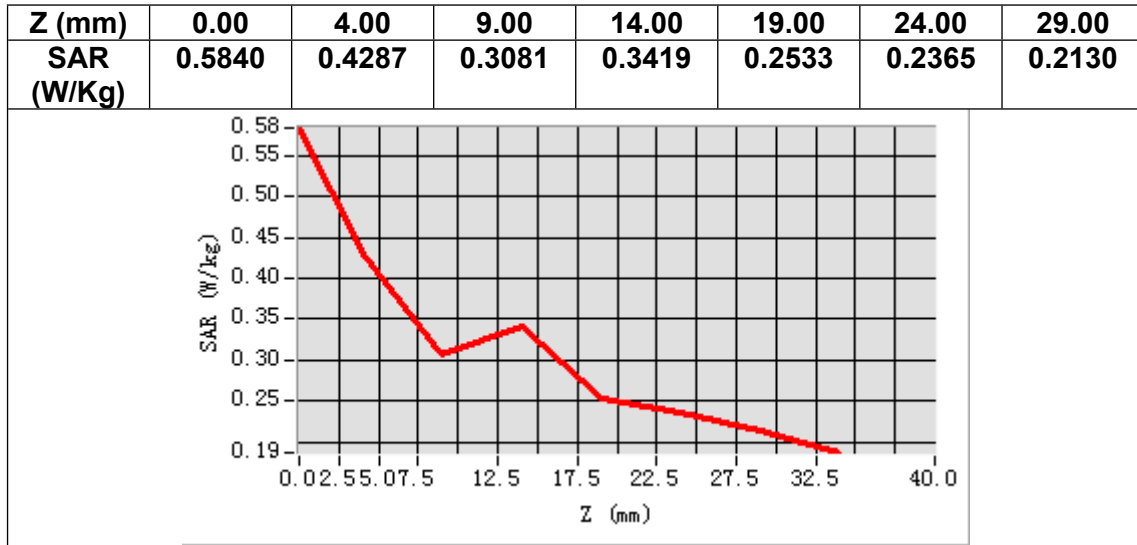

MEASUREMENT 6

Date of measurement: 29/4/2025

A. Experimental conditions.

Area Scan	<u>dx=15mm dy=15mm, h= 5.00 mm</u>
ZoomScan	<u>5x5x7, dx=8mm dy=8mm dz=5mm</u>
Phantom	<u>Validation plane</u>
Device Position	<u>Body</u>
Band	<u>Band2 WCDMA1900</u>
Channels	<u>Middle</u>
Signal	<u>WCDMA (Crest factor: 1.0)</u>
ConvF	<u>2.05</u>

B. SAR Measurement Results

Frequency (MHz)	1880.000000
Relative permittivity (real part)	40.000000
Relative permittivity (imaginary part)	13.408000
Conductivity (S/m)	1.400391
Variation (%)	2.190000

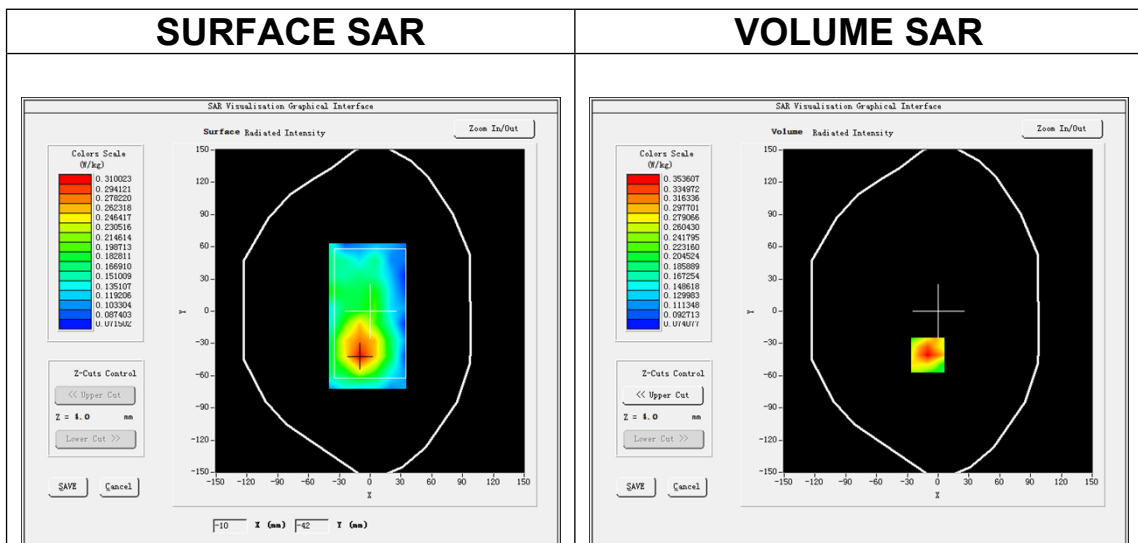

Maximum location: X=-10.00, Y=-41.00
SAR Peak: 0.47 W/kg

SAR 10g (W/Kg)	0.242331
SAR 1g (W/Kg)	0.327741

