

Shenzhen Saiwei Communication Technology Co., Ltd

Antenna test report

Customer Jiawei

Project name: A519(C39-V1.3)

Reporting time: 20240718

Catalogue

- △ Introduction to project debugging
- △ Report version feed
- △ Test environment
- △ Main antenna matching circuit
- △ Main antenna dark room data
- △ Additional instructions

Introduction to project debugging

Type	Smart phone						
Plate type	Motherboard						
Antenna Overview	Main antenna	Frequency band		Premature line status	Yao line form	Design area	Matching changes
		2G		FPC	PIFA		
		3G					
	4G						
	Other antennas	BT	2.4G		PIFA		
		433	433M				
		Episodes				PIFA	
Prototype status			Environmental treatment				

Report version feed

Edition	Date	Overview of meat
V1	20240702	Test data

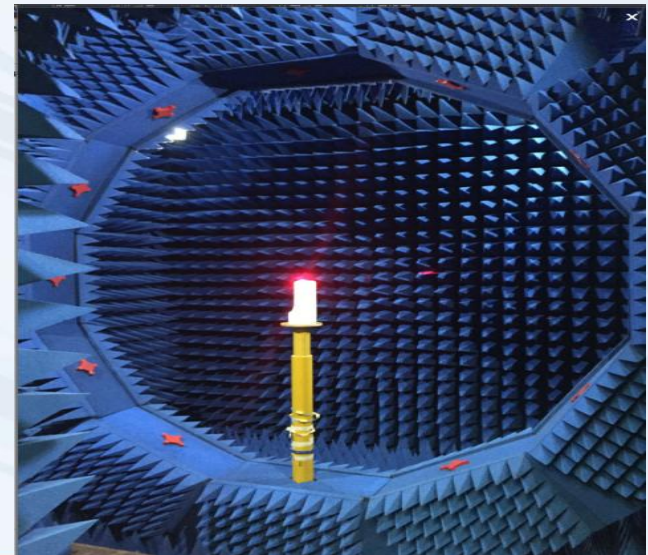
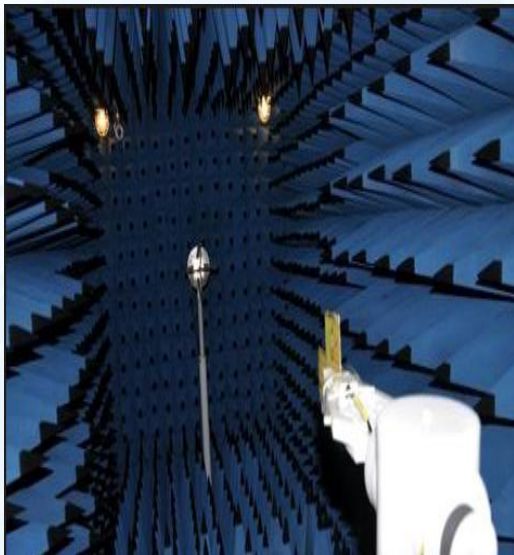

BT-Gain

Frequency ID	1	2	3	4	5	6
Frequency (MHz)	2400	2420	2440	2460	2480	2500
gain (dBm)	1.35	1.34	1.42	1.58	1.30	1.32
Efficiency (%)	53.4%	54.9%	55.7%	55.2%	54.9%	53.6%

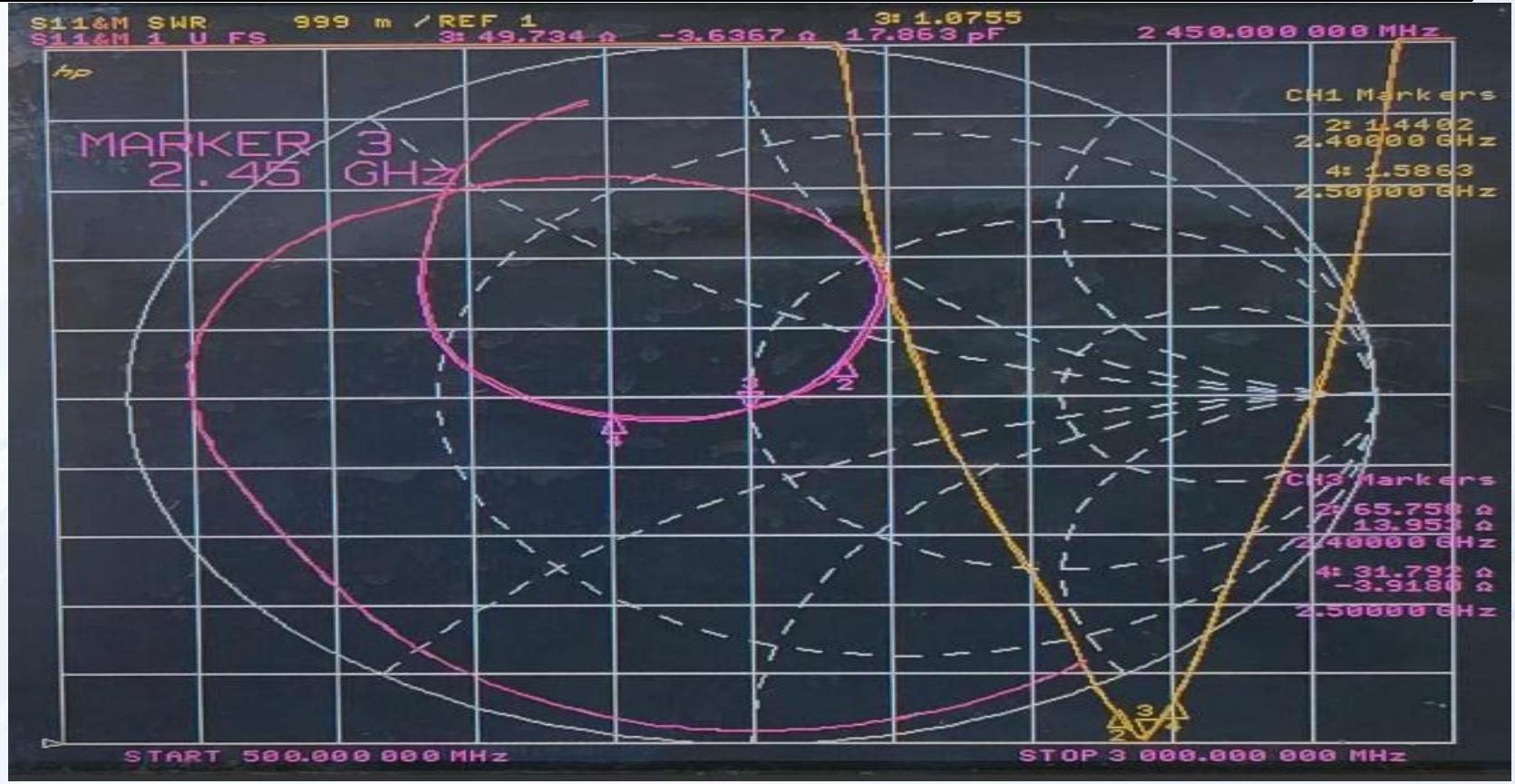

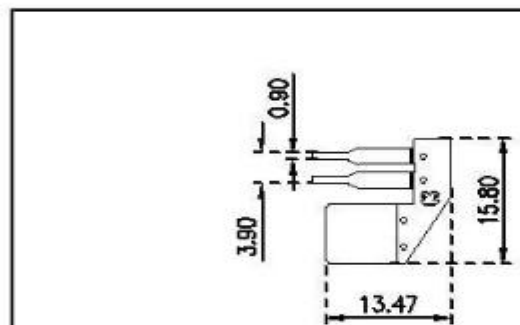
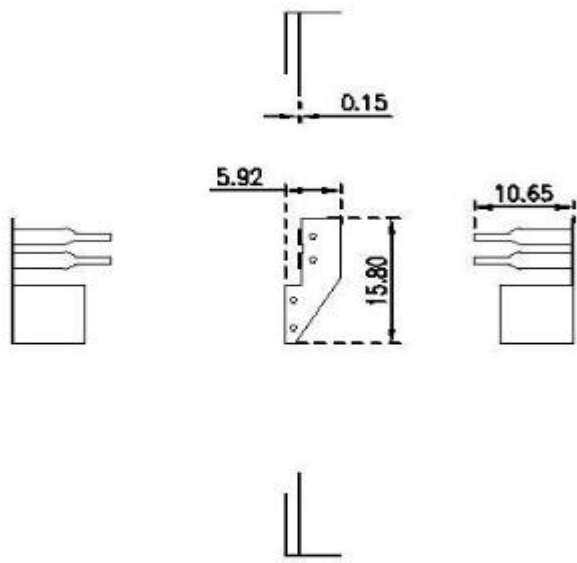

展开图档

注:

1. 打★号为严格控制尺寸 (必须等级A)
打*号为重要尺寸 (制作模具要控制, 模具验收必须等级B), 其它尺寸为设计参考尺寸等级C;
2. 不可有变形、翘起、毛刺、油污、刮伤等缺陷;
3. 材质用SUS 304 3/4H T=0.15;
4. 未标注尺寸按CAD电子图档1:1量取;
5. 未标注公差按CAD电子图档公差表执行;
6. 插脚孔位置公差为 ± 0.05 并实配;
7. 弹片表面印字, 具体内容见图, 要求字体清晰可见。

深圳市赛维通讯科技有限公司

第三角法		机种	CS	日期	2024-07-18	绘图	审核	系列	1 of 1	
0~10	±0.10	品名	BT天线	结构	设计	审核	核准			
10~20	±0.12	料号	VTL120-CS-BT-DK							
20~40	±0.15	材质	0.15mm 洋白铜							
40~	±0.20	表面处理								
请勿实测图纸 位置		表面处理		射制	单位	mm	比例	1:1	版本	REV:C

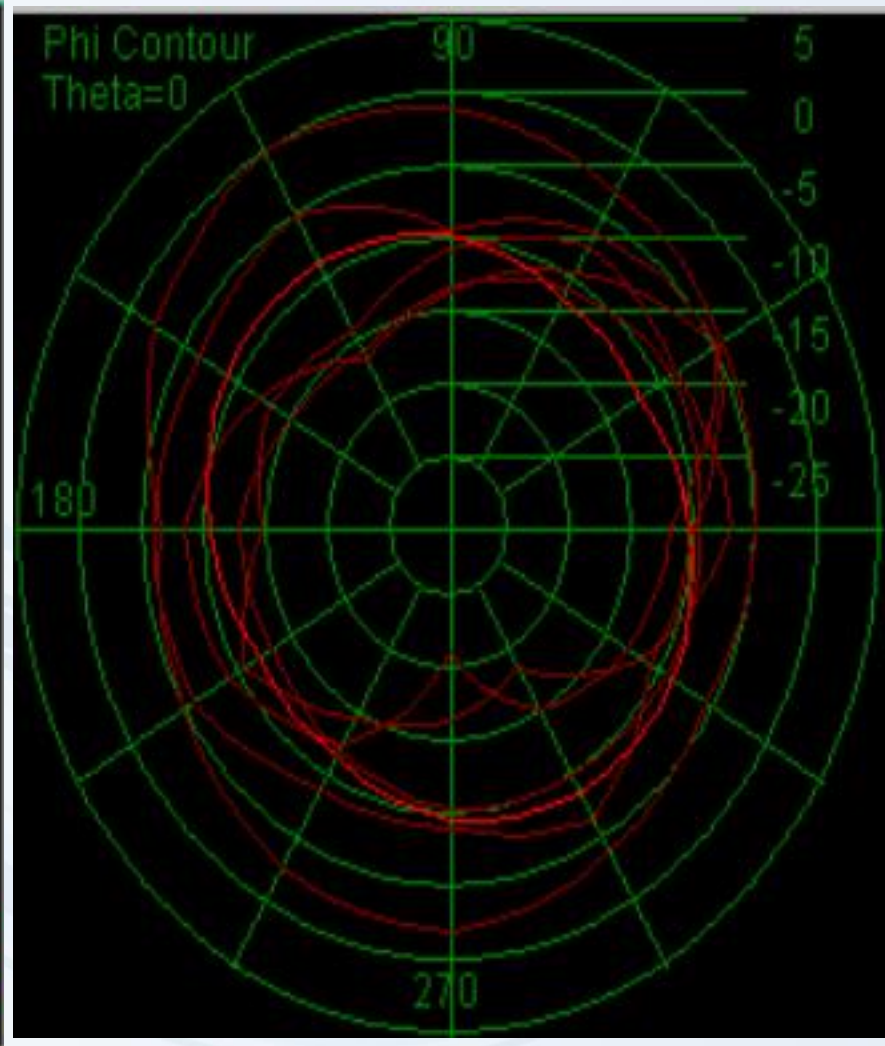
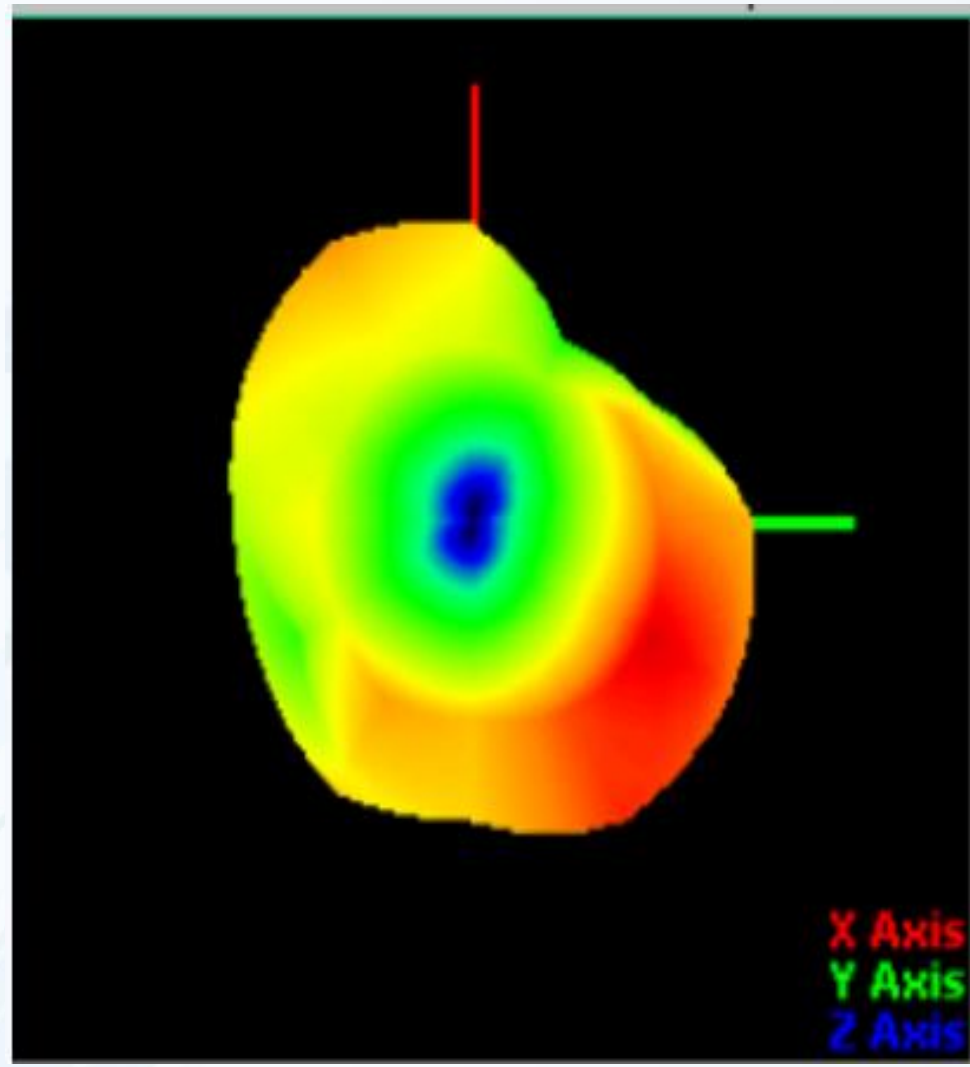

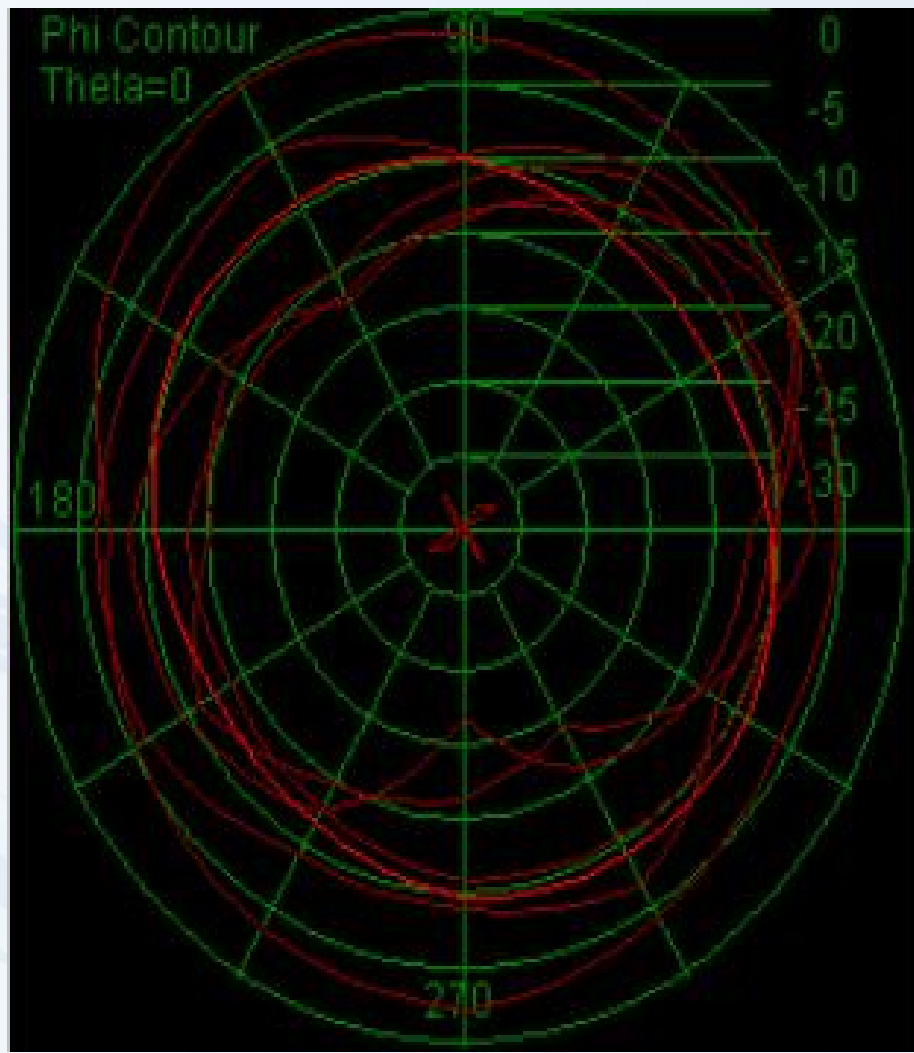
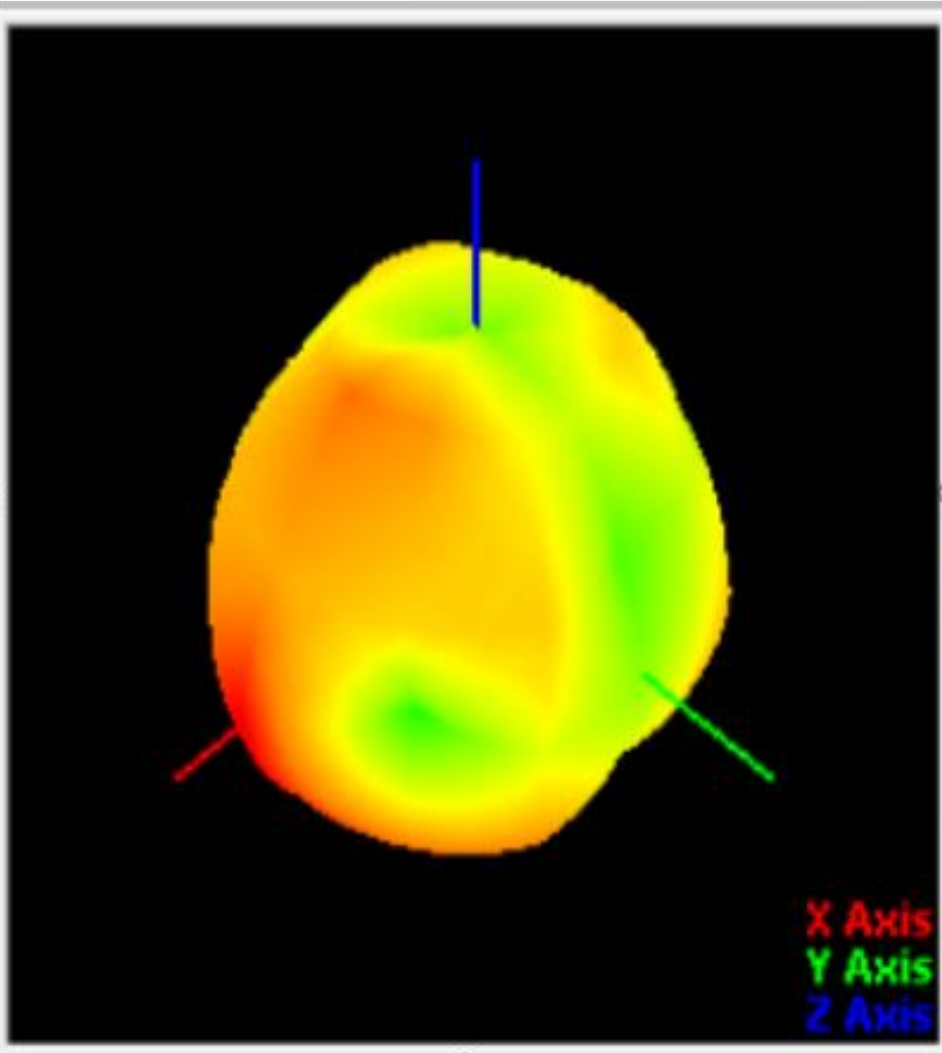

Frequency ID	1	2	3	4	5	6	7	8	9	10
Frequency (MHz)	410	415	420	425	430	435	440	445	450	455
gain (dBi)	-5.1	-4.85	-4.61	-4.59	-4.41	-4.35	-4.51	-4.71	-4.92	-5.22
Efficiency (%)	31.4%	32.9%	33.7%	35.2%	36.9%	36.6%	35.8%	34.5%	32.6%	30.4%

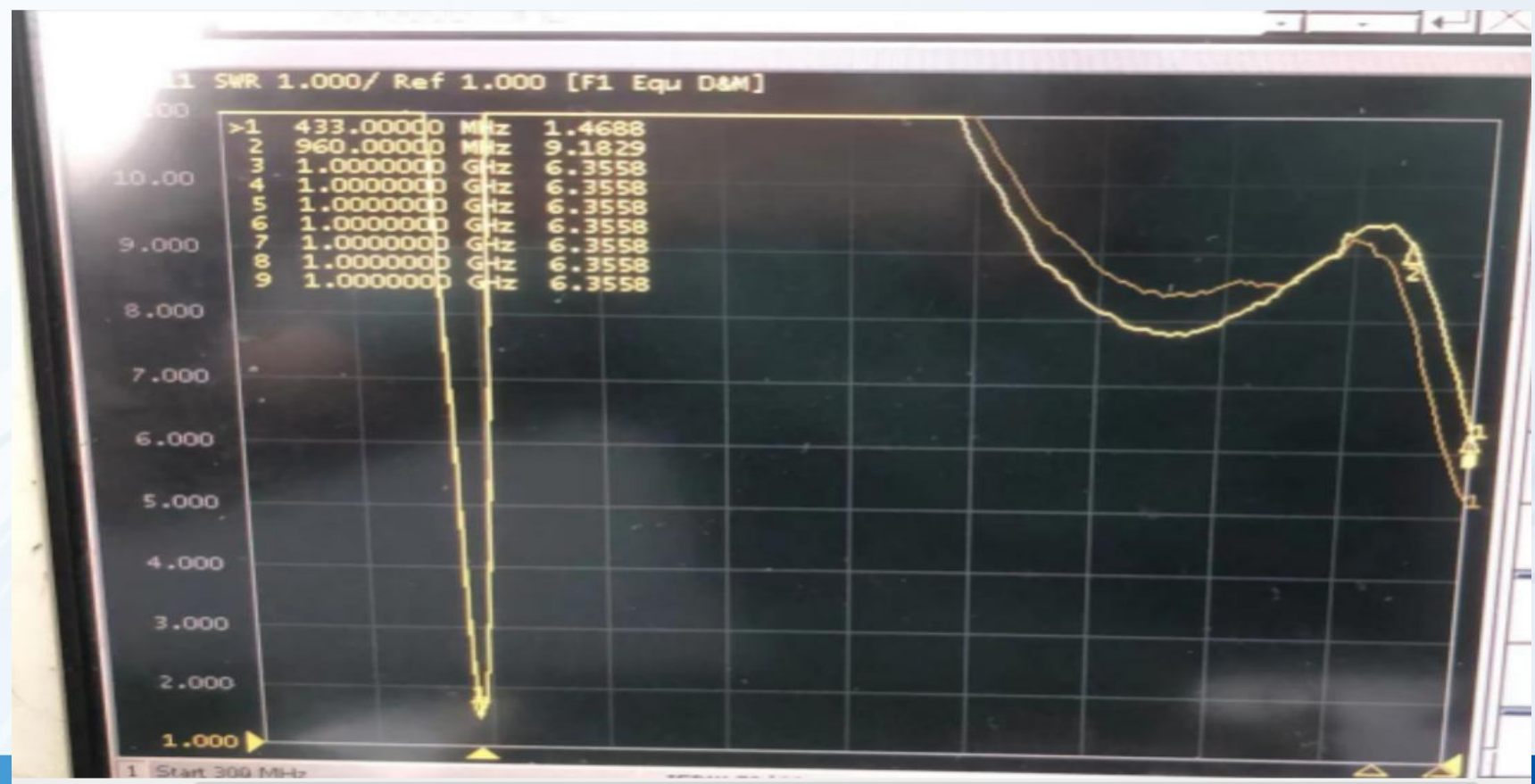

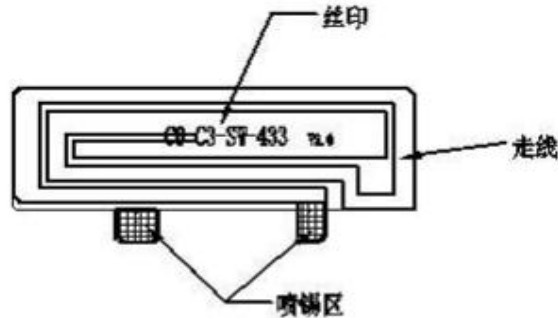

正面

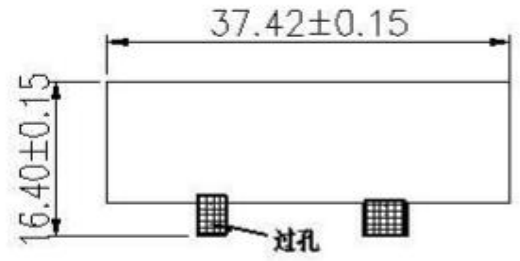

背面

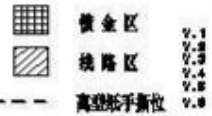

- 注
- 1、材料单面板 厚度0.5mm 绿色油墨
 - 2、金手指表面镀锡,不可有氧化现象。
 - 3、走线及孔精度公差范围:±0.05mm,外形尺寸公差控制在0.1mm以内;
 - 4、打*号为严格控制尺寸,标有*为重点尺寸,未标注尺寸按GB电子图档1:1量取;
 - 5、表面印字,具体内容及位置见图;

深圳市赛维通讯科技有限公司

第三角法		乳剂	CS	日期	2024-7-15	绘图		页码	1 of 1
0~10	±0.10	◎ 0.02	品名	433天线	结构	审核	批准		
10~20	±0.12	⊙ 0.03	料号	VTL120-C3-PCB					
20~40	±0.15	⊥ 0.03	材质	PCB					
40~	±0.20	∠ 0.02	表面处理		丝印				
请询实物图	位置	外观处理			单位	mm	比例	1:1	影本 BY:A

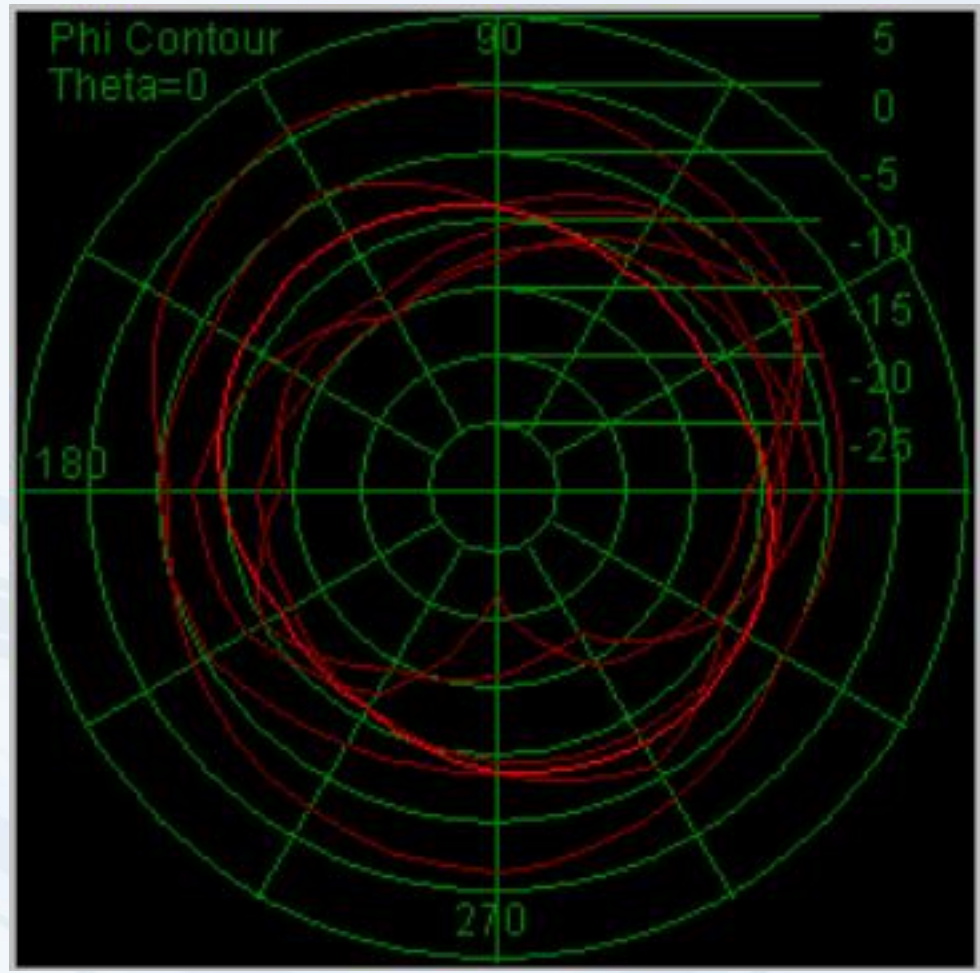
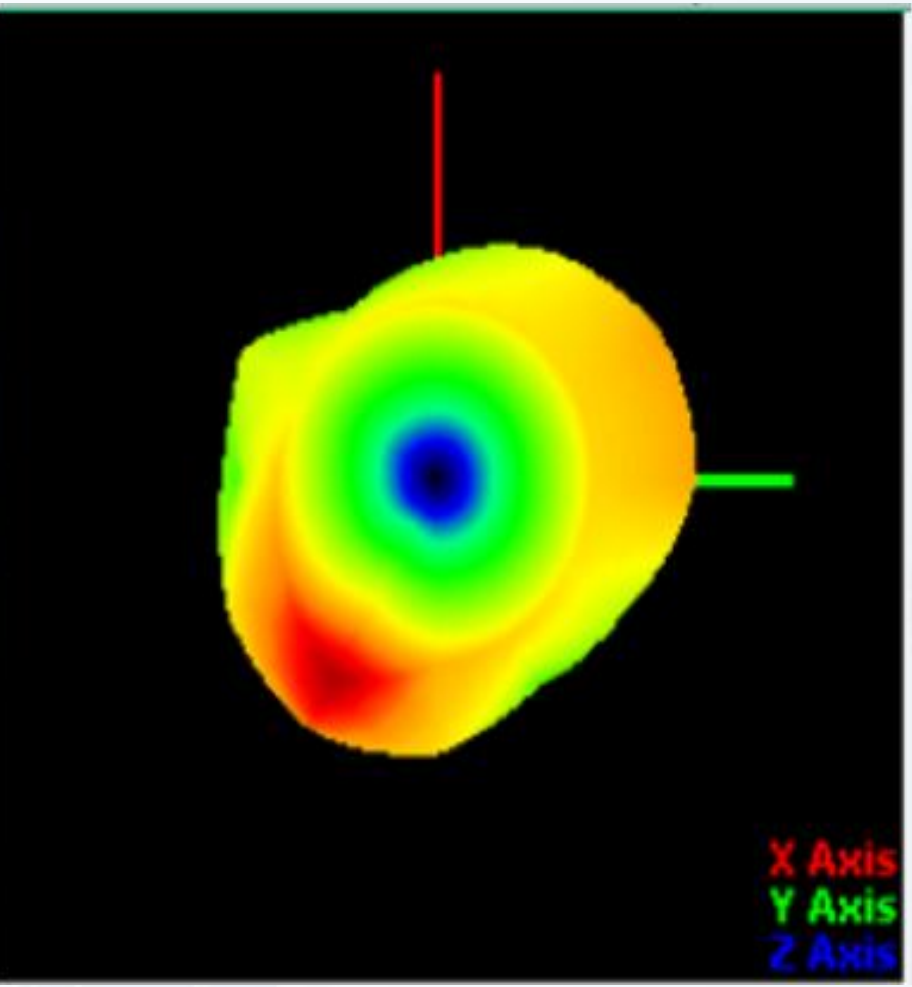

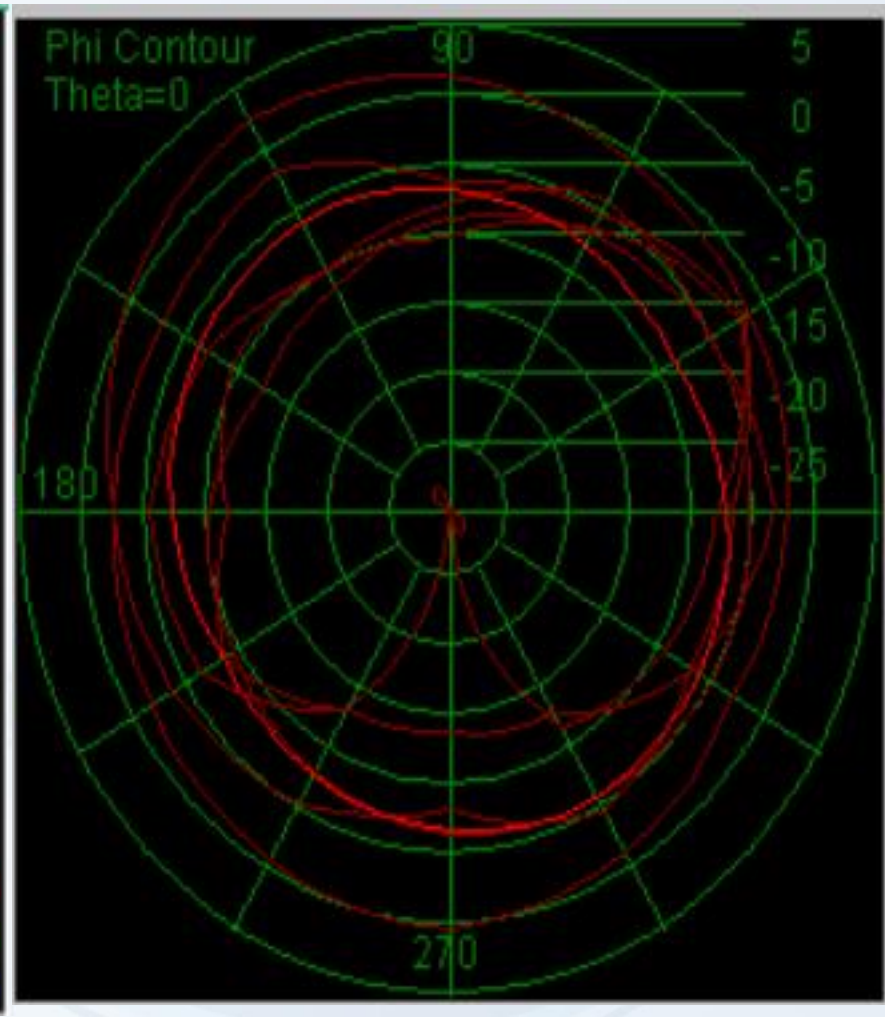
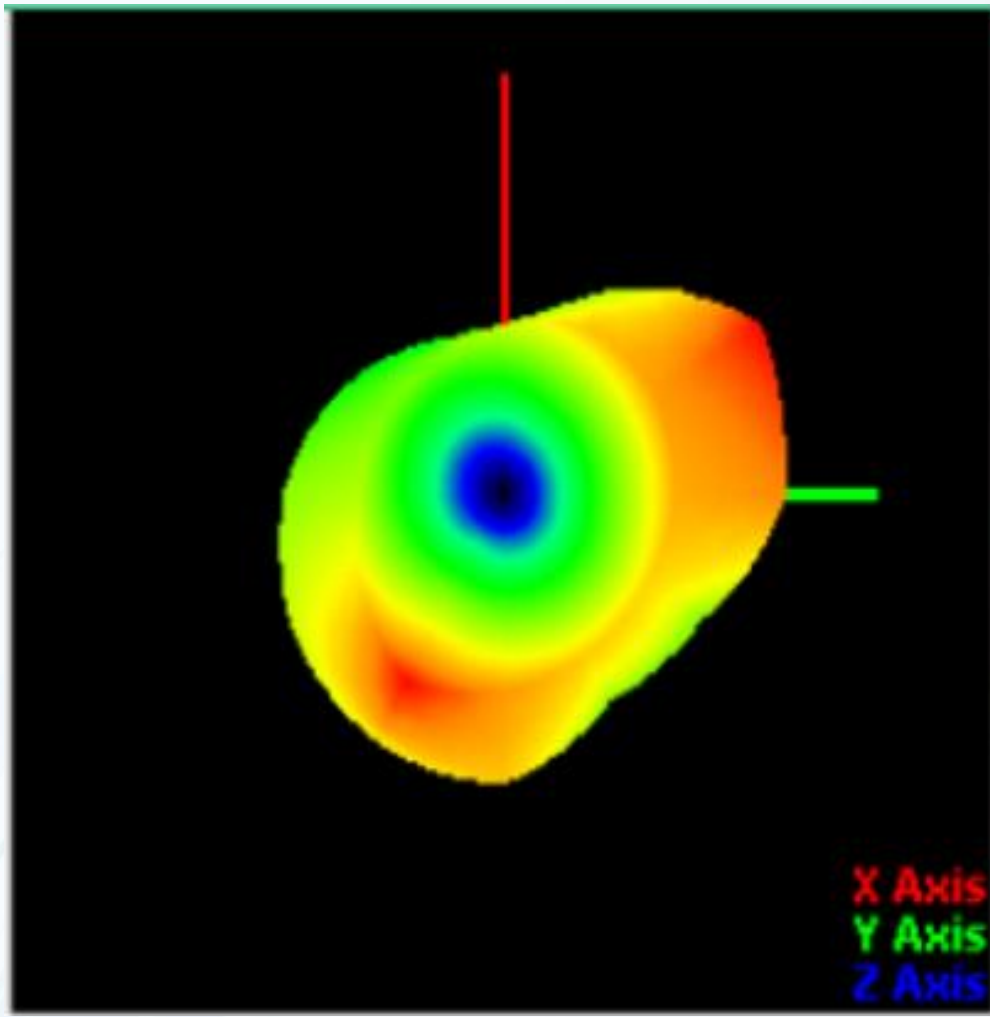

THANKS!

