



No.:
FCCSZ2024-0058-RF4

TEST REPORT

FCC ID : 2AYHY-GS601

NAME OF SAMPLE : Vape Detector

APPLICANT : Xiamen Milesight IoT Co., Ltd.

CLASSIFICATION OF TEST : N/A

CVC Testing Technology (Shenzhen) Co., Ltd.



Applicant		Name: Xiamen Milesight IoT Co., Ltd. Address: Building C09, Software Park Phase III, Xiamen 361024, Fujian, China	
Manufacturer		Name: Xiamen Milesight IoT Co., Ltd. Address: Building C09, Software Park Phase III, Xiamen 361024, Fujian, China	
Equipment Under Test		Name: Vape Detector Model/Type: GS601-915M Additional Model/Type: See Section 2.2 Brand: Milesight Serial No.: N/A Sample No.: 3-1	
Date of Receipt.	2024-08-06	Date of Testing	2024-08-06 ~ 2024-10-18
Test Specification		Test Result	
FCC Part 15, Subpart C, Section 15.225		PASS	
Evaluation of Test Result	The equipment under test was found to comply with the requirements of the standards applied. Seal of CVC Issue Date: 2024-10-18		
Compiled by: Zhu Yulin Name Signature	Reviewed by: Mo Xianbiao Name Signature	Approved by: Dong Sanbi Name Signature	
Other Aspects: NONE.			
Abbreviations: OK, Pass= passed Fail = failed N/A= not applicable EUT= equipment, sample(s) under tested			

This test report relates only to the EUT, and shall not be reproduced except in full, without written approval of CVC.



TABLE OF CONTENTS

RELEASE CONTROL RECORD	4
1 SUMMARY OF TEST RESULTS	5
1.1 LIST OF TEST AND MEASUREMENT INSTRUMENTS	6
1.2 MEASUREMENT UNCERTAINTY	7
1.3 TEST LOCATION	7
2 GENERAL INFORMATION	8
2.1 GENERAL PRODUCT INFORMATION	8
2.2 ADDITIONAL MODEL/TYPE	8
2.3 DESCRIPTION OF ACCESSORIES	9
2.4 OTHER INFORMATION	9
2.5 TEST MODE APPLICABILITY AND TESTED CHANNEL DETAIL	9
2.6 GENERAL DESCRIPTION OF APPLIED STANDARDS	12
2.7 DESCRIPTION OF SUPPORT UNITS	12
3 TEST TYPES AND RESULTS	13
3.1 CONDUCTED EMISSION MEASUREMENT	13
3.2 RADIATED EMISSIONS MEASUREMENT	16
3.3 FREQUENCY TOLERANCE	26
3.4 20dB BANDWIDTH	28
4 PHOTOGRAPHS OF TEST SETUP	30
5 PHOTOGRAPHS OF THE EUT	31



RELEASE CONTROL RECORD

ISSUE NO.	REASON FOR CHANGE	DATE ISSUED
FCCSZ2024-0058-RF4	Original release	2024-10-18



1 SUMMARY OF TEST RESULTS

The EUT has been tested according to the following specifications:

APPLIED STANDARD: FCC Part 15, Subpart C Section 15.225			
FCC STANDARD SECTION	TEST TYPE AND LIMIT	RESULT	REMARK
15.207	AC Power Line Conducted Emission	PASS	Meet the requirement of limit.
15.225 (a)&(b)&(c) 15.205	The field strength of Fundamental Emission	PASS	Meet the requirement of limit.
15.225 (d) 15.209	Radiated Emissions	PASS	Meet the requirement of limit.
15.225 (e)	Frequency tolerance	PASS	Meet the requirement of limit.
15.215 (c)	20dB Bandwidth	PASS	Meet the requirement of limit.
15.203	Antenna Requirement	PASS	No antenna connector is used.



1.1 LIST OF TEST AND MEASUREMENT INSTRUMENTS

Equipment	Manufacturer	Model No.	Serial Number	Cal. interval	Cal. Due
Antenna Port Conducted Test					
Signal&Spectrum Analyzer	Rohde&Schwarz	FSV 30	104408	1 year	2025/4/28
#3Shielding room	MORI	443	N/A	3 year	2026/5/16
Wideband radio communication tester	Rohde&Schwarz	CMW 500	168778	1 year	2025/5/24
Analog signal Generator (100kHz ~ 40GHz)	Rohde&Schwarz	SMB 100A	181934	1 year	2025/4/27
Vector signal Generator (9kHz ~ 6GHz)	Rohde&Schwarz	SGT 100A	111724	1 year	2025/4/27
RF control unit(BT/WiFi)	Tonscend	JS0806-2-8CH	20E8060261	1 year	2025/4/28
Temperature and humidity meter	/	C193561457	C193561457	1 year	2025/4/27
Conducted emission Test					
EMI Test Receiver limiter (10 dB)	Rohde&Schwarz	ESR3	102693	1 year	2025/5/24
Voltage probe	Rohde&Schwarz	ESH3-Z2	102824	1 year	2025/5/15
Current probe	Rohde&Schwarz	CVP9222C	28	1 year	2025/4/27
ISN network	Rohde&Schwarz	EZ-17	101442	1 year	2025/4/28
ISN network	Rohde&Schwarz	ENV 81	100401	1 year	2025/4/28
ISN network	Rohde&Schwarz	ENV 81 Cat6	101896	1 year	2025/4/28
#1Shielding room	MORI	854	N/A	3 year	2026/5/16
LISN	SCHWARZBECK	NSLK 8129	5021	1 year	2025/4/27
Temperature and humidity meter	/	C193561430	C193561430	1 year	2025/4/27
Radiation Spurious Test - 3M Chamber #2					
Signal&Spectrum Analyzer	Rohde&Schwarz	FSV 40	101898	1 year	2025/4/28
EMI Test Receiver	Rohde&Schwarz	ESR3	102693	1 year	2025/4/28
Antenna(30MHz~1001MHz)	SCHWARZBECK	VULB 9168	1133	1 year	2025/2/20
Horn antenna(1GHz-18GHz)	ETS	3117	227611	1 year	2025/2/4
Horn antenna(18GHz-40GHz)	QMS	QMS-00880	22051	1 year	2025/3/24
3m anechoic chamber	MORI	966	CS0300011	3 year	2026/5/18
Filter group(RSE-BT/WiFi)	Rohde&Schwarz	WiFi /BT Variant 1	100820	1 year	2025/4/28
Filter group(RSE-Cellular)	Rohde&Schwarz	Cellular Variant 1	100768	1 year	2025/4/28
Preamplifier(10kHz-1GHz)	Rohde&Schwarz	SCU-01F	100299	1 year	2025/4/28
Preamplifier(1GHz-18GHz)	Rohde&Schwarz	SCU-18F	100799	1 year	2025/4/28
Preamplifier(1GHz-18GHz)	Rohde&Schwarz	SCU-18F	100801	1 year	2025/4/28
Preamplifier(18GHz-40GHz)	Rohde&Schwarz	SCU-40A	101209	1 year	2025/4/28
Temperature and humidity meter	/	C193561517	C193561517	1 year	2025/4/27
Radiation Spurious Test - 3M Chamber #1					
EMI Test Receiver	Rohde&Schwarz	ESR 26	101718	1 year	2025/5/24
Antenna(30MHz~1000MHz)	SCHWARZBECK	VULB 9168	01132	1 year	2025/5/27
Horn antenna(1GHz-18GHz)	ETS	3117	227634	1 year	2025/3/25
Horn antenna(18GHz-40GHz)	SCHWARZBECK	BBHA 9170	01003	1 year	2025/3/25
3m anechoic chamber	MORI	966	CS0200019	3 year	2026/5/18
LISN (single-phase)	Rohde&Schwarz	ESH3-Z6	102152/102156	1 year	2025/4/27
Preamplifier(10kHz-1GHz)	Rohde&Schwarz	SCU-01F	100298	1 year	2025/4/28
Attenuator	/	SJ-5dB	607684	1 year	2025/2/4
#1 control room	MORI	433	CS0300028	3 year	2026/5/17
Temperature and humidity meter	UNI-T	A10T	C193561473	1 year	2025/4/27



1.2 MEASUREMENT UNCERTAINTY

Where relevant, the following measurement uncertainty levels have been estimated for tests performed on the EUT as specified in CISPR 16-4-2:

No.	Item	Measurement Uncertainty
1	Occupied Channel Bandwidth	±1.86 %
2	RF output power, conducted	±0.9 dB
3	Power Spectral Density, conducted	±0.8 dB
4	Conducted emission test	+/-2.7 dB
5	Radiated emission 9kHz-30MHz	+/-5.6 dB
	Radiated emission 30MHz-1GHz	+/-4.6 dB
	Radiated emission 1GHz-18GHz	+/-4.4 dB
	Radiated emission 18GHz-40GHz	+/-5.1 dB
6	Temperature	±0.73 °C
7	Humidity	±3.90 %
8	Supply voltages	±0.37 %
9	Time	±0.27 %

Remark: 95% Confidence Levels, k=2.

1.3 TEST LOCATION

The tests and measurements refer to this report were performed by EMC testing Lab of CVC Testing Technology (Shenzhen) Co., Ltd.

Address: No. 1301-14&16, Guangguang Road, Xinlan Community, Guanlan Subdistrict, Longhua District, Shenzhen, Guangdong, China

Post Code: 518110 Tel: 0755-23763060-8805
Fax: 0755-23763060 E-mail: sz-kf@cvc.org.cn
FCC(Test firm designation number: CN1363)
IC(Test firm CAB identifier number: CN0137)
CNAS(Test firm designation number: L16091)



2 GENERAL INFORMATION

2.1 GENERAL PRODUCT INFORMATION

PRODUCT	Vape Detector
BRAND	Milesight
MODEL	GS601-915M
ADDITIONAL MODEL	See Section 2.2
POWER SUPPLY (Remark 6)	1. DC 5V From USB 2. DC 48V From POE 3. DC 5V From PoE Splitter
MODULATION TYPE	ASK
OPERATING FREQUENCY	13.56MHz
NUMBER OF CHANNEL	1
ANTENNA TYPE (Remark 4/5)	Loop antenna
HARDWARE VERSION 1	GS06-00-V1.1(POE)
HARDWARE VERSION 2	GS06-00-V1.1
SOFTWARE VERSION	GS601.0000.0100.0101
I/O PORTS	Refer to user's manual
CABLE SUPPLIED	USB Cable, unshielded, 1.2m
<p>Remark:</p> <ol style="list-style-type: none"> For more detailed features description, please refer to the manufacturer's specifications or the User's Manual. For the test results, the EUT had been tested with all conditions. But only the worst case was shown in test report. EUT photo refer to the report (Report NO.: FCCSZ2024-0058-EUT). Please refer to the antenna report. Since the above data and/or information is provided by the client relevant results or conclusions of this report are only made for these data and/or information, CVC is not responsible for the authenticity, integrity and results of the data and information and/or the validity of the conclusion. EUT is divided into two versions with POE power supply and without POE power supply. Hardware version 1 is divided into POE power supply version, and hardware version 2 is divided into non-POE power supply version. 	

2.2 ADDITIONAL MODEL/TYPE

Main Model	Serial Model	Difference
GS601-915M	GS601-868M/915M, NI601-868M/915M, NI601-915M, GS601, NI601	The only differences are the label and model.



2.3 DESCRIPTION OF ACCESSORIES

DC Adapter	
Brand	N/A
Model No.:	FJ-SW2050501000U
Input:	100-240V ~ 50/60Hz 0.25A max
Output:	5V \equiv 1A
SN	N/A
DC Cable:	N/A

PoE Splitter (Optional)	
Brand	N/A
Model No.:	TYPEC0502
Input:	DC37-57V
Output:	5V/2.4A
SN	062405033569

2.4 OTHER INFORMATION

The EUT only have one channel.

CHANNEL	FREQUENCY (MHz)
1	13.56

2.5 TEST MODE APPLICABILITY AND TESTED CHANNEL DETAIL

Pre-Scan has been conducted to determine the worst-case mode from all possible combinations between available modulations, data rates, XYZ axis and antenna ports

The worst case was found when positioned on X axis for radiated emission. Following channel(s) was (were) selected for the final test as listed below:

EUT CONFIGURE MODE	APPLICABLE TO				DESCRIPTION
	RE	FT	PLC	BW	
A	√	√	√	√	NFC Link

Where RE: Radiated Emission

FT: Frequency tolerance

PLC: Power Line Conducted Emission

BW: 20dB Bandwidth



RADIATED EMISSION TEST:

- Pre-Scan has been conducted to determine the worst-case mode from all possible combinations between available modulations, XYZ axis, antenna ports (if EUT with antenna diversity architecture) and packet type.
- Following channel(s) was (were) selected for the final test as listed below.

EUT CONFIGURE MODE	TESTED CHANNEL	TESTED FREQUENCY (MHZ)	MODULATION TYPE	AXIS
A	1	13.56	ASK	X
	1	13.56	ASK	Y
	1	13.56	ASK	Z

FREQUENCY TOLERANCE:

- This item includes all test value of each mode, but only includes spectrum plot of worst value of each mode.
- Pre-Scan has been conducted to determine the worst-case mode from all possible combinations between available modulations, antenna ports (if EUT with antenna diversity architecture), and packet types.
- Following channel(s) was (were) selected for the final test as listed below.

EUT CONFIGURE MODE	TESTED CHANNEL	TESTED FREQUENCY (MHZ)	MODULATION TYPE	AXIS
A	1	13.56	ASK	Y

POWER LINE CONDUCTED EMISSION TEST:

- This item includes all test value of each mode, but only includes spectrum plot of worst value of each mode.
- Pre-Scan has been conducted to determine the worst-case mode from all possible combinations between available modulations, antenna ports (if EUT with antenna diversity architecture), and packet types.
- Following channel(s) was (were) selected for the final test as listed below.

EUT CONFIGURE MODE	TESTED CONDITION
A	NFC Link



20dB BANDWIDTH:

- This item includes all test value of each mode, but only includes spectrum plot of worst value of each mode.
- Pre-Scan has been conducted to determine the worst-case mode from all possible combinations between available modulations, antenna ports (if EUT with antenna diversity architecture), and packet types.
- Following channel(s) was (were) selected for the final test as listed below.

EUT CONFIGURE MODE	TESTED CHANNEL	TESTED FREQUENCY (MHZ)	MODULATION TYPE	AXIS
A	1	13.56	ASK	Y

TEST CONDITION:

Both hardware versions have been tested and only the worst version of the data is represented in this report

APPLICABLE TO	ENVIRONMENTAL CONDITIONS	TEST VOLTAGE (SYSTEM)	TESTED BY
RE	26.1deg. C, 59%RH	DC 5V From USB	Liu Yuan
FT	26.1deg. C, 59%RH	DC 5V From USB	Zhu Yulin
PLC	26.1deg. C, 59%RH	DC 5V From USB	Wang Zhiming
BW	26.1deg. C, 59%RH	DC 5V From USB	Zhu Yulin



2.6 GENERAL DESCRIPTION OF APPLIED STANDARDS

The EUT is a RF product, according to the specifications of the manufacturers. It must comply with the requirements of the following standards:

FCC PART 15, Subpart C. Section 15.225

ANSI C63.10-2020

All test items have been performed and recorded as per the above standards

2.7 DESCRIPTION OF SUPPORT UNITS

The EUT has been tested as an independent unit together with other necessary accessories or support units. The following support units or accessories were used to form a representative test configuration during the tests.

Support Equipment							
NO	Description	Brand	Model No.	Serial Number	Supplied by		
1	DC adapter	N/A	FJ-SW2050501000U	N/A	Client		
2	POE adapter	N/A	N/A	N/A	Lab		
3	PoE Splitter	N/A	TYPEC0502	062405033569	Client		
Support Cable							
NO	Description	Quantity (Number)	Length (m)	Detachable (Yes/ No)	Shielded (Yes/ No)	Cores (Number)	Supplied by
1	Network cable	1	1.5	No	No	N/A	Lab

3 TEST TYPES AND RESULTS

3.1 CONDUCTED EMISSION MEASUREMENT

3.1.1 Limit

Frequency (MHz)	Conducted Limits(dBμV)	
	Quasi-peak	Average
0.15 - 0.5	66 to 56 *	56 to 46*
0.5 - 5	56	46
5 - 30	60	50

NOTE: 1. The lower limit shall apply at the transition frequencies.
NOTE: 2. The limit decreases in line with the logarithm of the frequency in the range of 0.15 to 0.50MHz.

3.1.2 Measurement procedure

- The EUT was placed on a platform of nominal size, 1 m by 1.5 m, raised 80 cm above the conducting ground plane. The vertical conducting plane was located 40 cm to the rear of the EUT. All other surfaces of EUT were at least 80 cm from any other grounded conducting surface. The EUT and simulators are connected to the main power through a line impedance stabilization network (LISN). The LISN provides a 50 ohm /50uH coupling impedance for the measuring equipment. The peripheral devices are also connected to the main power through a LISN. (Please refer to the Test photographs) Each current-carrying conductor of the EUT power cord, except the ground (safety) conductor, was individually connected through a LISN to the input power source. The equipment under test shall be placed on a support of non-metallic material, the height of which shall be 1.5m above the ground,
- The excess length of the power cord between the EUT and the LISN receptacle were folded back and forth at the center of the lead to form a bundle not exceeding 40 cm in length.
- Conducted emissions were investigated over the frequency range from 0.15MHz to 30MHz using a receiver bandwidth of 9 kHz.

3.1.3 Test setup

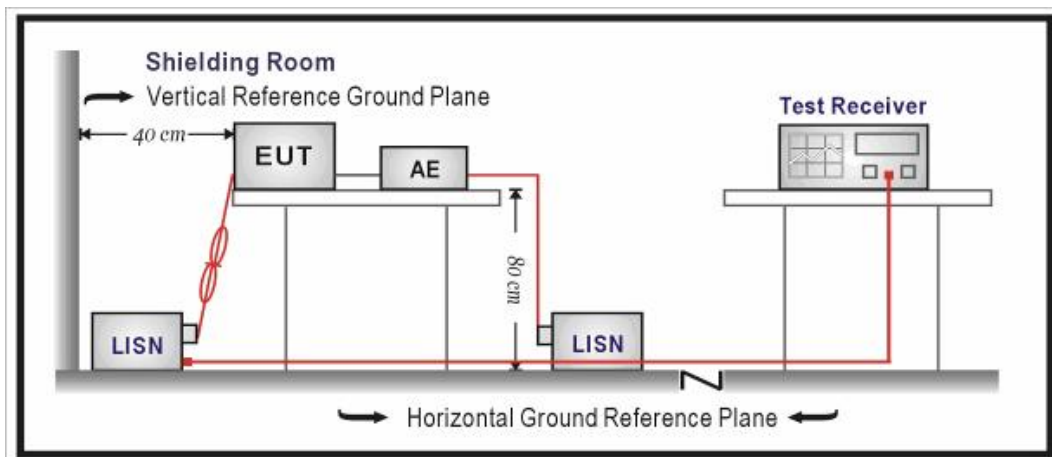



3.1.4 Test results

WORST-CASE DATA

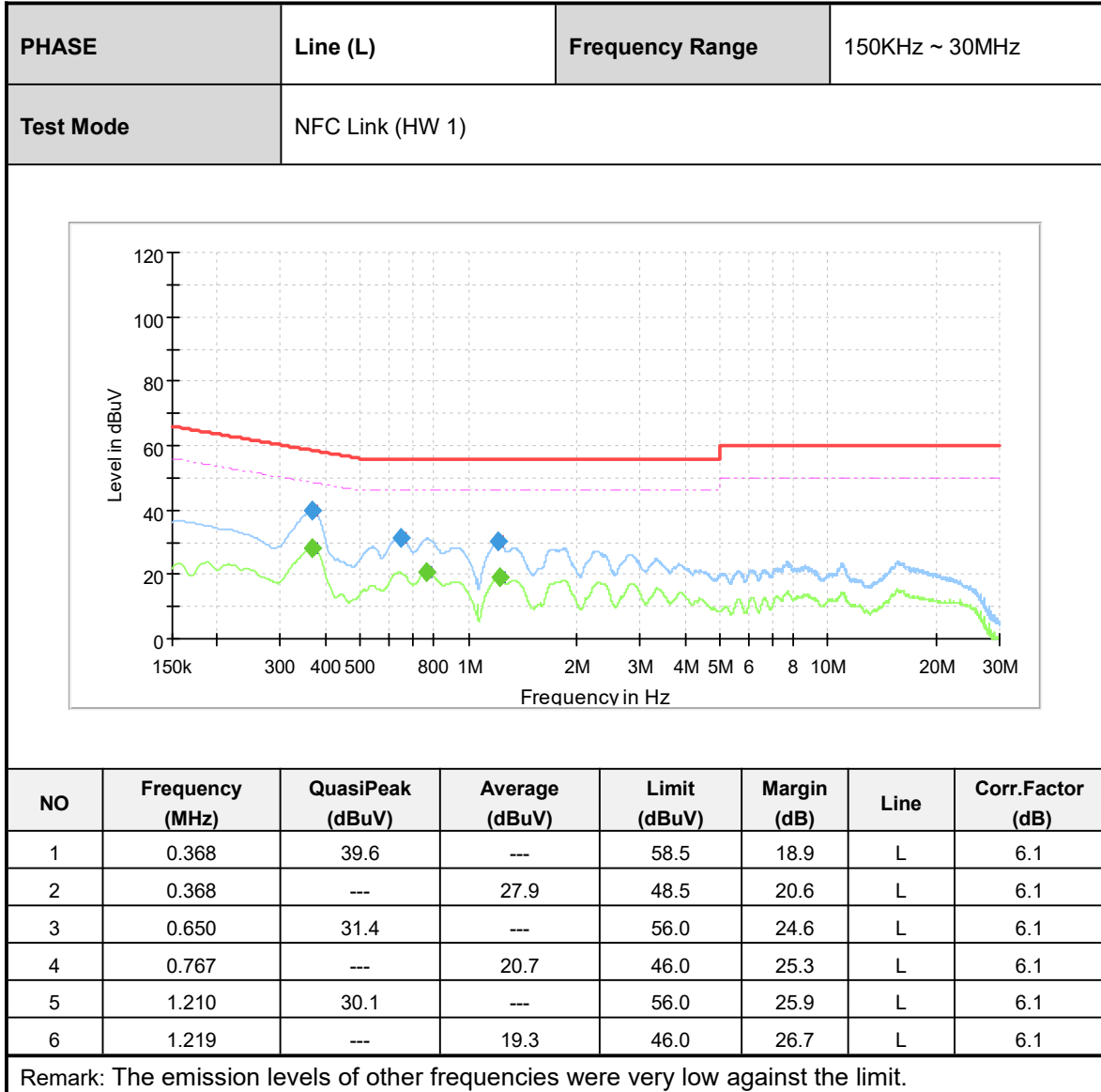



PHASE	Line (L)	Frequency Range	150KHz ~ 30MHz
Test Mode	NFC Link (HW 1)		

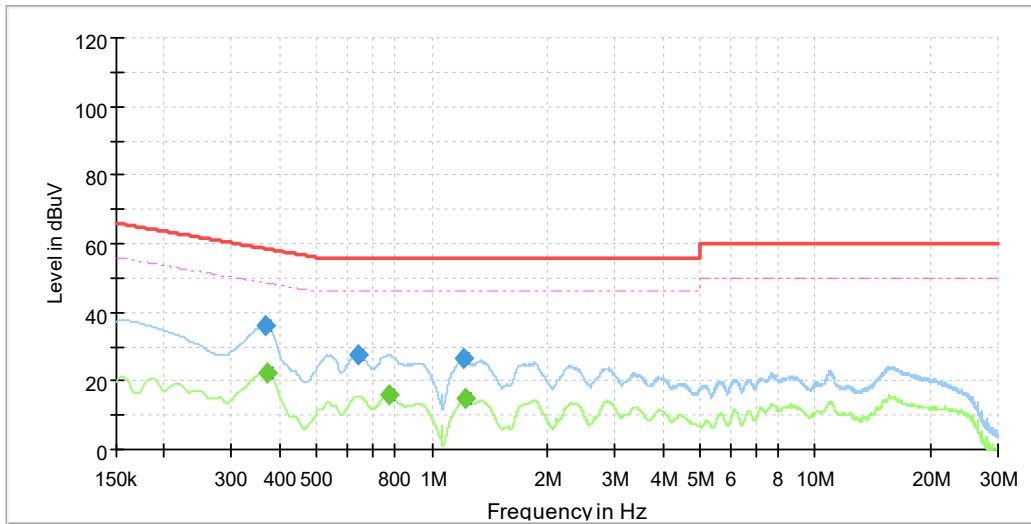

NO	Frequency (MHz)	QuasiPeak (dBuV)	Average (dBuV)	Limit (dBuV)	Margin (dB)	Line	Corr.Factor (dB)
1	0.366	36.1	---	58.6	22.5	N	6.1
2	0.371	---	22.5	48.5	26.0	N	6.1
3	0.643	27.7	---	56.0	28.3	N	6.1
4	0.769	---	15.7	46.0	30.3	N	6.1
5	1.203	26.7	---	56.0	29.3	N	6.1
6	1.217	---	14.7	46.0	31.3	N	6.1

Remark: The emission levels of other frequencies were very low against the limit.



3.2 RADIATED EMISSIONS MEASUREMENT

3.2.1 Limits

- (a) The field strength of any emissions within the band 13.553-13.567 MHz shall not exceed 15,848 microvolts/meter at 30 meters.
- (b) Within the bands 13.410-13.553 MHz and 13.567-13.710 MHz, the field strength of any emissions shall not exceed 334 microvolts/meter at 30 meters.
- (c) Within the bands 13.110-13.410 MHz and 13.710-14.010 MHz the field strength of any emissions shall not exceed 106 microvolts/meter at 30 meters.

FREQUENCIES (MHz)	FIELD STRENGTH (Microvolts/Meter)	MEASUREMENT DISTANCE (Meters)
0.009 ~ 0.490	2400/F(kHz)	300
0.490 ~ 1.705	24000/F(kHz)	30
1.705 ~ 30.0	30	30
30 ~ 88	100	3
88 ~ 216	150	3
216 ~ 960	200	3
Above 960	500	3

NOTE: 1. The lower limit shall apply at the transition frequencies.
NOTE: 2. Emission level (dBuV/m) = 20 log Emission level (uV/m).

3.2.2 Measurement procedure

- a. The EUT was placed on the top of a rotating table 1.5 meters(above 1GHz) and 0.8 meters(below 1GHz) above the ground at a 3 meters semi-anechoic chamber. The table was rotated 360 degrees to determine the position of the highest radiation.
- b. The EUT was set 3 meters away from the interference-receiving antenna, which was mounted on the top of a variable-height antenna tower.
- c. For below 1GHz was used bilog antenna, and above 1GHz was used horn antenna, and its height is varied from one meter to four meters above the ground to determine the maximum value of the field strength. Both horizontal and vertical polarizations of the antenna are set to make the measurement.
- d. For each suspected emission, the EUT was arranged to its worst case and then the antenna was tuned to heights from 1 meter to 4 meters and the rotatable table was turned from 0 degrees to 360 degrees to find the maximum reading.
- e. The test-receiver system was set to Peak Detect Function and Specified Bandwidth with Maximum Hold Mode.
- f. For below 30MHz, a loop antenna with its vertical plane is place 3m from the EUT and rotated about its vertical axis for maximum response at each azimuth about the EUT. And the centre of the loop shall be 1m above the ground.
- g. During the test, each emission was maximized by: having the EUT continuously working, investigated all operating modes, rotated about all 3 axis (X, Y & Z) and considered typical configuration to obtain worst position, manipulating interconnecting cables, For battery operated equipment, the equipment tests shall be perform using fresh batteries. The turntable was rotated to maximize the emission level.

NOTE:

1. The resolution bandwidth and video bandwidth of test receiver/spectrum analyzer is 120kHz for Quasi-peak detection at frequency below 1GHz.
2. The resolution bandwidth of test receiver/spectrum analyzer is 1 MHz and video bandwidth is 3MHz for Peak detection at frequency above 1GHz.
3. The resolution bandwidth of test receiver/spectrum analyzer is 1MHz and the video bandwidth is $\geq 1/T$ (Duty cycle < 98%) or 10Hz(Duty cycle > 98%) for Average detection (AV) at frequency above 1GHz.
4. All modes of operation were investigated and the worst-case emissions are reported.
5. The testing of the EUT was performed on all 3 orthogonal axes; the worst-case test configuration was reported on the file test setup photo.

3.2.3 Test setup

Below 30MHz Test Setup:

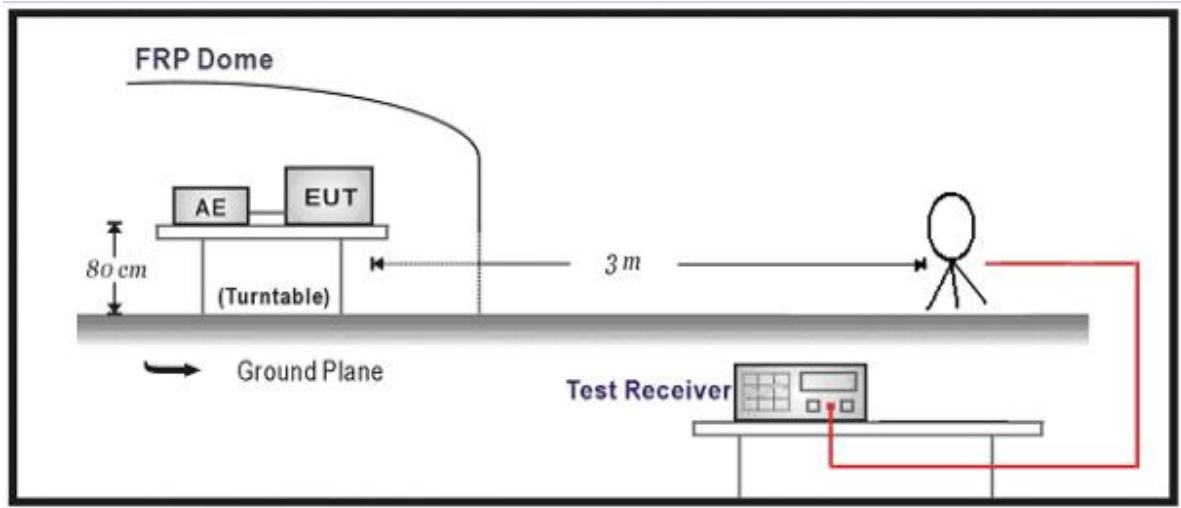

Below 1GHz Test Setup:

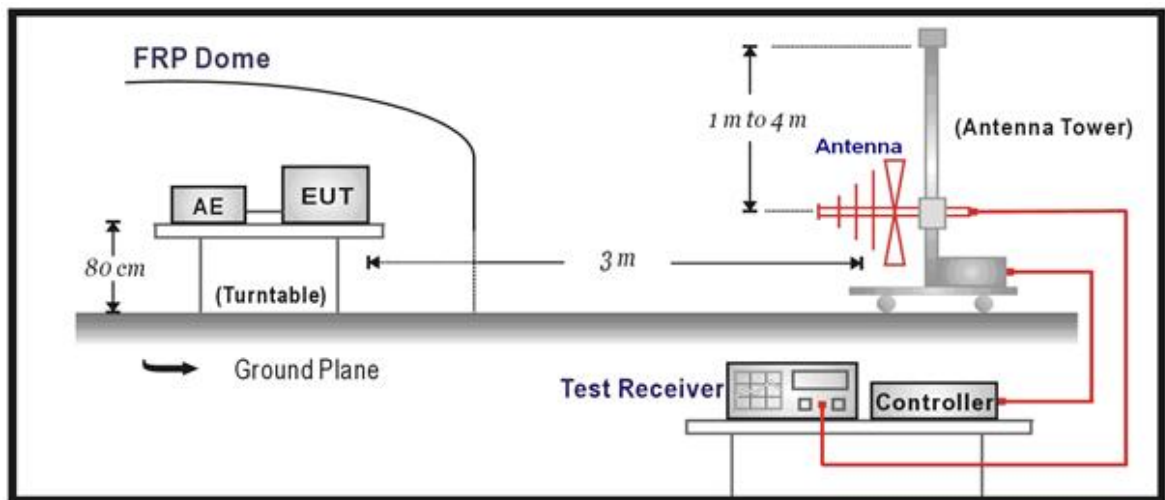



3.2.4 Test results

Result of The field strength of Fundamental Emission

Worst Test Mode	NFC (HW1)	Channel	13.56MHz
Frequency Range	13.11MHz ~ 14.01MHz	Detector Function	Quasi-Peak (QP)

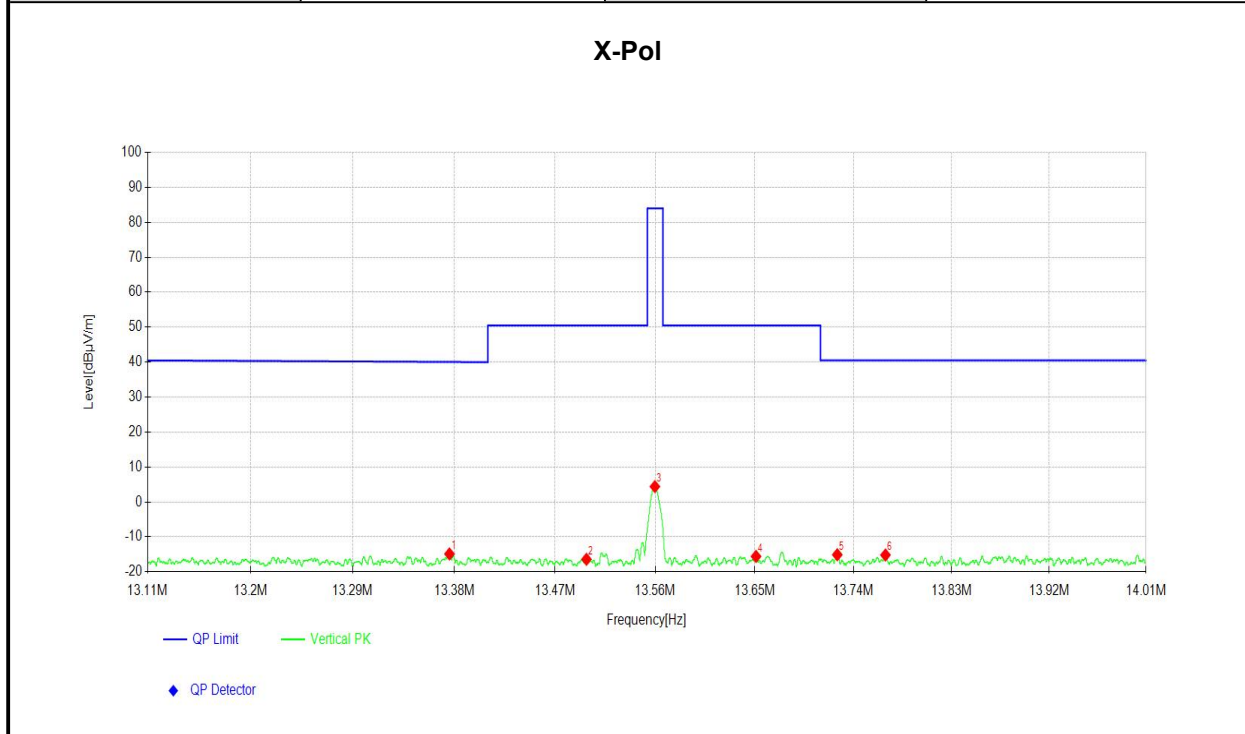

NO.	Freq. [MHz]	Reading [dBuV/m]	Factor [dB]	Level [dBuV/m]	Limit [dBuV/m]	Margin [dB]	Height [cm]	Angle [°]
1	13.376	5.04	-19.92	-14.88	40.06	54.94	100	3
2	13.498	3.51	-19.91	-16.40	50.50	66.90	100	56
3	13.560	24.30	-19.90	4.40	84.00	79.60	100	225
4	13.651	4.30	-19.88	-15.58	50.50	66.08	100	67
5	13.725	4.77	-19.87	-15.10	40.50	55.60	100	220
6	13.769	4.69	-19.86	-15.17	40.50	55.65	100	85

Remark: 1. Conversion factor to 30m has been added to the factor.
 2. Level (dBuV/m) = Reading (dBuV/m) + Factor (dB).
 3. Factor (dB/m)=Antenna Factor (dB/m) + Cable Factor (dB).
 4. Emission level (dBuV/m) = 20 log Emission level (uV/m).



Worst Test Mode	NFC (HW1)	Channel	13.56MHz
Frequency Range	13.11MHz ~ 14.01MHz	Detector Function	Quasi-Peak (QP)

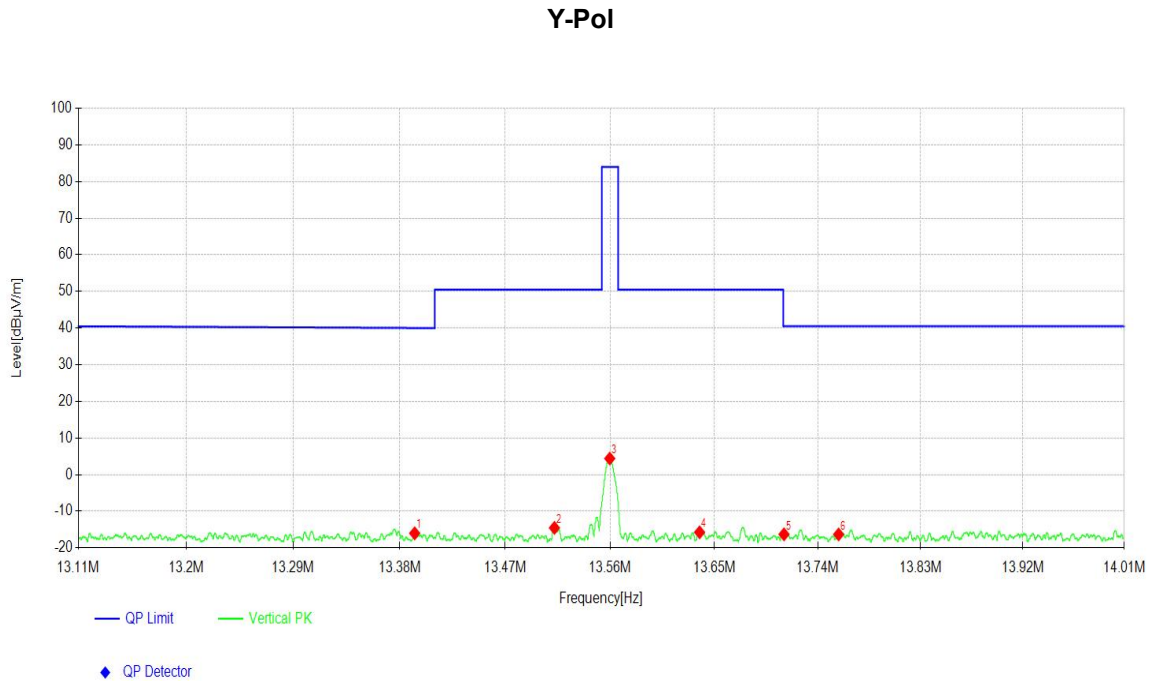

NO.	Freq. [MHz]	Reading [dBuV/m]	Factor [dB]	Level [dBuV/m]	Limit [dBuV/m]	Margin [dB]	Height [cm]	Angle [°]
1	13.393	3.91	-19.92	-16.01	40.03	56.04	100	354
2	13.512	5.38	-19.90	-14.52	50.50	65.02	100	27
3	13.560	24.30	-19.90	4.40	84.00	79.60	100	225
4	13.637	4.14	-19.88	-15.74	50.50	66.24	100	10
5	13.711	3.58	-19.87	-16.29	40.50	56.79	100	326
6	13.758	3.55	-19.87	-16.32	40.50	56.82	100	293

Remark: 1. Conversion factor to 30m has been added to the factor.
 2. Level (dBuV/m) = Reading (dBuV/m) + Factor (dB).
 3. Factor (dB/m)=Antenna Factor (dB/m) + Cable Factor (dB).
 4. Emission level (dBuV/m) = 20 log Emission level (uV/m).



Worst Test Mode	NFC (HW1)	Channel	13.56MHz
Frequency Range	13.11MHz ~ 14.01MHz	Detector Function	Quasi-Peak (QP)

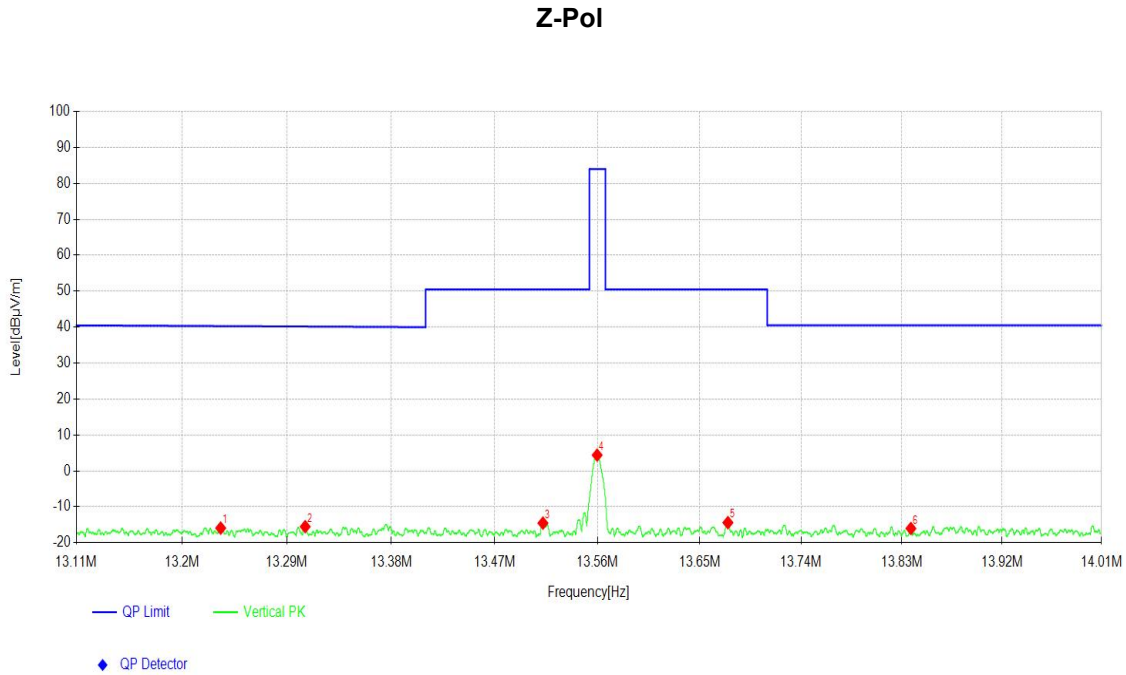

NO.	Freq. [MHz]	Reading [dBuV/m]	Factor [dB]	Level [dBuV/m]	Limit [dBuV/m]	Margin [dB]	Height [cm]	Angle [°]
1	13.233	4.05	-19.96	-15.91	40.29	56.20	100	333
2	13.306	4.42	-19.93	-15.51	40.17	55.68	100	316
3	13.512	5.38	-19.90	-14.52	50.50	65.02	100	27
4	13.560	24.30	-19.90	4.40	84.00	79.60	100	225
5	13.675	5.49	-19.88	-14.39	50.50	64.89	100	78
6	13.838	3.83	-19.85	-16.02	40.50	56.52	100	310

Remark: 1. Conversion factor to 30m has been added to the factor.
 2. Level (dBuV/m) = Reading (dBuV/m) + Factor (dB).
 3. Factor (dB/m)=Antenna Factor (dB/m) + Cable Factor (dB).
 4. Emission level (dBuV/m) = 20 log Emission level (uV/m).



Result of Radiated Emissions(9kHz~30MHz)

Worst Test Mode	NFC (HW1)	Channel	13.56MHz
Frequency Range	9KHz ~ 30MHz	Detector Function	Quasi-Peak (QP)

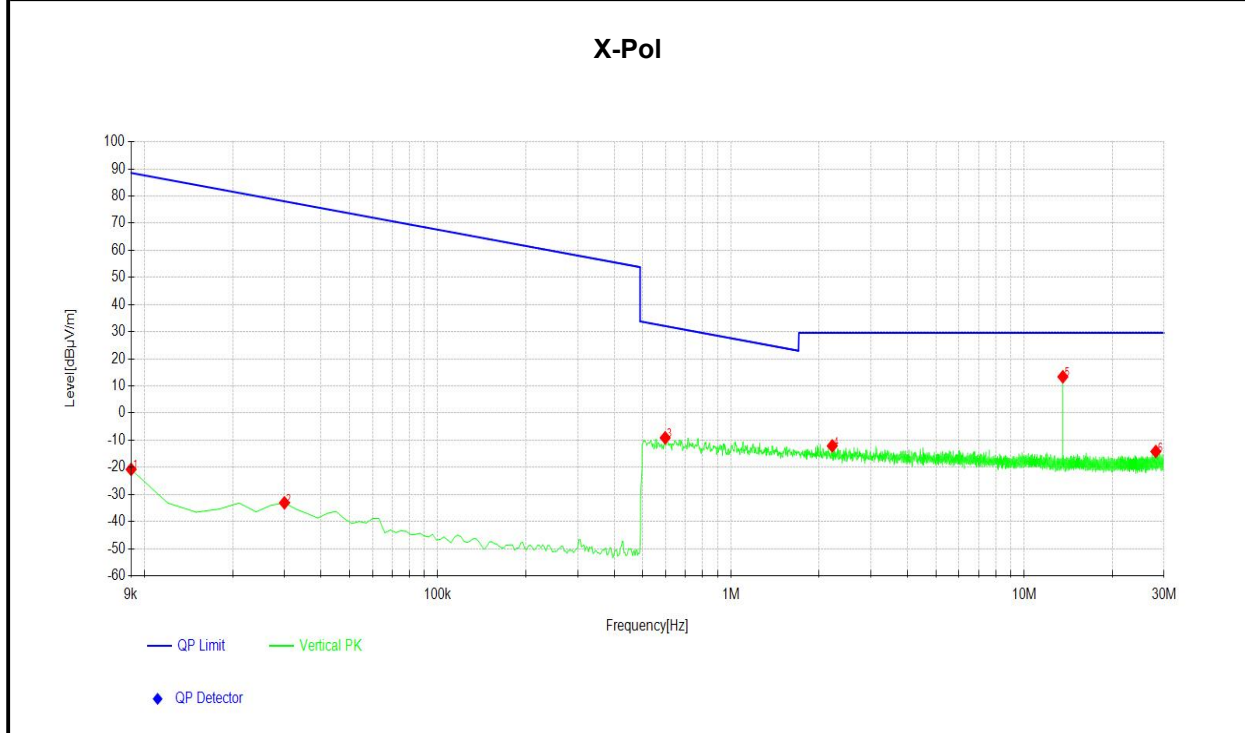

NO.	Freq. [MHz]	Reading [dBuV/m]	Factor [dB]	Level [dBuV/m]	Limit [dBuV/m]	Margin [dB]	Height [cm]	Angle [°]
1	0.009	38.72	-59.48	-20.76	88.52	109.28	150	141
2	0.030	26.08	-59.18	-33.10	78.06	111.16	150	146
3	0.597	9.69	-18.81	-9.12	32.08	41.20	150	360
4	2.217	6.97	-19.08	-12.11	29.57	41.68	150	316
5	13.557	33.27	-19.90	13.37	29.55	16.18	150	118
6	28.131	5.75	-19.93	-14.18	29.54	43.72	150	360

Remark: 1. Conversion factor to 30m has been added to the factor.
 2. Level (dBuV/m) = Reading (dBuV/m) + Factor (dB).
 3. Factor (dB/m)=Antenna Factor (dB/m) + Cable Factor (dB).
 4. Emission level (dBuV/m) = 20 log Emission level (uV/m).



Worst Test Mode	NFC (HW1)	Channel	13.56MHz
Frequency Range	9KHz ~ 30MHz	Detector Function	Quasi-Peak (QP)

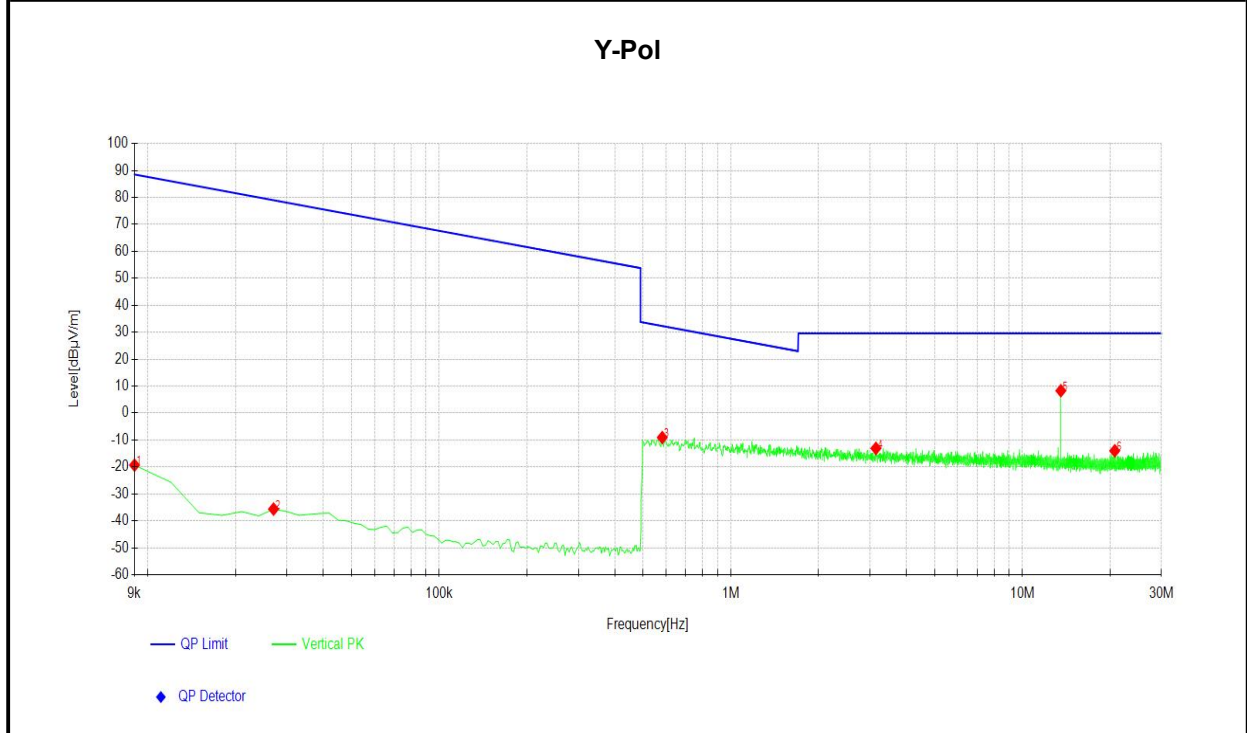

NO.	Freq. [MHz]	Reading [dBuV/m]	Factor [dB]	Level [dBuV/m]	Limit [dBuV/m]	Margin [dB]	Height [cm]	Angle [°]
1	0.009	40.16	-59.48	-19.32	88.52	107.84	150	10
2	0.027	23.59	-59.22	-35.63	78.98	114.61	150	83
3	0.582	9.73	-18.79	-9.06	32.30	41.36	150	315
4	3.146	5.92	-19.01	-13.09	29.56	42.65	150	38
5	13.563	28.20	-19.90	8.30	29.55	21.25	150	191
6	20.756	5.98	-19.98	-14.00	29.54	43.54	150	202

Remark: 1. Conversion factor to 30m has been added to the factor.
 2. Level (dBuV/m) = Reading (dBuV/m) + Factor (dB).
 3. Factor (dB/m)=Antenna Factor (dB/m) + Cable Factor (dB).
 4. Emission level (dBuV/m) = 20 log Emission level (uV/m).



Worst Test Mode	NFC (HW1)	Channel	13.56MHz
Frequency Range	9KHz ~ 30MHz	Detector Function	Quasi-Peak (QP)

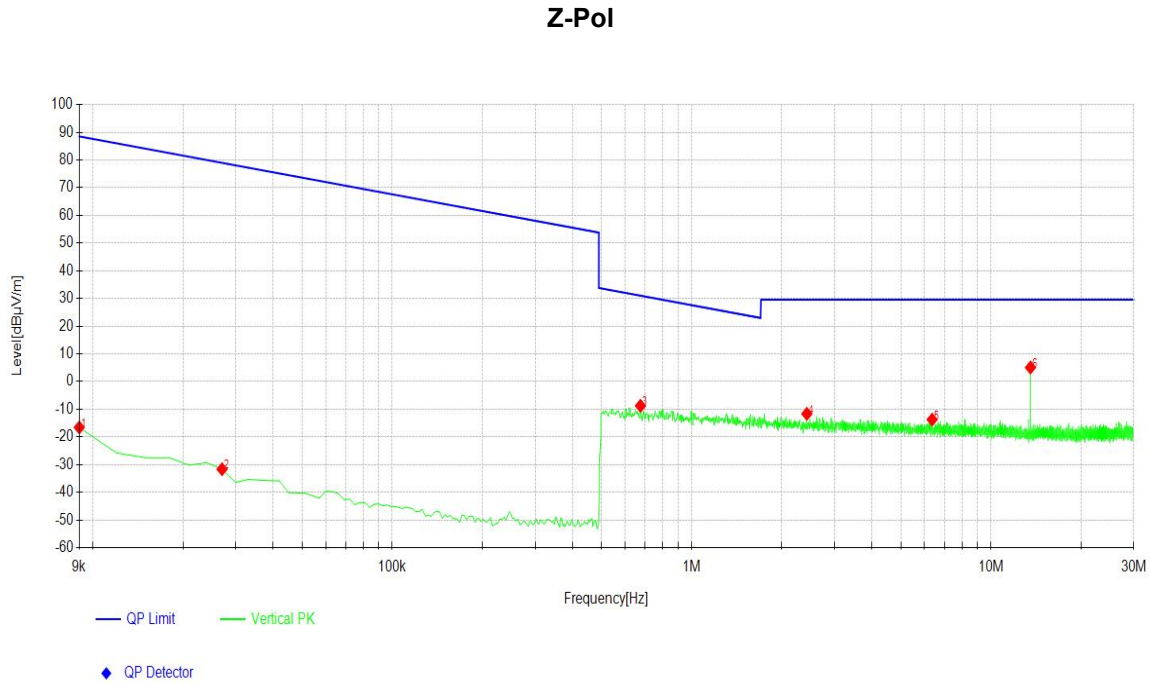

NO.	Freq. [MHz]	Reading [dBuV/m]	Factor [dB]	Level [dBuV/m]	Limit [dBuV/m]	Margin [dB]	Height [cm]	Angle [°]
1	0.009	42.91	-59.48	-16.57	88.52	105.09	150	26
2	0.027	27.58	-59.22	-31.64	78.98	110.62	150	333
3	0.675	10.16	-18.91	-8.75	31.01	39.76	150	26
4	2.427	7.40	-19.06	-11.66	29.57	40.40	150	333
5	6.362	5.59	-19.33	-13.74	29.56	43.27	150	77
6	13.554	24.97	-19.90	5.07	29.55	24.48	150	140

Remark: 1. Conversion factor to 30m has been added to the factor.
 2. Level (dBuV/m) = Reading (dBuV/m) + Factor (dB).
 3. Factor (dB/m)=Antenna Factor (dB/m) + Cable Factor (dB).
 4. Emission level (dBuV/m) = 20 log Emission level (uV/m).



Result of Radiated Emissions(30MHz~1GHz)

Worst Test Mode	NFC (HW1)	Channel	13.56MHz
Frequency Range	30MHz ~ 1GHz	Detector Function	Quasi-Peak (QP)

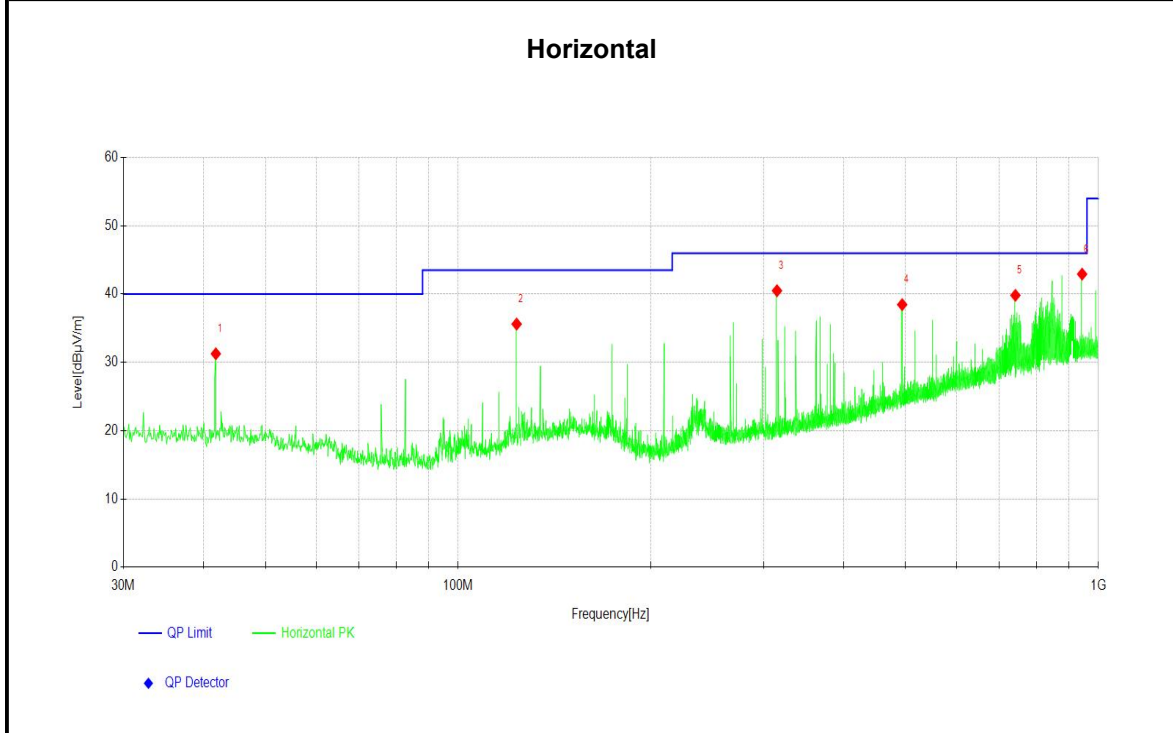

NO.	Freq. [MHz]	Reading [dBµV]	Factor [dB/m]	Level [dBµV/m]	Limit [dBµV/m]	Margin [dB]	Height [cm]	Angle [°]
1	41.835	11.39	19.87	31.26	40.00	8.74	100	20
2	123.420	16.60	19.01	35.61	43.50	7.89	200	312
3	314.820	20.41	20.09	40.50	46.00	5.50	100	23
4	493.803	14.54	23.92	38.46	46.00	7.54	200	6
5	742.051	11.92	27.90	39.82	46.00	6.18	100	344
6	943.249	12.83	30.10	42.93	46.00	3.07	100	344

Remark: 1. Level (dBuV/m) = Reading (dBuV/m) + Factor (dB).
 2. Factor (dB/m) = Antenna Factor (dB/m) + Cable Factor (dB).
 3. Margin(dB) = Limit[dBµV/m] - Level [dBµV/m]
 4. Emission level (dBuV/m) = 20 log Emission level (uV/m).



Worst Test Mode	NFC (HW1)	Channel	13.56MHz
Frequency Range	30MHz ~ 1GHz	Detector Function	Quasi-Peak (QP)

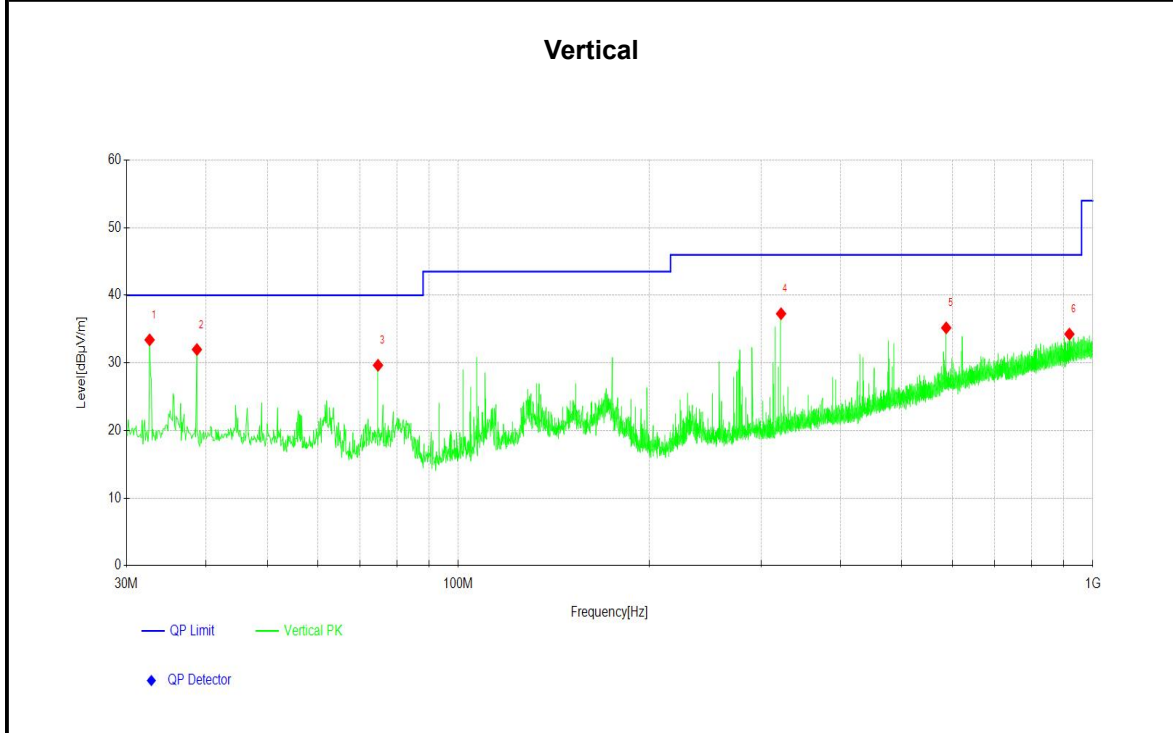

NO	Freq. [MHz]	Reading [dBµV]	Factor [dB/m]	Level [dBµV/m]	Limit [dBµV/m]	Margin [dB]	Height [cm]	Angle [°]
1	32.619	13.93	19.48	33.41	40.00	6.59	200	101
2	38.731	12.16	19.82	31.98	40.00	8.02	200	130
3	74.721	13.44	16.21	29.65	40.00	10.35	200	101
4	322.581	16.97	20.31	37.28	46.00	8.72	200	109
5	587.418	9.54	25.65	35.19	46.00	10.81	200	116
6	918.415	4.36	29.90	34.26	46.00	11.74	100	261

Remark: 1. Level (dBuV/m) = Reading (dBuV/m) + Factor (dB).
 2. Factor (dB/m) = Antenna Factor (dB/m) + Cable Factor (dB).
 3. Margin(dB) = Limit[dBµV/m] - Level [dBµV/m]
 4. Emission level (dBuV/m) = 20 log Emission level (uV/m).

3.3 FREQUENCY TOLERANCE

3.3.1 LIMIT OF FREQUENCY TOLERANCE

The frequency tolerance of the carrier signal shall be maintained within $\pm 0.01\%$ (100ppm) of the operating frequency over a temperature variation of -20 degrees to $+ 50$ degrees C at normal supply voltage, and for a variation in the primary supply voltage from 85% to 115% of the rated supply voltage at a temperature of 20 degrees C. For battery operated equipment, the equipment tests shall be performed using a new battery.

3.3.2 TEST PROCEDURES

Refer to ANSI C63.10-2020

3.3.3 TEST SETUP

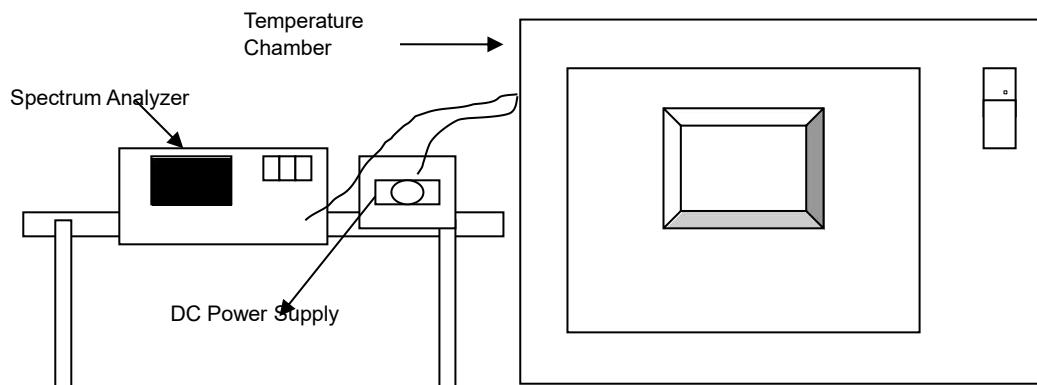



3.3.4 TEST RESULTS

FREQUENCY STABILITY VERSUS TEMP.									
TEMP. (°C)	POWER SUPPLY (V)	0 MINUTE		2 MINUTE		5 MINUTE		10 MINUTE	
		Measured Frequency (MHz)	Frequency Drift (ppm)	Measured Frequency (MHz)	Frequency Drift (ppm)	Measured Frequency (MHz)	Frequency Drift (ppm)	Measured Frequency (MHz)	Frequency Drift (ppm)
50	5	13.559910	-6.64	13.559906	-6.93	13.559913	-6.42	13.559907	-6.86
40	5	13.559908	-6.78	13.559908	-6.78	13.559918	-6.05	13.559912	-6.49
30	5	13.559905	-7.01	13.559904	-7.08	13.559917	-6.12	13.559909	-6.71
20	5	13.559913	-6.42	13.559908	-6.78	13.559910	-6.64	13.559907	-6.86
10	5	13.559909	-6.71	13.559903	-7.15	13.559908	-6.78	13.559909	-6.71
0	5	13.559905	-7.01	13.559911	-6.56	13.559908	-6.78	13.559912	-6.49
-10	5	13.559909	-6.71	13.559906	-6.93	13.559915	-6.27	13.559908	-6.78
-20	5	13.559911	-6.56	13.559906	-6.93	13.559918	-6.05	13.559907	-6.86
20	4.5	13.559915	-6.27	13.559911	-6.56	13.559916	-6.19	13.559902	-7.23
	5.5	13.559914	-6.34	13.559902	-7.23	13.559910	-6.64	13.559907	-6.86

3.4 20dB BANDWIDTH

3.4.1 LIMITS OF 20dB BANDWIDTH

The 20dB bandwidth shall be specified in operating frequency band. (13.11MHz – 14.01MHz)

3.4.2 TEST PROCEDURE

- a. Turn on the EUT and connect it to measurement instrument. Then set it to any one convenient frequency within its operating range. Set a reference level on the measuring instrument equal to the highest peak value.
- b. The resolution bandwidth of 1kHz and the video bandwidth of 3kHz were used.
- c. Measured spectrum width with power higher than 20dB below carrier.

Note: Because the measured signal is CW or CW-like adjust the RBW per C63.10 would not be practical since measured bandwidth will always follow the RBW and the result will be approximately the RBW

3.4.3 TEST SETUP

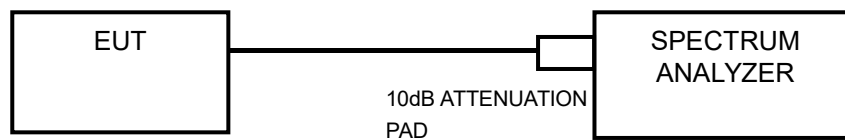



3.4.4 TEST RESULTS

Channel	Channel Frequency (MHz)	20db Bandwidth (KHz)
1	13.56	2.48

Lower & Upper Test Frequency Point (MHz)	Test Frequency (MHz)	P/F
Lower	13.5586	PASS
Upper	13.5611	PASS

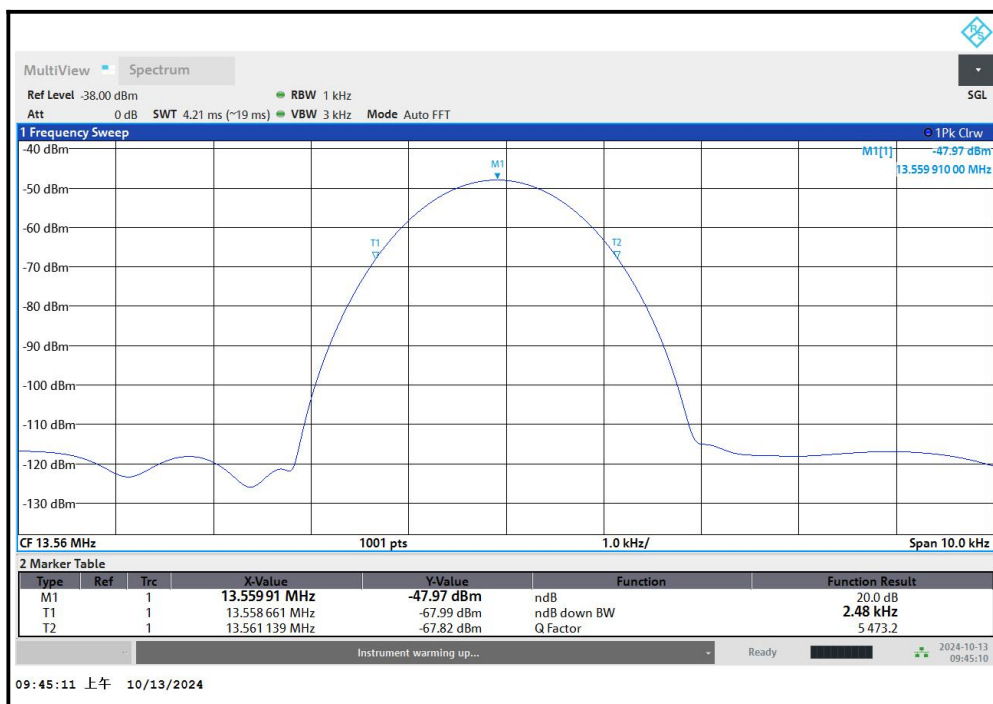



4 PHOTOGRAPHS OF TEST SETUP

Please refer to the attached file (Test Photos).



5 PHOTOGRAPHS OF THE EUT

Please refer to the attached file (External Photos report and Internal Photos).

----- End of the Report -----



Important

- (1) The test report is invalid without the official stamp of CVC;
- (2) Any part photocopies of the test report are forbidden without the written permission from CVC;
- (3) The test report is invalid without the signatures of Approval and Reviewer;
- (4) The test report is invalid if altered;
- (5) Objections to the test report must be submitted to CVC within 15 days.
- (6) Generally, commission test is responsible for the tested samples only.
- (7) As for the test result “-” or “N” means “not applicable”, “/” means “not test”, “P” means “pass” and “F” means “fail”

Address: No. 1301-14&16, Guanguang Road, Xinlan Community, Guanlan Subdistrict, Longhua District, Shenzhen, Guangdong, China

Post Code: 518110 Tel: 0755-23763060-8805

Fax: 0755-23763060 E-mail: sz-kf@cvc.org.cn

<http://www.cvc.org.cn>