



FCC PART 15C TEST REPORT

No. I22Z61813-IOT01

for

Honor Device Co., Ltd.

Smart Phone

Model Name: RMO-NX3

FCC ID: 2AYGCRMO-NX3

with

Hardware Version: HN2RMOM

Software Version: 6.1.0.21(C900E21R1P1)

Issued Date: 2022-11-4

Note:

The test results in this test report relate only to the devices specified in this report. This report shall not be reproduced except in full without the written approval of CTTL.

The report must not be used by the client to claim product certification, approval, or endorsement by NVLAP, NIST, or any agency of the U.S. Government.

Test Laboratory:

CTTL, Telecommunication Technology Labs, CAICT

No.52, HuayuanNorth Road, Haidian District, Beijing, P. R. China 100191.

Tel:+86(0)10-62304633-2512,Fax:+86(0)10-62304633-2504

Email:cttl_terminals@caict.ac.cn, website: www.chinattl.com



No. I22Z61813-IOT01

REPORT HISTORY

Report Number	Revision	Description	Issue Date
I22Z61813-IOT01	Rev.0	1st edition	2022-11-4

CONTENTS

1. TEST LABORATORY	5
1.1. INTRODUCTION & ACCREDITATION	5
1.2. TESTING LOCATION	5
1.3. TESTING ENVIRONMENT	6
1.4. PROJECT DATA	6
1.5. SIGNATURE	6
2. CLIENT INFORMATION	7
2.1. APPLICANT INFORMATION	7
2.2. MANUFACTURER INFORMATION	7
3. EQUIPMENT UNDER TEST (EUT) AND ANCILLARY EQUIPMENT (AE)	8
3.1. ABOUT EUT	8
3.2. INTERNAL IDENTIFICATION OF EUT	8
3.3. INTERNAL IDENTIFICATION OF AE	8
3.4. NORMAL ACCESSORY SETTING	9
3.5. GENERAL DESCRIPTION	9
4. REFERENCE DOCUMENTS	10
4.1. DOCUMENTS SUPPLIED BY APPLICANT	10
4.2. REFERENCE DOCUMENTS FOR TESTING	10
5. TEST RESULTS	11
5.1. SUMMARY OF TEST RESULTS	11
5.2. STATEMENTS	11
6. TEST FACILITIES UTILIZED	12
7. MEASUREMENT UNCERTAINTY	13
7.1. PEAK OUTPUT POWER - CONDUCTED	13
7.2. FREQUENCY BAND EDGES - CONDUCTED	13
7.3. FREQUENCY BAND EDGES - RADIATED	13
7.4. TRANSMITTER SPURIOUS EMISSION - CONDUCTED	13
7.5. TRANSMITTER SPURIOUS EMISSION - RADIATED	13
7.6. TIME OF OCCUPANCY (DWELL TIME)	13
7.7. 20dB BANDWIDTH	14
7.8. CARRIER FREQUENCY SEPARATION	14
7.9. AC POWERLINE CONDUCTED EMISSION	14
ANNEX A: EUT PARAMETERS	15
ANNEX B: DETAILED TEST RESULTS	16
B.1. MEASUREMENT METHOD	16
B.2. PEAK OUTPUT POWER	17



B.3. FREQUENCY BAND EDGES – CONDUCTED19

B.4. FREQUENCY BAND EDGES –RADIATED.....26

B.5. TRANSMITTER SPURIOUS EMISSION - CONDUCTED36

B.6. TRANSMITTER SPURIOUS EMISSION - RADIATED61

B.7. TIME OF OCCUPANCY (DWELL TIME).....72

B.8. 20DB BANDWIDTH.....83

B.9. CARRIER FREQUENCY SEPARATION89

B.10. NUMBER OF HOPPING CHANNELS92

B.11. AC POWERLINE CONDUCTED EMISSION96

ANNEX C: ACCREDITATION CERTIFICATE106



No. I22Z61813-IOT01

1. Test Laboratory

1.1. Introduction & Accreditation

Telecommunication Technology Labs, CAICT is an ISO/IEC 17025:2017 accredited test laboratory under NATIONAL VOLUNTARY LABORATORY ACCREDITATION PROGRAM (NVLAP) with lab code 600118-0, and is also an FCC accredited test laboratory (CN5017), and ISED accredited test laboratory (ISED#: 24849). The detail accreditation scope can be found on NVLAP website.

1.2. Testing Location

Conducted testing Location: CTTL(huayuan North Road)

Address: No. 52, Huayuan North Road, Haidian District, Beijing,
P. R. China100191

Radiated testing Location: CTTL(huayuan North Road)

Address: No. 52, Huayuan North Road, Haidian District, Beijing,
P. R. China100191

1.3. Testing Environment

Normal Temperature: 20-27°C
Relative Humidity: 20-50%

1.4. Project data

Testing Start Date: 2022-10-9
Testing End Date: 2022-11-4

1.5. Signature



Wu Le
(Prepared this test report)



Sun Zhenyu
(Reviewed this test report)



Hu Xiaoyu
(Approved this test report)



2. Client Information

2.1. Applicant Information

Company Name: Honor Device Co., Ltd.
Address /Post: Shum Yip Sky Park, No. 8089, Hongli West Road, Shenzhen, China
City: Shenzhen
Postal Code: /
Country: China
Telephone: /
Fax: /

2.2. Manufacturer Information

Company Name: Honor Device Co., Ltd.
Address /Post: Shum Yip Sky Park, No. 8089, Hongli West Road, Shenzhen, China
City: Shenzhen
Postal Code: /
Country: China
Telephone: /
Fax: /

3. Equipment Under Test (EUT) and Ancillary Equipment (AE)

3.1. About EUT

Description	Smart Phone
Model Name	RMO-NX3
FCC ID	2AYGCRMO-NX3
Frequency Band	ISM 2400MHz~2483.5MHz
Type of Modulation	GFSK/π/4 DQPSK/8DPSK
Number of Channels	79
Power Supply	3.87V DC by Battery
Antenna gain	-2dBi

3.2. Internal Identification of EUT

EUT ID*	SN or IMEI	HW Version	SW Version	Date of receipt
EUT2	869123060002698/ 869123060006962	HN2RMOM	6.1.0.21(C900E21R1P1)	2022-10-9
EUT3	869123060004322/ 869123060008596	HN2RMOM	6.1.0.21(C900E21R1P1)	2022-10-9
EUT4	869123060003670/ 869123060007945	HN2RMOM	6.1.0.21(C900E21R1P1)	2022-10-9
EUT5	869123060004835/ 869123060009107	HN2RMOM	6.1.0.21(C900E21R1P1)	2022-10-9

*EUT ID: is used to identify the test sample in the lab internally.

3.3. Internal Identification of AE

AE ID*	Name	Model	Manufacturer
AE1-1	Adapter	HW-100400E01	Honor Device Co., Ltd.
AE1-2	Adapter	HW-100400B01	Honor Device Co., Ltd.
AE1-3	Adapter	HW-100400U01	Honor Device Co., Ltd.
AE2-1	USB Cable	WA0052	Broad
AE2-2	USB Cable	CUDU01B-HC385-EH	FOXCONN
AE2-3	USB Cable	L99UC144-CS-H	LUXSHARE
AE2-4	USB Cable	AU2-CRO009HF	Freeport
AE2-5	USB Cable	2120-00062-0	MING JI
AE2-6	USB Cable	2120-00060-0	MING JI
AE2-7	USB Cable	L99UC139-CS-H	LUXSHARE
AE3-1	Headset	1293-3283-3.5mm-339	Quancheng
AE3-2	Headset	EPAB542-2WH05-DH	FOXCONN
AE3-3	Headset	MEND1532B528C00	Lianchuang
AE4-1	Battery	HB506492EFW	Honor Device Co., Ltd. (Sunwoda)



AE4-2	Battery	HB506492EFW	Honor Device Co., Ltd. (Desay)
AE4-3	Battery	HB506492EFW	Honor Device Co., Ltd. (CosMX)
AE5-1	Type-C to 3.5mm	USB042020090AW7	LC
AE5-2	Type-C to 3.5mm	6001-7001-TC-348	QC

*AE ID: is used to identify the test sample in the lab internally.

3.4. Normal Accessory setting

Fully charged battery should be used during the test.

3.5. General Description

The Equipment Under Test (EUT) is a model of Smart Phone with integrated antenna. It consists of normal options: lithium battery, charger. Manual and specifications of the EUT were provided to fulfill the test. Samples undergoing test were selected by the Client.

4. Reference Documents

4.1. Documents supplied by applicant

EUT parameters, referring to Annex A for detailed information, is supplied by the client or manufacturer, which is the basis of testing.

4.2. Reference Documents for testing

The following documents listed in this section are referred for testing.

Reference	Title	Version
FCC Part15	FCC CFR 47, Part 15, Subpart C: 15.205 Restricted bands of operation; 15.209 Radiated emission limits, general requirements; 15.247 Operation within the bands 902–928MHz, 2400– 2483.5 MHz, and 5725–5850 MHz.	2021
ANSI C63.10	American National Standard of Procedures for Compliance Testing of Unlicensed Wireless Devices	June,2013

5. Test Results

5.1. Summary of Test Results

Abbreviations used in this clause:

P Pass, The EUT complies with the essential requirements in the standard.

F Fail, The EUT does not comply with the essential requirements in the standard

NA Not Applicable, The test was not applicable

NP Not Performed, The test was not performed by CTTL

SUMMARY OF MEASUREMENT RESULTS	Sub-clause	Verdict
Peak Output Power	15.247 (b)(1)	P
Frequency Band Edges- Conducted	15.247 (d)	P
Frequency Band Edges- Radiated	15.247, 15.205, 15.209	P
Transmitter Spurious Emission - Conducted	15.247 (d)	P
Transmitter Spurious Emission - Radiated	15.247, 15.205, 15.209	P
Time of Occupancy (Dwell Time)	15.247 (a) (1)(iii)	P
20dB Bandwidth	15.247 (a)(1)	NA
Carrier Frequency Separation	15.247 (a)(1)	P
Number of hopping channels	15.247 (a)(iii)	P
AC Powerline Conducted Emission	15.107, 15.207	P

Please refer to **ANNEX A** for detail.

The measurement is made according to ANSI C63.10.

5.2. Statements

CTTL has evaluated the test cases requested by the applicant /manufacturer as listed in section 5.1 of this report for the EUT specified in section 3 according to the standards or reference documents listed in section 4.2

6. Test Facilities Utilized

Conducted test system

No.	Equipment	Model	Serial Number	Manufacturer	Calibration Period	Calibration Due date
1	Vector Signal Analyzer	FSQ26	100024	R&S	1 year	2023-03-23
2	Bluetooth Tester	CBT	100315	R&S	1 year	2023-01-22
3	Test Receiver	ESCI	100344	R&S	1 year	2023-03-21
4	LISN	ENV216	101200	R&S	1 year	2023-06-29
5	Shielding Room	S81	/	ETS-Lindgren	/	/

Radiated emission test system

No.	Equipment	Model	Serial Number	Manufacturer	Calibration Period	Calibration Due date
1	Test Receiver	ESW44	103015	R&S	1 year	2023-01-23
2	BiLog Antenna	VULB9163	01223	Schwarzbeck	1 year	2023-07-25
3	Dual-Ridge Waveguide Horn Antenna	3116	2661	ETS-Lindgren	1 year	2023-02-08
4	EMI Antenna	3115	00167250	ETS-Lindgren	1 year	2023-06-20
5	Antenna	HFH2-Z2	829324/007	R&S	1 year	2022-12-22
6	Bluetooth Tester	CBT	101042	R&S	1 year	2022-12-23

7. Measurement Uncertainty

7.1. Peak Output Power - Conducted

Measurement Uncertainty:

Measurement Uncertainty (k=2)	0.66dB
-------------------------------	--------

7.2. Frequency Band Edges - Conducted

Measurement Uncertainty:

Measurement Uncertainty (k=2)	0.66dB
-------------------------------	--------

7.3. Frequency Band Edges - Radiated

Measurement Uncertainty:

Measurement Uncertainty (k=2)	/
-------------------------------	---

7.4. Transmitter Spurious Emission - Conducted

Measurement Uncertainty:

Frequency Range	Uncertainty (k=2)
30 MHz ~ 8 GHz	1.22dB
8 GHz ~ 12.75 GHz	1.51dB
12.7GHz ~ 26 GHz	1.51dB

7.5. Transmitter Spurious Emission - Radiated

Measurement Uncertainty:

Frequency Range	Uncertainty(dBm) (k=2)
9kHz-30MHz	4.92
$30\text{MHz} \leq f \leq 1\text{GHz}$	5.18
$1\text{GHz} \leq f \leq 18\text{GHz}$	5.54
$18\text{GHz} \leq f \leq 40\text{GHz}$	5.26

7.6. Time of Occupancy (Dwell Time)

Measurement Uncertainty:

Measurement Uncertainty (k=2)	0.88ms
-------------------------------	--------

7.7. 20dB Bandwidth

Measurement Uncertainty:

Measurement Uncertainty (k=2)	61.936Hz
-------------------------------	----------

7.8. Carrier Frequency Separation

Measurement Uncertainty:

Measurement Uncertainty (k=2)	61.936Hz
-------------------------------	----------

7.9. AC Powerline Conducted Emission

Measurement Uncertainty:

Measurement Uncertainty (k=2)	3.08dB
-------------------------------	--------



No. I22Z61813-IOT01

ANNEX A: EUT parameters

Disclaimer: The antenna gain provided by the client may affect the validity of the measurement results in this report, and the client shall bear the impact and consequences arising therefrom.

ANNEX B: Detailed Test Results

B.1. Measurement Method

B.1.1. Conducted Measurements

The measurement is made according to ANSI C63.10.

- 1). Connect the EUT to the test system correctly.
- 2). Set the EUT to the required work mode (Transmitter, receiver or transmitter & receiver).
- 3). Set the EUT to the required channel.
- 4). Set the EUT hopping mode (hopping or hopping off).
- 5). Set the spectrum analyzer to start measurement.
- 6). Record the values. Vector Signal Analyzer

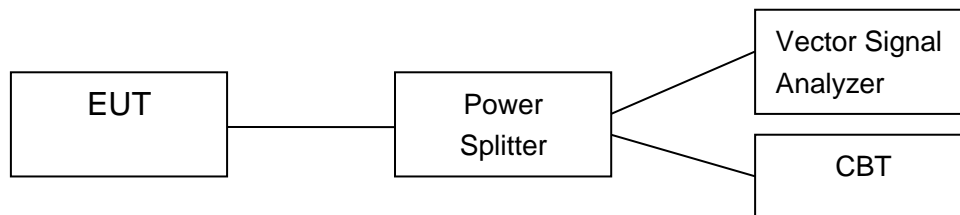

B.1.2. Radiated Emission Measurements

The measurement is made according to ANSI C63.10

The radiated emission test is performed in semi-anechoic chamber. The distance from the EUT to the reference point of measurement antenna is 3m. The test is carried out on both vertical and horizontal polarization and only maximization result of both polarizations is kept. During the test, the turntable is rotated 360° and the measurement antenna is moved from 1m to 4m to get the maximization result.

In the case of radiated emission, the used settings are as follows,

Sweep frequency from 30 MHz to 1GHz, RBW = 100 kHz, VBW = 300 kHz;

Sweep frequency from 1 GHz to 26GHz, RBW = 1MHz, VBW = 1MHz;

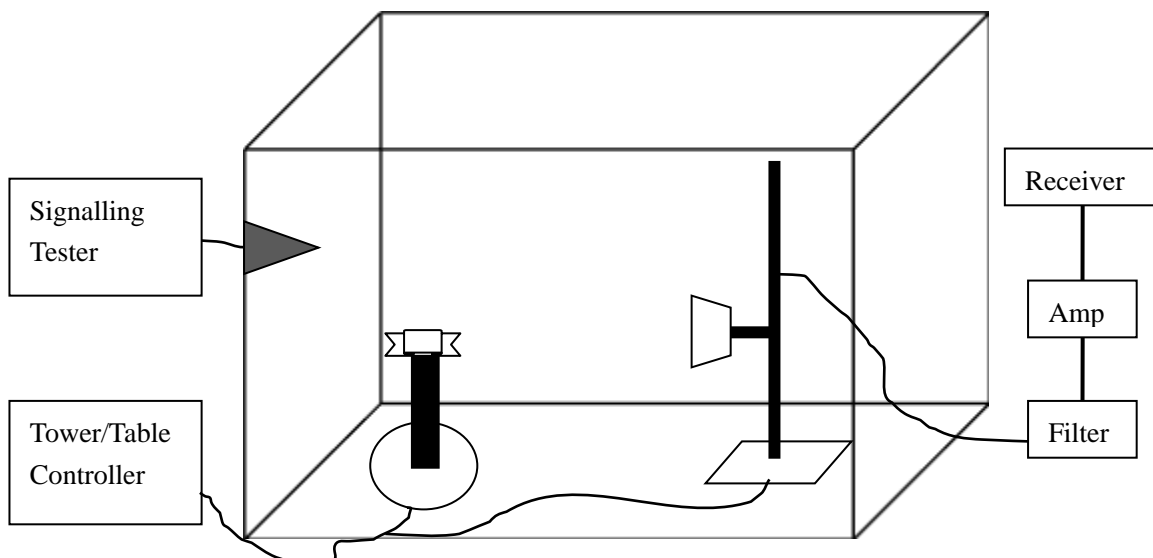

B.2. Peak Output Power

B.2.1. Peak Output Power – Conducted

Method of Measurement: See ANSI C63.10-clause 7.8.5

a) Use the following spectrum analyzer settings:

- Span: 6MHz
- RBW: 3MHz
- VBW: 3MHz
- Sweep time: 2.5ms
- Detector function: peak
- Trace: max hold

b) Allow trace to stabilize.

c) Use the marker-to-peak function to set the marker to the peak of the emission.

d) The indicated level is the peak output power.

Measurement Limit:

Standard	Limits	
	FCC Part 15.247 (b)(1)	Bandwidth \leq 1MHz
Bandwidth $>$ 1MHz		21dBm (125mW)

Measurement Results:

For GFSK

Channel	Ch 0 2402 MHz	Ch 39 2441 MHz	Ch 78 2480 MHz	Conclusion
Peak Conducted Output Power (dBm)	12.43	13.00	12.61	P

For $\pi/4$ DQPSK

Channel	Ch 0 2402 MHz	Ch 39 2441 MHz	Ch 78 2480 MHz	Conclusion
Peak Conducted Output Power (dBm)	11.43	11.62	11.50	P

For 8DPSK

Channel	Ch 0 2402 MHz	Ch 39 2441 MHz	Ch 78 2480 MHz	Conclusion
Peak Conducted Output Power (dBm)	11.71	11.85	11.67	P

Conclusion: PASS

B.2.2. E.I.R.P.

The radiated E.I.R.P. is listed below:

Antenna gain = -2dBi

For GFSK

Channel	Ch 0 2402 MHz	Ch 39 2441 MHz	Ch 78 2480 MHz	Conclusion
E.I.R.P (dBm)	10.43	11.00	10.61	P

For $\pi/4$ DQPSK

Channel	Ch 0 2402 MHz	Ch 39 2441 MHz	Ch 78 2480 MHz	Conclusion
E.I.R.P (dBm)	9.43	9.62	9.50	P

For 8DPSK

Channel	Ch 0 2402 MHz	Ch 39 2441 MHz	Ch 78 2480 MHz	Conclusion
E.I.R.P (dBm)	9.71	9.85	9.67	P

Note: E.I.R.P. are calculated with the antenna gain.

Conclusion: PASS

B.3. Frequency Band Edges – Conducted

Method of Measurement: See ANSI C63.10-clause 7.8.6

Connect the spectrum analyzer to the EUT using an appropriate RF cable connected to the EUT output. Configure the spectrum analyzer settings as described below (be sure to enter all losses between the unlicensed wireless device output and the spectrum analyzer).

- Span: 10 MHz
- Resolution Bandwidth: 100 kHz
- Video Bandwidth: 300 kHz
- Sweep Time:Auto
- Detector: Peak
- Trace: max hold

Place a marker at the end of the restricted band closest to the transmit frequency to show compliance. Also measure any emissions in the restricted bands. Save the spectrum analyzer plot. Repeat for each power and modulation for lowest and highest channel.

Observe the stored trace and measure the amplitude delta between the peak of the fundamental and the peak of the band-edge emission. This is not an absolute field strength measurement; it is only a relative measurement to determine the amount by which the emission drops at the band edge relative to the highest fundamental emission level.

Measurement Limit:

Standard	Limit (dBc)
FCC 47 CFR Part 15.247 (d)	< -20

Measurement Result:

For GFSK

Channel	Hopping	Band Edge Power (dBc)		Conclusion
0	Hopping OFF	Fig.1	-63.41	P
	Hopping ON	Fig.2	-67.23	P
78	Hopping OFF	Fig.3	-68.63	P
	Hopping ON	Fig.4	-70.27	P

For $\pi/4$ DQPSK

Channel	Hopping	Band Edge Power (dBc)		Conclusion
0	Hopping OFF	Fig.5	-58.00	P
	Hopping ON	Fig.6	-64.23	P
78	Hopping OFF	Fig.7	-63.19	P
	Hopping ON	Fig.8	-65.46	P

For 8DPSK

Channel	Hopping	Band Edge Power (dBc)		Conclusion
0	Hopping OFF	Fig.9	-57.26	P
	Hopping ON	Fig.10	-67.31	P
78	Hopping OFF	Fig.11	-65.98	P

	Hopping ON	Fig.12	-67.96	P
--	------------	--------	--------	---

Conclusion: PASS

Test graphs as below

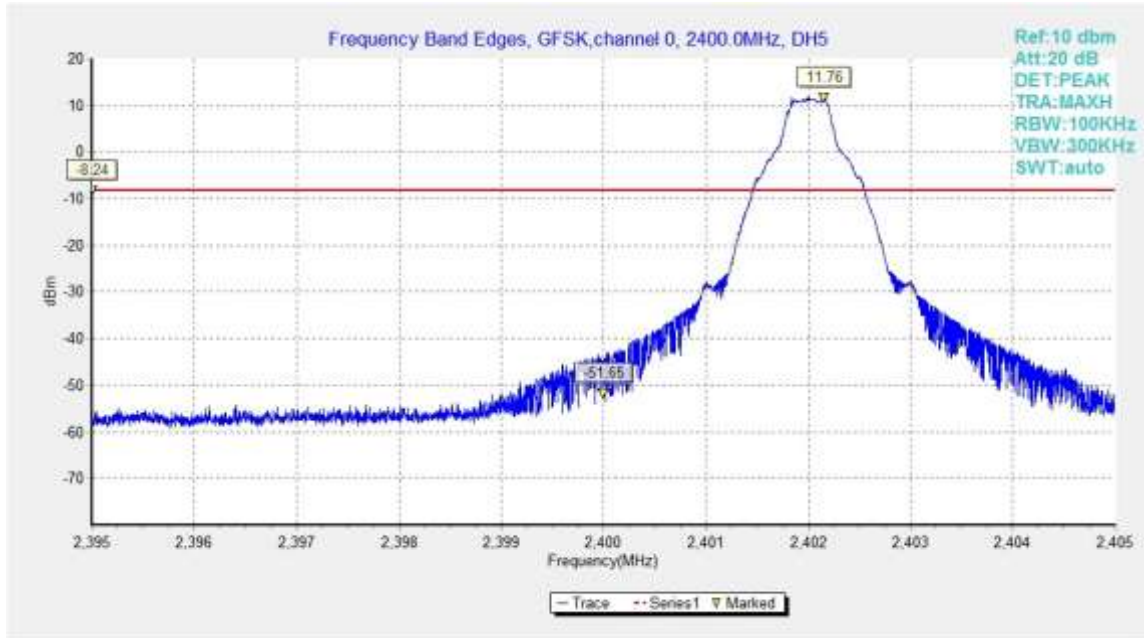

Fig.1. Frequency Band Edges: GFSK, Channel 0, Hopping Off

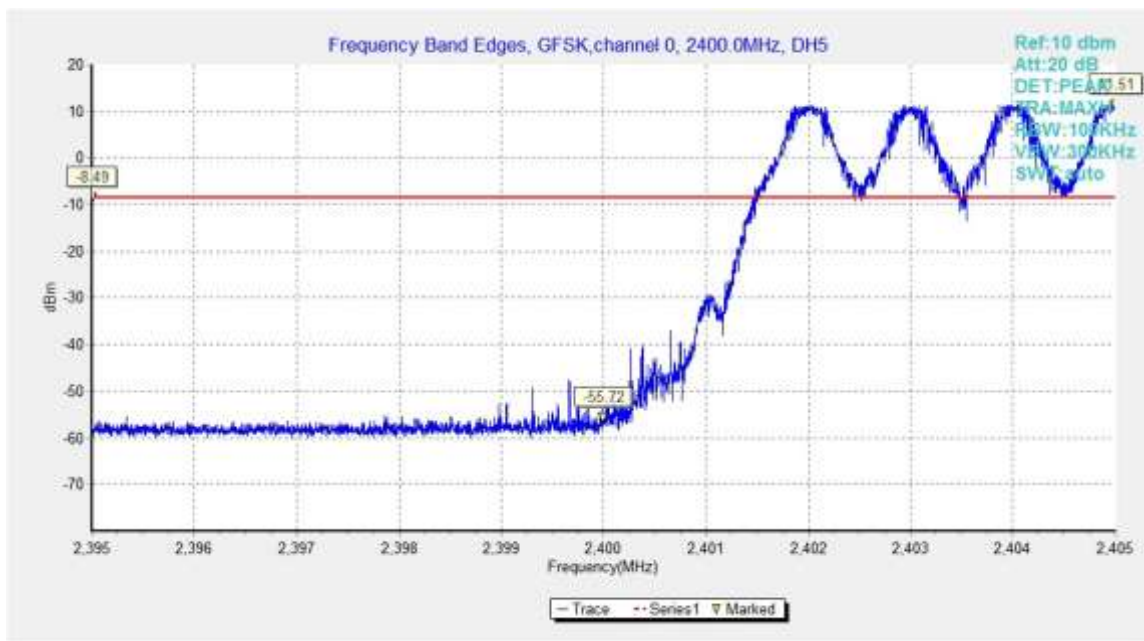

Fig.2. Frequency Band Edges: GFSK, Channel 0, Hopping On

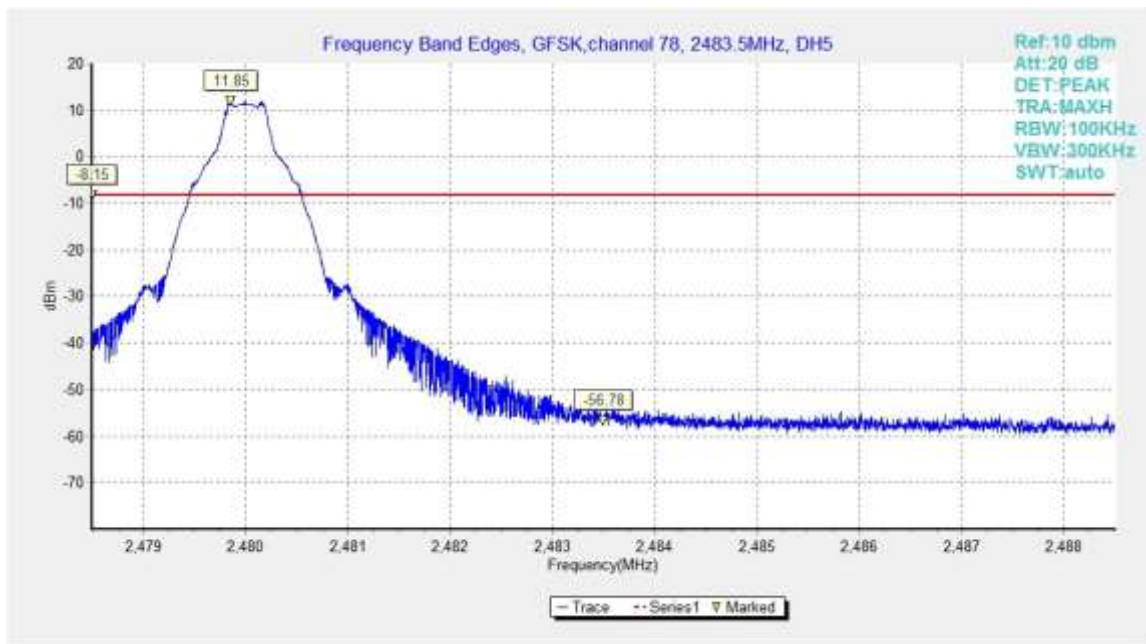

Fig.3. Frequency Band Edges: GFSK, Channel 78, Hopping Off

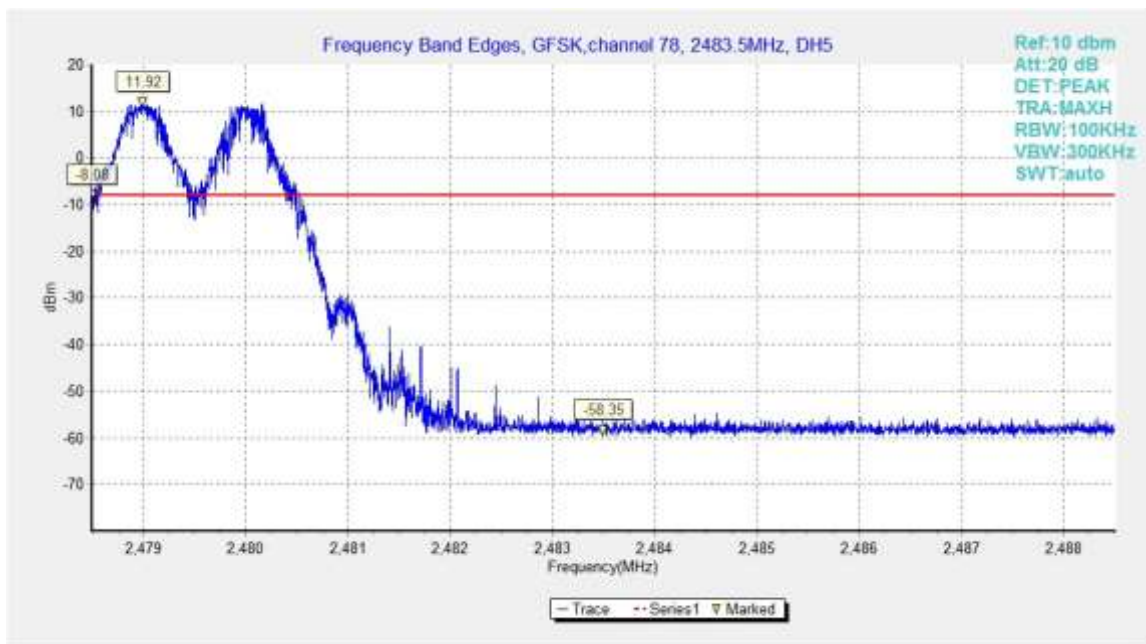

Fig.4. Frequency Band Edges: GFSK, Channel 78, Hopping On

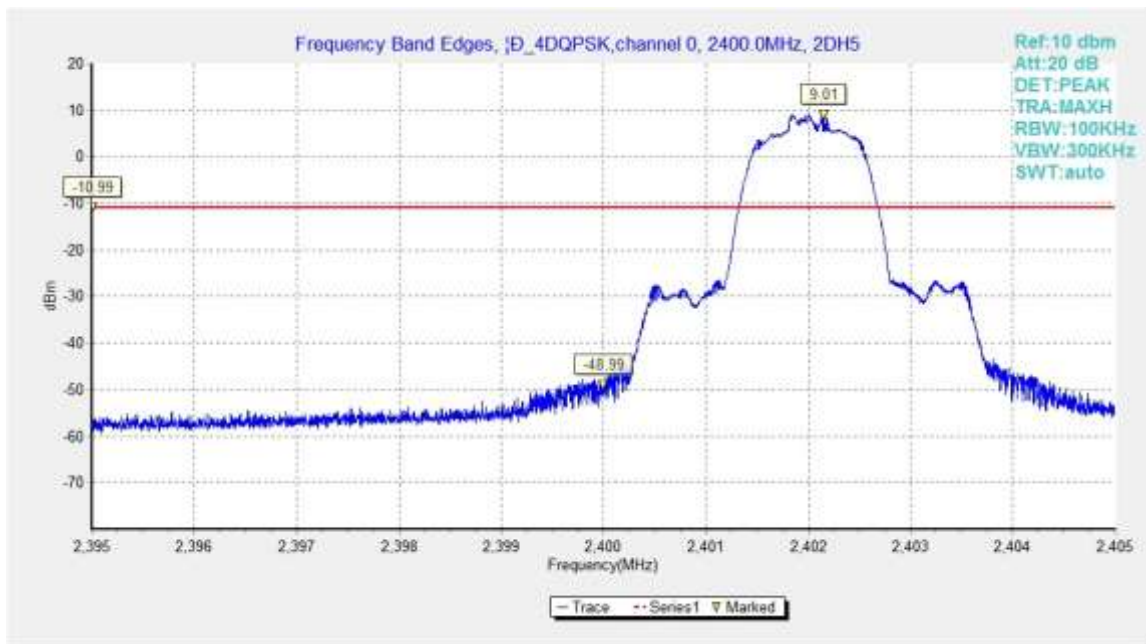

Fig.5. Frequency Band Edges: $\pi/4$ DQPSK, Channel 0, Hopping Off

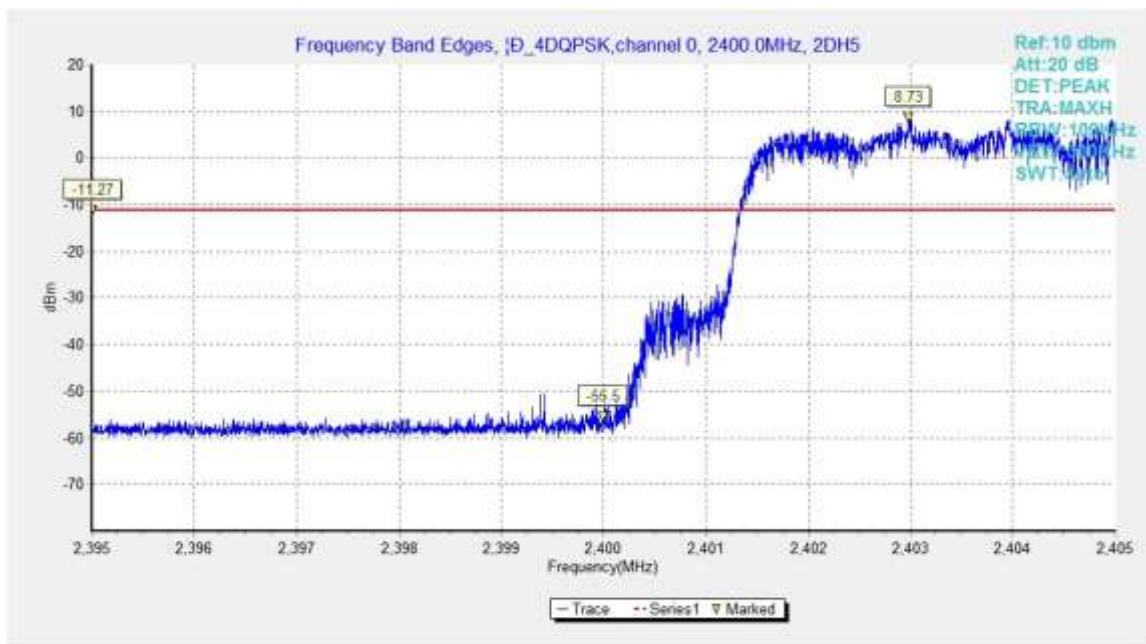

Fig.6. Frequency Band Edges: $\pi/4$ DQPSK, Channel 0, Hopping On

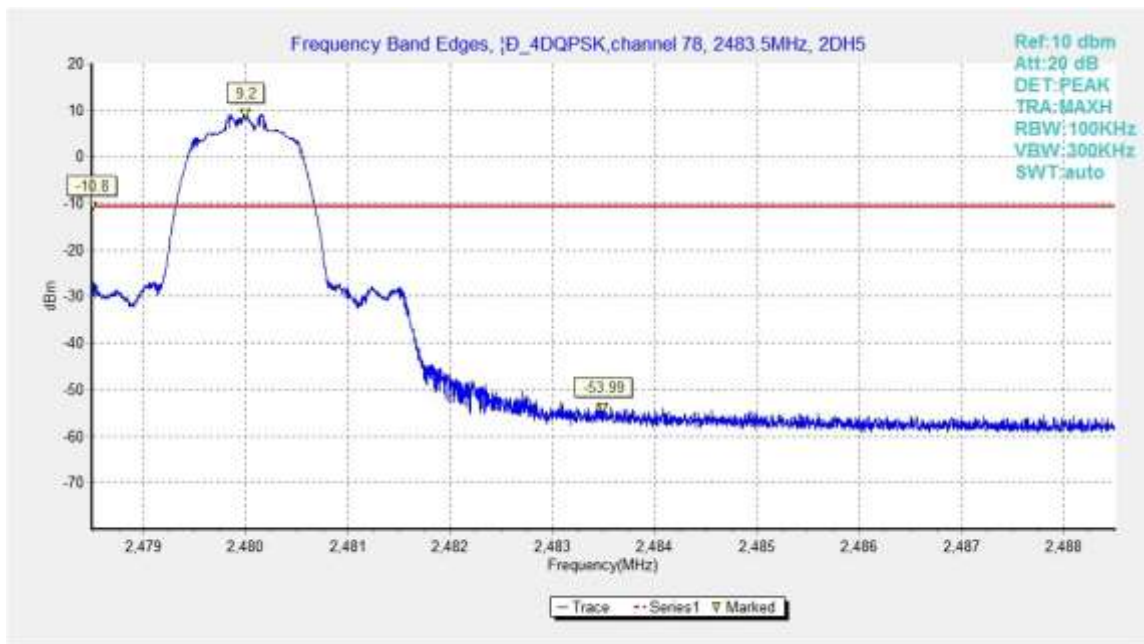

Fig.7. Frequency Band Edges: $\pi/4$ DQPSK, Channel 78, Hopping Off

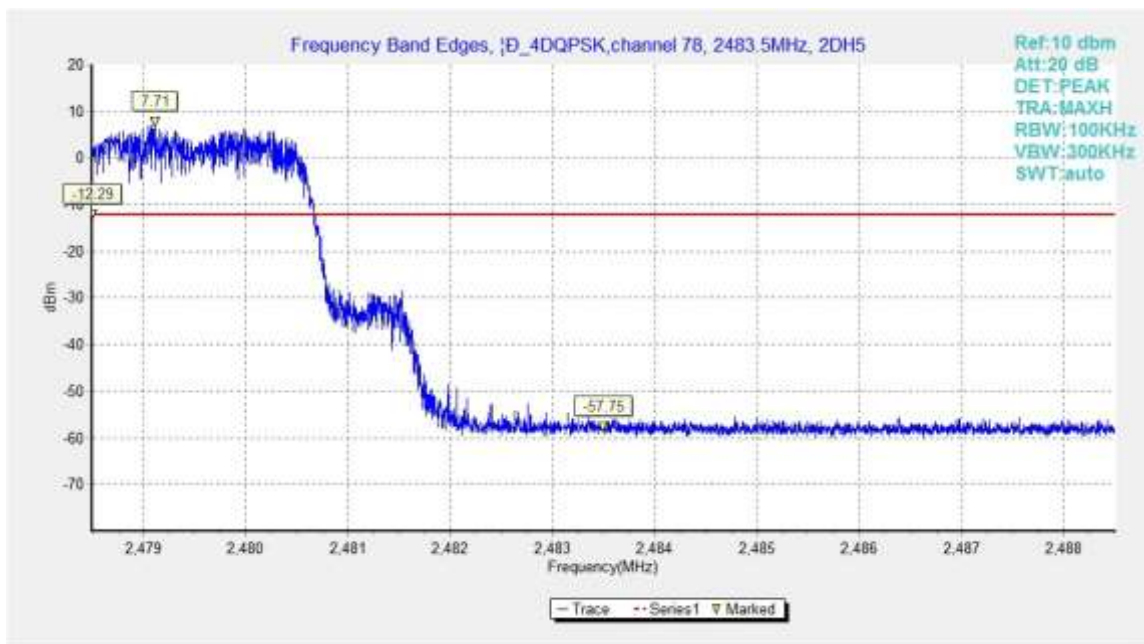

Fig.8. Frequency Band Edges: $\pi/4$ DQPSK, Channel 78, Hopping On

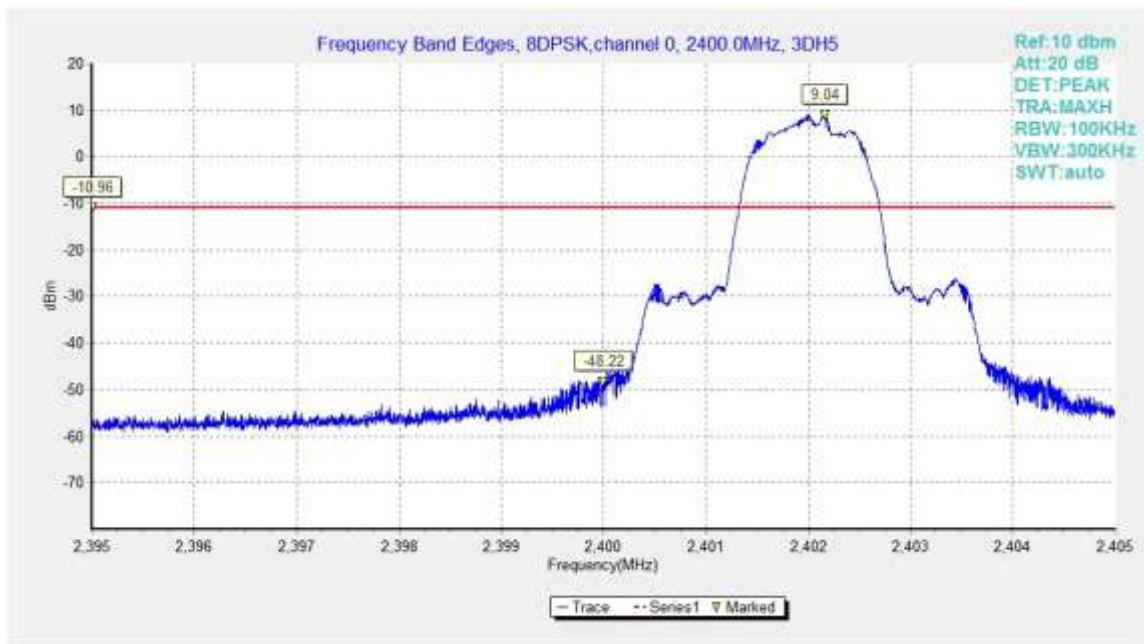

Fig.9. Frequency Band Edges: 8DPSK, Channel 0, Hopping Off

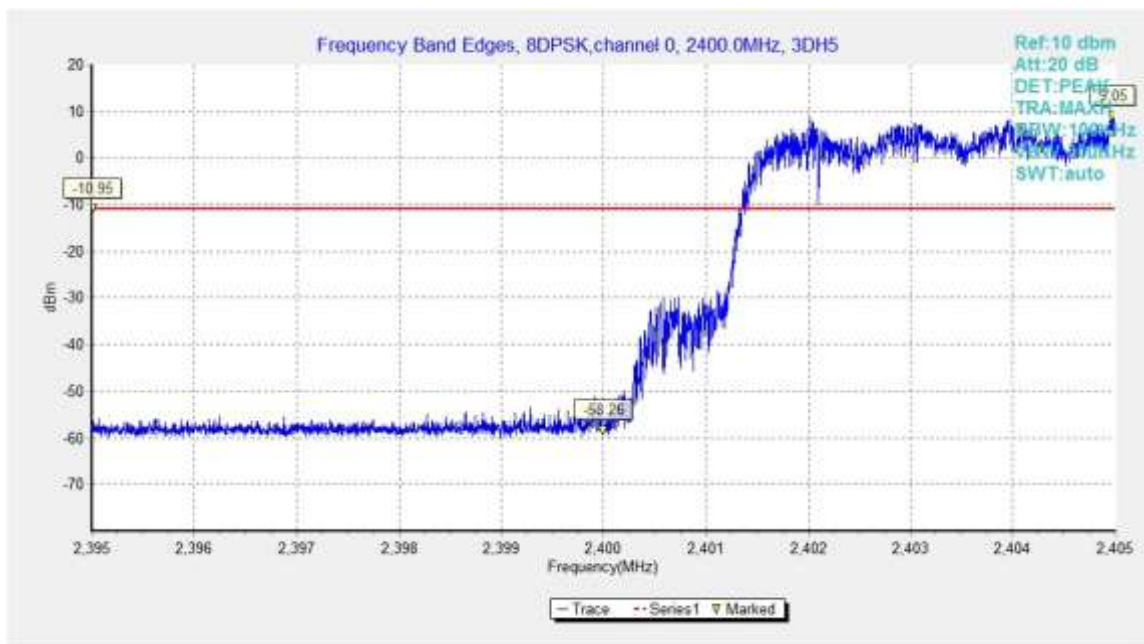

Fig.10. Frequency Band Edges: 8DPSK, Channel 0, Hopping On

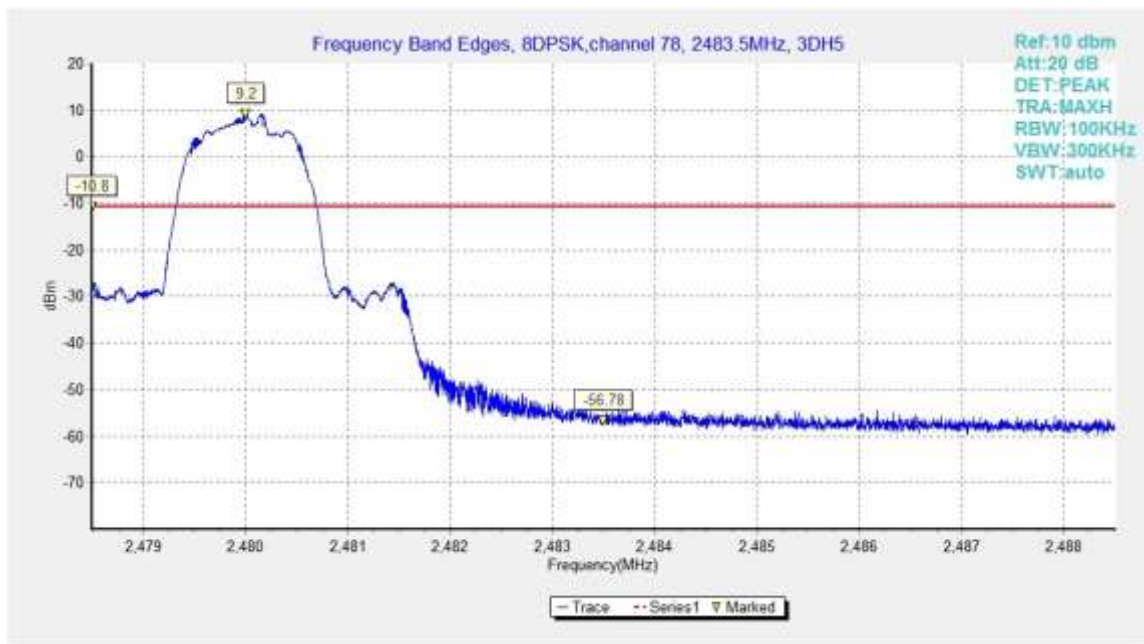

Fig.11. Frequency Band Edges: 8DPSK, Channel 78, Hopping Off

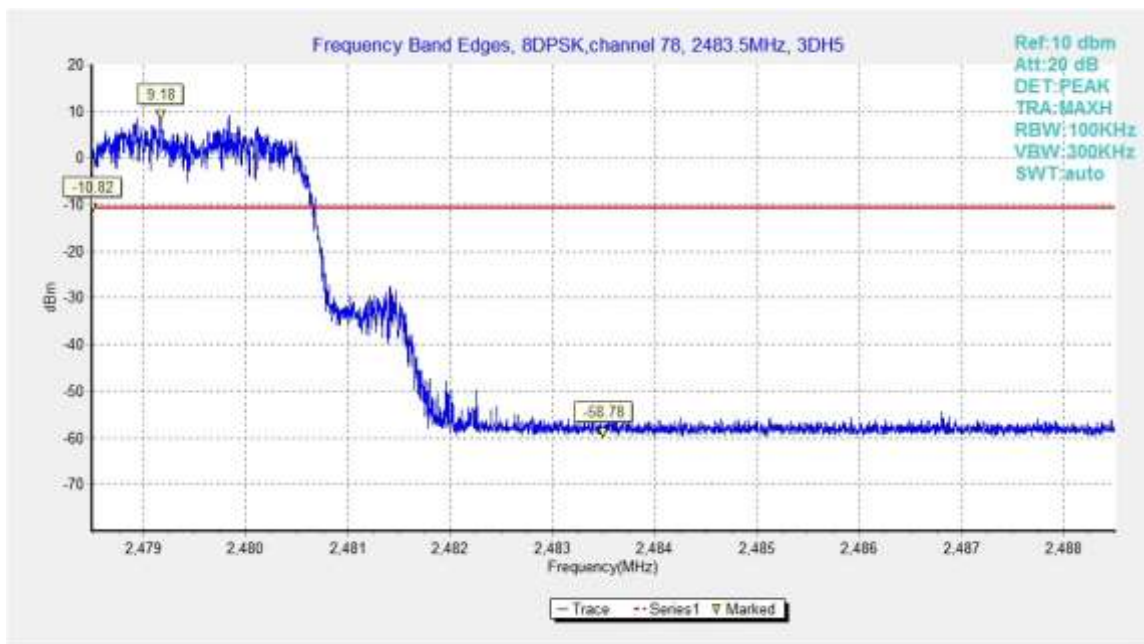

Fig.12. Frequency Band Edges: 8DPSK, Channel 78, Hopping On

B.4. Frequency Band Edges –Radiated

Method of Measurement: See ANSI C63.10-2013-clause 6.4 &6.5 & 6.6

Measurement Limit:

Standard	Limit
FCC 47 CFR Part 15.247, 15.205, 15.209	20dB below peak output power

radiated emissions which fall in the restricted bands, as defined in § 15.205(a), must also comply with the radiated emission limits specified in § 15.209(a) (see § 15.205(c)).

Limit in restricted band:

Frequency (MHz)	Field strength(μ V/m)	Measurement distance (m)
0.009 - 0.490	2400/F(kHz)	300
0.490 - 1.705	24000/F(kHz)	30
1.705 – 30.0	30	30

Frequency of emission (MHz)	Field strength(uV/m)	Field strength(dBuV/m)
30-88	100	40
88-216	150	43.5
216-960	200	46
Above 960	500	54

Set up:

Tabletop devices shall be placed on a nonconducting platform with nominal top surface dimensions 1 m by 1.5 m and the table height shall be 1.5 m.

The EUT and transmitting antenna shall be centered on the turntable.

Test Condition

The EUT shall be tested 1 near top, 1 near middle, and 1 near bottom. Set the unlicensed wireless device to operate in continuous transmit mode. For unlicensed wireless devices unable to be configured for 100% duty cycle even in test mode, configure the system for the maximum duty cycle supported.

When required for unlicensed wireless devices, measurements of the variation of the input power or the radiated signal level of the fundamental frequency component of the emission, as appropriate, shall be performed with the supply voltage varied between 85% and 115% of the nominal rated supply voltage.

Exploratory radiated emissions measurements

Exploratory radiated measurements shall be performed at the measurement distance or at a closer distance than that specified for compliance to determine the emission characteristics of the EUT and, if applicable, the EUT configuration that produces the maximum level of emissions. The frequencies of maximum emission may be determined by manually positioning the antenna close to the EUT, and then moving the antenna over all sides of the EUT while observing a spectral

display. It is advantageous to have prior knowledge of the frequencies of emissions, although this may be determined from such a near-field scan. The near-field scan shall only be used to determine the frequency but not the amplitude of the emissions. Where exploratory measurements are not adequate to determine the worst-case operating modes and are used only to identify the frequencies of the highest emissions, additional preliminary tests can be required.

For emissions from the EUT, the maximum level shall be determined by rotating the EUT and its antenna through 0° to 360° . For each mode of operation required to be tested, the frequency spectrum (based on findings from exploratory measurements) shall be monitored.

Broadband antennas and a spectrum analyzer or a radio-noise meter with a panoramic display are often useful in this type of test. If either antenna height or EUT azimuth are not fully measured during exploratory testing, then complete testing can be required at the OATS or semi-anechoic chamber when the final full spectrum testing is performed.

Final radiated emissions measurements

The final measurements are using the orientation and equipment arrangement of the EUT based on the measurement results found during the preliminary (exploratory) measurements, the EUT arrangement, appropriate modulation, and modes of operation that produce the emissions that have the highest amplitude relative to the limit shall be selected for the final measurement.

For emissions from the EUT, the maximum level shall be determined by rotating the EUT and its antenna through 0° to 360° . Final measurements for the EUT require a measurement antenna height scan of 1 m to 4 m and the antenna rotated to repeat the measurements for both the horizontal and vertical antenna polarizations. For each mode of operation required to be tested, the frequency spectrum (based on findings from exploratory measurements) shall be monitored.

For each mode selected, record the frequency and amplitude of the highest fundamental emission (if applicable), as well as the frequency and amplitude of the six highest spurious emissions relative to the limit. Emissions more than 20 dB below the limit do not need to be reported.

This maximization process was repeated with the EUT positioned in each of its three orthogonal orientations.

The receiver references:

Frequency of emission (MHz)	RBW/VBW	Sweep Time(s)
30-1000	100KHz/300KHz	5
1000-4000	1MHz/3MHz	15
4000-18000	1MHz/3MHz	40
18000-26500	1MHz/3MHz	20

EUT ID: EUT3 + AE2-1

Measurement Results:

Mode	Channel	Frequency Range	Test Results	Conclusion
GFSK	0	2.38GHz ~2.45GHz	Fig.13	P
	78	2.45GHz ~2.5GHz	Fig.14	P

Mode	Channel	Frequency Range	Test Results	Conclusion
$\pi/4$ DQPSK	0	2.38GHz ~2.43GHz	Fig.15	P
	78	2.45GHz ~2.5GHz	Fig.16	P

Mode	Channel	Frequency Range	Test Results	Conclusion
8DPSK	0	2.38GHz ~2.45GHz	Fig.17	P
	78	2.45GHz ~2.5GHz	Fig.18	P

Conclusion: PASS

Test graphs as below

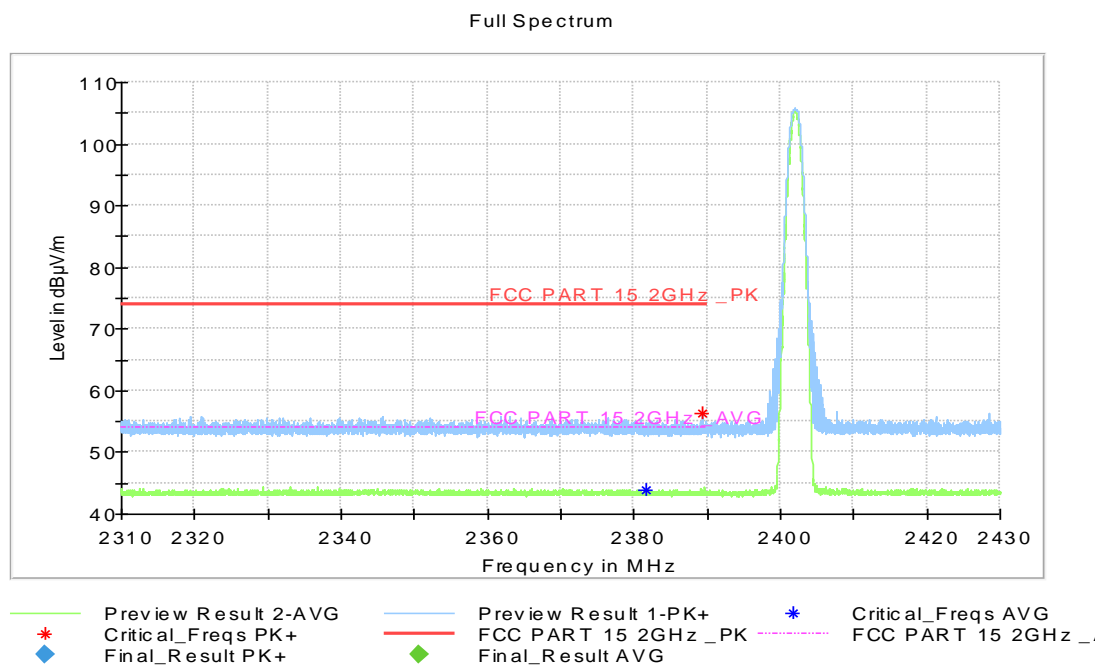

Fig.13. Frequency Band Edges: GFSK, Channel 0, Hopping Off, 2.38 GHz – 2.45GHz

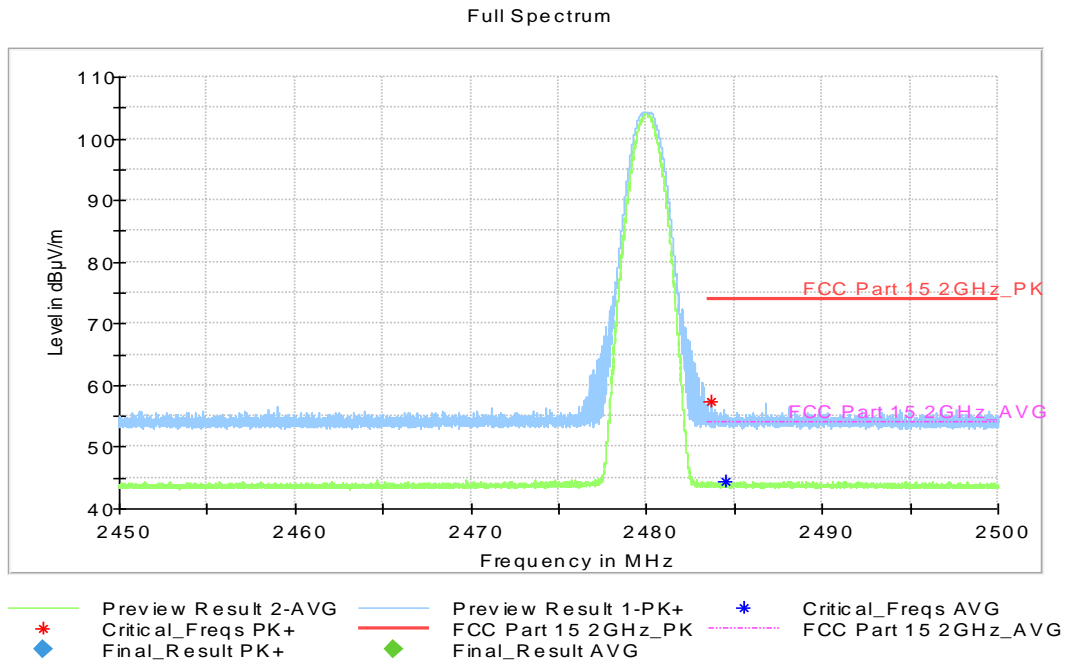

Fig.14. Frequency Band Edges: GFSK, Channel 78, Hopping Off, ch11, 2.45 GHz - 2.50GHz

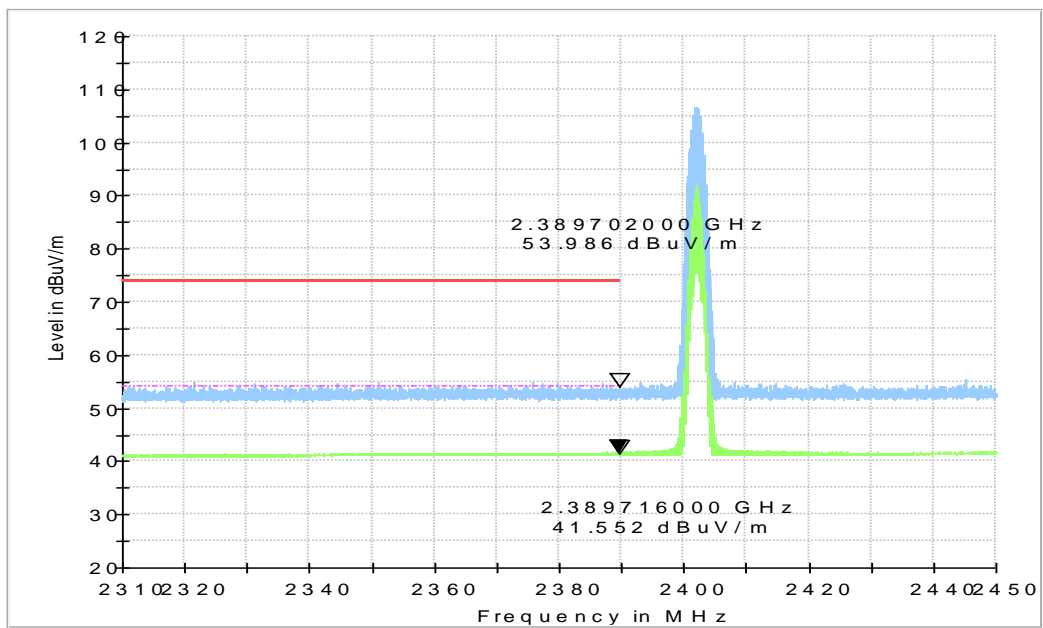

Fig.15. Frequency Band Edges: $\pi/4$ DQPSK, Channel 0, Hopping Off, 2.38 GHz - 2.45GHz

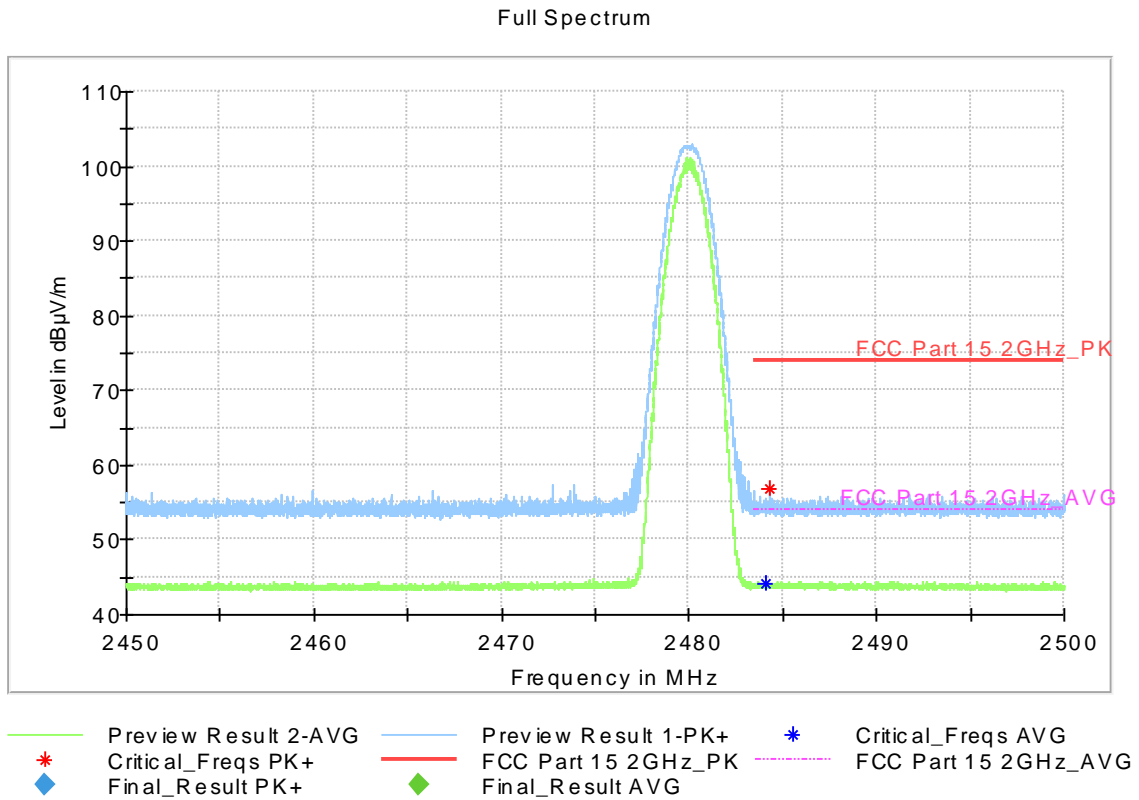

Fig.16. Frequency Band Edges: $\pi/4$ DQPSK, Channel 78, Hopping Off, 2.38 GHz - 2.45GHz

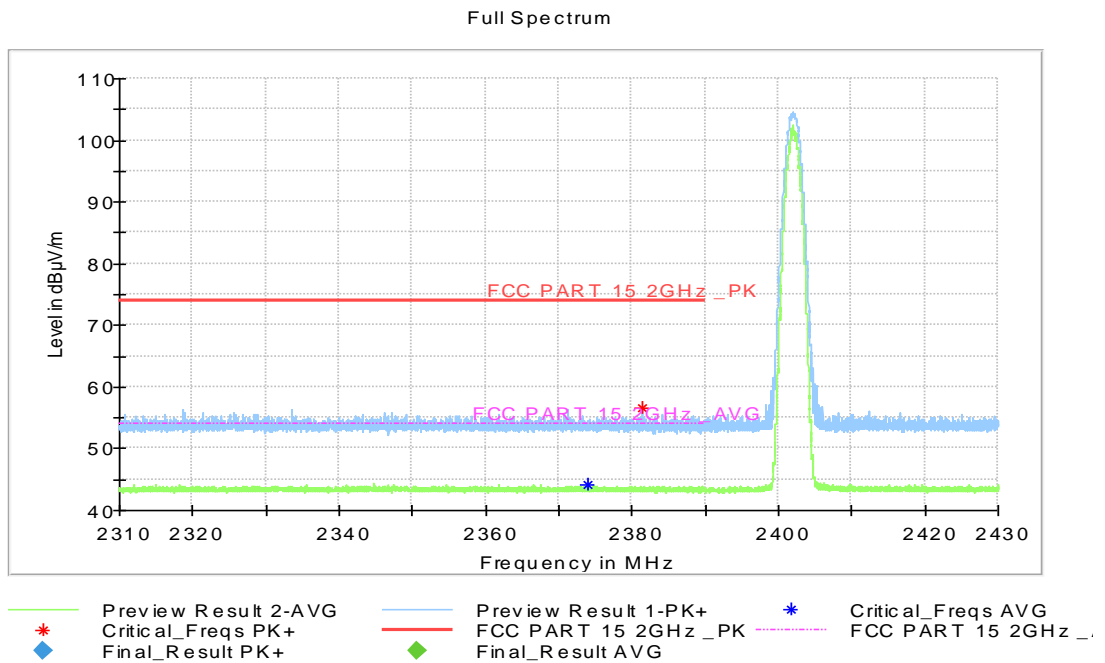

Fig.17. Frequency Band Edges: 8DPSK, Channel 0, 2.38 GHz - 2.45GHz

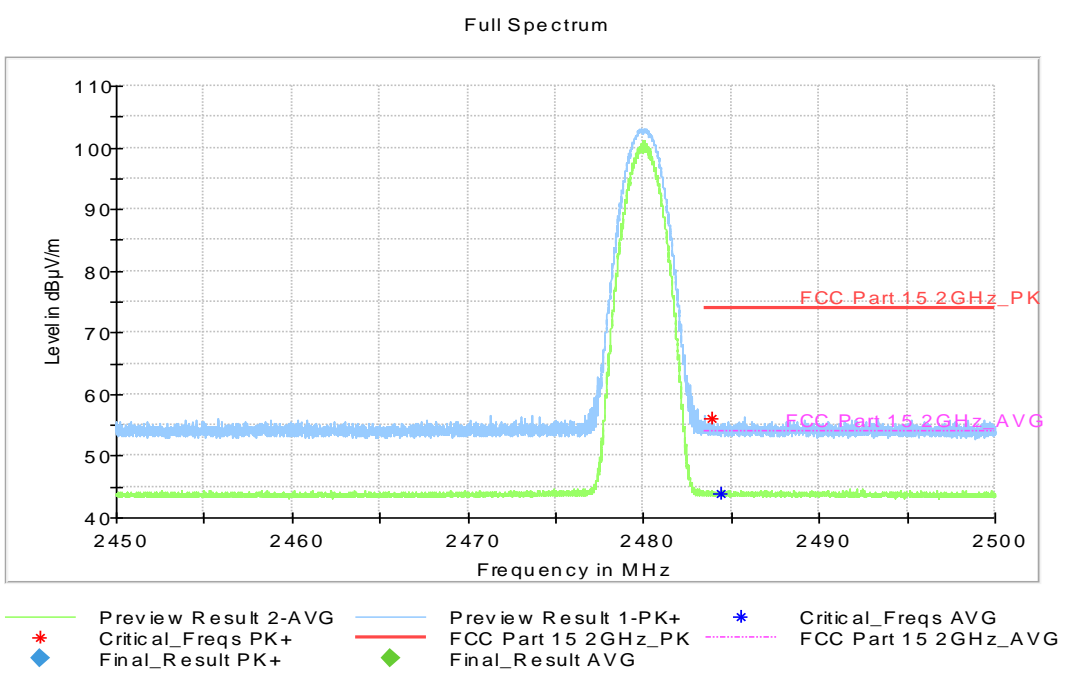

Fig.18. Frequency Band Edges: 8DPSK, Channel 78, 2.38 GHz - 2.45GHz

EUT ID: EUT4 + AE2-2

Measurement Results:

Mode	Channel	Frequency Range	Test Results	Conclusion
8DPSK	0	2.38GHz ~2.45GHz	Fig.19	P
	78	2.45GHz ~2.5GHz	Fig.20	P

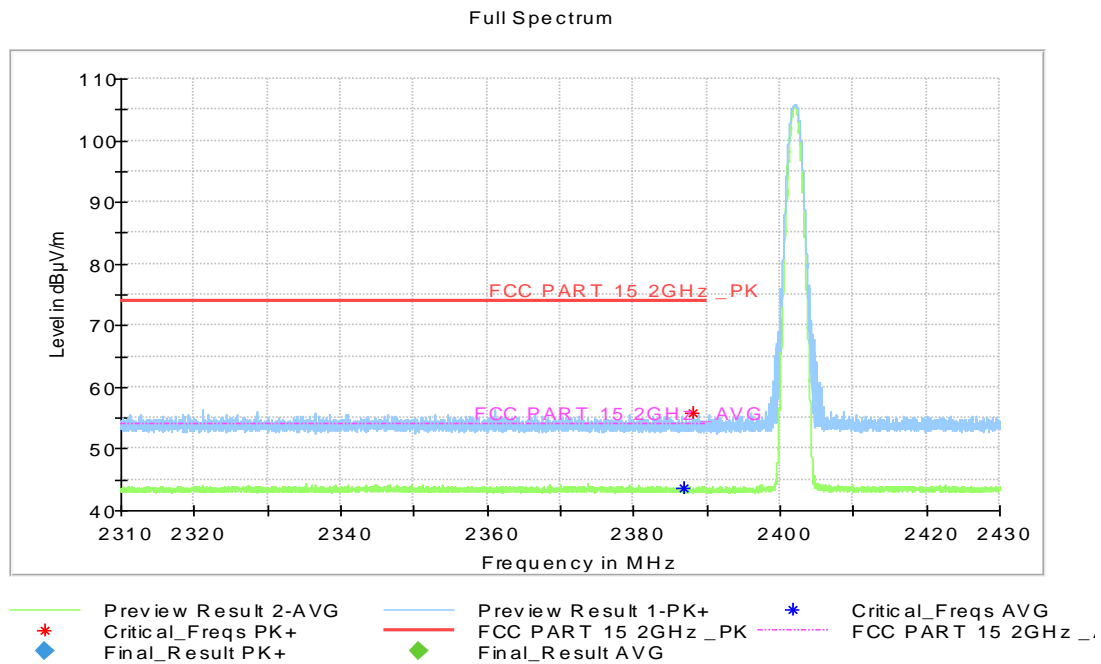

Fig.19. Frequency Band Edges: 8DPSK, Channel 0, 2.38 GHz - 2.45GHz

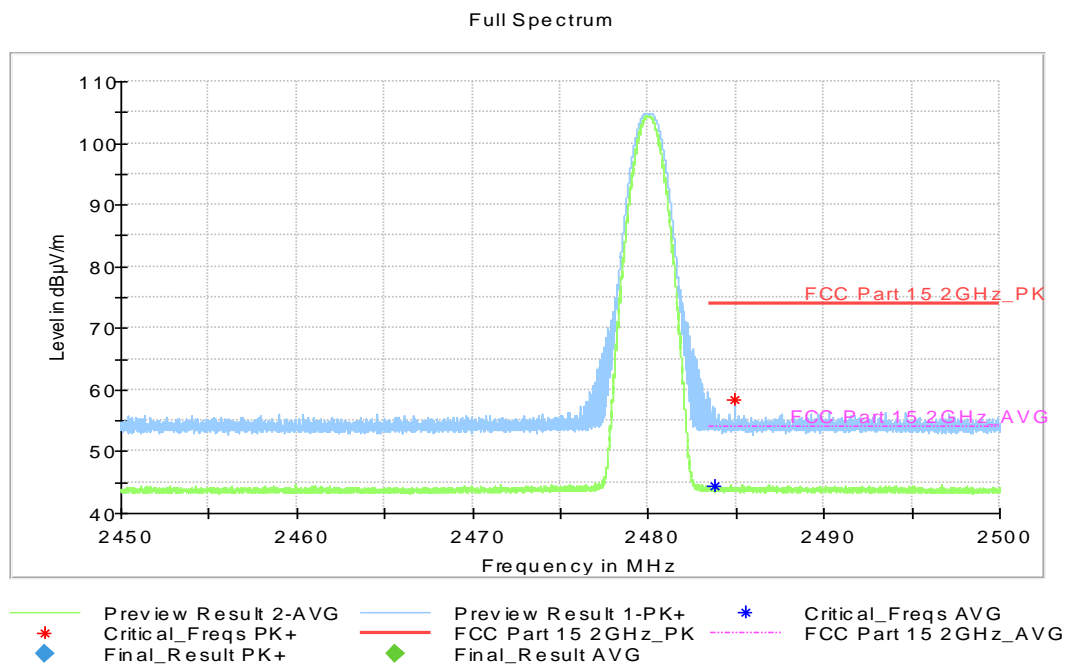

Fig.20. Frequency Band Edges: 8DPSK, Channel 78, 2.38 GHz - 2.45GHz

EUT ID: EUT5 + AE2-3

Measurement Results:

Mode	Channel	Frequency Range	Test Results	Conclusion
8DPSK	0	2.38GHz ~2.45GHz	Fig.21	P
	78	2.45GHz ~2.5GHz	Fig.22	P

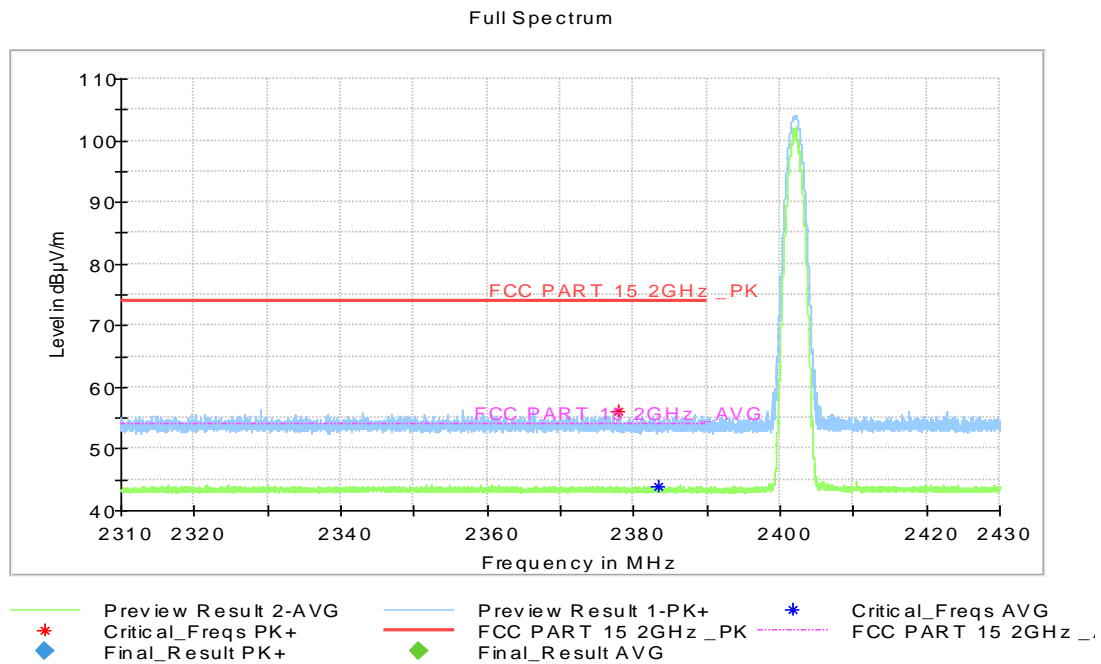

Fig.21. Frequency Band Edges: 8DPSK, Channel 0, 2.38 GHz - 2.45GHz

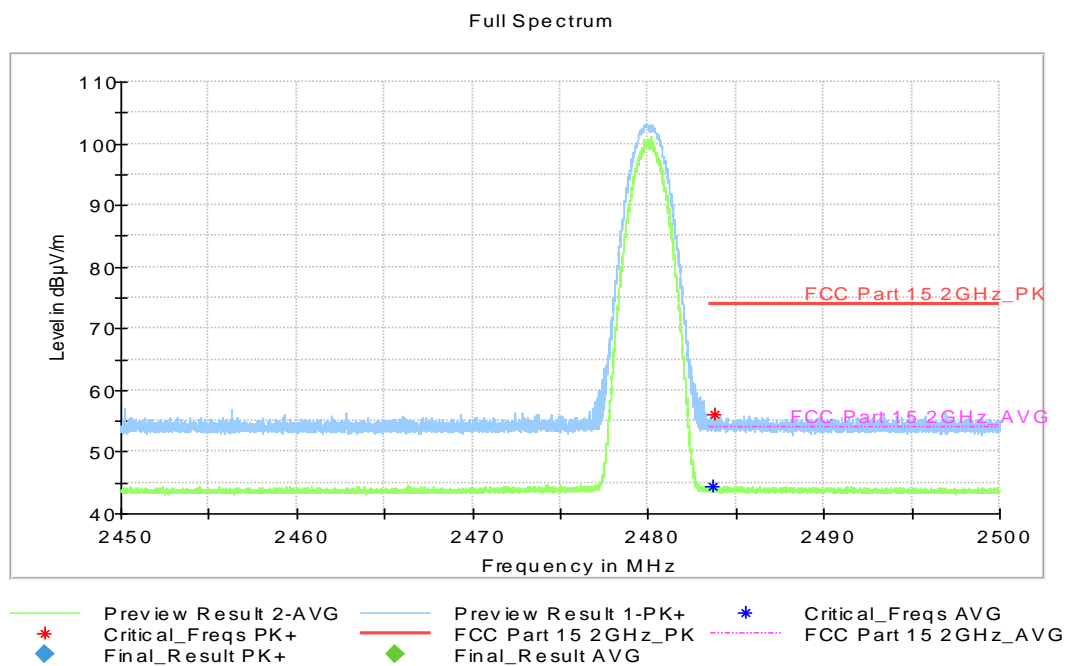

Fig.22. Frequency Band Edges: 8DPSK, Channel 78, 2.38 GHz - 2.45GHz

EUT ID: EUT3 + AE2-4

Measurement Results:

Mode	Channel	Frequency Range	Test Results	Conclusion
8DPSK	0	2.38GHz ~2.45GHz	Fig.23	P
	78	2.45GHz ~2.5GHz	Fig.24	P

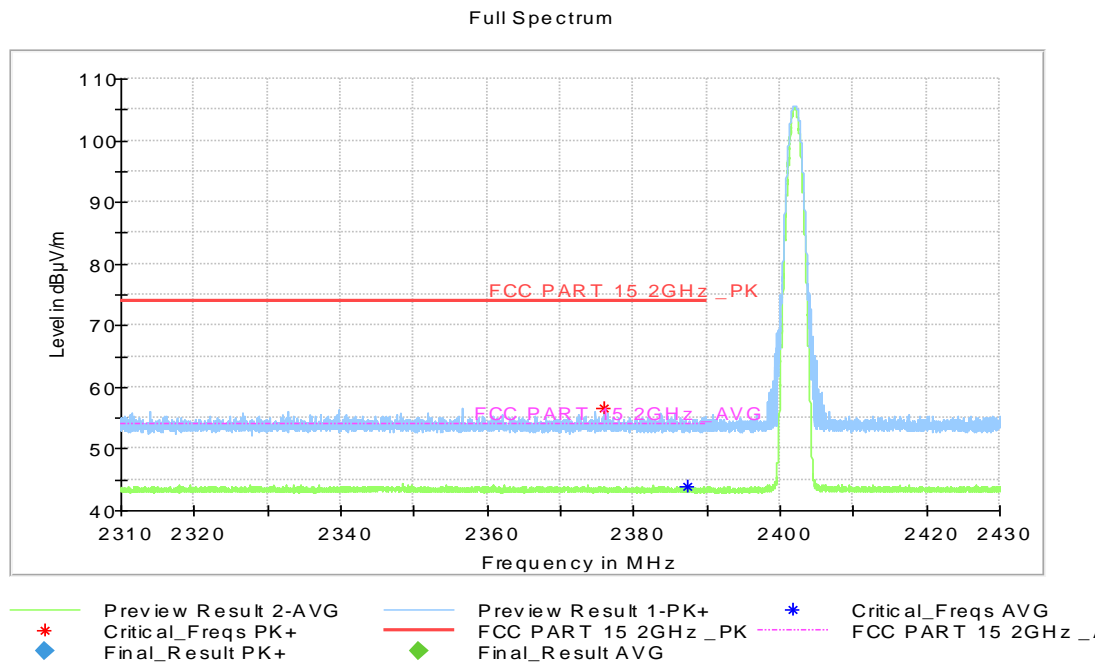

Fig.23. Frequency Band Edges: 8DPSK, Channel 0, 2.38 GHz - 2.45GHz

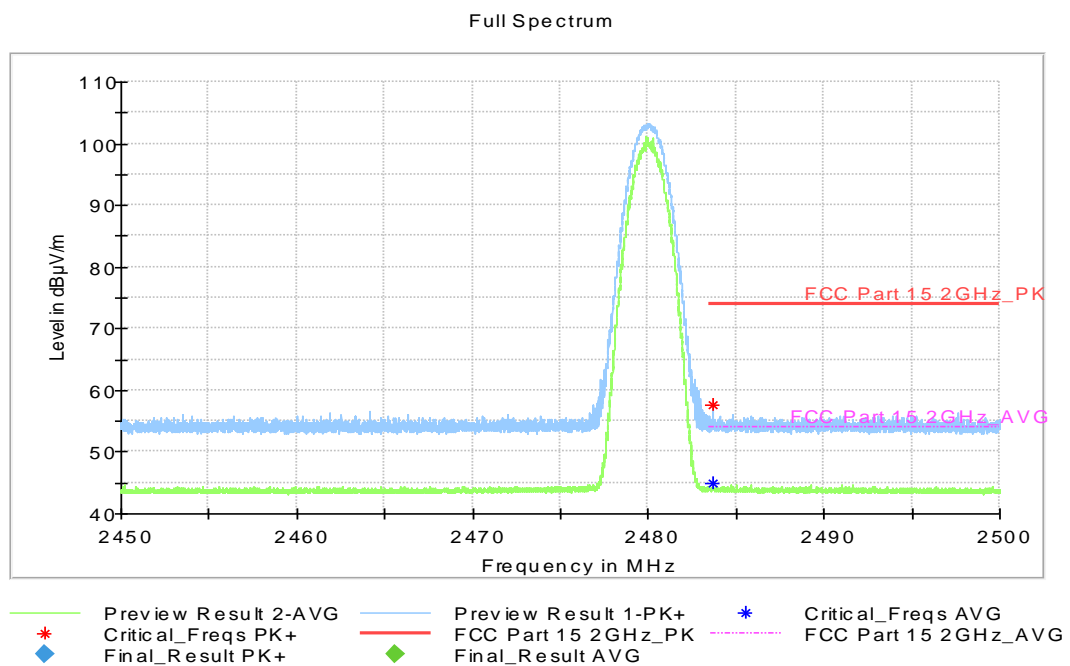

Fig.24. Frequency Band Edges: 8DPSK, Channel 78, 2.38 GHz - 2.45GHz

EUT ID: EUT4 + AE2-5

Measurement Results:

Mode	Channel	Frequency Range	Test Results	Conclusion
8DPSK	0	2.38GHz ~2.45GHz	Fig.25	P
	78	2.45GHz ~2.5GHz	Fig.26	P

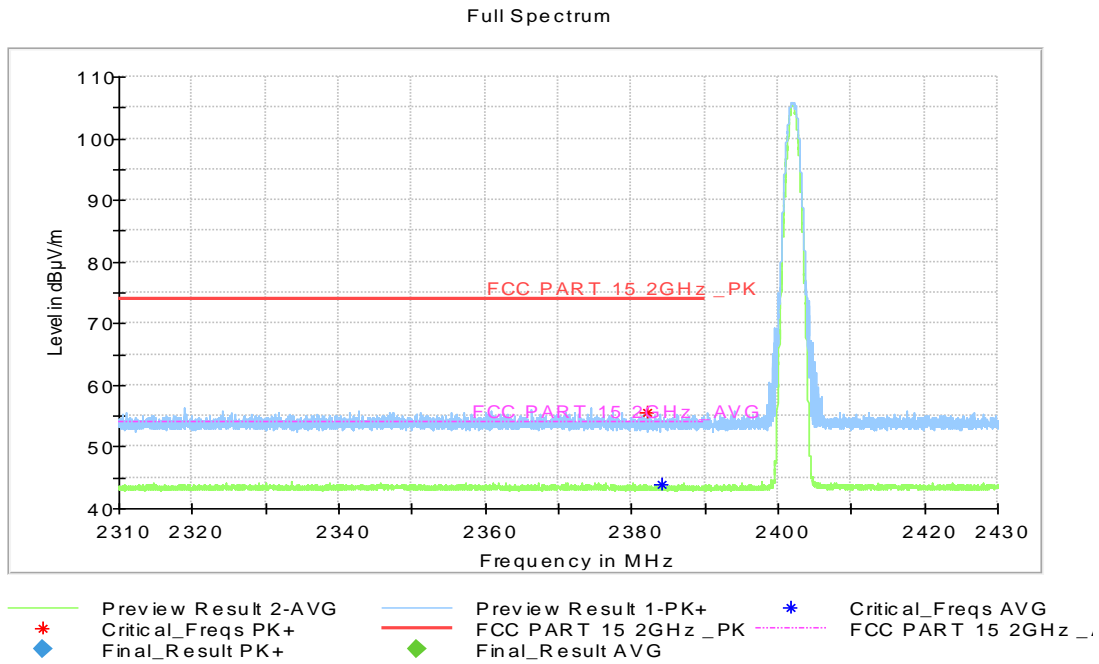

Fig.25. Frequency Band Edges: 8DPSK, Channel 0, 2.38 GHz - 2.45GHz

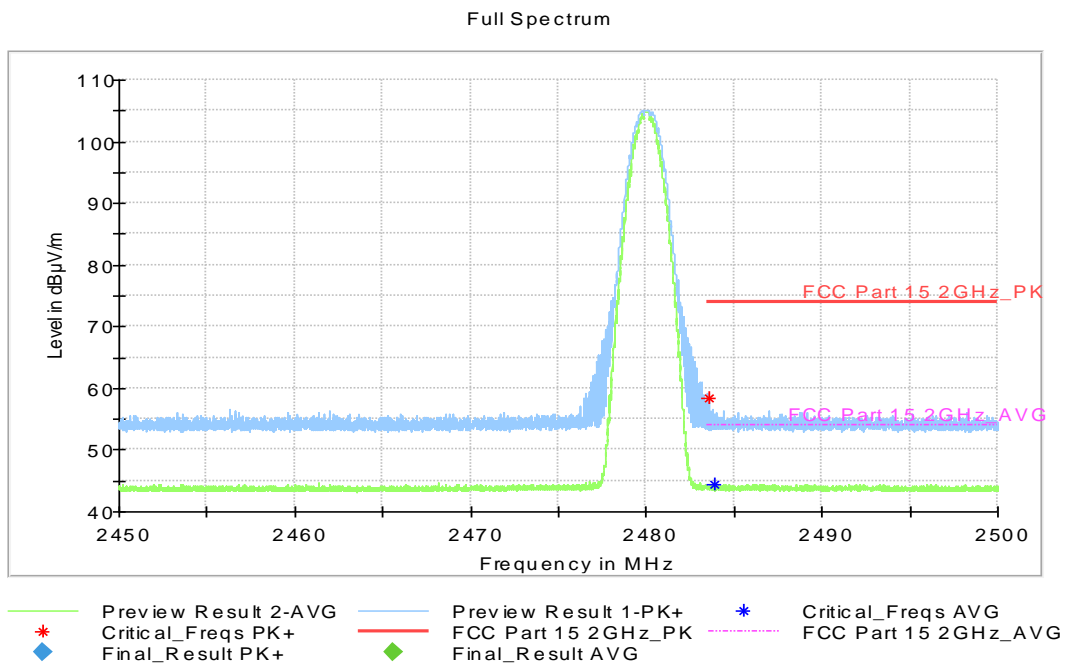

Fig.26. Frequency Band Edges: 8DPSK, Channel 78, 2.38 GHz - 2.45GHz

B.5. Transmitter Spurious Emission - Conducted

Method of Measurement: See ANSI C63.10-clause 7.8.8

Measurement Procedure – Reference Level

1. Set the RBW = 100 kHz.
2. Set the VBW = 300 kHz.
3. Set the span to 5-30 % greater than the EBW.
4. Detector = peak.
5. Sweep time = auto couple.
6. Trace mode = max hold.
7. Allow trace to fully stabilize.
8. Use the peak marker function to determine the maximum power level in any 100 kHz band segment within the fundamental EBW. Next, determine the power in 100 kHz band segments outside of the authorized frequency band using the following measurement:

Measurement Procedure - Unwanted Emissions

1. Set RBW = 100 kHz.
2. Set VBW = 300 kHz.
3. Set span to encompass the spectrum to be examined.
4. Detector = peak.
5. Trace Mode = max hold.
6. Sweep = auto couple.
7. Allow the trace to stabilize (this may take some time, depending on the extent of the span).

Ensure that the amplitude of all unwanted emissions outside of the authorized frequency band (excluding restricted frequency bands) is attenuated by at least the minimum requirements specified above.

Measurement Limit:

Standard	Limit
FCC 47 CFR Part 15.247 (d)	20dB below peak output power in 100 kHz bandwidth

Measurement Results:

For GFSK

Channel	Frequency Range	Test Results	Conclusion
Ch 0	Center Frequency	Fig.27	P

2402 MHz	30 MHz ~ 1 GHz	Fig.28	P
	1 GHz ~ 3 GHz	Fig.29	P
	3 GHz ~ 10 GHz	Fig.30	P
	10 GHz ~ 26 GHz	Fig.31	P
Ch 39 2441 MHz	Center Frequency	Fig.32	P
	30 MHz ~ 1 GHz	Fig.33	P
	1 GHz ~ 3 GHz	Fig.34	P
	3 GHz ~ 10 GHz	Fig.35	P
	10 GHz ~ 26 GHz	Fig.36	P
Ch 78 2480 MHz	Center Frequency	Fig.37	P
	30 MHz ~ 1 GHz	Fig.38	P
	1 GHz ~ 3 GHz	Fig.39	P
	3 GHz ~ 10 GHz	Fig.40	P
	10 GHz ~ 26 GHz	Fig.41	P

For $\pi/4$ DQPSK

Channel	Frequency Range	Test Results	Conclusion
Ch 0 2402 MHz	Center Frequency	Fig.42	P
	30 MHz ~ 1 GHz	Fig.43	P
	1 GHz ~ 3 GHz	Fig.44	P
	3 GHz ~ 10 GHz	Fig.45	P
	10 GHz ~ 26 GHz	Fig.46	P
Ch 39 2441 MHz	Center Frequency	Fig.47	P
	30 MHz ~ 1 GHz	Fig.48	P
	1 GHz ~ 3 GHz	Fig.49	P
	3 GHz ~ 10 GHz	Fig.50	P
	10 GHz ~ 26 GHz	Fig.51	P
Ch 78 2480 MHz	Center Frequency	Fig.52	P
	30 MHz ~ 1 GHz	Fig.53	P
	1 GHz ~ 3 GHz	Fig.54	P
	3 GHz ~ 10 GHz	Fig.55	P
	10 GHz ~ 26 GHz	Fig.56	P

For 8DPSK

Channel	Frequency Range	Test Results	Conclusion
Ch 0 2402 MHz	Center Frequency	Fig.57	P
	30 MHz ~ 1 GHz	Fig.58	P
	1 GHz ~ 3 GHz	Fig.59	P
	3 GHz ~ 10 GHz	Fig.60	P
	10 GHz ~ 26 GHz	Fig.61	P

Ch 39 2441 MHz	Center Frequency	Fig.62	P
	30 MHz ~ 1 GHz	Fig.63	P
	1 GHz ~ 3 GHz	Fig.64	P
	3 GHz ~ 10 GHz	Fig.65	P
	10 GHz ~ 26 GHz	Fig.66	P
Ch 78 2480 MHz	Center Frequency	Fig.67	P
	30 MHz ~ 1 GHz	Fig.68	P
	1 GHz ~ 3 GHz	Fig.69	P
	3 GHz ~ 10 GHz	Fig.70	P
	10 GHz ~ 26 GHz	Fig.71	P

Conclusion: PASS

Test graphs as below

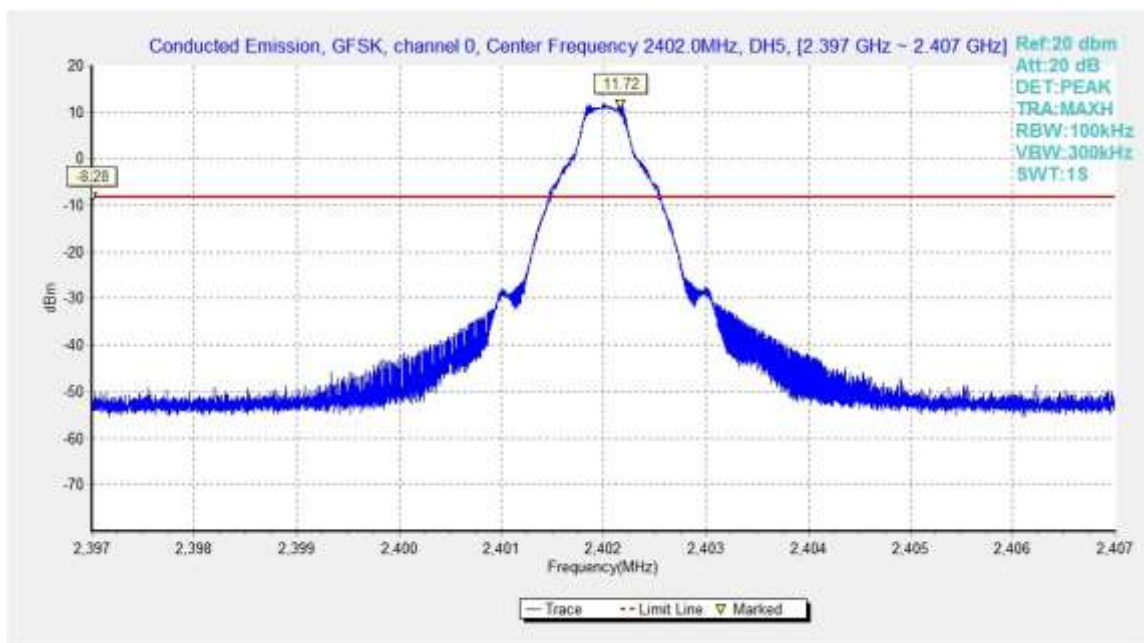

Fig.27. Conducted spurious emission: GFSK, Channel 0, 2402MHz

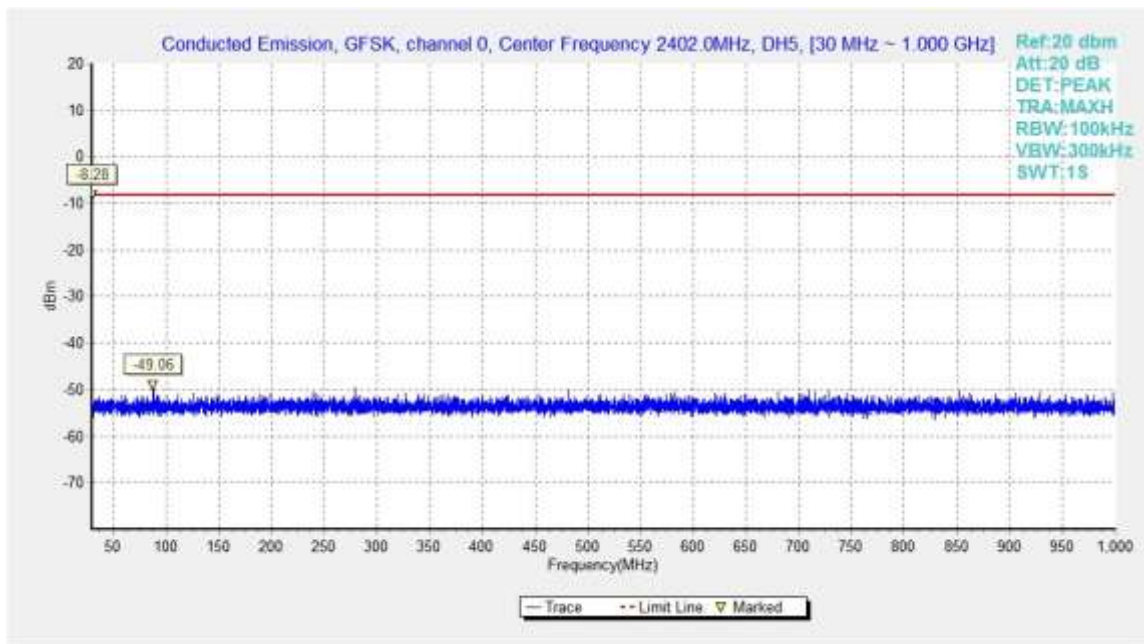

Fig.28. Conducted spurious emission: GFSK, Channel 0, 30MHz - 1GHz

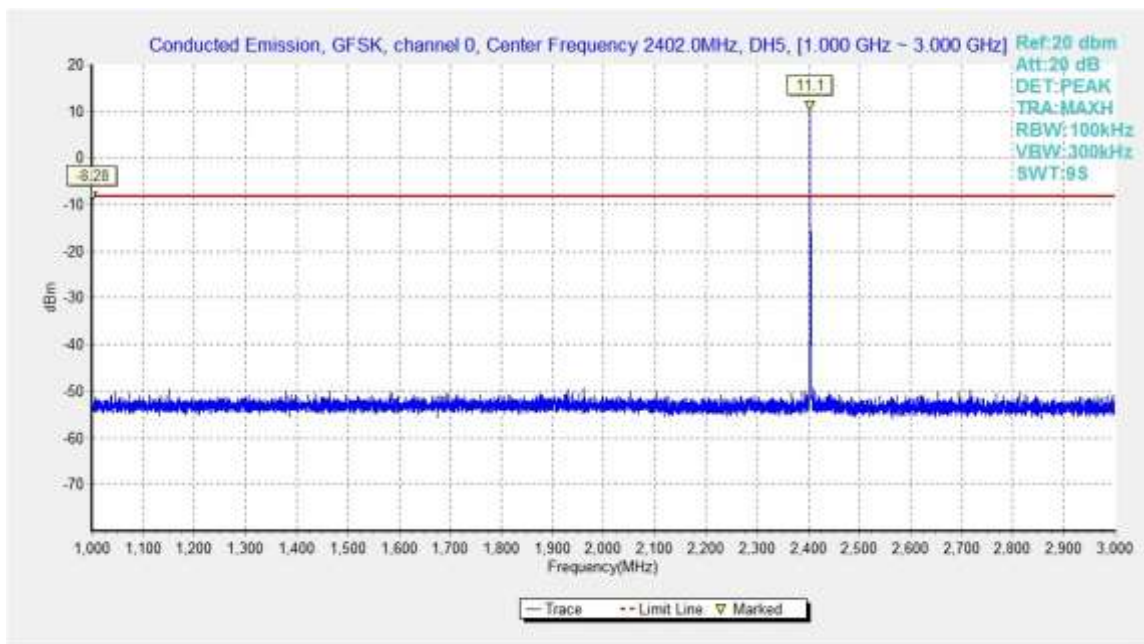

Fig.29. Conducted spurious emission: GFSK, Channel 0, 1GHz - 3GHz

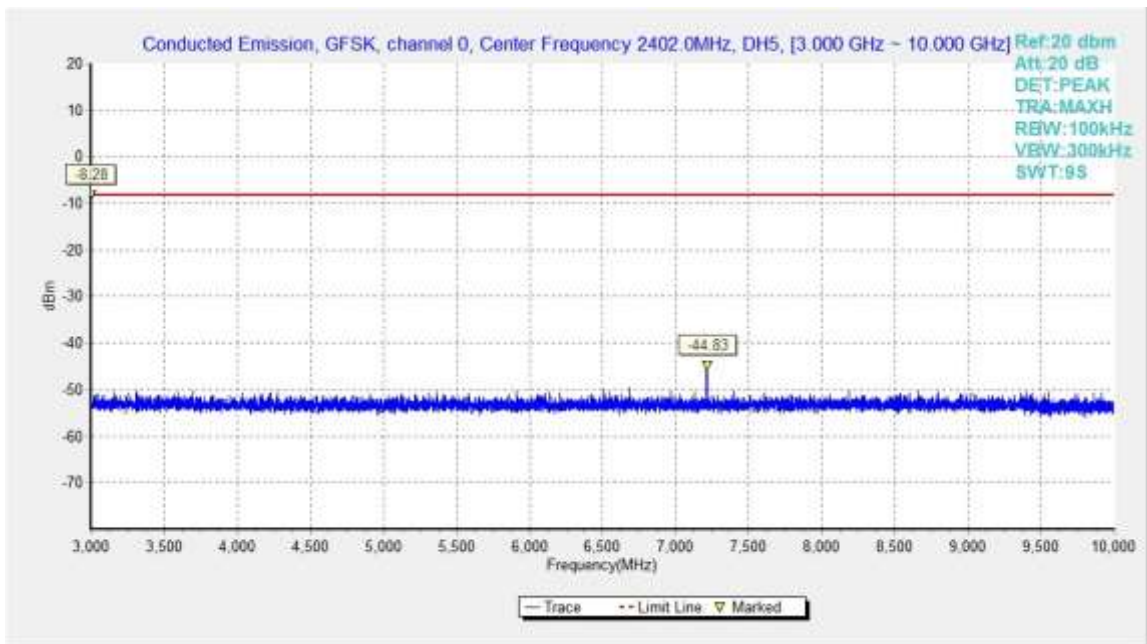

Fig.30. Conducted spurious emission: GFSK, Channel 0, 3GHz - 10GHz

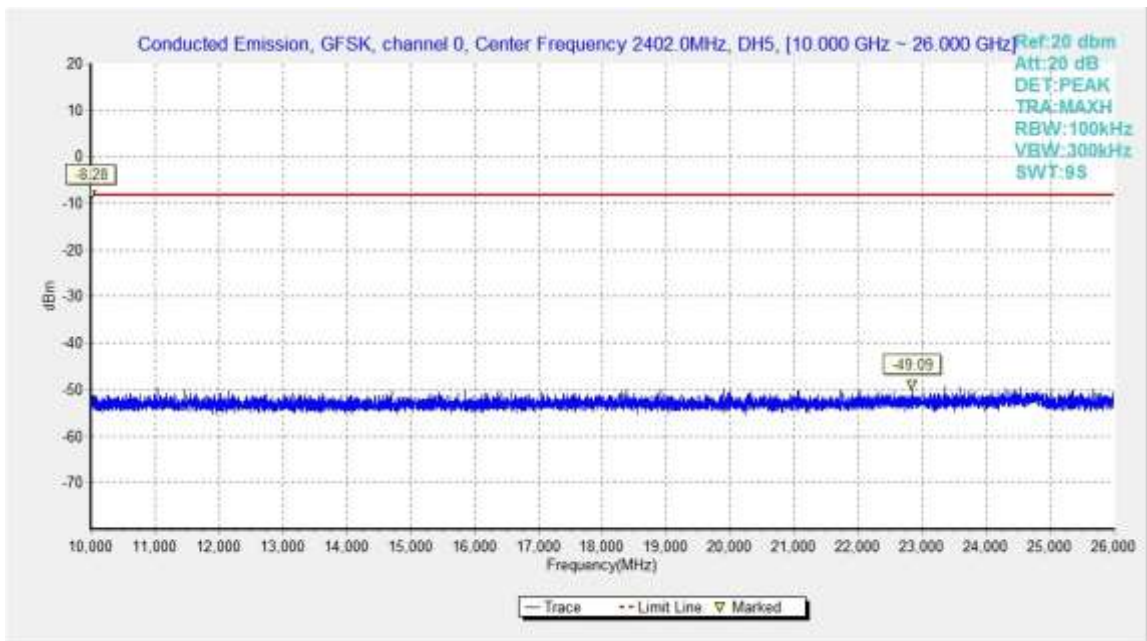

Fig.31. Conducted spurious emission: GFSK, Channel 0, 10GHz - 26GHz

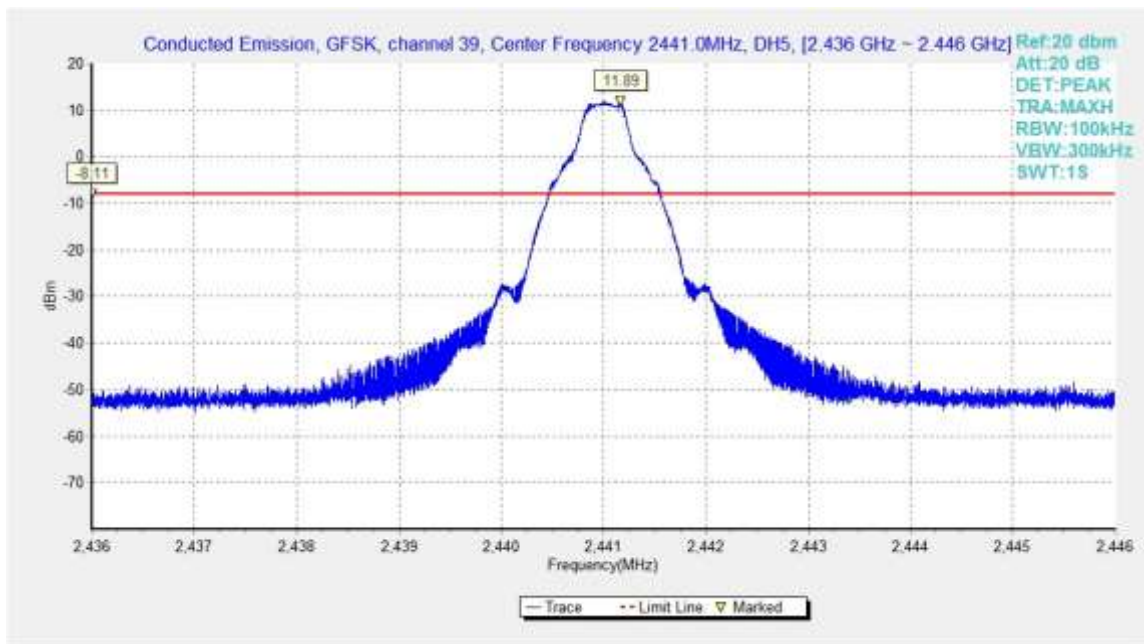

Fig.32. Conducted spurious emission: GFSK, Channel 39, 2441MHz

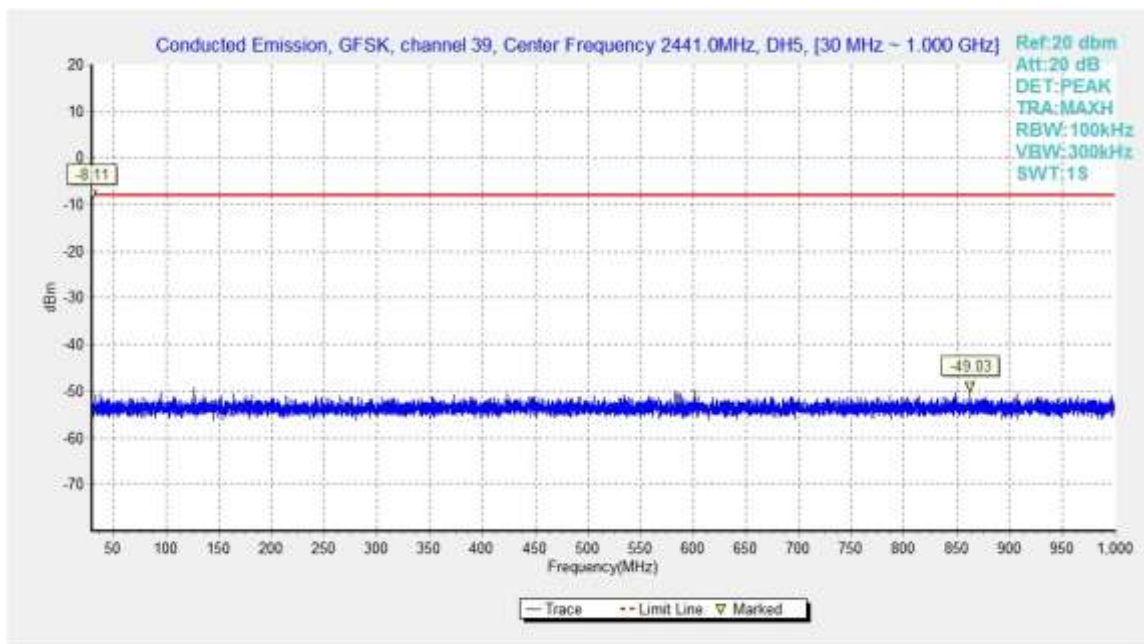

Fig.33. Conducted spurious emission: GFSK, Channel 39, 30MHz - 1GHz

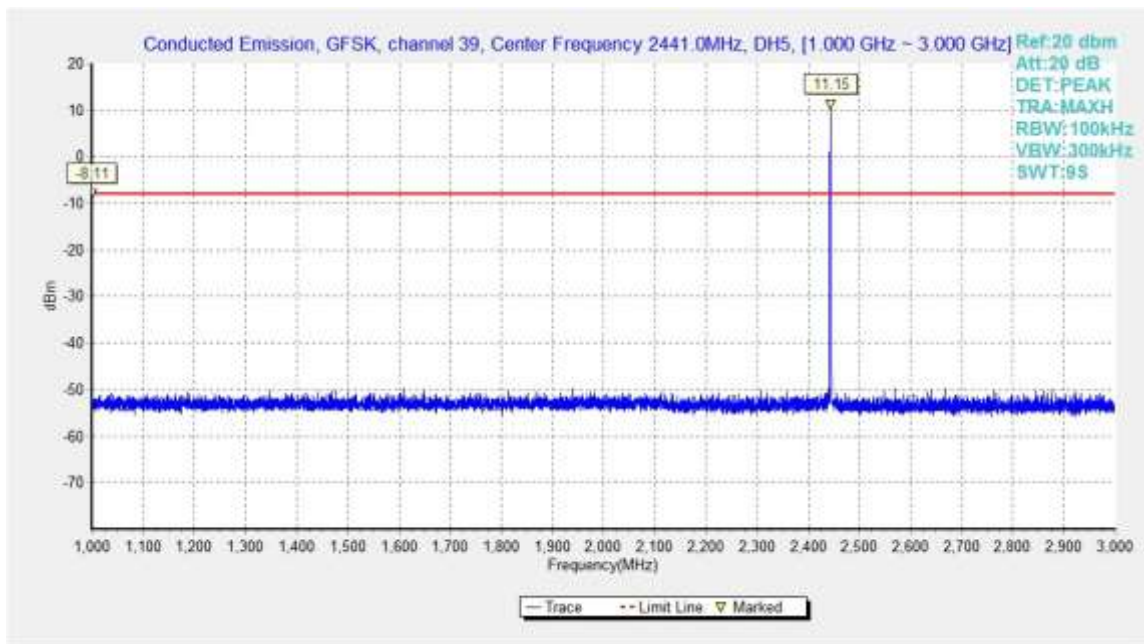

Fig.34. Conducted spurious emission: GFSK, Channel 39, 1GHz – 3GHz

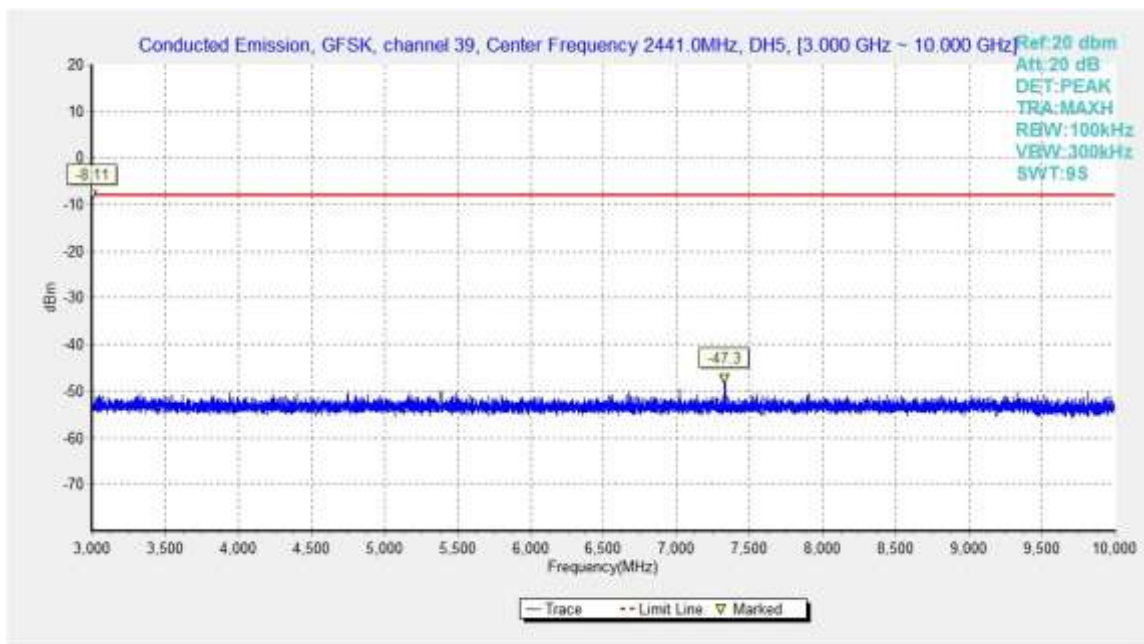

Fig.35. Conducted spurious emission: GFSK, Channel 39, 3GHz – 10GHz

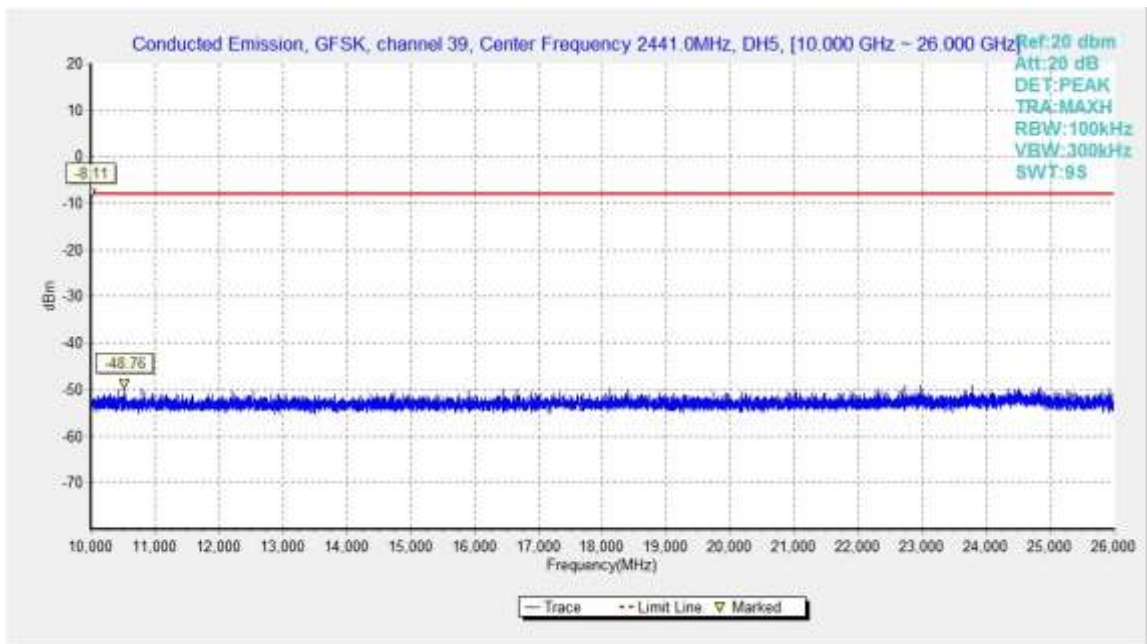

Fig.36. Conducted spurious emission: GFSK, Channel 39, 10GHz – 26GHz

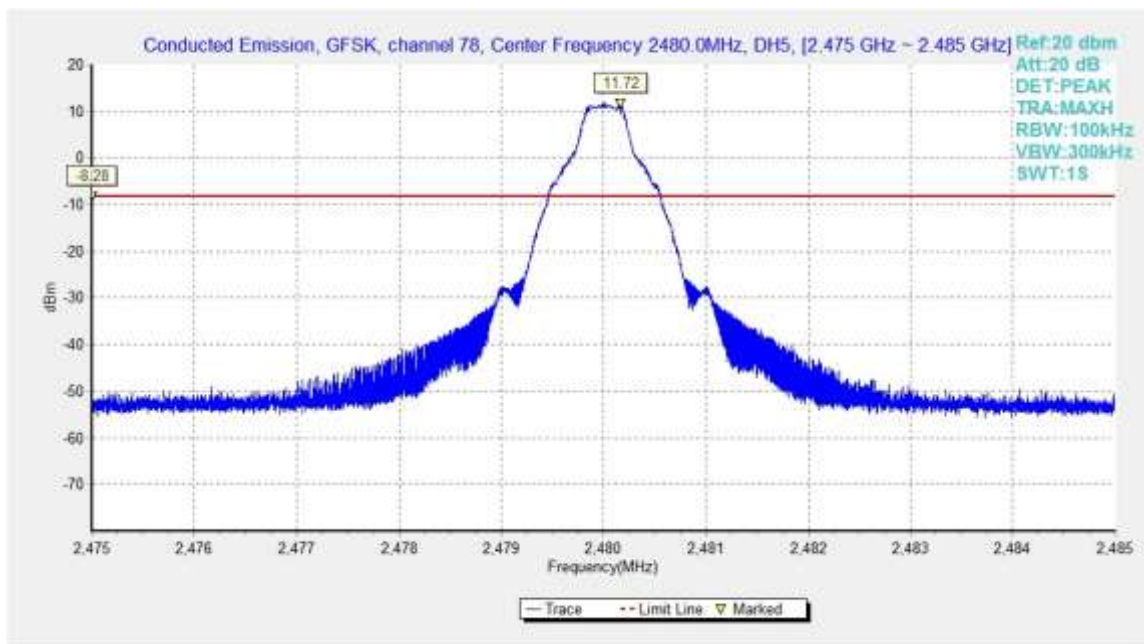

Fig.37. Conducted spurious emission: GFSK, Channel 78, 2480MHz

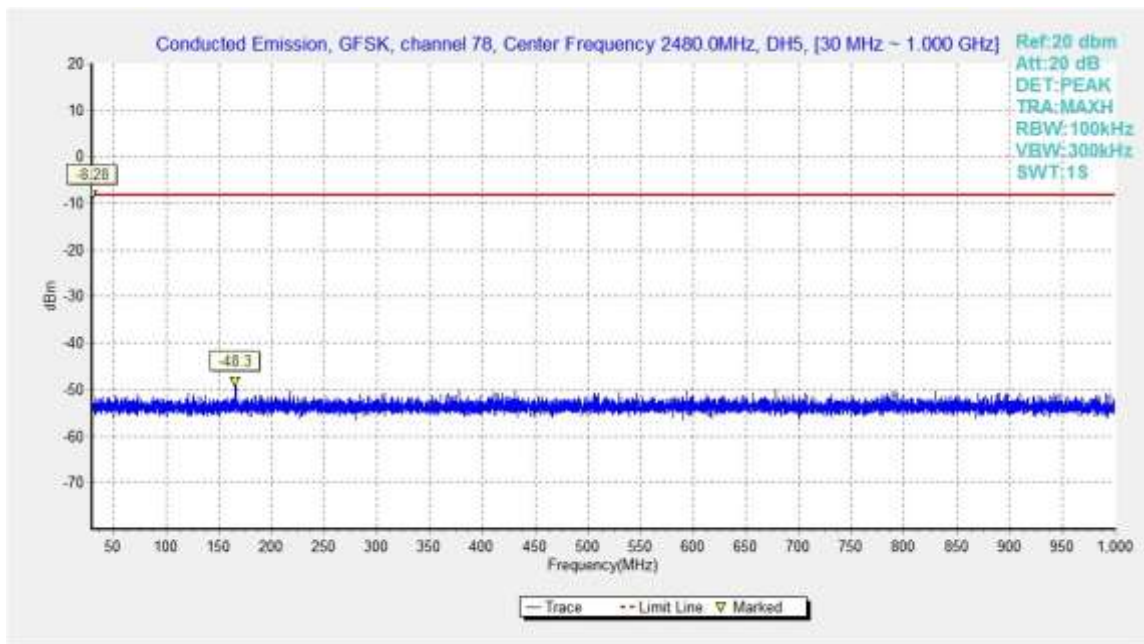

Fig.38. Conducted spurious emission: GFSK, Channel 78, 30MHz - 1GHz

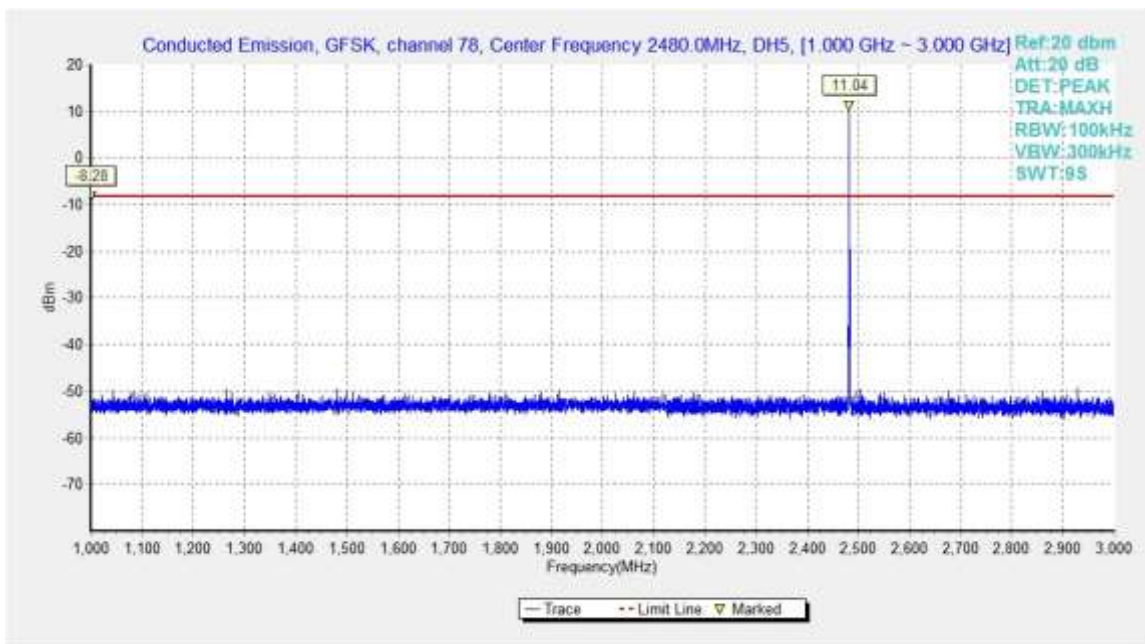

Fig.39. Conducted spurious emission: GFSK, Channel 78, 1GHz - 3GHz

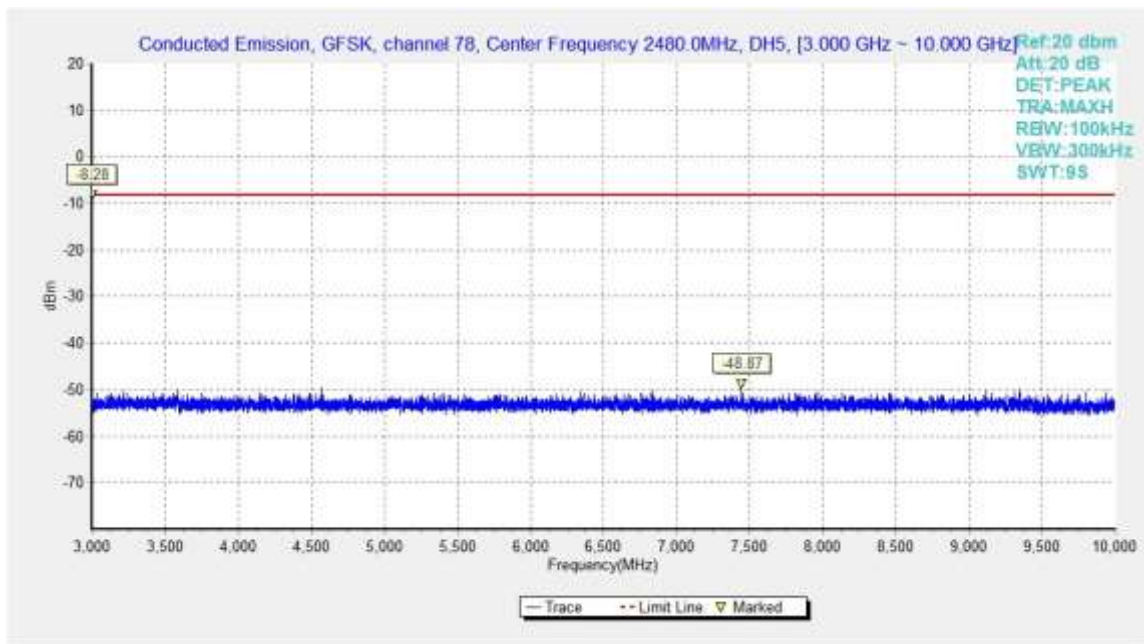

Fig.40. Conducted spurious emission: GFSK, Channel 78, 3GHz - 10GHz

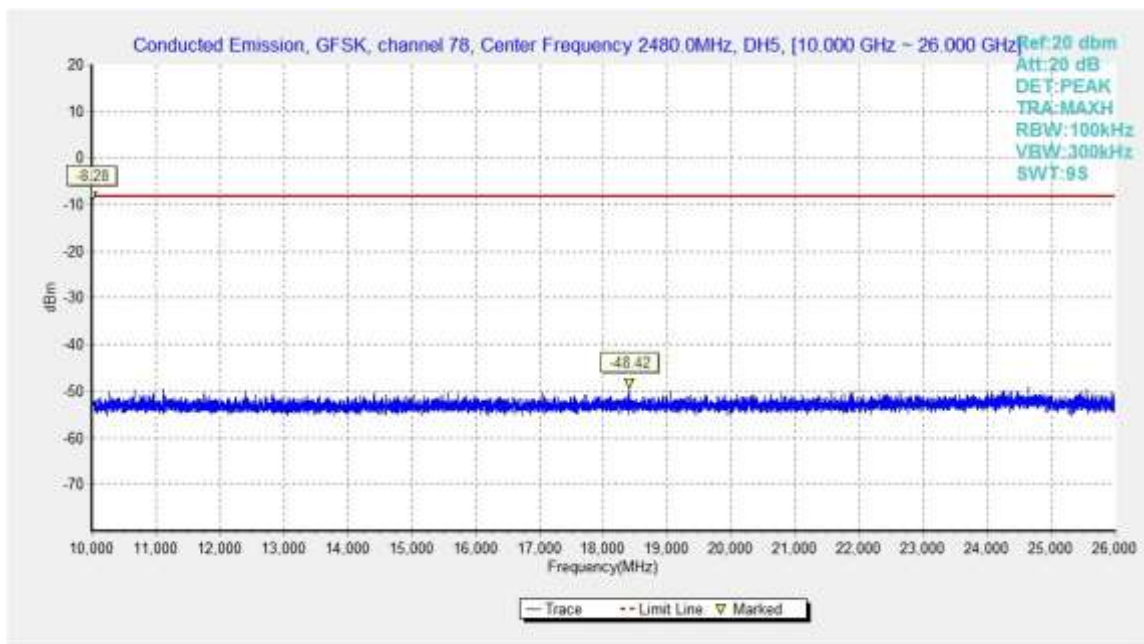

Fig.41. Conducted spurious emission: GFSK, Channel 78, 10GHz - 26GHz

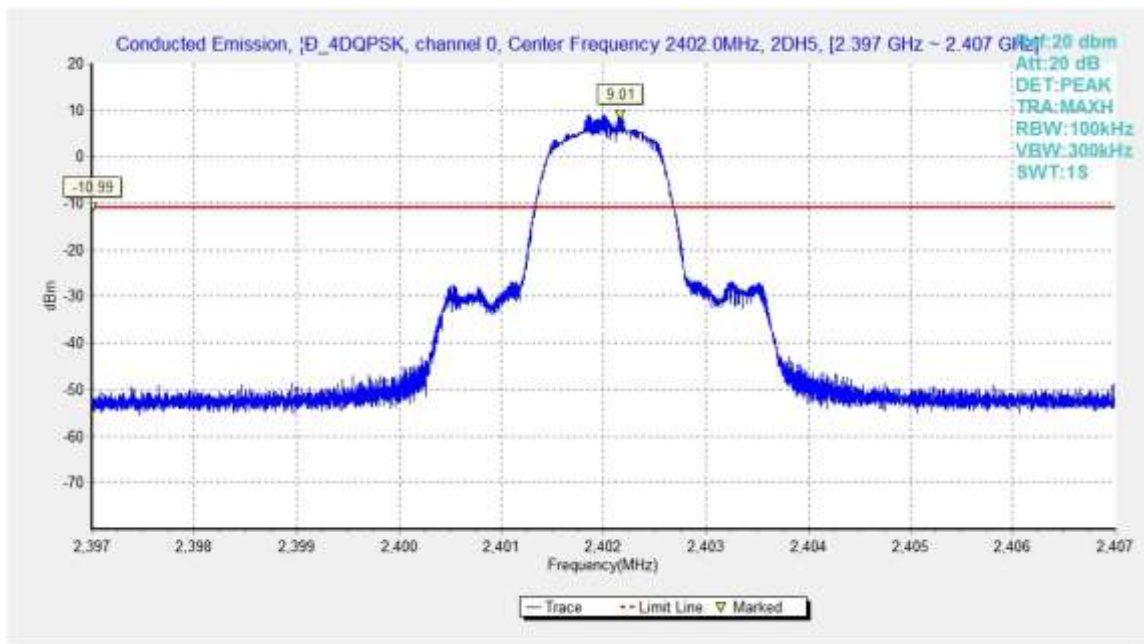

Fig.42. Conducted spurious emission: $\pi/4$ DQPSK, Channel 0, 2402MHz

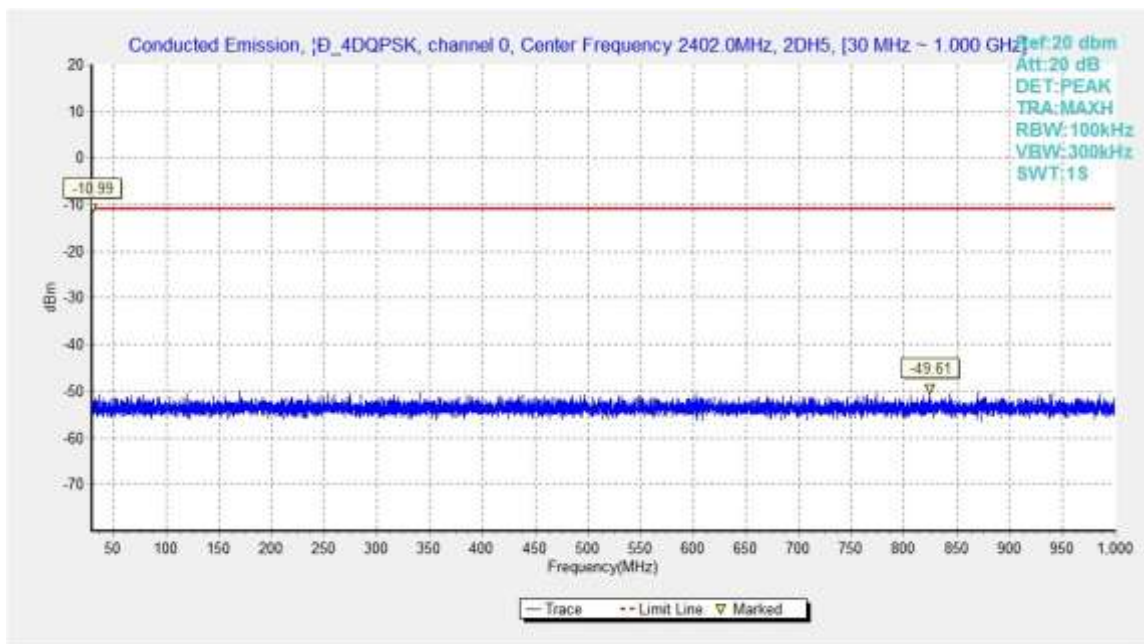

Fig.43. Conducted spurious emission: $\pi/4$ DQPSK, Channel 0, 30MHz - 1GHz

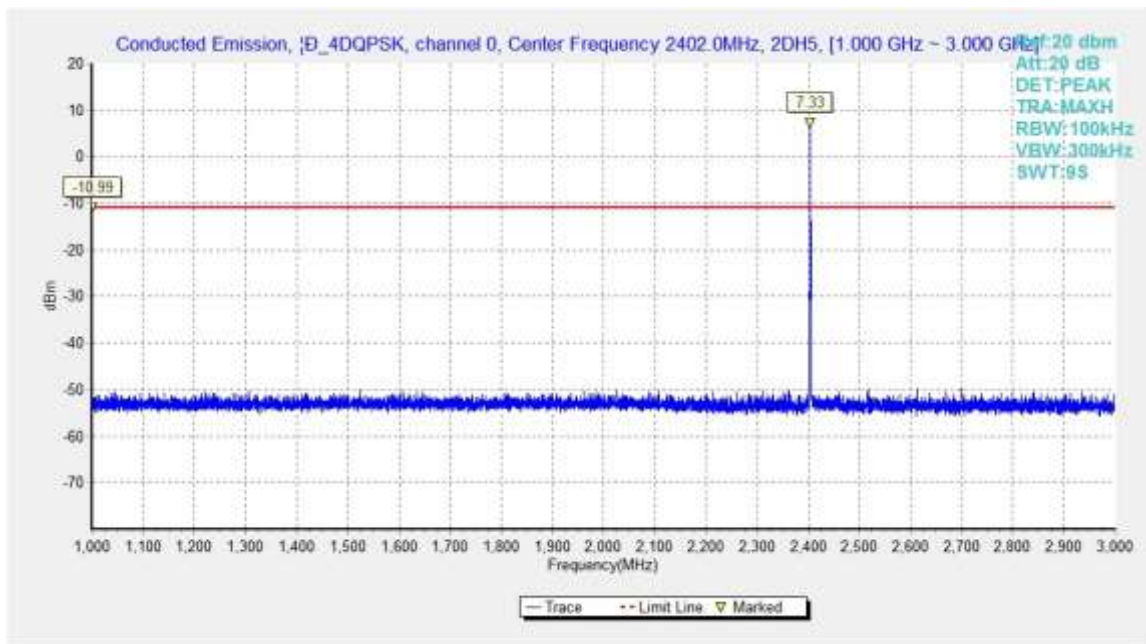

Fig.44. Conducted spurious emission: $\pi/4$ DQPSK, Channel 0, 1GHz - 3GHz

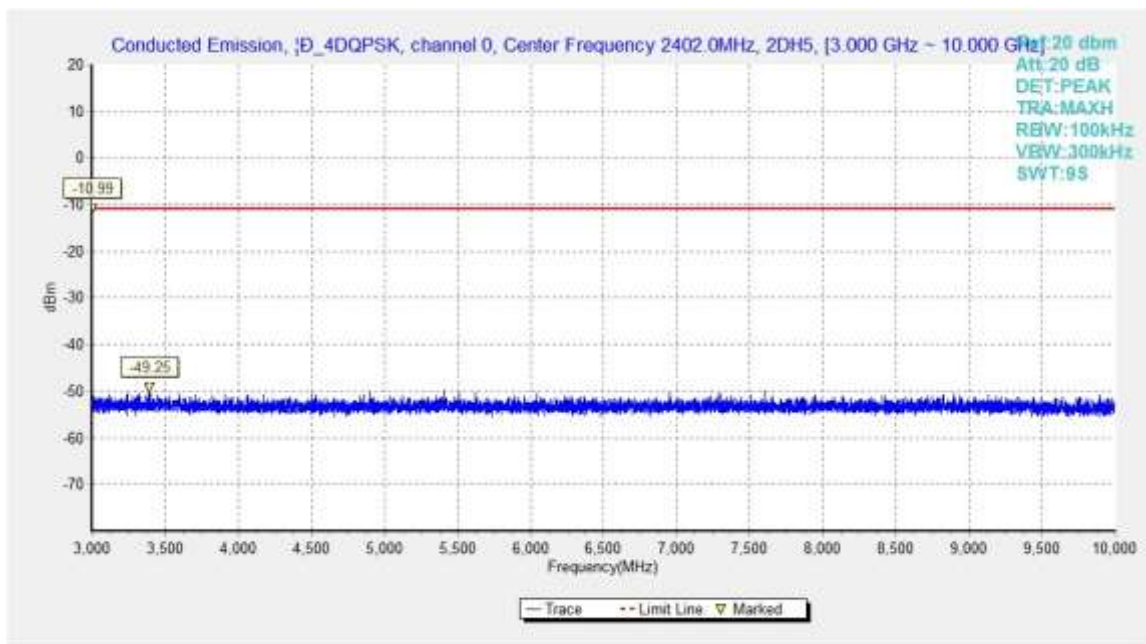

Fig.45. Conducted spurious emission: $\pi/4$ DQPSK, Channel 0, 3GHz - 10GHz

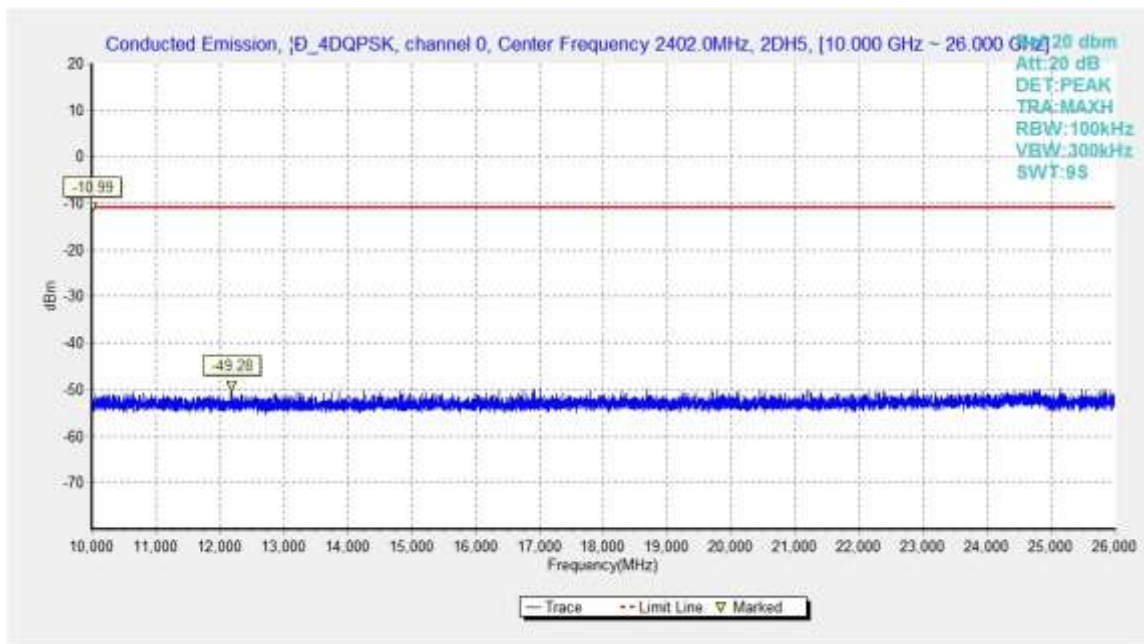

Fig.46. Conducted spurious emission: $\pi/4$ DQPSK, Channel 0, 10GHz - 26GHz

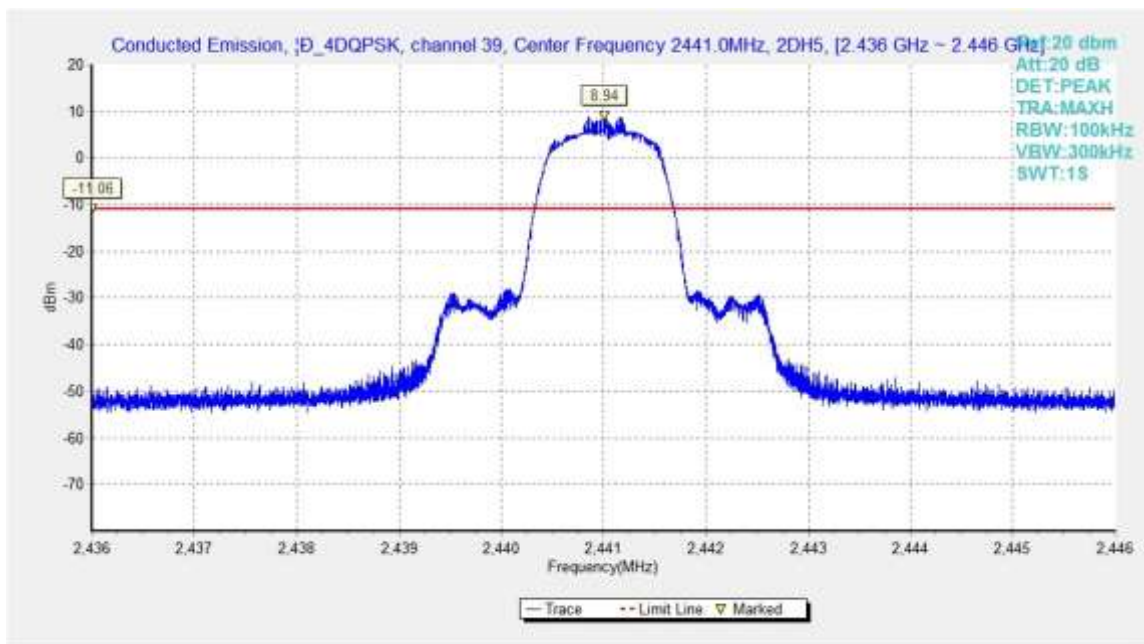

Fig.47. Conducted spurious emission: $\pi/4$ DQPSK, Channel 39, 2441MHz

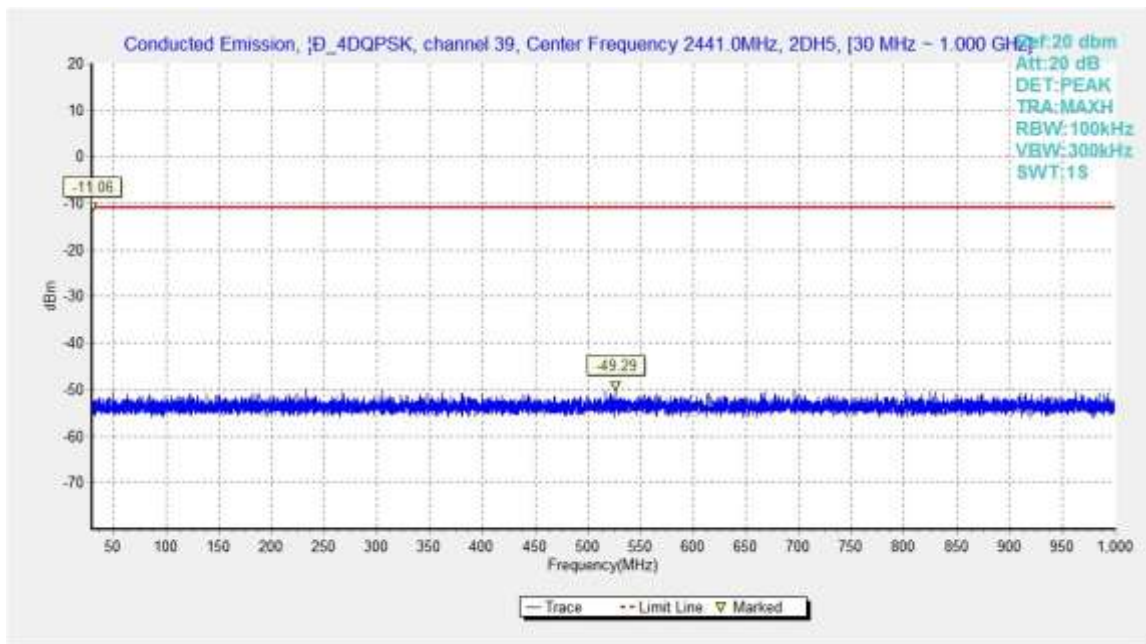

Fig.48. Conducted spurious emission: $\pi/4$ DQPSK, Channel 39, 30MHz - 1GHz

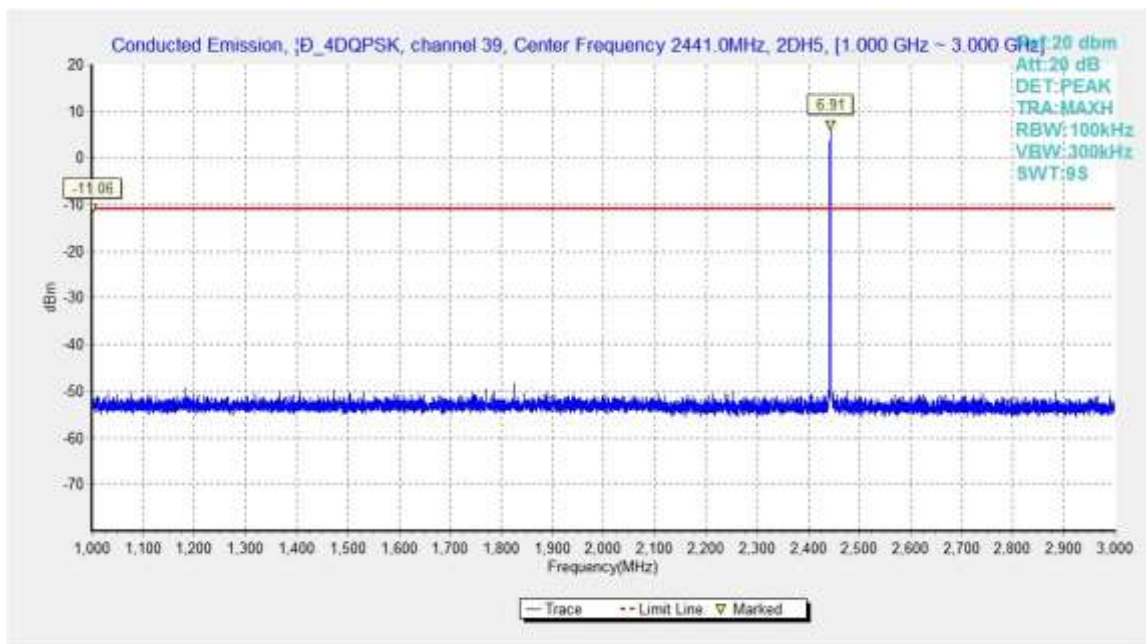

Fig.49. Conducted spurious emission: $\pi/4$ DQPSK, Channel 39, 1GHz - 3GHz

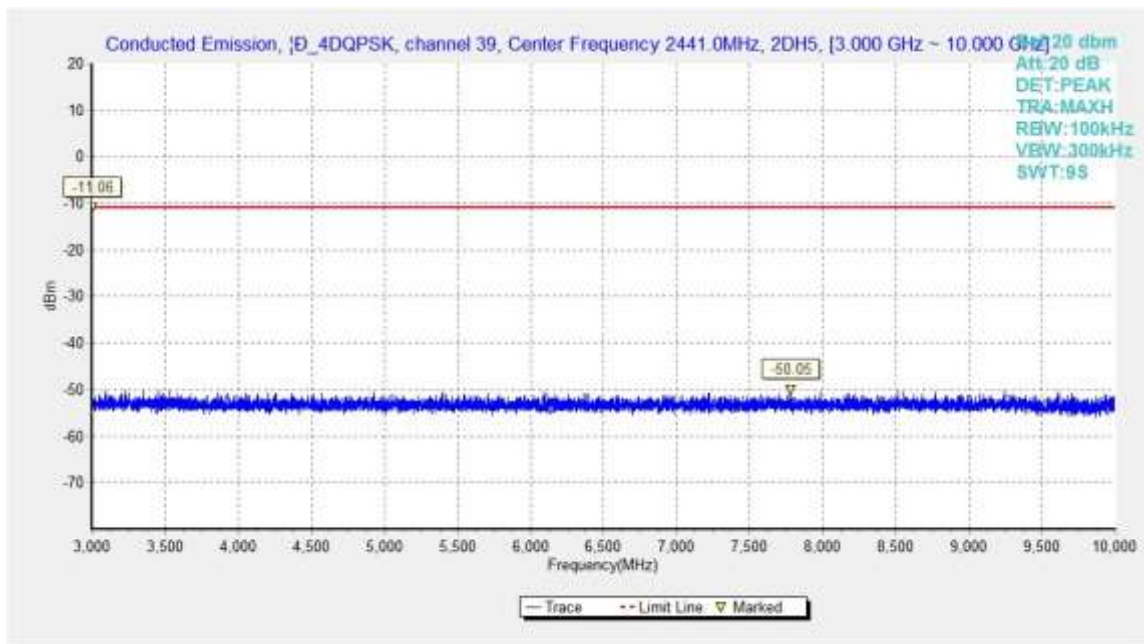

Fig.50. Conducted spurious emission: $\pi/4$ DQPSK, Channel 39, 3GHz - 10GHz

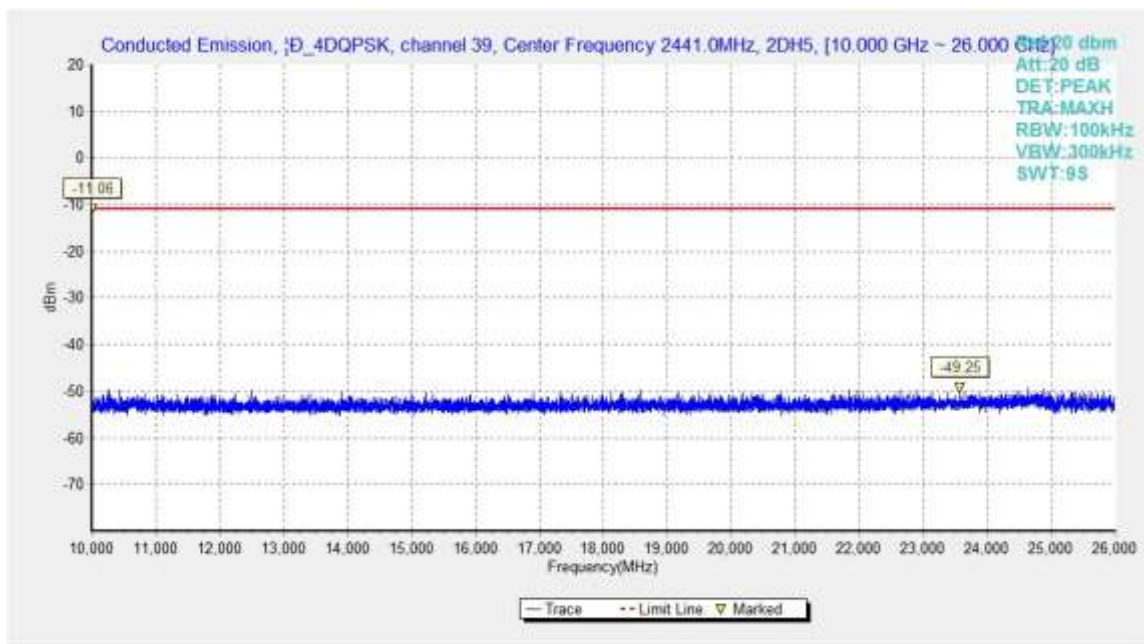

Fig.51. Conducted spurious emission: $\pi/4$ DQPSK, Channel 39, 10GHz – 26GHz

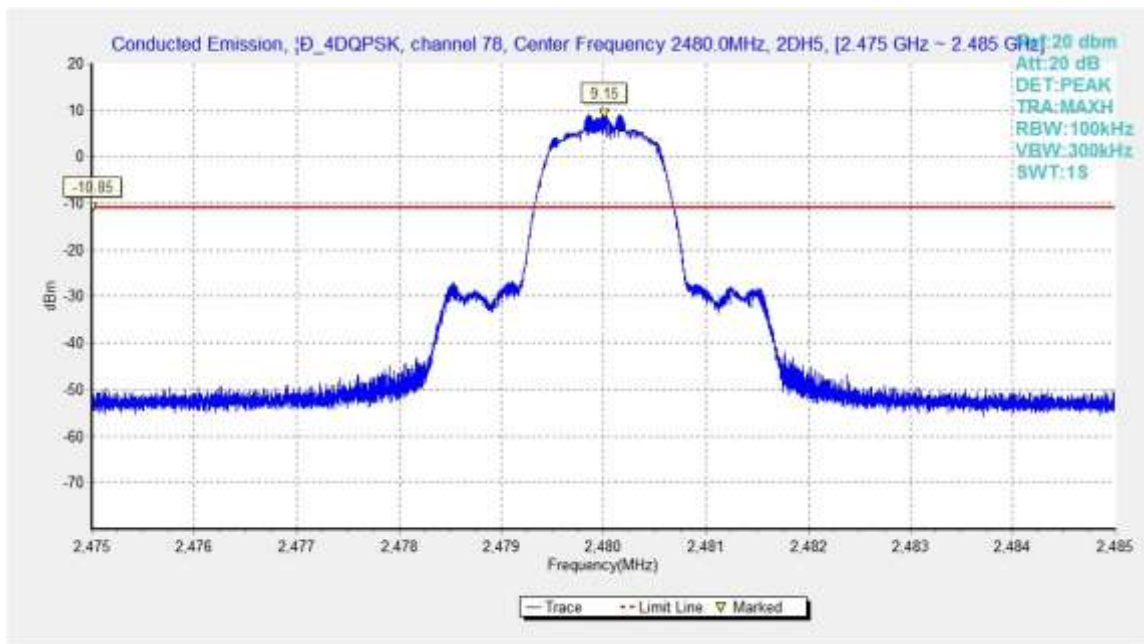

Fig.52. Conducted spurious emission: $\pi/4$ DQPSK, Channel 78, 2480MHz

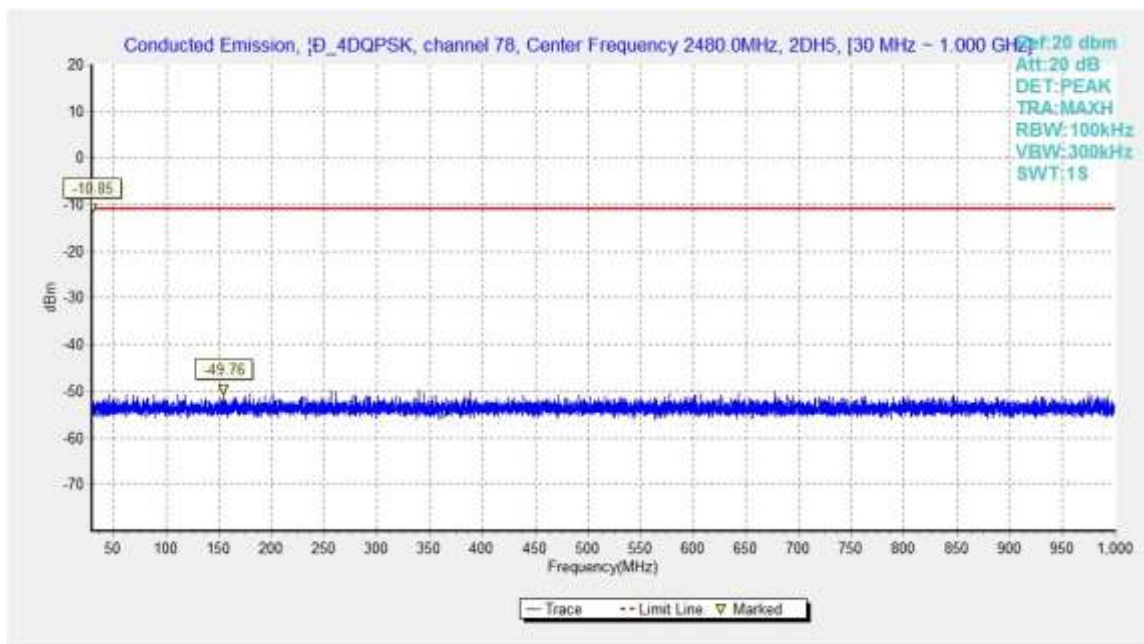

Fig.53. Conducted spurious emission: $\pi/4$ DQPSK, Channel 78, 30MHz - 1GHz

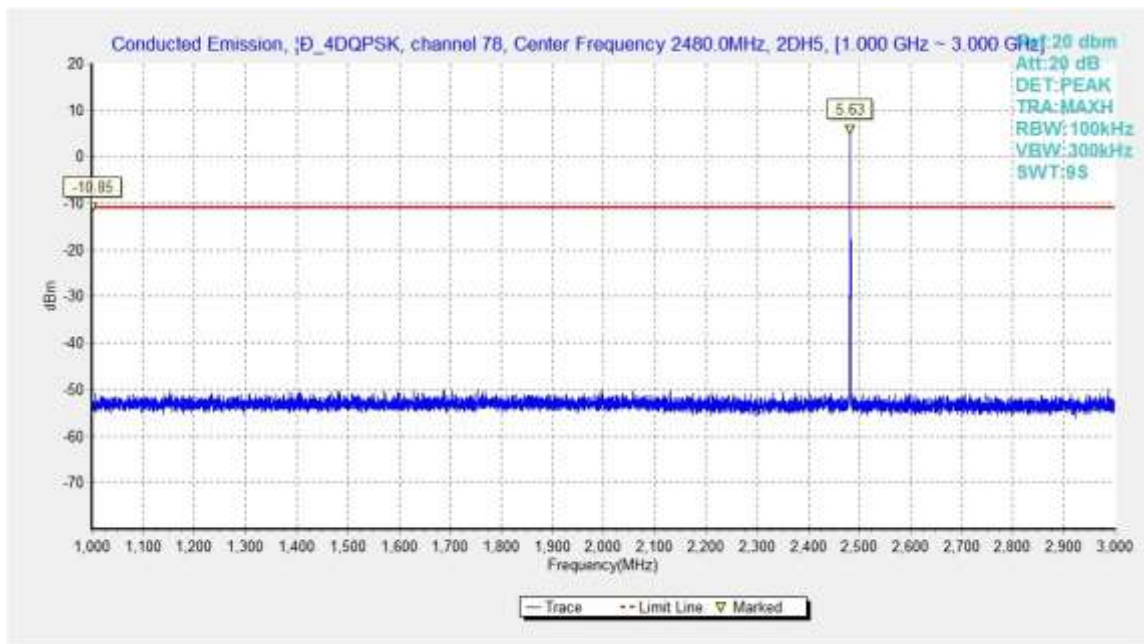

Fig.54. Conducted spurious emission: $\pi/4$ DQPSK, Channel 78, 1GHz - 3GHz

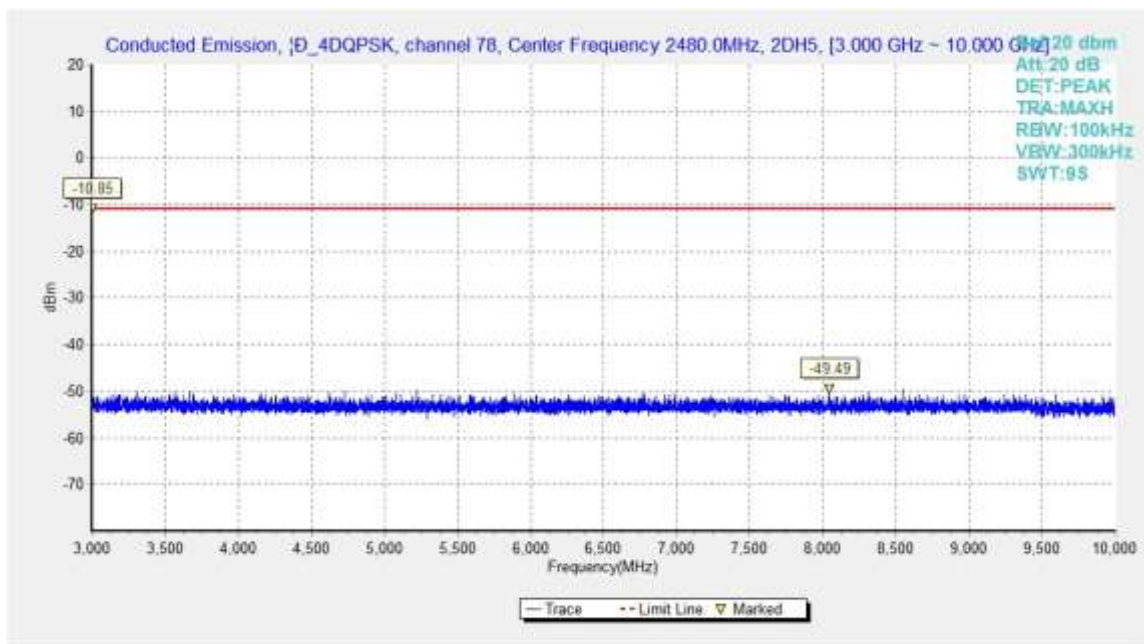

Fig.55. Conducted spurious emission: $\pi/4$ DQPSK, Channel 78, 3GHz - 10GHz

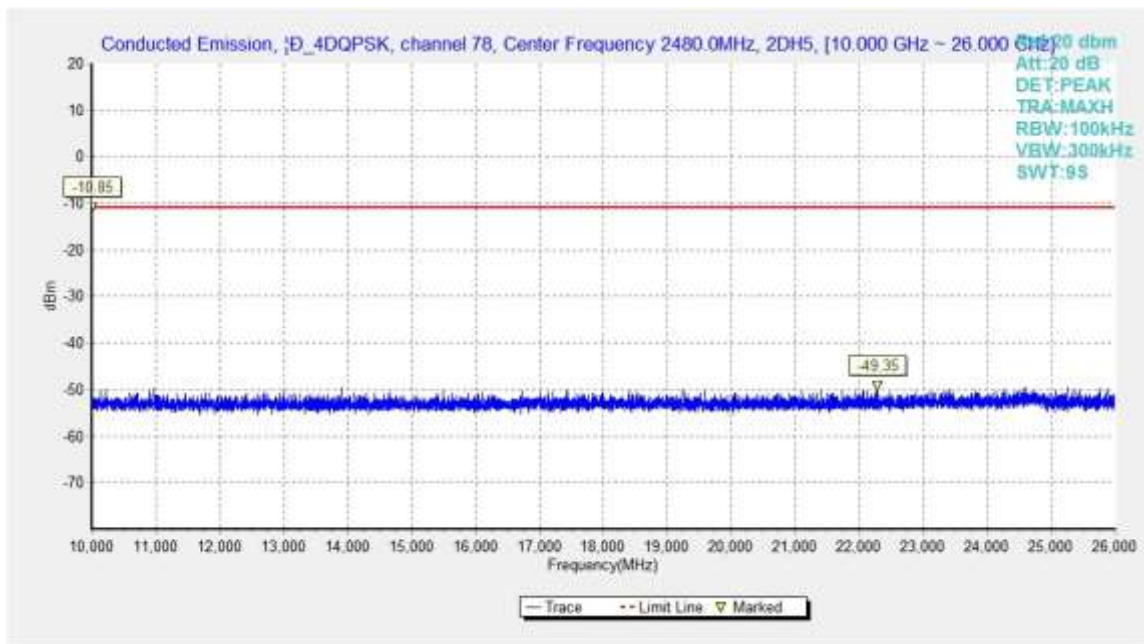

Fig.56. Conducted spurious emission: $\pi/4$ DQPSK, Channel 78, 10GHz - 26GHz

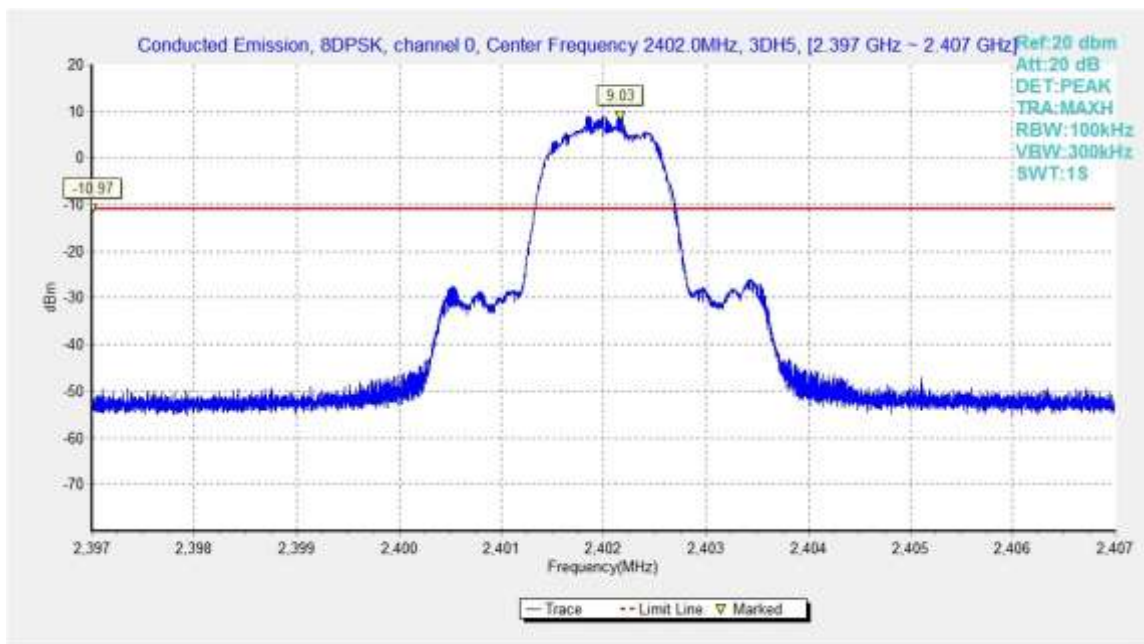

Fig.57. Conducted spurious emission: 8DPSK, Channel 0, 2.402MHz

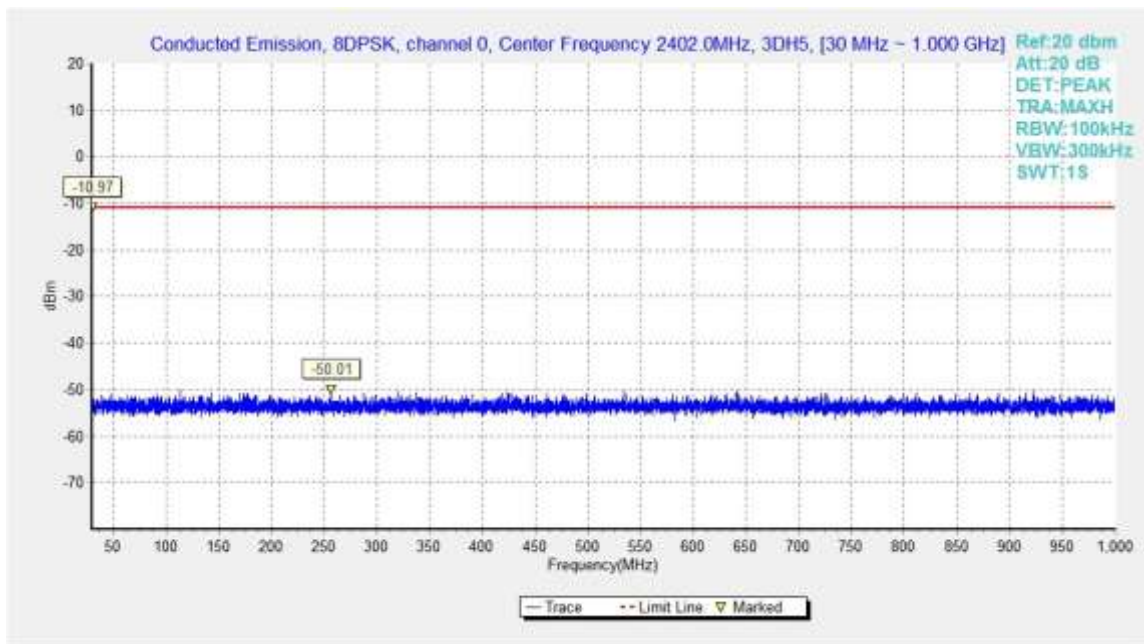

Fig.58. Conducted spurious emission: 8DPSK, Channel 0, 30MHz - 1GHz

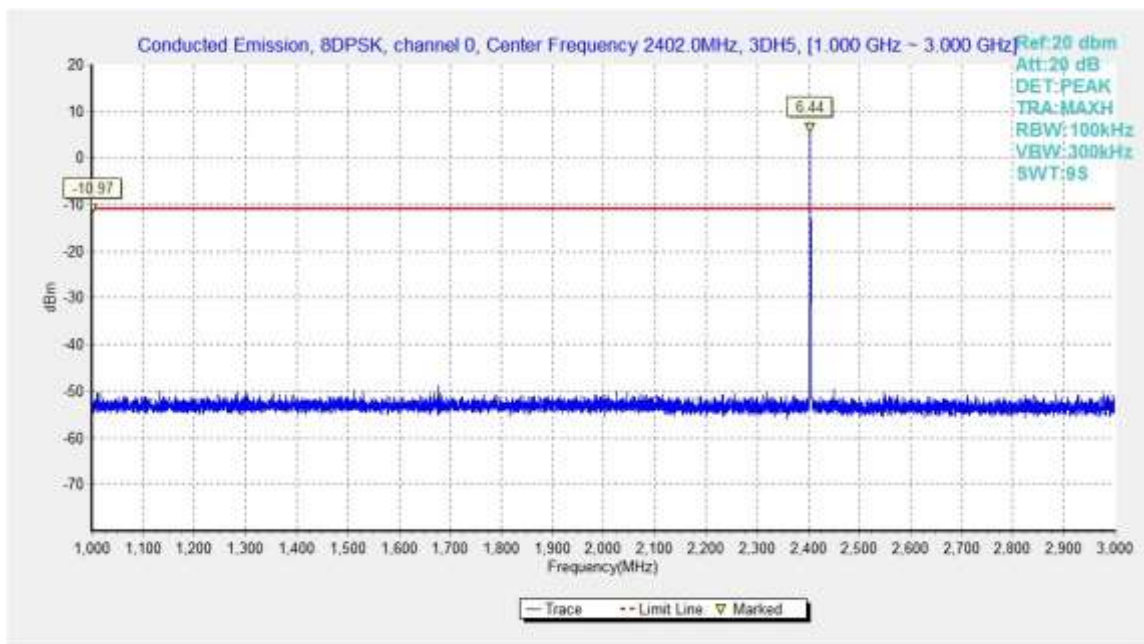

Fig.59. Conducted spurious emission: 8DPSK, Channel 0, 1GHz - 3GHz

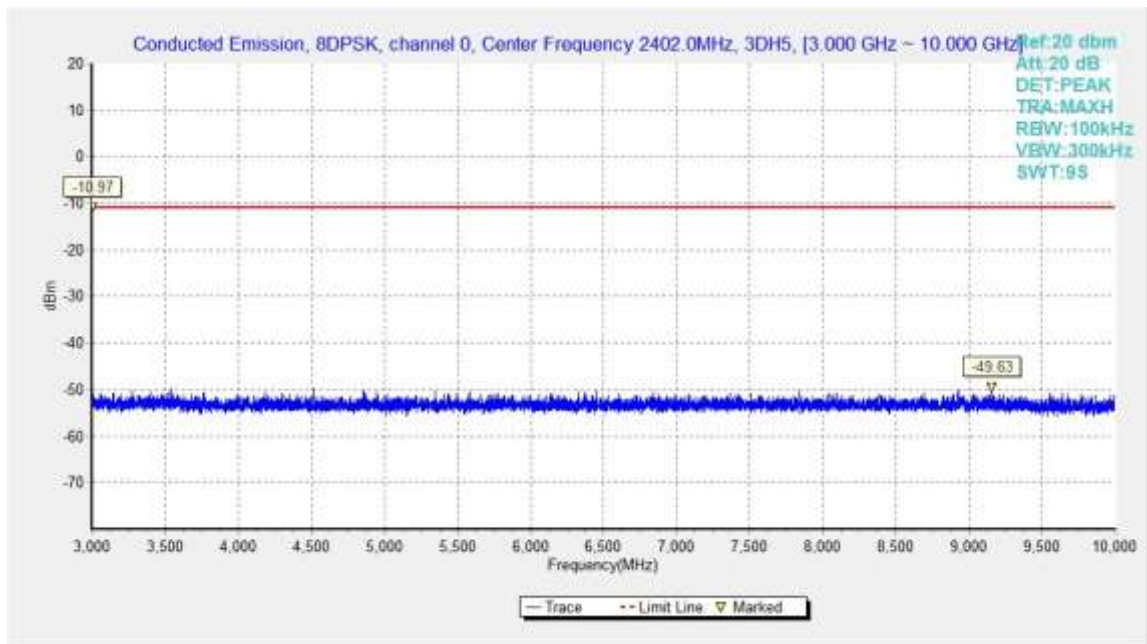

Fig.60. Conducted spurious emission: 8DPSK, Channel 0, 3GHz - 10GHz

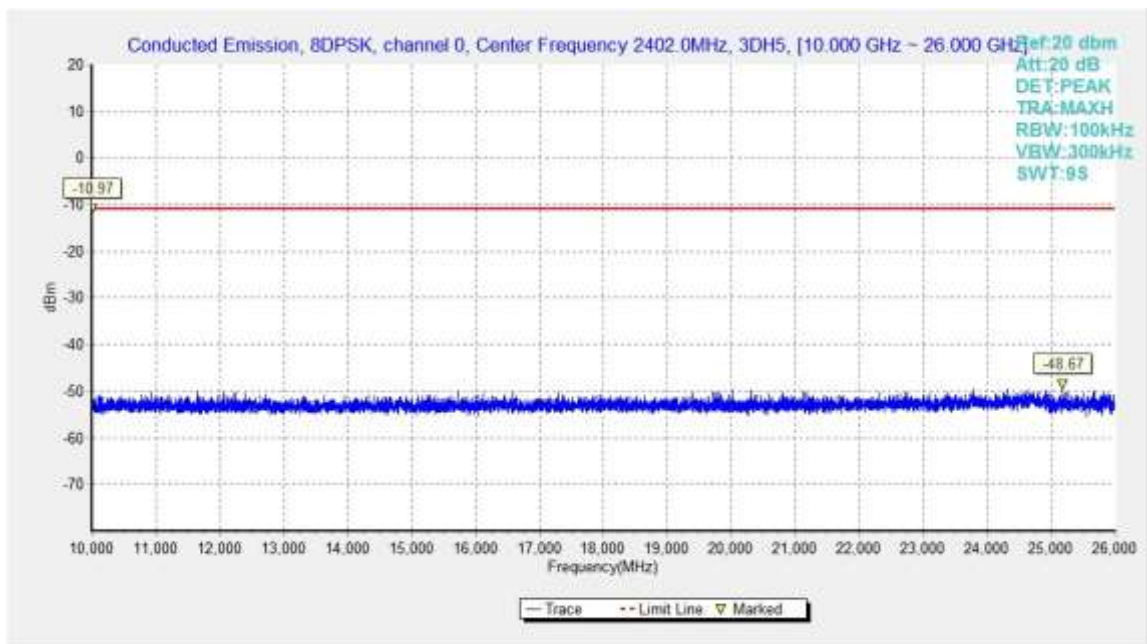

Fig.61. Conducted spurious emission: 8DPSK, Channel 0, 10GHz - 26GHz

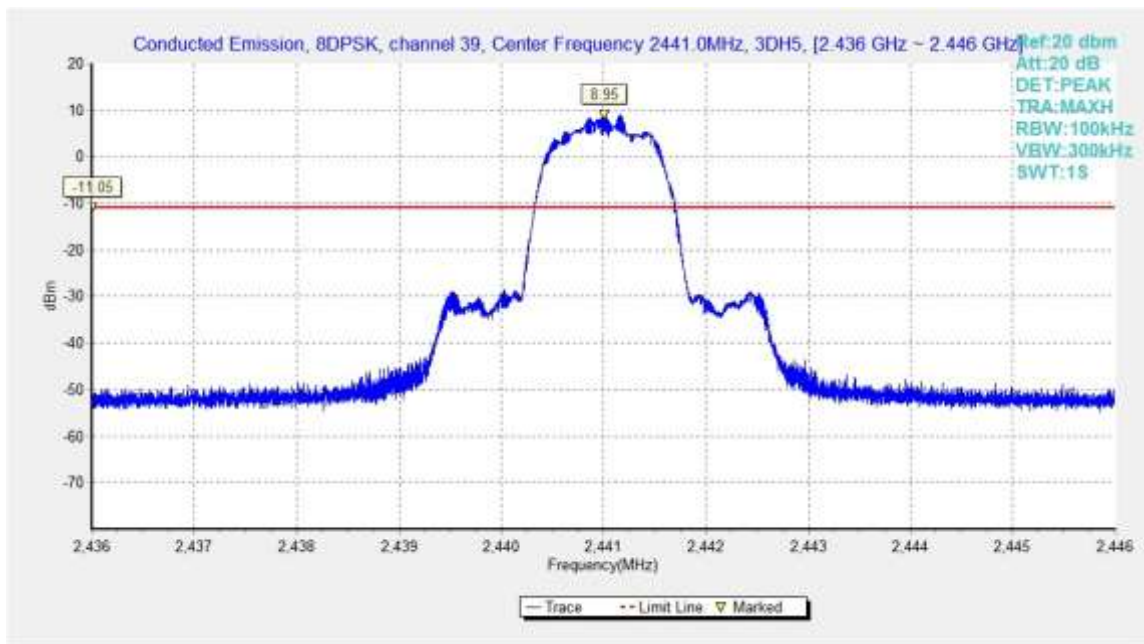

Fig.62. Conducted spurious emission: 8DPSK, Channel 39, 2441MHz

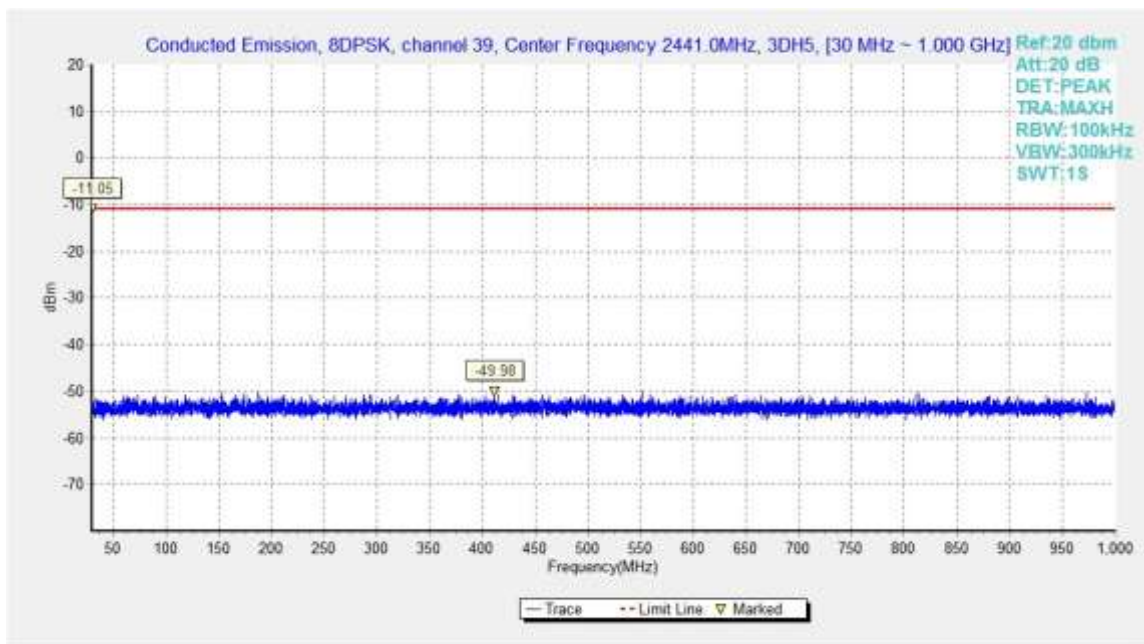

Fig.63. Conducted spurious emission: 8DPSK, Channel 39, 30MHz - 1GHz

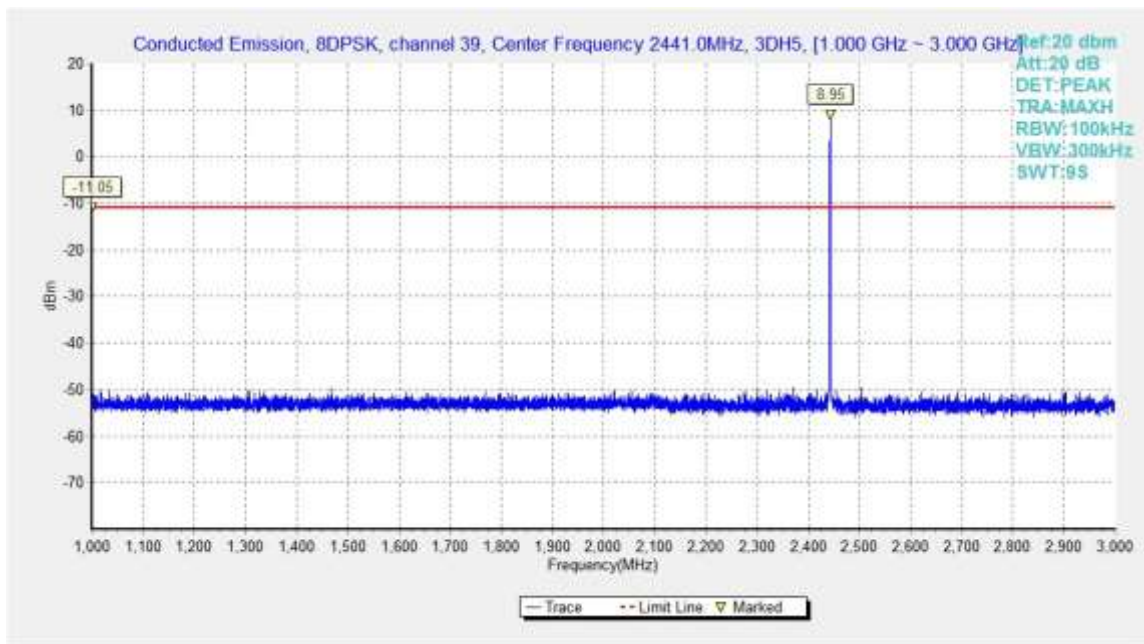

Fig.64. Conducted spurious emission: 8DPSK, Channel 39, 1GHz - 3GHz

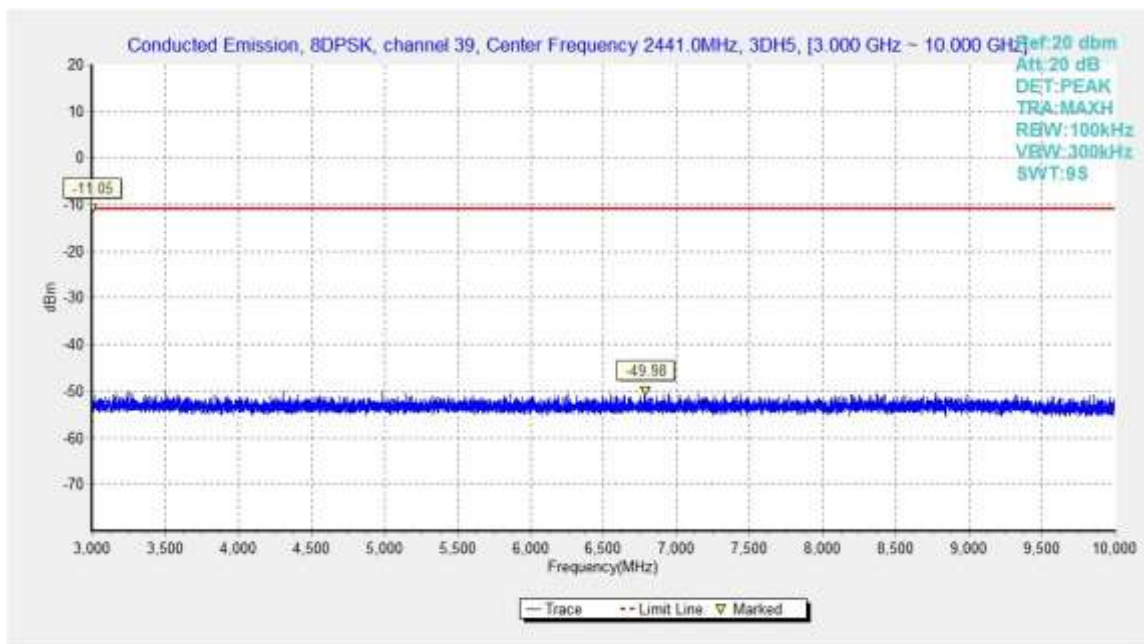

Fig.65. Conducted spurious emission: 8DPSK, Channel 39, 3GHz - 10GHz

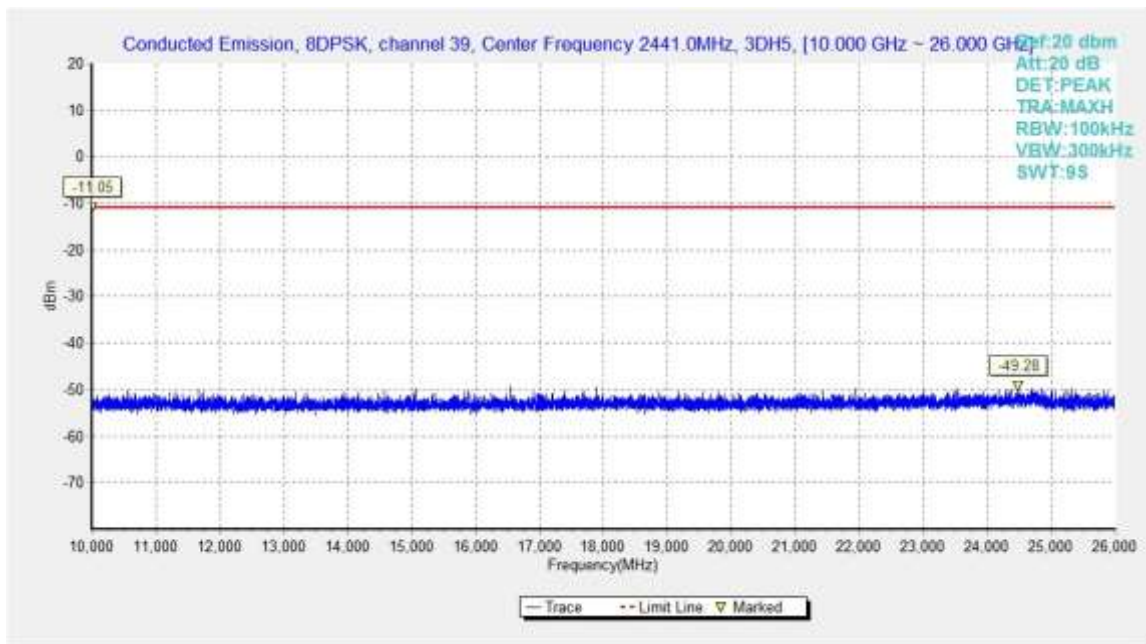

Fig.66. Conducted spurious emission: 8DPSK, Channel 39, 10GHz – 26GHz

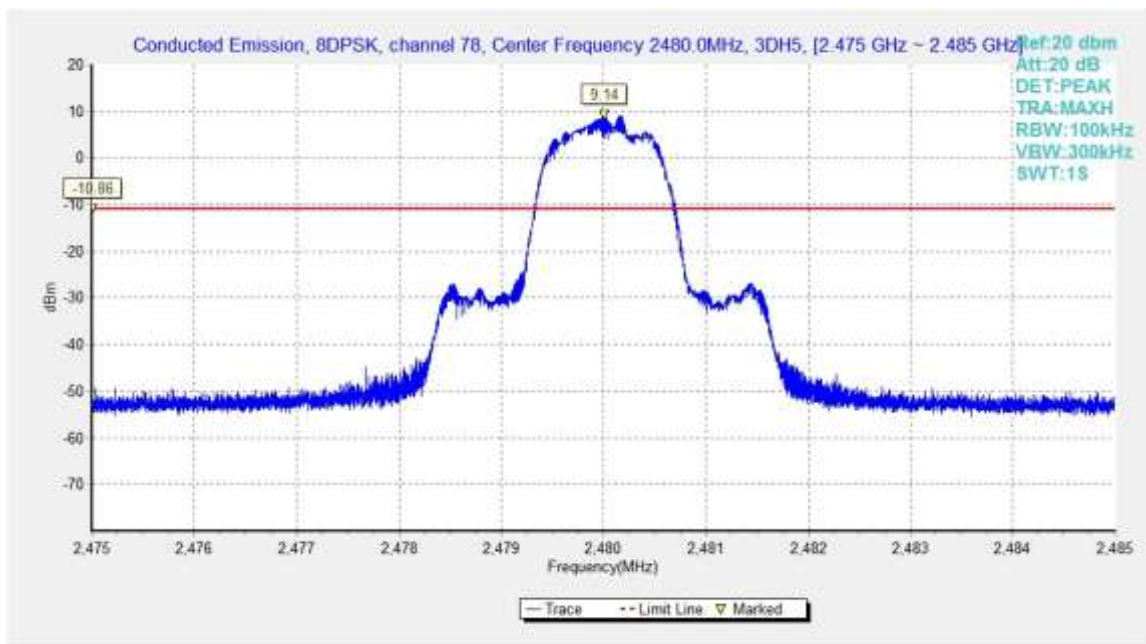

Fig.67. Conducted spurious emission: 8DPSK, Channel 78, 2480MHz

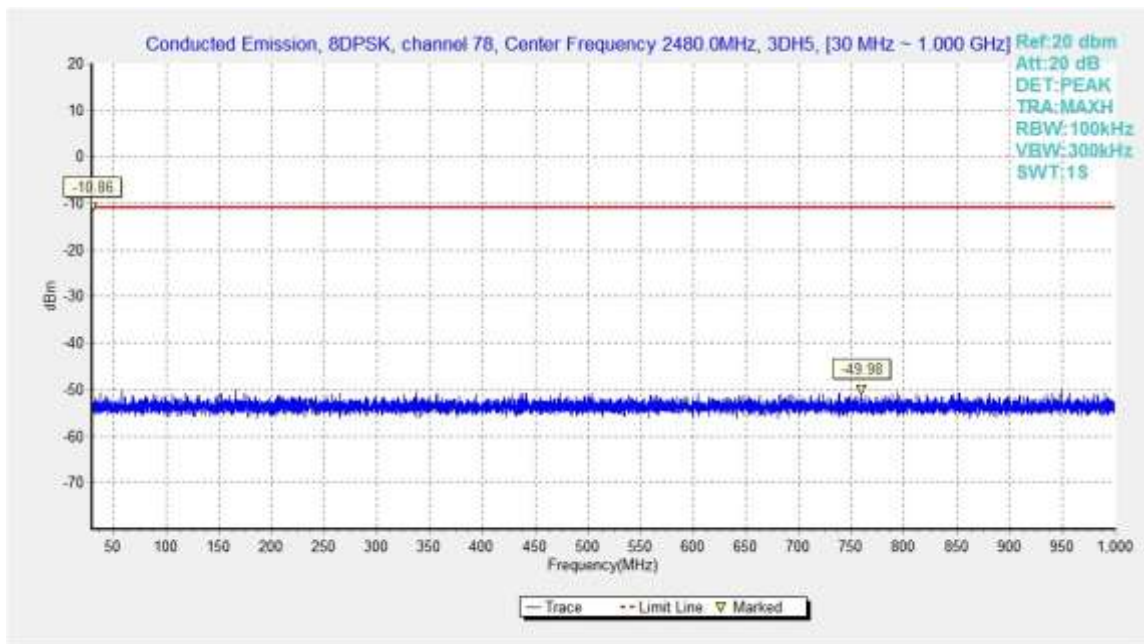

Fig.68. Conducted spurious emission: 8DPSK, Channel 78, 30MHz - 1GHz

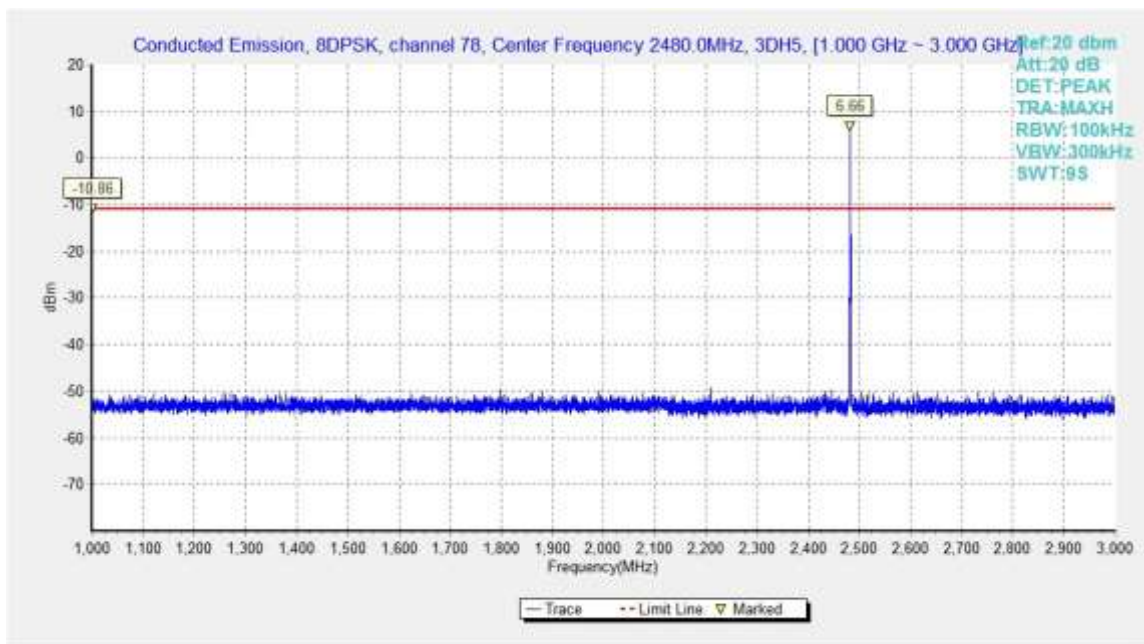

Fig.69. Conducted spurious emission: 8DPSK, Channel 78, 1GHz - 3GHz

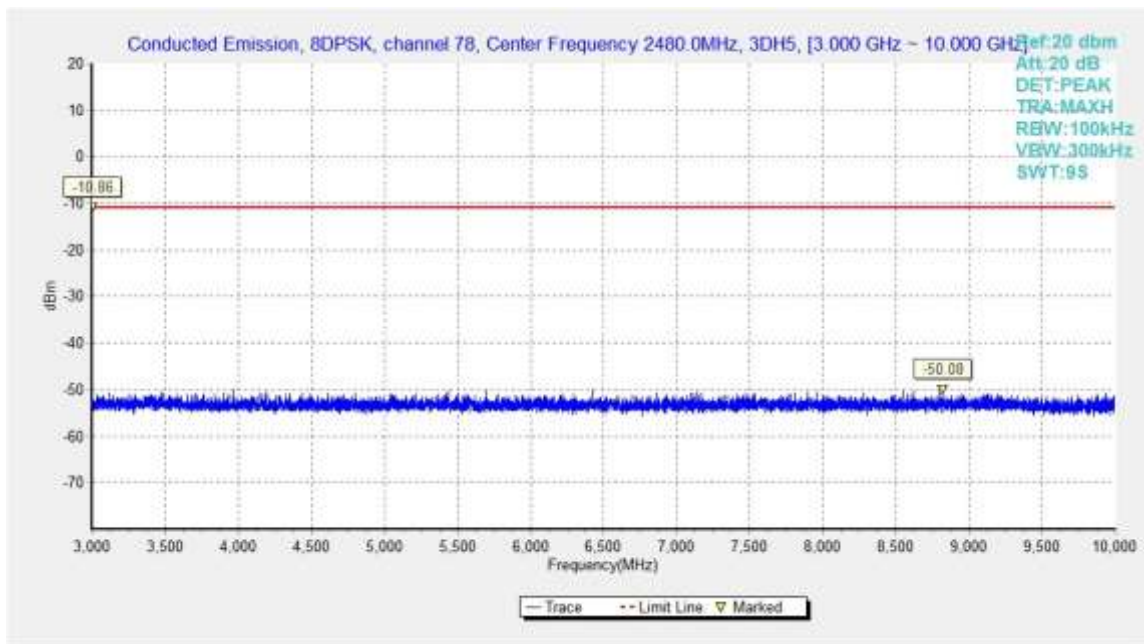

Fig.70. Conducted spurious emission: 8DPSK, Channel 78, 3GHz - 10GHz

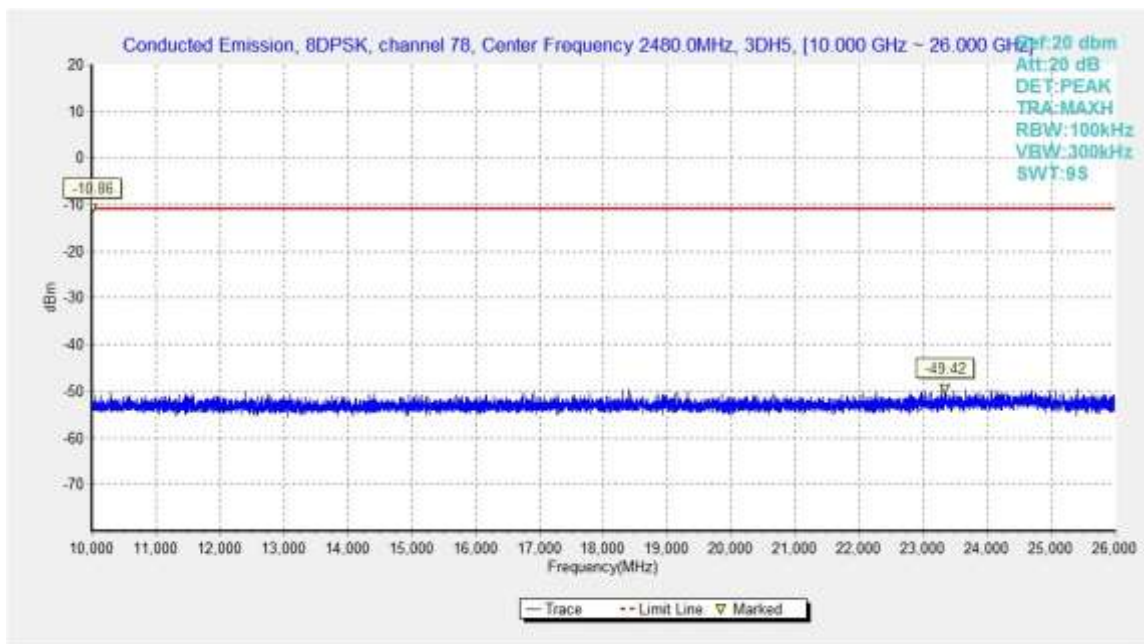

Fig.71. Conducted spurious emission: 8DPSK, Channel 78, 10GHz - 26GHz

B.6. Transmitter Spurious Emission - Radiated

Method of Measurement: See ANSI C63.10-2013-clause 6.4 & 6.5 & 6.6

Measurement Limit:

Standard	Limit
FCC 47 CFR Part 15.247, 15.205, 15.209	20dB below peak output power

radiated emissions which fall in the restricted bands, as defined in § 15.205(a), must also comply with the radiated emission limits specified in § 15.209(a) (see § 15.205(c)).

Limit in restricted band:

Frequency (MHz)	Field strength(μ V/m)	Measurement distance (m)
0.009 - 0.490	2400/F(kHz)	300
0.490 - 1.705	24000/F(kHz)	30
1.705 – 30.0	30	30

Frequency of emission (MHz)	Field strength(uV/m)	Field strength(dBuV/m)
30-88	100	40
88-216	150	43.5
216-960	200	46
Above 960	500	54

Set up:

Tabletop devices shall be placed on a nonconducting platform with nominal top surface dimensions 1 m by 1.5 m. For emissions testing at or below 1 GHz, the table height shall be 80 cm above the reference ground plane. For emission measurements above 1 GHz, the table height shall be 1.5 m

The EUT and transmitting antenna shall be centered on the turntable.

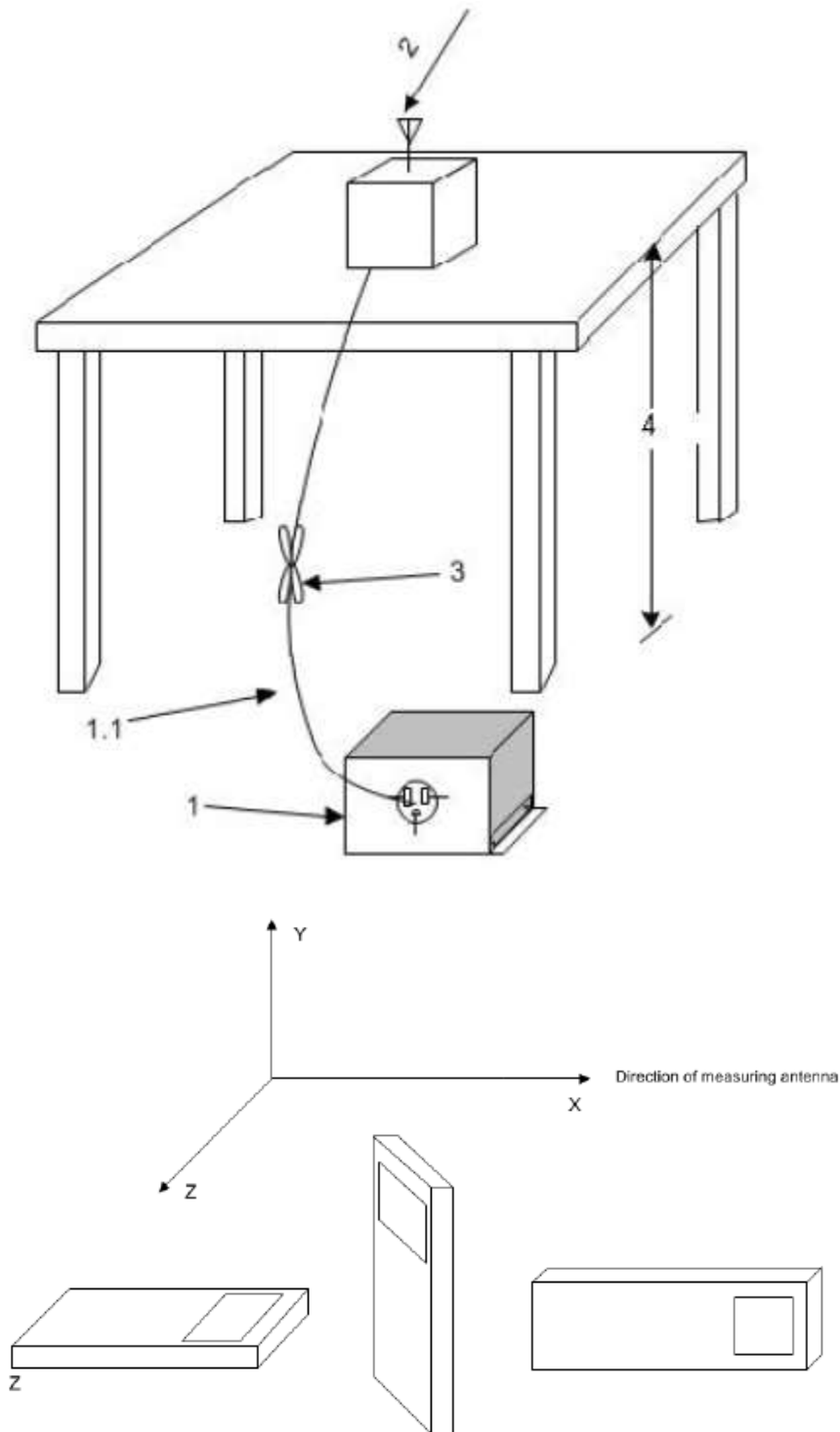

Test Condition

The EUT shall be tested 1 near top, 1 near middle, and 1 near bottom. Set the unlicensed wireless device to operate in continuous transmit mode. For unlicensed wireless devices unable to be configured for 100% duty cycle even in test mode, configure the system for the maximum duty cycle supported.

When required for unlicensed wireless devices, measurements of the variation of the input power or the radiated signal level of the fundamental frequency component of the emission, as appropriate, shall be performed with the supply voltage varied between 85% and 115% of the

nominal rated supply voltage.

Exploratory radiated emissions measurements

Exploratory radiated measurements shall be performed at the measurement distance or at a closer distance than that specified for compliance to determine the emission characteristics of the EUT and, if applicable, the EUT configuration that produces the maximum level of emissions. The frequencies of maximum emission may be determined by manually positioning the antenna close to the EUT, and then moving the antenna over all sides of the EUT while observing a spectral display. It is advantageous to have prior knowledge of the frequencies of emissions, although this may be determined from such a near-field scan. The near-field scan shall only be used to determine the frequency but not the amplitude of the emissions. Where exploratory measurements are not adequate to determine the worst-case operating modes and are used only to identify the frequencies of the highest emissions, additional preliminary tests can be required.

For emissions from the EUT, the maximum level shall be determined by rotating the EUT and its antenna through 0° to 360° . For each mode of operation required to be tested, the frequency spectrum (based on findings from exploratory measurements) shall be monitored.

Broadband antennas and a spectrum analyzer or a radio-noise meter with a panoramic display are often useful in this type of test. If either antenna height or EUT azimuth are not fully measured during exploratory testing, then complete testing can be required at the OATS or semi-anechoic chamber when the final full spectrum testing is performed.

Final radiated emissions measurements

The final measurements are using the orientation and equipment arrangement of the EUT based on the measurement results found during the preliminary (exploratory) measurements, the EUT arrangement, appropriate modulation, and modes of operation that produce the emissions that have the highest amplitude relative to the limit shall be selected for the final measurement.

For each mode of operation required to be tested, the frequency spectrum (based on findings from exploratory measurements) shall be monitored. The highest signal levels relative to the limit shall be determined by rotating the EUT from 0° to 360° and with varying the measurement antenna height between 1 m and 4 m in vertical and horizontal polarizations.

For each mode selected, record the frequency and amplitude of the highest fundamental emission (if applicable), as well as the frequency and amplitude of the six highest spurious emissions relative to the limit. Emissions more than 20 dB below the limit do not need to be reported.

This maximization process was repeated with the EUT positioned in each of its three orthogonal orientations.

The receiver references:

Frequency of emission (MHz)	RBW/VBW	Sweep Time(s)
30-1000	100KHz/300KHz	5
1000-4000	1MHz/3MHz	15
4000-18000	1MHz/3MHz	40
18000-26500	1MHz/3MHz	20

P_{Mea} is the field strength recorded from the instrument.

The measurement results are obtained as described below:

$$\text{Result} = P_{Mea} + \text{Cable Loss} + \text{Antenna Factor}$$

Where:

P_{Mea} field strength recorded from the instrument

EUT ID: EUT3 + AE2-1

Average Measurement results

GFSK Ch 0

Frequency (MHz)	Measurement Result (dBμV/m)	Cable loss (dB)	Antenna Factor (dB/m)	Receiver Reading (dBμV)	Limit (dBμV/m)	Margin (dB)	Antenna Pol. (H/V)
12009.500	42.86	-31.50	39.10	35.26	54.00	11.14	V
17239.000	41.38	-25.90	44.40	22.98	54.00	12.62	H
7206.000	40.49	-35.50	36.40	39.59	54.00	13.51	H
4804.000	39.64	-37.30	33.00	43.84	54.00	14.36	H
14094.500	38.89	-29.40	41.70	26.69	54.00	15.11	H
2336.700	44.37	-20.10	28.00	36.47	54.00	9.63	H

GFSK Ch 39

Frequency (MHz)	Measurement Result (dBμV/m)	Cable loss (dB)	Antenna Factor (dB/m)	Receiver Reading (dBμV)	Limit (dBμV/m)	Margin (dB)	Antenna Pol. (H/V)
12205.500	41.75	-31.40	39.00	34.15	54.00	12.25	V
17140.000	40.73	-26.60	43.40	23.93	54.00	13.27	V
13702.000	38.61	-29.10	40.90	26.81	54.00	15.39	V
7322.500	36.89	-35.10	36.60	35.39	54.00	17.11	H
4882.000	36.13	-37.20	33.20	40.13	54.00	17.87	H
8704.500	34.93	-34.40	38.00	31.33	54.00	19.07	V

GFSK Ch 78

Frequency (MHz)	Measurement Result (dBμV/m)	Cable loss (dB)	Antenna Factor (dB/m)	Receiver Reading (dBμV)	Limit (dBμV/m)	Margin (dB)	Antenna Pol. (H/V)
12399.500	43.42	-31.20	38.90	35.72	54.00	10.58	V
17146.000	41.00	-26.60	43.40	24.20	54.00	13.00	V
13722.000	38.85	-29.10	40.90	27.05	54.00	15.15	H
7440.500	38.18	-35.20	36.70	36.58	54.00	15.82	H
4960.000	37.76	-37.10	33.30	41.56	54.00	16.24	V
2490.900	44.47	-20.00	28.30	36.17	54.00	9.53	V

$\pi/4$ DQPSK Ch 0

Frequency (MHz)	Measurement Result (dB μ V/m)	Cable loss (dB)	Antenna Factor (dB/m)	Receiver Reading (dB μ V)	Limit (dB μ V/m)	Margin (dB)	Antenna Pol. (H/V)
17922.000	41.04	-25.50	46.70	19.84	54.00	12.96	V
13721.000	38.55	-29.10	40.90	26.75	54.00	15.45	V
12010.000	37.68	-31.50	39.10	30.08	54.00	16.32	V
9395.500	35.23	-32.90	37.90	30.23	54.00	18.77	H
7320.000	34.52	-35.10	36.60	33.02	54.00	19.48	H
2339.800	44.49	-20.10	28.00	36.59	54.00	9.51	V

 $\pi/4$ DQPSK Ch 39

Frequency (MHz)	Measurement Result (dB μ V/m)	Cable loss (dB)	Antenna Factor (dB/m)	Receiver Reading (dB μ V)	Limit (dB μ V/m)	Margin (dB)	Antenna Pol. (H/V)
17141.000	40.93	-26.60	43.40	24.13	54.00	13.07	H
13709.500	38.67	-29.10	40.90	26.87	54.00	15.33	H
12998.000	36.59	-30.50	39.20	27.89	54.00	17.41	V
8714.500	35.14	-34.40	38.00	31.54	54.00	18.86	H
7318.500	34.38	-35.10	36.60	32.88	54.00	19.62	H
4881.500	31.69	-37.20	33.20	35.69	54.00	22.31	V

 $\pi/4$ DQPSK Ch 78

Frequency (MHz)	Measurement Result (dB μ V/m)	Cable loss (dB)	Antenna Factor (dB/m)	Receiver Reading (dB μ V)	Limit (dB μ V/m)	Margin (dB)	Antenna Pol. (H/V)
17627.000	40.91	-25.70	46.00	20.71	54.00	13.09	V
13731.000	38.60	-29.10	40.90	26.80	54.00	15.40	V
12991.500	36.63	-30.50	39.20	27.93	54.00	17.37	V
8718.500	35.25	-34.40	38.00	31.65	54.00	18.75	V
7313.500	34.29	-35.00	36.50	32.69	54.00	19.71	V
2499.500	44.53	-20.00	28.40	36.13	54.00	9.47	V

8DPSK Ch 0

Frequency (MHz)	Measurement Result (dB μ V/m)	Cable loss (dB)	Antenna Factor (dB/m)	Receiver Reading (dB μ V)	Limit (dB μ V/m)	Margin (dB)	Antenna Pol. (H/V)
17137.500	41.18	-26.60	43.40	24.38	54.00	12.82	H
13739.500	38.74	-29.10	40.90	26.94	54.00	15.26	H
12009.000	37.19	-31.50	39.10	29.59	54.00	16.81	V
9496.000	35.14	-33.20	37.90	30.44	54.00	18.86	V
4804.000	35.11	-37.30	33.00	39.31	54.00	18.89	H
2344.800	44.43	-20.10	28.00	36.53	54.00	9.57	V

8DPSK Ch 39

Frequency (MHz)	Measurement Result (dB μ V/m)	Cable loss (dB)	Antenna Factor (dB/m)	Receiver Reading (dB μ V)	Limit (dB μ V/m)	Margin (dB)	Antenna Pol. (H/V)
17230.000	40.90	-25.90	44.40	22.50	54.00	13.10	V
13745.000	38.87	-29.10	40.90	27.07	54.00	15.13	V
12997.500	36.68	-30.50	39.20	27.98	54.00	17.32	V
9404.500	35.28	-32.90	37.90	30.28	54.00	18.72	V
7323.500	34.48	-35.10	36.60	32.98	54.00	19.52	H
4881.500	32.00	-37.20	33.20	36.00	54.00	22.00	H

8DPSK Ch 78

Frequency (MHz)	Measurement Result (dB μ V/m)	Cable loss (dB)	Antenna Factor (dB/m)	Receiver Reading (dB μ V)	Limit (dB μ V/m)	Margin (dB)	Antenna Pol. (H/V)
17045.500	40.90	-26.60	43.40	24.10	54.00	13.10	V
13726.000	38.57	-29.10	40.90	26.77	54.00	15.43	V
12400.000	37.51	-31.20	38.90	29.81	54.00	16.49	V
8722.000	35.00	-34.40	38.00	31.40	54.00	19.00	V
7311.500	34.47	-35.00	36.50	32.87	54.00	19.53	V
2491.700	44.76	-20.00	28.30	36.46	54.00	9.24	H

Peak Measurement results
GFSK Ch 0

Frequency (MHz)	Measurement Result (dB μ V/m)	Cable loss (dB)	Antenna Factor (dB/m)	Receiver Reading (dB μ V)	Limit (dB μ V/m)	Margin (dB)	Antenna Pol. (H/V)
17073.500	54.09	-26.60	43.40	37.29	74.00	19.91	H
13723.500	51.38	-29.10	40.90	39.58	74.00	22.62	H
12010.500	50.80	-31.50	39.10	43.20	74.00	23.20	V
7206.000	47.88	-35.50	36.40	46.98	74.00	26.12	H
9824.000	46.71	-33.50	38.00	42.21	74.00	27.29	H
2389.300	56.32	-20.00	28.10	48.32	74.00	17.68	V

GFSK Ch 39

Frequency (MHz)	Measurement Result (dB μ V/m)	Cable loss (dB)	Antenna Factor (dB/m)	Receiver Reading (dB μ V)	Limit (dB μ V/m)	Margin (dB)	Antenna Pol. (H/V)
17361.500	52.59	-25.90	44.40	34.19	74.00	21.41	V
12205.000	50.06	-31.40	39.00	42.46	74.00	23.94	V
13784.500	49.96	-29.10	40.90	38.16	74.00	24.04	V
9485.500	46.16	-33.20	37.90	41.46	74.00	27.84	V
7322.500	45.37	-35.10	36.60	43.87	74.00	28.63	V
4881.500	42.34	-37.20	33.20	46.34	74.00	31.66	H

GFSK Ch 78

Frequency (MHz)	Measurement Result (dB μ V/m)	Cable loss (dB)	Antenna Factor (dB/m)	Receiver Reading (dB μ V)	Limit (dB μ V/m)	Margin (dB)	Antenna Pol. (H/V)
17557.500	52.38	-26.90	45.20	33.98	74.00	21.62	H
12400.500	50.59	-31.20	38.90	42.89	74.00	23.41	V
14235.500	50.55	-29.00	42.00	37.55	74.00	23.45	H
9035.500	46.80	-33.80	38.10	42.40	74.00	27.20	V
6736.000	45.98	-35.50	35.50	45.98	74.00	28.02	V
2486.800	57.23	-20.00	28.30	48.93	74.00	16.77	H

$\pi/4$ DQPSK Ch 0

Frequency (MHz)	Measurement Result (dB μ V/m)	Cable loss (dB)	Antenna Factor (dB/m)	Receiver Reading (dB μ V)	Limit (dB μ V/m)	Margin (dB)	Antenna Pol. (H/V)
17900.000	52.92	-25.50	46.70	31.72	74.00	21.08	H
14255.000	49.86	-28.40	42.30	35.96	74.00	24.14	V
12865.500	48.10	-30.70	39.10	39.60	74.00	25.90	V
8735.500	47.12	-34.40	38.00	43.52	74.00	26.88	V
7313.500	46.21	-35.00	36.50	44.61	74.00	27.79	H
2317.000	56.07	-20.10	27.90	48.17	74.00	17.93	V

 $\pi/4$ DQPSK Ch 39

Frequency (MHz)	Measurement Result (dB μ V/m)	Cable loss (dB)	Antenna Factor (dB/m)	Receiver Reading (dB μ V)	Limit (dB μ V/m)	Margin (dB)	Antenna Pol. (H/V)
16963.500	52.66	-26.30	42.40	36.66	74.00	21.34	H
13715.500	49.90	-29.10	40.90	38.10	74.00	24.10	V
12926.500	48.04	-30.50	39.20	39.34	74.00	25.96	H
8917.000	46.24	-33.50	38.10	41.64	74.00	27.76	V
7145.000	45.92	-35.40	36.30	45.02	74.00	28.08	V
4794.000	41.23	-37.30	33.00	45.43	74.00	32.77	V

 $\pi/4$ DQPSK Ch 78

Frequency (MHz)	Measurement Result (dB μ V/m)	Cable loss (dB)	Antenna Factor (dB/m)	Receiver Reading (dB μ V)	Limit (dB μ V/m)	Margin (dB)	Antenna Pol. (H/V)
17129.500	52.61	-26.60	43.40	35.81	74.00	21.39	V
13716.000	50.09	-29.10	40.90	38.29	74.00	23.91	V
12992.000	48.04	-30.50	39.20	39.34	74.00	25.96	H
9489.500	47.89	-33.20	37.90	43.19	74.00	26.11	V
6836.000	46.11	-35.50	35.80	45.71	74.00	27.89	H
2499.900	56.02	-20.00	28.40	47.62	74.00	17.98	V

8DPSK Ch 0

Frequency (MHz)	Measurement Result (dBμV/m)	Cable loss (dB)	Antenna Factor (dB/m)	Receiver Reading (dBμV)	Limit (dBμV/m)	Margin (dB)	Antenna Pol. (H/V)
17245.500	52.59	-25.90	44.40	34.19	74.00	21.41	H
14202.500	50.21	-29.00	42.00	37.21	74.00	23.79	H
11908.000	48.17	-31.80	39.00	40.97	74.00	25.83	H
8996.500	46.95	-33.30	38.20	42.05	74.00	27.05	V
7594.500	45.83	-35.00	36.90	44.03	74.00	28.17	V
2381.400	56.48	-20.00	28.10	48.48	74.00	17.52	H

8DPSK Ch 39

Frequency (MHz)	Measurement Result (dBμV/m)	Cable loss (dB)	Antenna Factor (dB/m)	Receiver Reading (dBμV)	Limit (dBμV/m)	Margin (dB)	Antenna Pol. (H/V)
17058.000	52.70	-26.60	43.40	35.90	74.00	21.30	V
13684.000	50.20	-29.50	40.40	39.30	74.00	23.80	V
12990.000	48.08	-30.50	39.20	39.38	74.00	25.92	H
9917.500	46.47	-33.50	38.10	41.87	74.00	27.53	H
7308.000	46.07	-35.00	36.50	44.47	74.00	27.93	H
4623.000	42.02	-37.30	32.70	46.72	74.00	31.98	V

8DPSK Ch 78

Frequency (MHz)	Measurement Result (dBμV/m)	Cable loss (dB)	Antenna Factor (dB/m)	Receiver Reading (dBμV)	Limit (dBμV/m)	Margin (dB)	Antenna Pol. (H/V)
17662.000	52.68	-25.70	46.00	32.48	74.00	21.32	H
13743.000	50.42	-29.10	40.90	38.62	74.00	23.58	V
12401.000	47.83	-31.20	38.90	40.13	74.00	26.17	V
9411.000	46.60	-32.90	37.90	41.60	74.00	27.40	V
7535.000	45.28	-34.50	36.80	42.98	74.00	28.72	V
2485.700	56.27	-20.00	28.30	47.97	74.00	17.73	H

Conclusion: PASS

Sample calculation: 17662.000MHz

$$\text{Peak ERP(dBm)} = P_{\text{Mea}}(32.48\text{dBuV/m}) + \text{Cable Loss}(-25.70) + \text{Antenna Factor}(46.00) = 52.68 \text{ dBuV/m}$$

WOSRT CASE 18GHz-26.5 GHz

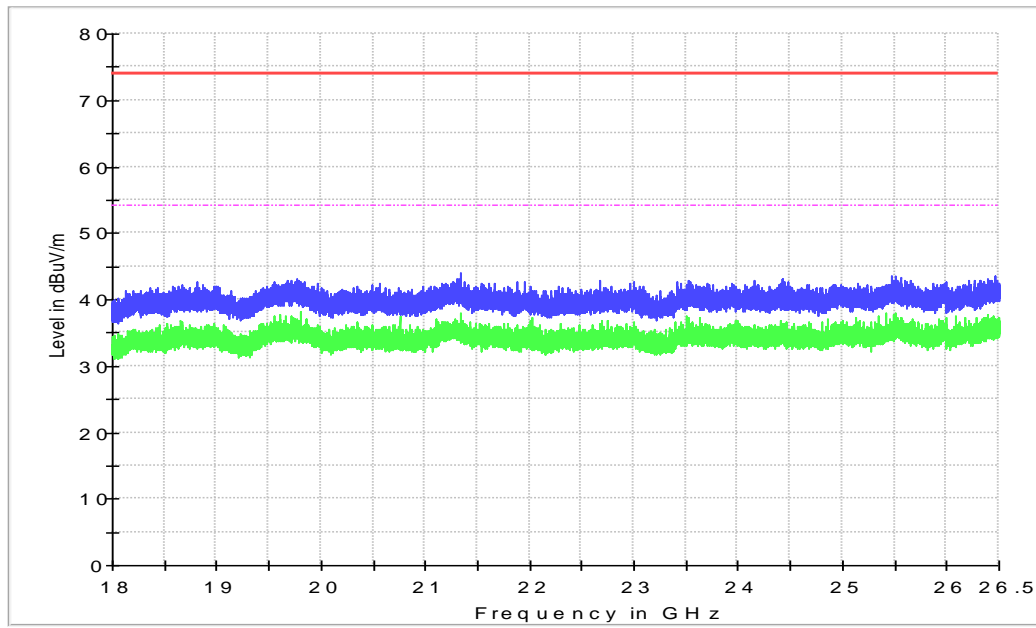

WOSRT CASE BELOW 1GHz

- FCC Part 15C 30-1G Limit
- Peak Preview Result
- ◆ Final Result QPK

RE FCC_30MHz-1GHz_10m_Direct_testing_FP5b

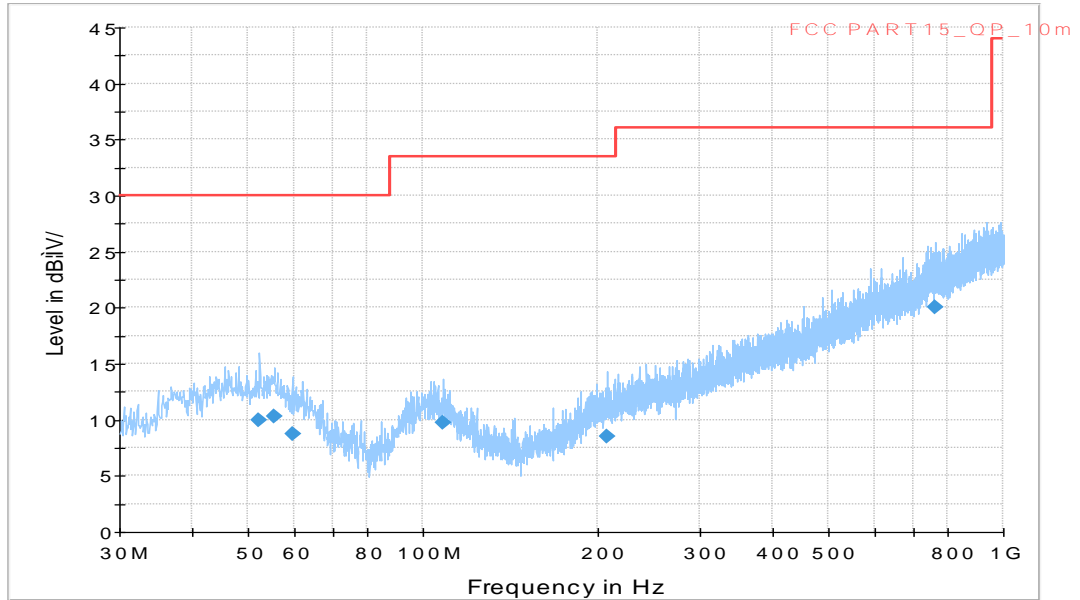

Frequency (MHz)	QuasiPeak (dBuV/m)	Height (cm)	Polarization	Azimuth (deg)	Corr. (dB)	Margin (dB)	Limit (dBuV/m)
52.213000	9.9	125.0	H	93.0	-11.2	20.1	30.0
55.414000	10.3	175.0	V	45.0	-11.3	19.7	30.0
59.585000	8.7	275.0	H	-10.0	-11.9	21.3	30.0
108.279000	9.7	100.0	V	225.0	-12.6	23.8	33.5
207.995000	8.5	175.0	H	225.0	-11.5	25.0	33.5
764.678000	20.0	225.0	V	135.0	1.9	16.0	36.0

BELOW 30MHz

No emissions were found within 20dB of the limit below 30MHz.

B.7. Time of Occupancy (Dwell Time)

Method of Measurement: See ANSI C63.10-clause 7.8.4

The EUT must have its hopping function enabled. Use the following spectrum analyzer settings:

- Span = zero span, centered on a hopping channel
- RBW = 1 MHz
- VBW \geq RBW
- Sweep = as necessary to capture the entire dwell time per hopping channel
- Detector function = peak
- Trace = max hold

Measure a pulse time in time domain at middle frequency and then count the hopping number in 31.6s(which equals with 0.4 multiply 79) of middle frequency ,then multiply the pulse time and hopping number and record them.

Measurement Limit:

Standard	Limit (ms)
FCC 47 CFR Part 15.247(a) (1)(iii)	< 400

Measurement Result:

For GFSK

Channel	Packet	Pulse time (ms)		Number of Transmissions		Dwell Time (ms)	Conclusion
		Fig.	Value	Fig.	Value		
39	DH1	Fig.72	0.38	Fig.73	320	121.6	P
	DH3	Fig.74	1.64	Fig.75	103	168.92	P
	DH5	Fig.76	2.89	Fig.77	70	202.3	P

For $\pi/4$ DQPSK

Channel	Packet	Pulse time (ms)		Number of Transmissions		Dwell Time (ms)	Conclusion
		Fig.	Value	Fig.	Value		
39	2DH1	Fig.78	0.39	Fig.79	318	124.02	P
	2DH3	Fig.80	1.64	Fig.81	113	185.32	P
	2DH5	Fig.82	2.89	Fig.83	70	202.3	P

For 8DPSK

Channel	Packet	Pulse time (ms)		Number of Transmissions		Dwell Time (ms)	Conclusion
		Fig.	ms	Fig.	Count		
39	3DH1	Fig.84	0.39	Fig.85	318	124.02	P
	3DH3	Fig.86	1.64	Fig.87	101	165.64	P
	3DH5	Fig.88	2.89	Fig.89	64	184.96	P

Conclusion: PASS

Test graphs as below:

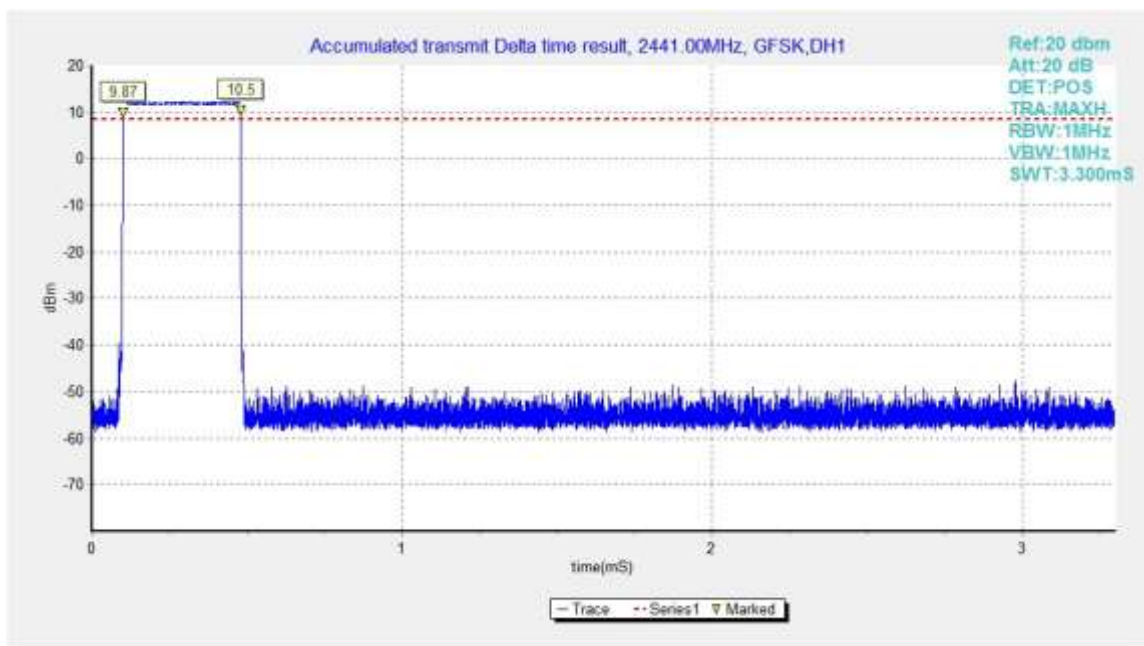

Fig.72. Time of occupancy (Dwell Time): Channel 39, Packet DH1

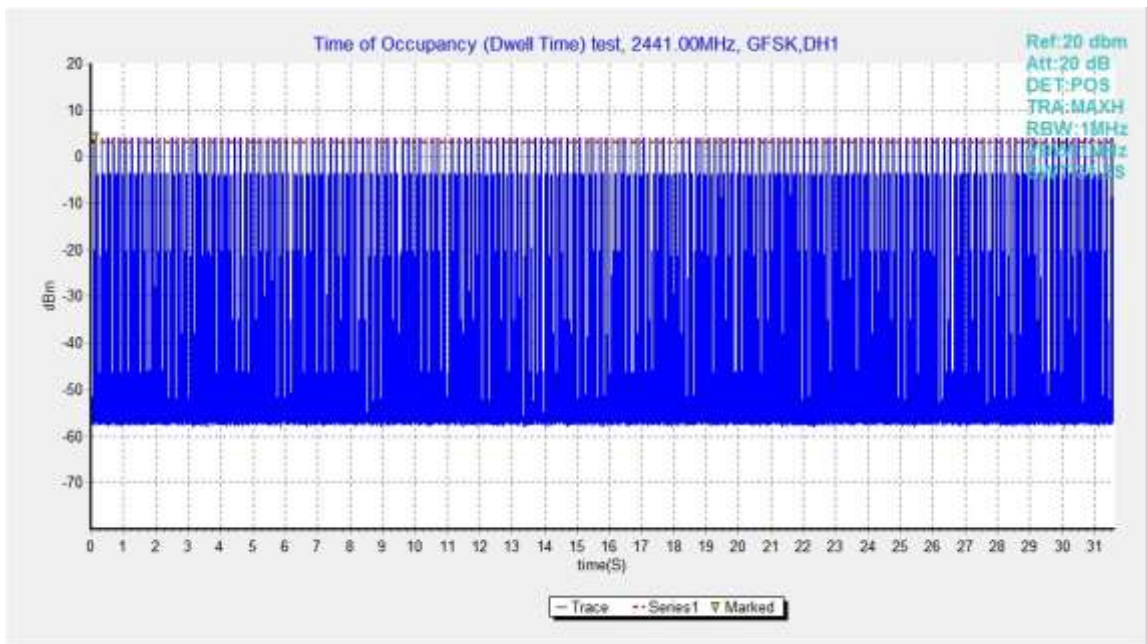

Fig.73. Number of Transmissions Measurement: Channel 39,Packet DH1

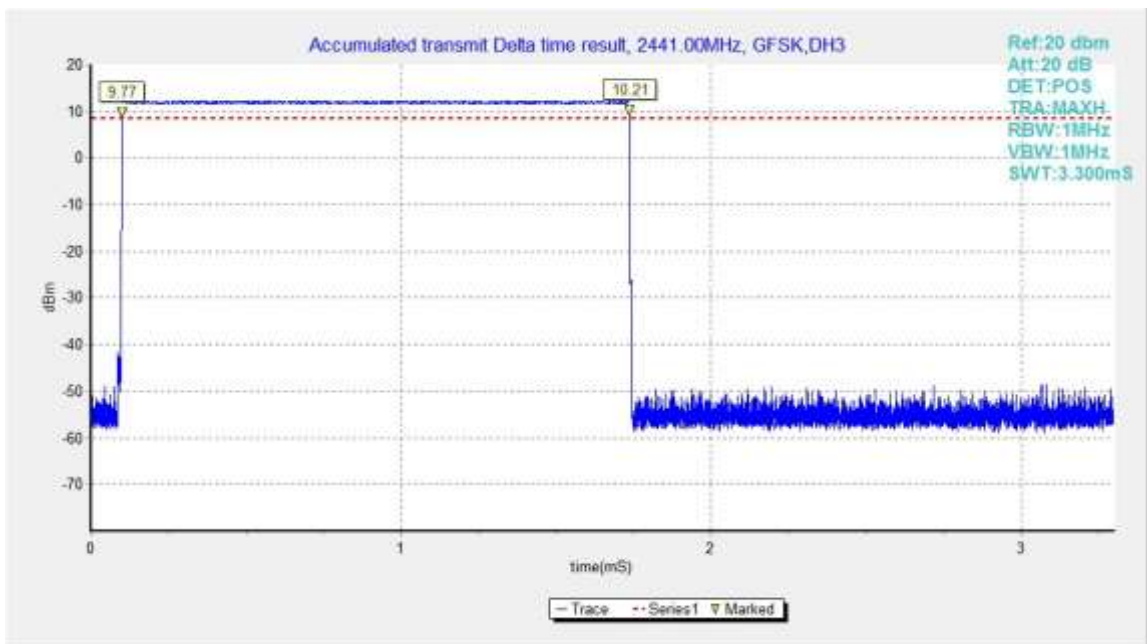

Fig.74. Time of occupancy (Dwell Time): Channel 39, Packet DH3

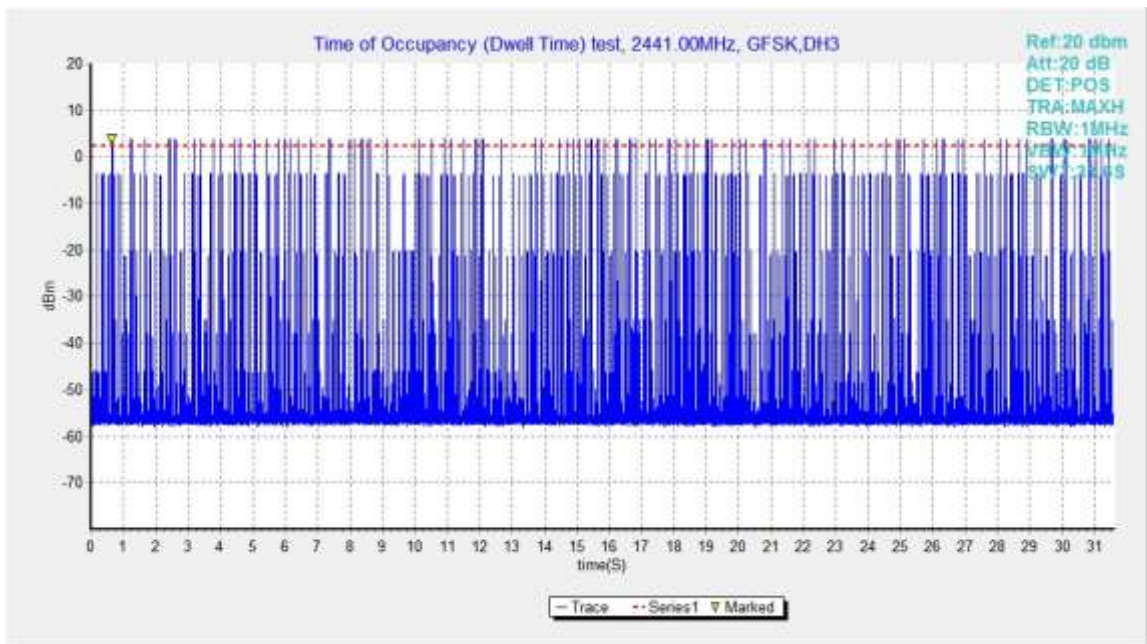

Fig.75. Number of Transmissions Measurement: Channel 39,Packet DH3

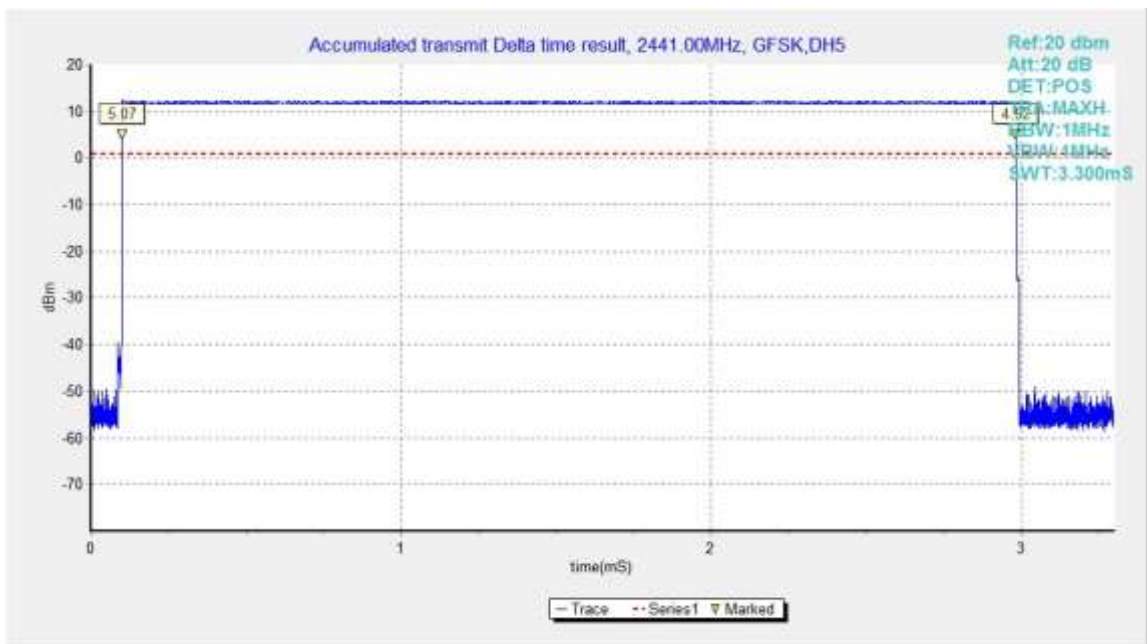

Fig.76. Time of occupancy (Dwell Time): Channel 39, Packet DH5

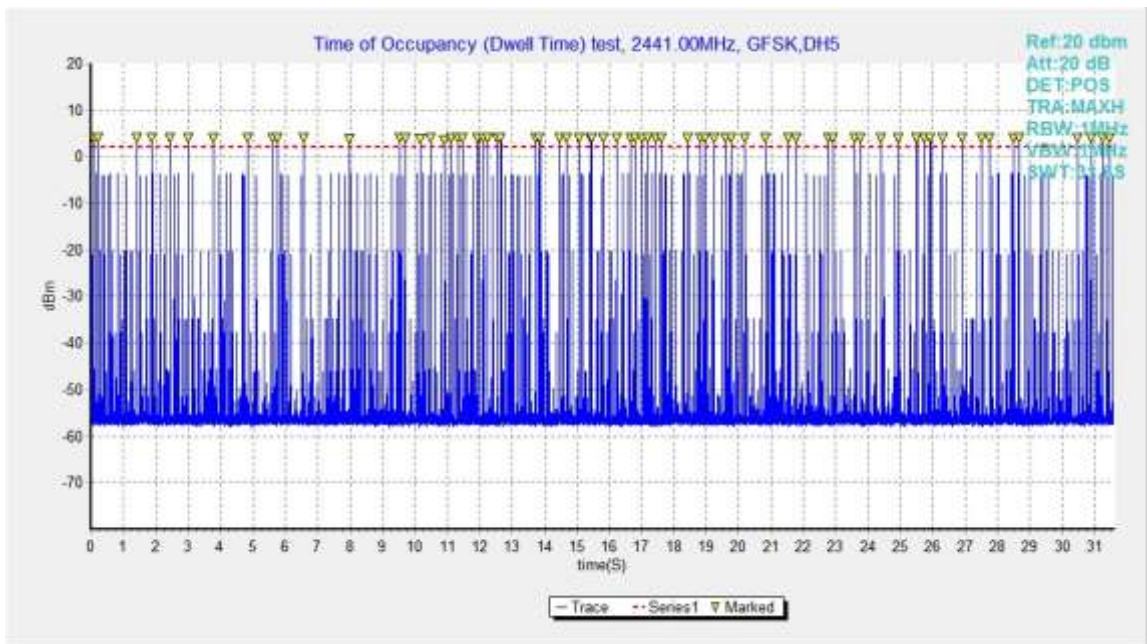

Fig.77. Number of Transmissions Measurement: Channel 39,Packet DH5

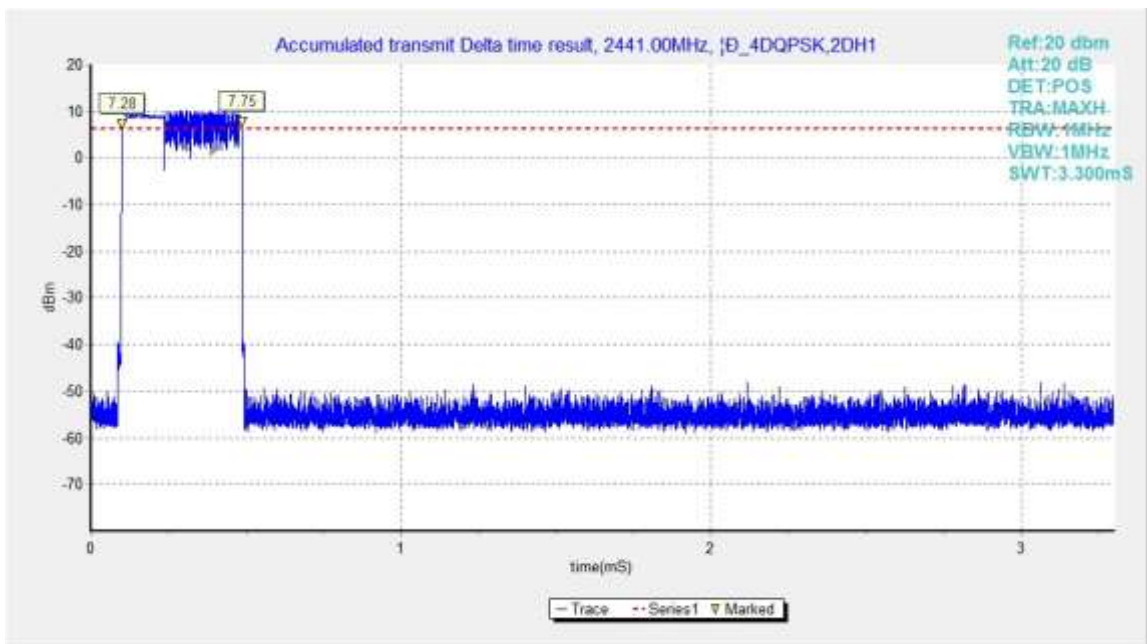

Fig.78. Time of occupancy (Dwell Time): Channel 39, Packet 2-DH1

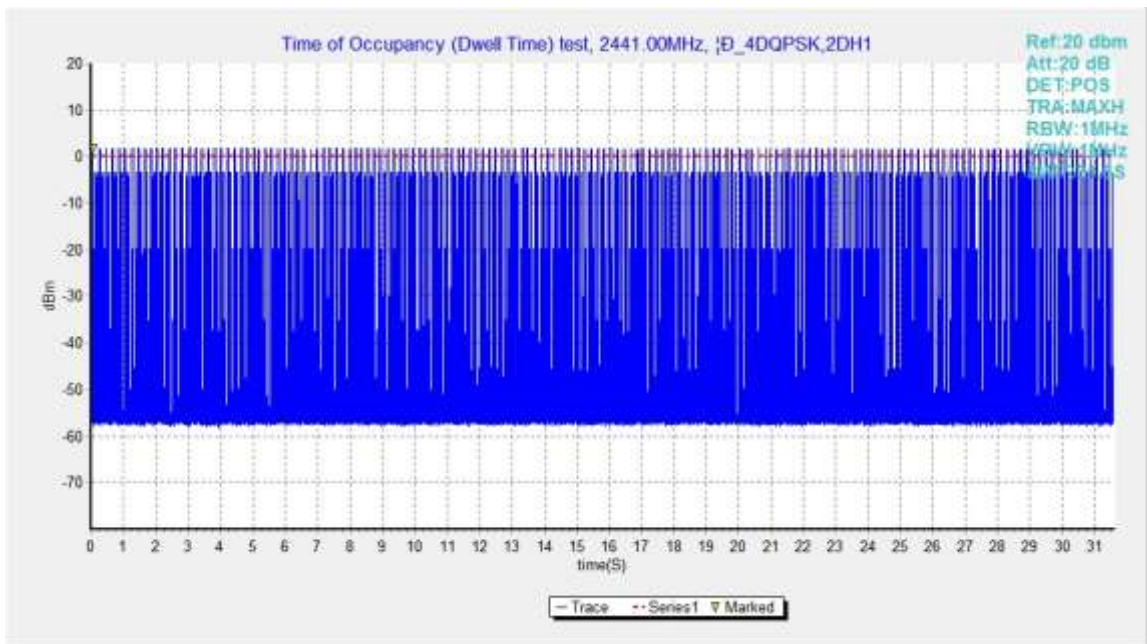

Fig.79. Number of Transmissions Measurement: Channel 39,Packet 2-DH1

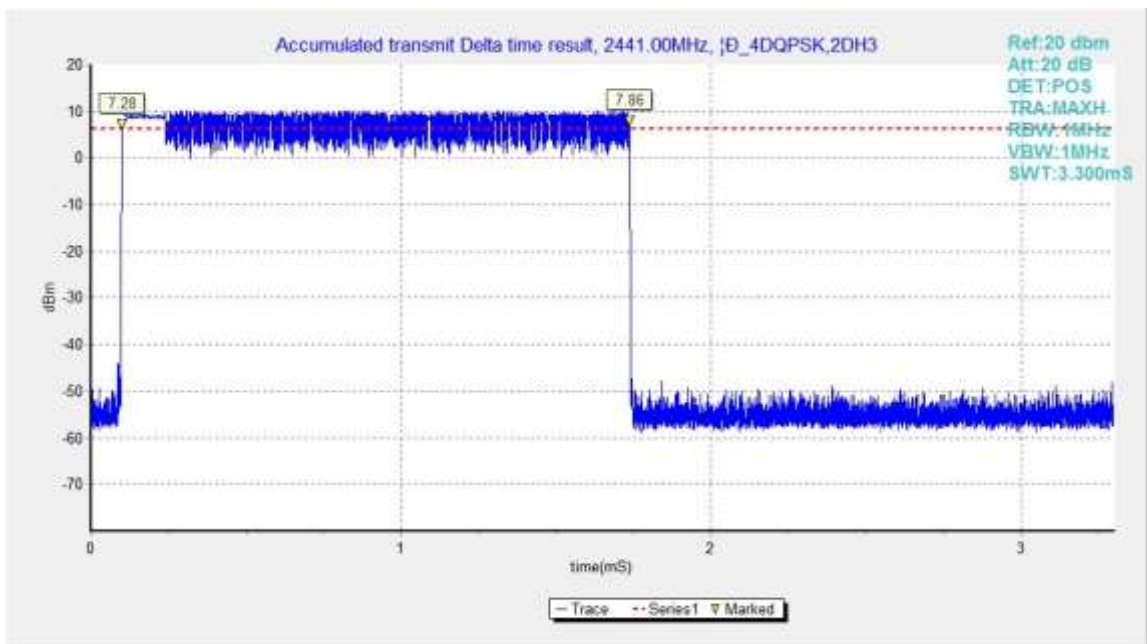

Fig.80. Time of occupancy (Dwell Time): Channel 39, Packet 2-DH3

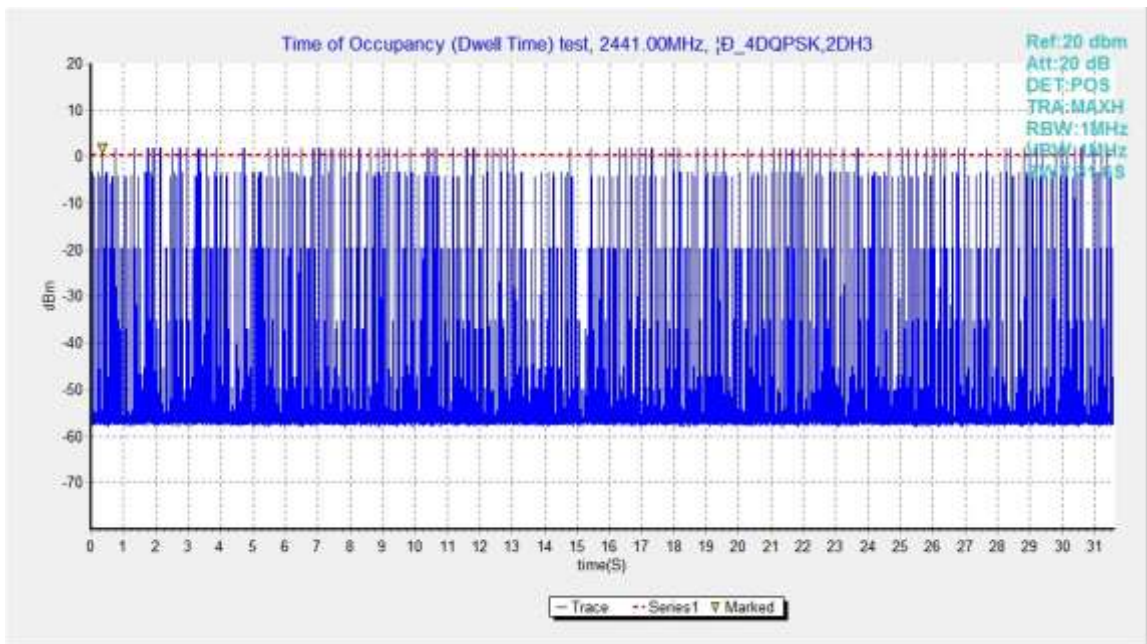

Fig.81. Number of Transmissions Measurement: Channel 39,Packet 2-DH3

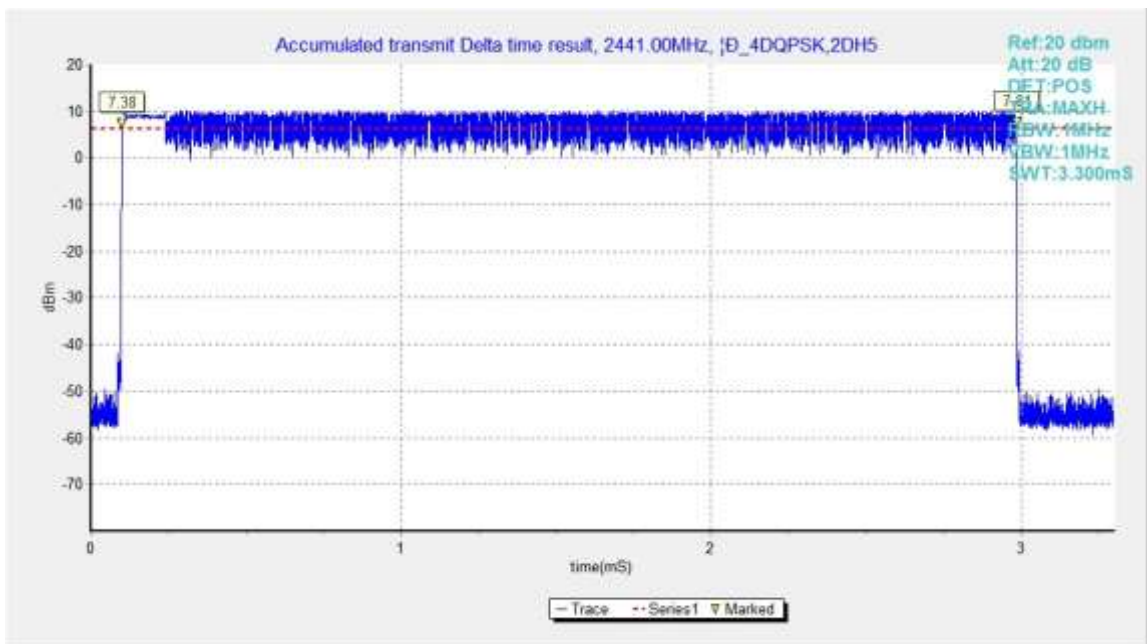

Fig.82. Time of occupancy (Dwell Time): Channel 39, Packet 2-DH5

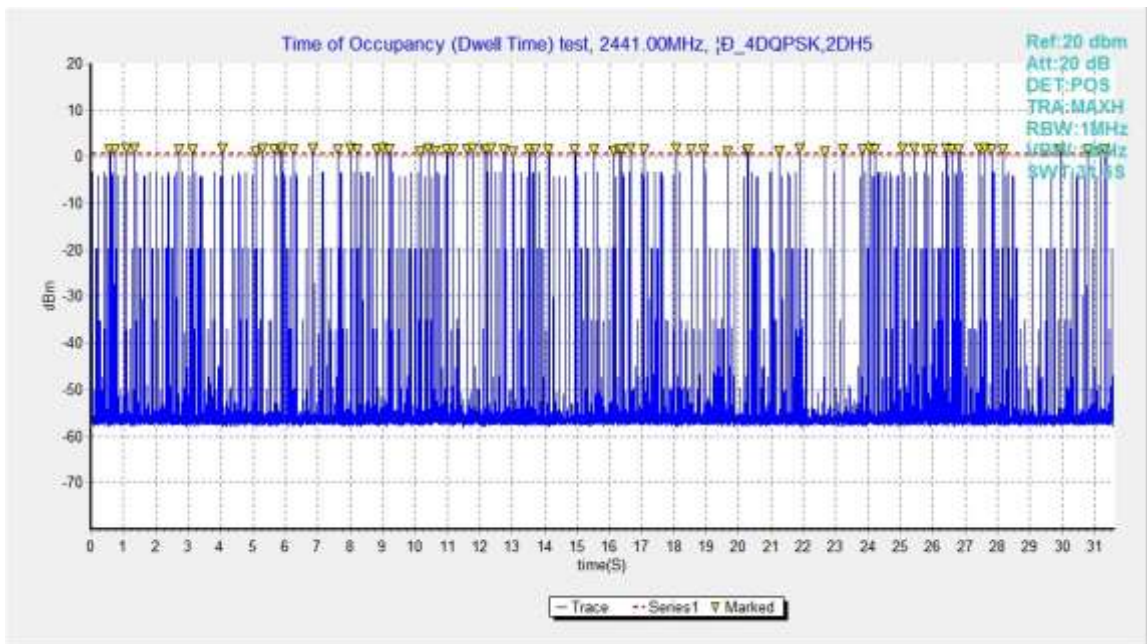

Fig.83. Number of Transmissions Measurement: Channel 39,Packet 2-DH5

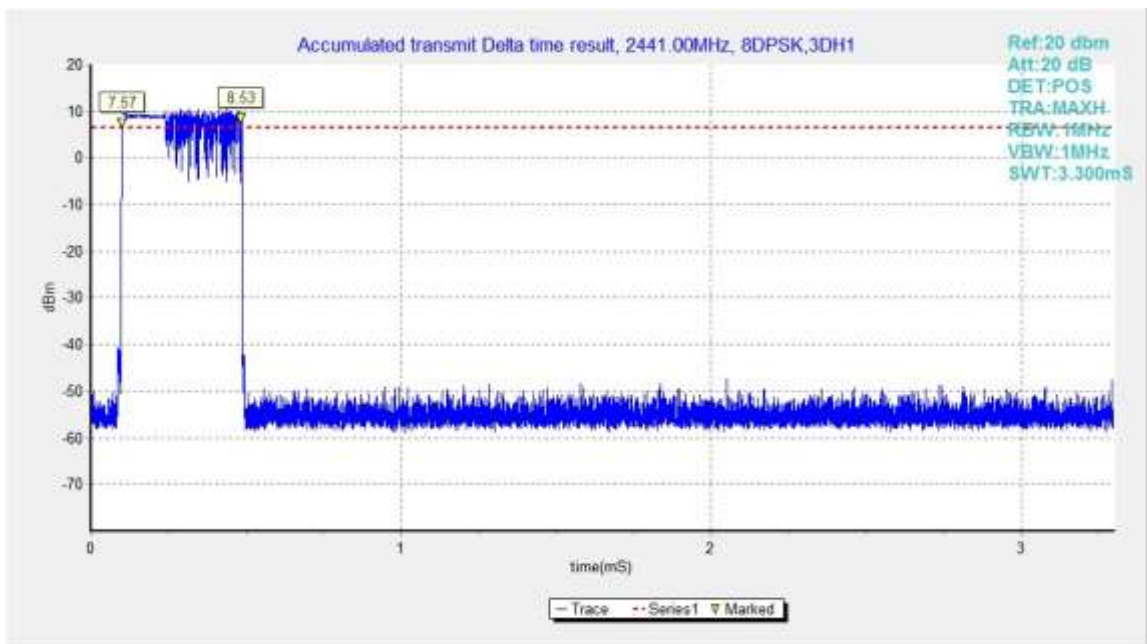

Fig.84. Time of occupancy (Dwell Time): Channel 39, Packet 3-DH1

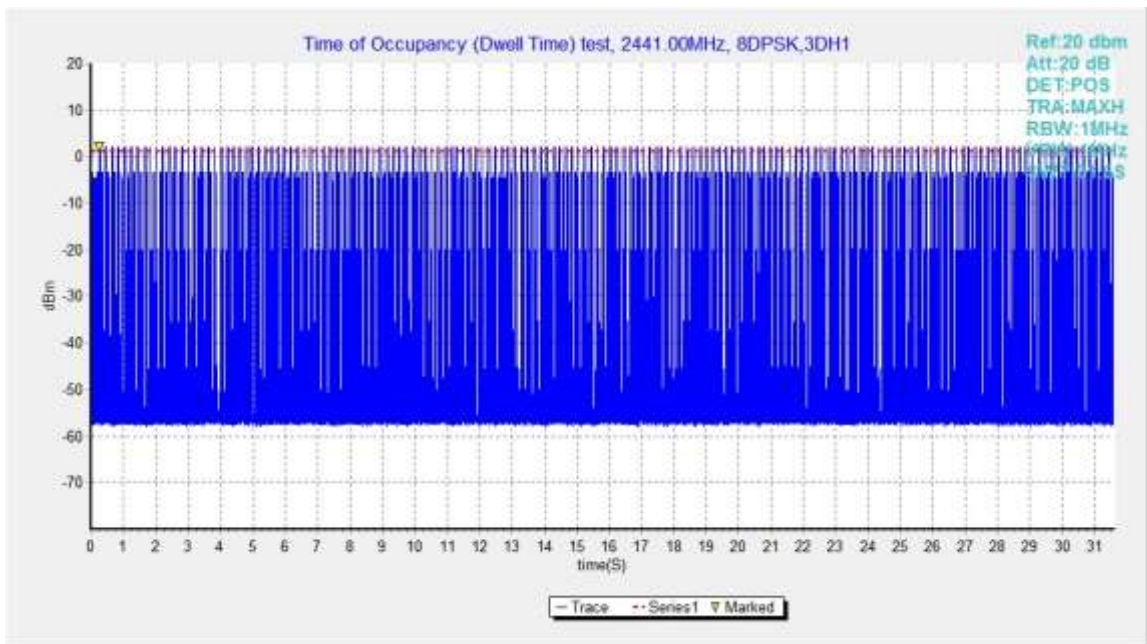

Fig.85. Number of Transmissions Measurement: Channel 39,Packet 3-DH1

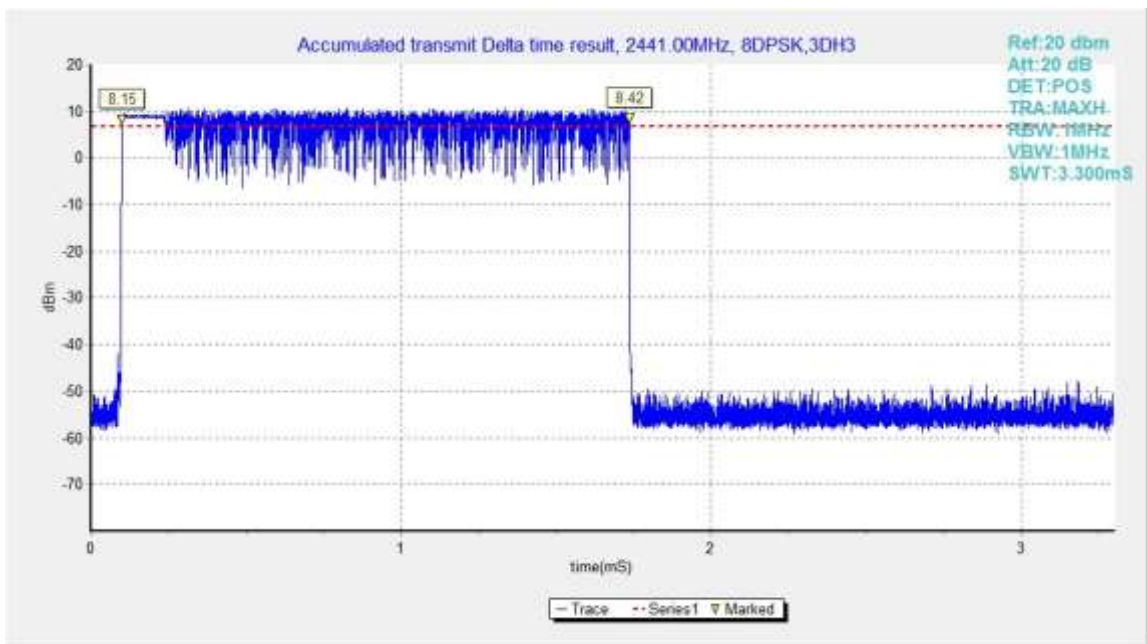

Fig.86. Time of occupancy (Dwell Time): Channel 39, Packet 3-DH3

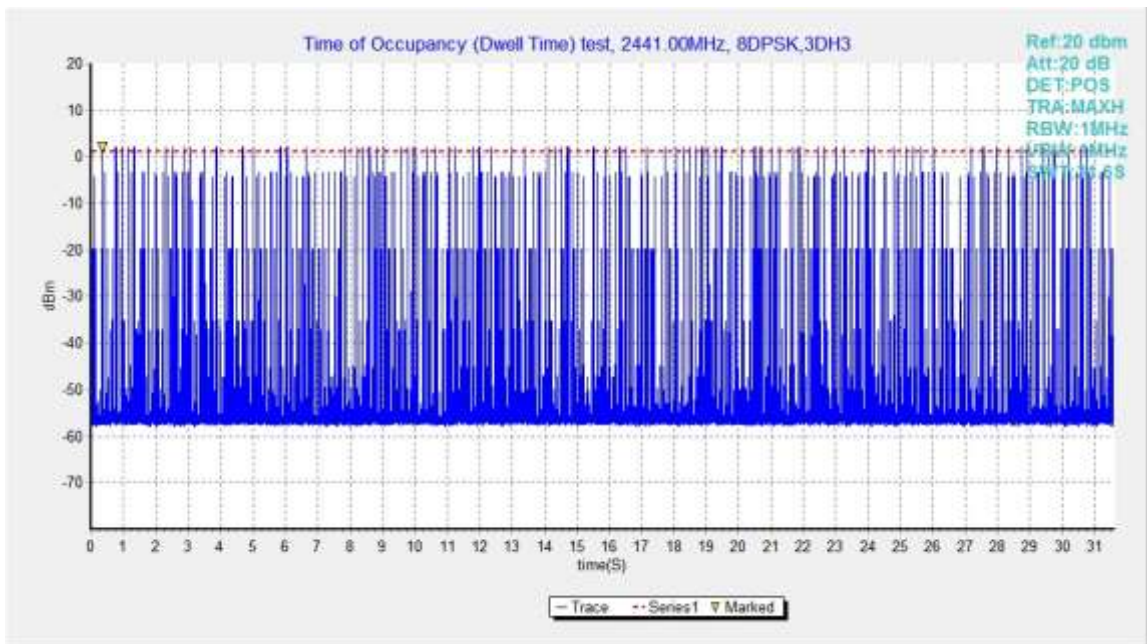

Fig.87. Number of Transmissions Measurement: Channel 39,Packet 3-DH3

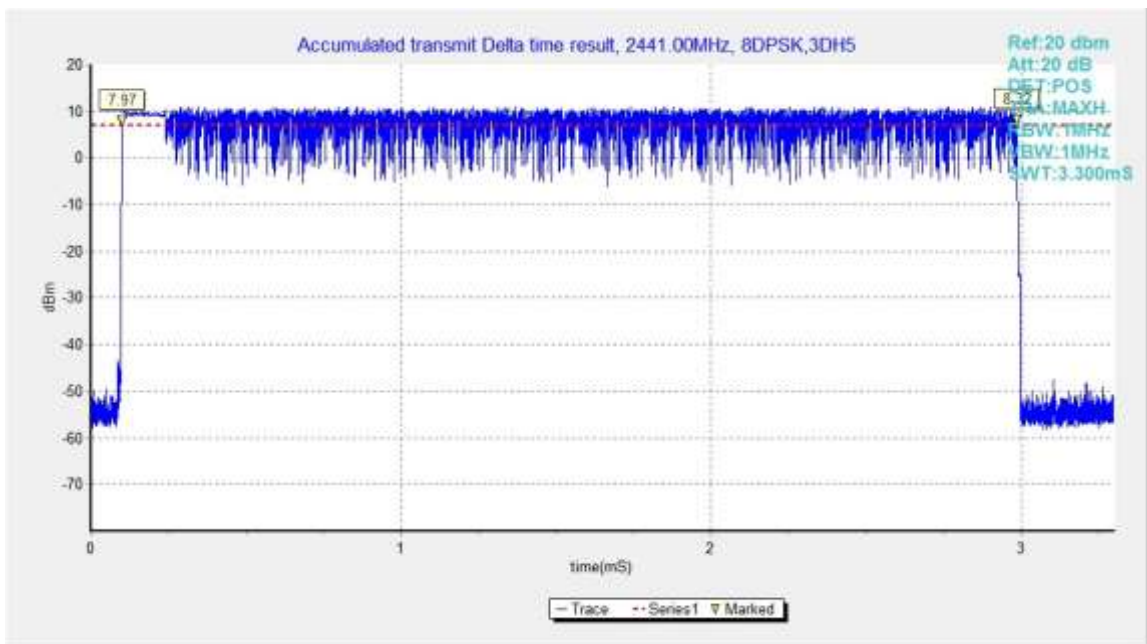

Fig.88. Time of occupancy (Dwell Time): Channel 39, Packet 3-DH5

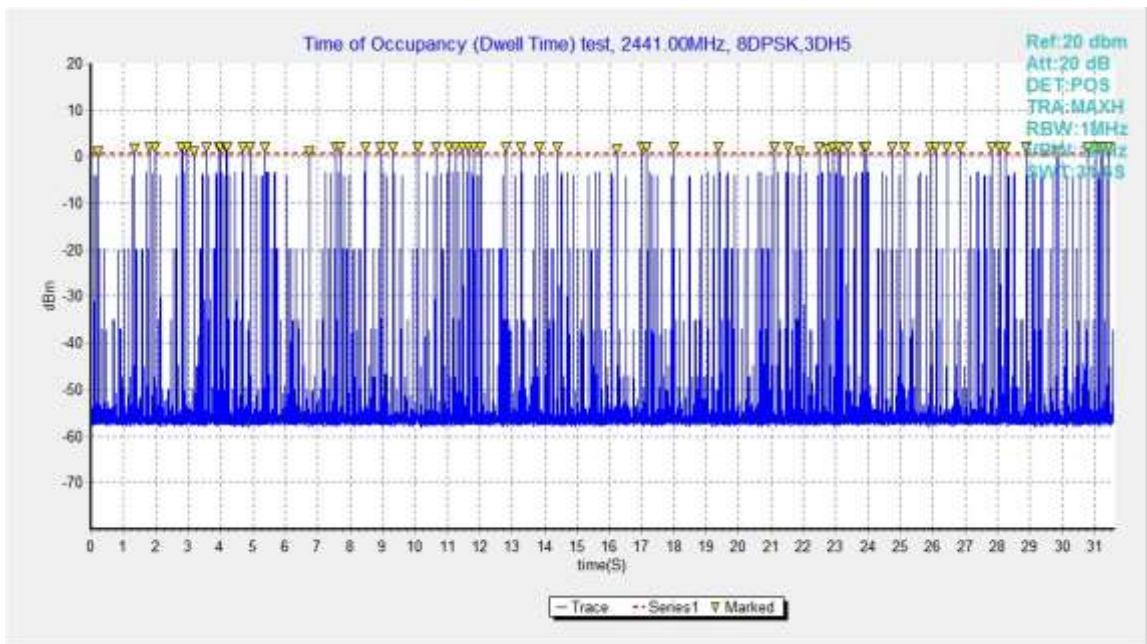

Fig.89. Number of Transmissions Measurement: Channel 39,Packet 3-DH5

B.8. 20dB Bandwidth

Method of Measurement: See ANSI C63.10-clause 6.9.2

Measurement Procedure - Unwanted Emissions

1. Set RBW = 30kHz.
2. Set VBW = 100 kHz.
3. Set span to 3MHz
4. Detector = peak.
5. Trace Mode = max hold.
6. Sweep = auto couple.
7. Allow the trace to stabilize (this may take some time, depending on the extent of the span).

Measurement Limit:

Standard	Limit
FCC 47 CFR Part 15.247(a)(1)	NA *

Use NdB Down function of the SA to measure the 20dB Bandwidth

* Comment: This test case is not required according to the latest FCC 47 CFR Part 15.247. But the test results are necessary for “carrier frequency separation” test case, in Annex A.8.

Measurement Results:

For GFSK

Channel	20dB Bandwidth (kHz)		Conclusion
0	Fig.90	922.50	NA
39	Fig.91	922.50	NA
78	Fig.92	921.75	NA

For $\pi/4$ DQPSK

Channel	20dB Bandwidth (kHz)		Conclusion
0	Fig.93	1289.25	NA
39	Fig.94	1306.50	NA
78	Fig.95	1310.25	NA

For 8DPSK

Channel	20dB Bandwidth (kHz)		Conclusion
0	Fig.96	1299.75	NA
39	Fig.97	1296.00	NA
78	Fig.98	1298.25	NA

Conclusion: NA

Test graphs as below:

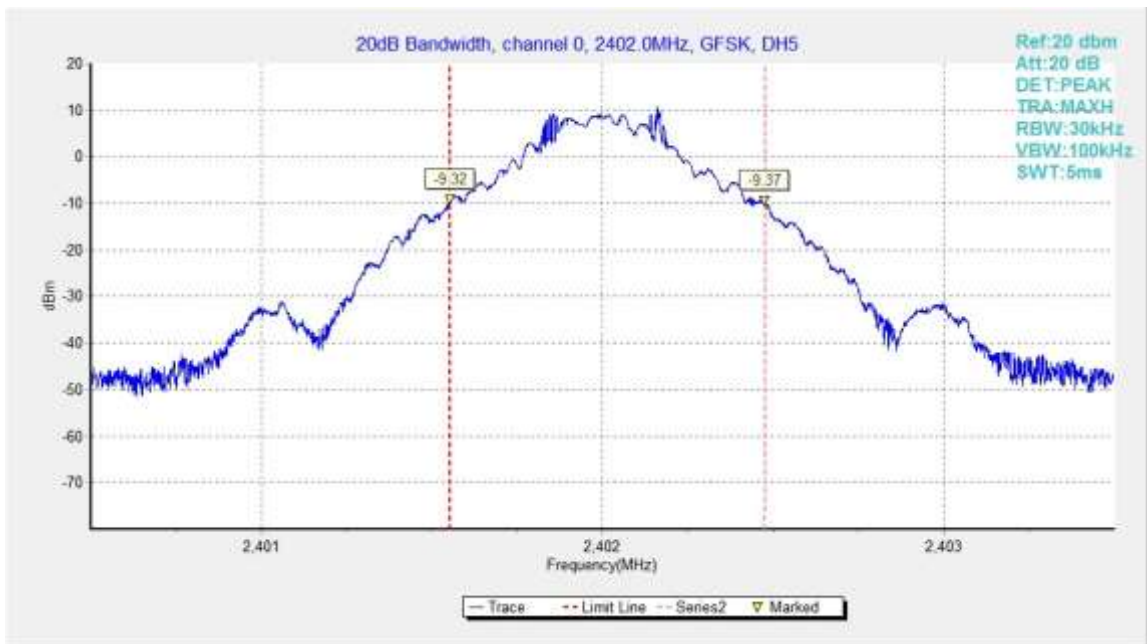

Fig.90. 20dB Bandwidth: GFSK, Channel 0

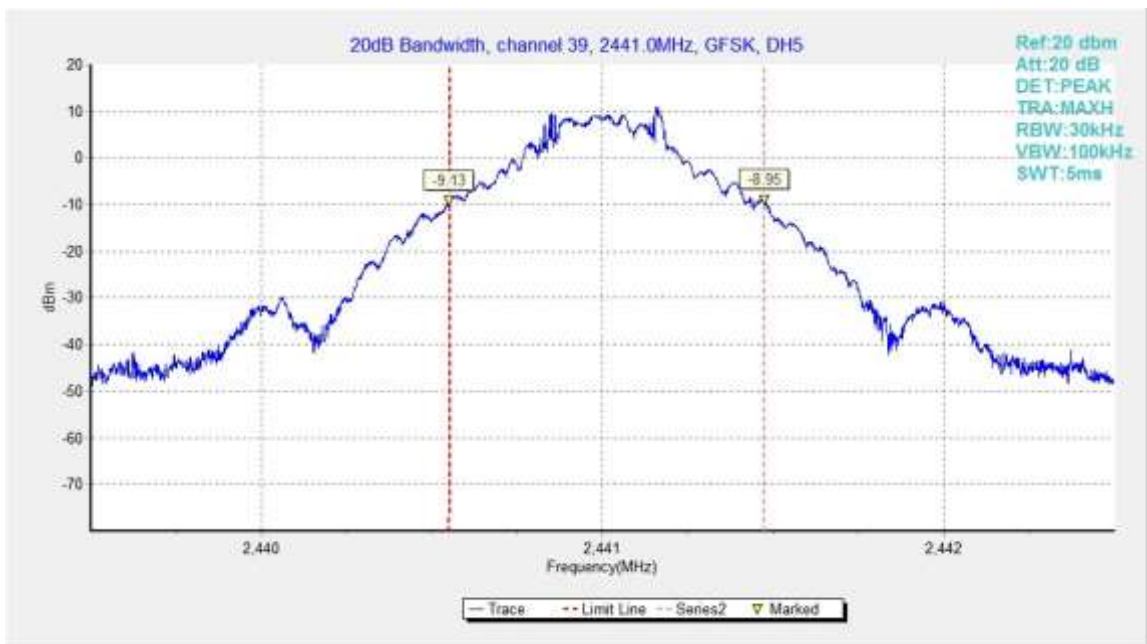

Fig.91. 20dB Bandwidth: GFSK, Channel 39

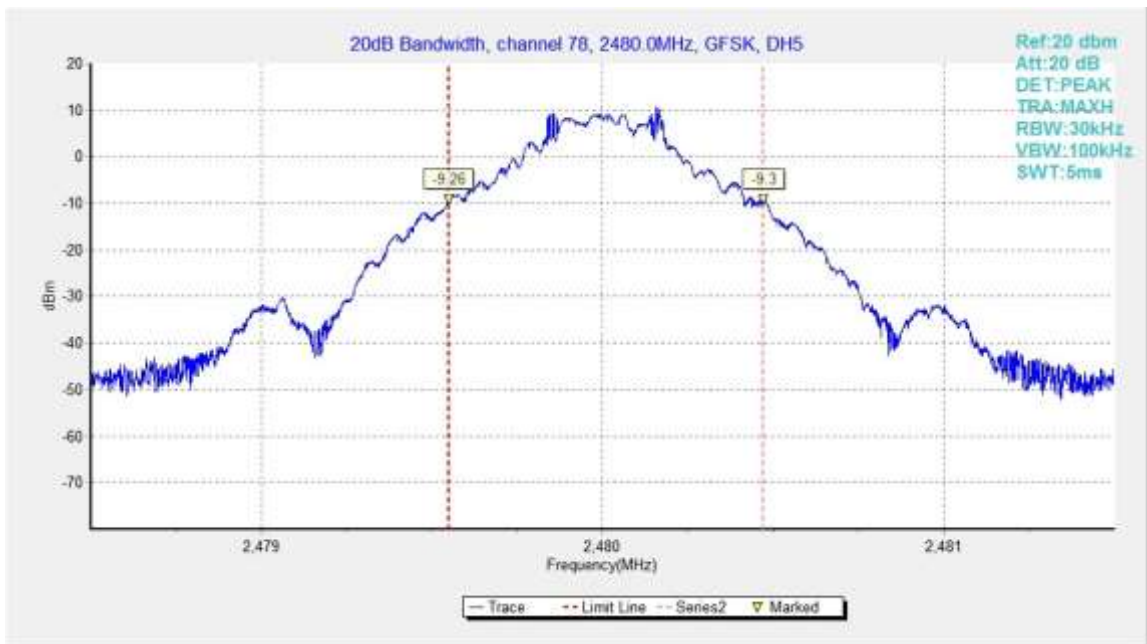

Fig.92. 20dB Bandwidth: GFSK, Channel 78

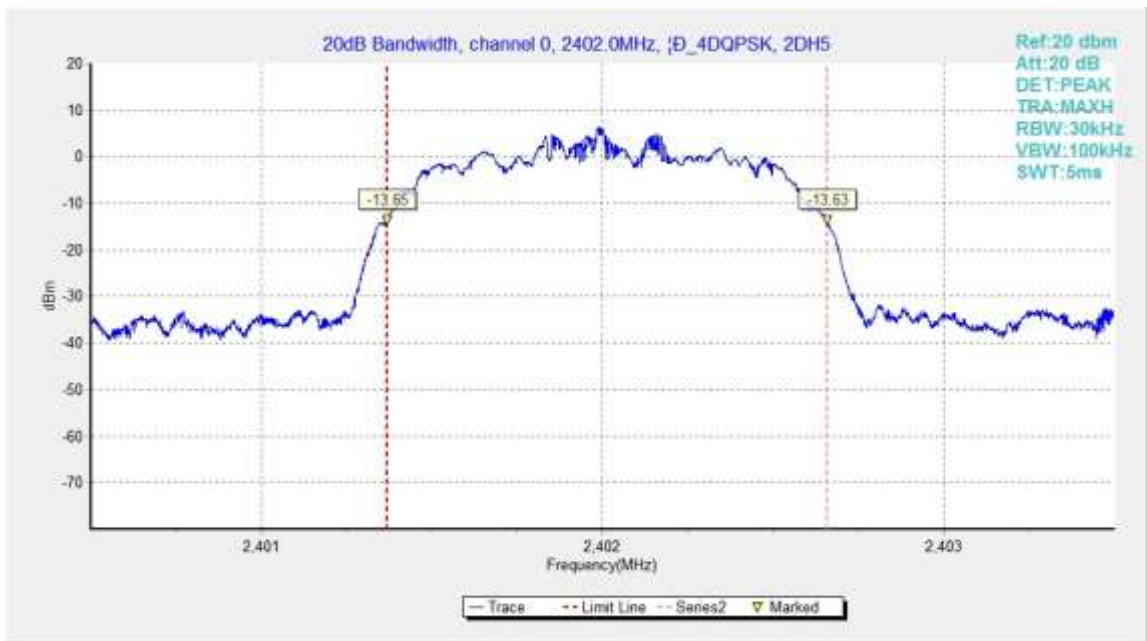

Fig.93. 20dB Bandwidth: $\pi/4$ DQPSK, Channel 0

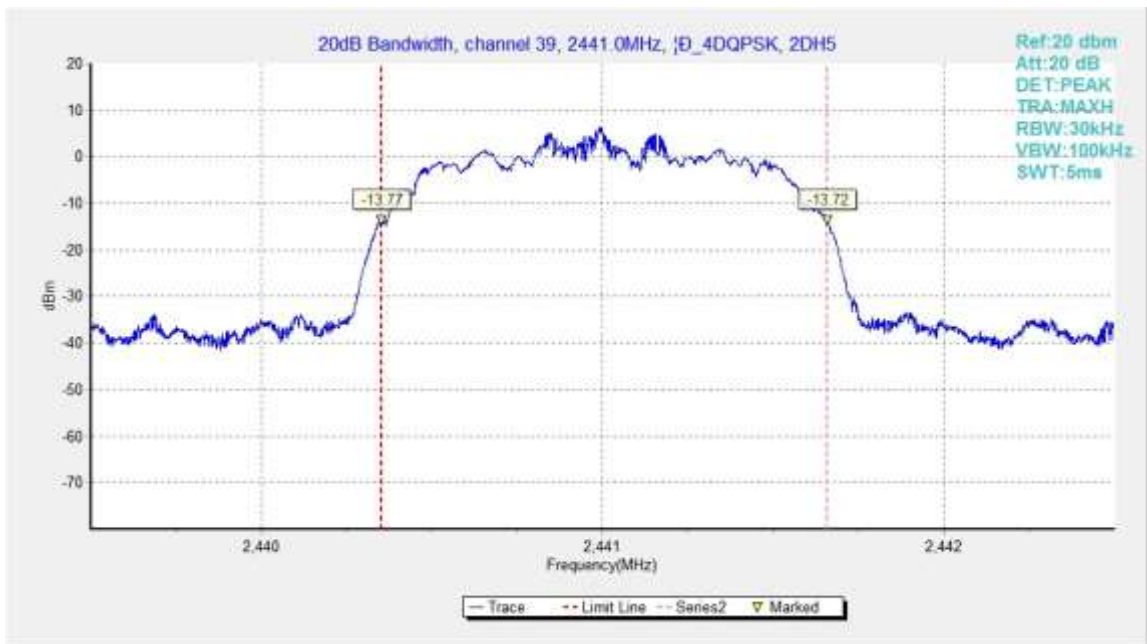

Fig.94. 20dB Bandwidth: $\pi/4$ DQPSK, Channel 39

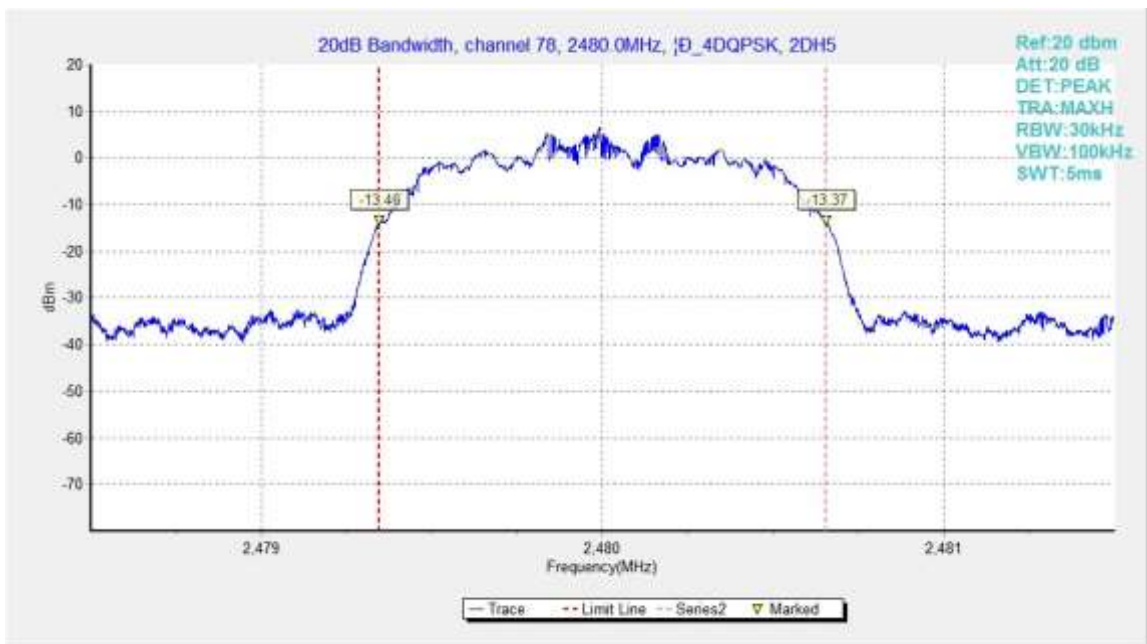

Fig.95. 20dB Bandwidth: $\pi/4$ DQPSK, Channel 78

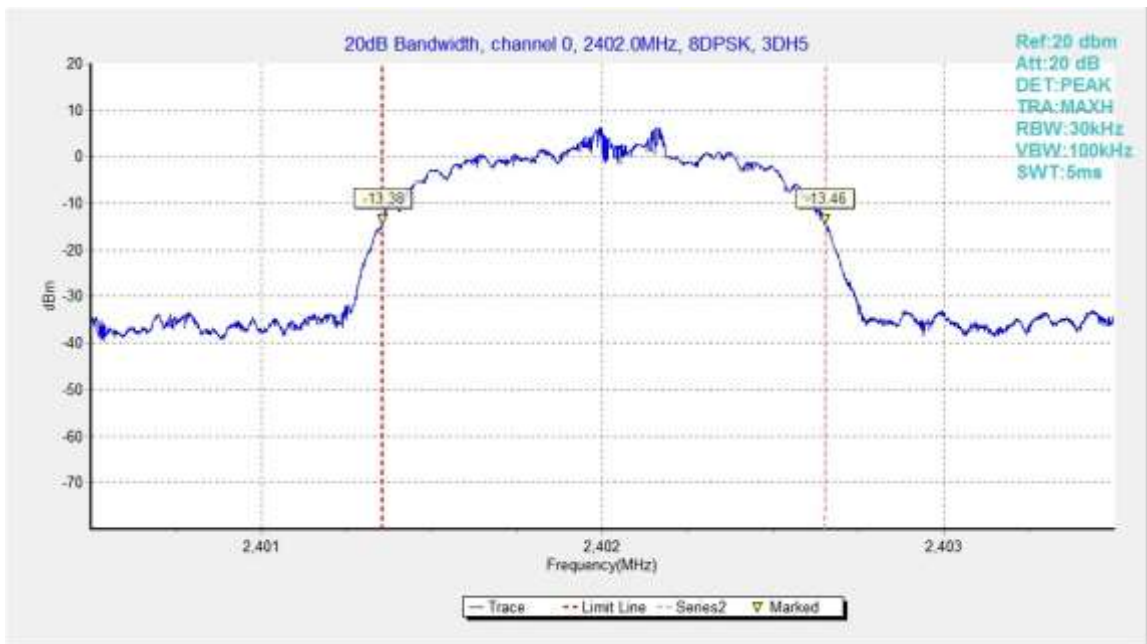

Fig.96. 20dB Bandwidth: 8DPSK, Channel 0

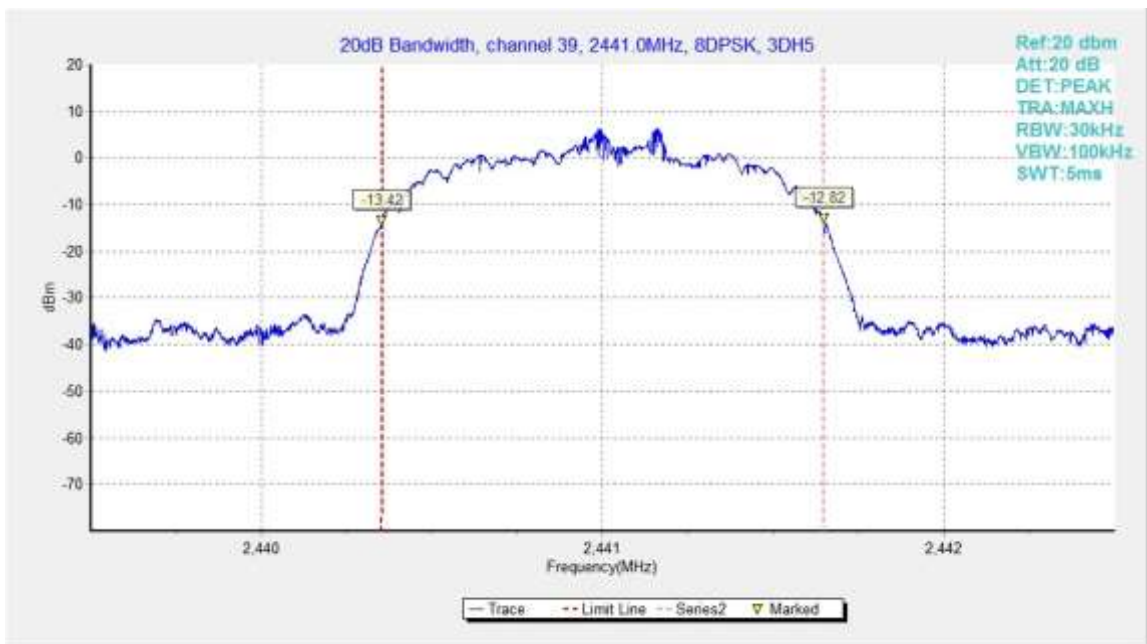

Fig.97. 20dB Bandwidth: 8DPSK, Channel 39

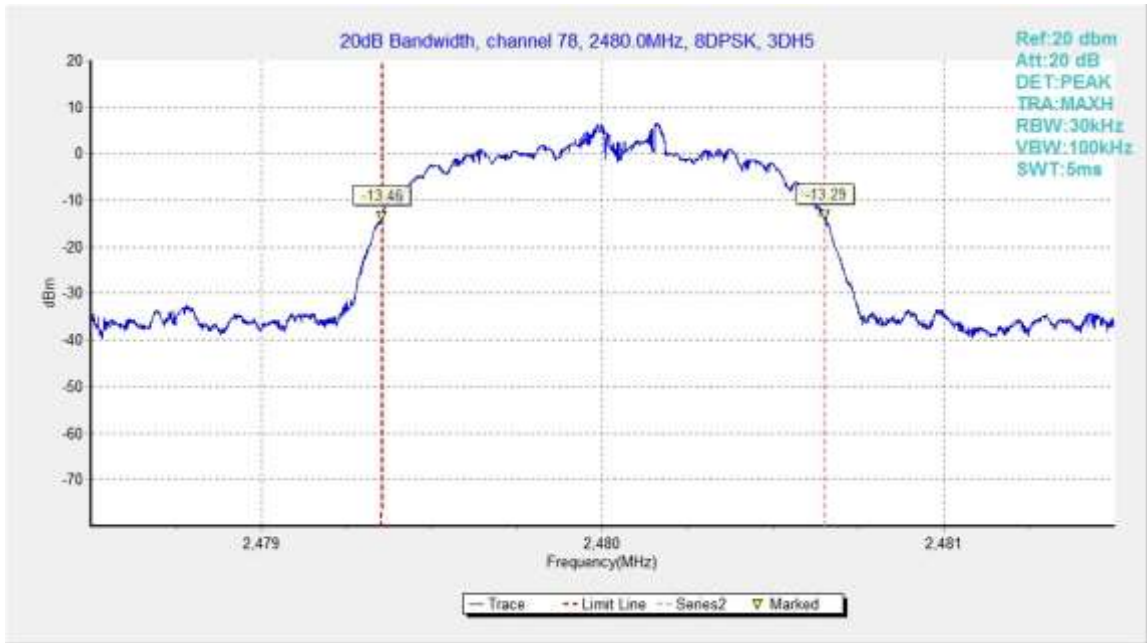

Fig.98. 20dB Bandwidth: 8DPSK, Channel 78

B.9. Carrier Frequency Separation

Method of Measurement: See ANSI C63.10-clause 7.8.2

The EUT must have its hopping function enabled. Use the following spectrum analyzer settings:

- Span = 3MHz
- RBW=300kHz
- VBW=300kHz
- Sweep = auto
- Detector function = peak
- Trace = max hold
- Allow the trace to stabilize

Search the peak marks of the middle frequency and adjacent channel, then record the separation between them.

* Comment: This limit should be over 25 kHz or $(2/3) * 20\text{dB}$ bandwidth, whichever is greater.

Measurement Limit:

Standard	Limit(kHz)
FCC 47 CFR Part 15.247(a)(1)	over 25 kHz or $(2/3) * 20\text{dB}$ bandwidth

Measurement Result:

For GFSK

Channel	Carrier frequency separation (kHz)		Conclusion
39	Fig.99	986.25	P

For $\pi/4$ DQPSK

Channel	Carrier frequency separation (kHz)		Conclusion
39	Fig.100	978.00	P

For 8DPSK

Channel	Carrier frequency separation (kHz)		Conclusion
39	Fig.101	999.00	P

Conclusion: PASS

Test graphs as below:

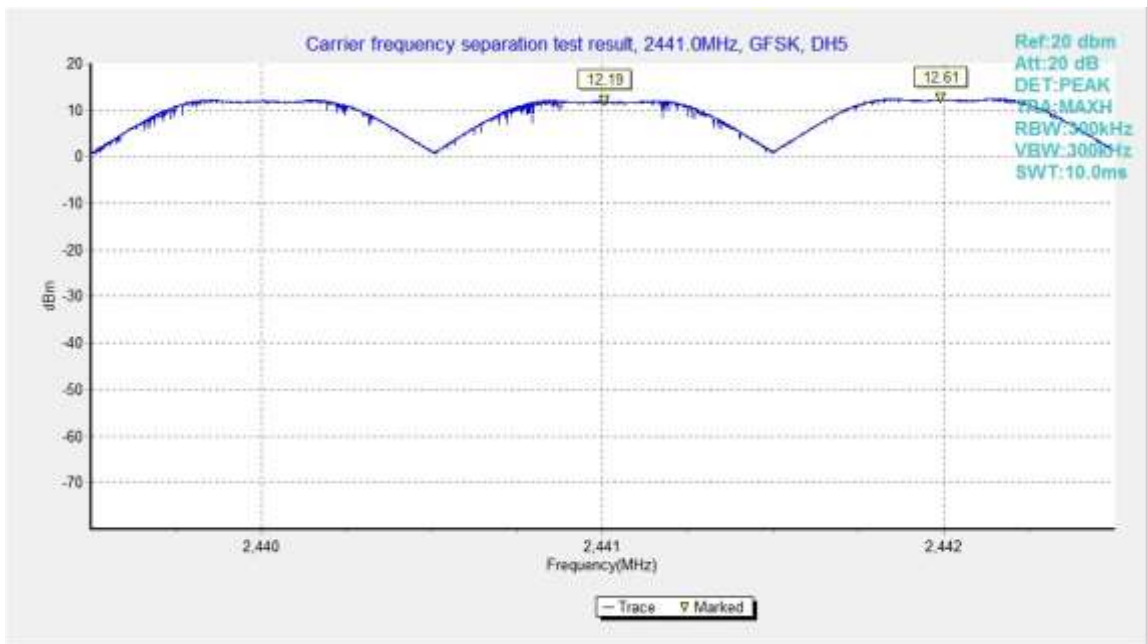
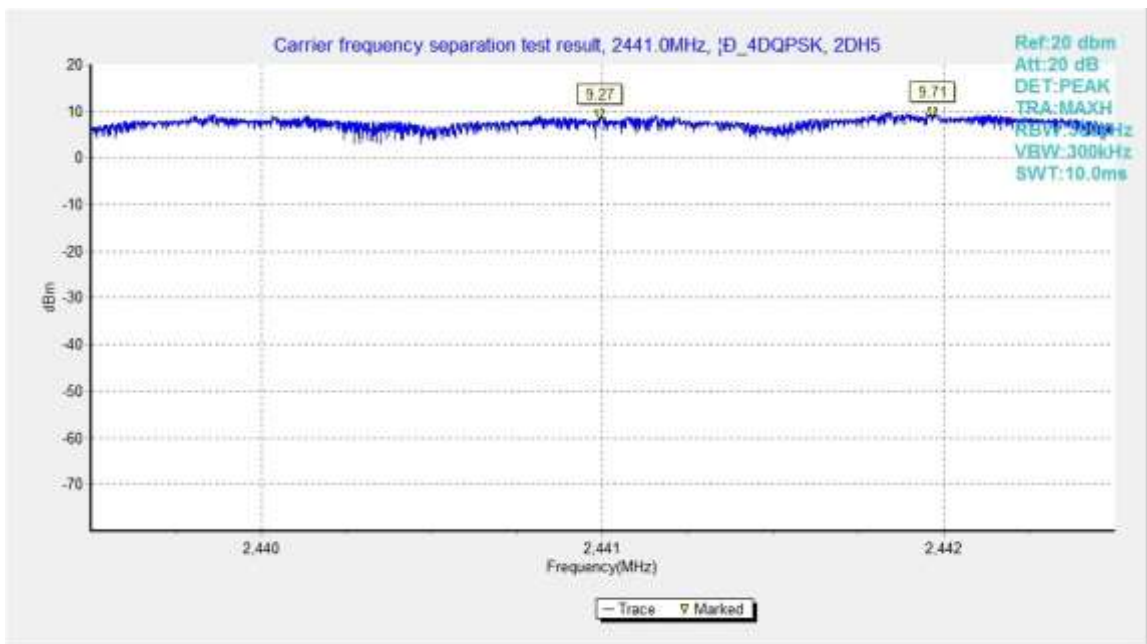

Fig.99. Carrier frequency separation measurement: GFSK, Channel 39

 Fig.100. Carrier frequency separation measurement: $\pi/4$ DQPSK, Channel 39

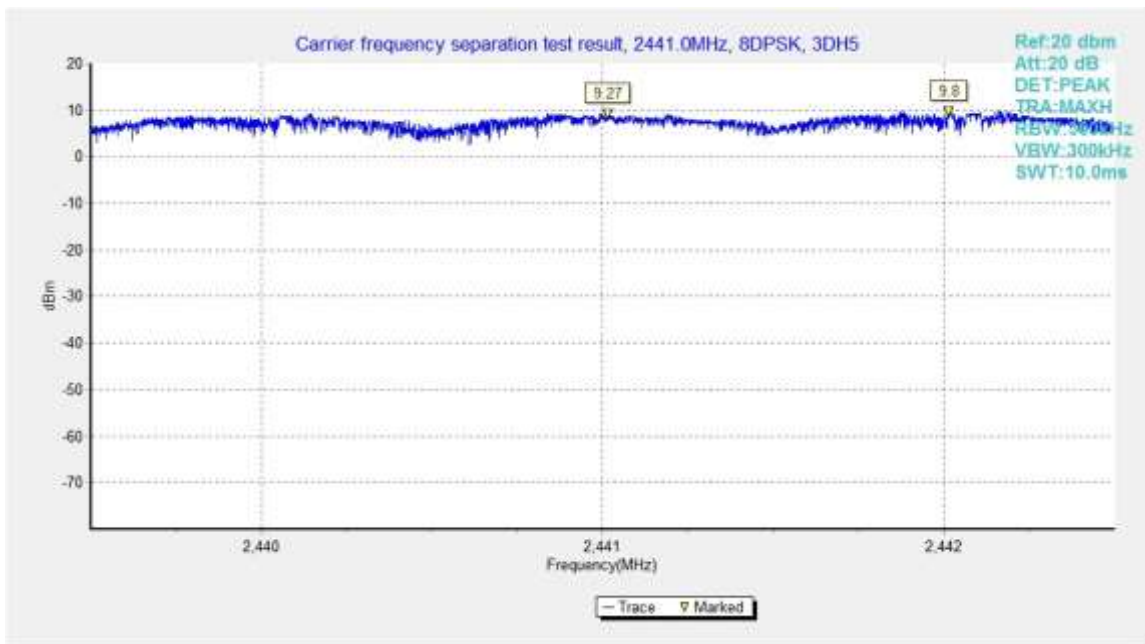

Fig.101. Carrier frequency separation measurement: 8DPSK, Channel 39

B.10. Number of Hopping Channels

Method of Measurement: See ANSI C63.10-clause 7.8.3

The EUT must have its hopping function enabled. Use the following spectrum analyzer settings:

- Span = the frequency band of operation
- RBW = 500kHz
- VBW = 500kHz
- Sweep = auto
- Detector function = peak
- Trace = max hold
- Allow the trace to stabilize

It might prove necessary to break the span up into subranges to show clearly all of the hopping frequencies. Compliance of an EUT with the appropriate regulatory limit shall be determined for the number of hopping channels. A plot of the data shall be included in the test report.

Measurement Limit:

Standard	Limit
FCC 47 CFR Part 15.247(a) (1)(iii)	At least 15 non-overlapping channels

Measurement Result:

For GFSK

Channel	Number of hopping channels		Conclusion
0~39	Fig.102	79	P
40~78	Fig.103		

For $\pi/4$ DQPSK

Channel	Number of hopping channels		Conclusion
0~39	Fig.104	79	P
40~78	Fig.105		

For 8DPSK

Channel	Number of hopping channels		Conclusion
0~39	Fig.106	79	P
40~78	Fig.107		

Conclusion: PASS

Test graphs as below:

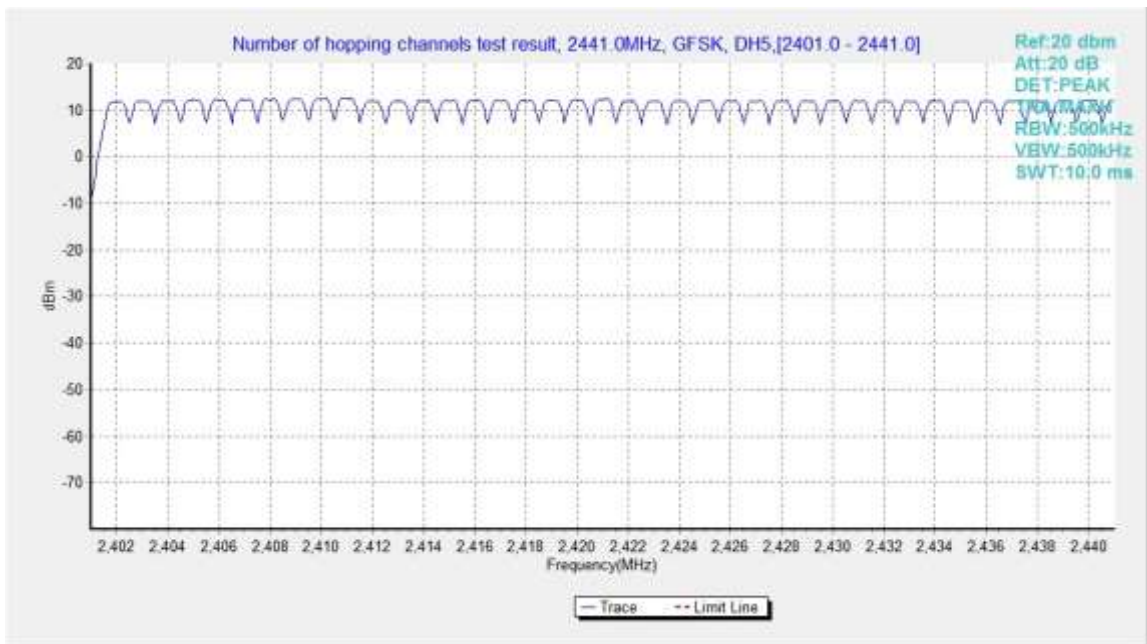

Fig.102. Number of hopping frequencies: GFSK, Channel 0 - 39

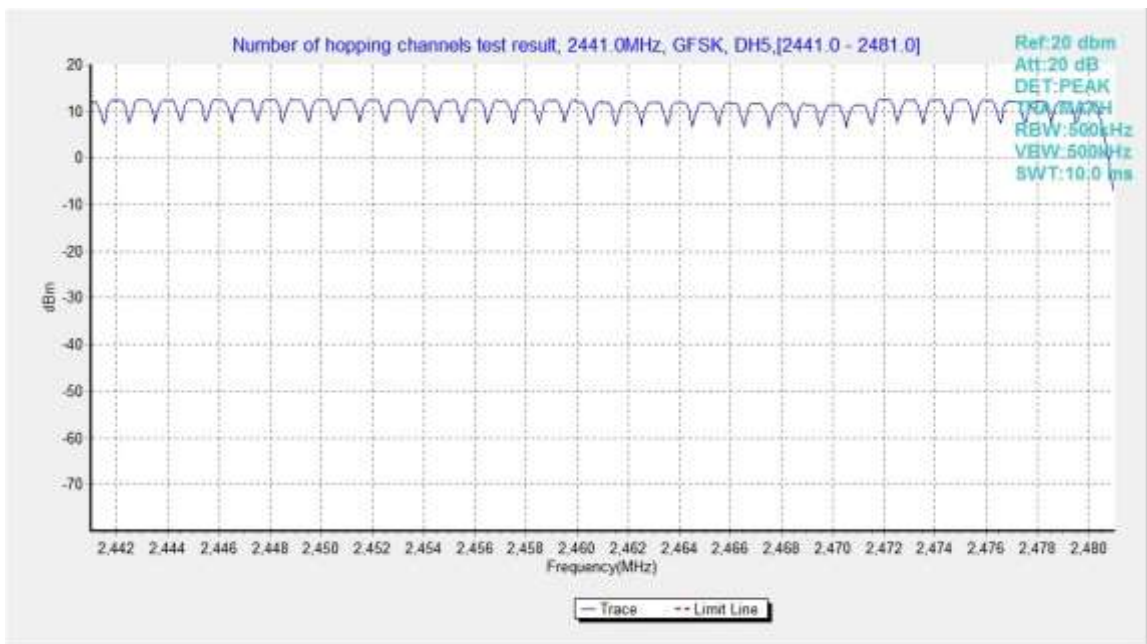

Fig.103. Number of hopping frequencies: GFSK, Channel 40 - 78

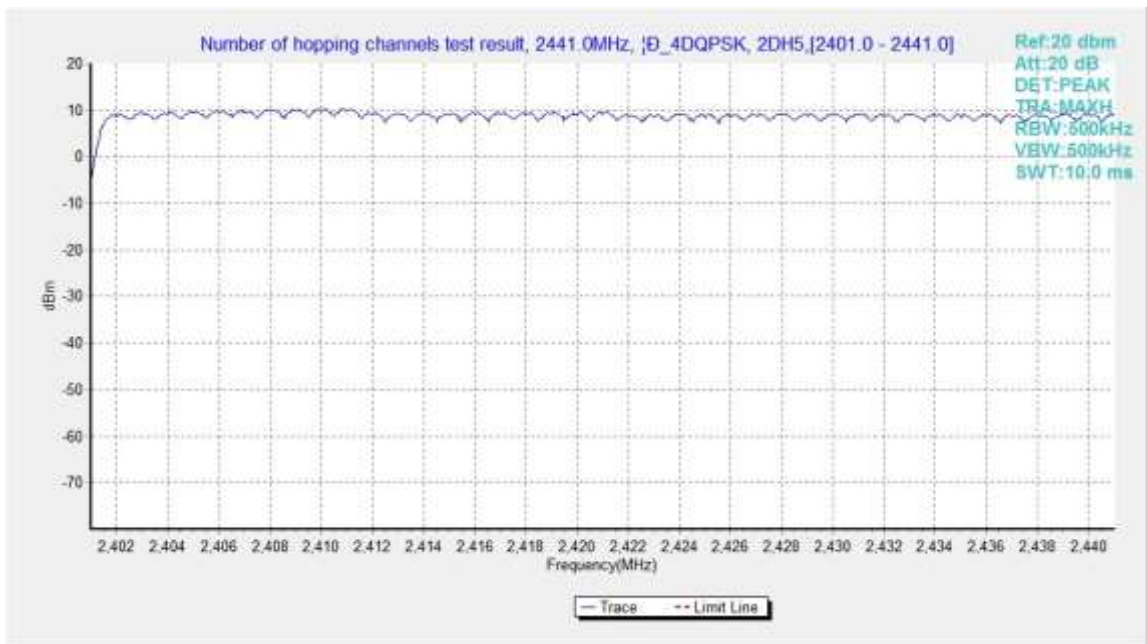

Fig.104. Number of hopping frequencies: $\pi/4$ DQPSK, Channel 0 - 39

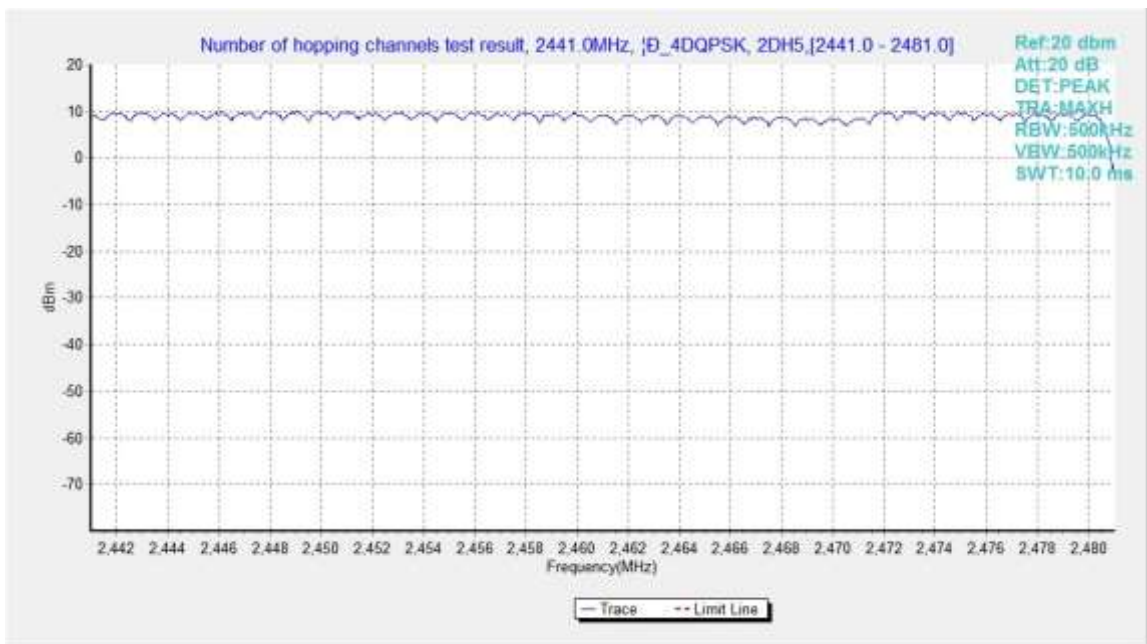

Fig.105. Number of hopping frequencies: $\pi/4$ DQPSK, Channel 40 - 78

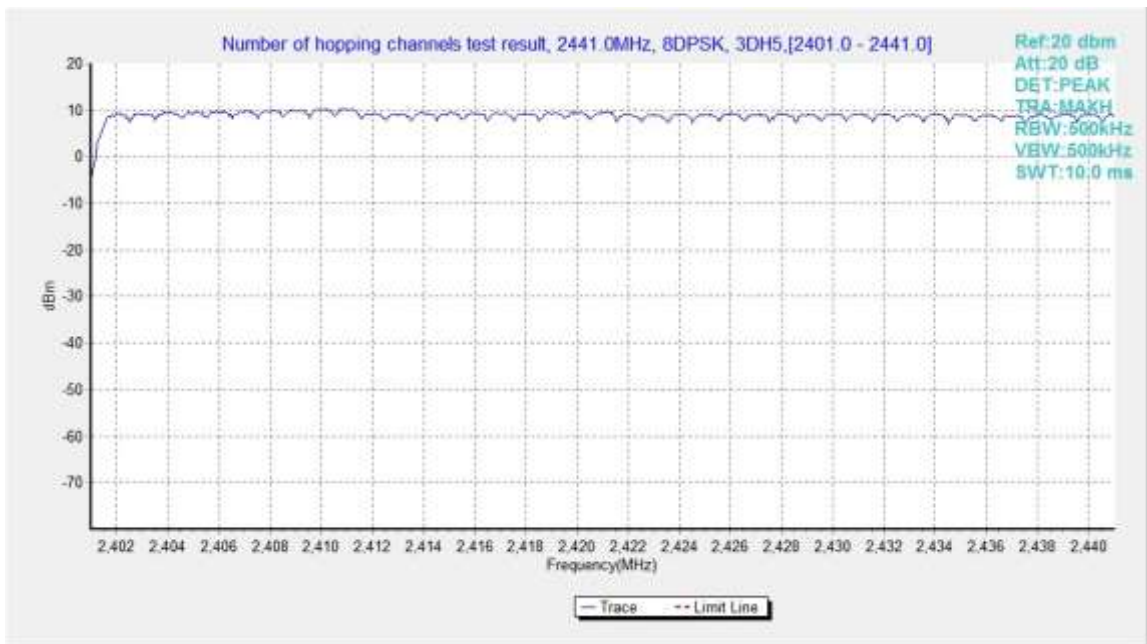

Fig.106. Number of hopping frequencies: 8DPSK, Channel 0 - 39

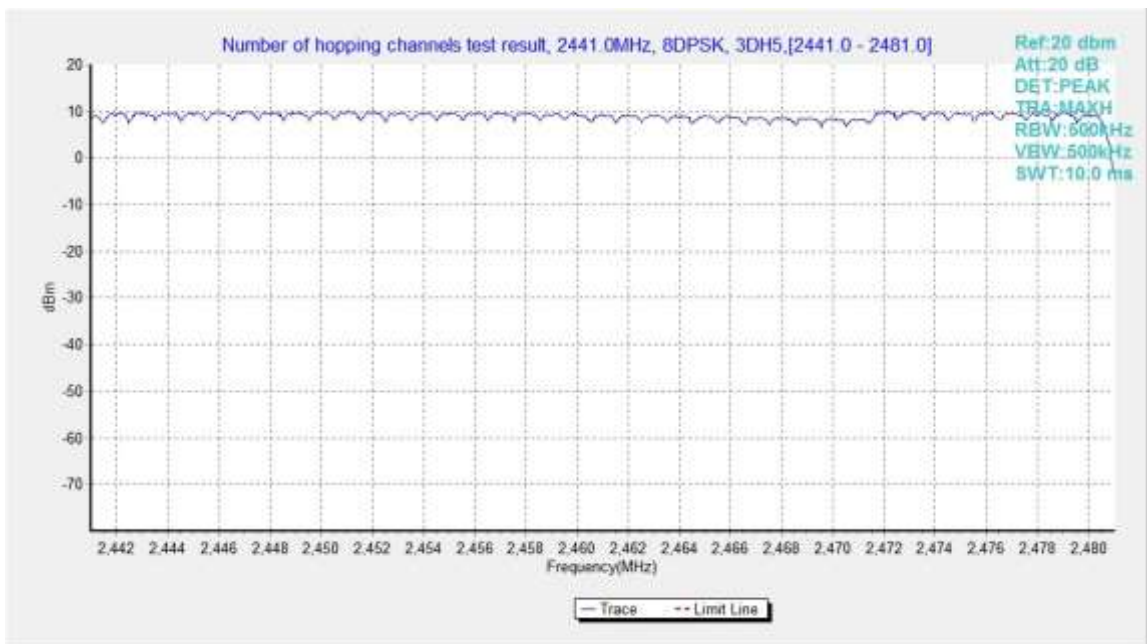

Fig.107. Number of hopping frequencies: 8DPSK, Channel 40 - 78

B.11. AC Powerline Conducted Emission

Method of Measurement: See ANSI C63.10-clause 6.2

Setup:

A stand-alone EUT shall be placed in the center along the back edge of the tabletop. For multiunit tabletop systems, the EUT shall be centered laterally (left to right facing the tabletop) on the tabletop and its rear shall be flush with the rear of the table.

Accessories that are part of an EUT system tested on a tabletop shall be placed in a test arrangement on one or both sides of the host with a 10 cm separation between the nearest points of the cabinets. The rear of the host and accessories shall be flush with the back of the supporting tabletop unless that would not be typical of normal use. If more than two accessories are present, then an equipment test arrangement shall be chosen that maintains 10 cm spacing between cabinets unless the equipment is normally located closer together.

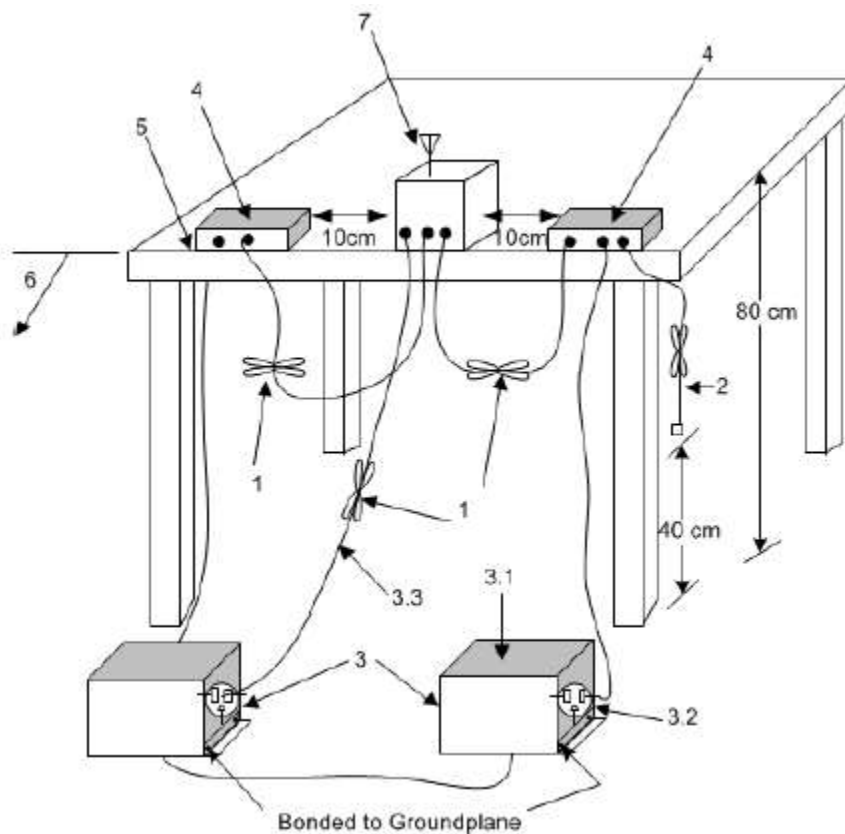

Exploratory ac power-line conducted emission measurements

Exploratory measurements shall be used to identify the frequency of the emission that has the highest amplitude relative to the limit by operating the EUT in a range of typical modes of operation, cable positions, and with a typical system equipment configuration and arrangement. For each mode of operation and for each ac power current-carrying conductor, cable manipulation shall be performed within the range of likely configurations. For this measurement or series of measurements, the frequency spectrum of interest shall be monitored looking for the emission that has the highest amplitude relative to the limit. Once that emission is found for each current-carrying conductor of each power cord associated with the EUT (but not the cords associated with non-EUT equipment in the overall system), the one configuration and

arrangement and mode of operation that produces the emission closest to the limit over all of the measured conductors shall be recorded.

Final ac power-line conducted emission measurements

Based on the exploratory tests of the EUT, the one EUT cable configuration and arrangement and mode of operation that produced the emission with the highest amplitude relative to the limit is selected for the final measurement, while applying the appropriate modulating signal to the EUT. If the EUT is relocated from an exploratory test site to a final test site, the highest emissions shall be remaximized at the final test location before final ac power-line conducted emission measurements are performed. The final test on all current-carrying conductors of all of the power cords to the equipment that comprises the EUT (but not the cords associated with other non-EUT equipment in the system) is then performed for the full frequency range for which the EUT is being tested for compliance without further variation of the EUT arrangement, cable positions, or EUT mode of operation. If the EUT is composed of equipment units that have their own separate ac power connections (e.g., floor-standing equipment with independent power cords for each shelf that are able to connect directly to the ac power network), then each current-carrying conductor of one unit is measured while the other units are connected to a second (or more) LISN(s). All units shall be measured separately. If a power strip is provided by the manufacturer, to supply all of the units making up the EUT, only the conductors in the power cord of the power strip shall be measured.

Test Condition:

Voltage (V)	Frequency (Hz)
120	60

Measurement Result and limit:

Note: The EUT has no BT transmit without connected to PC. The AC Powerline Conducted Emission can do the idle only

EUT ID: EUT3 + AE2-1 + AE1-3

Bluetooth (Quasi-peak Limit)

Frequency range (MHz)	Quasi-peak Limit (dB μ V)	Result (dB μ V)		Conclusion
		With charger		
		bluetooth	Idle	
0.15 to 0.5	66 to 56	/	Fig.B.11.1	P
0.5 to 5	56			
5 to 30	60			

NOTE: The limit decreases linearly with the logarithm of the frequency in the range 0.15 MHz to 0.5 MHz.

Bluetooth (Average Limit)

Frequency range (MHz)	Average Limit (dB μ V)	Result (dB μ V)		Conclusion
		With charger		
		bluetooth	Idle	
0.15 to 0.5	56 to 46	/	Fig.B.11.1	P
0.5 to 5	46			
5 to 30	50			

NOTE: The limit decreases linearly with the logarithm of the frequency in the range 0.15 MHz to 0.5 MHz.

EUT ID: EUT4 + AE2-2 + AE1-3

Bluetooth (Quasi-peak Limit)

Frequency range (MHz)	Quasi-peak Limit (dB μ V)	Result (dB μ V)		Conclusion
		With charger		
		bluetooth	Idle	
0.15 to 0.5	67 to 56	/	Fig.B.11.2	P
0.5 to 5	56			
5 to 30	60			

NOTE: The limit decreases linearly with the logarithm of the frequency in the range 0.15 MHz to 0.5 MHz.

Bluetooth (Average Limit)

Frequency range (MHz)	Average Limit (dB μ V)	Result (dB μ V)		Conclusion
		With charger		
		bluetooth	Idle	
0.15 to 0.5	57 to 46	/	Fig.B.11.2	P
0.5 to 5	46			
5 to 30	50			

NOTE: The limit decreases linearly with the logarithm of the frequency in the range 0.15 MHz to 0.5 MHz.

EUT ID: EUT5 + AE2-3 + AE1-3

Bluetooth (Quasi-peak Limit)

Frequency range (MHz)	Quasi-peak Limit (dB μ V)	Result (dB μ V)		Conclusion
		With charger		
		bluetooth	Idle	
0.15 to 0.5	68 to 56	/	Fig.B.11.3	P
0.5 to 5	56			
5 to 30	60			

NOTE: The limit decreases linearly with the logarithm of the frequency in the range 0.15 MHz to 0.5 MHz.

Bluetooth (Average Limit)

Frequency range (MHz)	Average Limit (dB μ V)	Result (dB μ V)		Conclusion
		With charger		
		bluetooth	Idle	
0.15 to 0.5	58 to 46	/	Fig.B.11.3	P
0.5 to 5	46			
5 to 30	50			

NOTE: The limit decreases linearly with the logarithm of the frequency in the range 0.15 MHz to 0.5 MHz.

EUT ID: EUT3 + AE2-4 + AE1-3
Bluetooth (Quasi-peak Limit)

Frequency range (MHz)	Quasi-peak Limit (dB μ V)	Result (dB μ V)		Conclusion
		With charger		
		bluetooth	Idle	
0.15 to 0.5	69 to 56	/	Fig.B.11.4	P
0.5 to 5	56			
5 to 30	60			

NOTE: The limit decreases linearly with the logarithm of the frequency in the range 0.15 MHz to 0.5 MHz.

Bluetooth (Average Limit)

Frequency range (MHz)	Average Limit (dB μ V)	Result (dB μ V)		Conclusion
		With charger		
		bluetooth	Idle	
0.15 to 0.5	59 to 46	/	Fig.B.11.4	P
0.5 to 5	46			
5 to 30	50			

NOTE: The limit decreases linearly with the logarithm of the frequency in the range 0.15 MHz to 0.5 MHz.

EUT ID: EUT4 + AE2-5 + AE1-3

Bluetooth (Quasi-peak Limit)

Frequency range (MHz)	Quasi-peak Limit (dB μ V)	Result (dB μ V)		Conclusion
		With charger		
		bluetooth	Idle	
0.15 to 0.5	70 to 56	/	Fig.B.11.5	P
0.5 to 5	56			
5 to 30	60			

NOTE: The limit decreases linearly with the logarithm of the frequency in the range 0.15 MHz to 0.5 MHz.

Bluetooth (Average Limit)

Frequency range (MHz)	Average Limit (dB μ V)	Result (dB μ V)		Conclusion
		With charger		
		bluetooth	Idle	
0.15 to 0.5	60 to 46	/	Fig.B.11.5	P
0.5 to 5	46			
5 to 30	50			

NOTE: The limit decreases linearly with the logarithm of the frequency in the range 0.15 MHz to 0.5 MHz.

Conclusion: Pass

Test graphs as below:

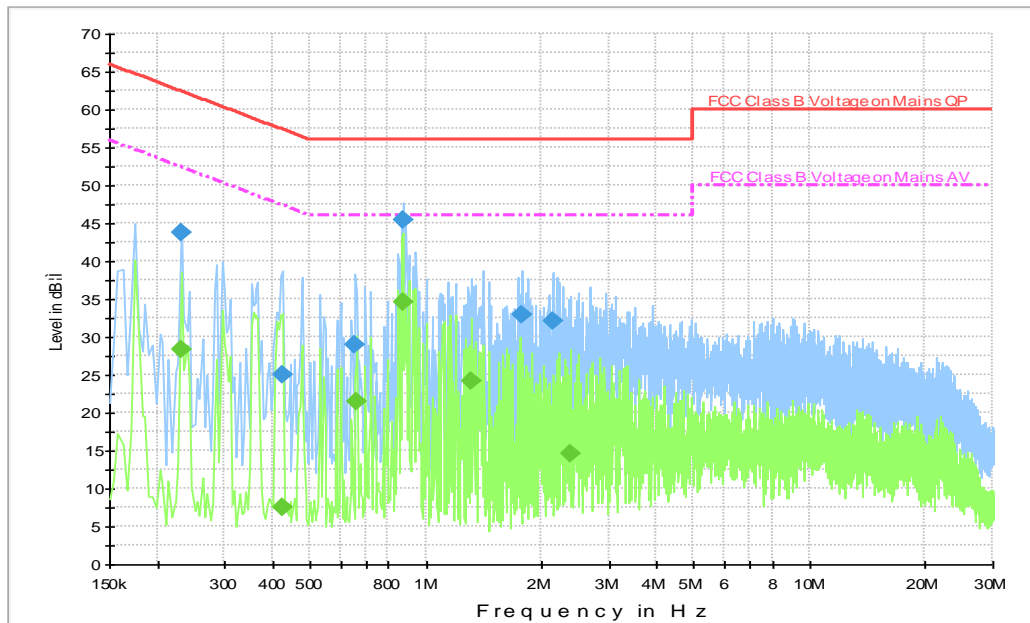
Fig. B11.1 AC Powerline Conducted Emission-Idle (EUT3 + AE2-1 + AE1-3)
Final Result 1

Frequency (MHz)	QuasiPeak (dB μ V)	Meas. Time	Bandwidth (kHz)	Filter	Line	Corr. (dB)	Margin (dB)	Limit (dB μ)
0.230000	43.8	2000.0	9.000	On	L1	19.7	18.6	62.4
0.422000	24.9	2000.0	9.000	On	L1	19.7	32.5	57.4
0.654000	29.0	2000.0	9.000	On	L1	19.7	27.0	56.0
0.874000	45.3	2000.0	9.000	On	N	19.6	10.7	56.0
1.786000	32.9	2000.0	9.000	On	L1	19.6	23.1	56.0
2.134000	32.1	2000.0	9.000	On	L1	19.6	23.9	56.0

Final Result 2

Frequency (MHz)	CAverage (dB μ V)	Meas. Time	Bandwidth (kHz)	Filter	Line	Corr. (dB)	Margin (dB)	Limit (dB μ)
0.230000	28.3	2000.0	9.000	On	L1	19.7	24.2	52.4
0.422000	7.6	2000.0	9.000	On	N	19.7	39.8	47.4
0.662000	21.5	2000.0	9.000	On	N	19.6	24.5	46.0
0.870000	34.5	2000.0	9.000	On	N	19.6	11.5	46.0
1.314000	24.2	2000.0	9.000	On	N	19.6	21.8	46.0
2.378000	14.5	2000.0	9.000	On	L1	19.6	31.5	46.0

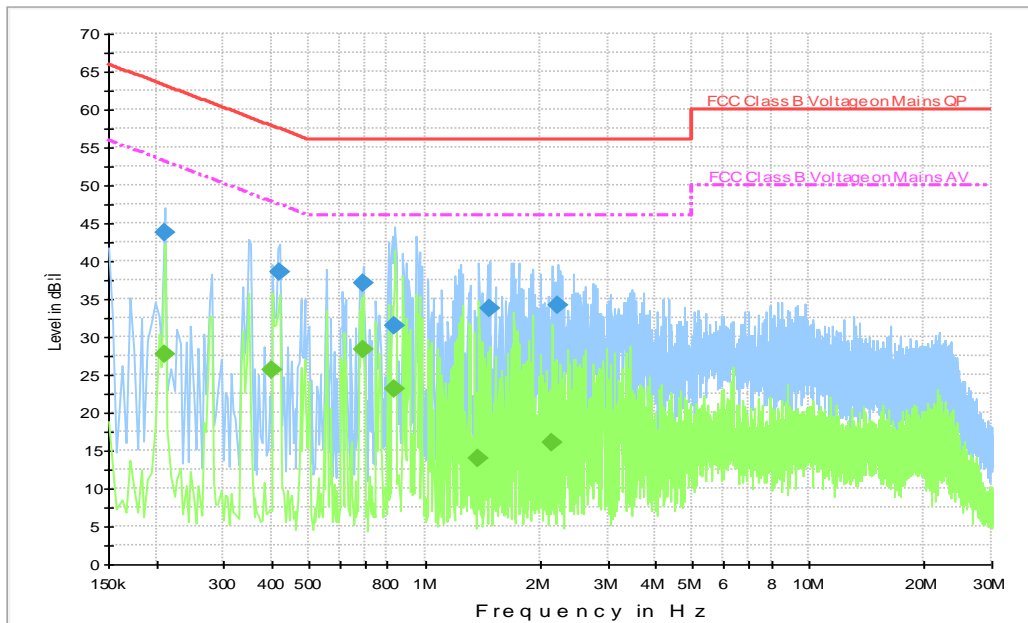

Fig. B11.2 AC Powerline Conducted Emission-802.11a (EUT4 + AE2-2 + AE1-3)

Final Result 1

Frequency (MHz)	QuasiPeak (dB µV)	Meas. Time	Bandwidth (kHz)	Filter	Line	Corr. (dB)	Margin (dB)	Limit (dB µ)
0.210000	43.7	1000.0	9.000	On	L1	19.7	19.6	63.2
0.418000	38.5	1000.0	9.000	On	L1	19.7	19.0	57.5
0.690000	37.0	1000.0	9.000	On	N	19.6	19.0	56.0
0.838000	31.5	1000.0	9.000	On	N	19.6	24.5	56.0
1.482000	33.8	1000.0	9.000	On	L1	19.7	22.2	56.0
2.226000	34.1	1000.0	9.000	On	L1	19.6	21.9	56.0

Final Result 2

Frequency (MHz)	CAverage (dB µV)	Meas. Time	Bandwidth (kHz)	Filter	Line	Corr. (dB)	Margin (dB)	Limit (dB µ)
0.210000	27.7	1000.0	9.000	On	L1	19.7	25.5	53.2
0.402000	25.5	1000.0	9.000	On	N	19.6	22.3	47.8
0.690000	28.3	1000.0	9.000	On	N	19.6	17.7	46.0
0.838000	23.1	1000.0	9.000	On	N	19.6	22.9	46.0
1.382000	14.1	1000.0	9.000	On	L1	19.6	31.9	46.0
2.150000	16.1	1000.0	9.000	On	L1	19.6	29.9	46.0

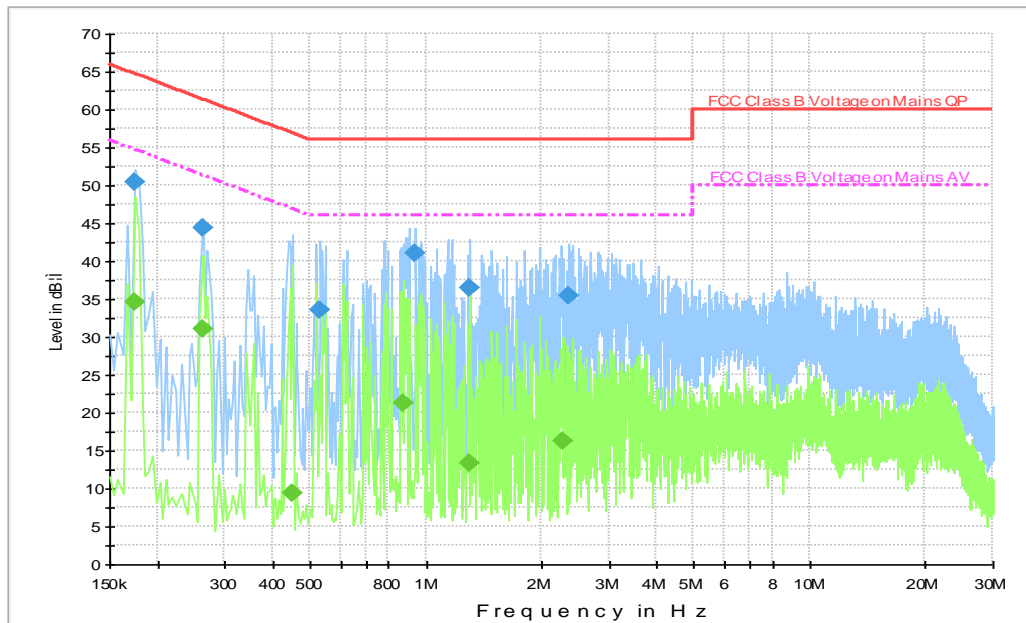

Fig. B11.3 AC Powerline Conducted Emission-802.11a (EUT5 + AE2-3 + AE1-3)

Final Result 1

Frequency (MHz)	QuasiPeak (dB µ V)	Meas. Time	Bandwidth (kHz)	Filter	Line	Corr. (dB)	Margin (dB)	Limit (dB µ)
0.174000	50.4	1000.0	9.000	On	L1	19.7	14.4	64.8
0.262000	44.5	1000.0	9.000	On	N	19.7	16.9	61.4
0.530000	33.5	1000.0	9.000	On	L1	19.7	22.5	56.0
0.938000	41.1	1000.0	9.000	On	N	19.6	14.9	56.0
1.306000	36.5	1000.0	9.000	On	L1	19.6	19.5	56.0
2.354000	35.4	1000.0	9.000	On	L1	19.6	20.6	56.0

Final Result 2

Frequency (MHz)	CAverage (dB µ V)	Meas. Time	Bandwidth (kHz)	Filter	Line	Corr. (dB)	Margin (dB)	Limit (dB µ)
0.174000	34.5	1000.0	9.000	On	L1	19.7	20.3	54.8
0.262000	30.9	1000.0	9.000	On	N	19.7	20.4	51.4
0.450000	9.4	1000.0	9.000	On	L1	19.7	37.5	46.9
0.874000	21.3	1000.0	9.000	On	N	19.6	24.7	46.0
1.306000	13.2	1000.0	9.000	On	L1	19.6	32.8	46.0
2.286000	16.2	1000.0	9.000	On	N	19.6	29.8	46.0

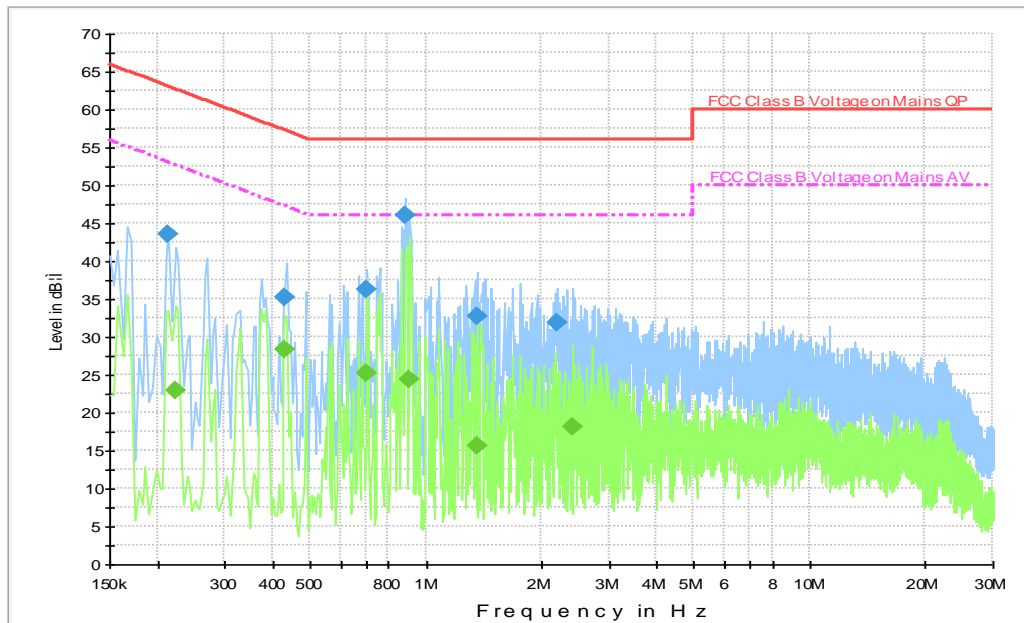

Fig. B11.4 AC Powerline Conducted Emission-802.11a (EUT3 + AE2-4 + AE1-3)

Final Result 1

Frequency (MHz)	QuasiPeak (dB µV)	Meas. Time	Bandwidth (kHz)	Filter	Line	Corr. (dB)	Margin (dB)	Limit (dB µV)
0.214000	43.6	2000.0	9.000	On	L1	19.7	19.5	63.0
0.430000	35.3	2000.0	9.000	On	N	19.7	22.0	57.3
0.702000	36.2	2000.0	9.000	On	N	19.7	19.8	56.0
0.882000	46.1	2000.0	9.000	On	N	19.6	9.9	56.0
1.358000	32.7	2000.0	9.000	On	L1	19.6	23.3	56.0
2.206000	31.9	2000.0	9.000	On	L1	19.6	24.1	56.0

Final Result 2

Frequency (MHz)	CAverage (dB µV)	Meas. Time	Bandwidth (kHz)	Filter	Line	Corr. (dB)	Margin (dB)	Limit (dB µV)
0.222000	23.0	2000.0	9.000	On	N	19.7	29.8	52.7
0.430000	28.3	2000.0	9.000	On	N	19.7	19.0	47.3
0.702000	25.2	2000.0	9.000	On	N	19.7	20.8	46.0
0.910000	24.5	2000.0	9.000	On	N	19.6	21.5	46.0
1.358000	15.6	2000.0	9.000	On	L1	19.6	30.4	46.0
2.414000	18.2	2000.0	9.000	On	N	19.6	27.8	46.0

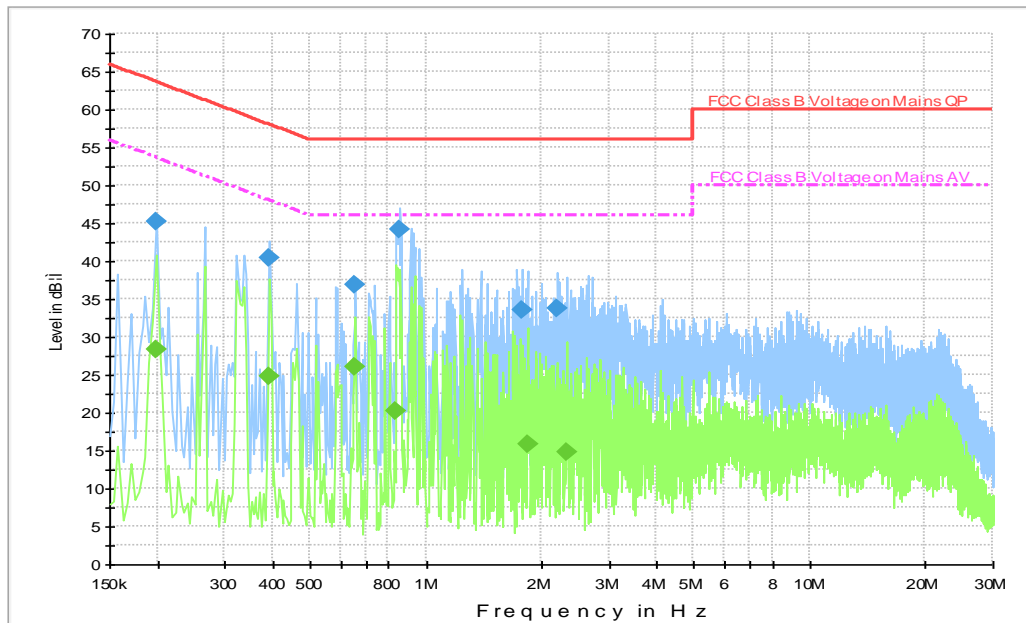

Fig. B11.5 AC Powerline Conducted Emission-802.11a (EUT4 + AE2-5 + AE1-3)

Final Result 1

Frequency (MHz)	QuasiPeak (dB µ V)	Meas. Time	Bandwidth (kHz)	Filter	Line	Corr. (dB)	Margin (dB)	Limit (dB µ)
0.198000	45.2	1000.0	9.000	On	L1	19.7	18.5	63.7
0.390000	40.4	1000.0	9.000	On	L1	19.7	17.7	58.1
0.654000	36.8	1000.0	9.000	On	L1	19.7	19.2	56.0
0.858000	44.1	1000.0	9.000	On	N	19.6	11.9	56.0
1.782000	33.6	1000.0	9.000	On	L1	19.6	22.4	56.0
2.206000	33.7	1000.0	9.000	On	L1	19.6	22.3	56.0

Final Result 2

Frequency (MHz)	CAverage (dB µ V)	Meas. Time	Bandwidth (kHz)	Filter	Line	Corr. (dB)	Margin (dB)	Limit (dB µ)
0.198000	28.4	1000.0	9.000	On	L1	19.7	25.3	53.7
0.390000	24.8	1000.0	9.000	On	L1	19.7	23.2	48.1
0.654000	25.9	1000.0	9.000	On	N	19.6	20.1	46.0
0.838000	20.1	1000.0	9.000	On	N	19.6	25.9	46.0
1.834000	15.8	1000.0	9.000	On	L1	19.6	30.2	46.0
2.326000	14.8	1000.0	9.000	On	L1	19.6	31.2	46.0

ANNEX C: Accreditation Certificate

<p>United States Department of Commerce National Institute of Standards and Technology</p>  	
<hr/> Certificate of Accreditation to ISO/IEC 17025:2017 <hr/>	
NVLAP LAB CODE: 600118-0	
Telecommunication Technology Labs, CAICT Beijing China	
<i>is accredited by the National Voluntary Laboratory Accreditation Program for specific services, listed on the Scope of Accreditation, for:</i>	
Electromagnetic Compatibility & Telecommunications	
<i>This laboratory is accredited in accordance with the recognized international Standard ISO/IEC 17025:2017. This accreditation demonstrates technical competence for a defined scope and the operation of a laboratory quality management system (refer to joint ISO-ILAC-IAF Communique dated January 2009).</i>	
2022-10-01 through 2023-09-30 Effective Dates	  For the National Voluntary Laboratory Accreditation Program

END OF REPORT