



HAC TEST REPORT

Applicant Cloud Mobile Holding LLC
FCC ID 2AY6A-C7
Product Mobile phone
Brand Cloud Mobile
Model Stratus C7
Report No. R2209A0854-H1
Issue Date October 13, 2022

TA Technology (Shanghai) Co., Ltd. tested the above equipment in accordance with the requirements in **ANSI C63.19-2011**. The test results show that the equipment tested is capable of demonstrating compliance with the requirements as documented in this report.

Wei Fangying

Fan Guangchang

Prepared by: Wei Fangying Approved by: Fan Guangchang

TA Technology (Shanghai) Co., Ltd.

Building 3, No.145, Jintang Rd, Tangzhen Industry Park, Pudong Shanghai, China

TEL: +86-021-50791141/2/3

FAX: +86-021-50791141/2/3-8000

Table of Contents

1	Test Laboratory.....	3
1.1	Notes of the Test Report.....	3
1.2	Test facility.....	3
1.3	Testing Location.....	3
1.4	Laboratory Environment.....	4
2	Statement of Compliance.....	5
3	Description of Equipment under Test.....	6
4	Test Specification and Operational Conditions.....	9
4.1	Test Specification.....	9
5	Test Information.....	10
5.1	Operational Conditions during Test.....	10
5.1.1	General Description of Test Procedures.....	10
5.2	HAC RF Measurements System Configuration.....	10
5.2.1	HAC Measurement Set-up.....	10
5.2.2	Probe System.....	11
5.2.3	Test Arch Phantom & Phone Positioner.....	12
5.3	RF Test Procedures.....	13
5.4	System Check.....	15
5.5	Modulation Interference Factor.....	16
5.6	Justification of Held to Ear Modes Tested.....	17
5.6.1	Analysis of RF Air Interface Technologies.....	17
5.6.2	Average Antenna Input Power & Evaluation for Low-power Exemption.....	18
6	Test Results.....	19
6.1	ANSI C63.19-2011 Limits.....	19
6.2	Summary Test Results.....	20
7	Measurement Uncertainty.....	21
8	Main Test Instruments.....	22
	ANNEX A: System Check Results.....	23
	ANNEX B: Graph Results.....	26
	ANNEX C: E-Probe Calibration Certificate.....	44
	ANNEX D: CD835V3 Dipole Calibration Certificate.....	66
	ANNEX E: CD1880V3 Dipole Calibration Certificate.....	71
	ANNEX F: CD2600V3 Dipole Calibration Certificate.....	76
	ANNEX G: DAE4 Calibration Certificate.....	81
	ANNEX H: UID Specifications.....	84
	ANNEX I: The EUT Appearances and Test Configuration.....	85



1 Test Laboratory

1.1 Notes of the Test Report

This report shall not be reproduced in full or partial, without the written approval of **TA Technology (Shanghai) Co., Ltd.** The results documented in this report apply only to the tested sample, under the conditions and modes of operation as described herein .Measurement Uncertainties were not taken into account and are published for informational purposes only. This report is written to support regulatory compliance of the applicable standards stated above.

1.2 Test facility

FCC (Designation number: CN1179, Test Firm Registration Number: 446626)

TA Technology (Shanghai) Co., Ltd. has been listed on the US Federal Communications Commission list of test facilities recognized to perform measurements.

A2LA (Certificate Number: 3857.01)

TA Technology (Shanghai) Co., Ltd. has been listed by American Association for Laboratory Accreditation to perform measurement.

1.3 Testing Location

Company: TA Technology (Shanghai) Co., Ltd.
Address: Building 3, No.145, Jintang Rd, Tangzhen Industry Park, Pudong Shanghai, China
City: Shanghai
Post code: 201201
Country: P. R. China
Contact: Fan Guangchang
Telephone: +86-021-50791141/2/3
Fax: +86-021-50791141/2/3-8000
Website: <http://www.ta-shanghai.com>
E-mail: fanguangchang@ta-shanghai.com



1.4 Laboratory Environment

Temperature	Min. = 18°C, Max. = 28 °C
Relative humidity	Min. = 0%, Max. = 80%
Ground system resistance	< 0.5 Ω
Ambient noise is checked and found very low and in compliance with requirement of standards. Reflection of surrounding objects is minimized and in compliance with requirement of standards.	

2 Statement of Compliance

Table 2.1: The Total M-rating of each tested band

Mode	Rating
GSM 850	M4
GSM 1900	M4
LTE TDD Band 41	M4
WCDMA & LTE-FDD	M4
The Total M-rating is M4	
Date of Testing: September 24, 2022 ~ September 26, 2022 Date of Sample Received: September 16, 2022	
Note: 1. Refer to section 5.6.2 Evaluation for Low-power Exemption. RF Emission testing for this device is required only for GSM voice modes and LTE-TDD modes. WCDMA and LTE-FDD mode applicable air-interfaces are exempt from testing in accordance with C63.19-2011 Clause 4.4 and are rated M4. 2. All indications of Pass/Fail in this report are opinions expressed by TA Technology (Shanghai) Co., Ltd. based on interpretations and/or observations of test results. Measurement Uncertainties were not taken into account and are published for informational purposes only.	

3 Description of Equipment under Test

Client Information

Applicant	Cloud Mobile Holding LLC
Applicant address	1149 S. HILL ST. SUITE H400, LOS ANGELES, CA 90015
Manufacturer	Shenzhen Along Electronics Co., LTD
Manufacturer address	No.35, Xinyuan Industrial Zone, Gushu Community, Xixiang Street, Bao 'an District, Shenzhen

General Technologies

Device Type:	Portable Device	
State of Sample:	Prototype Unit	
Model:	Stratus C7	
IMEI:	135790246811222	
Hardware Version:	W18_MB_V21	
Software Version:	W18_Stratus_C7	
Antenna Type:	LDS Antenna	
Power Class:	GSM 850: 4 GSM 1900: 1 WCDMA Band II/IV/V: 3 LTE FDD 2/4/5/7/12/13/17/66/71: 3 LTE TDD 41: 3	
Power Level	GSM 850: level 5 GSM 1900: level 0 WCDMA Band II/IV/V: All up bits LTE FDD 2/4/5/7/12/13/17/66/71: max power LTE TDD 41: max power	
Test Modulation:	(GSM)GMSK; (WCDMA) QPSK; (LTE) QPSK, 16QAM;	
Operating Frequency Range(s):	Mode	Tx (MHz)
	GSM 850	824 ~ 849
	GSM 1900	1850 ~ 1910
	WCDMA Band II	1850 ~ 1910
	WCDMA Band IV	1710 ~ 1755
	WCDMA Band V	824 ~ 849
	LTE FDD 2	1850 ~ 1910
	LTE FDD 4	1710 ~ 1755
	LTE FDD 5	824 ~ 849
LTE FDD 7	2500 ~ 2570	



	LTE FDD 12	699 ~ 716
	LTE FDD 13	777 ~ 787
	LTE FDD 17	704 ~ 716
	LTE TDD 41	2555 ~ 2655
	LTE FDD 66	1710 ~ 1780
	LTE FDD 71	663 ~ 698
Accessory Equipment		
Battery	Manufacturer: SHENZHEN KEHUAXIN ELECTRONICS CO., LTD. Model: C7	
Note: The EUT is sent from the applicant to TA and the information of the EUT is declared by the applicant.		



Air-Interface	Band (MHz)	Type	ANSI C63.19 tested	Simultaneous Transmissions	Voice over Digital Transport OTT Capability	Name of Voice Service	Power Reduction
GSM	850	VO	Yes	N/A	N/A	CMRS Voice	N/A
	1900						
	GPRS/EDGE	DT	No		No	#	No
WCDMA	Band II	VO	Yes	N/A	N/A	CMRS Voice	N/A
	Band IV						
	Band V						
	HSPA	DT	No		No	#	No
LTE	Band 2	VD	Yes	N/A	N/A	VoLTE	No
	Band 4						
	Band 5						
	Band 7						
	Band 12						
	Band 13						
	Band 17						
	Band 41						
	Band 66						
	Band 71						

VO= legacy Cellular Voice Service from Table 7.1 in 7.4.2.1 of ANSI C63.19-2011

DT= Digital Transport only (no voice)

VD= IP voice service over digital transport.

#: Ref Lev in accordance with 7.4.2.1 of ANSI C63.19-2011

##: Ref Lev in accordance with the July 2012 VoLTE interpretation.

Remark:

1. It applies the low power exemption based on ANSI C63.19-2011



4 Test Specification and Operational Conditions

4.1 Test Specification

The tests documented in this report were performed in accordance with the following:

FCC CFR47 Part 20.19

ANSI C63.19-2011

KDB 285076 D01 HAC Guidance v06

KDB 285076 D02 T-Coil testing for CMRS IP v04

5 Test Information

5.1 Operational Conditions during Test

5.1.1 General Description of Test Procedures

The phone was tested in all normal configurations for the ear use. The EUT is mounted in the device holder equivalent as for classic dosimeter measurements. The acoustic output of the EUT shall coincide with the center point of the area formed by the dielectric wire and the middle bar of the arch's top frame. The EUT shall be moved vertically upwards until it touches the frame. The fine adjustment is possible by sliding the complete. The EUT holder is on the yellow base plate of the Test Arch phantom. These test configurations are tested at the high, middle and low frequency channels of each applicable operating mode.

A communication link is set up with a System Simulator (SS) by air link, and a call is established. The EUT is commanded to operate at maximum transmitting power.

5.2 HAC RF Measurements System Configuration

5.2.1 HAC Measurement Set-up

These measurements are performed using the DASY5 automated dosimetric assessment system. It is made by Schmid & Partner Engineering AG (SPEAG) in Zurich, Switzerland. It consists of high precision robotics system (Stäubli), robot controller, Intel Core2 computer, near-field probe, probe alignment sensor. The robot is a six-axis industrial robot performing precise movements. Cell controller systems contain the power supply, robot controller, teach pendant (Joystick) and remote control, and are used to drive the robot motors. The Stäubli Robot is connected to the cell controller to allow software manipulation of the robot. A data acquisition electronic (DAE) circuit performs the signal amplification; signal multiplexing, AD-conversion, offset measurements, mechanical surface detection, collision detection, etc. is connected to the Electro-optical coupler (EOC). The EOC performs the conversion from the optical into digital electric signal of the DAE and transfers data to the PC plug-in card.

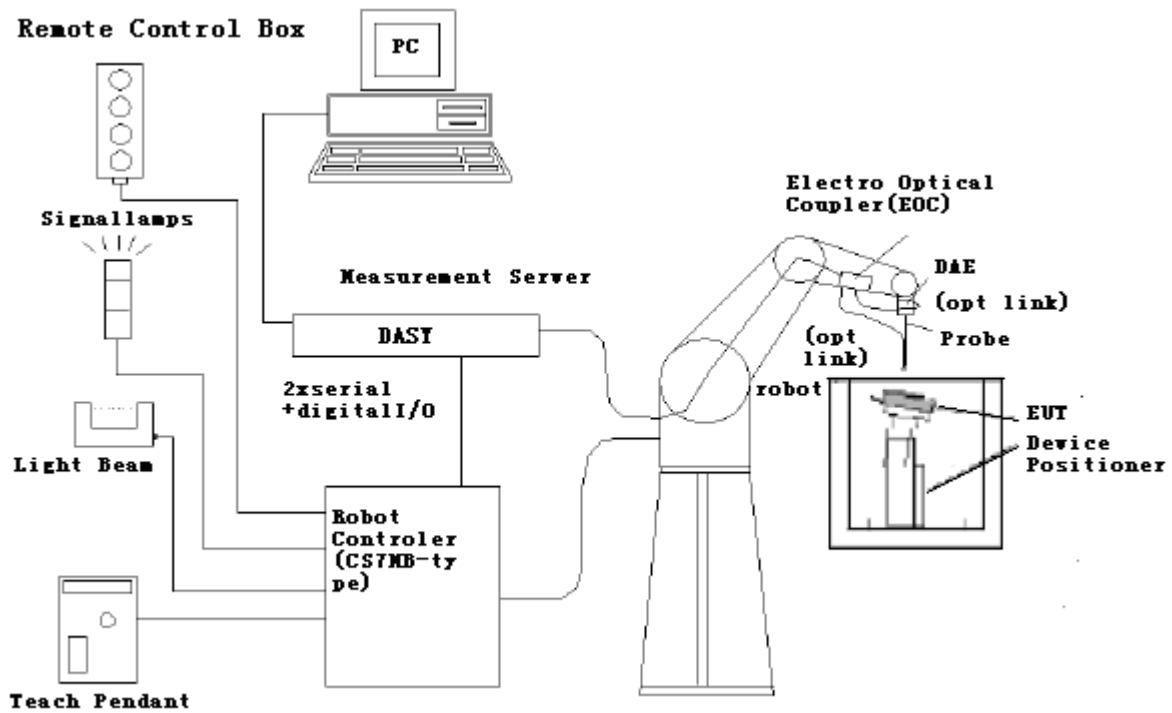

Figure 1 HAC Test Measurement Set-up

The DAE4 consists of a highly sensitive electrometer-grade preamplifier with auto-zeroing, a channel and gain-switching multiplexer, a fast 16 bit AD-converter and a command decoder and control logic unit. Transmission to the PC-card is accomplished through an optical downlink for data and status information and an optical uplink for commands and clock lines. The mechanical probe mounting device includes two different sensor systems for frontal and sidewise probe contacts. They are also used for mechanical surface detection and probe collision detection. The robot uses its own controller with a built in VME-bus computer.

5.2.2 Probe System

The HAC measurements were conducted with the E-Field Probe ER3DV6 and the H-Field Probe H3DV6 (manufactured by SPEAG), designed in the classical triangular configuration and optimized for dosimetric evaluation.

E-Field Probe Description

Construction	One dipole parallel, two dipoles normal to probe axis Built-in shielding against static charges PEEK enclosure material
Calibration	In air from 100 MHz to 3.0 GHz (absolute accuracy $\pm 6.0\%$, $k=2$)
Frequency	40 MHz to > 6 GHz (can be extended to < 20 MHz) Linearity: ± 0.2 dB (100 MHz to 3 GHz)



Figure 2 ER3DV6 E-field

Directivity	± 0.2 dB in air (rotation around probe axis) ± 0.4 dB in air (rotation normal to probe axis)	Probe
Dynamic Range	2 V/m to > 1000 V/m; Linearity: ± 0.2 dB	
Dimensions	Overall length: 330 mm (Tip: 16 mm) Tip diameter: 8 mm (Body: 12 mm) Distance from probe tip to dipole centers: 2.5 mm	
Application	General near-field measurements up to 6 GHz Field component measurements Fast automatic scanning in phantoms	

5.2.3 Test Arch Phantom & Phone Positioner

The Test Arch phantom should be positioned horizontally on a stable surface. Reference markings on the Phantom allow the complete setup of all predefined phantom positions and measurement grids by manually teaching three points in the robot. It enables easy and well defined positioning of the phone and validation dipoles as well as simple teaching of the robot (Dimensions: 370 x 370 x 370 mm). The Device reference point is set for the EUT at 6.3 mm, the Grid reference point is on the upper surface at the origin of the coordinates, and the “user point \Height Check 0.5 mm” is 0.5mm above the center, allowing verification of the gap of 0.5mm while the probe is positioned there.

The Phone Positioner supports accurate and reliable positioning of any phone with effect on near field $\leq \pm 0.5 \text{ dB}$.

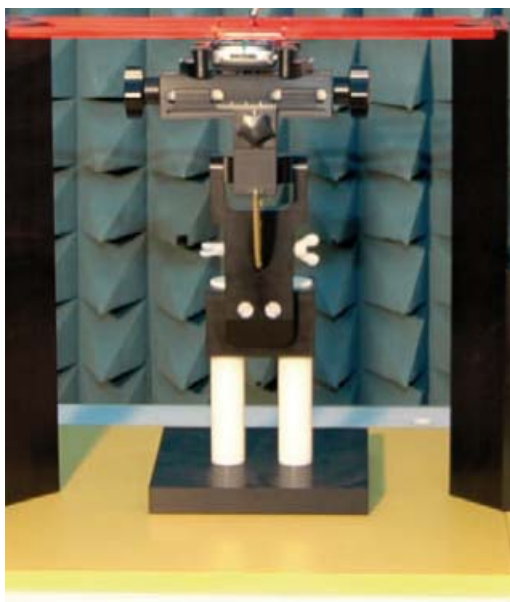

Figure 3 HAC Phantom & Device Holder

5.3 RF Test Procedures

The evaluation was performed with the following procedure:

1. Confirm proper operation of the field probe, probe measurement system and other instrumentation and the positioning system.
2. Position the WD in its intended test position. The gauge block can simplify this positioning. Note that a separate E-field gauge block will be needed if the center of the probe sensor elements is at different distances from the tip of the probe.
3. Configure the WD normal operation for maximum rated RF output power, at the desired channel and other operating parameters (e.g., test mode), as intended for the test.
4. The center sub-grid shall center on the center of the axial measurement point or the acoustic output, as appropriate. Locate the field probe at the initial test position in the 50 mm by 50 mm grid, which is contained in the measurement plane. If the field alignment method is used, align the probe for maximum field reception.
5. Record the reading.
6. Scan the entire 50 mm by 50 mm region in equally spaced increments and record the reading at each measurement point. The grid is 5 cm by 5 cm area that is divided into 9 evenly sized blocks or sub-grids. The distance between measurement points shall be sufficient to assure the identification of the maximum reading.
7. Identify the five contiguous sub-grids around the center sub-grid with the lowest maximum field strength readings. Thus the six areas to be used to determine the WD's highest emissions are identified and outlined for the final manual scan. Please note that a maximum of five blocks can be excluded for both E-field measurements for the WD output being measured. Stated another way, the center sub-grid and three others must be common to both the E-field measurements.
8. Identify the maximum field reading within the non-excluded sub-grids identified in Step 7.
9. Convert the maximum field strength reading identified in Step 8 to V/m or A/m, as appropriate. For probes which require a probe modulation factor, this conversion shall be done using the appropriate probe modulation factor and the calibration.
10. Repeat Step 1 through Step 10 for both the E-field measurements.
11. Compare this reading to the categories in ANSI C63.19 Clause 8 and record the resulting category. The lowest category number listed in 8.2, Table 8.3 obtained in Step 10 for either E-field determines the M category for the audio coupling mode assessment. Record the WD category rating.



Figure 4 WD reference and plane for RF emission measurements

5.4 System Check

Validation Procedure

Place a dipole antenna meeting the requirements given in ANSI C63.19 D.11 in the position normally occupied by the WD. The dipole antenna serves as a known source for an electrical output. Position the E-field probe so that:

The probes and their cables are parallel to the coaxial feed of the dipole antenna.

The probe cables and the coaxial feed of the dipole antenna approach the measurement area from opposite directions.

Position the E-field probe at a 15 mm distance from the center of the probe element to the top surface. Validation was performed to verify that measured E-field is within +/-18% from the target reference values provided by the manufacturer. "Values within +/-18% are acceptable. Of which 12% is deviation and 13% is measurement uncertainty."

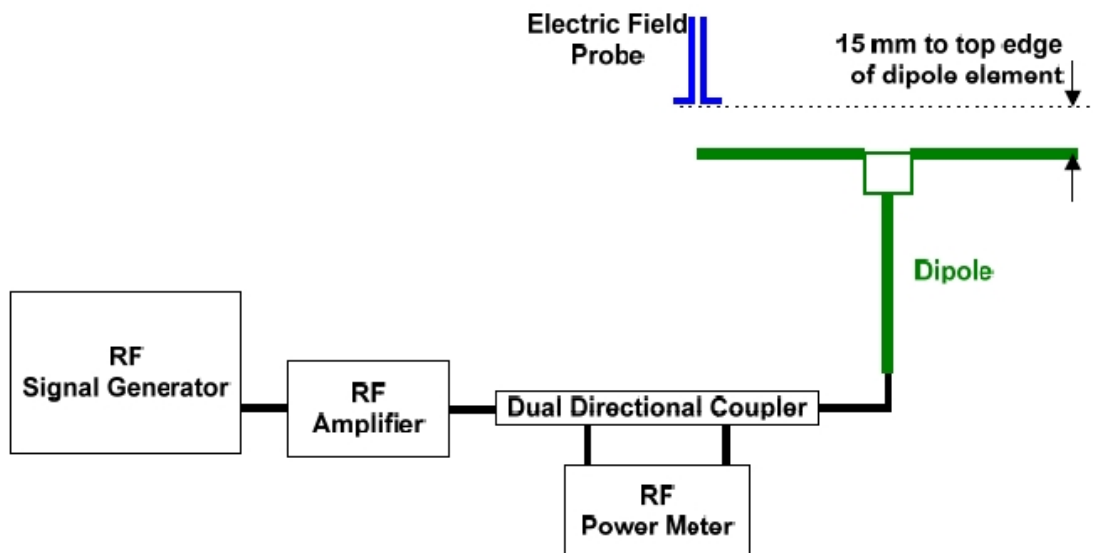

Figure 5 Dipole Validation Setup

Frequency (MHz)	Input Power (mW)	Target ¹ Value (V/m)	Measured ² Value (V/m)	Deviation ³ (%)	Test Date
835	100	106.6	107.3	-0.65	2022/9/26
1880	100	90.5	92.1	1.77	2022/9/24
2600	100	87.3	87.4	0.11	2022/9/24

5.5 Modulation Interference Factor

For any specific fixed and repeatable modulated signal, a modulation interference factor (MIF, expressed in dB) may be developed that relates its interference potential to its steady-state rms signal level or average power level. This factor is a function only of the audio-frequency amplitude modulation characteristics of the signal and is the same for field-strength and conducted power measurements. It is important to emphasize that the MIF is valid only for a specific repeatable audio-frequency amplitude modulation characteristic. Any change in modulation characteristic requires determination and application of a new MIF

The MIF may be determined using a radiated RF field or a conducted RF signal,

- b) Using RF illumination or conducted coupling, apply the specific modulated signal in question to the measurement system at a level within its confirmed operating dynamic range.
- c) Measure the steady-state rms level at the output of the fast probe or sensor.
- d) Measure the steady-state average level at the weighting output.
- e) Without changing the square-law detector or weighting system, and using RF illumination or conducted coupling, substitute for the specific modulated signal a 1kHz, 80% amplitude modulated carrier at the same frequency and adjust its strength until the level at the weighting output equals the step d) measurement.
- f) Without changing the carrier level from step e), remove the 1 kHz modulation and again measure the steady-state ms level indicated at the output of the fast probe or sensor.
- g) MIF values were not tested by a probe or as specified in the standards but are based on analysis provided by SPEAG (Version: UID_ Summary_ 210906) for all the air interfaces (GSM, WCDMA, CDMA, LTE, and Wi-Fi). The data included in this report are for the worst case operating modes. The UIDs used are listed below:

UID	Communication system	MIF(dB)
10021-DAC	GSM-FDD (TDMA, GMSK)	3.63
10011-CAB	UMTS-FDD (WCDMA)	-27.23
10170-CAE	LTE-FDD (SC-FDMA, 1 RB, 20 MHz, 16QAM)	-9.76
10176-CAG	LTE-FDD (SC-FDMA, 1 RB, 10 MHz, 16QAM)	-9.76
10173-CAG	LTE-TDD (SC-FDMA, 1 RB, 20 MHz, 16QAM)	-1.44

5.6 Justification of Held to Ear Modes Tested

5.6.1 Analysis of RF Air Interface Technologies

- a. According to the April 2013 TCB workshop slides, LTE and other OTT data services are outside the current definition of a managed CMRS service and are currently not required to be evaluated.
- b. No associated T-coil measurements for VoIP over WIFI CMRS have been made in accordance with the guidance issued by OET in KDB publication 285076 D02 T-Coil testing for CMRS IP.
- c. An analysis was performed, following the guidance of 4.3 and 4.4 of the ANSI standard, of the RF air interface technologies being evaluated. The factors that will affect the RF interference potential were evaluated, and the worst case operating modes were identified and used in the evaluation. A WD's interference potential is a function both of the WD's average near-field field strength and of the signal's audio-frequency amplitude modulation characteristics. Per 4.4, RF air interface technologies that have low power have been found to produce sufficiently low RF interference potential, So it is possible to exempt them from the product testing specified in Clause 5 of the ANSI standard. An RF air interface technology of a device is exempt from testing when its average antenna input power plus its MIF is <math><17\text{dBm}</math> for all of its operating modes. RF air interface technologies exempted from testing in this manner are automatically assigned an M4 rating to be used in determining the overall rating for the WD.

The worst case MIF plus the worst case average antenna input power for all modes are investigated below to determine the testing requirements for this device.

5.6.2 Average Antenna Input Power & Evaluation for Low-power Exemption

An RF air interface technology of a device is exempt from testing when its average antenna input power plus its **MIF is ≤ 17 dBm** for any of its operating modes. If a device supports multiple RF air interfaces, each RF air interface shall be evaluated individually.

Band	Maximum Average Antenna Input Power (dBm)	Worst Case MIF (dB)	Maximum Average Antenna Input Power + MIF (dBm)	Low power exemption
GSM 850	32.00	3.63	35.63	No
GSM 1900	29.50	3.63	33.13	No
WCDMA Band II	22.00	-27.23	-5.23	Yes
WCDMA Band IV	22.50	-27.23	-4.73	Yes
WCDMA Band V	22.50	-27.23	-4.73	Yes
LTE FDD 2	24.50	-9.76	14.74	Yes
LTE FDD 4	24.50	-9.76	14.74	Yes
LTE FDD 5	24.00	-9.76	14.24	Yes
LTE FDD 7	25.00	-9.76	15.24	Yes
LTE FDD 12	24.00	-9.76	14.24	Yes
LTE FDD 13	24.00	-9.76	14.24	Yes
LTE FDD 17	24.00	-9.76	14.24	Yes
LTE TDD 41	25.50	-1.44	24.06	No
LTE FDD 66	25.00	-9.76	15.24	Yes
LTE FDD 71	24.00	-9.76	14.24	Yes

Note: 1. MIF values applied in this test report were provided by the HAC equipment provider, SPEAG.



6 Test Results

6.1 ANSI C63.19-2011 Limits

Category	Telephone RF parameters < 960 MHz	Telephone RF parameters > 960 MHz
Near field	E-field emissions	
Category M1	50 to 55 dB (V/m)	40 to 45 dB (V/m)
Category M2	45 to 50 dB (V/m)	35 to 40 dB (V/m)
Category M3	40 to 45 dB (V/m)	30 to 35 dB (V/m)
Category M4	< 40 dB (V/m)	< 30 dB (V/m)



6.2 Summary Test Results

Band	Channel /Frenqucy (MHz)	MIF (dB)	E-field (dBV/m)	Power Drift (dB)	Category	Graph Results
GSM 850	128/824.2	3.63	37.05	0.04	M4	1
	190/836.6	3.63	36.75	-3.43	M4	2
	251/848.8	3.63	33.33	-0.41	M4	3
GSM 1900	512/1850.2	3.63	23.36	-0.10	M4	4
	661/1880	3.63	23.46	0.15	M4	5
	810/1909.8	3.63	23.93	0.03	M4	6
LTE TDD 41	39750/2506	-1.44	22.76	-0.78	M4	7
	40620/2593	-1.44	22.72	-0.02	M4	8
	41490/2680	-1.44	21.78	-1.85	M4	9



7 Measurement Uncertainty

Measurement uncertainty evaluation template for DUT HAC RF test

Error source	Type	Uncertainty Value (\pm %)	Prob. Dist.	k	c_i/E	c_i/H	Standard Uncertainty u_i (\pm %)	Degree of freedom v_{eff} or v_i
Measurement system								
Probe Calibration	B	5.1	N	1	1	1	5.1	∞
Axial Isotropy	B	4.7	R	1.732	1	1	2.7	∞
Sensor Displacement	B	16.5	R	1.732	1	0.145	9.5	∞
Boundary Effects	B	2.4	R	1.732	1	1	1.4	∞
Test Arch	B	7.2	R	1.732	1	0	4.2	∞
Linearity	B	4.7	R	1.732	1	1	2.7	∞
Scaling to Peak Envelope Power	B	2.0	R	1.732	1	1	1.2	∞
System Detection Limit	B	1.0	R	1.732	1	1	0.6	∞
Readout Electronics	B	0.3	N	1	1	1	0.3	∞
Response Time	B	0.8	R	1.732	1	1	0.5	∞
Integration Time	B	2.6	R	1.732	1	1	1.5	∞
RF Ambient Conditions	B	3.0	R	1.732	1	1	1.7	∞
RF Reflections	B	12.0	R	1.732	1	1	6.9	∞
Probe Positioner	B	1.2	R	1.732	1	0.67	0.7	∞
Probe Positioning	A	4.7	R	1.732	1	0.67	2.7	∞
Extra. And Interpolation	B	1.0	R	1.732	1	1	0.6	∞
Test sample related								
Device Positioning Vertical	B	4.7	R	1.732	1	0.67	2.7	∞
Device Positioning Lateral	B	1.0	R	1.732	1	1	0.6	∞
Device Holder and Phantom	B	2.4	R	1.732	1	1	1.4	∞
Power Drift	B	5.0	R	1.732	1	1	2.9	∞
Phantom and Setup related								
Phantom Thickness	B	2.4	R	1.732	1	0.67	1.4	∞
Combined standard uncertainty (%)							15.3	
Expanded Std. uncertainty on power (K=2)							30.6	
Expanded Std. uncertainty on field (K=2)							15.3	

8 Main Test Instruments

Name	Manufacturer	Type	Serial Number	Calibration Date	Expiration Time
Power meter	Agilent	E4417A	GB41291714	2022-05-14	2023-05-13
Power sensor	Agilent	N8481H	MY50350004	2022-05-14	2023-05-13
Signal Generator	Agilent	N5181A	MY50140143	2022-05-14	2023-05-13
Amplifier	INDEXSAR	TPA-005060G01	13030502	2022-05-14	2023-05-13
Wideband radio communication tester	R&S	CMW500	146734	2022-05-14	2023-05-13
E-Field Probe	SPEAG	EF3DV3	4048	2022-03-04	2023-03-03
DAE	SPEAG	DAE4	1317	2022-06-13	2023-06-12
Validation Kit 835MHz	SPEAG	CD835V3	1133	2020-10-12	2023-10-11
Validation Kit 1880MHz	SPEAG	CD1880V3	1115	2020-10-12	2023-10-11
Validation Kit 2600MHz	SPEAG	CD2600V3	1016	2021-01-18	2024-01-17
Hygrothermograph	Anymetr	HTC - 1	TY2020A001	2022-05-14	2023-05-13
HAC Phantom	SPEAG	SD HAC P01 BB	1117	/	/
DASY5 Test System	SPEAG	TX90 XL	/	/	/
Tissue Test Software	Agilent	85070	/	/	/

*****END OF REPORT *****

ANNEX A: System Check Results

HAC_System Performance Check at 835MHz_E

DUT: Dipole 835 MHz; Type: CD835V3; SN:1023

Date: 9/26/2022

Communication System: CW; Frequency: 835 MHz; Duty Cycle: 1:1

Phantom section: RF Section

DASY5 Configuration:

Sensor-Surface: 4mm (Mechanical Surface Detection)

Probe: EF3DV3 – SN4048; ConvF(1, 1, 1); Calibrated:3/4/2022

Electronics: DAE4 SN1317; Calibrated: 6/13/2022

Phantom: HAC Test Arch with AMCC; Type: SD HAC P01 BA;

Measurement SW: DASY52, Version 52.10 (4); SEMCAD X Version 14.6.14 (7483)

E Scan - measurement distance from the probe sensor center to CD835 Dipole = 15mm

2/Hearing Aid Compatibility Test (41x361x1): Measurement grid: dx=0.5000 mm, dy=0.5000 mm

Device Reference Point: 0, 0, -6.3 mm

Reference Value = 91 V/m; Power Drift = 0.003 dB

Applied MIF = 0.00 dB

Maximum value of peak Total field = 107.3 V/m

Hearing Aid Near-Field Category: M4 (AWF 0 dB)

Peak E-field in V/m

Grid 1 101.2 M4	Grid 2 104.3 M4	Grid 3 101.5 M4
Grid 4 61.2 M4	Grid 5 64.23 M4	Grid 6 62.39 M4
Grid 7 104.5 M4	Grid 8 107.3 M4	Grid 9 104.3 M4

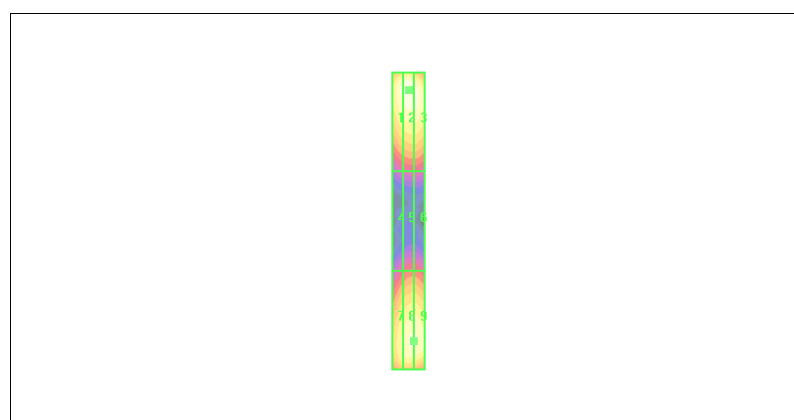
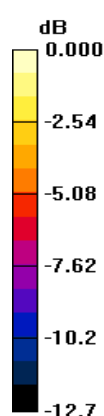



HAC_System Performance Check at 1880MHz_E

DUT: Dipole 1880 MHz; Type: CD1880V3; SN: 1018

Date: 9/24/2022

Communication System: CW; Frequency: 1880 MHz;Duty Cycle: 1:1

Phantom section: RF Section

DASY5 Configuration:

Sensor-Surface: 4mm (Mechanical Surface Detection)

Probe: EF3DV3 – SN4048; ConvF(1, 1, 1); Calibrated:3/4/2022

Electronics: DAE4 SN1317; Calibrated: 6/13/2022

Phantom: HAC Test Arch with AMCC; Type: SD HAC P01 BA;

Measurement SW: DASY52, Version 52.10 (4); SEMCAD X Version 14.6.14 (7483)

E Scan - measurement distance from the probe sensor center to CD1880 Dipole = 15mm/Hearing Aid Compatibility Test (41x181x1): Measurement grid: dx=0.5000 mm, dy=0.5000 mm

Device Reference Point: 0, 0, -6.3 mm

Reference Value = 86V/m; Power Drift = 0.002 dB

Applied MIF = 0.00 dB

Maximum value of peak Total field = 92.1 V/m

Hearing Aid Near-Field Category: M2 (AWF 0 dB)

Peak E-field in V/m

Grid 1 91.78 M2	Grid 2 98.10 M2	Grid 3 93.42M2
Grid 4 71.76 M3	Grid 5 73.56 M3	Grid 6 71.17 M3
Grid 7 87.15 M2	Grid 8 89.46 M2	Grid 9 89.01 M2

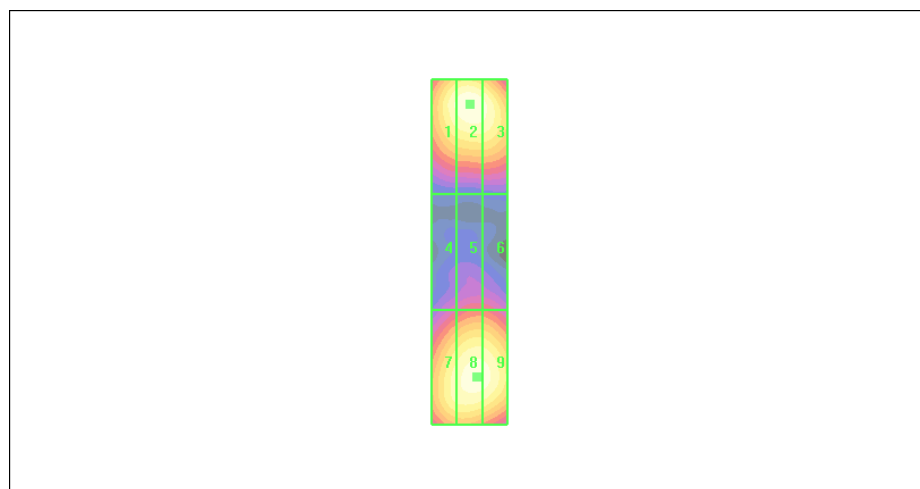
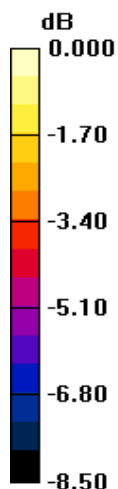

0 dB = 98.10V/m



HAC_System Performance Check at 2600MHz_E

DUT: Dipole 2600 MHz; Type: CD2600V3; SN: 1016

Date: 9/24/2022

Communication System: CW; Frequency: 2600 MHz;Duty Cycle: 1:1

Ambient Temperature:22.3 °C

Phantom section: RF Section

DASY5 Configuration:

Sensor-Surface: 0mm (Mechanical Surface Detection)

Probe: EF3DV3 – SN4048; ConvF(1, 1, 1); Calibrated:3/4/2022

Electronics: DAE4 SN1317; Calibrated: 6/13/2022

Phantom: HAC Test Arch with AMCC; Type: SD HAC P01 BA;

Measurement SW: DASY52, Version 52.10 (4); SEMCAD X Version 14.6.14 (7483)

E Scan - measurement distance from the probe sensor center to CD2600 Dipole =

15mm/Hearing Aid Compatibility Test (41x181x1): Measurement grid: dx=0.5000 mm, dy=0.5000 mm

Maximum value of peak Total field = 87.40 V/m

Applied MIF = 0.00 dB

Device Reference Point: 0, 0, -6.3 mm

Reference Value = 71.52V/m; Power Drift = 0.01 dB

Hearing Aid Near-Field Category: M2 (AWF 0 dB)

Peak E-field in V/m

Grid 1	Grid 2	Grid 3
83.35 M2	86.32 M2	85.70M2
Grid 4	Grid 5	Grid 6
79.62 M3	81.46 M3	81.15 M3
Grid 7	Grid 8	Grid 9
84.28 M2	87.40 M2	86.59 M2

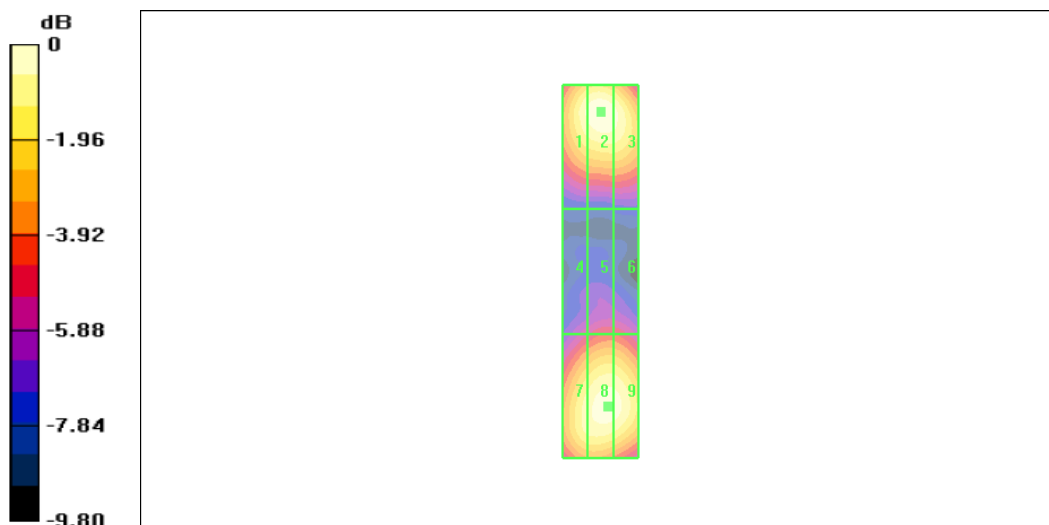

ANNEX B: Graph Results

Plot 1 HAC RF E-Field GSM 850 Low

Date: 9/26/2022

Communication System: UID 10021-DAC, GSM-FDD (TDMA, GMSK); Frequency: 824.2 MHz; Duty Cycle: 1:8.30042

Medium parameters used: $\sigma = 0$ S/m, $\epsilon_r = 1$; $\rho = 1000$ kg/m³

Ambient Temperature: 22.3 °C Liquid Temperature: 21.5 °C

Phantom section: RF Section

DASY5 Configuration:

Sensor-Surface: 0mm (Mechanical Surface Detection)

Probe: EF3DV3 – SN4048; ConvF(1, 1, 1); Calibrated: 3/4/2022

Electronics: DAE4 SN1317; Calibrated: 6/13/2022

Phantom: HAC Test Arch with AMCC; Type: SD HAC P01 BA;

Measurement SW: DASY52, Version 52.10 (4); SEMCAD X Version 14.6.14 (7483)

GSM 850 HAC RF E-Field/E Scan - ER3D: 15 mm from Probe Center to the Device Low/Hearing Aid Compatibility Test (101x101x1): Interpolated grid: dx=0.5000 mm, dy=0.5000 mm

Device Reference Point: 0, 0, -6.3 mm

Reference Value = 60.20 V/m; Power Drift = 0.04 dB

Applied MIF = 3.63 dB

RF audio interference level = 37.05 dBV/m

Emission category: M4

MIF scaled E-field

Grid 1 M4 35.93 dBV/m	Grid 2 M4 36.91 dBV/m	Grid 3 M4 36.78 dBV/m
Grid 4 M4 35.72 dBV/m	Grid 5 M4 37.05 dBV/m	Grid 6 M4 36.93 dBV/m
Grid 7 M4 35.34 dBV/m	Grid 8 M4 36.8 dBV/m	Grid 9 M4 36.7 dBV/m

Cursor:

Total = 37.05 dBV/m

E Category: M4

Location: -5, -0.5, 7.7 mm

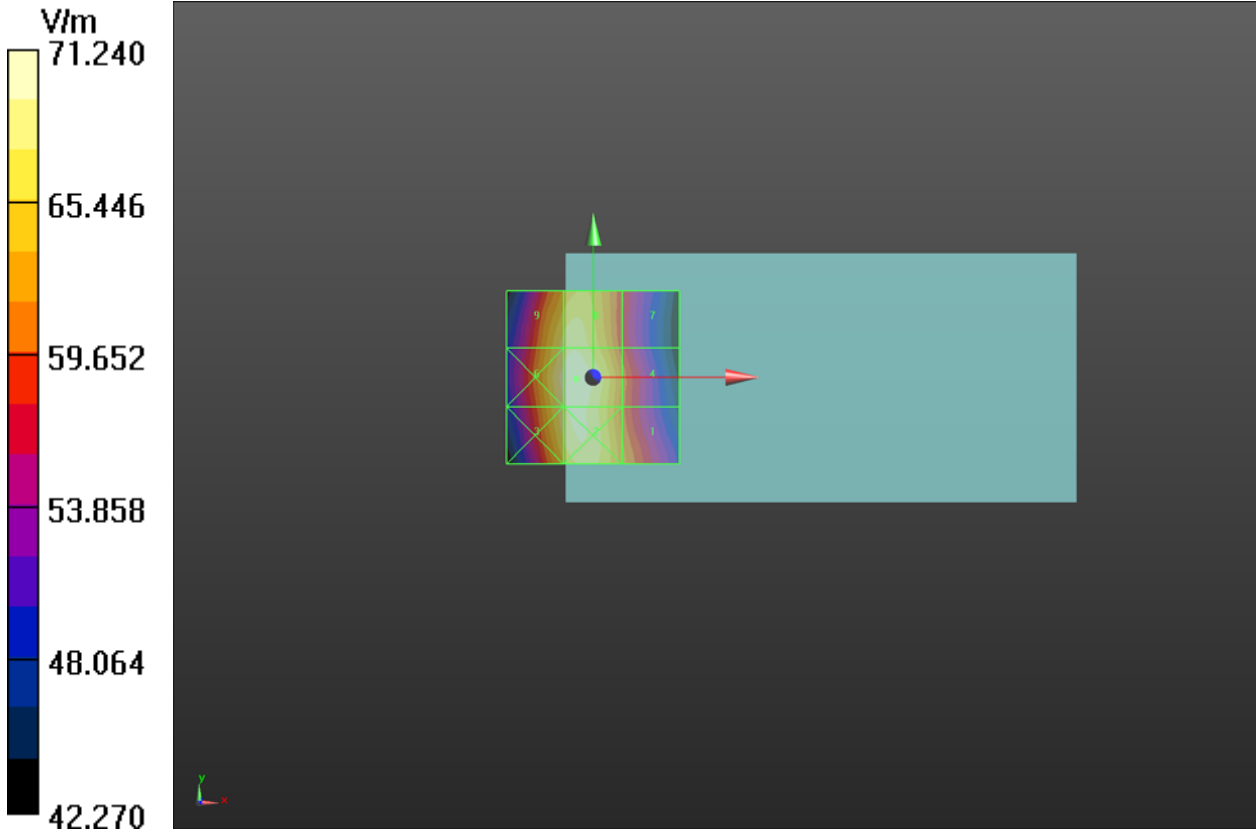



Plot 2 HAC RF E-Field GSM 850 Middle

Date: 9/26/2022

Communication System: UID 10021-DAC, GSM-FDD (TDMA, GMSK); Frequency: 836.6 MHz; Duty Cycle: 1:8.30042

Medium parameters used: $\sigma = 0$ S/m, $\epsilon_r = 1$; $\rho = 1000$ kg/m³

Ambient Temperature: 22.3 °C Liquid Temperature: 21.5 °C

Phantom section: RF Section

DASY5 Configuration:

Sensor-Surface: 1.4mm (Mechanical Surface Detection)

Probe: EF3DV3 – SN4048; ConvF(1, 1, 1); Calibrated: 3/4/2022

Electronics: DAE4 SN1317; Calibrated: 6/13/2022

Phantom: HAC Test Arch with AMCC; Type: SD HAC P01 BA;

Measurement SW: DASY52, Version 52.10 (4); SEMCAD X Version 14.6.14 (7483)

GSM 850 HAC RF E-Field/E Scan - ER3D: 15 mm from Probe Center to the Device Middle/Hearing Aid Compatibility Test (101x101x1): Interpolated grid: dx=0.5000 mm, dy=0.5000 mm

Device Reference Point: 0, 0, -6.3 mm

Reference Value = 6.565 V/m; Power Drift = -3.43 dB

Applied MIF = 3.63 dB

RF audio interference level = 36.75 dBV/m

Emission category: M4

MIF scaled E-field

Grid 1 M4 18.63 dBV/m	Grid 2 M4 26.87 dBV/m	Grid 3 M4 36.16 dBV/m
Grid 4 M4 18.45 dBV/m	Grid 5 M4 36.75 dBV/m	Grid 6 M4 30.56 dBV/m
Grid 7 M4 17.44 dBV/m	Grid 8 M4 35.08 dBV/m	Grid 9 M4 34.38 dBV/m

Cursor:

Total = 36.75 dBV/m

E Category: M4

Location: 0, 5, 7.7 mm

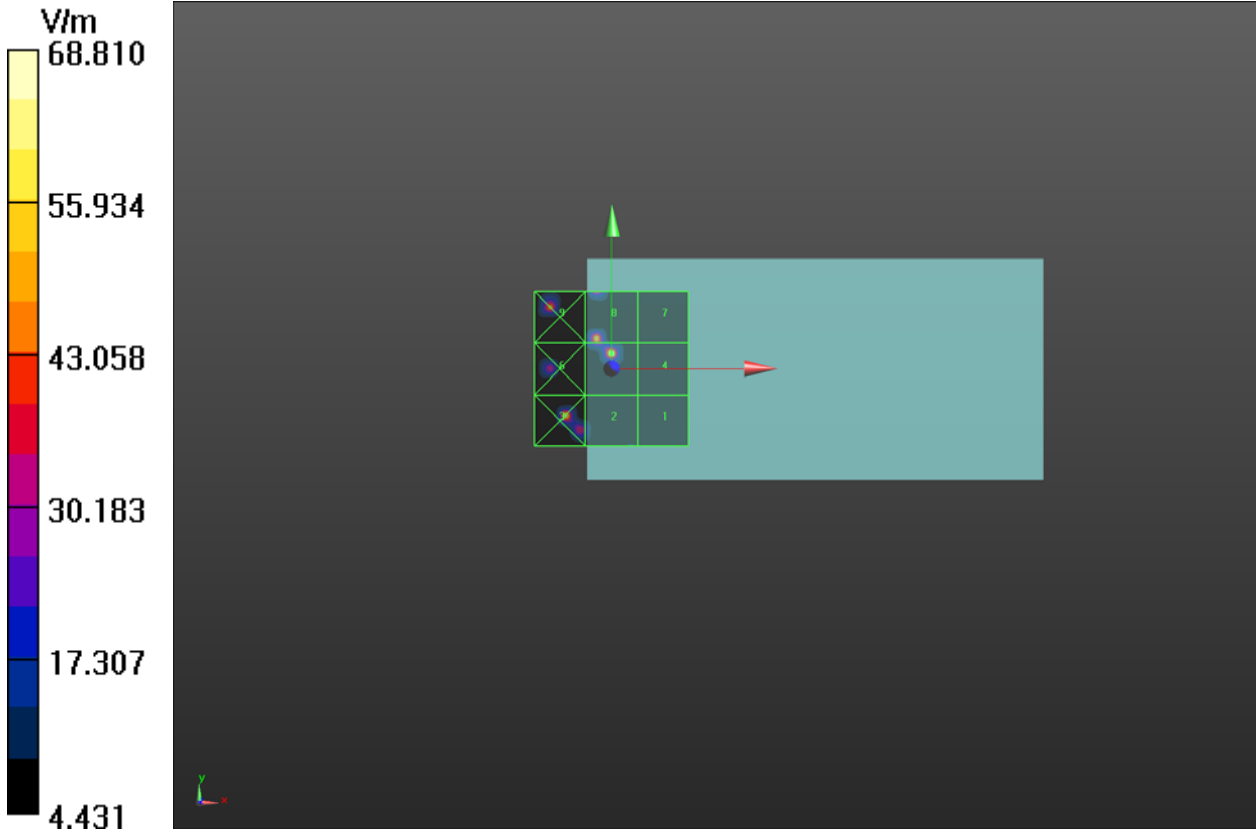

**Plot 3 HAC RF E-Field GSM 850 High**

Date: 9/26/2022

Communication System: UID 10021-DAC, GSM-FDD (TDMA, GMSK); Frequency: 848.8 MHz; Duty Cycle: 1:8.30042

Medium parameters used: $\sigma = 0$ S/m, $\epsilon_r = 1$; $\rho = 1000$ kg/m³

Ambient Temperature: 22.3 °C Liquid Temperature: 21.5 °C

Phantom section: RF Section

DASY5 Configuration:

Sensor-Surface: 0mm (Mechanical Surface Detection)

Probe: EF3DV3 – SN4048; ConvF(1, 1, 1); Calibrated: 3/4/2022

Electronics: DAE4 SN1317; Calibrated: 6/13/2022

Phantom: HAC Test Arch with AMCC; Type: SD HAC P01 BA;

Measurement SW: DASY52, Version 52.10 (4); SEMCAD X Version 14.6.14 (7483)

GSM 850 HAC RF E-Field/E Scan - ER3D: 15 mm from Probe Center to the Device High/Hearing**Aid Compatibility Test (101x101x1):** Interpolated grid: dx=0.5000 mm, dy=0.5000 mm

Device Reference Point: 0, 0, -6.3 mm

Reference Value = 4.554 V/m; Power Drift = -0.41 dB

Applied MIF = 3.63 dB

RF audio interference level = 33.33 dBV/m

Emission category: M4

MIF scaled E-field

Grid 1 M4 17.15 dBV/m	Grid 2 M4 33.33 dBV/m	Grid 3 M4 19.31 dBV/m
Grid 4 M4 17.73 dBV/m	Grid 5 M4 17.72 dBV/m	Grid 6 M4 34.76 dBV/m
Grid 7 M4 17.3 dBV/m	Grid 8 M4 37.68 dBV/m	Grid 9 M4 37.32 dBV/m

Cursor:

Total = 37.68 dBV/m

E Category: M4

Location: -5.5, 20, 7.7 mm

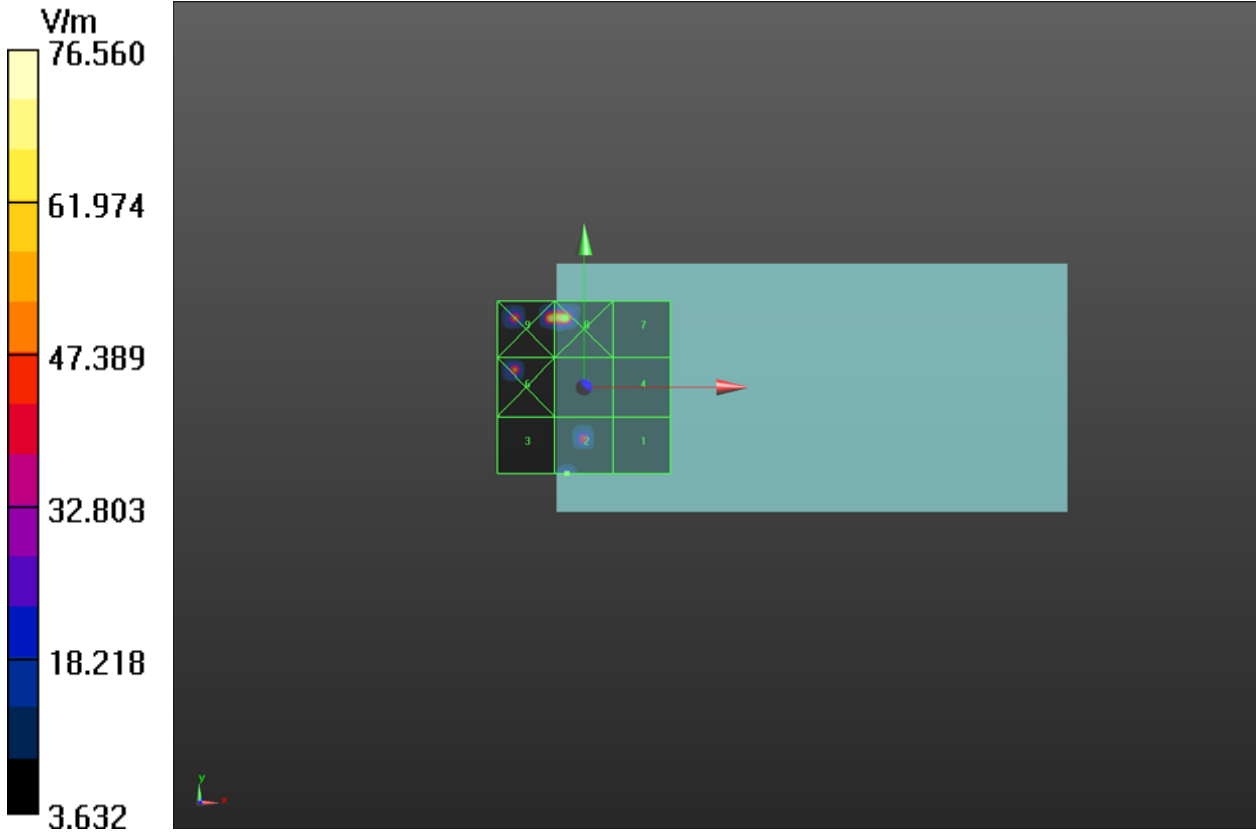

**Plot 4 HAC RF E-Field GSM 1900 Low**

Date: 9/24/2022

Communication System: UID 10021-DAC, GSM-FDD (TDMA, GMSK); Frequency: 1850.2 MHz; Duty Cycle: 1:8.30042

Medium parameters used: $\sigma = 0$ S/m, $\epsilon_r = 1$; $\rho = 1000$ kg/m³

Ambient Temperature: 22.3 °C Liquid Temperature: 21.5 °C

Phantom section: RF Section

DASY5 Configuration:

Sensor-Surface: 0mm (Mechanical Surface Detection)

Probe: EF3DV3 – SN4048; ConvF(1, 1, 1); Calibrated: 3/4/2022

Electronics: DAE4 SN1317; Calibrated: 6/13/2022

Phantom: HAC Test Arch with AMCC; Type: SD HAC P01 BA;

Measurement SW: DASY52, Version 52.10 (4); SEMCAD X Version 14.6.14 (7483)

GSM 1900 HAC RF E-Field/E Scan - ER3D: 15 mm from Probe Center to the Device Low/Hearing Aid Compatibility Test (101x101x1): Interpolated grid: dx=0.5000 mm, dy=0.5000 mm

Device Reference Point: 0, 0, -6.3 mm

Reference Value = 10.79 V/m; Power Drift = -0.10 dB

Applied MIF = 3.63 dB

RF audio interference level = 23.36 dBV/m

Emission category: M4

MIF scaled E-field

Grid 1 M4 20.91 dBV/m	Grid 2 M4 23.68 dBV/m	Grid 3 M4 23.7 dBV/m
Grid 4 M4 20.25 dBV/m	Grid 5 M4 23.36 dBV/m	Grid 6 M4 23.35 dBV/m
Grid 7 M4 23.16 dBV/m	Grid 8 M4 22.27 dBV/m	Grid 9 M4 22.22 dBV/m

Cursor:

Total = 23.70 dBV/m

E Category: M4

Location: -9.5, -15.5, 7.7 mm

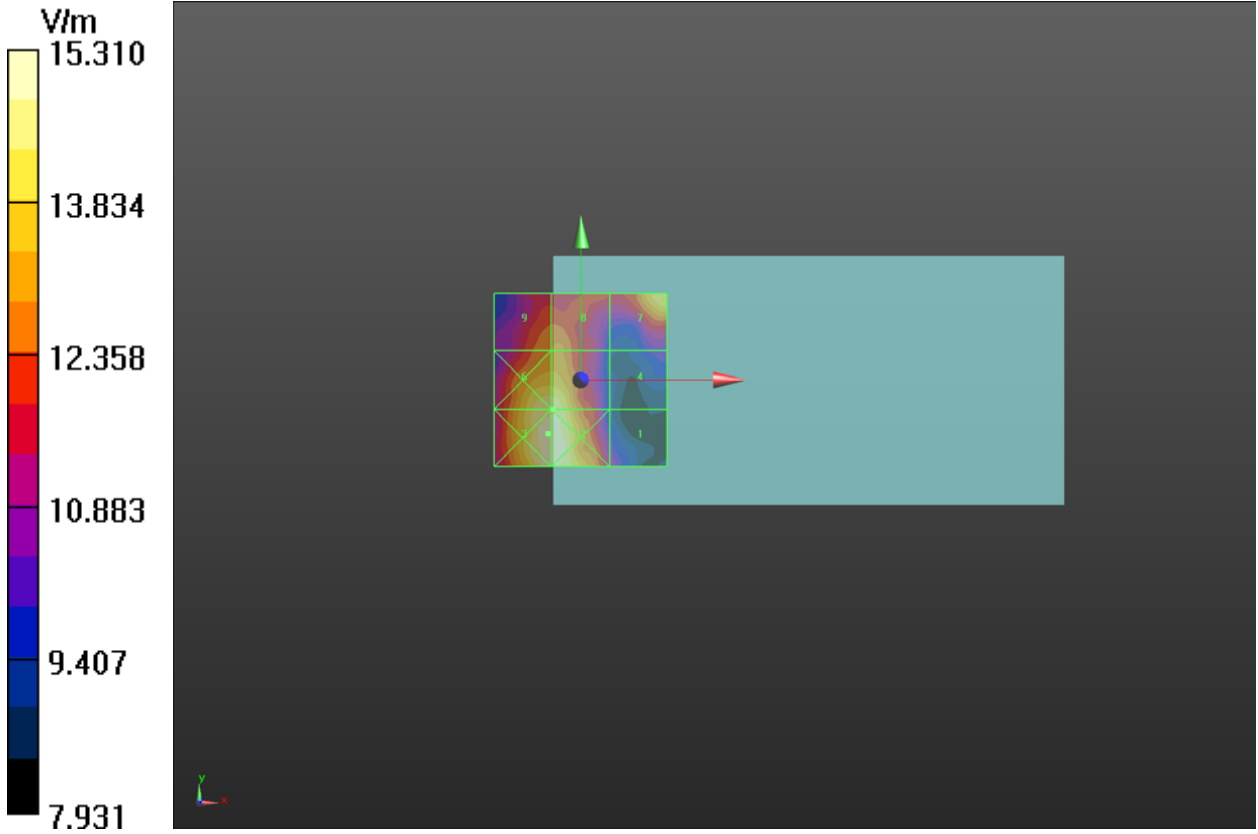



Plot 5 HAC RF E-Field GSM 1900 Middle

Date: 9/24/2022

Communication System: UID 10021-DAC, GSM-FDD (TDMA, GMSK); Frequency: 1880 MHz;Duty Cycle: 1:8.30042

Medium parameters used: $\sigma = 0$ S/m, $\epsilon_r = 1$; $\rho = 1000$ kg/m³

Ambient Temperature:22.3 °C Liquid Temperature: 21.5°C

Phantom section: RF Section

DASY5 Configuration:

Sensor-Surface: 0mm (Mechanical Surface Detection)

Probe: EF3DV3 – SN4048; ConvF(1, 1, 1); Calibrated:3/4/2022

Electronics: DAE4 SN1317; Calibrated: 6/13/2022

Phantom: HAC Test Arch with AMCC; Type: SD HAC P01 BA;

Measurement SW: DASY52, Version 52.10 (4); SEMCAD X Version 14.6.14 (7483)

GSM 1900 HAC RF E-Field/E Scan - ER3D: 15 mm from Probe Center to the Device Middle/Hearing Aid Compatibility Test (101x101x1): Interpolated grid: dx=0.5000 mm, dy=0.5000 mm

Device Reference Point: 0, 0, -6.3 mm

Reference Value = 10.53 V/m; Power Drift = 0.15 dB

Applied MIF = 3.63 dB

RF audio interference level = 23.46 dBV/m

Emission category: M4

MIF scaled E-field

Grid 1 M4 20.18 dBV/m	Grid 2 M4 23.45 dBV/m	Grid 3 M4 23.46 dBV/m
Grid 4 M4 20.23 dBV/m	Grid 5 M4 23.13 dBV/m	Grid 6 M4 23.13 dBV/m
Grid 7 M4 23.49 dBV/m	Grid 8 M4 22.27 dBV/m	Grid 9 M4 21.89 dBV/m

Cursor:

Total = 23.49 dBV/m

E Category: M4

Location: 25, 25, 7.7 mm

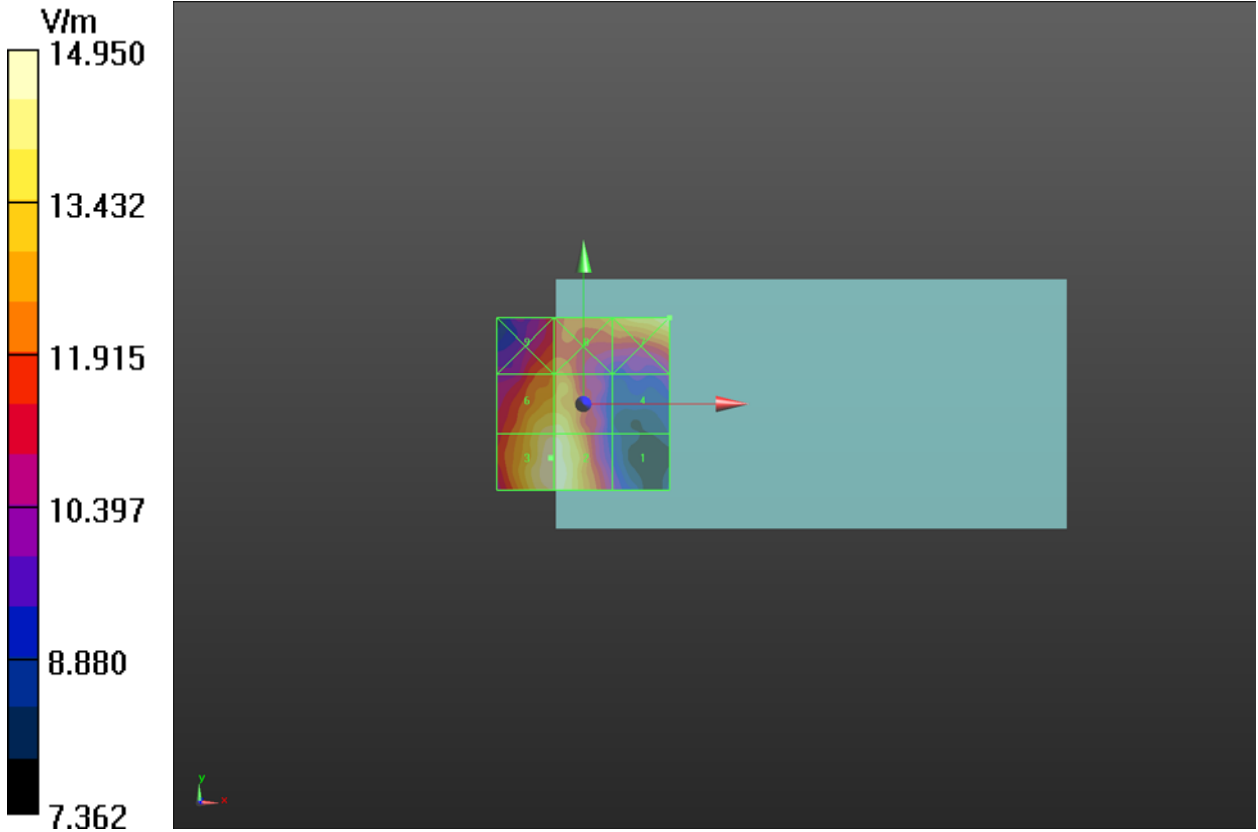

**Plot 6 HAC RF E-Field GSM 1900 High**

Date: 9/24/2022

Communication System: UID 10021-DAC, GSM-FDD (TDMA, GMSK); Frequency: 1909.8 MHz; Duty Cycle: 1:8.30042

Medium parameters used: $\sigma = 0$ S/m, $\epsilon_r = 1$; $\rho = 1000$ kg/m³

Ambient Temperature: 22.3 °C Liquid Temperature: 21.5 °C

Phantom section: RF Section

DASY5 Configuration:

Sensor-Surface: 0mm (Mechanical Surface Detection)

Probe: EF3DV3 – SN4048; ConvF(1, 1, 1); Calibrated: 3/4/2022

Electronics: DAE4 SN1317; Calibrated: 6/13/2022

Phantom: HAC Test Arch with AMCC; Type: SD HAC P01 BA;

Measurement SW: DASY52, Version 52.10 (4); SEMCAD X Version 14.6.14 (7483)

GSM 1900 HAC RF E-Field/E Scan - ER3D: 15 mm from Probe Center to the Device High/Hearing Aid Compatibility Test (101x101x1): Interpolated grid: dx=0.5000 mm, dy=0.5000 mm

Device Reference Point: 0, 0, -6.3 mm

Reference Value = 11.62 V/m; Power Drift = 0.03 dB

Applied MIF = 3.63 dB

RF audio interference level = 23.93 dBV/m

Emission category: M4

MIF scaled E-field

Grid 1 M4 20.1 dBV/m	Grid 2 M4 23.93 dBV/m	Grid 3 M4 23.91 dBV/m
Grid 4 M4 20.67 dBV/m	Grid 5 M4 23.67 dBV/m	Grid 6 M4 23.69 dBV/m
Grid 7 M4 24.11 dBV/m	Grid 8 M4 23.41 dBV/m	Grid 9 M4 23.11 dBV/m

Cursor:

Total = 24.11 dBV/m

E Category: M4

Location: 24.5, 25, 7.7 mm

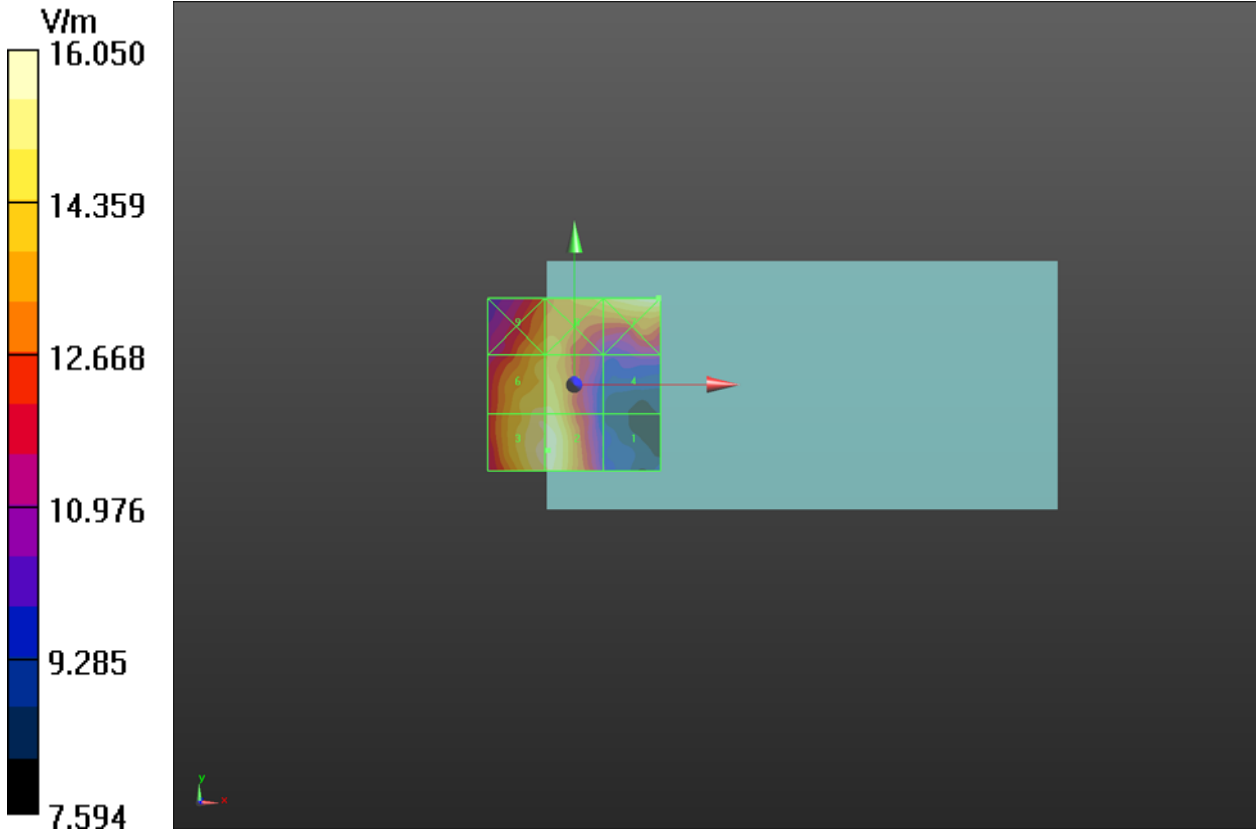



Plot 7 HAC RF E-Field LTE Band 41 Low

Date: 9/24/2022

Communication System: UID 10173-CAG, LTE-TDD (SC-FDMA, 1 RB, 20 MHz, 16QAM); Frequency: 2506 MHz; Duty Cycle: 1:6.79047

Medium parameters used: $\sigma = 0$ S/m, $\epsilon_r = 1$; $\rho = 1000$ kg/m³

Ambient Temperature: 22.3 °C Liquid Temperature: 21.5 °C

Phantom section: RF Section

DASY5 Configuration:

Sensor-Surface: 0mm (Mechanical Surface Detection)

Probe: EF3DV3 – SN4048; ConvF(1, 1, 1); Calibrated: 3/4/2022

Electronics: DAE4 SN1317; Calibrated: 6/13/2022

Phantom: HAC Test Arch with AMCC; Type: SD HAC P01 BA;

Measurement SW: DASY52, Version 52.10 (4); SEMCAD X Version 14.6.14 (7483)

LTE B41 HAC RF E-Field/E Scan - ER3D: 15 mm from Probe Center to the Device Low/Hearing Aid Compatibility Test (101x101x1): Interpolated grid: dx=0.5000 mm, dy=0.5000 mm

Device Reference Point: 0, 0, -6.3 mm

Reference Value = 21.36 V/m; Power Drift = -0.78 dB

Applied MIF = -1.44 dB

RF audio interference level = 22.76 dBV/m

Emission category: M4

MIF scaled E-field

Grid 1 M4 27.01 dBV/m	Grid 2 M4 22.7 dBV/m	Grid 3 M4 22.76 dBV/m
Grid 4 M4 27.62 dBV/m	Grid 5 M4 22.69 dBV/m	Grid 6 M4 22.75 dBV/m
Grid 7 M4 27.27 dBV/m	Grid 8 M4 20.41 dBV/m	Grid 9 M4 20.6 dBV/m

Cursor:

Total = 27.62 dBV/m

E Category: M4

Location: 23, 2.5, 7.7 mm

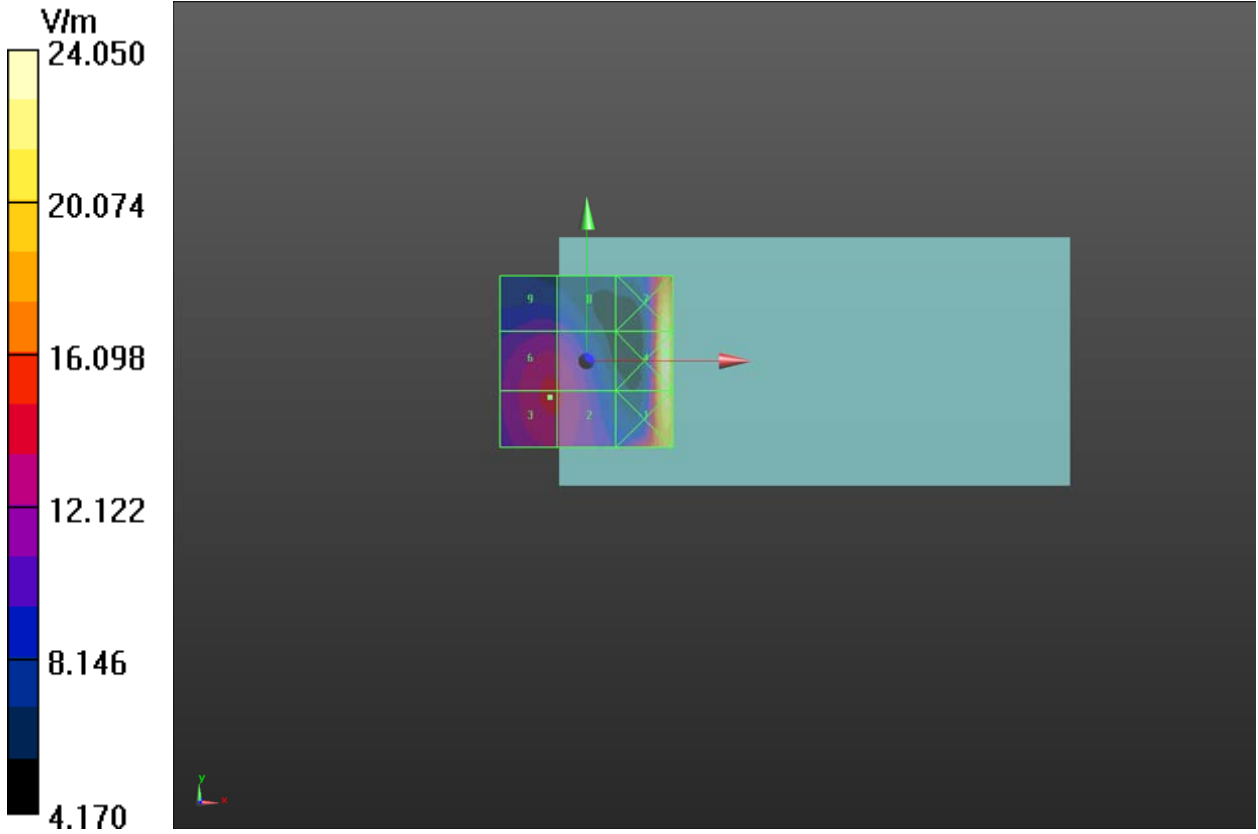

**Plot 8 HAC RF E-Field LTE Band 41 Middle**

Date: 9/24/2022

Communication System: UID 10173-CAG, LTE-TDD (SC-FDMA, 1 RB, 20 MHz, 16QAM); Frequency: 2593 MHz; Duty Cycle: 1:6.79047

Medium parameters used: $\sigma = 0$ S/m, $\epsilon_r = 1$; $\rho = 1000$ kg/m³

Ambient Temperature: 22.3 °C Liquid Temperature: 21.5 °C

Phantom section: RF Section

DASY5 Configuration:

Sensor-Surface: 0mm (Mechanical Surface Detection)

Probe: EF3DV3 – SN4048; ConvF(1, 1, 1); Calibrated: 3/4/2022

Electronics: DAE4 SN1317; Calibrated: 6/13/2022

Phantom: HAC Test Arch with AMCC; Type: SD HAC P01 BA;

Measurement SW: DASY52, Version 52.10 (4); SEMCAD X Version 14.6.14 (7483)

LTE B41 HAC RF E-Field/E Scan - ER3D: 15 mm from Probe Center to the Device Middle/Hearing Aid Compatibility Test (101x101x1): Interpolated grid: dx=0.5000 mm, dy=0.5000 mm

Device Reference Point: 0, 0, -6.3 mm

Reference Value = 18.33 V/m; Power Drift = -0.02 dB

Applied MIF = -1.44 dB

RF audio interference level = 22.72 dBV/m

Emission category: M4

MIF scaled E-field

Grid 1 M4 23.19 dBV/m	Grid 2 M4 23.36 dBV/m	Grid 3 M4 23.31 dBV/m
Grid 4 M4 18.4 dBV/m	Grid 5 M4 22.72 dBV/m	Grid 6 M4 22.72 dBV/m
Grid 7 M4 15.2 dBV/m	Grid 8 M4 18.39 dBV/m	Grid 9 M4 18.63 dBV/m

Cursor:

Total = 23.36 dBV/m

E Category: M4

Location: -6.5, -20.5, 7.7 mm

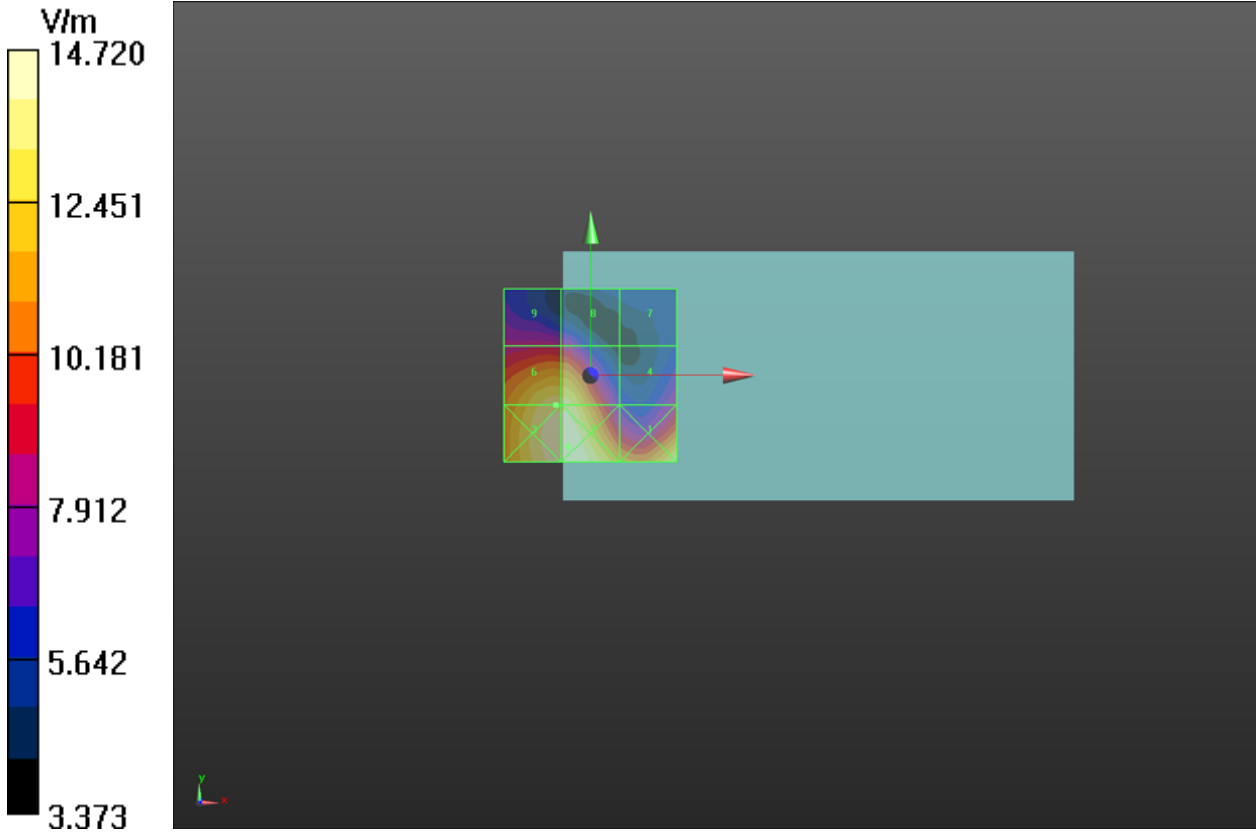

**Plot 9 HAC RF E-Field LTE Band 41 High**

Date: 9/24/2022

Communication System: UID 10173-CAG, LTE-TDD (SC-FDMA, 1 RB, 20 MHz, 16QAM); Frequency: 2680 MHz; Duty Cycle: 1:6.79047

Medium parameters used: $\sigma = 0$ S/m, $\epsilon_r = 1$; $\rho = 1000$ kg/m³

Ambient Temperature: 22.3 °C Liquid Temperature: 21.5 °C

Phantom section: RF Section

DASY5 Configuration:

Sensor-Surface: 0mm (Mechanical Surface Detection)

Probe: EF3DV3 – SN4048; ConvF(1, 1, 1); Calibrated: 3/4/2022

Electronics: DAE4 SN1317; Calibrated: 6/13/2022

Phantom: HAC Test Arch with AMCC; Type: SD HAC P01 BA;

Measurement SW: DASY52, Version 52.10 (4); SEMCAD X Version 14.6.14 (7483)

LTE B41 HAC RF E-Field/E Scan - ER3D: 15 mm from Probe Center to the Device High/Hearing**Aid Compatibility Test (101x101x1):** Interpolated grid: dx=0.5000 mm, dy=0.5000 mm

Device Reference Point: 0, 0, -6.3 mm

Reference Value = 15.98 V/m; Power Drift = -1.85 dB

Applied MIF = -1.44 dB

RF audio interference level = 21.78 dBV/m

Emission category: M4

MIF scaled E-field

Grid 1 M4 28.06 dBV/m	Grid 2 M4 21.78 dBV/m	Grid 3 M4 21.75 dBV/m
Grid 4 M4 28.55 dBV/m	Grid 5 M4 20.33 dBV/m	Grid 6 M4 20.35 dBV/m
Grid 7 M4 28.24 dBV/m	Grid 8 M4 16.67 dBV/m	Grid 9 M4 16.29 dBV/m

Cursor:

Total = 28.55 dBV/m

E Category: M4

Location: 23, 2.5, 7.7 mm

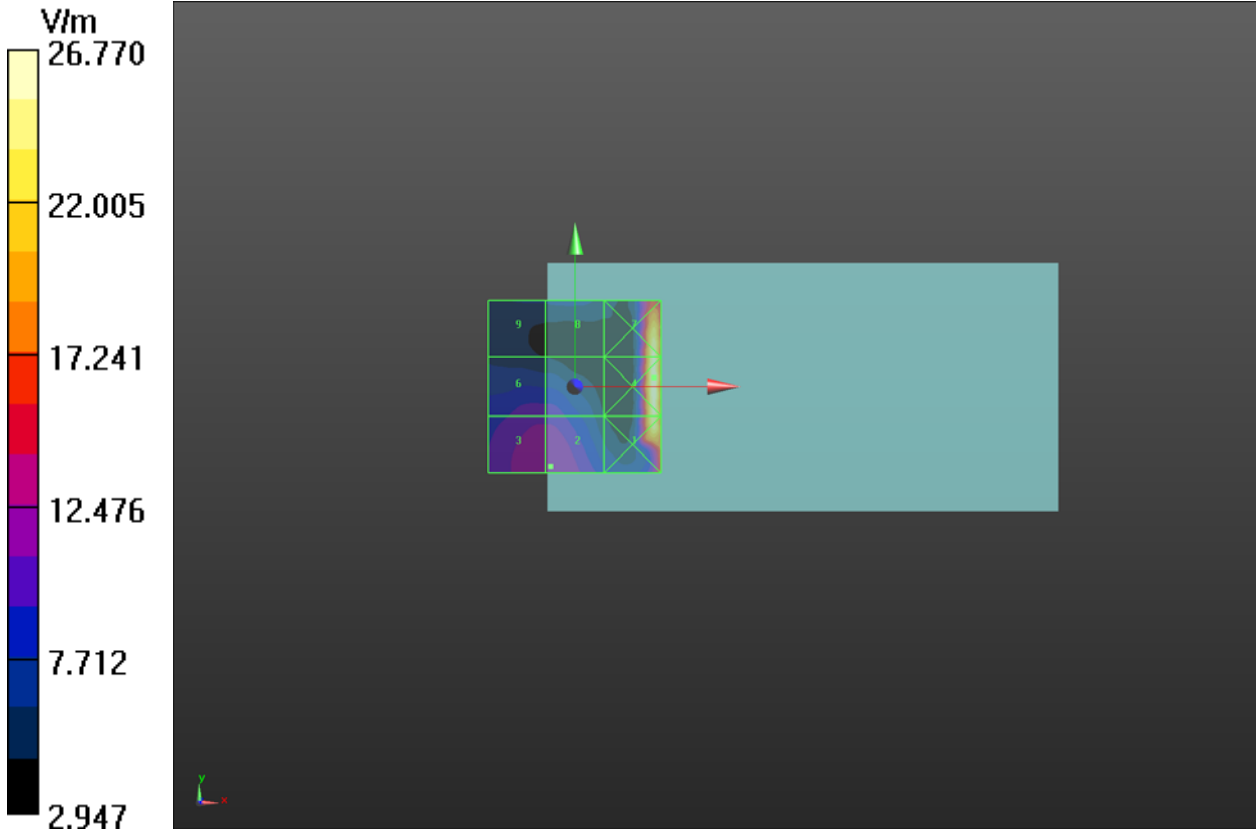



ANNEX C: E-Probe Calibration Certificate

**Calibration Laboratory of
Schmid & Partner
Engineering AG**
Zeughausstrasse 43, 8004 Zurich, Switzerland



S Schweizerischer Kalibrierdienst
S Service suisse d'étalonnage
C Servizio svizzero di taratura
S Swiss Calibration Service

Accredited by the Swiss Accreditation Service (SAS)
The Swiss Accreditation Service is one of the signatories to the EA
Multilateral Agreement for the recognition of calibration certificates

Accreditation No.: **SCS 0108**

Client **TA-SH (Auden)**

Certificate No: **EF3-4048_Mar22**

CALIBRATION CERTIFICATE

Object: **EF3DV3- SN:4048**

Calibration procedure(s): **QA CAL-02.v9, QA CAL-25.v7
Calibration procedure for E-field probes optimized for close near field evaluations in air**

Calibration date: **March 4, 2022**

This calibration certificate documents the traceability to national standards, which realize the physical units of measurements (SI). The measurements and the uncertainties with confidence probability are given on the following pages and are part of the certificate.

All calibrations have been conducted in the closed laboratory facility: environment temperature (22 ± 3)°C and humidity < 70%.

Calibration Equipment used (M&TE critical for calibration)

Primary Standards	ID	Cal Date (Certificate No.)	Scheduled Calibration
Power meter NRP	SN: 104778	09-Apr-21 (No. 217-03291/03292)	Apr-22
Power sensor NRP-Z91	SN: 103244	09-Apr-21 (No. 217-03291)	Apr-22
Power sensor NRP-Z91	SN: 103245	09-Apr-21 (No. 217-03292)	Apr-22
Reference 20 dB Attenuator	SN: CC2552 (20x)	09-Apr-21 (No. 217-03343)	Apr-22
DAE4	SN: 789	24-Dec-21 (No. DAE4-789_Dec21)	Dec-22
Reference Probe ER3DV6	SN: 2328	08-Oct-21 (No. ER3-2328_Oct21)	Oct-22
Secondary Standards	ID	Check Date (in house)	Scheduled Check
Power meter E4419B	SN: GB41293874	06-Apr-16 (in house check Jun-20)	In house check: Jun-22
Power sensor E4412A	SN: MY41498087	06-Apr-16 (in house check Jun-20)	In house check: Jun-22
Power sensor E4412A	SN: 000110210	06-Apr-16 (in house check Jun-20)	In house check: Jun-22
RF generator HP 8648C	SN: US3642U01700	04-Aug-99 (in house check Jun-20)	In house check: Jun-22
Network Analyzer E8358A	SN: US41080477	31-Mar-14 (in house check Oct-20)	In house check: Oct-22

Calibrated by:	Name Aidonia Georgiadou	Function Laboratory Technician	Signature
Approved by:	Name Sven Kühn	Function Deputy Manager	Signature

Issued: March 7, 2022

This calibration certificate shall not be reproduced except in full without written approval of the laboratory.

**Calibration Laboratory of
Schmid & Partner
Engineering AG**
Zeughausstrasse 43, 8004 Zurich, Switzerland



S Schweizerischer Kalibrierdienst
C Service suisse d'étalonnage
S Servizio svizzero di taratura
S Swiss Calibration Service

Accredited by the Swiss Accreditation Service (SAS)
The Swiss Accreditation Service is one of the signatories to the EA
Multilateral Agreement for the recognition of calibration certificates

Accreditation No.: **SCS 0108**

Glossary:

NORM _{x,y,z}	sensitivity in free space
DCP	diode compression point
CF	crest factor (1/duty_cycle) of the RF signal
A, B, C, D	modulation dependent linearization parameters
En	incident E-field orientation normal to probe axis
Ep	incident E-field orientation parallel to probe axis
Polarization φ	φ rotation around probe axis
Polarization θ	θ rotation around an axis that is in the plane normal to probe axis (at measurement center), i.e., θ = 0 is normal to probe axis
Connector Angle	information used in DASY system to align probe sensor X to the robot coordinate system

Calibration is Performed According to the Following Standards:

- a) IEEE Std 1309-2005, " IEEE Standard for calibration of electromagnetic field sensors and probes, excluding antennas, from 9 kHz to 40 GHz", December 2005
- b) CTIA Test Plan for Hearing Aid Compatibility, Rev 3.1.1, May 2017

Methods Applied and Interpretation of Parameters:

- *NORM_{x,y,z}*: Assessed for E-field polarization θ = 0 for XY sensors and θ = 90 for Z sensor (f ≤ 900 MHz in TEM-cell; f > 1800 MHz: R22 waveguide).
- *NORM(f)_{x,y,z}* = *NORM_{x,y,z}* * *frequency_response* (see Frequency Response Chart).
- *DCP_{x,y,z}*: DCP are numerical linearization parameters assessed based on the data of power sweep with CW signal (no uncertainty required). DCP does not depend on frequency nor media.
- *PAR*: PAR is the Peak to Average Ratio that is not calibrated but determined based on the signal characteristics
- *A_{x,y,z}; B_{x,y,z}; C_{x,y,z}; D_{x,y,z}; VR_{x,y,z}*: A, B, C, D are numerical linearization parameters assessed based on the data of power sweep for specific modulation signal. The parameters do not depend on frequency nor media. VR is the maximum calibration range expressed in RMS voltage across the diode.
- *Spherical isotropy (3D deviation from isotropy)*: in a locally homogeneous field realized using an open waveguide setup.
- *Sensor Offset*: The sensor offset corresponds to the offset of virtual measurement center from the probe tip (on probe axis). No tolerance required.
- *Connector Angle*: The angle is assessed using the information gained by determining the *NORM_x* (no uncertainty required).



EF3DV3 – SN:4048

March 4, 2022

DASY/EASY - Parameters of Probe: EF3DV3 - SN:4048**Basic Calibration Parameters**

	Sensor X	Sensor Y	Sensor Z	Unc (k=2)
Norm ($\mu\text{V}/(\text{V}/\text{m})^2$)	0.62	0.60	1.13	$\pm 10.1\%$
DCP (mV) ^B	102.7	101.2	96.0	

Calibration results for Frequency Response (30 MHz – 6 GHz)

Frequency MHz	Target E-Field V/m	Measured E-field (En) V/m	Deviation E-normal in %	Measured E-field (Ep) V/m	Deviation E-normal in %	Unc (k=2) %
30	77.3	77.4	0.2%	77.6	0.4%	$\pm 5.1\%$
100	77.1	78.2	1.4%	77.5	0.6%	$\pm 5.1\%$
450	77.2	78.3	1.4%	77.9	0.9%	$\pm 5.1\%$
600	77.1	77.8	1.0%	77.4	0.4%	$\pm 5.1\%$
750	77.2	77.7	0.7%	77.2	0.1%	$\pm 5.1\%$
1800	142.5	138.8	-2.6%	140.0	-1.8%	$\pm 5.1\%$
2000	135.2	131.6	-2.6%	132.2	-2.2%	$\pm 5.1\%$
2200	127.8	123.6	-3.3%	125.1	-2.1%	$\pm 5.1\%$
2500	125.6	122.5	-2.4%	124.1	-1.1%	$\pm 5.1\%$
3000	79.3	75.6	-4.7%	77.1	-2.8%	$\pm 5.1\%$
3500	257.2	248.3	-3.5%	246.2	-4.3%	$\pm 5.1\%$
3700	249.6	239.2	-4.2%	238.3	-4.5%	$\pm 5.1\%$
5200	50.8	51.4	1.3%	51.4	1.3%	$\pm 5.1\%$
5500	49.6	49.3	-0.5%	48.0	-3.3%	$\pm 5.1\%$
5800	48.9	48.6	-0.7%	49.6	1.5%	$\pm 5.1\%$

The reported uncertainty of measurement is stated as the standard uncertainty of measurement multiplied by the coverage factor k=2, which for a normal distribution corresponds to a coverage probability of approximately 95%.

^B Numerical linearization parameter: uncertainty not required.

^E Uncertainty is determined using the max. deviation from linear response applying rectangular distribution and is expressed for the square of the field value.



EF3DV3 – SN:4048

March 4, 2022

DASY/EASY - Parameters of Probe: EF3DV3 - SN:4048**Calibration Results for Modulation Response**

UID	Communication System Name		A dB	B dB $\sqrt{\mu}$ V	C	D dB	VR mV	Max dev.	Max Unc ^E (k=2)
0	CW	X	0.00	0.00	1.00	0.00	197.5	$\pm 3.0\%$	$\pm 4.7\%$
		Y	0.00	0.00	1.00		192.9		
		Z	0.00	0.00	1.00		162.7		
10352-AAA	Pulse Waveform (200Hz, 10%)	X	3.22	67.12	10.90	10.00	60.0	$\pm 0.9\%$	$\pm 9.6\%$
		Y	9.03	80.70	18.44		60.0		
		Z	20.00	92.14	22.11		60.0		
10353-AAA	Pulse Waveform (200Hz, 20%)	X	1.94	65.32	9.08	6.99	80.0	$\pm 1.0\%$	$\pm 9.6\%$
		Y	20.00	90.63	20.14		80.0		
		Z	20.00	93.23	21.31		80.0		
10354-AAA	Pulse Waveform (200Hz, 40%)	X	1.05	64.19	7.65	3.98	95.0	$\pm 1.0\%$	$\pm 9.6\%$
		Y	20.00	91.09	18.81		95.0		
		Z	20.00	98.06	22.15		95.0		
10355-AAA	Pulse Waveform (200Hz, 60%)	X	0.88	65.89	7.73	2.22	120.0	$\pm 1.1\%$	$\pm 9.6\%$
		Y	20.00	93.18	18.50		120.0		
		Z	20.00	112.58	27.62		120.0		
10387-AAA	QPSK Waveform, 1 MHz	X	1.93	69.63	16.86	1.00	150.0	$\pm 1.0\%$	$\pm 9.6\%$
		Y	2.00	67.90	16.54		150.0		
		Z	2.57	74.71	20.31		150.0		
10388-AAA	QPSK Waveform, 10 MHz	X	2.58	71.02	17.48	0.00	150.0	$\pm 0.7\%$	$\pm 9.6\%$
		Y	2.78	71.20	17.38		150.0		
		Z	3.72	77.82	21.13		150.0		
10396-AAA	64-QAM Waveform, 100 kHz	X	3.12	74.00	20.62	3.01	150.0	$\pm 0.6\%$	$\pm 9.6\%$
		Y	3.98	74.91	20.74		150.0		
		Z	3.30	73.51	20.91		150.0		
10399-AAA	64-QAM Waveform, 40 MHz	X	3.63	68.00	16.45	0.00	150.0	$\pm 0.8\%$	$\pm 9.6\%$
		Y	3.75	68.07	16.43		150.0		
		Z	4.05	70.04	17.94		150.0		
10414-AAA	WLAN CCDF, 64-QAM, 40MHz	X	4.91	66.12	15.96	0.00	150.0	$\pm 1.1\%$	$\pm 9.6\%$
		Y	5.13	66.06	15.91		150.0		
		Z	5.18	66.77	16.68		150.0		

Note: For details on UID parameters see Appendix

The reported uncertainty of measurement is stated as the standard uncertainty of measurement multiplied by the coverage factor k=2, which for a normal distribution corresponds to a coverage probability of approximately 95%.

^B Numerical linearization parameter: uncertainty not required.^E Uncertainty is determined using the max. deviation from linear response applying rectangular distribution and is expressed for the square of the field value.



EF3DV3 – SN:4048

March 4, 2022

DASY/EASY - Parameters of Probe: EF3DV3 - SN:4048**Sensor Frequency Model Parameters**

	Sensor X	Sensor Y	Sensor Z
Frequency Corr. (LF)	0.00	0.04	5.80
Frequency Corr. (HF)	2.82	2.82	2.82

Sensor Model Parameters

	C1 fF	C2 fF	α V ⁻¹	T1 ms.V ⁻²	T2 ms.V ⁻¹	T3 ms	T4 V ⁻²	T5 V ⁻¹	T6
X	46.2	300.95	36.02	8.14	0.40	4.95	1.67	0.00	1.00
Y	70.3	462.16	36.58	17.98	1.11	5.01	1.08	0.42	1.01
Z	57.3	384.37	38.30	14.54	0.86	5.05	0.22	0.44	1.00

Other Probe Parameters

Sensor Arrangement	Rectangular
Connector Angle (°)	157
Mechanical Surface Detection Mode	enabled
Optical Surface Detection Mode	disabled
Probe Overall Length	337 mm
Probe Body Diameter	12 mm
Tip Length	25 mm
Tip Diameter	4 mm
Probe Tip to Sensor X Calibration Point	1.5 mm
Probe Tip to Sensor Y Calibration Point	1.5 mm
Probe Tip to Sensor Z Calibration Point	1.5 mm

EF3DV3 – SN:4048

March 4, 2022

Receiving Pattern (ϕ), $\vartheta = 0^\circ$

f=600 MHz,TEM,0°

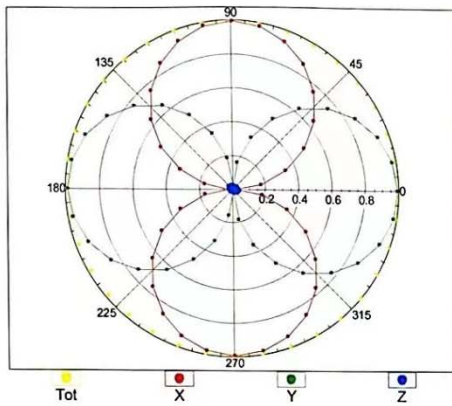

f=1800 MHz,R22,0°

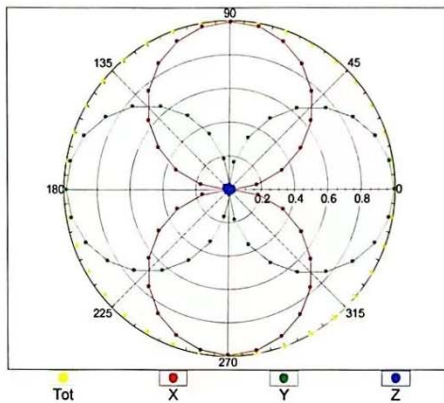

Receiving Pattern (ϕ), $\vartheta = 90^\circ$

f=600 MHz,TEM,90°

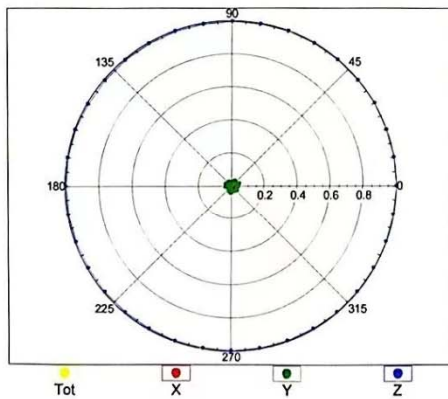

f=1800 MHz,R22,90°

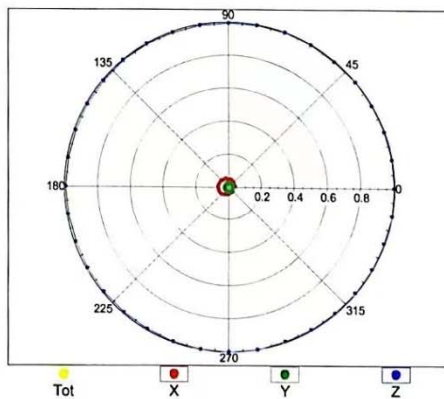

EF3DV3 – SN:4048

March 4, 2022

Receiving Pattern (ϕ), $\vartheta = 0^\circ$

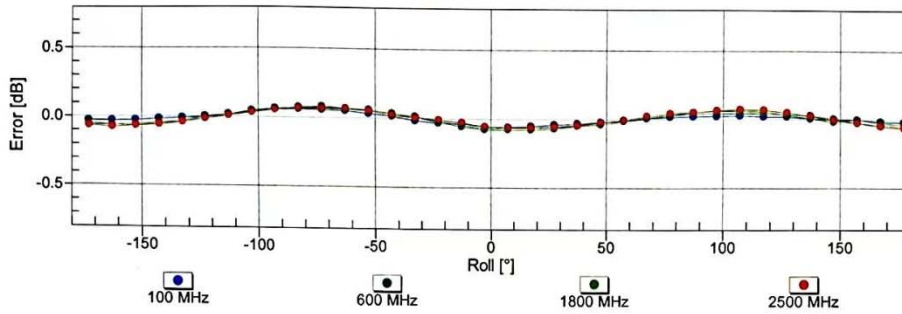

Uncertainty of Axial Isotropy Assessment: $\pm 0.5\%$ ($k=2$)

Receiving Pattern (ϕ), $\vartheta = 90^\circ$

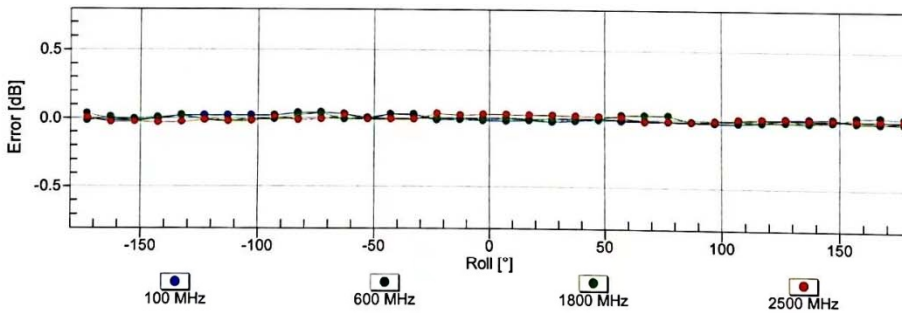

Uncertainty of Axial Isotropy Assessment: $\pm 0.5\%$ ($k=2$)



EF3DV3 – SN:4048

March 4, 2022

Dynamic Range f(E-field) (TEM cell, f = 900 MHz)

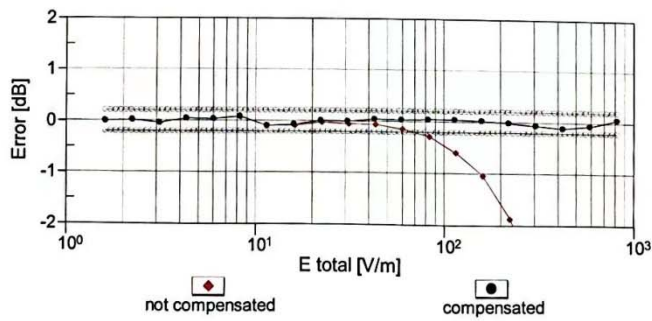
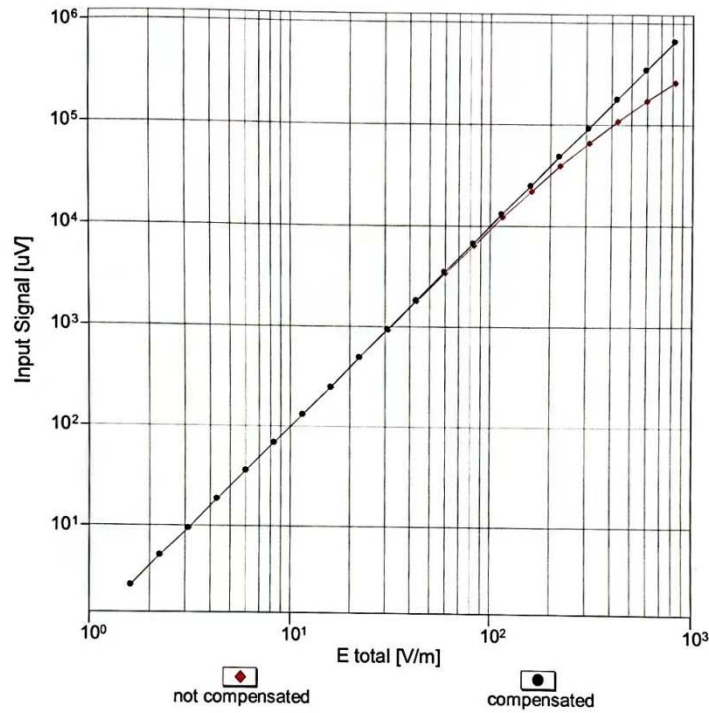

Uncertainty of Linearity Assessment: $\pm 0.6\%$ (k=2)

EF3DV3 – SN:4048

March 4, 2022

Deviation from Isotropy in Air Error (ϕ , θ), $f = 900$ MHz

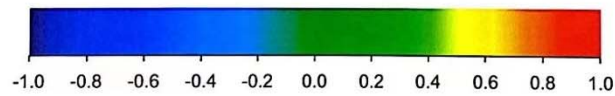
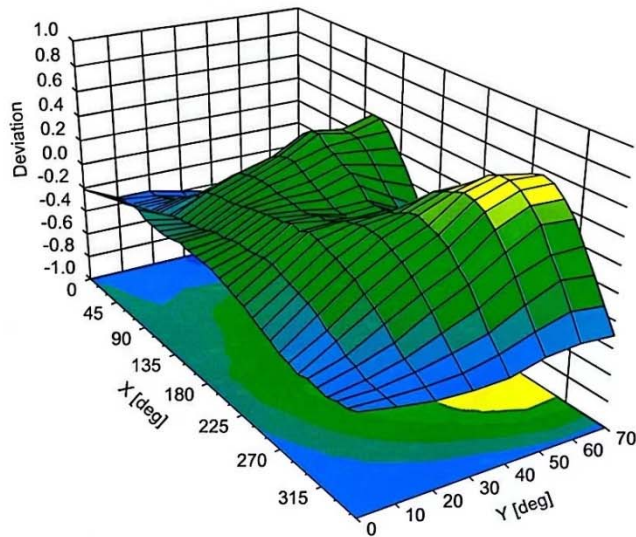

Uncertainty of Spherical Isotropy Assessment: $\pm 2.6\%$ ($k=2$)



EF3DV3 – SN:4048

March 4, 2022

Appendix: Modulation Calibration Parameters

UID	Rev	Communication System Name	Group	PAR (dB)	Unc ^E (k=2)
0		CW	CW	0.00	± 4.7 %
10010	CAA	SAR Validation (Square, 100ms, 10ms)	Test	10.00	± 9.6 %
10011	CAB	UMTS-FDD (WCDMA)	WCDMA	2.91	± 9.6 %
10012	CAB	IEEE 802.11b WiFi 2.4 GHz (DSSS, 1 Mbps)	WLAN	1.87	± 9.6 %
10013	CAB	IEEE 802.11g WiFi 2.4 GHz (DSSS-OFDM, 6 Mbps)	WLAN	9.46	± 9.6 %
10021	DAC	GSM-FDD (TDMA, GMSK)	GSM	9.39	± 9.6 %
10023	DAC	GPRS-FDD (TDMA, GMSK, TN 0)	GSM	9.57	± 9.6 %
10024	DAC	GPRS-FDD (TDMA, GMSK, TN 0-1)	GSM	6.56	± 9.6 %
10025	DAC	EDGE-FDD (TDMA, 8PSK, TN 0)	GSM	12.62	± 9.6 %
10026	DAC	EDGE-FDD (TDMA, 8PSK, TN 0-1)	GSM	9.55	± 9.6 %
10027	DAC	GPRS-FDD (TDMA, GMSK, TN 0-1-2)	GSM	4.80	± 9.6 %
10028	DAC	GPRS-FDD (TDMA, GMSK, TN 0-1-2-3)	GSM	3.55	± 9.6 %
10029	DAC	EDGE-FDD (TDMA, 8PSK, TN 0-1-2)	GSM	7.78	± 9.6 %
10030	CAA	IEEE 802.15.1 Bluetooth (GFSK, DH1)	Bluetooth	5.30	± 9.6 %
10031	CAA	IEEE 802.15.1 Bluetooth (GFSK, DH3)	Bluetooth	1.87	± 9.6 %
10032	CAA	IEEE 802.15.1 Bluetooth (GFSK, DH5)	Bluetooth	1.16	± 9.6 %
10033	CAA	IEEE 802.15.1 Bluetooth (PI/4-DQPSK, DH1)	Bluetooth	7.74	± 9.6 %
10034	CAA	IEEE 802.15.1 Bluetooth (PI/4-DQPSK, DH3)	Bluetooth	4.53	± 9.6 %
10035	CAA	IEEE 802.15.1 Bluetooth (PI/4-DQPSK, DH5)	Bluetooth	3.83	± 9.6 %
10036	CAA	IEEE 802.15.1 Bluetooth (8-DPSK, DH1)	Bluetooth	8.01	± 9.6 %
10037	CAA	IEEE 802.15.1 Bluetooth (8-DPSK, DH3)	Bluetooth	4.77	± 9.6 %
10038	CAA	IEEE 802.15.1 Bluetooth (8-DPSK, DH5)	Bluetooth	4.10	± 9.6 %
10039	CAB	CDMA2000 (1xRTT, RC1)	CDMA2000	4.57	± 9.6 %
10042	CAB	IS-54 / IS-136 FDD (TDMA/FDM, PI/4-DQPSK, Halfrate)	AMPS	7.78	± 9.6 %
10044	CAA	IS-91/EIA/TIA-553 FDD (FDMA, FM)	AMPS	0.00	± 9.6 %
10048	CAA	DECT (TDD, TDMA/FDM, GFSK, Full Slot, 24)	DECT	13.80	± 9.6 %
10049	CAA	DECT (TDD, TDMA/FDM, GFSK, Double Slot, 12)	DECT	10.79	± 9.6 %
10056	CAA	UMTS-TDD (TD-SCDMA, 1.28 Mcps)	TD-SCDMA	11.01	± 9.6 %
10058	DAC	EDGE-FDD (TDMA, 8PSK, TN 0-1-2-3)	GSM	6.52	± 9.6 %
10059	CAB	IEEE 802.11b WiFi 2.4 GHz (DSSS, 2 Mbps)	WLAN	2.12	± 9.6 %
10060	CAB	IEEE 802.11b WiFi 2.4 GHz (DSSS, 5.5 Mbps)	WLAN	2.83	± 9.6 %
10061	CAB	IEEE 802.11b WiFi 2.4 GHz (DSSS, 11 Mbps)	WLAN	3.60	± 9.6 %
10062	CAD	IEEE 802.11a/h WiFi 5 GHz (OFDM, 6 Mbps)	WLAN	8.68	± 9.6 %
10063	CAD	IEEE 802.11a/h WiFi 5 GHz (OFDM, 9 Mbps)	WLAN	8.63	± 9.6 %
10064	CAD	IEEE 802.11a/h WiFi 5 GHz (OFDM, 12 Mbps)	WLAN	9.09	± 9.6 %
10065	CAD	IEEE 802.11a/h WiFi 5 GHz (OFDM, 18 Mbps)	WLAN	9.00	± 9.6 %
10066	CAD	IEEE 802.11a/h WiFi 5 GHz (OFDM, 24 Mbps)	WLAN	9.38	± 9.6 %
10067	CAD	IEEE 802.11a/h WiFi 5 GHz (OFDM, 36 Mbps)	WLAN	10.12	± 9.6 %
10068	CAD	IEEE 802.11a/h WiFi 5 GHz (OFDM, 48 Mbps)	WLAN	10.24	± 9.6 %
10069	CAD	IEEE 802.11a/h WiFi 5 GHz (OFDM, 54 Mbps)	WLAN	10.56	± 9.6 %
10071	CAB	IEEE 802.11g WiFi 2.4 GHz (DSSS/OFDM, 9 Mbps)	WLAN	9.83	± 9.6 %
10072	CAB	IEEE 802.11g WiFi 2.4 GHz (DSSS/OFDM, 12 Mbps)	WLAN	9.62	± 9.6 %
10073	CAB	IEEE 802.11g WiFi 2.4 GHz (DSSS/OFDM, 18 Mbps)	WLAN	9.94	± 9.6 %
10074	CAB	IEEE 802.11g WiFi 2.4 GHz (DSSS/OFDM, 24 Mbps)	WLAN	10.30	± 9.6 %
10075	CAB	IEEE 802.11g WiFi 2.4 GHz (DSSS/OFDM, 36 Mbps)	WLAN	10.77	± 9.6 %
10076	CAB	IEEE 802.11g WiFi 2.4 GHz (DSSS/OFDM, 48 Mbps)	WLAN	10.94	± 9.6 %
10077	CAB	IEEE 802.11g WiFi 2.4 GHz (DSSS/OFDM, 54 Mbps)	WLAN	11.00	± 9.6 %
10081	CAB	CDMA2000 (1xRTT, RC3)	CDMA2000	3.97	± 9.6 %
10082	CAB	IS-54 / IS-136 FDD (TDMA/FDM, PI/4-DQPSK, Fullrate)	AMPS	4.77	± 9.6 %
10090	DAC	GPRS-FDD (TDMA, GMSK, TN 0-4)	GSM	6.56	± 9.6 %
10097	CAC	UMTS-FDD (HSDPA)	WCDMA	3.98	± 9.6 %
10098	DAC	UMTS-FDD (HSUPA, Subtest 2)	WCDMA	3.98	± 9.6 %
10099	CAC	EDGE-FDD (TDMA, 8PSK, TN 0-4)	GSM	9.55	± 9.6 %

Certificate No: EF3-4048_Mar22

Page 10 of 22