

TEST REPORT

Applicant: Blustream PTY LTD

Address of Applicant: 26 Lionel Rd, Mount Waverley, Melbourne, Victoria, 3149, Australia

Manufacturer/Factory: Shen Zhen Proitav Technology Co.,Ltd

Address of Manufacturer/Factory: Floor 3-4, Building 16, Hejing Industrial Zone, Fuyong Town, Baoan District, Shenzhen, China

Equipment Under Test (EUT)

Product Name: 4K60 BYOD Presentation Switcher

Model No.: AMF41W

Trade Mark: Blustream

FCC ID: 2AY2P-AMF41W

IC: 27021-AMF41W

Applicable standards: FCC CFR Title 47 Part 15 Subpart E Section 15.407
RSS-Gen Issue 5
RSS-247 Issue 2

Date of sample receipt: February 01, 2021

Date of Test: February 02, 2021-May 13, 2021

Date of report issued: May 14, 2021

Test Result : PASS *

* In the configuration tested, the EUT complied with the standards specified above.

Authorized Signature:



Robinson Luo
Laboratory Manager

This results shown in this test report refer only to the sample(s) tested, this test report cannot be reproduced, except in full, without prior written permission of the company. The report would be invalid without specific stamp of test institute and the signatures of compiler and approver.

2 Version

Version No.	Date	Description
00	May 14, 2021	Original

Prepared By:

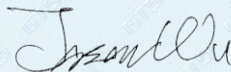

Project Engineer

Date:

May 14, 2021

Check By:

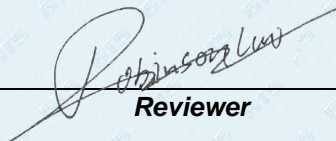

Reviewer

Date:

May 14, 2021

3 Contents

	Page
1 COVER PAGE	1
2 VERSION	2
3 CONTENTS	3
4 TEST SUMMARY	4
4.1 MEASUREMENT UNCERTAINTY	4
5 GENERAL INFORMATION	5
5.1 GENERAL DESCRIPTION OF EUT	5
5.2 TEST MODE	7
5.3 DESCRIPTION OF SUPPORT UNITS	7
5.4 TEST FACILITY	7
5.5 TEST LOCATION	7
6 TEST INSTRUMENTS LIST	8
7 TEST RESULTS AND MEASUREMENT DATA	10
7.1 ANTENNA REQUIREMENT	10
7.2 CONDUCTED EMISSIONS	11
7.3 CONDUCTED PEAK OUTPUT POWER	14
7.4 CHANNEL BANDWIDTH AND 99% OCCUPIED BANDWIDTH	15
7.5 POWER SPECTRAL DENSITY	16
7.6 BAND EDGE	17
7.6.1 Radiated Emission Method	17
7.7 SPURIOUS EMISSION	25
7.7.1 Radiated Emission Method	25
7.8 FREQUENCY STABILITY	49
8 TEST SETUP PHOTO	50
9 EUT CONSTRUCTIONAL DETAILS	50

4 Test Summary

Test Item	Section	Result
Antenna requirement	FCC part 15.203 & RSS-Gen 8.3	Pass
AC Power Line Conducted Emission	FCC part 15.207 & RSS-Gen 8.8	Pass
Conducted Peak Output Power	FCC part 15.407(a)(3) & RSS-247 6.2.4.1	Pass
Channel Bandwidth and 99% Occupied Bandwidth	FCC part 15.407(e) & RSS-247 6.2.4.1	Pass
Power Spectral Density	FCC part 15.407(a)(3) & RSS-247 6.2.4.1	Pass
Band Edge	FCC part 15.407(b)(4) RSS-Gen 8.10 & RSS-Gen	Pass
Spurious Emission	FCC part 15.205/15.209/15.407(b)(4) RSS-247 6.2.4.2 & RSS-Gen 8.9	Pass
Frequency Stability	FCC part 15.407(g) & RSS-Gen 8.11	Pass

Remarks:

1. Pass: The EUT complies with the essential requirements in the standard.
2. Test according to ANSI C63.10:2013.

4.1 Measurement Uncertainty

Test Item	Frequency Range	Measurement Uncertainty	Notes
Radiated Emission	30MHz-200MHz	3.8039dB	(1)
Radiated Emission	200MHz-1GHz	3.9679dB	(1)
Radiated Emission	1GHz-18GHz	4.29dB	(1)
Radiated Emission	18GHz-40GHz	3.30dB	(1)
AC Power Line Conducted Emission	0.15MHz ~ 30MHz	3.44dB	(1)

Note (1): The measurement uncertainty is for coverage factor of k=2 and a level of confidence of 95%.

5 General Information

5.1 General Description of EUT

Product Name:	4K60 BYOD Presentation Switcher
Model No.:	AMF41W
Serial No.:	BA020210719XXXX
Hardware Version:	V0.3
Software Version:	v2.4.7
Test sample(s) ID:	GTS202102000020-1
Sample(s) Status:	Engineer sample
Operation Frequency:	802.11a/802.11n(HT20)/802.11ac(HT20): 5745MHz~5805MHz
Channel numbers:	5
Channel bandwidth:	20MHz
Modulation technology:	Orthogonal Frequency Division Multiplexing (OFDM)
Antenna Type:	Integral Antenna
Antenna gain:	ANT 1: 2dBi ANT 2: 2dBi
Power supply:	Adapter: Model: NBS24J120200D5 Input: AC 100-240V, 50/60Hz, 0.6A Output: DC 12.0V, 2.0A, 24.0W

Operation Frequency each of channel							
Channel	Frequency	Channel	Frequency	Channel	Frequency	Channel	Frequency
149	5745MHz	151	5755MHz	153	5765MHz	155	5775MHz
157	5785MHz	159	5795MHz	161	5805MHz		

Note:

In section 15.31(m), regards to the operating frequency range over 10 MHz, the Lowest frequency, the middle frequency, and the highest frequency of channel were selected to perform the test, and the selected channel see below:

Test channel	Frequency (MHz)
	802.11a/n/ac(HT20)
Lowest channel	5745
Middle channel	5785
Highest channel	5805

5.2 Test mode

Transmitting mode	Keep the EUT in continuously transmitting mode
-------------------	--

We have verified the construction and function in typical operation. All the test modes were carried out with the EUT in transmitting operation, which was shown in this test report and defined as follows:

Per-scan all kind of data rate in lowest channel, and found the follow list which it was worst case.

Mode	Data rate
802.11a	6Mbps
802.11n/ac(HT20)	6.5Mbps

5.3 Description of Support Units

Manufacturer	Description	Model	Serial Number
Lenovo	Notebook PC	E40-80	N/A

5.4 Test Facility

The test facility is recognized, certified, or accredited by the following organizations:

- **FCC —Registration No.: 381383**

Global United Technology Services Co., Ltd., Shenzhen EMC Laboratory has been registered and fully described in a report filed with the (FCC) Federal Communications Commission. The acceptance letter from the FCC is maintained in files. Registration 381383.

- **IC —Registration No.: 9079A**

The 3m Semi-anechoic chamber of Global United Technology Services Co., Ltd. has been registered by Certification and Engineering Bureau of Industry Canada for radio equipment testing with Registration No.: 9079A.

- **CNAS (No. CNAS L5775)**

CNAS has accredited Global United Technology Services Co., Ltd., to ISO/IEC 17025:2017 General Requirements for the Competence of Testing and Calibration Laboratories (CNAS-CL01 Accreditation Criteria for the Competence of Testing and Calibration Laboratories) for the competence in the field of testing.

5.5 Test Location

All tests were performed at:

Global United Technology Services Co., Ltd.

Address: No. 123-128, Tower A, Jinyuan Business Building, No.2, Laodong Industrial Zone, Xixiang Road, Baoan District, Shenzhen, Guangdong, China 518102

Tel: 0755-27798480

Fax: 0755-27798960

6 Test Instruments list

Radiated Emission:						
Item	Test Equipment	Manufacturer	Model No.	Inventory No.	Cal.Date (mm-dd-yy)	Cal.Due date (mm-dd-yy)
1	3m Semi- Anechoic Chamber	ZhongYu Electron	9.2(L)*6.2(W)* 6.4(H)	GTS250	July. 02 2020	July. 01 2025
2	Control Room	ZhongYu Electron	6.2(L)*2.5(W)* 2.4(H)	GTS251	N/A	N/A
3	EMI Test Receiver	Rohde & Schwarz	ESU26	GTS203	June. 25 2020	June. 24 2021
4	BiConiLog Antenna	SCHWARZBECK MESS-ELEKTRONIK	VULB9163	GTS214	June. 25 2020	June. 24 2021
5	Double -ridged waveguide horn	SCHWARZBECK MESS-ELEKTRONIK	BBHA 9120 D	GTS208	June. 25 2020	June. 24 2021
6	Horn Antenna	ETS-LINDGREN	3160	GTS217	June. 25 2020	June. 24 2021
7	EMI Test Software	AUDIX	E3	N/A	N/A	N/A
8	Coaxial Cable	GTS	N/A	GTS213	June. 25 2020	June. 24 2021
9	Coaxial Cable	GTS	N/A	GTS211	June. 25 2020	June. 24 2021
10	Coaxial cable	GTS	N/A	GTS210	June. 25 2020	June. 24 2021
11	Coaxial Cable	GTS	N/A	GTS212	June. 25 2020	June. 24 2021
12	Amplifier(100kHz-3GHz)	HP	8347A	GTS204	June. 25 2020	June. 24 2021
13	Amplifier(2GHz-20GHz)	HP	84722A	GTS206	June. 25 2020	June. 24 2021
14	Amplifier (18-26GHz)	Rohde & Schwarz	AFS33-18002 650-30-8P-44	GTS218	June. 25 2020	June. 24 2021
15	Band filter	Amindeon	82346	GTS219	June. 25 2020	June. 24 2021
16	Power Meter	Anritsu	ML2495A	GTS540	June. 25 2020	June. 24 2021
17	Power Sensor	Anritsu	MA2411B	GTS541	June. 25 2020	June. 24 2021
18	Wideband Radio Communication Tester	Rohde & Schwarz	CMW500	GTS575	June. 25 2020	June. 24 2021
19	Splitter	Agilent	11636B	GTS237	June. 25 2020	June. 24 2021
20	Loop Antenna	ZHINAN	ZN30900A	GTS534	June. 25 2020	June. 24 2021
21	Breitband hornantenne	SCHWARZBECK	BBHA 9170	GTS579	Oct. 18 2020	Oct. 17 2021
22	Amplifier	TDK	PA-02-02	GTS574	Oct. 18 2020	Oct. 17 2021
23	Amplifier	TDK	PA-02-03	GTS576	Oct. 18 2020	Oct. 17 2021
24	PSA Series Spectrum Analyzer	Rohde & Schwarz	FSP	GTS578	June. 25 2020	June. 24 2021

Conducted Emission						
Item	Test Equipment	Manufacturer	Model No.	Inventory No.	Cal.Date (mm-dd-yy)	Cal.Due date (mm-dd-yy)
1	Shielding Room	ZhongYu Electron	7.3(L)x3.1(W)x2.9(H)	GTS252	May.15 2019	May.14 2022
2	EMI Test Receiver	R&S	ESCI 7	GTS552	June. 25 2020	June. 24 2021
3	Coaxial Switch	ANRITSU CORP	MP59B	GTS225	June. 25 2020	June. 24 2021
4	ENV216 2-L-V-NETZNACHB.DE	ROHDE&SCHWARZ	ENV216	GTS226	June. 25 2020	June. 24 2021
5	Coaxial Cable	GTS	N/A	GTS227	N/A	N/A
6	EMI Test Software	AUDIX	E3	N/A	N/A	N/A
7	Thermo meter	KTJ	TA328	GTS233	June. 25 2020	June. 24 2021
8	Absorbing clamp	Elektronik-Feinmechanik	MDS21	GTS229	June. 25 2020	June. 24 2021
9	ISN	SCHWARZBECK	NTFM 8158	GTS565	June. 25 2020	June. 24 2021

RF Conducted Test:						
Item	Test Equipment	Manufacturer	Model No.	Serial No.	Cal.Date (mm-dd-yy)	Cal.Due date (mm-dd-yy)
1	MXA Signal Analyzer	Agilent	N9020A	GTS566	June. 25 2020	June. 24 2021
2	EMI Test Receiver	R&S	ESCI 7	GTS552	June. 25 2020	June. 24 2021
3	Spectrum Analyzer	Agilent	E4440A	GTS533	June. 25 2020	June. 24 2021
4	MXG vector Signal Generator	Agilent	N5182A	GTS567	June. 25 2020	June. 24 2021
5	ESG Analog Signal Generator	Agilent	E4428C	GTS568	June. 25 2020	June. 24 2021
6	USB RF Power Sensor	DARE	RPR3006W	GTS569	June. 25 2020	June. 24 2021
7	RF Switch Box	Shongyi	RFSW3003328	GTS571	June. 25 2020	June. 24 2021
8	Programmable Constant Temp & Humi Test Chamber	WEWON	WHTH-150L-40-880	GTS572	June. 25 2020	June. 24 2021

General used equipment:						
Item	Test Equipment	Manufacturer	Model No.	Inventory No.	Cal.Date (mm-dd-yy)	Cal.Due date (mm-dd-yy)
1	Humidity/ Temperature Indicator	KTJ	TA328	GTS243	June. 25 2020	June. 24 2021
2	Barometer	ChangChun	DYM3	GTS255	June. 25 2020	June. 24 2021

7 Test results and Measurement Data

7.1 Antenna requirement

Standard requirement:	FCC Part15 C Section 15.203
<p><i>15.203 requirement:</i></p> <p>An intentional radiator shall be designed to ensure that no antenna other than that furnished by the responsible party shall be used with the device. The use of a permanently attached antenna or of an antenna that uses a unique coupling to the intentional radiator, the manufacturer may design the unit so that a broken antenna can be replaced by the user, but the use of a standard antenna jack or electrical connector is prohibited.</p>	
Standard requirement:	RSS-Gen 8.3
<p>A transmitter can only be sold or operated with antennas with which it was approved.</p> <p>When a measurement at the antenna connector is used to determine RF output power, the effective gain of the device's antenna shall be stated, based on measurement or on data from the antenna manufacturer. For transmitters of RF output power of 10 milliwatts or less, only the portion of the antenna gain that is in excess of 6 dBi (6 dB above isotropic gain) shall be added to the measured RF output power to demonstrate compliance with the radiated power limits specified in the applicable standard. For transmitters of output power greater than 10 milliwatts, the total antenna gain shall be added to the measured RF output power to demonstrate compliance to the specified radiated power</p>	
E.U.T Antenna:	
<p><i>The antenna is Integral antenna, the best case gain of the antenna is 2dBi, reference to the appendix II for details</i></p>	

7.2 Conducted Emissions

Test Requirement:	FCC Part15 C Section 15.207 RSS-Gen 8.8					
Test Method:	ANSI C63.10:2013					
Test Frequency Range:	150KHz to 30MHz					
Class / Severity:	Class B					
Receiver setup:	RBW=9KHz, VBW=30KHz, Sweep time=auto					
Limit:	Frequency range (MHz)		Limit (dBuV)			
			Quasi-peak		Average	
	0.15-0.5		66 to 56*		56 to 46*	
	0.5-5		56		46	
	5-30		60		50	
* Decreases with the logarithm of the frequency.						
Test setup:	<p>Remark E.U.T: Equipment Under Test LISN: Line Impedance Stabilization Network Test table height=0.8m</p>					
Test procedure:	<ol style="list-style-type: none"> 1. The E.U.T and simulators are connected to the main power through a line impedance stabilization network (L.I.S.N.). This provides a 50ohm/50uH coupling impedance for the measuring equipment. 2. The peripheral devices are also connected to the main power through a LISN that provides a 50ohm/50uH coupling impedance with 50ohm termination. (Please refer to the block diagram of the test setup and photographs). 3. Both sides of A.C. line are checked for maximum conducted interference. In order to find the maximum emission, the relative positions of equipment and all of the interface cables must be changed according to ANSI C63.10:2013 on conducted measurement. 					
Test Instruments:	Refer to section 6.0 for details					
Test mode:	Refer to section 5.2 for details					
Test environment:	Temp.:	25 °C	Humid.:	52%	Press.:	1012mbar
Test voltage:	AC 120V, 60Hz					
Test results:	Pass					

Remark: Both high and low voltages have been tested to show only the worst low voltage test data.

Measurement data

Line:

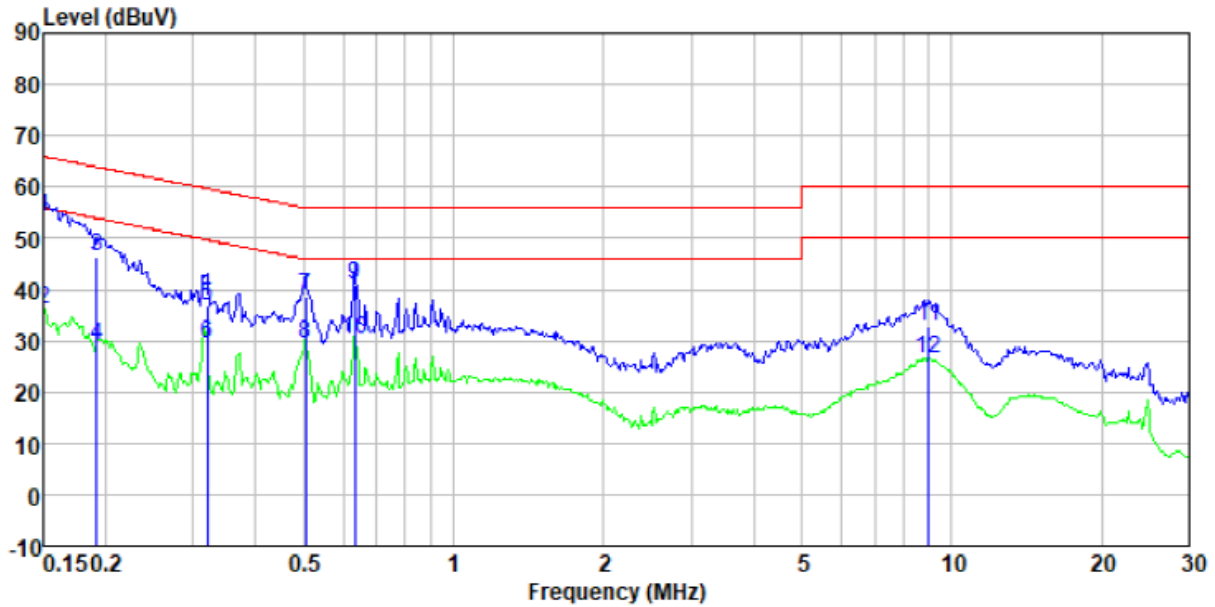

Freq MHz	Reading level dBuV	LISN/ISN factor dB/m	Cable loss dB	Level dBuV	Limit level dBuV	Over limit dB	Remark
0.15	33.79	20.40	0.07	54.26	66.00	-11.74	QP
0.15	15.65	20.40	0.07	36.12	56.00	-19.88	Average
0.19	25.78	20.40	0.11	46.29	63.93	-17.64	QP
0.19	8.60	20.40	0.11	29.11	53.93	-24.82	Average
0.32	16.49	20.39	0.10	36.98	59.71	-22.73	QP
0.32	8.90	20.39	0.10	29.39	49.71	-20.32	Average
0.50	18.30	20.31	0.11	38.72	56.00	-17.28	QP
0.50	9.25	20.31	0.11	29.67	46.00	-16.33	Average
0.63	20.35	20.28	0.12	40.75	56.00	-15.25	QP
0.63	9.93	20.28	0.12	30.33	46.00	-15.67	Average
9.01	12.41	20.20	0.20	32.81	60.00	-27.19	QP
9.01	6.18	20.20	0.20	26.58	50.00	-23.42	Average

Neutral:

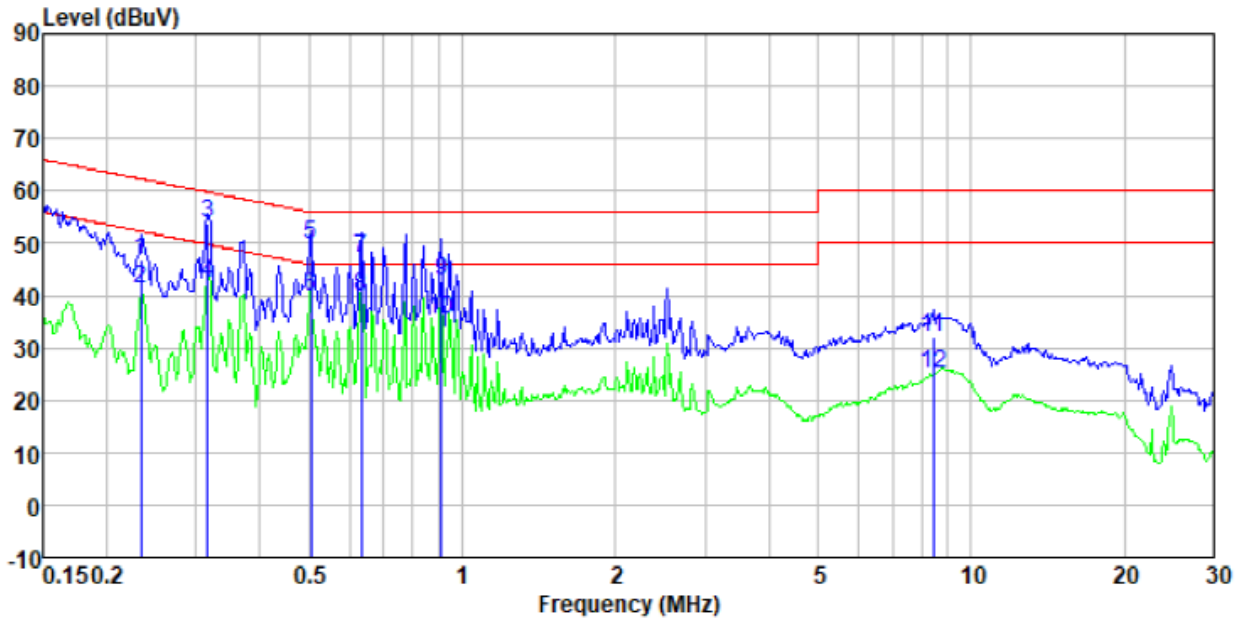

Freq MHz	Reading level dBuV	LISN/ISN factor dB/m	Cable loss dB	Level dBuV	Limit level dBuV	Over limit dB	Remark
0.23	26.30	20.40	0.11	46.81	62.30	-15.49	QP
0.23	20.76	20.40	0.11	41.27	52.30	-11.03	Average
0.32	33.26	20.39	0.10	53.75	59.80	-6.05	QP
0.32	22.05	20.39	0.10	42.54	49.80	-7.26	Average
0.50	29.27	20.31	0.11	49.69	56.00	-6.31	QP
0.50	19.50	20.31	0.11	39.92	46.00	-6.08	Average
0.63	26.76	20.28	0.12	47.16	56.00	-8.84	QP
0.63	19.58	20.28	0.12	39.98	46.00	-6.02	Average
0.91	22.25	20.22	0.14	42.61	56.00	-13.39	QP
0.91	15.14	20.22	0.14	35.50	46.00	-10.50	Average
8.41	11.71	20.20	0.19	32.10	60.00	-27.90	QP
8.41	4.60	20.20	0.19	24.99	50.00	-25.01	Average

Notes:

1. An initial pre-scan was performed on the line and neutral lines with peak detector.
2. Quasi-Peak and Average measurement were performed at the frequencies with maximized peak emission.
3. Final Level = Receiver Read level + LISN Factor + Cable Loss
4. If the average limit is met when using a quasi-peak detector receiver, the EUT shall be deemed to meet both *limits and measurement with the average detector receiver is unnecessary.*

7.3 Conducted Peak Output Power

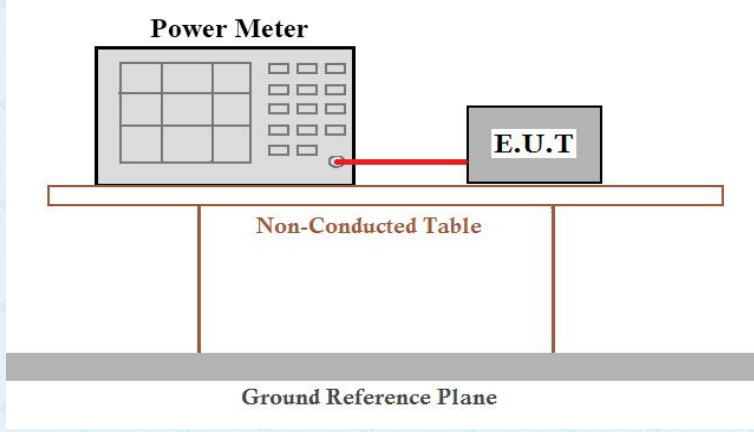
Test Requirement:	FCC Part15 E Section 15.407(a)(3) RSS-247 6.2.4.1
Test Method:	ANSI C63.10:2013 and KDB 789033 D02 General U-NII Test Procedures New Rules v02r01 & RSS-Gen
Limit:	30dBm
Test setup:	 <p>The diagram illustrates the test setup. A Power Meter is connected to an E.U.T. (Equipment Under Test) via a red cable. Both are placed on a Non-Conducted Table, which sits on a Ground Reference Plane.</p>
Test Instruments:	Refer to section 6.0 for details
Test mode:	Refer to section 5.2 for details
Test results:	Pass

Measurement Data: The detailed test data see Appendix for WIFI 5.8G

7.4 Channel Bandwidth and 99% Occupied Bandwidth

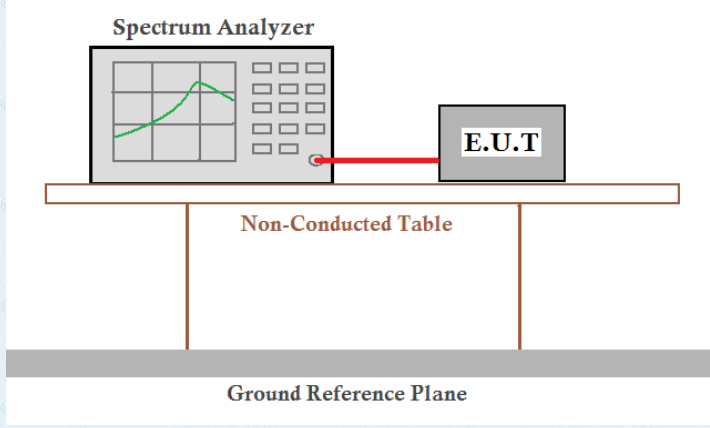
Test Requirement:	FCC Part15 E Section 15.407(e) RSS-247 Section 5.2 & RSS-Gen Section 6.2.4.1
Test Method:	ANSI C63.10:2013 and KDB 789033 D02 General U-NII Test Procedures New Rules v02r01 & RSS-Gen
Limit:	>500KHz
Test setup:	 <p>The diagram illustrates the test setup. A Spectrum Analyzer is connected to an E.U.T. (Equipment Under Test) via a red cable. Both are placed on a Non-Conducted Table, which is supported by a Ground Reference Plane.</p>
Test Instruments:	Refer to section 6.0 for details
Test mode:	Refer to section 5.2 for details
Test results:	Pass

Measurement Data: The detailed test data see Appendix for WIFI 5.8G

7.5 Power Spectral Density

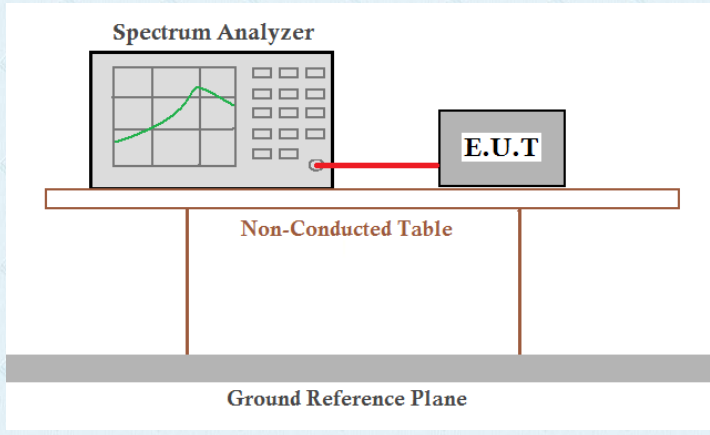
Test Requirement:	FCC Part15 E Section 15.407(a)(3) RSS-247 Section 6.2.4.1
Test Method:	ANSI C63.10:2013 and KDB 789033 D02 General U-NII Test Procedures New Rules v02r01 & RSS-Gen
Limit:	30dBm/500kHz
Test setup:	 <p>The diagram illustrates the test setup. A Spectrum Analyzer is connected to an E.U.T. (Equipment Under Test) via a red cable. Both are placed on a Non-Conducted Table, which sits on a Ground Reference Plane.</p>
Test Instruments:	Refer to section 6.0 for details
Test mode:	Refer to section 5.2 for details
Test results:	Pass

Measurement Data: The detailed test data see Appendix for WIFI 5.8G

7.6 Band edge

7.6.1 Radiated Emission Method

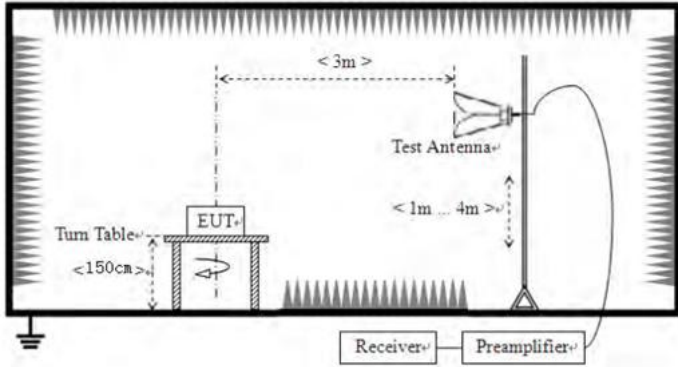
Test Requirement:	FCC Part15 C Section 15.209 and 15.205 RSS-247 Section 6.2.4.2 & RSS-Gen 8.10														
Test Method:	ANSI C63.10: 2013 & RSS-Gen														
Test Frequency Range:	9kHz to 40GHz, only worse case is reported														
Test site:	Measurement Distance: 3m														
Receiver setup:	<table border="1"> <thead> <tr> <th>Frequency</th> <th>Detector</th> <th>RBW</th> <th>VBW</th> <th>Value</th> </tr> </thead> <tbody> <tr> <td rowspan="2">Above 1GHz</td> <td>Peak</td> <td>1MHz</td> <td>3MHz</td> <td>Peak</td> </tr> <tr> <td>RMS</td> <td>1MHz</td> <td>3MHz</td> <td>RMS</td> </tr> </tbody> </table>	Frequency	Detector	RBW	VBW	Value	Above 1GHz	Peak	1MHz	3MHz	Peak	RMS	1MHz	3MHz	RMS
Frequency	Detector	RBW	VBW	Value											
Above 1GHz	Peak	1MHz	3MHz	Peak											
	RMS	1MHz	3MHz	RMS											
Limit:	All emissions shall be limited to a level of -27 dBm/MHz at 75 MHz or more above or below the band edge increasing linearly to 10 dBm/MHz at 25 MHz above or below the band edge, and from 25 MHz above or below the band edge increasing linearly to a level of 15.6 dBm/MHz at 5 MHz above or below the band edge, and from 5 MHz above or below the band edge increasing linearly to a level of 27 dBm/MHz at the band edge.														
Test setup:															
Test Procedure:	<ol style="list-style-type: none"> 1. The EUT was placed on the top of a rotating table 1.5 meters above the ground at a 3 meter camber. The table was rotated 360 degrees to determine the position of the highest radiation. 2. The EUT was set 3 meters away from the interference-receiving antenna, which was mounted on the top of a variable-height antenna tower. 3. The antenna height is varied from one meter to four meters above the ground to determine the maximum value of the field strength. Both horizontal and vertical polarizations of the antenna are set to make the measurement. 4. For each suspected emission, the EUT was arranged to its worst case and then the antenna was tuned to heights from 1 meter to 4 meters and the rota table was turned from 0 degrees to 360 degrees to find the maximum reading. 5. The test-receiver system was set to Peak Detect Function and Specified Bandwidth with Maximum Hold Mode. 6. If the emission level of the EUT in peak mode was 10dB lower than the limit specified, then testing could be stopped and the peak values of the EUT would be reported. Otherwise the emissions that did not have 10dB margin would be re-tested one by one using peak, quasi-peak or average method as specified and then reported in a data sheet. 7. The radiation measurements are performed in X, Y, Z axis positioning. And found the X axis positioning which it is worse case, only the test worst case mode is recorded in the report. 														

Test Instruments:	Refer to section 6.0 for details
Test mode:	Refer to section 5.2 for details
Test results:	Pass

Remarks:

1. Only the worst case Main Antenna test data..
2. Final Level =Receiver Read level + Antenna Factor + Cable Loss – Preamplifier Factor
3. The emission levels of other frequencies are very lower than the limit and not show in test report.
4. The pre-test were performed on lowest, middle and highest frequencies, only the worst case's (lowest and highest frequencies) data was showed.
5. According to KDB 789033 D02v02r01 section G) 1) d),for measurements above 1000 MHz @3m distance, the limit of field strength is computed as follows:

$$E[\text{dBuV/m}] = \text{EIRP}[\text{dBm}] + 95.2;$$

$$E[\text{dBuV/m}] = -27 + 95.2 = 68.2\text{dBuV/m}.$$

$$E[\text{dBuV/m}] = 10 + 95.2 = 105.2\text{dBuV/m}.$$

$$E[\text{dBuV/m}] = 15.6 + 95.2 = 110.8\text{dBuV/m}.$$

$$E[\text{dBuV/m}] = 27 + 95.2 = 122.2\text{dBuV/m}$$

Measurement data:

ANT 1

IEEE 802.11a								
Peak value:								
Frequency (MHz)	Read Level (dBuV)	Antenna Factor (dB/m)	Cable Loss (dB)	Preamp Factor (dB)	Level (dBuV/m)	Limit Line (dBuV/m)	Over Limit (dB)	Polarization
5650.00	38.45	32.36	9.72	23.83	56.70	68.20	-11.50	Horizontal
5700.00	37.84	32.50	9.79	23.84	56.29	105.20	-48.91	Horizontal
5720.00	36.45	32.53	9.81	23.85	54.94	110.80	-55.86	Horizontal
5725.00	44.86	32.53	9.83	23.86	63.36	122.20	-58.84	Horizontal
5850.00	40.65	32.70	9.99	23.87	59.47	122.20	-62.73	Horizontal
5855.00	36.55	32.72	9.99	23.88	55.38	110.80	-55.42	Horizontal
5875.00	36.79	32.74	10.04	23.89	55.68	105.20	-49.52	Horizontal
5925.00	36.54	32.80	10.11	23.90	55.55	68.20	-12.65	Horizontal
5650.00	36.59	32.36	9.72	23.83	54.84	68.20	-13.36	Vertical
5700.00	35.84	32.50	9.79	23.84	54.29	105.20	-50.91	Vertical
5720.00	36.59	32.53	9.81	23.85	55.08	110.80	-55.72	Vertical
5725.00	43.98	32.53	9.83	23.86	62.48	122.20	-59.72	Vertical
5850.00	41.28	32.70	9.99	23.87	60.10	122.20	-62.10	Vertical
5855.00	35.62	32.72	9.99	23.88	54.45	110.80	-56.35	Vertical
5875.00	36.48	32.74	10.04	23.89	55.37	105.20	-49.83	Vertical
5925.00	35.89	32.80	10.11	23.90	54.90	68.20	-13.30	Vertical

IEEE 802.11n(HT20)

Peak value:

Frequency (MHz)	Read Level (dBuV)	Antenna Factor (dB/m)	Cable Loss (dB)	Preamp Factor (dB)	Level (dBuV/m)	Limit Line (dBuV/m)	Over Limit (dB)	Polarization
5650.00	33.99	32.36	9.72	23.83	52.24	68.20	-15.96	Horizontal
5700.00	33.44	32.50	9.79	23.84	51.89	105.20	-53.31	Horizontal
5720.00	34.56	32.53	9.81	23.85	53.05	110.80	-57.75	Horizontal
5725.00	44.12	32.53	9.83	23.86	62.62	122.20	-59.58	Horizontal
5850.00	41.01	32.70	9.99	23.87	59.83	122.20	-62.37	Horizontal
5855.00	34.62	32.72	9.99	23.88	53.45	110.80	-57.35	Horizontal
5875.00	36.31	32.74	10.04	23.89	55.20	105.20	-50.00	Horizontal
5925.00	36.99	32.80	10.11	23.90	56.00	68.20	-12.20	Horizontal
5650.00	36.84	32.36	9.72	23.83	55.09	68.20	-13.11	Vertical
5700.00	35.72	32.50	9.79	23.84	54.17	105.20	-51.03	Vertical
5720.00	36.72	32.53	9.81	23.85	55.21	110.80	-55.59	Vertical
5725.00	44.00	32.53	9.83	23.86	62.50	122.20	-59.70	Vertical
5850.00	41.59	32.70	9.99	23.87	60.41	122.20	-61.79	Vertical
5855.00	35.55	32.72	9.99	23.88	54.38	110.80	-56.42	Vertical
5875.00	36.32	32.74	10.04	23.89	55.21	105.20	-49.99	Vertical
5925.00	36.96	32.80	10.11	23.90	55.97	68.20	-12.23	Vertical

IEEE 802.11ac(HT 20)								
Peak value:								
Frequency (MHz)	Read Level (dBuV)	Antenna Factor (dB/m)	Cable Loss (dB)	Preamp Factor (dB)	Level (dBuV/m)	Limit Line (dBuV/m)	Over Limit (dB)	Polarization
5650.00	34.62	32.36	9.72	23.83	52.87	68.20	-15.33	Horizontal
5700.00	36.15	32.50	9.79	23.84	54.60	105.20	-50.60	Horizontal
5720.00	36.54	32.53	9.81	23.85	55.03	110.80	-55.77	Horizontal
5725.00	43.98	32.53	9.83	23.86	62.48	122.20	-59.72	Horizontal
5850.00	41.08	32.70	9.99	23.87	59.90	122.20	-62.30	Horizontal
5855.00	35.96	32.72	9.99	23.88	54.79	110.80	-56.01	Horizontal
5875.00	36.85	32.74	10.04	23.89	55.74	105.20	-49.46	Horizontal
5925.00	37.95	32.80	10.11	23.90	56.96	68.20	-11.24	Horizontal
5650.00	34.89	32.36	9.72	23.83	53.14	68.20	-15.06	Vertical
5700.00	35.98	32.50	9.79	23.84	54.43	105.20	-50.77	Vertical
5720.00	35.98	32.53	9.81	23.85	54.47	110.80	-56.33	Vertical
5725.00	43.65	32.53	9.83	23.86	62.15	122.20	-60.05	Vertical
5850.00	41.85	32.70	9.99	23.87	60.67	122.20	-61.53	Vertical
5855.00	36.54	32.72	9.99	23.88	55.37	110.80	-55.43	Vertical
5875.00	36.18	32.74	10.04	23.89	55.07	105.20	-50.13	Vertical
5925.00	36.85	32.80	10.11	23.90	55.86	68.20	-12.34	Vertical

ANT 2

IEEE 802.11a								
Peak value:								
Frequency (MHz)	Read Level (dBuV)	Antenna Factor (dB/m)	Cable Loss (dB)	Preamp Factor (dB)	Level (dBuV/m)	Limit Line (dBuV/m)	Over Limit (dB)	Polarization
5650.00	37.98	32.36	9.72	23.83	56.23	68.20	-11.97	Horizontal
5700.00	37.69	32.50	9.79	23.84	56.14	105.20	-49.06	Horizontal
5720.00	36.21	32.53	9.81	23.85	54.70	110.80	-56.10	Horizontal
5725.00	43.99	32.53	9.83	23.86	62.49	122.20	-59.71	Horizontal
5850.00	40.02	32.70	9.99	23.87	58.84	122.20	-63.36	Horizontal
5855.00	36.32	32.72	9.99	23.88	55.15	110.80	-55.65	Horizontal
5875.00	35.69	32.74	10.04	23.89	54.58	105.20	-50.62	Horizontal
5925.00	36.12	32.80	10.11	23.90	55.13	68.20	-13.07	Horizontal
5650.00	36.35	32.36	9.72	23.83	54.60	68.20	-13.60	Vertical
5700.00	34.85	32.50	9.79	23.84	53.30	105.20	-51.90	Vertical
5720.00	36.26	32.53	9.81	23.85	54.75	110.80	-56.05	Vertical
5725.00	43.28	32.53	9.83	23.86	61.78	122.20	-60.42	Vertical
5850.00	40.69	32.70	9.99	23.87	59.51	122.20	-62.69	Vertical
5855.00	35.68	32.72	9.99	23.88	54.51	110.80	-56.29	Vertical
5875.00	36.03	32.74	10.04	23.89	54.92	105.20	-50.28	Vertical
5925.00	35.99	32.80	10.11	23.90	55.00	68.20	-13.20	Vertical

IEEE 802.11n(HT20)								
Peak value:								
Frequency (MHz)	Read Level (dBuV)	Antenna Factor (dB/m)	Cable Loss (dB)	Preamp Factor (dB)	Level (dBuV/m)	Limit Line (dBuV/m)	Over Limit (dB)	Polarization
5650.00	31.65	32.36	9.72	23.83	49.90	68.20	-18.30	Horizontal
5700.00	32.52	32.50	9.79	23.84	50.97	105.20	-54.23	Horizontal
5720.00	32.98	32.53	9.81	23.85	51.47	110.80	-59.33	Horizontal
5725.00	42.38	32.53	9.83	23.86	60.88	122.20	-61.32	Horizontal
5850.00	40.32	32.70	9.99	23.87	59.14	122.20	-63.06	Horizontal
5855.00	33.58	32.72	9.99	23.88	52.41	110.80	-58.39	Horizontal
5875.00	34.98	32.74	10.04	23.89	53.87	105.20	-51.33	Horizontal
5925.00	35.67	32.80	10.11	23.90	54.68	68.20	-13.52	Horizontal
5650.00	35.85	32.36	9.72	23.83	54.10	68.20	-14.10	Vertical
5700.00	34.96	32.50	9.79	23.84	53.41	105.20	-51.79	Vertical
5720.00	35.32	32.53	9.81	23.85	53.81	110.80	-56.99	Vertical
5725.00	35.55	32.53	9.83	23.86	54.05	122.20	-68.15	Vertical
5850.00	40.38	32.70	9.99	23.87	59.20	122.20	-63.00	Vertical
5855.00	34.65	32.72	9.99	23.88	53.48	110.80	-57.32	Vertical
5875.00	35.24	32.74	10.04	23.89	54.13	105.20	-51.07	Vertical
5925.00	35.86	32.80	10.11	23.90	54.87	68.20	-13.33	Vertical

IEEE 802.11ac(HT 20)								
Peak value:								
Frequency (MHz)	Read Level (dBuV)	Antenna Factor (dB/m)	Cable Loss (dB)	Preamp Factor (dB)	Level (dBuV/m)	Limit Line (dBuV/m)	Over Limit (dB)	Polarization
5650.00	33.86	32.36	9.72	23.83	52.11	68.20	-16.09	Horizontal
5700.00	35.96	32.50	9.79	23.84	54.41	105.20	-50.79	Horizontal
5720.00	35.76	32.53	9.81	23.85	54.25	110.80	-56.55	Horizontal
5725.00	42.68	32.53	9.83	23.86	61.18	122.20	-61.02	Horizontal
5850.00	40.65	32.70	9.99	23.87	59.47	122.20	-62.73	Horizontal
5855.00	34.56	32.72	9.99	23.88	53.39	110.80	-57.41	Horizontal
5875.00	35.68	32.74	10.04	23.89	54.57	105.20	-50.63	Horizontal
5925.00	36.86	32.80	10.11	23.90	55.87	68.20	-12.33	Horizontal
5650.00	34.20	32.36	9.72	23.83	52.45	68.20	-15.75	Vertical
5700.00	34.98	32.50	9.79	23.84	53.43	105.20	-51.77	Vertical
5720.00	34.68	32.53	9.81	23.85	53.17	110.80	-57.63	Vertical
5725.00	43.25	32.53	9.83	23.86	61.75	122.20	-60.45	Vertical
5850.00	41.13	32.70	9.99	23.87	59.95	122.20	-62.25	Vertical
5855.00	36.25	32.72	9.99	23.88	55.08	110.80	-55.72	Vertical
5875.00	35.48	32.74	10.04	23.89	54.37	105.20	-50.83	Vertical
5925.00	36.25	32.80	10.11	23.90	55.26	68.20	-12.94	Vertical

7.7 Spurious Emission

7.7.1 Radiated Emission Method

Test Requirement:	FCC Part15 C Section 15.209, Part 15E Section 15.407(b)(4) RSS-247 Section 6.2.4.2 & RSS-Gen Section 8.9																												
Test Method:	ANSI C63.10:2013 & RSS-Gen																												
Test Frequency Range:	9kHz to 40GHz																												
Test site:	Measurement Distance: 3m																												
Receiver setup:	Frequency	Detector	RBW	VBW	Value																								
	9kHz-150kHz	Quasi-peak	200Hz	1kHz	Quasi-peak Value																								
	150kHz-30MHz	Quasi-peak	9kHz	30kHz	Quasi-peak Value																								
	30MHz-1GHz	Quasi-peak	120kHz	300kHz	Quasi-peak Value																								
	Above 1GHz	Peak	1MHz	3MHz	Peak Value																								
AV		1MHz	3MHz	Average Value																									
FCC Limit:	<table border="1"> <thead> <tr> <th>Frequency (MHz)</th> <th>Field strength (microvolts/meter)</th> <th>Measurement distance (meters)</th> </tr> </thead> <tbody> <tr> <td>0.009-0.490</td> <td>2400/F(kHz)</td> <td>300</td> </tr> <tr> <td>0.490-1.705</td> <td>24000/F(kHz)</td> <td>30</td> </tr> <tr> <td>1.705-30.0</td> <td>30</td> <td>30</td> </tr> <tr> <td>30-88</td> <td>100**</td> <td>3</td> </tr> <tr> <td>88-216</td> <td>150**</td> <td>3</td> </tr> <tr> <td>216-960</td> <td>200**</td> <td>3</td> </tr> <tr> <td>Above 960</td> <td>500</td> <td>3</td> </tr> </tbody> </table>					Frequency (MHz)	Field strength (microvolts/meter)	Measurement distance (meters)	0.009-0.490	2400/F(kHz)	300	0.490-1.705	24000/F(kHz)	30	1.705-30.0	30	30	30-88	100**	3	88-216	150**	3	216-960	200**	3	Above 960	500	3
	Frequency (MHz)	Field strength (microvolts/meter)	Measurement distance (meters)																										
0.009-0.490	2400/F(kHz)	300																											
0.490-1.705	24000/F(kHz)	30																											
1.705-30.0	30	30																											
30-88	100**	3																											
88-216	150**	3																											
216-960	200**	3																											
Above 960	500	3																											
<p>The emission limits shown in the above table are based on measurements employing a CISPR quasi-peak detector except for the frequency bands 9-90 kHz, 110-490 kHz and above 1000 MHz. Radiated emission limits in these three bands are based on measurements employing an average detector.</p>																													
IC Limit:	<p>Table 5 – General field strength limits at frequencies above 30 MHz</p> <table border="1"> <thead> <tr> <th>Frequency (MHz)</th> <th>Field strength (µV/m at 3 m)</th> </tr> </thead> <tbody> <tr> <td>30 – 88</td> <td>100</td> </tr> <tr> <td>88 – 216</td> <td>150</td> </tr> <tr> <td>216 – 960</td> <td>200</td> </tr> <tr> <td>Above 960</td> <td>500</td> </tr> </tbody> </table>					Frequency (MHz)	Field strength (µV/m at 3 m)	30 – 88	100	88 – 216	150	216 – 960	200	Above 960	500														
	Frequency (MHz)	Field strength (µV/m at 3 m)																											
30 – 88	100																												
88 – 216	150																												
216 – 960	200																												
Above 960	500																												
<p>Table 6 – General field strength limits at frequencies below 30 MHz</p> <table border="1"> <thead> <tr> <th>Frequency</th> <th>Magnetic field strength (H-Field) (µA/m)</th> <th>Measurement distance (m)</th> </tr> </thead> <tbody> <tr> <td>9 - 490 kHz¹</td> <td>6.37/F (F in kHz)</td> <td>300</td> </tr> <tr> <td>490 - 1705 kHz</td> <td>63.7/F (F in kHz)</td> <td>30</td> </tr> <tr> <td>1.705 - 30 MHz</td> <td>0.08</td> <td>30</td> </tr> </tbody> </table>						Frequency	Magnetic field strength (H-Field) (µA/m)	Measurement distance (m)	9 - 490 kHz ¹	6.37/F (F in kHz)	300	490 - 1705 kHz	63.7/F (F in kHz)	30	1.705 - 30 MHz	0.08	30												
Frequency	Magnetic field strength (H-Field) (µA/m)	Measurement distance (m)																											
9 - 490 kHz ¹	6.37/F (F in kHz)	300																											
490 - 1705 kHz	63.7/F (F in kHz)	30																											
1.705 - 30 MHz	0.08	30																											
<p>Note 1: The emission limits for the ranges 9-90 kHz and 110-490 kHz are based on measurements employing a linear average detector.</p>																													

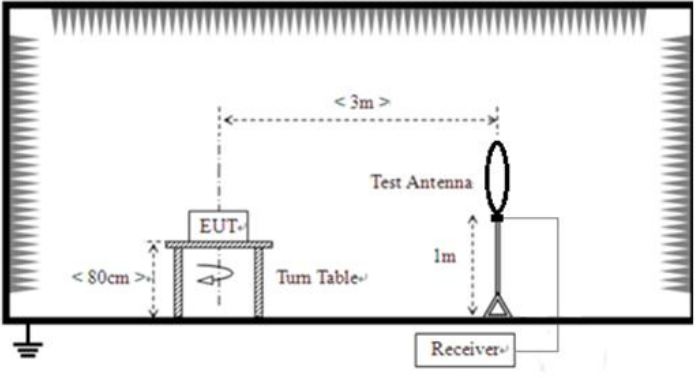
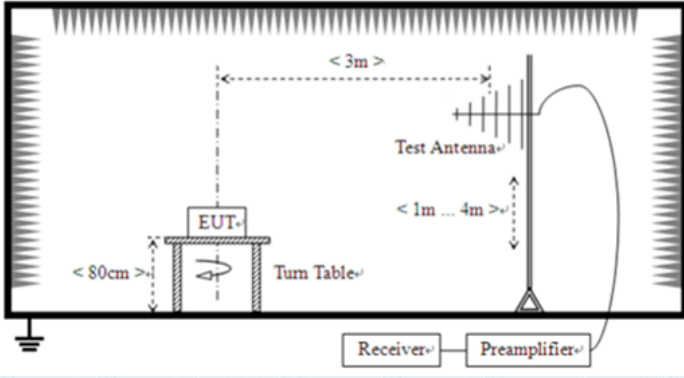
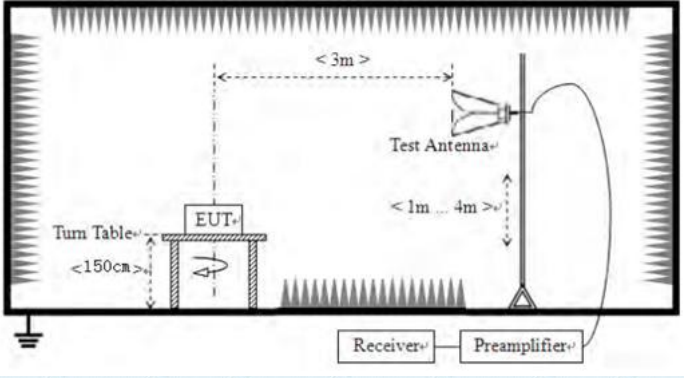
<p>Test setup:</p>	<p>For radiated emissions from 9kHz to 30MHz</p>  <p>For radiated emissions from 30MHz to 1GHz</p>  <p>For radiated emissions above 1GHz</p> 
<p>Test Procedure:</p>	<ol style="list-style-type: none"> 1. The EUT was placed on the top of a rotating table (0.8m for below 1GHz and 1.5 meters for above 1GHz) above the ground at a 3 meter camber. The table was rotated 360 degrees to determine the position of the highest radiation. 2. The EUT was set 3 meters away from the interference-receiving antenna, which was mounted on the top of a variable-height antenna tower. 3. The antenna height is varied from one meter to four meters above the ground to determine the maximum value of the field strength. Both horizontal and vertical polarizations of the antenna are set to make the

	<p>measurement.</p> <ol style="list-style-type: none"> 4. For each suspected emission, the EUT was arranged to its worst case and then the antenna was tuned to heights from 1 meter to 4 meters and the rota table was turned from 0 degrees to 360 degrees to find the maximum reading. 5. The test-receiver system was set to Peak Detect Function and Specified Bandwidth with Maximum Hold Mode. 6. If the emission level of the EUT in peak mode was 10dB lower than the limit specified, then testing could be stopped and the peak values of the EUT would be reported. Otherwise the emissions that did not have 10dB margin would be re-tested one by one using peak, quasi-peak or average method as specified and then reported in a data sheet. 7. The radiation measurements are performed in X, Y, Z axis positioning. And found the X axis positioning which it is worse case, only the test worst case mode is recorded in the report. 					
Test Instruments:	Refer to section 6.0 for details					
Test mode:	Refer to section 5.2 for details					
Test environment:	Temp.:	25 °C	Humid.:	52%	Press.:	1012mbar
Test voltage:	AC 120V, 60Hz					
Test results:	Pass					

Remarks:

1. Only the worst case Main Antenna test data.
2. Pre-scan all kind of the place mode (X-axis, Y-axis, Z-axis), and found the Y-axis which it is worse case.

Measurement Data:

9 kHz ~ 30 MHz

The low frequency, which started from 9 kHz to 30 MHz, was pre-scanned and the result which was 20 dB lower than the limit line per 15.31(o) was not reported.

All antennas have test, only the worst case ANT 1 report.

Below 1GHz

Test mode:	802.11a	Test channel:	Lowest	Polarization:	Horizontal
------------	---------	---------------	--------	---------------	------------

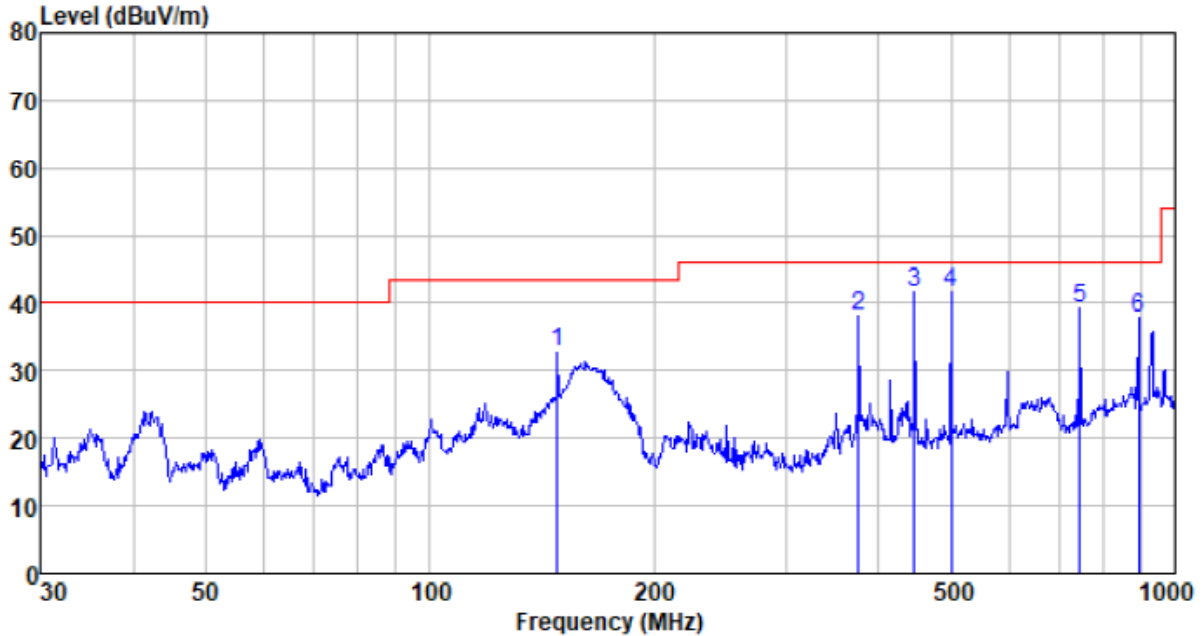

Freq MHz	Reading level dBuV	Antenna factor dB/m	Cable loss dB	Preamp factor dB	level dBuV/m	Limit level dBuV/m	Over limit dB	Remark
148.441	60.57	7.57	1.56	37.07	32.63	43.50	-10.87	QP
375.939	57.93	14.94	2.75	37.50	38.12	46.00	-7.88	QP
446.414	59.78	16.28	3.07	37.52	41.61	46.00	-4.39	QP
501.179	58.59	17.30	3.31	37.51	41.69	46.00	-4.31	QP
744.866	52.25	20.41	4.26	37.63	39.29	46.00	-6.71	QP
893.857	48.27	22.23	4.83	37.60	37.73	46.00	-8.27	QP

Test mode:	802.11a	Test channel:	Lowest	Polarization:	Vertical
------------	---------	---------------	--------	---------------	----------

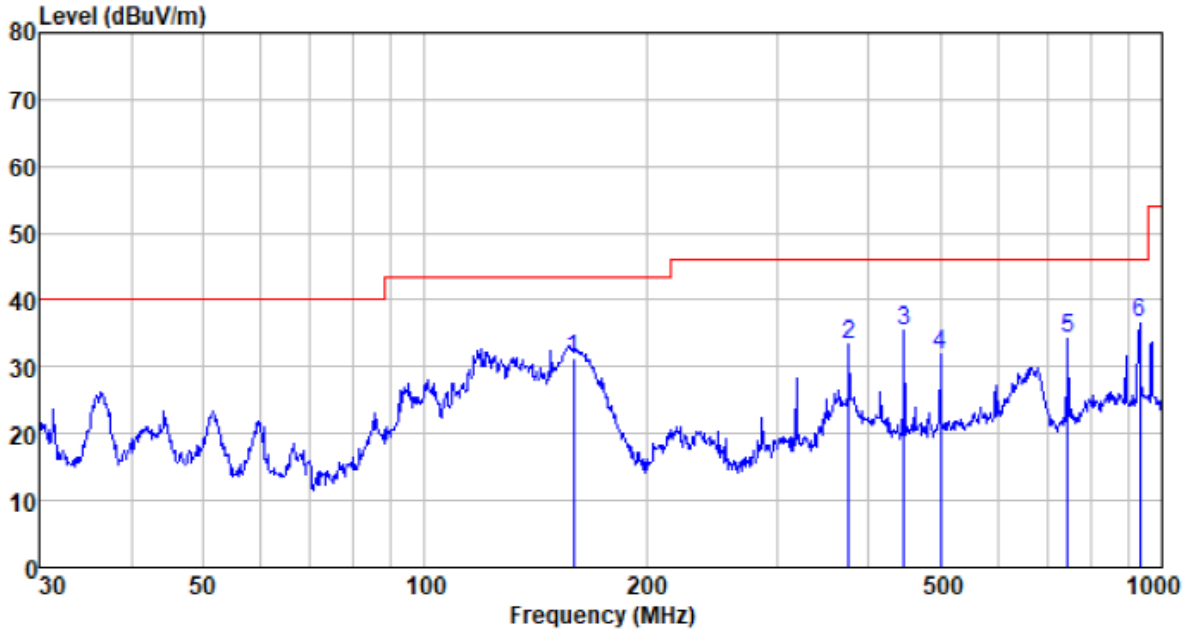

Freq MHz	Reading level dBuV	Antenna factor dB/m	Cable loss dB	Preamp factor dB	level dBuV/m	Limit level dBuV/m	Over limit dB	Remark
159.225	58.46	8.25	1.62	37.13	31.20	43.50	-12.30	QP
375.939	53.04	14.94	2.75	37.50	33.23	46.00	-12.77	QP
446.414	53.51	16.28	3.07	37.52	35.34	46.00	-10.66	QP
501.179	48.84	17.30	3.31	37.51	31.94	46.00	-14.06	QP
744.866	47.28	20.41	4.26	37.63	34.32	46.00	-11.68	QP
932.272	46.69	22.43	4.98	37.57	36.53	46.00	-9.47	QP

Test mode:	802.11a	Test channel:	Middle	Polarization:	Horizontal
------------	---------	---------------	--------	---------------	------------

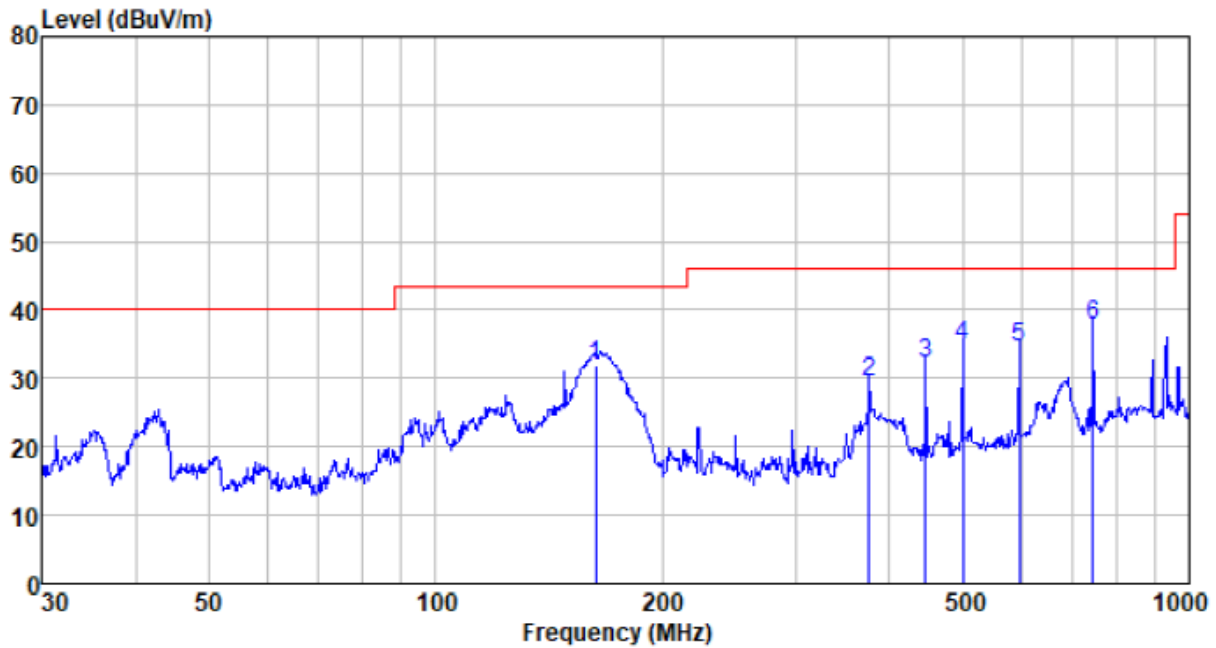

Freq MHz	Reading level dBUV	Antenna factor dB/m	Cable loss dB	Preamp factor dB	level dBUV/m	Limit level dBUV/m	Over limit dB	Remark
163.182	59.13	8.37	1.65	37.15	32.00	43.50	-11.50	QP
375.939	49.41	14.94	2.75	37.50	29.60	46.00	-16.40	QP
446.414	50.44	16.28	3.07	37.52	32.27	46.00	-13.73	QP
501.179	51.73	17.30	3.31	37.51	34.83	46.00	-11.17	QP
595.133	48.86	19.39	3.70	37.54	34.41	46.00	-11.59	QP
744.866	50.87	20.41	4.26	37.63	37.91	46.00	-8.09	QP

Test mode:	802.11a	Test channel:	Middle	Polarization:	Vertical
------------	---------	---------------	--------	---------------	----------

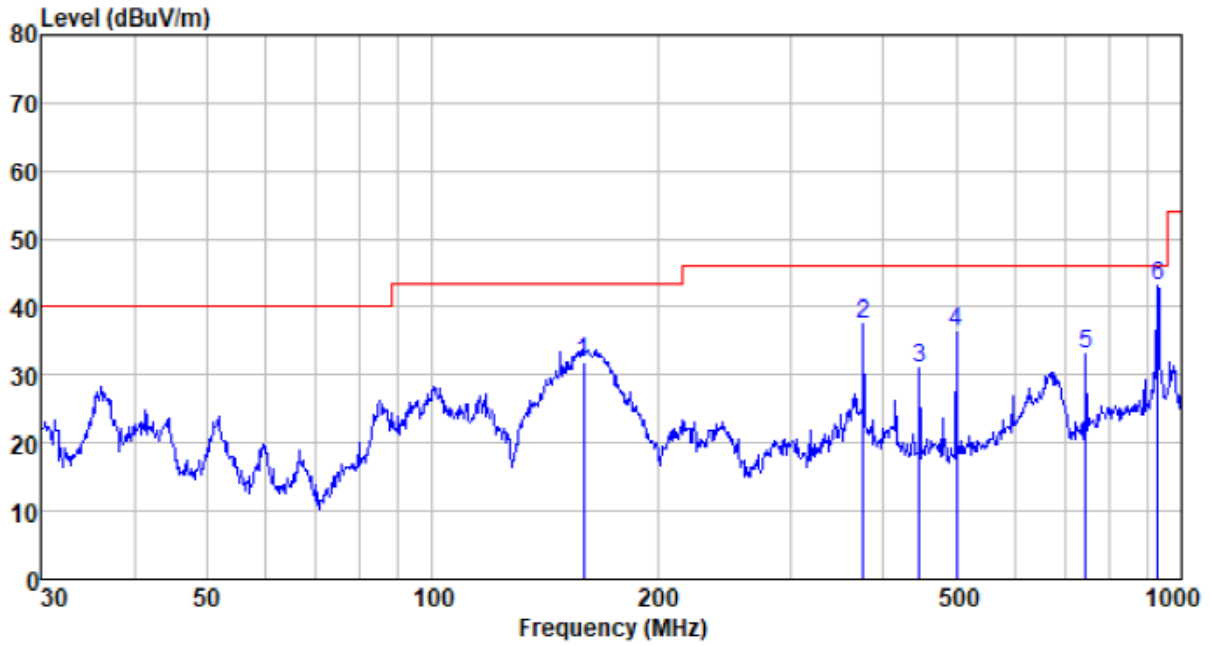

Freq MHz	Reading level dBuV	Antenna factor dB/m	Cable loss dB	Preamp factor dB	level dBUV/m	Limit level dBUV/m	Over limit dB	Remark
159.225	59.13	8.25	1.62	37.13	31.87	43.50	-11.63	QP
375.939	57.16	14.94	2.75	37.50	37.35	46.00	-8.65	QP
446.414	49.03	16.28	3.07	37.52	30.86	46.00	-15.14	QP
501.179	53.09	17.30	3.31	37.51	36.19	46.00	-9.81	QP
744.866	46.16	20.41	4.26	37.63	33.20	46.00	-12.80	QP
929.008	53.16	22.41	4.96	37.57	42.96	46.00	-3.04	QP

Test mode:	802.11a	Test channel:	Highest	Polarization:	Horizontal
------------	---------	---------------	---------	---------------	------------

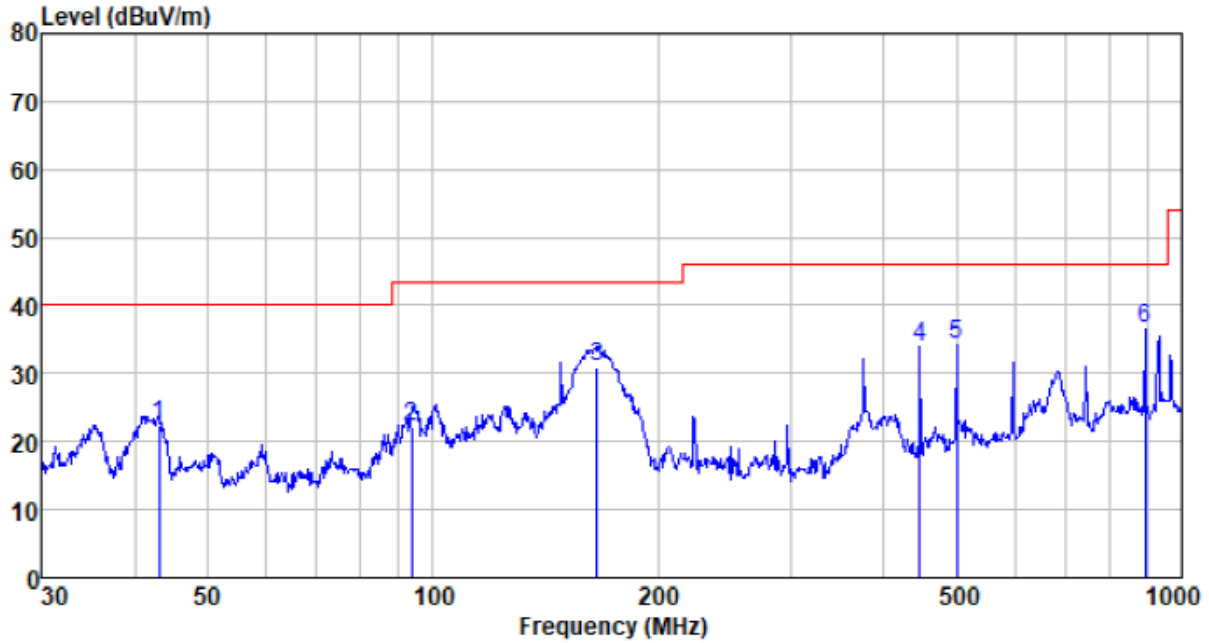

Freq MHz	Reading level dBUV	Antenna factor dB/m	Cable loss dB	Preamp factor dB	level dBUV/m	Limit level dBUV/m	Over limit dB	Remark
43.050	45.20	12.23	0.70	35.83	22.30	40.00	-17.70	QP
93.768	46.37	11.25	1.14	36.67	22.09	43.50	-21.41	QP
165.487	57.99	8.41	1.66	37.16	30.90	43.50	-12.60	QP
446.414	52.25	16.28	3.07	37.52	34.08	46.00	-11.92	QP
501.179	51.24	17.30	3.31	37.51	34.34	46.00	-11.66	QP
893.857	47.23	22.23	4.83	37.60	36.69	46.00	-9.31	QP

Test mode:	802.11a	Test channel:	Highest	Polarization:	Vertical
------------	---------	---------------	---------	---------------	----------

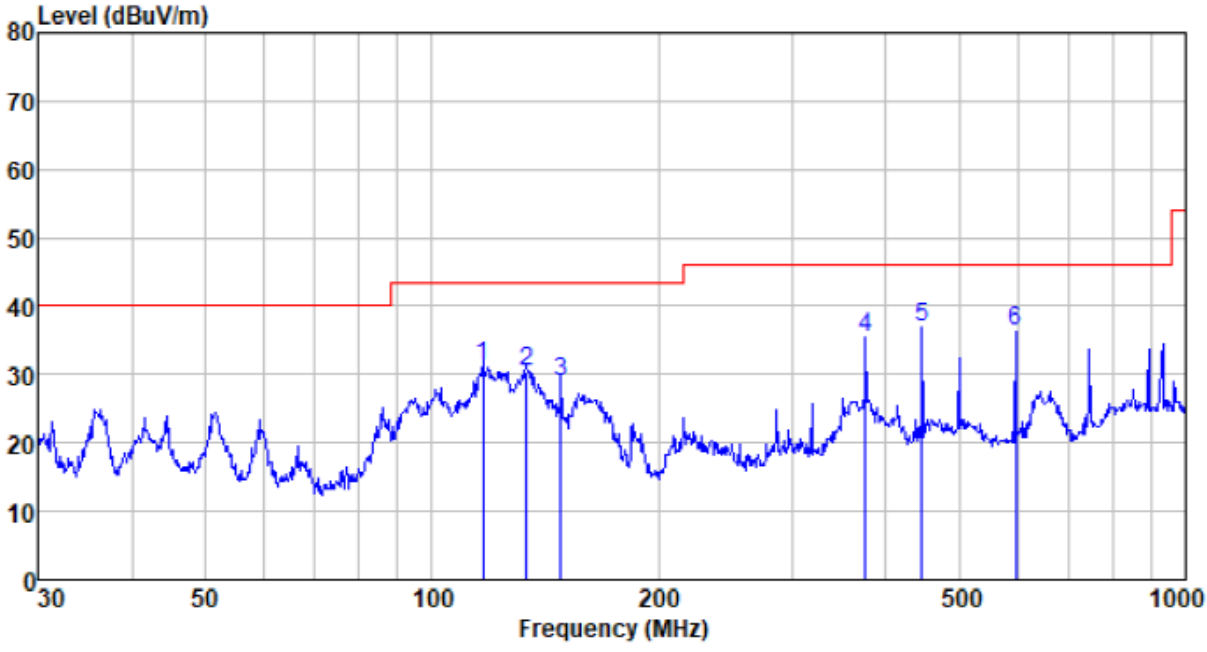

Freq MHz	Reading level dBuV	Antenna factor dB/m	Cable loss dB	Preamp factor dB	level dBuV/m	Limit level dBuV/m	Over limit dB	Remark
116.950	56.81	10.01	1.34	36.86	31.30	43.50	-12.20	QP
133.619	57.90	7.92	1.46	36.98	30.30	43.50	-13.20	QP
148.441	56.79	7.57	1.56	37.07	28.85	43.50	-14.65	QP
375.939	55.22	14.94	2.75	37.50	35.41	46.00	-10.59	QP
446.414	54.99	16.28	3.07	37.52	36.82	46.00	-9.18	QP
595.133	50.87	19.39	3.70	37.54	36.42	46.00	-9.58	QP

Test mode:	802.11n(HT20)	Test channel:	Lowest	Polarization:	Horizontal
------------	---------------	---------------	--------	---------------	------------

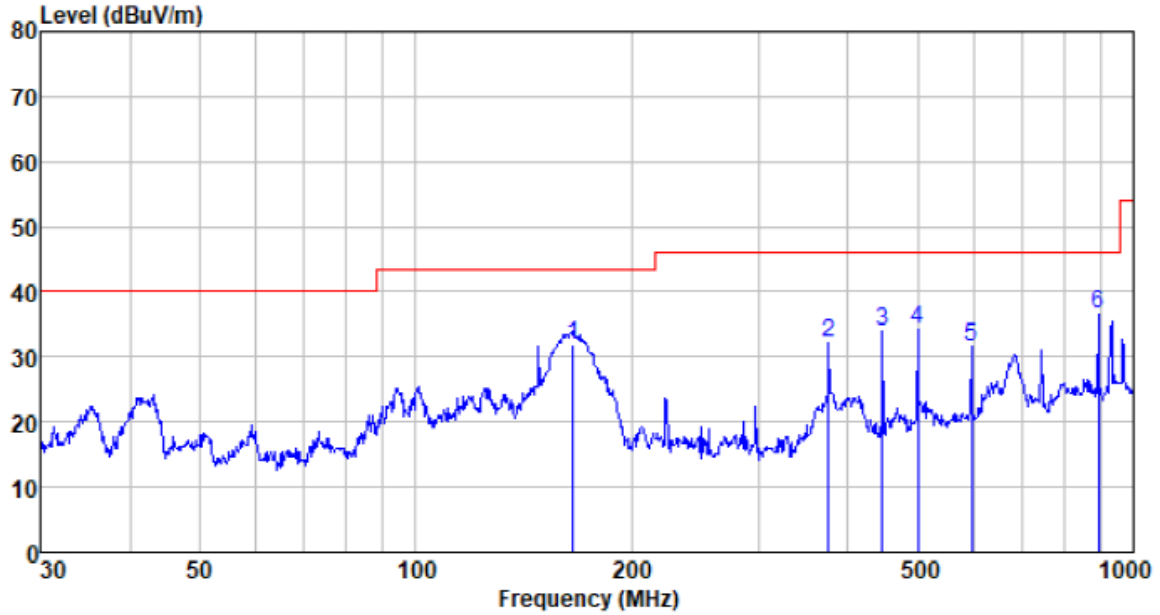

Freq MHz	Reading level dBuV	Antenna factor dB/m	Cable loss dB	Preamp factor dB	level dBuV/m	Limit level dBuV/m	Over limit dB	Remark
165.487	58.99	8.41	1.66	37.16	31.90	43.50	-11.60	QP
375.939	52.11	14.94	2.75	37.50	32.30	46.00	-13.70	QP
446.414	52.25	16.28	3.07	37.52	34.08	46.00	-11.92	QP
501.179	51.24	17.30	3.31	37.51	34.34	46.00	-11.66	QP
595.133	46.11	19.39	3.70	37.54	31.66	46.00	-14.34	QP
893.857	47.23	22.23	4.83	37.60	36.69	46.00	-9.31	QP

Test mode:	802.11n(HT20)	Test channel:	Lowest	Polarization:	Vertical
------------	---------------	---------------	--------	---------------	----------

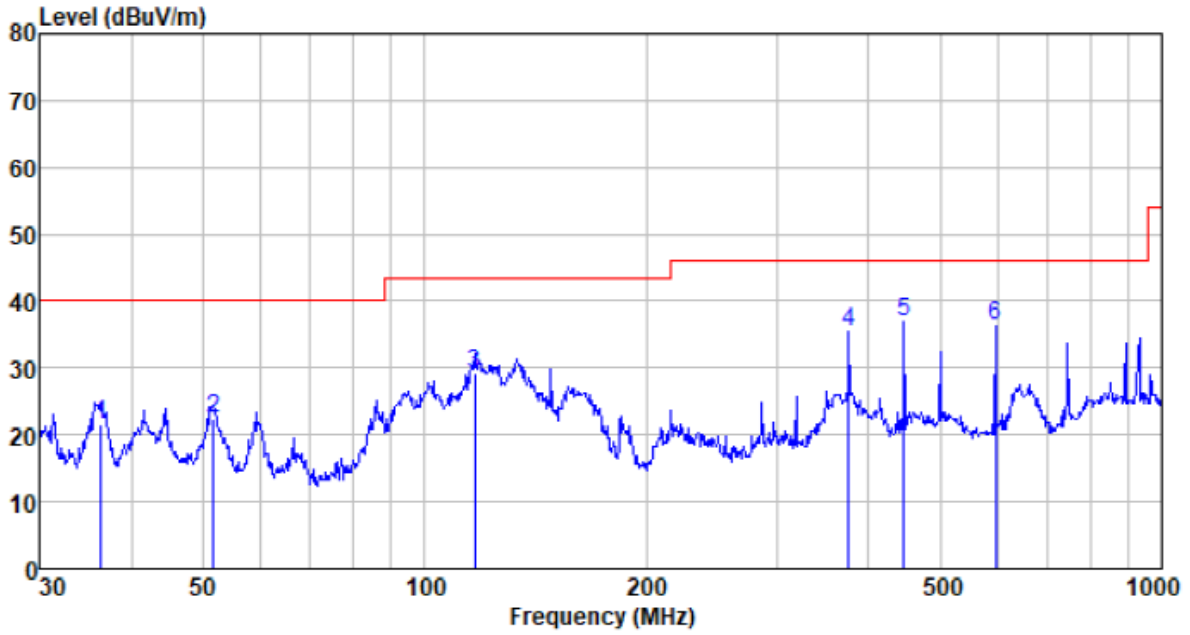

Freq MHz	Reading level dBuV	Antenna factor dB/m	Cable loss dB	Preamp factor dB	level dBuV/m	Limit level dBuV/m	Over limit dB	Remark
36.381	44.94	11.58	0.62	35.45	21.69	40.00	-18.31	QP
51.662	45.71	12.12	0.79	36.21	22.41	40.00	-17.59	QP
116.950	54.81	10.01	1.34	36.86	29.30	43.50	-14.20	QP
375.939	55.22	14.94	2.75	37.50	35.41	46.00	-10.59	QP
446.414	54.99	16.28	3.07	37.52	36.82	46.00	-9.18	QP
595.133	50.87	19.39	3.70	37.54	36.42	46.00	-9.58	QP

Test mode:	802.11n(HT20)	Test channel:	Middle	Polarization:	Horizontal
------------	---------------	---------------	--------	---------------	------------

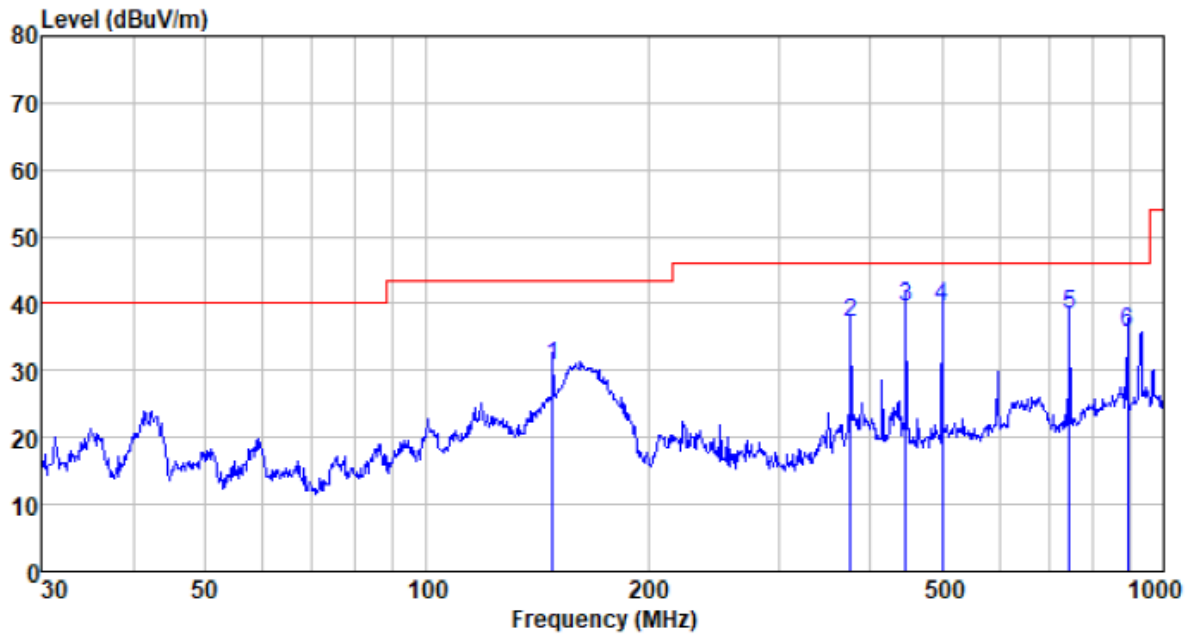

Freq MHz	Reading level dBuV	Antenna factor dB/m	Cable loss dB	Preamp factor dB	level dBuV/m	Limit level dBuV/m	Over limit dB	Remark
148.441	58.57	7.57	1.56	37.07	30.63	43.50	-12.87	QP
375.939	56.93	14.94	2.75	37.50	37.12	46.00	-8.88	QP
446.414	57.78	16.28	3.07	37.52	39.61	46.00	-6.39	QP
501.179	56.59	17.30	3.31	37.51	39.69	46.00	-6.31	QP
744.866	51.25	20.41	4.26	37.63	38.29	46.00	-7.71	QP
893.857	46.27	22.23	4.83	37.60	35.73	46.00	-10.27	QP

Test mode:	802.11n(HT20)	Test channel:	Middle	Polarization:	Vertical
------------	---------------	---------------	--------	---------------	----------

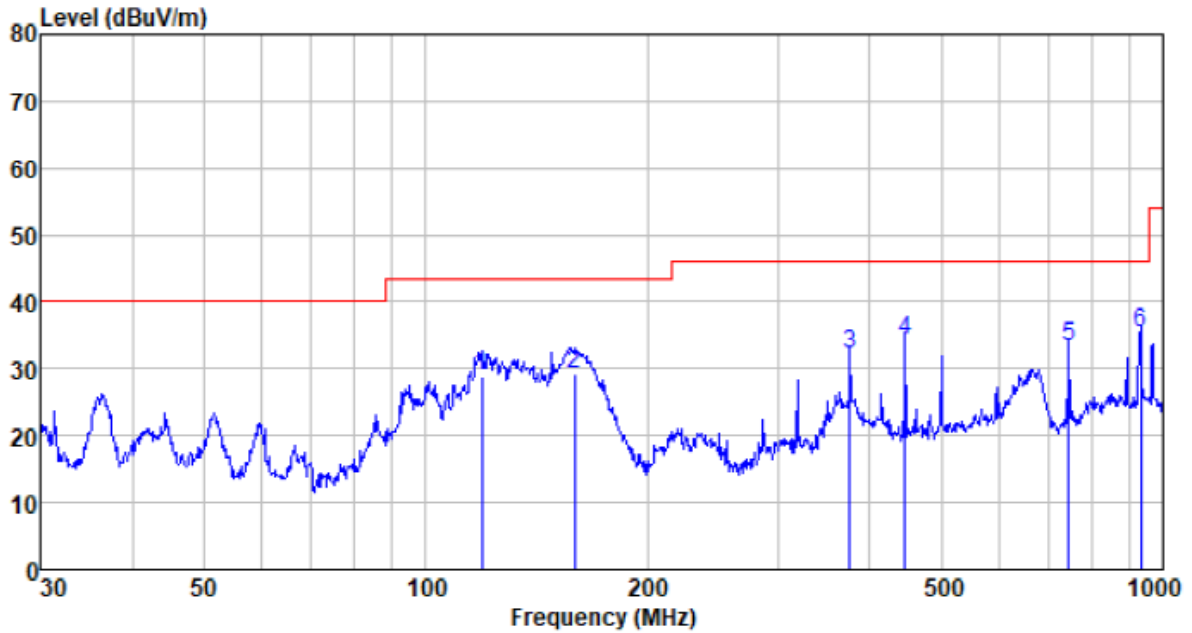

Freq MHz	Reading level dBuV	Antenna factor dB/m	Cable loss dB	Preamp factor dB	level dBuV/m	Limit level dBuV/m	Over limit dB	Remark
119.018	54.76	9.67	1.35	36.87	28.91	43.50	-14.59	QP
159.225	56.46	8.25	1.62	37.13	29.20	43.50	-14.30	QP
375.939	52.04	14.94	2.75	37.50	32.23	46.00	-13.77	QP
446.414	52.51	16.28	3.07	37.52	34.34	46.00	-11.66	QP
744.866	46.28	20.41	4.26	37.63	33.32	46.00	-12.68	QP
932.272	45.69	22.43	4.98	37.57	35.53	46.00	-10.47	QP

Test mode:	802.11n(HT20)	Test channel:	Highest	Polarization:	Horizontal
------------	---------------	---------------	---------	---------------	------------

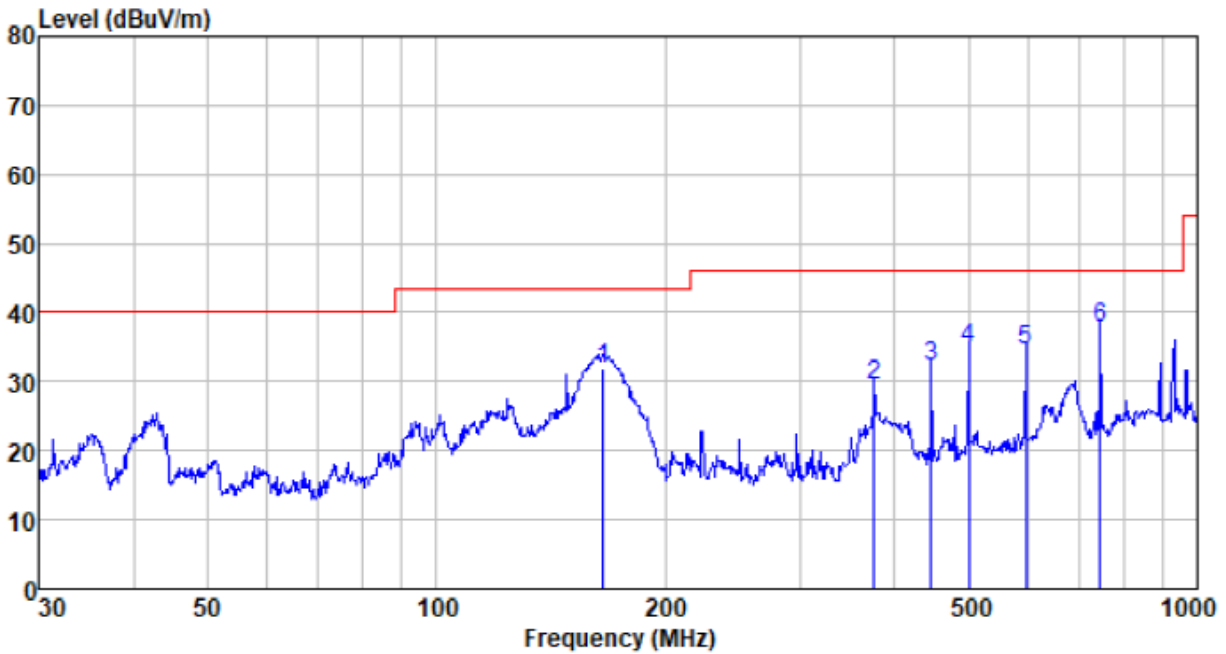

Freq MHz	Reading level dBuV	Antenna factor dB/m	Cable loss dB	Preamp factor dB	level dBuV/m	Limit level dBuV/m	Over limit dB	Remark
165.487	58.94	8.41	1.66	37.16	31.85	43.50	-11.65	QP
375.939	49.41	14.94	2.75	37.50	29.60	46.00	-16.40	QP
446.414	50.44	16.28	3.07	37.52	32.27	46.00	-13.73	QP
501.179	51.73	17.30	3.31	37.51	34.83	46.00	-11.17	QP
595.133	48.86	19.39	3.70	37.54	34.41	46.00	-11.59	QP
744.866	50.87	20.41	4.26	37.63	37.91	46.00	-8.09	QP

Test mode:	802.11n(HT20)	Test channel:	Highest	Polarization:	Vertical
------------	---------------	---------------	---------	---------------	----------

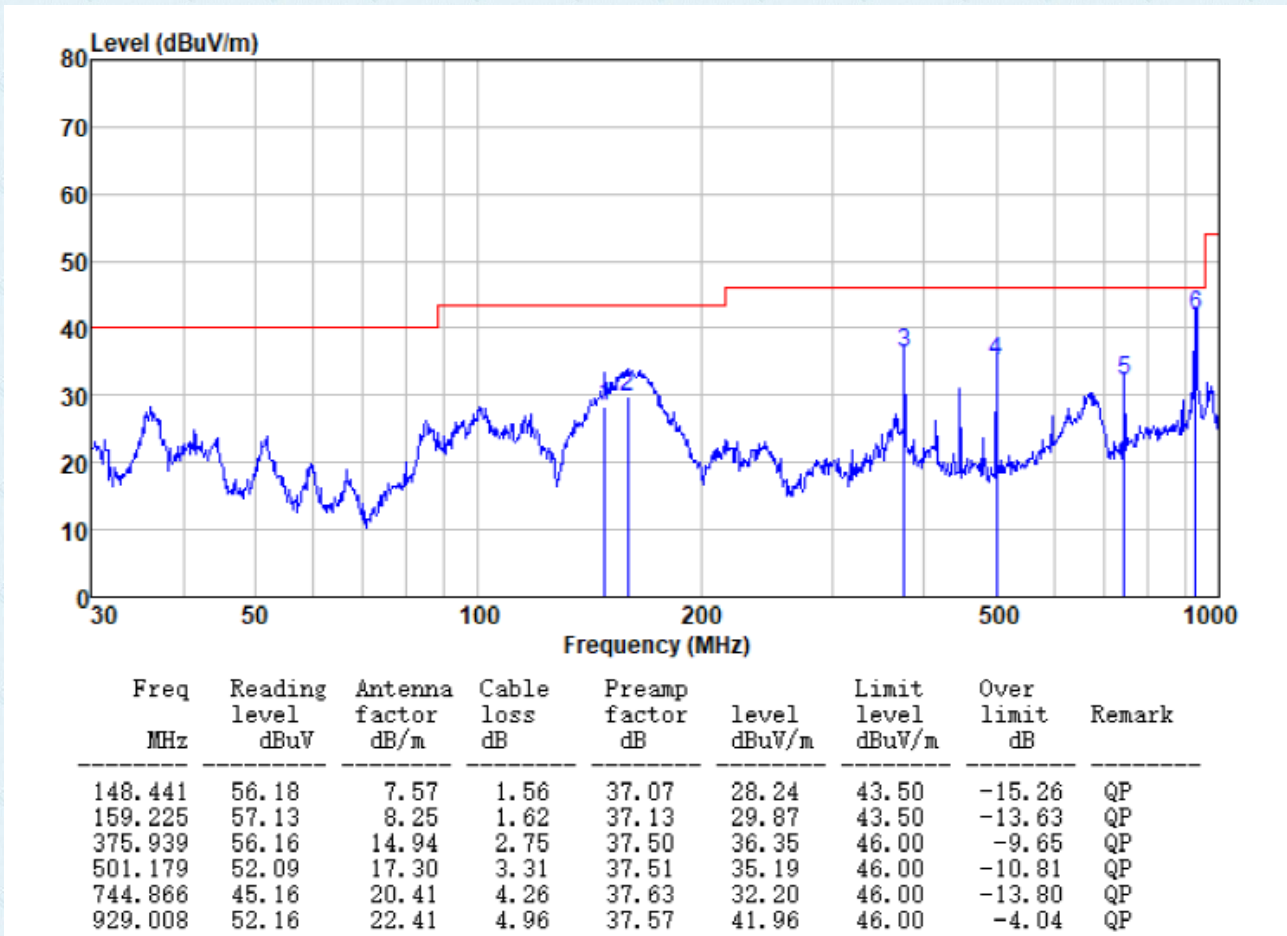

Test mode:	802.11ac(HT20)	Test channel:	Lowest	Polarization:	Horizontal
------------	----------------	---------------	--------	---------------	------------

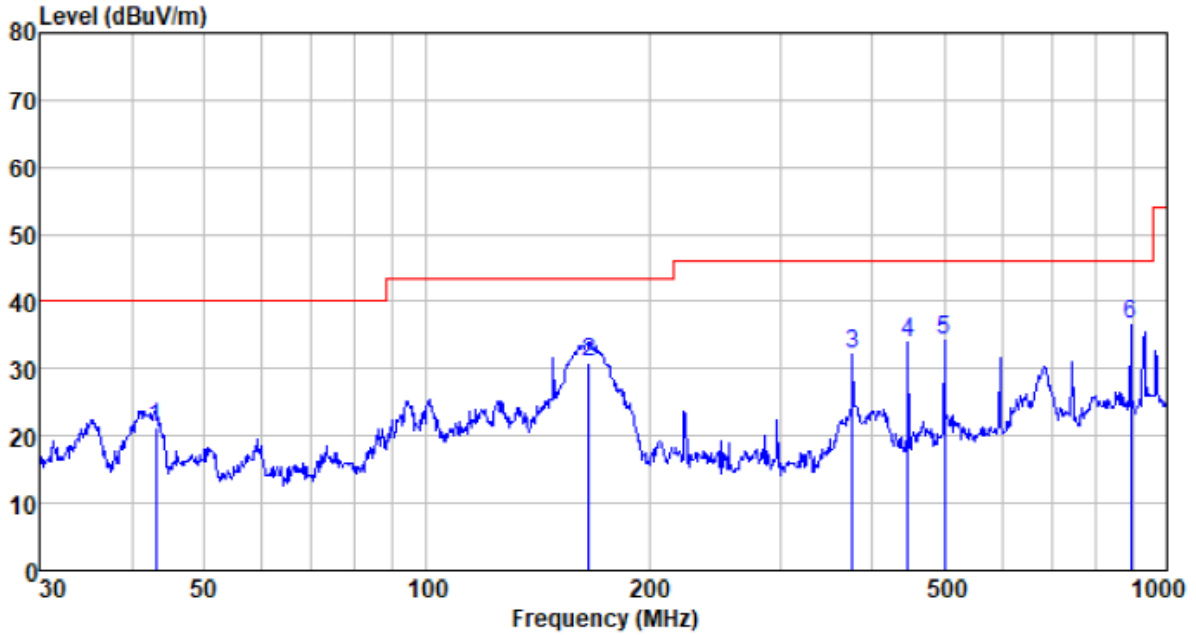

Freq MHz	Reading level dBUV	Antenna factor dB/m	Cable loss dB	Preamp factor dB	level dBUV/m	Limit level dBUV/m	Over limit dB	Remark
43.050	44.20	12.23	0.70	35.83	21.30	40.00	-18.70	QP
165.487	57.99	8.41	1.66	37.16	30.90	43.50	-12.60	QP
375.939	52.11	14.94	2.75	37.50	32.30	46.00	-13.70	QP
446.414	52.25	16.28	3.07	37.52	34.08	46.00	-11.92	QP
501.179	51.24	17.30	3.31	37.51	34.34	46.00	-11.66	QP
893.857	47.23	22.23	4.83	37.60	36.69	46.00	-9.31	QP

Test mode:	802.11ac(HT20)	Test channel:	Lowest	Polarization:	Vertical
------------	----------------	---------------	--------	---------------	----------

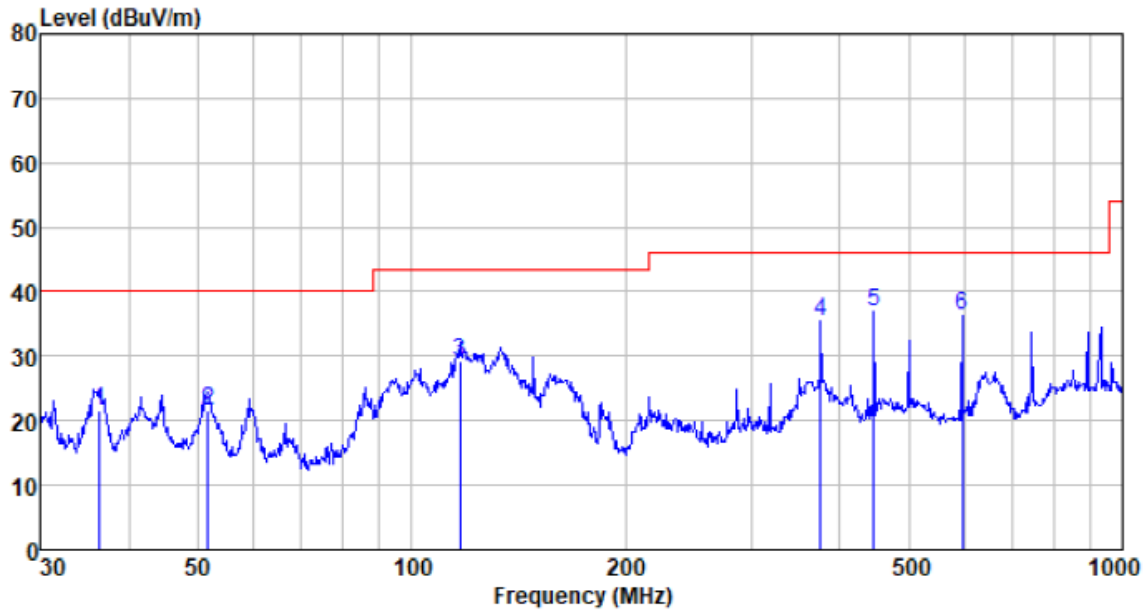

Freq MHz	Reading level dBuV	Antenna factor dB/m	Cable loss dB	Preamp factor dB	level dBuV/m	Limit level dBuV/m	Over limit dB	Remark
36.381	44.94	11.58	0.62	35.45	21.69	40.00	-18.31	QP
51.662	44.71	12.12	0.79	36.21	21.41	40.00	-18.59	QP
116.950	54.81	10.01	1.34	36.86	29.30	43.50	-14.20	QP
375.939	55.22	14.94	2.75	37.50	35.41	46.00	-10.59	QP
446.414	54.99	16.28	3.07	37.52	36.82	46.00	-9.18	QP
595.133	50.87	19.39	3.70	37.54	36.42	46.00	-9.58	QP

Test mode:	802.11ac(HT20)	Test channel:	Middle	Polarization:	Horizontal
------------	----------------	---------------	--------	---------------	------------

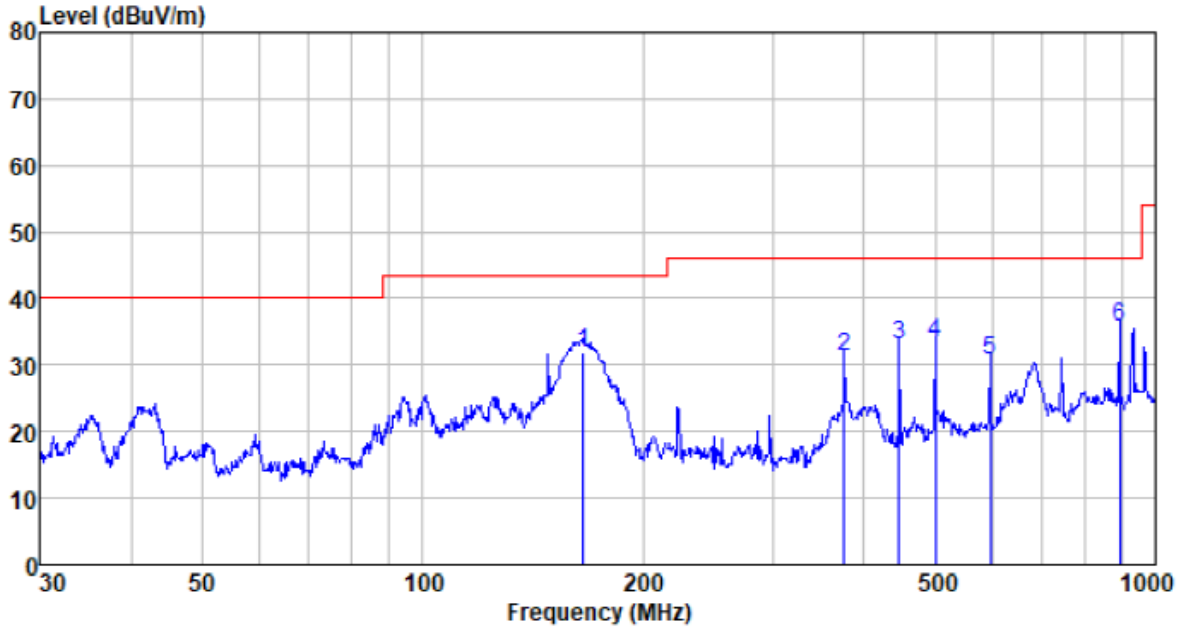

Freq MHz	Reading level dBuV	Antenna factor dB/m	Cable loss dB	Preamp factor dB	level dBuV/m	Limit level dBuV/m	Over limit dB	Remark
165.487	58.99	8.41	1.66	37.16	31.90	43.50	-11.60	QP
375.939	51.11	14.94	2.75	37.50	31.30	46.00	-14.70	QP
446.414	51.25	16.28	3.07	37.52	33.08	46.00	-12.92	QP
501.179	50.24	17.30	3.31	37.51	33.34	46.00	-12.66	QP
595.133	45.11	19.39	3.70	37.54	30.66	46.00	-15.34	QP
893.857	46.23	22.23	4.83	37.60	35.69	46.00	-10.31	QP

Test mode:	802.11ac(HT20)	Test channel:	Middle	Polarization:	Vertical
------------	----------------	---------------	--------	---------------	----------

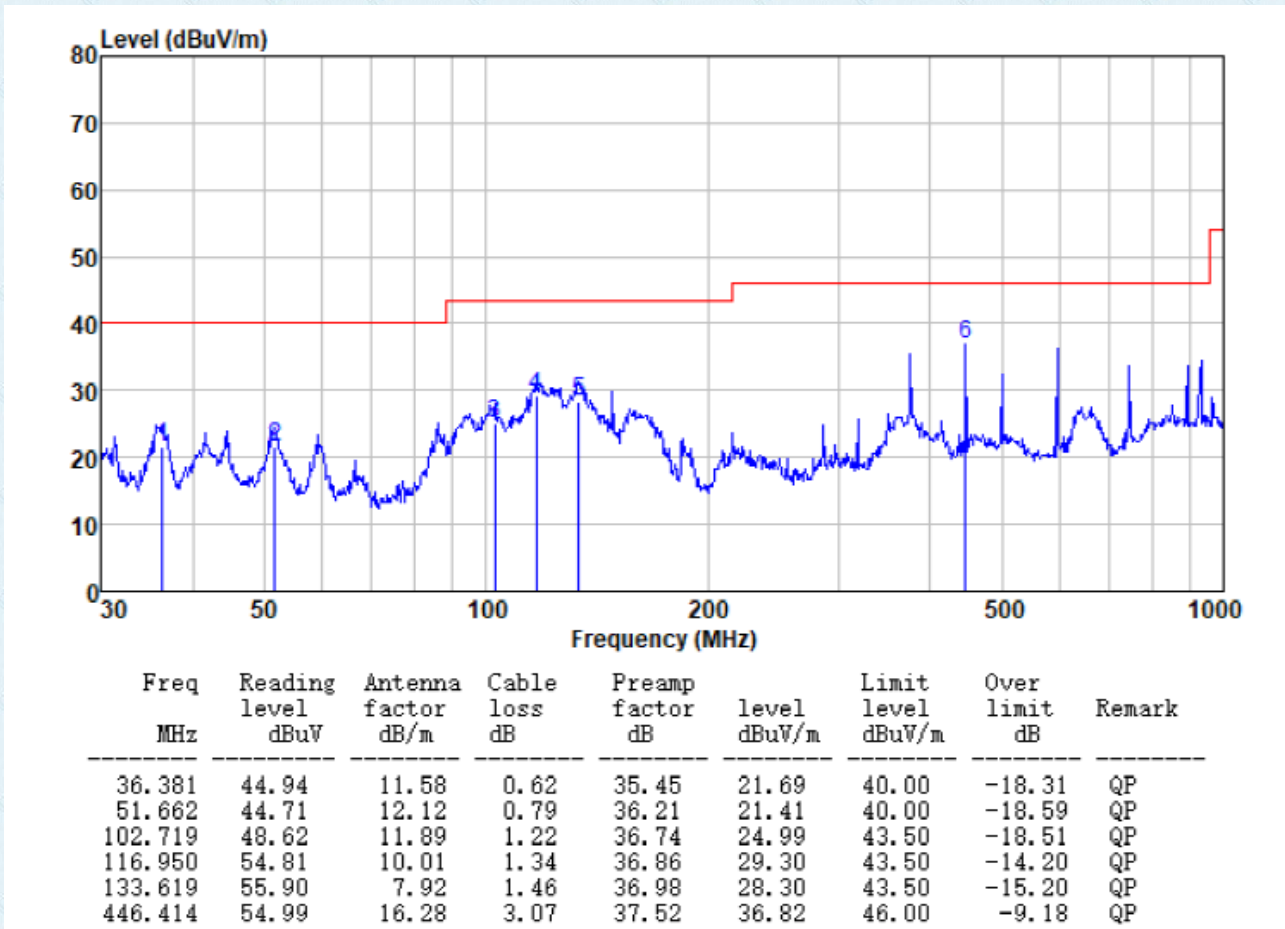

Test mode:	802.11ac(HT20)	Test channel:	Highest	Polarization:	Horizontal
------------	----------------	---------------	---------	---------------	------------

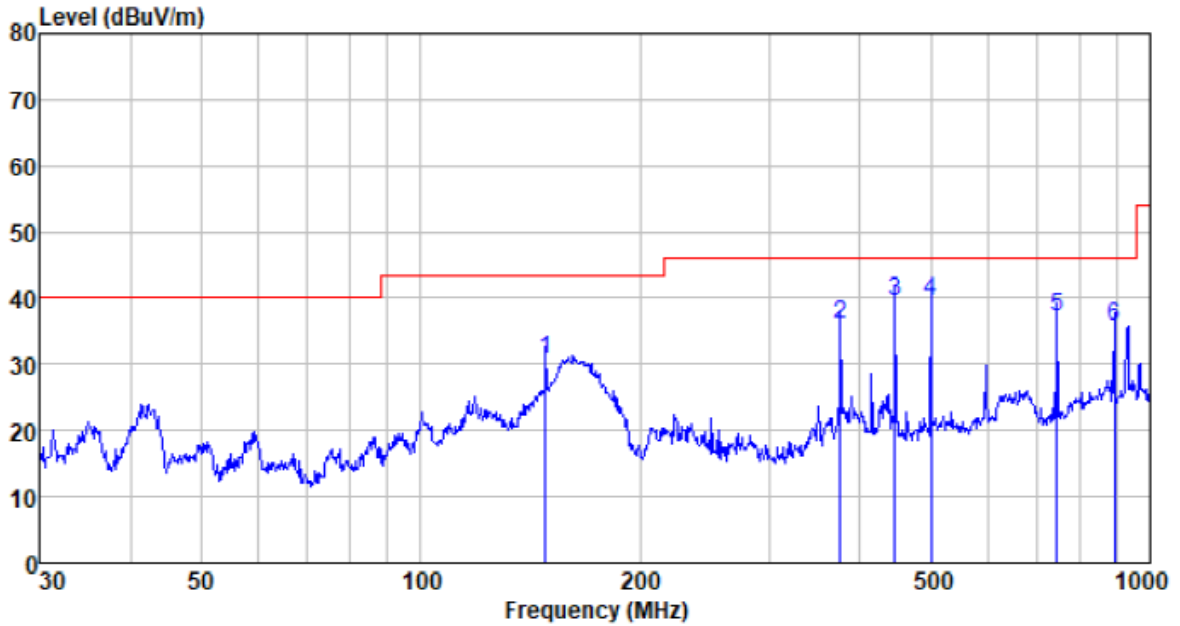

Freq MHz	Reading level dBuV	Antenna factor dB/m	Cable loss dB	Preamp factor dB	level dBuV/m	Limit level dBuV/m	Over limit dB	Remark
148.441	58.57	7.57	1.56	37.07	30.63	43.50	-12.87	QP
375.939	55.93	14.94	2.75	37.50	36.12	46.00	-9.88	QP
446.414	57.78	16.28	3.07	37.52	39.61	46.00	-6.39	QP
501.179	56.59	17.30	3.31	37.51	39.69	46.00	-6.31	QP
744.866	50.25	20.41	4.26	37.63	37.29	46.00	-8.71	QP
893.857	46.27	22.23	4.83	37.60	35.73	46.00	-10.27	QP

Test mode:	802.11ac(HT20)	Test channel:	Highest	Polarization:	Vertical
------------	----------------	---------------	---------	---------------	----------

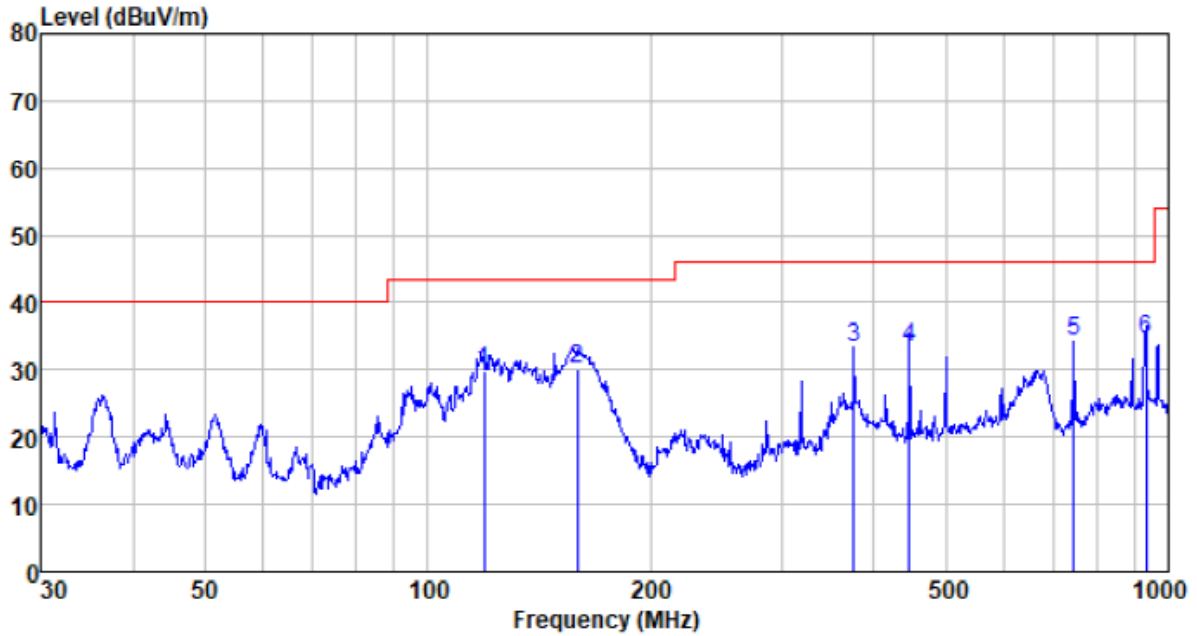

Freq MHz	Reading level dBuV	Antenna factor dB/m	Cable loss dB	Preamp factor dB	level dBuV/m	Limit level dBuV/m	Over limit dB	Remark
119.018	55.76	9.67	1.35	36.87	29.91	43.50	-13.59	QP
159.225	57.46	8.25	1.62	37.13	30.20	43.50	-13.30	QP
375.939	53.04	14.94	2.75	37.50	33.23	46.00	-12.77	QP
446.414	51.51	16.28	3.07	37.52	33.34	46.00	-12.66	QP
744.866	47.28	20.41	4.26	37.63	34.32	46.00	-11.68	QP
932.272	44.69	22.43	4.98	37.57	34.53	46.00	-11.47	QP

Above 1GHz:

Test mode:		802.11a		Test channel:		lowest	
Antenna Pol.	Frequency (MHz)	Reading Level (dBuV/m)	Factor (dBuV/m)	Measure Level (dBuV/m)	Limit (dBuV/m)	Over limit(dB)	Detector
V	11490.00	24.23	21.64	45.87	68.20	-22.33	PK
V	17235.00	23.45	21.80	45.25	68.20	-22.95	PK
H	11490.00	23.96	21.83	45.79	68.20	-22.41	PK
H	17235.00	22.18	21.67	43.85	68.20	-24.35	PK

Test mode:		802.11a		Test channel:		Middle	
Antenna Pol.	Frequency (MHz)	Reading Level (dBuV/m)	Factor (dBuV/m)	Measure Level (dBuV/m)	Limit (dBuV/m)	Over limit(dB)	Detector
V	11570.00	23.65	21.64	45.29	68.20	-22.91	PK
V	17355.00	21.86	21.80	41.08	68.20	-27.12	PK
H	11570.00	18.96	21.83	38.92	68.20	-29.28	PK
H	17355.00	19.65	21.67	39.37	68.20	-28.83	PK

Test mode:		802.11a		Test channel:		Highest	
Antenna Pol.	Frequency (MHz)	Reading Level (dBuV/m)	Factor (dBuV/m)	Measure Level (dBuV/m)	Limit (dBuV/m)	Over limit(dB)	Detector
V	11610.00	22.53	21.64	44.17	68.20	-24.03	PK
V	17415.00	21.65	21.80	43.45	68.20	-24.75	PK
H	11610.00	20.35	21.83	42.18	68.20	-26.02	PK
H	17415.00	19.35	21.67	41.02	68.20	-27.18	PK

Test mode:		802.11n(HT20)		Test channel:		lowest	
Antenna Pol.	Frequency (MHz)	Reading Level (dBuV/m)	Factor (dBuV/m)	Measure Level (dBuV/m)	Limit (dBuV/m)	Over limit(dB)	Detector
V	11490.00	23.52	21.64	45.16	68.20	-23.04	PK
V	17235.00	21.03	21.80	42.83	68.20	-25.37	PK
H	11490.00	21.99	21.83	43.82	68.20	-24.38	PK
H	17235.00	20.35	21.67	42.02	68.20	-26.18	PK

Test mode:		802.11n(HT20)		Test channel:		Middle	
Antenna Pol.	Frequency (MHz)	Reading Level (dBuV/m)	Factor (dBuV/m)	Measure Level (dBuV/m)	Limit (dBuV/m)	Over limit(dB)	Detector
V	11570.00	21.35	21.64	42.99	68.20	-25.21	PK
V	17355.00	20.35	21.80	41.08	68.20	-27.12	PK
H	11570.00	16.58	21.83	38.92	68.20	-29.28	PK
H	17355.00	17.53	21.67	39.37	68.20	-28.83	PK

Test mode:		802.11n(HT20)		Test channel:		Highest	
Antenna Pol.	Frequency (MHz)	Reading Level (dBuV/m)	Factor (dBuV/m)	Measure Level (dBuV/m)	Limit (dBuV/m)	Over limit(dB)	Detector
V	11610.00	20.63	21.64	42.27	68.20	-25.93	PK
V	17415.00	19.34	21.80	41.14	68.20	-27.06	PK
H	11610.00	18.95	21.83	40.78	68.20	-27.42	PK
H	17415.00	17.65	21.67	39.32	68.20	-28.88	PK

Test mode:		802.11ac(HT20)		Test channel:		lowest	
Antenna Pol.	Frequency (MHz)	Reading Level (dBuV/m)	Factor (dBuV/m)	Measure Level (dBuV/m)	Limit (dBuV/m)	Over limit(dB)	Detector
V	11490.00	23.54	21.64	45.18	68.20	-23.02	PK
V	17235.00	21.68	21.80	43.48	68.20	-24.72	PK
H	11490.00	21.63	21.83	43.46	68.20	-24.74	PK
H	17235.00	19.48	21.67	41.15	68.20	-27.05	PK

Test mode:		802.11ac(HT20)		Test channel:		Middle	
Antenna Pol.	Frequency (MHz)	Reading Level (dBuV/m)	Factor (dBuV/m)	Measure Level (dBuV/m)	Limit (dBuV/m)	Over limit(dB)	Detector
V	11570.00	21.06	21.64	42.70	68.20	-25.50	PK
V	17355.00	18.65	21.80	40.45	68.20	-27.75	PK
H	11570.00	18.68	21.83	40.51	68.20	-27.69	PK
H	17355.00	17.62	21.67	39.29	68.20	-28.91	PK

Test mode:		802.11ac(HT20)		Test channel:		Highest	
Antenna Pol.	Frequency (MHz)	Reading Level (dBuV/m)	Factor (dBuV/m)	Measure Level (dBuV/m)	Limit (dBuV/m)	Over limit(dB)	Detector
V	11610.00	21.86	21.64	43.50	68.20	-24.70	PK
V	17415.00	19.52	21.80	41.32	68.20	-26.88	PK
H	11610.00	18.45	21.83	40.28	68.20	-27.92	PK
H	17415.00	17.35	21.67	39.02	68.20	-29.18	PK

Notes:

1. Measure Level = Reading Level + Factor.
2. The test trace is same as the ambient noise (the test frequency range: 18GHz~40GHz), therefore no data appear in the report.
3. The test result on peak is lower than average limit, then average measurement needn't be performed.

7.8 Frequency stability

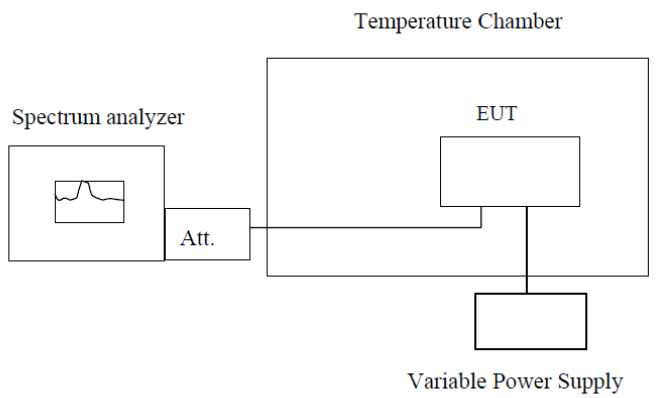
Test Requirement:	FCC Part15 C Section 15.407(g) RSS-Gen Section 8.11
Test Method:	ANSI C63.10:2013, FCC Part 2.1055 & RSS-Gen
Limit:	Manufactures of U-NII devices are responsible for ensuring frequency stability such that an emission is maintained within the band of operation under all conditions of normal operation as specified
Test Procedure:	The EUT was setup to ANSI C63.4, 2003; tested to 2.1055 for compliance to FCC Part 15.407(g) requirements.
Test setup:	 <p>Note : Measurement setup for testing on Antenna connector</p>
Test Instruments:	Refer to section 6 for details
Test mode:	Refer to section 5.2 for details
Test results:	Pass

Measurement Data: The detailed test data see Appendix for WIFI 5.8G

8 Test Setup Photo

Reference to the **appendix I** for details.

9 EUT Constructional Details

Reference to the **appendix II** for details.

-----END-----