

Test Report

Report No.: MTi231204020-19E1
Date of issue: 2024-01-04
Applicant: Shenzhen Caibo Technology Co., Ltd.
Product: 3 in 1 Magnetic Wireless Charger
Model(s): T6
FCC ID: 2AXTH-T6

Shenzhen Microtest Co., Ltd.

<http://www.mtitest.com>

The test report is only used for customer scientific research, teaching, internal quality control and other purposes, and is for internal reference only.





Instructions

1. This test report shall not be partially reproduced without the written consent of the laboratory.
2. The test results in this test report are only responsible for the samples submitted
3. This test report is invalid without the seal and signature of the laboratory.
4. This test report is invalid if transferred, altered, or tampered with in any form without authorization.
5. Any objection to this test report shall be submitted to the laboratory within 15 days from the date of receipt of the report.

Table of contents

1	General Description	5
1.1	Description of the EUT	5
1.2	Description of test modes	5
1.3	Environmental Conditions	7
1.4	Description of support units	7
1.5	Measurement uncertainty	7
2	Summary of Test Result	8
3	Test Facilities and accreditations	9
3.1	Test laboratory	9
4	List of test equipment.....	10
5	Evaluation Results (Evaluation)	11
5.1	Antenna requirement	11
6	Radio Spectrum Matter Test Results (RF)	12
6.1	Conducted Emission at AC power line	12
6.2	20dB Occupied Bandwidth	15
6.3	Emissions in frequency bands (below 30MHz).....	20
6.4	Emissions in frequency bands (30MHz - 1GHz).....	23
	Photographs of the test setup.....	26
	Photographs of the EUT	27

Test Result Certification	
Applicant:	Shenzhen Caibo Technology Co., Ltd.
Address:	F4, Building 30, Fifth Industrial Zone, Huaide Cuigang Industrial Park, Fu Yong, Bao'an District, Shenzhen China.
Manufacturer:	Shenzhen Caibo Technology Co., Ltd.
Address:	F4, Building 30, Fifth Industrial Zone, Huaide Cuigang Industrial Park, Fu Yong, Bao'an District, Shenzhen China.
Factory:	Shenzhen Caibo Technology Co., Ltd.
Address:	F4, Building 30, Fifth Industrial Zone, Huaide Cuigang Industrial Park, Fu Yong, Bao'an District, Shenzhen China.
Product description	
Product name:	3 in 1 Magnetic Wireless Charger
Trademark:	KOAKUMA
Model name:	T6
Series Model(s):	N/A
Standards:	47 CFR Part 15C
Test Method:	ANSI C63.10-2013
Date of Test	
Date of test:	2023-12-07 to 2023-12-14
Test result:	Pass

Test Engineer	:	
		(Maleah Deng)
Reviewed By	:	
		(Leon Chen)
Approved By	:	
		(Tom Xue)

1 General Description

1.1 Description of the EUT

Product name:	3 in 1 Magnetic Wireless Charger
Model name:	T6
Series Model(s):	N/A
Model difference:	N/A
Electrical rating:	Input: 5V=3A, 9V=3A, 12V=3A MAX Wireless Output: phone: 5W,7.5W,10W,15W; Wireless Earbuds: 3W iWatch: 2.5W
Accessories:	N/A
Hardware version:	T6-9516-V2
Software version:	0x00422D05
Test sample(s) number:	MTi231204020-19S1001
RF specification	
Operating frequency range:	Transmitter1 (Phone): 115-205KHz Transmitter2 (Wireless Earbuds): 115-205KHz Transmitter3 (iWatch): 300-350KHz
Modulation type:	ASK
Antenna(s) type:	Coil Antenna

1.2 Description of test modes

No.	Emission test modes
Mode1	Wireless output(5W)+Wireless Earbuds(3W)+iWatch(2.5W)
Mode2	Wireless output(7.5W)+Wireless Earbuds(3W)+iWatch(2.5W)
Mode3	Wireless output(10W)+Wireless Earbuds(3W)+iWatch(2.5W)
Mode4	Wireless output(15W)+Wireless Earbuds(3W)+iWatch(2.5W)
Mode5	Wireless output(5W)+Wireless Earbuds(3W)
Mode6	Wireless output(7.5W)+Wireless Earbuds(3W)
Mode7	Wireless output(10W)+Wireless Earbuds(3W)
Mode8	Wireless output(15W)+Wireless Earbuds(3W)
Mode9	Wireless output(5W)+iWatch(2.5W)
Mode10	Wireless output(7.5W)+iWatch(2.5W)
Mode11	Wireless output(10W)+iWatch(2.5W)
Mode12	Wireless output(15W)+iWatch(2.5W)
Mode13	Wireless Earbuds(3W)+iWatch(2.5W)
Mode14	Wireless output(5W)
Mode15	Wireless output(7.5W)
Mode16	Wireless output(10W)

Mode17	Wireless output(15W)
Mode18	iWatch(2.5W)
Mode19	Wireless Earbuds(3W)
Mode20	stand by

1.3 Environmental Conditions

During the measurement the environmental conditions were within the listed ranges:

Temperature:	15°C ~ 35°C
Humidity:	20% RH ~ 75% RH
Atmospheric pressure:	98 kPa ~ 101 kPa

1.4 Description of support units

The EUT has been tested as an independent unit together with other necessary accessories or support units. The following support units or accessories were used to form a representative test configuration during the tests.

Support equipment list			
Description	Model	Serial No.	Manufacturer
Lenovo Laptop Portable adapter (65W)	LS-65WTAQCPD	31088453SH94303G	Lenovo
iWatch	iwatch 7	/	apple
airpods	airpods 3	/	apple
wireless charging load	YBZ1.1	/	YBZ
Support cable list			
Description	Length (m)	From	To
/	/	/	/

1.5 Measurement uncertainty

Measurement	Uncertainty
Conducted emissions (AMN 150kHz~30MHz)	±3.1dB
Occupied channel bandwidth	±3 %
Radiated spurious emissions (9kHz~30MHz)	±4.3dB
Radiated spurious emissions (30MHz~1GHz)	±4.7dB
Temperature	±1 °C
Humidity	± 5 %

This uncertainty represents an expanded uncertainty expressed at approximately the 95% confidence level using a coverage factor of k=2.

2 Summary of Test Result

No.	Item	Standard	Requirement	Result
1	Antenna requirement	47 CFR Part 15C	47 CFR Part 15.203	Pass
2	Conducted Emission at AC power line	47 CFR Part 15C	47 CFR Part 15.207(a)	Pass
3	20dB Occupied Bandwidth	47 CFR Part 15C	47 CFR Part 15.215(c)	Pass
4	Emissions in frequency bands (below 30MHz)	47 CFR Part 15C	47 CFR Part 15.209	Pass
5	Emissions in frequency bands (30MHz - 1GHz)	47 CFR Part 15C	47 CFR Part 15.209	Pass

3 Test Facilities and accreditations

3.1 Test laboratory

Test laboratory:	Shenzhen Microtest Co., Ltd.
Test site location:	101, No.7, Zone 2, Xinxing Industrial Park, Fuhai Avenue, Xinhe Community, Fuhai Street, Bao'an District, Shenzhen, Guangdong, China
Telephone:	(86-755)88850135
Fax:	(86-755)88850136
CNAS Registration No.:	CNAS L5868
FCC Registration No.:	448573
IC Registration No.:	21760
CABID:	CN0093

4 List of test equipment

No.	Equipment	Manufacturer	Model	Serial No.	Cal. date	Cal. Due
Conducted Emission at AC power line						
1	EMI Test Receiver	Rohde&schwarz	ESCI3	101368	2023-04-26	2024-04-25
2	Artificial mains network	Schwarzbeck	NSLK 8127	183	2023-05-05	2024-05-04
3	Artificial Mains Network	Rohde & Schwarz	ESH2-Z5	100263	2023-06-03	2024-06-02
20dB Occupied Bandwidth						
1	Wideband Radio Communication Tester	Rohde&schwarz	CMW500	149155	2023-04-26	2024-04-25
2	ESG Series Analog Ssignal Generator	Agilent	E4421B	GB40051240	2023-04-25	2024-04-24
3	PXA Signal Analyzer	Agilent	N9030A	MY51350296	2023-04-25	2024-04-24
4	Synthesized Sweeper	Agilent	83752A	3610A01957	2023-04-25	2024-04-24
5	MXA Signal Analyzer	Agilent	N9020A	MY50143483	2023-04-26	2024-04-25
6	RF Control Unit	Tonscend	JS0806-1	19D8060152	2023-04-26	2024-04-25
7	Band Reject Filter Group	Tonscend	JS0806-F	19D8060160	2023-05-05	2024-05-04
8	ESG Vector Signal Generator	Agilent	N5182A	MY50143762	2023-04-25	2024-04-24
9	DC Power Supply	Agilent	E3632A	MY40027695	2023-05-05	2024-05-04
Emissions in frequency bands (below 30MHz)						
1	EMI Test Receiver	Rohde&schwarz	ESCI7	101166	2023-04-26	2024-04-25
2	Active Loop Antenna	Schwarzbeck	FMZB 1519 B	00066	2023-06-11	2025-06-10
3	Amplifier	Hewlett-Packard	8447F	3113A06184	2023-06-26	2024-06-25
Emissions in frequency bands (30MHz - 1GHz)						
1	EMI Test Receiver	Rohde&schwarz	ESCI7	101166	2023-04-26	2024-04-25
2	TRILOG Broadband Antenna	schwarabeck	VULB 9163	9163-1338	2023-06-11	2025-06-10
3	Active Loop Antenna	Schwarzbeck	FMZB 1519 B	00066	2023-06-11	2025-06-10
4	Amplifier	Hewlett-Packard	8447F	3113A06184	2023-06-26	2024-06-25
5	Multi-device Controller	TuoPu	TPMDC	/	2023-05-04	2024-05-03

5 Evaluation Results (Evaluation)

5.1 Antenna requirement

Test Requirement:	Refer to 47 CFR Part 15.203, an intentional radiator shall be designed to ensure that no antenna other than that furnished by the responsible party shall be used with the device. The use of a permanently attached antenna or of an antenna that uses a unique coupling to the intentional radiator shall be considered sufficient to comply with the provisions of this section.
-------------------	---

5.1.1 Conclusion:

The antenna of the EUT is permanently attached. The EUT complies with the requirement of FCC PART 15.203.
--

6 Radio Spectrum Matter Test Results (RF)

6.1 Conducted Emission at AC power line

Test Requirement:	Except as shown in paragraphs (b) and (c) of this section, for an intentional radiator that is designed to be connected to the public utility (AC) power line, the radio frequency voltage that is conducted back onto the AC power line on any frequency or frequencies, within the band 150 kHz to 30 MHz, shall not exceed the limits in the following table, as measured using a 50 µH/50 ohms line impedance stabilization network (LISN).		
Test Limit:	Frequency of emission (MHz)	Conducted limit (dBµV)	
		Quasi-peak	Average
	0.15-0.5	66 to 56*	56 to 46*
	0.5-5	56	46
	5-30	60	50
	*Decreases with the logarithm of the frequency.		
Test Method:	ANSI C63.10-2013 section 6.2		
Procedure:	Refer to ANSI C63.10-2013 section 6.2, standard test method for ac power-line conducted emissions from unlicensed wireless devices		

6.1.1 E.U.T. Operation:

Operating Environment:					
Temperature:	25.3 °C	Humidity:	51 %	Atmospheric Pressure:	101 kPa
Pre test mode:	Mode1, Mode2, Mode3, Mode4, Mode5, Mode6, Mode7, Mode8, Mode9, Mode10, Mode11, Mode12, Mode13, Mode14, Mode15, Mode16, Mode17, Mode18, Mode19, Mode20				
Final test mode:	All of the listed pre-test mode were tested, only the data of the worst mode (Mode1) is recorded in the report				

6.1.2 Test Setup Diagram:

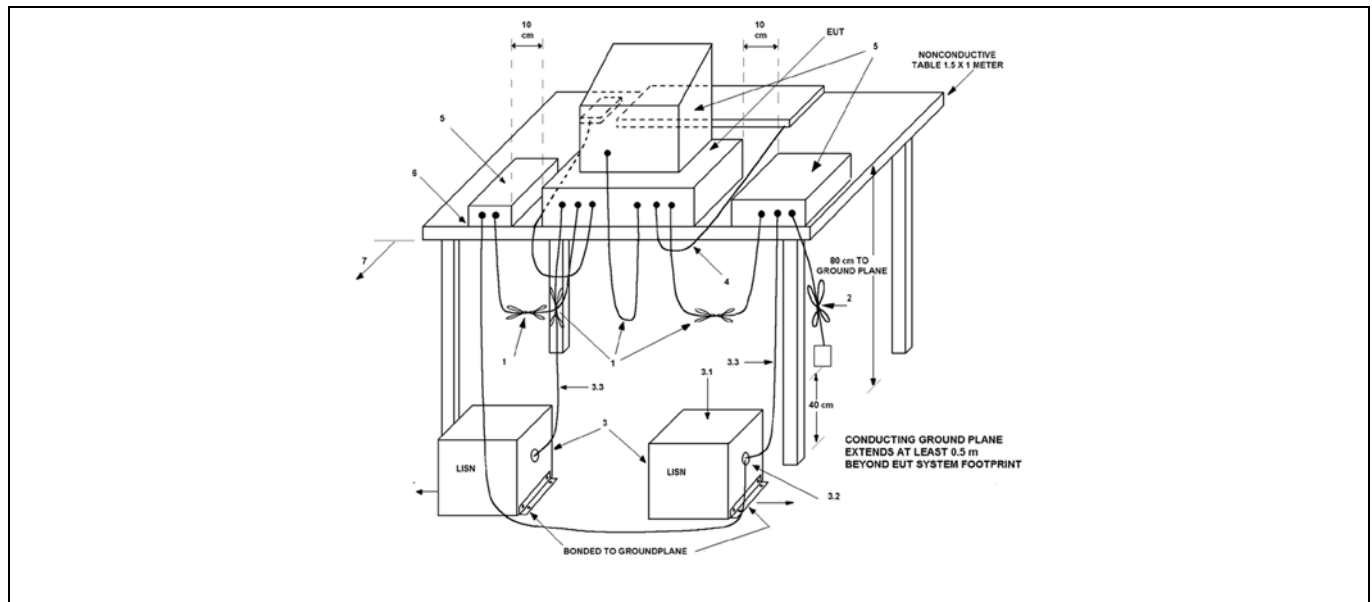

6.1.3 Test Data:

Mode1 / Line: Line

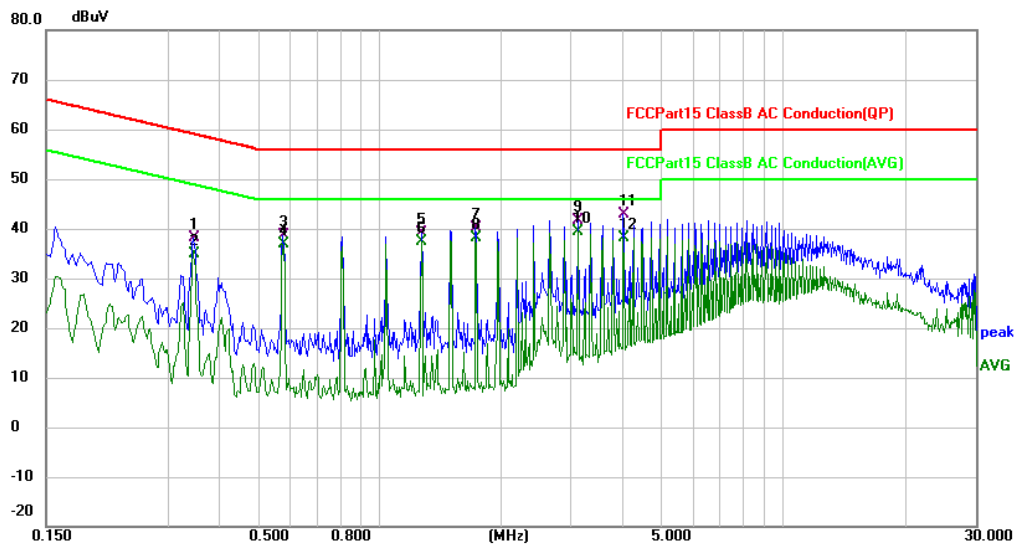

No.	Mk.	Freq.	Reading	Correct	Measure-	Limit	Over		
		MHz	Level	Factor	ment			Detector	Comment
			dBuV	dB	dBuV	dBuV	dB		
1		0.3460	27.23	10.94	38.17	59.06	-20.89	QP	
2		0.3460	23.98	10.94	34.92	49.06	-14.14	AVG	
3		0.5780	27.04	11.51	38.55	56.00	-17.45	QP	
4		0.5780	25.48	11.51	36.99	46.00	-9.01	AVG	
5		1.2740	26.22	12.91	39.13	56.00	-16.87	QP	
6		1.2740	24.43	12.91	37.34	46.00	-8.66	AVG	
7		1.7340	26.18	13.89	40.07	56.00	-15.93	QP	
8		1.7340	24.13	13.89	38.02	46.00	-7.98	AVG	
9		3.1220	31.38	10.29	41.67	56.00	-14.33	QP	
10	*	3.1220	29.16	10.29	39.45	46.00	-6.55	AVG	
11		4.0459	32.62	10.29	42.91	56.00	-13.09	QP	
12		4.0459	27.91	10.29	38.20	46.00	-7.80	AVG	

Mode1 / Line: Neutral

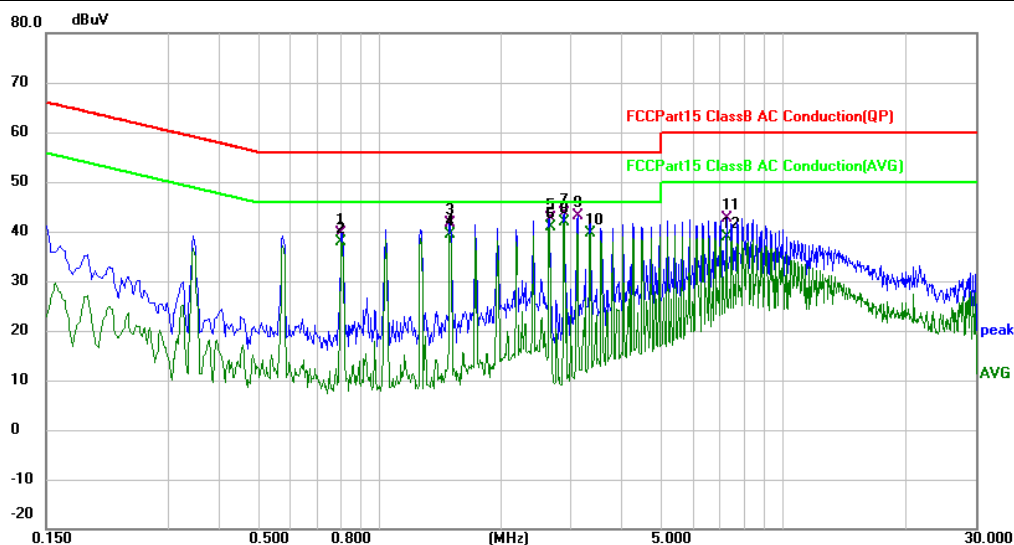

No.	Mk.	Freq.	Reading Level	Correct Factor	Measurement	Limit	Over	Detector	Comment
		MHz	dBuV	dB	dBuV	dBuV	dB		
1		0.8059	27.75	12.00	39.75	56.00	-16.25	QP	
2		0.8059	25.80	12.00	37.80	46.00	-8.20	AVG	
3		1.4940	28.51	13.19	41.70	56.00	-14.30	QP	
4		1.4940	26.24	13.19	39.43	46.00	-6.57	AVG	
5		2.6580	32.47	10.18	42.65	56.00	-13.35	QP	
6		2.6580	30.58	10.18	40.76	46.00	-5.24	AVG	
7		2.8900	33.35	10.25	43.60	56.00	-12.40	QP	
8	*	2.8900	31.51	10.25	41.76	46.00	-4.24	AVG	
9		3.1180	32.91	10.27	43.18	56.00	-12.82	QP	
10		3.3500	29.42	10.27	39.69	46.00	-6.31	AVG	
11		7.2819	32.24	10.29	42.53	60.00	-17.47	QP	
12		7.2819	28.65	10.29	38.94	50.00	-11.06	AVG	

6.2 20dB Occupied Bandwidth

Test Requirement:	47 CFR Part 15.215(c)
Test Limit:	Refer to 47 CFR 15.215(c), intentional radiators operating under the alternative provisions to the general emission limits, as contained in §§ 15.217 through 15.257 and in subpart E of this part, must be designed to ensure that the 20 dB bandwidth of the emission, or whatever bandwidth may otherwise be specified in the specific rule section under which the equipment operates, is contained within the frequency band designated in the rule section under which the equipment is operated.
Test Method:	ANSI C63.10-2013, section 6.9.2
Procedure:	<p>a) The spectrum analyzer center frequency is set to the nominal EUT channel center frequency. The span range for the EMI receiver or spectrum analyzer shall be between two times and five times the OBW.</p> <p>b) The nominal IF filter bandwidth (3 dB RBW) shall be in the range of 1% to 5% of the OBW and video bandwidth (VBW) shall be approximately three times RBW, unless otherwise specified by the applicable requirement.</p> <p>c) Set the reference level of the instrument as required, keeping the signal from exceeding the maximum input mixer level for linear operation. In general, the peak of the spectral envelope shall be more than $[10 \log (OBW/RBW)]$ below the reference level. Specific guidance is given in 4.1.5.2.</p> <p>d) Steps a) through c) might require iteration to adjust within the specified tolerances.</p> <p>e) The dynamic range of the instrument at the selected RBW shall be more than 10 dB below the target “-xx dB down” requirement; that is, if the requirement calls for measuring the -20 dB OBW, the instrument noise floor at the selected RBW shall be at least 30 dB below the reference value.</p> <p>f) Set detection mode to peak and trace mode to max hold.</p> <p>g) Determine the reference value: Set the EUT to transmit an unmodulated carrier or modulated signal, as applicable. Allow the trace to stabilize. Set the spectrum analyzer marker to the highest level of the displayed trace (this is the reference value).</p> <p>h) Determine the “-xx dB down amplitude” using $[(\text{reference value}) - xx]$. Alternatively, this calculation may be made by using the marker-delta function of the instrument.</p> <p>i) If the reference value is determined by an unmodulated carrier, then turn the EUT modulation ON, and either clear the existing trace or start a new trace on the spectrum analyzer and allow the new trace to stabilize. Otherwise, the trace from step g) shall be used for step j).</p> <p>j) Place two markers, one at the lowest frequency and the other at the highest frequency of the envelope of the spectral display, such that each marker is at or slightly below the “-xx dB down amplitude” determined in step h). If a marker is below this “-xx dB down amplitude” value, then it shall be as close as possible to this value. The occupied bandwidth is the frequency difference between the two markers. Alternatively, set a marker at the lowest frequency of the envelope of the spectral display, such that the marker is at or slightly below the “-xx dB down amplitude” determined in step h). Reset the marker-delta function and move the marker to the other side of the emission until the delta marker amplitude is at the same level as the reference marker amplitude. The marker-delta frequency reading at this point is the specified emission bandwidth.</p> <p>k) The occupied bandwidth shall be reported by providing plot(s) of the measuring instrument display; the plot axes and the scale units per division shall be clearly labeled. Tabular data may be reported in addition to the plot(s).</p>

6.2.1 E.U.T. Operation:

Operating Environment:					
Temperature:	25 °C	Humidity:	59 %	Atmospheric Pressure:	99 kPa
Pre test mode:	Mode1, Mode2, Mode3, Mode4, Mode5, Mode6, Mode7, Mode8, Mode9, Mode10, Mode11, Mode12, Mode13, Mode14, Mode15, Mode16, Mode17, Mode18, Mode19, Mode20				
Final test mode:	All of the listed pre-test mode were tested, only the data of the worst mode (Mode17, Mode18, Mode19) is recorded in the report				

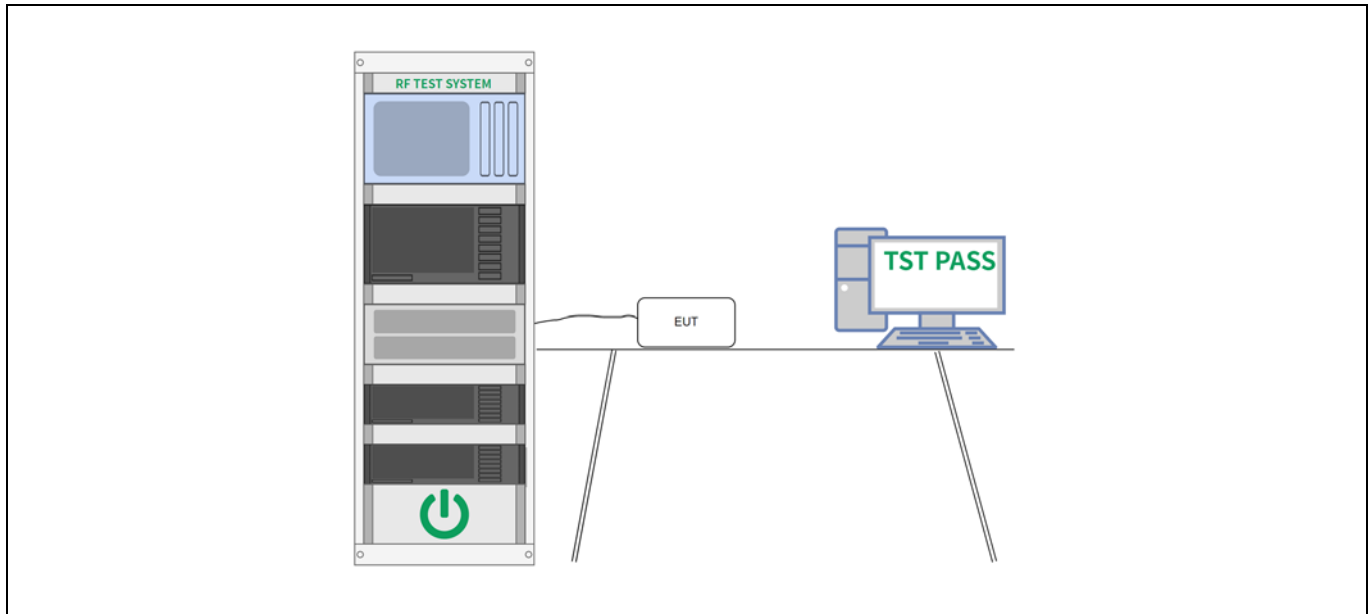
6.2.2 Test Setup Diagram:

6.2.3 Test Data:

Note: Because the measured signal is CW-like, adjusting the RBW per C63.10 would not be practical since measurement bandwidth will always follow the RBW. The RBW is set to 300 Hz to perform the occupied bandwidth test.

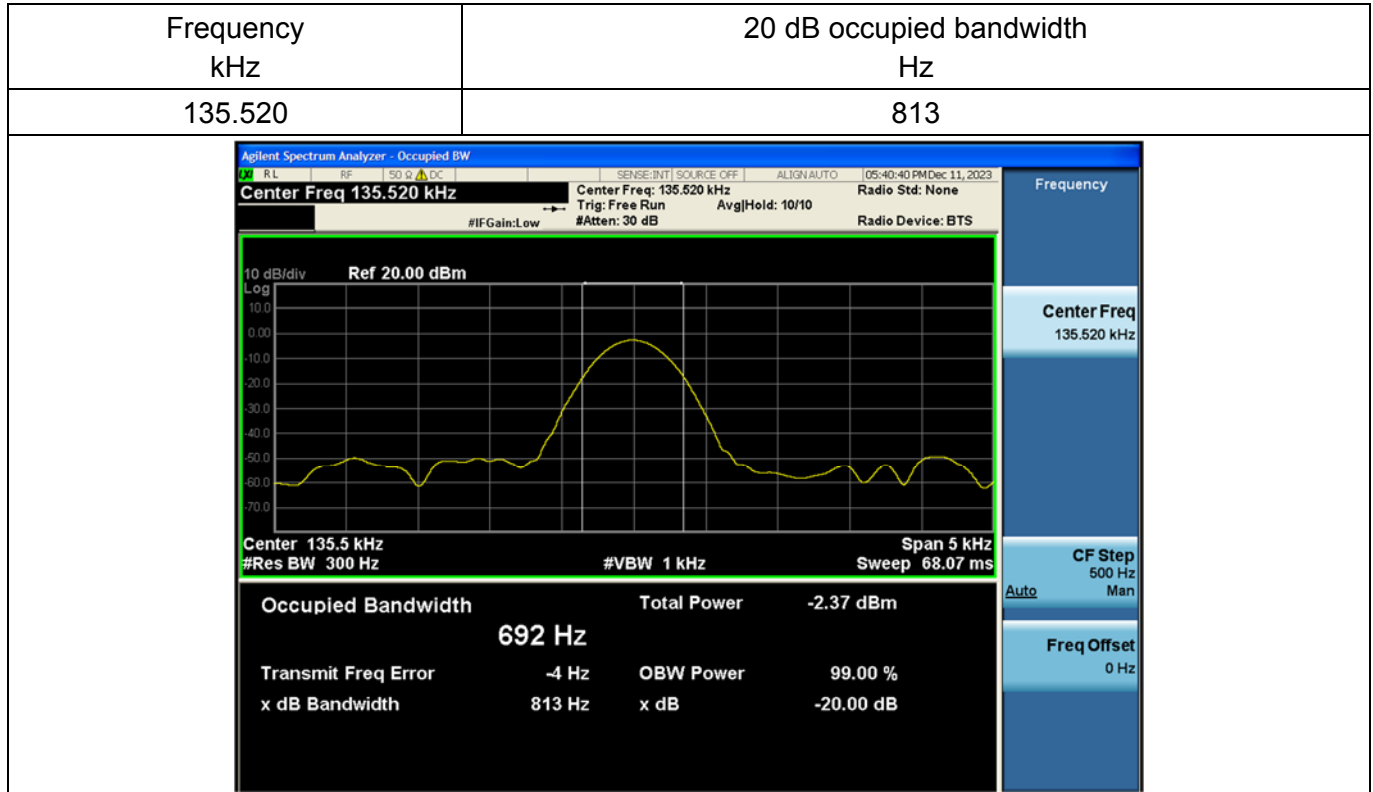
Transmitter1(Phone):

Note: Because the measured signal is CW-like, adjusting the RBW per C63.10 would not be practical since measurement bandwidth will always follow the RBW. The RBW is set to 300 Hz to perform the occupied bandwidth test.

Transmitter2(Wireless Earbuds):

Frequency kHz	20 dB occupied bandwidth Hz
136.340	815

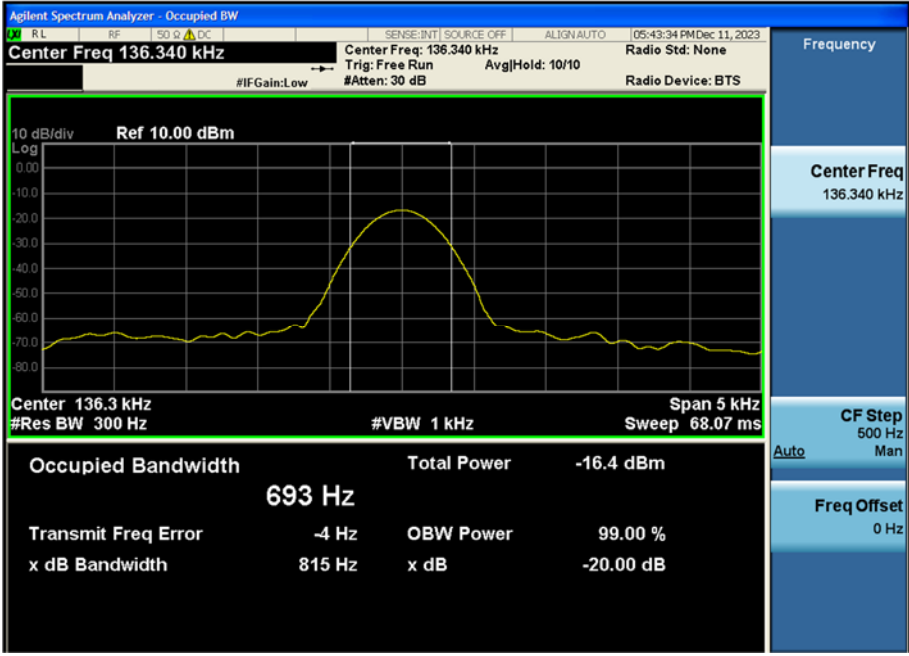

The screenshot displays the following data from the Agilent Spectrum Analyzer:

- Center Freq:** 136.340 kHz
- Ref:** 10.00 dBm
- Occupied Bandwidth:** 693 Hz
- Total Power:** -16.4 dBm
- Transmit Freq Error:** -4 Hz
- OBW Power:** 99.00 %
- x dB Bandwidth:** 815 Hz
- x dB:** -20.00 dB

Note: Because the measured signal is CW-like, adjusting the RBW per C63.10 would not be practical since measurement bandwidth will always follow the RBW. The RBW is set to 300 Hz to perform the occupied bandwidth test.

Transmitter3(Wireless Earbuds):

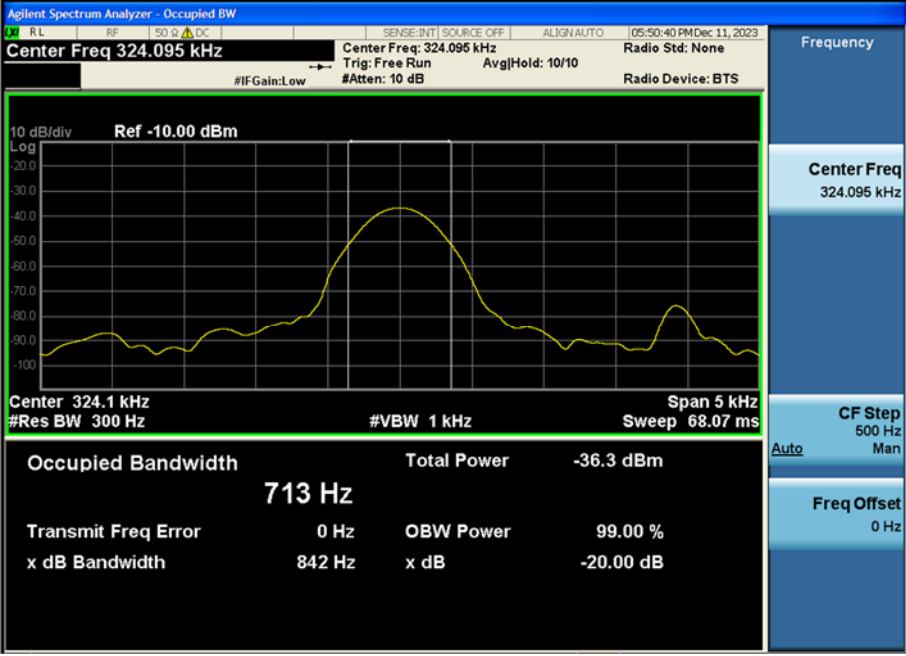
Frequency kHz	20 dB occupied bandwidth Hz
324.095	842
	

6.3 Emissions in frequency bands (below 30MHz)

Test Requirement:	47 CFR Part 15.209		
Test Limit:	Frequency (MHz)	Field strength (microvolts/meter)	Measurement distance (meters)
	0.009-0.490	2400/F(kHz)	300
	0.490-1.705	24000/F(kHz)	30
	1.705-30.0	30	30
	30-88	100 **	3
	88-216	150 **	3
	216-960	200 **	3
	Above 960	500	3
<p>** Except as provided in paragraph (g), fundamental emissions from intentional radiators operating under this section shall not be located in the frequency bands 54-72 MHz, 76-88 MHz, 174-216 MHz or 470-806 MHz. However, operation within these frequency bands is permitted under other sections of this part, e.g., §§ 15.231 and 15.241.</p> <p>In the emission table above, the tighter limit applies at the band edges. The emission limits shown in the above table are based on measurements employing a CISPR quasi-peak detector except for the frequency bands 9–90 kHz, 110–490 kHz and above 1000 MHz. Radiated emission limits in these three bands are based on measurements employing an average detector. As shown in § 15.35(b), for frequencies above 1000 MHz, the field strength limits in paragraphs (a) and (b) of this section are based on average limits. However, the peak field strength of any emission shall not exceed the maximum permitted average limits specified above by more than 20 dB under any condition of modulation. For point-to-point operation under paragraph (b) of this section, the peak field strength shall not exceed 2500 millivolts/meter at 3 meters along the antenna azimuth.</p>			
Test Method:	ANSI C63.10-2013 section 6.4		
Procedure:	ANSI C63.10-2013 section 6.4		

6.3.1 E.U.T. Operation:

Operating Environment:					
Temperature:	22.5 °C	Humidity:	43 %	Atmospheric Pressure:	101 kPa
Pre test mode:	Mode1, Mode2, Mode3, Mode4, Mode5, Mode6, Mode7, Mode8, Mode9, Mode10, Mode11, Mode12, Mode13, Mode14, Mode15, Mode16, Mode17, Mode18, Mode19, Mode20				
Final test mode:	All of the listed pre-test mode were tested, only the data of the worst mode (Mode4) is recorded in the report				

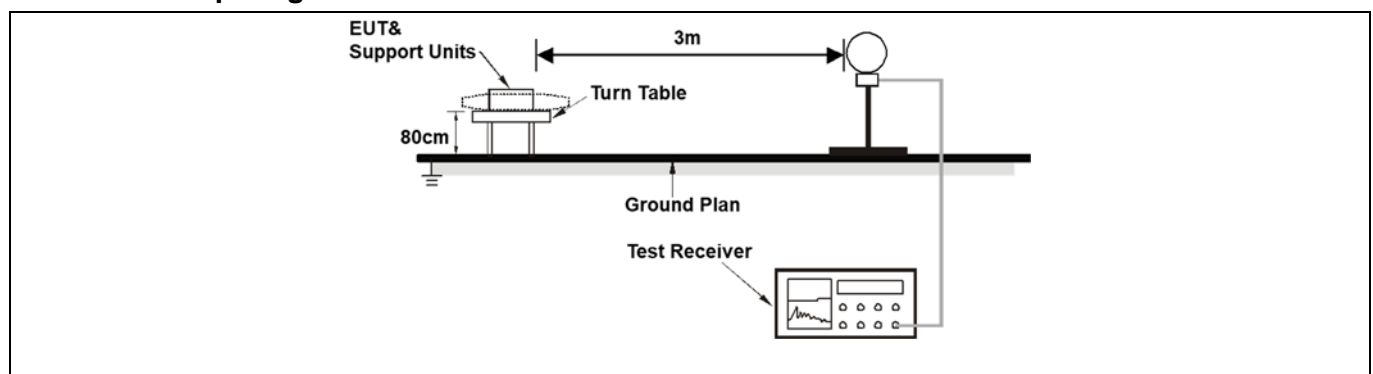
6.3.2 Test Setup Diagram:

6.3.3 Test Data:

Mode4 / Polarization: coplanar

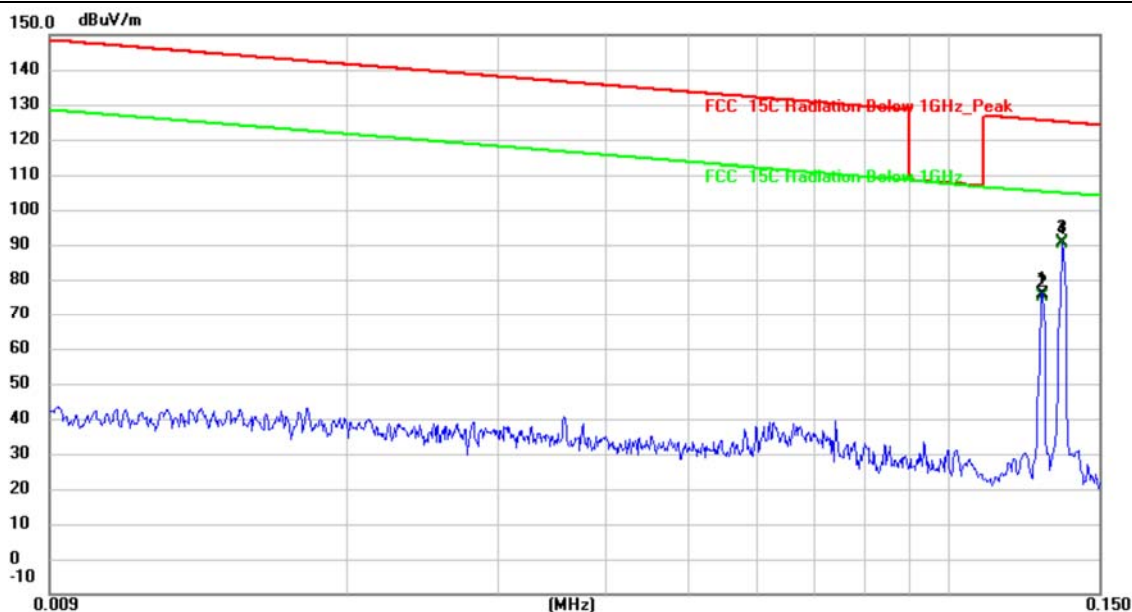

No.	Mk.	Freq.	Reading Level	Correct Factor	Measurement	Limit	Over	Detector
		MHz	dBuV	dB	dBuV/m	dBuV/m	dB	
1		0.1285	55.74	19.91	75.65	125.45	-49.80	peak
2		0.1285	54.98	19.91	74.89	105.45	-30.56	AVG
3		0.1356	70.84	19.95	90.79	124.98	-34.19	peak
4	*	0.1356	70.17	19.95	90.12	104.98	-14.86	AVG

Mode4 / Polarization: coplanar

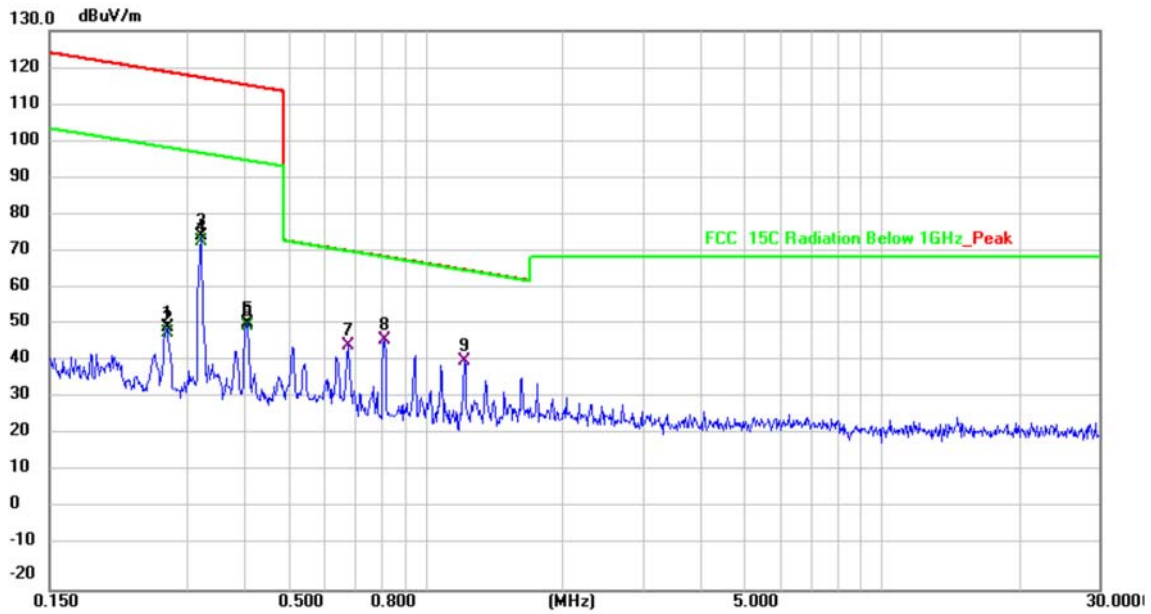

No.	Mk.	Freq. MHz	Reading Level dBuV	Correct Factor dB	Measure- ment dBuV/m	Limit dBuV/m	Over dB	Detector
1		0.2715	30.24	20.03	50.27	118.94	-68.67	peak
2		0.2715	28.60	20.03	48.63	98.94	-50.31	AVG
3		0.3240	54.92	19.97	74.89	117.42	-42.53	peak
4		0.3240	53.62	19.97	73.59	97.42	-23.83	AVG
5		0.4061	31.49	19.88	51.37	115.43	-64.06	peak
6		0.4061	30.95	19.88	50.83	95.43	-44.60	AVG
7		0.6790	25.79	19.73	45.52	70.97	-25.45	QP
8	*	0.8130	27.11	19.71	46.82	69.41	-22.59	QP
9		1.2161	21.50	19.69	41.19	65.93	-24.74	QP

6.4 Emissions in frequency bands (30MHz - 1GHz)

Test Requirement:	47 CFR Part 15.209		
Test Limit:	Frequency (MHz)	Field strength (microvolts/meter)	Measurement distance (meters)
	0.009-0.490	2400/F(kHz)	300
	0.490-1.705	24000/F(kHz)	30
	1.705-30.0	30	30
	30-88	100 **	3
	88-216	150 **	3
	216-960	200 **	3
	Above 960	500	3
<p>** Except as provided in paragraph (g), fundamental emissions from intentional radiators operating under this section shall not be located in the frequency bands 54-72 MHz, 76-88 MHz, 174-216 MHz or 470-806 MHz. However, operation within these frequency bands is permitted under other sections of this part, e.g., §§ 15.231 and 15.241.</p> <p>In the emission table above, the tighter limit applies at the band edges. The emission limits shown in the above table are based on measurements employing a CISPR quasi-peak detector except for the frequency bands 9–90 kHz, 110–490 kHz and above 1000 MHz. Radiated emission limits in these three bands are based on measurements employing an average detector. As shown in § 15.35(b), for frequencies above 1000 MHz, the field strength limits in paragraphs (a) and (b) of this section are based on average limits. However, the peak field strength of any emission shall not exceed the maximum permitted average limits specified above by more than 20 dB under any condition of modulation. For point-to-point operation under paragraph (b) of this section, the peak field strength shall not exceed 2500 millivolts/meter at 3 meters along the antenna azimuth.</p>			
Test Method:	ANSI C63.10-2013 section 6.5		
Procedure:	ANSI C63.10-2013 section 6.5		

6.4.1 E.U.T. Operation:

Operating Environment:					
Temperature:	22.5 °C	Humidity:	43 %	Atmospheric Pressure:	101 kPa
Pre test mode:	Mode1, Mode2, Mode3, Mode4, Mode5, Mode6, Mode7, Mode8, Mode9, Mode10, Mode11, Mode12, Mode13, Mode14, Mode15, Mode16, Mode17, Mode18, Mode19, Mode20				
Final test mode:	All of the listed pre-test mode were tested, only the data of the worst mode (Mode4) is recorded in the report				

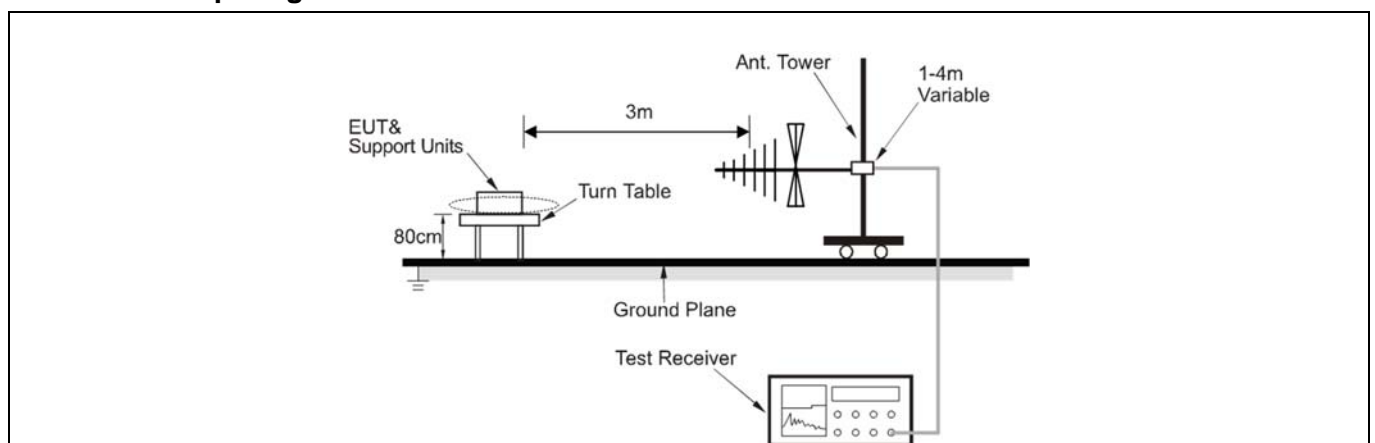
6.4.2 Test Setup Diagram:

6.4.3 Test Data:

Mode4 / Polarization: Horizontal

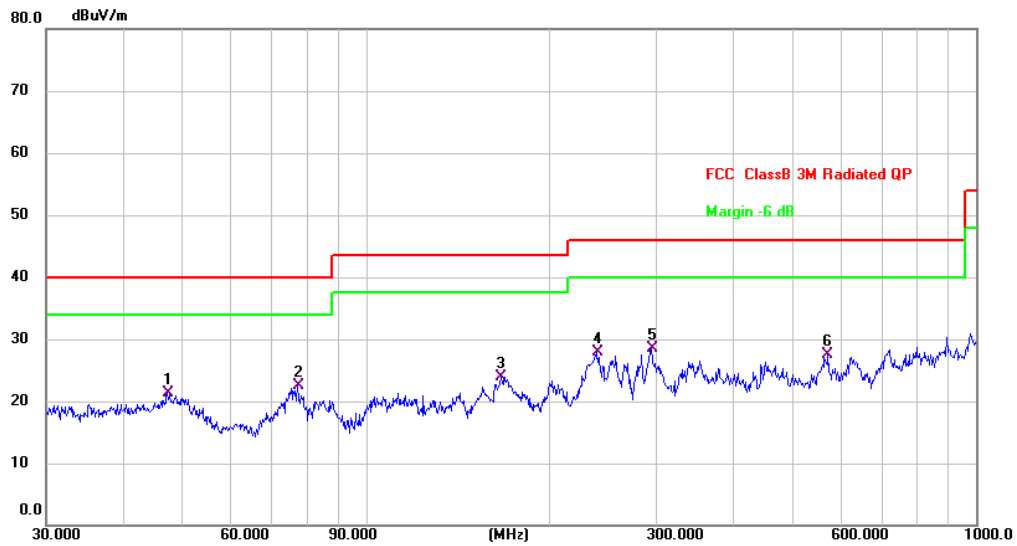

No.	Mk.	Freq. MHz	Reading Level dBuV	Correct Factor dB	Measure- ment dBuV/m	Limit dBuV/m	Over dB	Detector	Comment
1		47.3255	28.68	-7.45	21.23	40.00	-18.77	QP	
2		77.3212	35.34	-12.89	22.45	40.00	-17.55	QP	
3		166.0680	34.90	-11.02	23.88	43.50	-19.62	QP	
4		239.9874	34.80	-6.89	27.91	46.00	-18.09	QP	
5	*	294.1137	33.50	-5.02	28.48	46.00	-17.52	QP	
6		572.6144	29.83	-2.28	27.55	46.00	-18.45	QP	

Mode4 / Polarization: Vertical

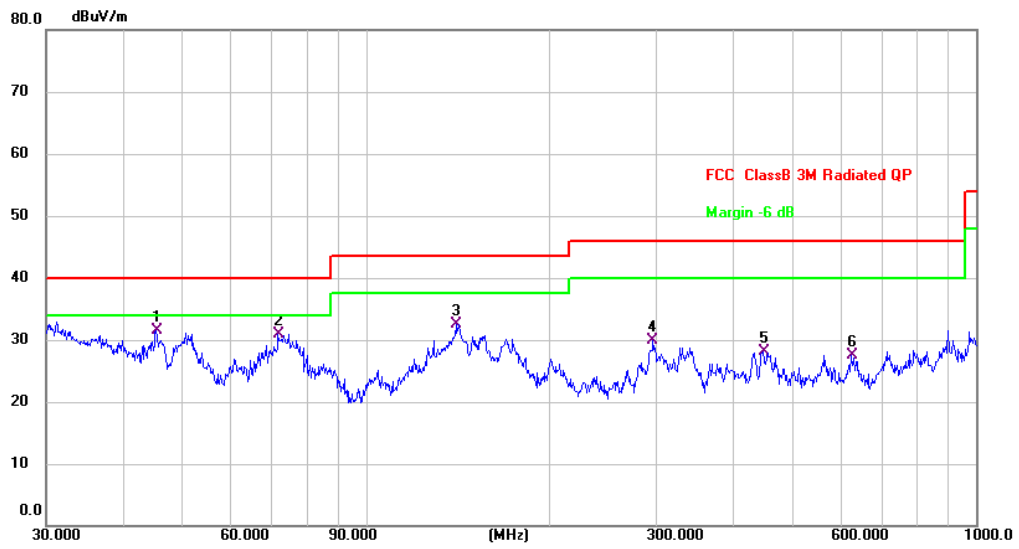

No.	Mk.	Freq.	Reading Level	Correct Factor	Measurement	Limit	Over	Detector	Comment
		MHz	dBuV	dB	dBuV/m	dBuV/m	dB		
1	*	45.3755	38.78	-7.35	31.43	40.00	-8.57	QP	
2		71.8320	42.24	-11.26	30.98	40.00	-9.02	QP	
3		140.3421	42.29	-9.76	32.53	43.50	-10.97	QP	
4		296.1836	34.91	-4.91	30.00	46.00	-16.00	QP	
5		447.9822	32.32	-4.19	28.13	46.00	-17.87	QP	
6		625.0780	27.48	-0.05	27.43	46.00	-18.57	QP	

Photographs of the test setup

Refer to Appendix - Test Setup Photos

Photographs of the EUT

Refer to Appendix - EUT Photos

----End of Report----