

**CFR 47 FCC PART 15 SUBPART E
ISED RSS-248 ISSUE 2**

TEST REPORT

For

AXE5400 Whole Home Mesh Wi-Fi 6E System

MODEL NUMBER: Deco XE75 Pro

REPORT NUMBER: 4790853841-1-RF-3

ISSUE DATE: August 10, 2023

FCC ID: 2AXJ4XE75V3

IC: 26583-XE75V3

Prepared for

TP-Link Corporation Limited

**Room 901, 9/F. , New East Ocean Centre, 9 Science Museum Road, Tsim Sha Tsui,
Kowloon, Hong Kong**

Prepared by

UL Verification Services (Guangzhou) Co., Ltd, Song Shan Lake Branch

**Building 10, Innovation Technology Park, No. 1, Li Bin Road, Song Shan Lake Hi-
Tech Development Zone Dongguan, 523808, People's Republic of China**

Tel: +86 769 22038881

Fax: +86 769 33244054

Website: www.ul.com

Revision History

Rev.	Issue Date	Revisions	Revised By
V0	August 10, 2023	Initial Issue	

Summary of Test Results

Test Item	Clause	Limit/Requirement	Result
On Time And Duty Cycle	ANSI C63.10-2013, Clause 12.2	None; for reporting purposes only.	Pass
26dB Emission Bandwidth And 99% Occupied Bandwidth	KDB 789033 D02 v02r01 Section C.1	FCC Part 15.407 (a) (10) RSS-248 Issue 2, Clause 4.4 RSS-Gen Clause 6.7	Pass
Conducted Output Power	KDB 789033 D02 v02r01 Section E.3.a (Method PM)	FCC 15.407 (a) RSS-248 Issue 2, Clause 4.5	Pass
Power Spectral Density	KDB 789033 D02 v02r01 Section F	FCC 15.407 (a) RSS-248 Issue 2, Clause 4.5	Pass
In-Band Emissions (Mask)	KDB 987594 D02 U-NII 6GHz EMC Measurement v01r01 J	FCC 15.407 (b) RSS-248 Issue 2, Clause 4.6	Pass
Frequency Stability	ANSI C63.10-2013, Clause 6.8.	FCC 15.407 (g)	Pass
Contention-based Protocol	KDB 987594 D02 U-NII 6GHz EMC Measurement v01r01 I	FCC 15.407 (d) (6) RSS-248 Issue 2, Clause 4.7	Pass
Radiated Emissions And Band Edge Measurement	KDB 789033 D02 v02r01 Section G.3, G.4, G.5, and G.6	FCC 15.407 (b) FCC 15.209 FCC 15.205 RSS-248 Issue 2, Clause 4.6 RSS-GEN Clause 8.9	Pass
AC Power Line Conducted Emission	ANSI C63.10-2013, Clause 6.2.	FCC 15.207 RSS-GEN Clause 8.8	Pass
Antenna Requirement	N/A	FCC 47 CFR Part 15.203/ 15.407(a)(1) (2), RSS-Gen Issue 5, Clause 6.8	Pass

*This test report is only published to and used by the applicant, and it is not for evidence purpose in China.

*The measurement result for the sample received is <Pass> according to <CFR 47 FCC PART 15 SUBPART E ISED RSS-248 ISSUE 2> when <Accuracy Method> decision rule is applied.

CONTENTS

1. ATTESTATION OF TEST RESULTS.....	6
2. TEST METHODOLOGY.....	7
3. FACILITIES AND ACCREDITATION.....	7
4. CALIBRATION AND UNCERTAINTY	8
4.1. <i>MEASURING INSTRUMENT CALIBRATION</i>	<i>8</i>
4.2. <i>MEASUREMENT UNCERTAINTY.....</i>	<i>8</i>
5. EQUIPMENT UNDER TEST	9
5.1. <i>DESCRIPTION OF EUT</i>	<i>9</i>
5.2. <i>CHANNEL LIST</i>	<i>10</i>
5.3. <i>MAXIMUM EIRP</i>	<i>14</i>
5.4. <i>TEST CHANNEL CONFIGURATION.....</i>	<i>15</i>
5.5. <i>THE WORSE CASE POWER SETTING PARAMETER.....</i>	<i>16</i>
5.6. <i>WORSE CASE CONFIGURATIONS.....</i>	<i>19</i>
5.7. <i>DESCRIPTION OF AVAILABLE ANTENNAS</i>	<i>20</i>
5.8. <i>SUPPORT UNITS FOR SYSTEM TEST</i>	<i>21</i>
6. MEASURING EQUIPMENT AND SOFTWARE USED.....	22
7. ANTENNA PORT TEST RESULTS	25
7.1. <i>ON TIME AND DUTY CYCLE.....</i>	<i>25</i>
7.2. <i>26DB EMISSION BANDWIDTH AND 99% OCCUPIED BANDWIDTH.....</i>	<i>26</i>
7.3. <i>CONDUCTED OUTPUT POWER</i>	<i>28</i>
7.4. <i>POWER SPECTRAL DENSITY</i>	<i>31</i>
7.5. <i>IN-BAND EMISSIONS (MASK).....</i>	<i>34</i>
7.6. <i>FREQUENCY STABILITY.....</i>	<i>36</i>
7.7. <i>CONTENTION-BASED PROTOCOL</i>	<i>38</i>
8. RADIATED TEST RESULTS.....	42
8.1. <i>RESTRICTED BANDEDGE</i>	<i>50</i>
8.2. <i>SPURIOUS EMISSIONS(1 GHZ~9 GHZ)</i>	<i>68</i>
8.3. <i>SPURIOUS EMISSIONS(9 GHZ~18 GHZ)</i>	<i>94</i>
8.4. <i>SPURIOUS EMISSIONS(9 KHZ~30 MHZ)</i>	<i>172</i>
8.5. <i>SPURIOUS EMISSIONS(18 GHZ~26 GHZ)</i>	<i>175</i>
8.6. <i>SPURIOUS EMISSIONS(26 GHZ~40 GHZ)</i>	<i>177</i>
8.7. <i>SPURIOUS EMISSIONS(30 MHZ~1 GHZ).....</i>	<i>179</i>

8.8.	<i>SIMULTANEOUSLY TRANSMISSION SPURIOUS EMISSIONS</i>	181
9.	AC POWER LINE CONDUCTED EMISSION	185
10.	ANTENNA REQUIREMENT	189
11.	TEST DATA	190
11.1.	<i>APPENDIX A: EMISSION BANDWIDTH</i>	190
11.1.1.	Test Result.....	190
11.1.2.	Test Graphs	191
11.2.	<i>APPENDIX B: OCCUPIED CHANNEL BANDWIDTH</i>	218
11.2.1.	Test Result.....	218
11.2.2.	Test Graphs	220
11.3.	<i>APPENDIX C: DUTY CYCLE</i>	246
11.3.1.	Test Result.....	246
11.3.2.	Test Graphs	247
11.4.	<i>APPENDIX D: MAXIMUM CONDUCTED OUTPUT POWER</i>	249
11.4.1.	NSS=2 Test Result	249
11.4.2.	NSS=1 Test Result	252
11.5.	<i>APPENDIX E: MAXIMUM POWER SPECTRAL DENSITY</i>	256
11.5.1.	NSS=2 Test Result	256
11.5.2.	NSS=2 Test Graphs.....	259
11.5.3.	NSS=1 Test Result	285
11.5.4.	NSS=1 Test Graphs.....	288
11.6.	<i>APPENDIX F: INBAND EMISSIONS</i>	314
11.6.1.	Test Result.....	314
11.6.2.	Test Graphs	315
11.7.	<i>APPENDIX G: CONTENTION BASED PROTOCOL</i>	328
11.7.1.	Test Result for Master.....	328
11.7.2.	Test Graphs for Master	333
11.7.3.	Test Result for Mesh	349
11.7.1.	Test Graphs for Mesh	354
11.8.	<i>APPENDIX H: FREQUENCY STABILITY</i>	369
11.8.1.	Test Result.....	369

1. ATTESTATION OF TEST RESULTS

Applicant Information

Company Name: TP-Link Corporation Limited
 Address: Room 901, 9/F. , New East Ocean Centre, 9 Science Museum Road, Tsim Sha Tsui, Kowloon, Hong Kong

Manufacturer Information

Company Name: TP-Link Corporation Limited
 Address: Room 901, 9/F. , New East Ocean Centre, 9 Science Museum Road, Tsim Sha Tsui, Kowloon, Hong Kong

EUT Information

EUT Name: AXE5400 Whole Home Mesh Wi-Fi 6E System
 Model: Deco XE75 Pro
 Brand: tp-link
 Sample Received Date: May 15, 2023
 Sample Status: Normal
 Sample ID: 6093289
 Date of Tested: May 26, 2023 to August 10, 2023

APPLICABLE STANDARDS	
STANDARD	TEST RESULTS
CFR 47 FCC PART 15 SUBPART E ISED RSS-248 ISSUE 2	Pass

Prepared By:

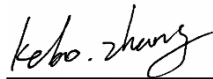

Kebo Zhang
Senior Project Engineer

Checked By:

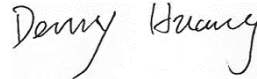

Denny Huang
Senior Project Engineer

Approved By:



Stephen Guo
Operations Manager

2. TEST METHODOLOGY

All tests were performed in accordance with the standard CFR 47 FCC PART 15 SUBPART E ISED RSS-248 ISSUE 2, ANSI C63.10-2013, CFR 47 FCC Part 2, CFR 47 FCC Part 15, KDB 789033 D02 v02r01, RSS-GEN Issue 5, RSS-248 Issue 2, KDB414788 D01 Radiated Test Site v01r01, KDB 662911 D01 Multiple Transmitter Output v02r01, KDB987594 D01 U-NII 6GHz General Requirements v01r02, KDB987594 D02 U-NII 6 GHz EMC Measurement v01v01.

3. FACILITIES AND ACCREDITATION

Accreditation Certificate	<p>A2LA (Certificate No.: 4102.01) UL Verification Services (Guangzhou) Co., Ltd. Song Shan Lake Branch. has been assessed and proved to be in compliance with A2LA.</p> <p>FCC (FCC Designation No.: CN1187) UL Verification Services (Guangzhou) Co., Ltd. Song Shan Lake Branch. Has been recognized to perform compliance testing on equipment subject to the Commission's Declaration of Conformity (DoC) and Certification rules</p> <p>ISED (Company No.: 21320) UL Verification Services (Guangzhou) Co., Ltd. Song Shan Lake Branch. has been registered and fully described in a report filed with ISED. The Company Number is 21320 and the test lab Conformity Assessment Body Identifier (CABID) is CN0046.</p> <p>VCCI (Registration No.: G-20019, R-20004, C-20012 and T-20011) UL Verification Services (Guangzhou) Co., Ltd. Song Shan Lake Branch. has been assessed and proved to be in compliance with VCCI, the Membership No. is 3793. Facility Name: Chamber D, the VCCI registration No. is G-20019 and R-20004 Shielding Room B , the VCCI registration No. is C-20012 and T-20011</p>
---------------------------	--

Note 1:

All tests measurement facilities use to collect the measurement data are located at Building 10, Innovation Technology Park, No. 1, Li Bin Road, Song Shan Lake Hi-Tech Development Zone Dongguan, 523808, People's Republic of China.

Note 2:

The test anechoic chamber in UL Verification Services (Guangzhou) Co., Ltd. Song Shan Lake Branch had been calibrated and compared to the open field sites and the test anechoic chamber is shown to be equivalent to or worst case from the open field site.

Note 3:

For below 30 MHz, lab had performed measurements at test anechoic chamber and comparing to measurements obtained on an open field site. And these measurements below 30 MHz had been correlated to measurements performed on an OFS.

4. CALIBRATION AND UNCERTAINTY

4.1. MEASURING INSTRUMENT CALIBRATION

The measuring equipment utilized to perform the tests documented in this report has been calibrated in accordance with the manufacturer's recommendations and is traceable to recognized national standards.

4.2. MEASUREMENT UNCERTAINTY

Where relevant, the following measurement uncertainty levels have been estimated for tests performed on the apparatus:

Test Item	Uncertainty
Conduction emission	3.62 dB
Radiated Emission (Included Fundamental Emission) (9 kHz ~ 30 MHz)	2.2 dB
Radiated Emission (Included Fundamental Emission) (30 MHz ~ 1 GHz)	4.00 dB
Radiated Emission (Included Fundamental Emission) (1 GHz to 40 GHz)	5.78 dB (1 GHz ~ 18 GHz)
	5.23 dB (18 GHz ~ 26 GHz)
	5.37 dB (26 GHz ~ 40 GHz)
Duty Cycle	±0.028%
Emission Bandwidth and 99% Occupied Bandwidth	±0.0196%
Maximum Conducted Output Power	±0.766 dB
Maximum Power Spectral Density Level	±1.22 dB
Frequency Stability	±2.76%
Conducted Band-edge Compliance	±1.328 dB
Conducted Unwanted Emissions In Non-restricted Frequency Bands	±0.746 dB (9 kHz ~ 1 GHz)
	±1.328dB (1 GHz ~ 26 GHz)
Note: This uncertainty represents an expanded uncertainty expressed at approximately the 95% confidence level using a coverage factor of k=2.	

5. EQUIPMENT UNDER TEST

5.1. DESCRIPTION OF EUT

EUT Name/PMN:	AXE5400 Whole Home Mesh Wi-Fi 6E System
Model:	Deco XE75 Pro
HVIN:	Deco XE75V3
Radio Technology:	IEEE802.11ax HE20/ax HE40/ax HE80/ax HE160
Operation Frequency:	UNII-5 Band: 6115 MHz ~ 6425 MHz UNII-6 Band: 6425 MHz ~ 6525 MHz UNII-7 Band: 6525 MHz ~ 6875 MHz UNII-8 Band: 6875 MHz ~ 7125 MHz
Operational mode:	Master & Mesh
Type of Modulation:	IEEE 802.11ax: OFDMA (BPSK, QPSK, 16QAM, 64QAM, 256QAM, 1024QAM)
Normal Test Voltage:	DC 12 V via adapter

5.2. CHANNEL LIST

UNII-5 (For Bandwidth=20MHz)					
Channel	Frequency (MHz)	Channel	Frequency (MHz)	Channel	Frequency (MHz)
/	/	33	6115	65	6275
/	/	37	6135	69	6295
/	/	41	6155	73	6315
/	/	45	6175	77	6335
/	/	49	6195	81	6355
/	/	53	6215	85	6375
/	/	57	6235	89	6395
/	/	61	6255	93	6415

UNII-6 (For Bandwidth=20 MHz)					
Channel	Frequency (MHz)	Channel	Frequency (MHz)	Channel	Frequency (MHz)
97	6435	105	6475	113	6515
101	6455	109	6495	/	/

UNII-7 (For Bandwidth=20 MHz)					
Channel	Frequency (MHz)	Channel	Frequency (MHz)	Channel	Frequency (MHz)
117	6535	141	6655	165	6775
121	6555	145	6675	169	6795
125	6575	149	6695	173	6815
129	6595	153	6715	177	6835
133	6615	157	6735	181	6855
137	6635	161	6755	185	6875

UNII-8 (For Bandwidth=20 MHz)					
Channel	Frequency (MHz)	Channel	Frequency (MHz)	Channel	Frequency (MHz)
189	6895	205	6975	221	7055
193	6915	209	6995	225	7075
197	6935	213	7015	229	7095
201	6955	217	7035	/	/

UNII-5 (For Bandwidth=40MHz)					
Channel	Frequency (MHz)	Channel	Frequency (MHz)	Channel	Frequency (MHz)
/	/	35	6125	67	6285
/	/	43	6165	75	6325
/	/	51	6205	83	6365
/	/	59	6245	91	6405

UNII-6 (For Bandwidth=40 MHz)					
Channel	Frequency (MHz)	Channel	Frequency (MHz)	Channel	Frequency (MHz)
99	6445	107	6485	/	/

UNII-7 (For Bandwidth=40 MHz)					
Channel	Frequency (MHz)	Channel	Frequency (MHz)	Channel	Frequency (MHz)
115	6525	139	6645	163	6765
123	6605	147	6685	171	6805
131	6645	155	6725	179	6845

UNII-8 (For Bandwidth=40 MHz)					
Channel	Frequency (MHz)	Channel	Frequency (MHz)	Channel	Frequency (MHz)
187	6885	203	6965	219	7045
195	6925	211	7005	227	7085

UNII-5 (For Bandwidth=80MHz)					
Channel	Frequency (MHz)	Channel	Frequency (MHz)	Channel	Frequency (MHz)
/	/	39	6145	71	6305
/	/	55	6225	87	6385

UNII-6 (For Bandwidth=80 MHz)					
Channel	Frequency (MHz)	Channel	Frequency (MHz)	Channel	Frequency (MHz)
103	6465	/	/	/	/

UNII-7 (For Bandwidth=80 MHz)					
Channel	Frequency (MHz)	Channel	Frequency (MHz)	Channel	Frequency (MHz)
119	6545	151	6705	183	6865
135	6625	167	6785	/	/

UNII-8 (For Bandwidth=80 MHz)					
Channel	Frequency (MHz)	Channel	Frequency (MHz)	Channel	Frequency (MHz)
199	6945	215	7025	/	/

UNII-5 (For Bandwidth=160 MHz)					
Channel	Frequency (MHz)	Channel	Frequency (MHz)	Channel	Frequency (MHz)
/	/	47	6185	79	6345

UNII-6 (For Bandwidth=160 MHz)					
Channel	Frequency (MHz)	Channel	Frequency (MHz)	Channel	Frequency (MHz)
111	6505	/	/	/	/

UNII-7 (For Bandwidth=160 MHz)					
Channel	Frequency (MHz)	Channel	Frequency (MHz)	Channel	Frequency (MHz)
143	6665	175	6825	/	/

UNII-8 (For Bandwidth=160 MHz)					
Channel	Frequency (MHz)	Channel	Frequency (MHz)	Channel	Frequency (MHz)
207	6985	/	/	/	/

5.3. MAXIMUM EIRP

IEEE Std. 802.11	Frequency (MHz)	Maximum Average Conducted Power (dBm)	Maximum Average EIRP (dBm)
ax HE20	6115 ~ 7095	15.83	16.83
ax HE40		18.84	19.84
ax HE80		21.97	22.97
ax HE160		24.61	25.61

5.4. TEST CHANNEL CONFIGURATION

UNII-5 Test Channel Configuration		
IEEE Std.	Test Channel Number	Frequency
802.11ax HE20	CH 33(Low Channel), CH 65(MID Channel), CH 93(High Channel)	6115 MHz, 6275 MHz, 6415 MHz
802.11ax HE40	CH 35(Low Channel), CH 67(MID Channel), CH 91(High Channel)	6125 MHz, 6285 MHz, 6405 MHz
802.11ax HE80	CH 39(Low Channel), CH 55(MID Channel), CH 87(High Channel)	6145 MHz, 6225 MHz, 6385 MHz
802.11ax HE160	CH 47(Low Channel), CH 79(High Channel)	6185 MHz, 6345 MHz

UNII-6 Test Channel Configuration		
IEEE Std.	Test Channel Number	Frequency
802.11ax HE20	CH 97(Low Channel), CH 105(MID Channel), CH 113(High Channel)	6435 MHz, 6475 MHz, 6515 MHz
802.11ax HE40	CH 99(Low Channel), CH 107(High Channel)	6445 MHz, 6485 MHz
802.11ax HE80	CH 103(Low Channel)	6465 MHz
802.11ax HE160	CH 111(Low Channel)	6505 MHz

UNII-7 Test Channel Configuration		
IEEE Std.	Test Channel Number	Frequency
802.11ax HE20	CH 117(Low Channel), CH 153(MID Channel), CH 185(High Channel)	6535 MHz, 6715 MHz, 6875 MHz
802.11ax HE40	CH 115(Low Channel), CH 155(MID Channel), CH 179(High Channel)	6525 MHz, 6725 MHz, 6845 MHz
802.11ax HE80	CH 119(Low Channel), CH 151(MID Channel), CH 183(High Channel)	6545 MHz, 6705 MHz, 6865 MHz
802.11ax HE160	CH 143(Low Channel), CH 175(High Channel)	6665 MHz, 6825 MHz

UNII-8 Test Channel Configuration		
IEEE Std.	Test Channel Number	Frequency
802.11ax HE20	CH 185(Low Channel), CH 213(MID Channel), CH 229 (High Channel)	6895 MHz, 7015 MHz, 7095 MHz
802.11ax HE40	CH 187(Low Channel), CH 211(MID Channel), CH 227(High Channel)	6885 MHz, 7005 MHz, 7085 MHz
802.11ax HE80	CH 119(Low Channel), CH 183(High Channel)	6945 MHz, 7025 MHz
802.11ax HE160	CH 207(Low Channel)	6985 MHz

5.5. THE WORSE CASE POWER SETTING PARAMETER

The Worse Case Power Setting Parameter		
Test Software	QSPR	
NSS=1		
Mode	Frequency (MHz)	Soft set value
802.11AX 20M	6115	10.5
	6275	11
	6415	11.5
	6435	11.5
	6475	11.5
	6515	11.5
	6535	12
	6715	11
	6875	11
	6895	11
	7015	11
	7095	11
	7115	11
802.11AX 40M	6125	13
	6285	13.5
	6405	14
	6445	14
	6485	14.5
	6525	15
	6725	14
	6845	14
	6885	14
	7005	14.5
7085	14	
802.11AX 80M	6145	16.5
	6225	16
	6385	17
	6465	17.5
	6545	17
	6705	17
	6865	16.5
	6945	17.5
	7025	17.5
802.11ax 160M	6185	19
	6345	20.5

	6505	20
	6665	20
	6825	20
	6985	21
NSS=2		
Mode	Frequency (MHz)	Soft set value
802.11AX 20M	6115	13
	6275	13.5
	6415	14.5
	6435	14
	6475	14
	6515	14.5
	6535	14.5
	6715	13.5
	6875	13.5
	6895	14
	7015	14
	7095	14
	7115	14/4
802.11AX 40M	6125	16
	6285	16
	6405	17
	6445	17
	6485	17
	6525	17.5
	6725	17
	6845	17
	6885	17
	7005	17.5
	7085	16.5
802.11AX 80M	6145	20
	6225	19
	6385	20
	6465	20
	6545	20
	6705	19.5
	6865	19.5
	6945	20.5
7025	19.5	

802.11ax 160M	6185	22
	6345	22
	6505	23
	6665	23
	6825	23
	6985	23

5.6. WORSE CASE CONFIGURATIONS

The EUT was tested in the following configuration(s):

Controlled in test mode using a software application on the EUT supplied by customer. The application was used to enable a continuous transmission and to select the mode, test channels, bandwidth, data rates as required.

Test channels referring to section 5.4.

Maximum power setting referring to section 5.5.

Worst case Data Rates declared by the customer:

802.11ax HE20 CDD mode : MCS0
802.11ax HE40 CDD mode : MCS0
802.11ax HE80 CDD mode : MCS0
802.11ax HE160 CDD mode : MCS0

All modes support CDD mode.

The EUT has 4 separate antennas which correspond to 4 separate antenna ports. Core 2 and Core 4 correspond to antenna 2 and antenna 4 respectively and they support WLAN 2.4G and RLAN 5G. Core 1 and Core 3 correspond to antenna 1 and antenna 3 respectively and they support RLAN 6G.

The measured additional path loss was included in any path loss calculations for all RF cable used during tested.

Simultaneously Transmission Conditions:

Support Technology			Support (YES/NO)
WIFI (2.4G)	WIFI (5G)	WIFI (6G)	YES

Note: The emission of the simultaneous operation has been evaluated and no non-compliance was found.

5.7. DESCRIPTION OF AVAILABLE ANTENNAS

Antenna No.	Frequency Band	Antenna Type	Max Antenna Gain (dBi)
1	5925 ~ 7125	Diople Antenna	1
3	5925 ~ 7125	Diople Antenna	1

The EUT support Cyclic Shift Diversity(CDD) mode.

MIMO output power port and MIMO PSD port summing were performed in accordance with KDB 662911 D01. For the CDD results the Directional Gain was calculated in accordance with the following method.

For output power measurements:

Directional gain= $G_{ANT} + \text{Array Gain} = 1 \text{ dBi}$

G_{ANT} : equal to the gain of the antenna having the highest gain

Array Gain = 0 dB (i.e., no array gain) for $N_{ANT} \leq 4$

For power spectral density (PSD) measurements:

Directional gain= $G_{ANT} + \text{Array Gain} = 4.01 \text{ dBi}$

Array Gain = $10 \log(N_{ANT}/N_{SS}) \text{ dB}$.

N_{ANT} : number of transmit antennas

N_{SS} : number of spatial streams, The worst case directional gain will occur when $N_{SS} = 1$

IEE Std. 802.11	Transmit and Receive Mode	Description
802.11ax HE20	☒2TX, 2RX	ANT 1 and ANT 4 can be used as transmitting/receiving antenna.
802.11ax HE40	☒2TX, 2RX	ANT 1 and ANT 4 can be used as transmitting/receiving antenna.
802.11ax HE80	☒2TX, 2RX	ANT 1 and ANT 4 can be used as transmitting/receiving antenna.
802.11ax HE160	☒2TX, 2RX	ANT 1 and ANT 4 can be used as transmitting/receiving antenna.

Note: The value of the antenna gain was declared by customer.

5.8. SUPPORT UNITS FOR SYSTEM TEST

SUPPORT EQUIPMENT

Item	Equipment	Brand Name	Model Name	Remarks
1	Laptop	ThinkPad	X230i	/

I/O CABLES

Cable No	Port	Connector Type	Cable Type	Cable Length(m)	Remarks
1	LAN1	RJ45	Unshielded	1.0 m	/

ACCESSORIES

Item	Accessory	Brand Name	Model Name	Description
1	I.T.E. POWER SUPPLY	tp-link	T12020-2B4	Input: AC 100-240 V, 50 / 60 Hz, 0.8 A Output: DC 12.0 V, 2 A

TEST SETUP

The EUT can work in engineering mode with a software through a laptop.

SETUP DIAGRAM FOR TESTS

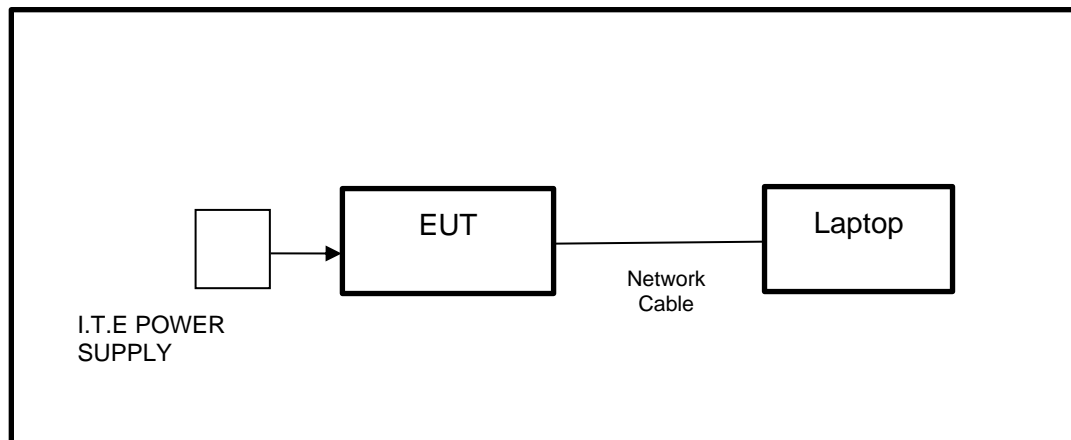

6. MEASURING EQUIPMENT AND SOFTWARE USED

R&S TS 8997 Test System					
Equipment	Manufacturer	Model No.	Serial No.	Last Cal.	Due. Date
Power sensor, Power Meter	R&S	OSP120	100921	Mar.31,2023	Mar.30,2024
Vector Signal Generator	R&S	SMBV100A	261637	Oct.17, 2022	Oct.16, 2023
Signal Generator	R&S	SMB100A	178553	Oct.17, 2022	Oct.16, 2023
Signal Analyzer	R&S	FSV40	101118	Oct.17, 2022	Oct.16, 2023
Software					
Description	Manufacturer	Name		Version	
For R&S TS 8997 Test System	Rohde & Schwarz	EMC 32		10.60.10	
Tonsend RF Test System					
Equipment	Manufacturer	Model No.	Serial No.	Last Cal.	Due. Date
Wideband Radio Communication Tester	R&S	CMW500	155523	Oct.17, 2022	Oct.16, 2023
Wireless Connectivity Tester	R&S	CMW270	1201.0002N75-102	Sep.28, 2022	Sep.27, 2023
PXA Signal Analyzer	Keysight	N9030A	MY55410512	Oct.17, 2022	Oct.16, 2023
MXG Vector Signal Generator	Keysight	N5182B	MY56200284	Oct.17, 2022	Oct.16, 2023
MXG Vector Signal Generator	Keysight	N5172B	MY56200301	Oct.17, 2022	Oct.16, 2023
DC power supply	Keysight	E3642A	MY55159130	Oct.17, 2022	Oct.16, 2023
Temperature & Humidity Chamber	SANMOOD	SG-80-CC-2	2088	Oct.17, 2022	Oct.16, 2023
Attenuator	Aglient	8495B	2814a12853	Oct.18, 2022	Oct.17, 2023
RF Control Unit	Tonscend	JS0806-2	23B80620666	April 18,2023	April 17,2024
Software					
Description	Manufacturer	Name		Version	
Tonsend SRD Test System	Tonsend	JS1120-3 RF Test System		V3.2.22	

Conducted Emissions					
Equipment	Manufacturer	Model No.	Serial No.	Last Cal.	Due Date
EMI Test Receiver	R&S	ESR3	101961	Oct.17, 2022	Oct.16, 2023
Two-Line V-Network	R&S	ENV216	101983	Oct.17, 2022	Oct.16, 2023
Artificial Mains Networks	Schwarzbeck	NSLK 8126	8126465	Oct.17, 2022	Oct.16, 2023
Software					
Description			Manufacturer	Name	Version
Test Software for Conducted Emissions			Farad	EZ-EMC	Ver. UL-3A1

Radiated Emissions					
Equipment	Manufacturer	Model No.	Serial No.	Last Cal.	Due Date
MXE EMI Receiver	KESIGHT	N9038A	MY56400036	Oct.17, 2022	Oct.16, 2023
Hybrid Log Periodic Antenna	TDK	HLP-3003C	130959	Aug.02, 2021	Aug.01, 2024
Preamplifier	HP	8447D	2944A09099	Oct.17, 2022	Oct.16, 2023
EMI Measurement Receiver	R&S	ESR26	101377	Oct.17, 2022	Oct.16, 2023
Horn Antenna	TDK	HRN-0118	130940	July 20, 2021	July 19, 2024
Preamplifier	TDK	PA-02-0118	TRS-305-00067	Oct.17, 2022	Oct.16, 2023
Horn Antenna	Schwarzbeck	BBHA9170	697	July 20, 2021	July 19, 2024
Preamplifier	TDK	PA-02-2	TRS-307-00003	Oct.17, 2022	Oct.16, 2023
Preamplifier	TDK	PA-02-3	TRS-308-00002	Oct.17, 2022	Oct.16, 2023
Loop antenna	Schwarzbeck	1519B	00008	Dec.14, 2021	Dec.13, 2024
Preamplifier	TDK	PA-02-001-3000	TRS-302-00050	Oct.17, 2022	Oct.16, 2023
Preamplifier	Mini-Circuits	ZX60-83LN-S+	SUP01202035	Oct.17, 2022	Oct.16, 2023
High Pass Filter	Wi	WHKX10-2700-3000-18000-40SS	23	Oct.17, 2022	Oct.16, 2023
Highpass Filter	Wainwright	WHKX10-5850-6500-1800-40SS	4	Oct.17, 2022	Oct.16, 2023
Band Reject Filter	Wainwright	WRCJV12-5695-5725-5850-5880-40SS	4	Oct.17, 2022	Oct.16, 2023

Band Reject Filter	Wainwright	WRCJV20-5120-5150-5350-5380-60SS	2	Oct.17, 2022	Oct.16, 2023
Band Reject Filter	Wainwright	WRCJV20-5440-5470-5725-5755-60SS	1	Oct.17, 2022	Oct.16, 2023
Band Reject Filter	Wainwright	WRCJV8-2350-2400-2483.5-2533.5-40SS	4	Oct.17, 2022	Oct.16, 2023
Band Reject Filter	Wainwright	WRCD5-1879-1879.85-1880.15-1881-40SS	1	Oct.17, 2022	Oct.16, 2023
Notch Filter	Wainwright	WHJ10-882-980-7000-40SS	1	Oct.17, 2022	Oct.16, 2023
Software					
Description			Manufacturer	Name	Version
Test Software for Radiated Emissions			Farad	EZ-EMC	Ver. UL-3A1

Other Instrument					
Equipment	Manufacturer	Model No.	Serial No.	Last Cal.	Due Date
Temperature humidity probe	OMEGA	ITHX-SD-5	18470007	Oct.22, 2022	Oct.21, 2023
Barometer	Yiyi	Baro	N/A	Oct.24, 2022	Oct.23, 2023
Attenuator	Agilent	8495B	2814a12853	Oct.18, 2022	Oct.17, 2023

7. ANTENNA PORT TEST RESULTS

7.1. ON TIME AND DUTY CYCLE

LIMITS

None; for reporting purposes only.

TEST PROCEDURE

Refer to KDB 789033 D02 General U-NII Test Procedures New Rules v02r01 section II.B.

The zero-span mode on a spectrum analyzer or EMI receiver, if the response time and spacing between bins on the sweep are sufficient to permit accurate measurements of the on and off times of the transmitted signal. Set the center frequency of the instrument to the center frequency of the transmission. Set $RBW \geq EBW$ if possible; otherwise, set RBW to the largest available value. Set $VBW \geq RBW$. Set detector = peak or average. The zero-span measurement method shall not be used unless both RBW and VBW are $> 50/T$, where T is defined in II.B.1.a), and the number of sweep points across duration T exceeds 100. (For example, if VBW and/or RBW are limited to 3 MHz, then the zero-span method of measuring duty cycle shall not be used if $T \leq 16.7$ microseconds.)

TEST SETUP

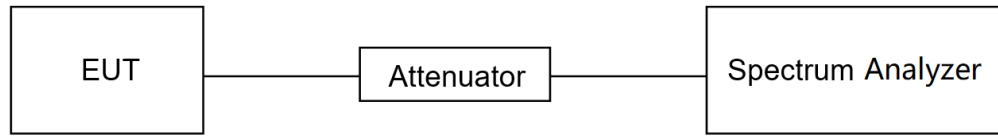

TEST ENVIRONMENT

Temperature	25.7°C	Relative Humidity	63.1%
Atmosphere Pressure	101kPa	Test Voltage	DC 12 V

TEST DATE / ENGINEER

Test Date	May 27, 2023	Test By	Johnson Liu
-----------	--------------	---------	-------------

TEST RESULTS

Please refer to section "Test Data" - Appendix C

7.2. 26DB EMISSION BANDWIDTH AND 99% OCCUPIED BANDWIDTH

LIMITS

CFR 47 FCC Part15, Subpart E		
Test Item	Limit	Frequency Range (MHz)
26 dB Emission Bandwidth	The maximum transmitter channel bandwidth for U-NII devices in the 5.925-7.125 GHz band is 320 megahertz.	5.925-7.125 GHz

ISED RSS-248 ISSUE 2		
Test Item	Limit	Frequency Range (MHz)
99 % Occupied Bandwidth	The occupied bandwidth of the device shall not exceed 320 MHz.	5.925-7.125 GHz

TEST PROCEDURE

Refer to KDB 789033 D02 General U-NII Test Procedures New Rules v02r01 section II.C1. for 26 dB Emission Bandwidth; section II.D. for 99 % Occupied Bandwidth.

Connect the EUT to the spectrum analyser and use the following settings:

Center Frequency	The center frequency of the channel under test
Detector	Peak
RBW	For 26 dB Emission bandwidth: approximately 1 % of the EBW. For 99 % Occupied Bandwidth: approximately 1 % ~ 5 % of the OBW.
VBW	For 26 dB Bandwidth: $>3 \times \text{RBW}$ For 99 % Bandwidth: $>3 \times \text{RBW}$
Trace	Max hold
Sweep	Auto couple

- a) Use the 99 % power bandwidth function of the instrument, allow the trace to stabilize and report the measured bandwidth.
- b) Allow the trace to stabilize and measure the maximum width of the emission that is constrained by the frequencies associated with the two outermost amplitude points (upper and lower frequencies) that are attenuated by 6/26 dB relative to the maximum level measured in the fundamental emission.

TEST SETUP

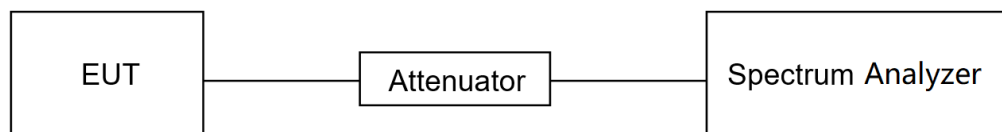

TEST ENVIRONMENT

Temperature	25.7°C	Relative Humidity	63.1%
Atmosphere Pressure	101kPa	Test Voltage	DC 12 V

TEST DATE / ENGINEER

Test Date	May 27, 2023	Test By	Johnson Liu
-----------	--------------	---------	-------------

TEST RESULTS

Please refer to section "Test Data" - Appendix A&B

7.3. CONDUCTED OUTPUT POWER

LIMITS

CFR 47 FCC Part15, Subpart E		
Test Item	Limit	Frequency Range (MHz)
Conducted Output Power	<input type="checkbox"/> Standard Power Access Point The maximum e.i.r.p. over the frequency band of operation must not exceed 36 dBm. For outdoor devices, the maximum e.i.r.p. at any elevation angle above 30 degrees as measured from the horizon must not exceed 125 mW (21 dBm).	5.925-6.425 GHz 6.525-6.875 GHz
	<input checked="" type="checkbox"/> Indoor Access Point The maximum e.i.r.p. over the frequency band of operation must not exceed 30 dBm.	5.925-7.125 GHz
	<input type="checkbox"/> Subordinate Device The maximum e.i.r.p. over the frequency band of operation must not exceed 30 dBm.	5.925-7.125 GHz
	<input type="checkbox"/> Client Devices, Operating Under The Control Of A Standard Power Access Point The maximum e.i.r.p. over the frequency band of operation must not exceed 30 dBm and the device must limit its power to no more than 6 dB below its associated standard power access point's authorized transmit power.	5.925-6.425 GHz 6.525-6.875 GHz
	<input type="checkbox"/> Client Devices, Operating Under The Control Of An Indoor Access Point The maximum e.i.r.p. over the frequency band of operation must not exceed 24 dBm.	5.925-7.125 GHz

ISED RSS-248 ISSUE 2		
Test Item	Limit	Frequency Range (MHz)
Conducted Output Power	<input type="checkbox"/> Standard Power Access Point The maximum e.i.r.p. over the 5925-6875 MHz frequency band shall not exceed 36 dBm and the maximum e.i.r.p. for a device not enclosed by walls and a ceiling, measured at any elevation angle greater than 30 degrees above the horizon, shall not exceed 21 dBm over the 5925-6875 MHz frequency band	5.925-6.425 GHz 6.525-6.875 GHz
	<input checked="" type="checkbox"/> Low-Power Indoor Access-Points The maximum e.i.r.p. over the 5925-7125 MHz frequency band shall not exceed 30 dBm	5.925-7.125 GHz
	<input type="checkbox"/> Subordinate Device The maximum e.i.r.p. over the 5925-7125 MHz frequency band shall not exceed 30 dBm	5.925-7.125 GHz
	<input type="checkbox"/> Standard Client Devices The maximum e.i.r.p. over the 5925-6875 MHz frequency band shall not exceed 30 dBm and the maximum power limits shall remain at least 6 dB below the power levels authorized for the associated standard-power access point	5.925-6.425 GHz 6.525-6.875 GHz
	<input type="checkbox"/> Low-Power Client Devices The maximum e.i.r.p. over the 5925-7125 MHz frequency band shall not exceed 24 dBm	5.925-7.125 GHz

TEST PROCEDURE

Refer to KDB 789033 D02 General U-NII Test Procedures New Rules v02r01 section II.E.

Method SA-1 (trace averaging with the EUT transmitting at full power throughout each sweep):

- (i) Set span to encompass the entire emission bandwidth (EBW) (or, alternatively, the entire 99% occupied bandwidth) of the signal.
- (ii) Set RBW = 1 MHz.
- (iii) Set VBW \geq 3 MHz.
- (iv) Number of points in sweep $\geq 2 \times$ span / RBW. (This ensures that bin-to-bin spacing is \leq RBW/2, so that narrowband signals are not lost between frequency bins.)
- (v) Sweep time = auto.
- (vi) Detector = power averaging (rms), if available. Otherwise, use sample detector mode.
- (vii) If transmit duty cycle $<$ 98 %, use a video trigger with the trigger level set to enable triggering only on full power pulses. Transmitter must operate at maximum power control level for the entire duration of every sweep. If the EUT transmits continuously (i.e., with no off intervals) or at duty cycle \geq 98 %, and if each transmission is entirely at the maximum power control level, then the trigger shall be set to "free run."

- (viii) Trace average at least 100 traces in power averaging (rms) mode.
- (ix) Compute power by integrating the spectrum across the EBW (or, alternatively, the entire 99% occupied bandwidth) of the signal using the instrument's band power measurement function with band limits set equal to the EBW (or occupied bandwidth) band edges. If the instrument does not have a band power function, sum the spectrum levels (in power units) at 1 MHz intervals extending across the EBW (or, alternatively, the entire 99% occupied bandwidth) of the spectrum.

Method PM (Measurement using an RF average power meter):

- (i) Measurements may be performed using a wideband RF power meter with a thermocouple detector or equivalent if all of the following conditions are satisfied:
 - a. The EUT is configured to transmit continuously or to transmit with a constant duty cycle.
 - b. At all times when the EUT is transmitting, it must be transmitting at its maximum power control level.
 - c. The integration period of the power meter exceeds the repetition period of the transmitted signal by at least a factor of five.
- (ii) If the transmitter does not transmit continuously, measure the duty cycle, x , of the transmitter output signal as described in II.B.
- (iii) Measure the average power of the transmitter. This measurement is an average over both the on and off periods of the transmitter.
- (iv) Adjust the measurement in dBm by adding $10 \log (1/x)$ where x is the duty cycle (e.g., $10 \log (1/0.25)$ if the duty cycle is 25 %).

Method PM-G (Measurement using a gated RF average power meter):

Measurements may be performed using a wideband gated RF power meter provided that the gate parameters are adjusted such that the power is measured only when the EUT is transmitting at its maximum power control level. Since the measurement is made only during the ON time of the transmitter, no duty cycle correction factor is required.

Straddle channel power was measured using spectrum analyzer.

TEST SETUP

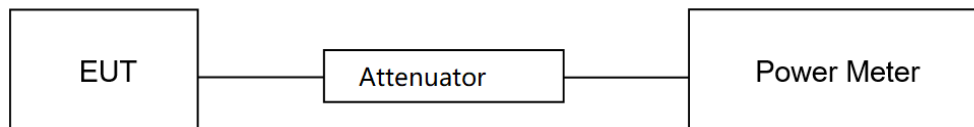

TEST ENVIRONMENT

Temperature	25.7°C	Relative Humidity	63.1%
Atmosphere Pressure	101kPa	Test Voltage	DC 12 V

TEST DATE / ENGINEER

Test Date	May 27, 2023	Test By	Johnson Liu
-----------	--------------	---------	-------------

TEST RESULTS

Please refer to section "Test Data" - Appendix D

7.4. POWER SPECTRAL DENSITY

LIMITS

CFR 47 FCC Part15, Subpart E		
Test Item	Limit	Frequency Range (MHz)
Conducted Output Power	<input type="checkbox"/> Standard Power Access Point The maximum power spectral density must not exceed 23 dBm e.i.r.p. in any 1-megahertz band.	5.925-6.425 GHz 6.525-6.875 GHz
	<input checked="" type="checkbox"/> Indoor Access Point The maximum power spectral density must not exceed 5 dBm e.i.r.p. in any 1-megahertz band.	5.925-7.125 GHz
	<input type="checkbox"/> Subordinate Device The maximum power spectral density must not exceed 5 dBm e.i.r.p. in any 1-megahertz band.	5.925-7.125 GHz
	<input type="checkbox"/> Client Devices, Operating Under The Control Of A Standard Power Access Point The maximum power spectral density must not exceed 17 dBm e.i.r.p. in any 1-megahertz band.	5.925-6.425 GHz 6.525-6.875 GHz
	<input type="checkbox"/> Client Devices, Operating Under The Control Of An Indoor Access Point The maximum power spectral density must not exceed -1 dBm e.i.r.p. in any 1-megahertz band.	5.925-7.125 GHz

ISED RSS-248 ISSUE 2		
Test Item	Limit	Frequency Range (MHz)
Conducted Output Power	<input type="checkbox"/> Standard Power Access Point The maximum e.i.r.p. spectral density shall not exceed 23 dBm/MHz	5.925-6.425 GHz 6.525-6.875 GHz
	<input checked="" type="checkbox"/> Low-Power Indoor Access-Points The maximum e.i.r.p. spectral density shall not exceed 5 dBm/MHz	5.925-7.125 GHz
	<input type="checkbox"/> Subordinate Device The maximum e.i.r.p. spectral density shall not exceed 5 dBm/MHz	5.925-7.125 GHz
	<input type="checkbox"/> Standard Client Devices The maximum e.i.r.p. spectral density shall not exceed 17 dBm/MHz	5.925-6.425 GHz 6.525-6.875 GHz
	<input type="checkbox"/> Low-Power Client Devices The maximum e.i.r.p. spectral density shall not exceed -1 dBm/MHz	5.925-7.125 GHz

TEST PROCEDURE

Refer to KDB 789033 D02 General U-NII Test Procedures New Rules v02r01 section II.F.

Connect the EUT to the spectrum analyser and use the following settings:

Center Frequency	The center frequency of the channel under test
Detector	RMS
RBW	1 MHz
VBW	$\geq 3 \times \text{RBW}$
Span	Encompass the entire emissions bandwidth (EBW) of the signal
Trace	Max hold
Sweep time	Auto

Allow trace to fully stabilize and Use the peak search function on the instrument to find the peak of the spectrum and record its value.

Add $10 \log(1/x)$, where x is the duty cycle, to the peak of the spectrum, the result is the Maximum PSD over 1 MHz reference bandwidth.

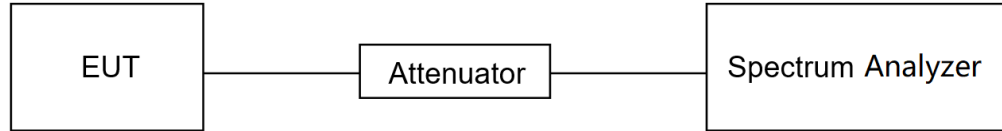
TEST SETUP**TEST ENVIRONMENT**

Temperature	25.7°C	Relative Humidity	63.1%
Atmosphere Pressure	101kPa	Test Voltage	DC 12 V

TEST DATE / ENGINEER

Test Date	May 27, 2023	Test By	Johnson Liu
-----------	--------------	---------	-------------

TEST RESULTS

Please refer to section "Test Data" - Appendix E

7.5. IN-BAND EMISSIONS (MASK)

LIMITS

Please refer to CFR 47 FCC §15.407 (b) (7) and RSS-248 Issue 2, Clause 4.2 (b)

For transmitters operating within the 5.925-7.125 GHz bands: Power spectral density must be suppressed by 20 dB at 1 MHz outside of channel edge, by 28 dB at one channel bandwidth from the channel center, and by 40 dB at one- and one-half times the channel bandwidth away from channel center. At frequencies between one megahertz outside an unlicensed device's channel edge and one channel bandwidth from the center of the channel, the limits must be linearly interpolated between 20 dB and 28 dB suppression, and at frequencies between one and one- and one-half times an unlicensed device's channel bandwidth, the limits must be linearly interpolated between 28 dB and 40 dB suppression. Emissions removed from the channel center by more than one- and one-half times the channel bandwidth must be suppressed by at least 40 dB.

TEST PROCEDURE

Refer to 987594 D02 U-NII 6GHz EMC Measurement v01r01 J.

Connect output of the antenna port to a spectrum analyzer or EMI receiver, with appropriate attenuation, as to not damage the instrumentation.

2. Set the reference level of the measuring equipment in accordance with procedure 4.1.5.2 of ANSI C63.10-2013.
3. Measure the 26 dB EBW using the test procedure 12.4.1 of ANSI C63.10-2013. (This will be used to determine the channel edge.)
4. Measure the power spectral density (which will be used for emissions mask reference) using the following procedure:
 - a) Set the span to encompass the entire 26 dB EBW of the signal.
 - b) Set RBW = same RBW used for 26 dB EBW measurement.
 - c) Set VBW $\geq 3 \times$ RBW
 - d) Number of points in sweep $\geq [2 \times \text{span} / \text{RBW}]$.
 - e) Sweep time = auto.
 - f) Detector = RMS (i.e., power averaging)
 - g) Trace average at least 100 traces in power averaging (rms) mode.
 - h) Use the peak search function on the instrument to find the peak of the spectrum.
5. For the purposes of developing the emission mask, the channel bandwidth is defined as the 26 dB EBW.
6. Using the measuring equipment limit line function, develop the emissions mask based on the following requirements. The emissions power spectral density must be reduced below the peak power spectral density (in dB) as follows:
 - a. Suppressed by 20 dB at 1 MHz outside of the channel edge. (The channel edge is defined as the 26-dB point on either side of the carrier center frequency.)
 - b. Suppressed by 28 dB at one channel bandwidth from the channel center.
 - c. Suppressed by 40 dB at one- and one-half times the channel bandwidth from the channel center.
7. Adjust the span to encompass the entire mask as necessary.
8. Clear trace.
9. Trace average at least 100 traces in power averaging (rms) mode.
10. Adjust the reference level as necessary so that the crest of the channel touches the top of the emission mask.

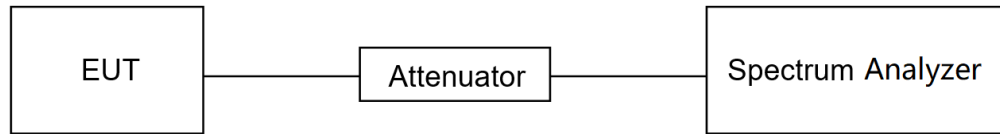
TEST SETUP**TEST ENVIRONMENT**

Temperature	25.7°C	Relative Humidity	63.1%
Atmosphere Pressure	101kPa	Test Voltage	DC 12 V

TEST DATE / ENGINEER

Test Date	May 27, 2023	Test By	Johnson Liu
-----------	--------------	---------	-------------

TEST RESULTS

Please refer to section "Test Data" - Appendix F

7.6. FREQUENCY STABILITY

LIMITS

The frequency of the carrier signal shall be maintained within band of operation.

TEST PROCEDURE

1. The EUT was placed inside an environmental chamber as the temperature in the chamber was varied between 0 °C ~ 40 °C (declared by customer).

2. The temperature was incremented by 10 °C intervals and the unit allowed to stabilize at each temperature before each measurement. The center frequency of the transmitting channel was evaluated at each temperature and the frequency deviation from the channel's center frequency was recorded.

3. The primary supply voltage is varied from 85 % to 115 % of the nominal value for non hand-carried battery and AC powered equipment. For hand-carried, battery-powered equipment, primary supply voltage is reduced to the battery operating end point which shall be specified by the manufacturer.

Connect the EUT to the spectrum analyser and use the following settings:

Center Frequency	The center frequency of the channel under test
Detector	Peak
RBW	10 kHz
VBW	$\geq 3 \times \text{RBW}$
Span	Encompass the entire emissions bandwidth (EBW) of the signal
Trace	Max hold
Sweep time	Auto

4. While maintaining a constant temperature inside the environmental chamber, turn the EUT on and record the operating frequency at startup, and at 2 minutes, 5 minutes, and 10 minutes after the EUT is energized.

5. Allow the trace to stabilize, find the peak value of the power envelope and record the frequency, then calculated the frequency drift.

TEST ENVIRONMENT

	Normal Test Conditions	Extreme Test Conditions
Relative Humidity	20 % - 75 %	/
Atmospheric Pressure	100 kPa ~102 kPa	/
Temperature	T _N (Normal Temperature): 25.1 °C	T _L (Low Temperature): 0 °C
		T _H (High Temperature): 40 °C
Supply Voltage	V _N (Normal Voltage): AC 120 V, 60 Hz	V _L (Low Voltage): AC102 V
		V _H (High Voltage): AC 138 V

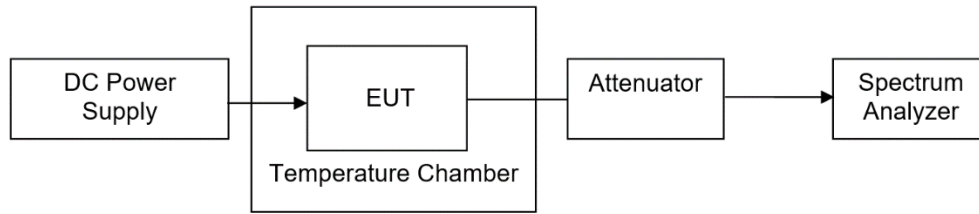
TEST SETUP

TEST ENVIRONMENT

Temperature	25.7°C	Relative Humidity	63.1%
Atmosphere Pressure	101kPa	Test Voltage	DC 12 V

TEST DATE / ENGINEER

Test Date	May 27, 2023	Test By	Johnson Liu
-----------	--------------	---------	-------------

TEST RESULTS

Please refer to section "Test Data" - Appendix H

7.7. CONTENTION-BASED PROTOCOL

LIMITS

Please refer to CFR 47 FCC §15.407 (d) (6) and RSS-248 Issue 2 Clause 4.7

Indoor access points, subordinate devices and client devices operating in the 5.925-7.125 GHz band (herein referred to as unlicensed devices) are required to use technologies that include a contention-based protocol to avoid co-channel interference with incumbent devices sharing the band. To ensure incumbent co-channel operations are detected in a technology-agnostic manner, unlicensed devices are required to detect co-channel radio frequency energy (energy detect) and avoid simultaneous transmission.

Unlicensed low-power indoor devices must detect co-channel radio frequency power that is at least -62 dBm or lower. Upon detection of energy in the band, unlicensed low power indoor devices must vacate the channel (in which incumbent signal is transmitted) and stay off the incumbent channel as long as detected radio frequency power is equal to or greater than the threshold (-62 dBm)¹. The -62 dBm (or lower) threshold is referenced to a 0 dBi antenna gain. To ensure incumbent operations are reliably detected in the band, low power indoor devices must detect RF energy throughout their intended operating channel. For example, an 802.11 device that plans to transmit a 40 MHz- wide signal (on a primary 20 MHz channel and a secondary 20 MHz channel) must detect energy throughout the entire 40 MHz channel. Additionally, low-power indoor devices must detect co-channel energy with 90% or greater certainty.

a) Simulating Incumbent Signal

The incumbent signal is assumed to be noise-like. One example of such transmission could be Digital Video Broadcasting (DVB) systems that use Orthogonal Frequency Division Multiplexing (OFDM). Incumbent systems may also use different bandwidths for their transmissions. A 10 MHz-wide additive white Gaussian noise (AWGN) signal is selected to simulate and represent incumbent transmission.

b) Required number of tests

Incumbent and EUT (access point, subordinate or client) signals may occupy different portions of the channel. Depending on the EUT transmission bandwidth and incumbent signal center frequency (simulated by a 10 MHz-wide AWGN signal), the center frequency of the EUT signal f_{cc1} may fall within the incumbent's occupied bandwidth (Figure 1.a), or outside of it (Figure 1.b).

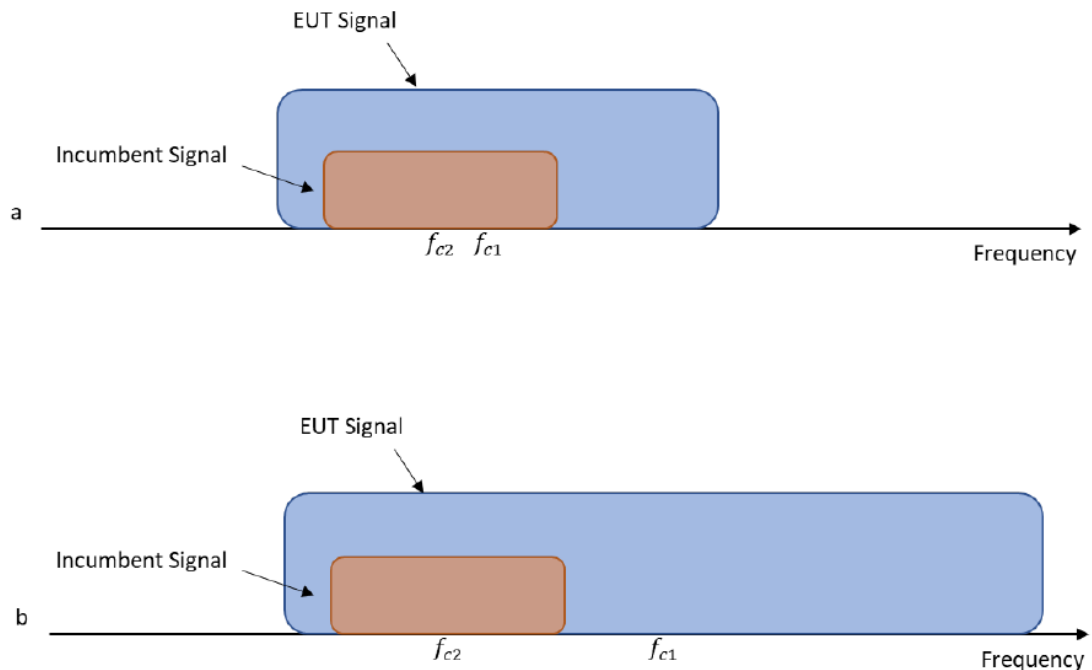

Figure 1. Two possible scenarios where a) center frequency of EUT transmission falls within incumbent's bandwidth, or b) outside of it

To ensure EUT reliably detects an incumbent signal in both scenarios shown in Figure 1, the detection threshold test may be repeated more than once with the incumbent signal (having center frequency f_{cc2}) tuned to different center frequencies within the UT transmission bandwidth. The criteria specified in Table 1 determines how many times the detection threshold test must be performed;

Table 1. Criteria to determine number of times detection threshold test may be performed

If	Number of Tests	Placement of Incumbent Transmission
$BW_{EUT} \leq BW_{Inc}$	Once	Tune incumbent and EUT transmissions ($f_{c1} = f_{c2}$)
$BW_{Inc} < BW_{EUT} \leq 2BW_{Inc}$	Once	Incumbent transmission is contained within BW_{EUT}
$2BW_{Inc} < BW_{EUT} \leq 4BW_{Inc}$	Twice. Incumbent transmission is contained within BW_{EUT}	Incumbent transmission is located as closely as possible to the lower edge and upper edge, respectively, of the EUT channel
$BW_{EUT} > 4BW_{Inc}$	Three times	Incumbent transmission is located as closely as possible to the lower edge of the EUT channel, in the middle of EUT channel, and as closely as possible to the upper edge of the EUT channel

where:

BW_{EUT} : Transmission bandwidth of EUT signal

BW_{Inc} : Transmission bandwidth of the simulated incumbent signal (10 MHz wide AWGN signal)

f_{c1} : Center frequency of EUT transmission

f_{c2} : Center frequency of simulated incumbent signal

TEST PROCEDURE

To ensure the EUT is capable of detecting co-channel energy, the first step is to configure the EUT to transmit with a constant duty cycle. To simulate an incumbent signal, a signal generator (or similar source) that is capable of generating band-limited additive white Gaussian noise (AWGN) is required. Depending on the EUT antenna configuration, the AWGN signal can be provided to the EUT receiver via a conducted method (Figure 2) or a radiated method (Figure 3). Figure 2 shows the conducted test setup where a band-limited AWGN signal is generated at a very low power level and injected into the EUT's antenna port. The AWGN signal power level is then incrementally increased while the EUT transmission is monitored on a signal analyzer 2 to verify if the EUT can sense the AWGN signal and can subsequently cease its transmission. A triggered measurement, as shown in Figure 2, is optional, and assists with determining the time it takes the EUT to cease transmission (or vacate the channel) upon detecting RF energy. If the EUT has only one antenna port, then an AWGN signal source can be connected to the same antenna port.

1. Configure the EUT to transmit with a constant duty cycle.
2. Set the operating parameters of the EUT including power level, operating frequency, modulation and bandwidth.
3. Set the signal analyzer center frequency to the nominal EUT channel center frequency. The span range of the signal analyzer shall be between two times and five times the OBW of the EUT. Connect the output port of the EUT to the signal analyzer 2, as shown in Figure 2. Ensure that the attenuator 2 provides enough attenuation to not overload the signal analyzer 2 receiver.
4. Monitoring the signal analyzer 2, verify the EUT is operating and transmitting with the parameters set at step two.
5. Using an AWGN signal source, generate (but do not transmit, i.e., RF OFF) a 10 MHz-wide AWGN signal. Use Table 1 to determine the center frequency of the 10 MHz AWGN signal relative to the EUT's channel bandwidth and center frequency.
6. Set the AWGN signal power to an extremely low level (more than 20 dB below the -62 dBm threshold). Connect the AWGN signal source, via a 3-dB splitter, to the signal analyzer 1 and the EUT as shown in Figure 2.
7. Transmit the AWGN signal (RF ON) and verify its characteristics on the signal analyzer 1.
8. Monitor the signal analyzer 2 to verify if the AWGN signal has been detected and the EUT has ceased transmission. If the EUT continues to transmit, then incrementally increase the AWGN signal power level until the EUT stops transmitting.
9. (Including all losses in the RF paths) Determine and record the AWGN signal power level (at the EUT's antenna port) at which the EUT ceased transmission. Repeat the procedure at least 10 times to verify the EUT can detect an AWGN signal with 90% (or better) level of certainty.
10. Refer to Table 1 to determine number of times the detection threshold testing needs to be repeated. If testing is required more than once, then go back to step 5, choose a different center frequency for the AWGN signal and repeat the process.

TEST SETUP

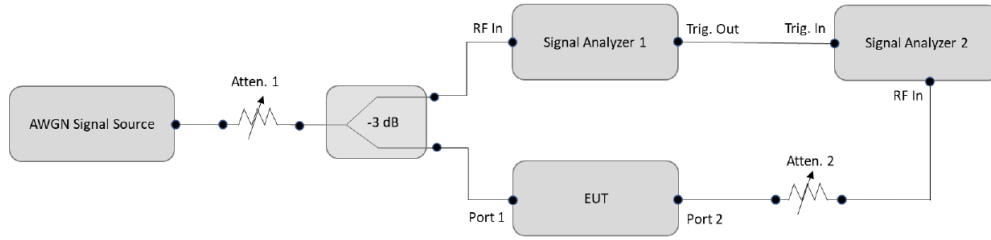

TEST ENVIRONMENT

Temperature	25.7°C	Relative Humidity	63.1%
Atmosphere Pressure	101kPa	Test Voltage	DC 12 V

TEST DATE / ENGINEER

Test Date	June 13, 2023	Test By	Johnson Liu
-----------	---------------	---------	-------------

TEST RESULTS

Please refer to section "Test Data" - Appendix G

8. RADIATED TEST RESULTS

LIMITS

Refer to CFR 47 FCC §15.205, §15.209 and §15.407 (b) (6).

Refer to ISED RSS-GEN Clause 8.9, Clause 8.10 and ISED RSS-248 4.6.

Radiation Disturbance Test Limit for FCC (Class B) (9 kHz ~ 1 GHz)

Emissions radiated outside of the specified frequency bands above 30 MHz			
Frequency Range (MHz)	Field Strength Limit (uV/m) at 3 m	Field Strength Limit (dBuV/m) at 3 m	
		Quasi-Peak	
30 - 88	100	40	
88 - 216	150	43.5	
216 - 960	200	46	
Above 960	500	54	
Above 1000	500	Peak	Average
		74	54

FCC Emissions radiated outside of the specified frequency bands below 30 MHz		
Frequency (MHz)	Field strength (microvolts/meter)	Measurement distance (meters)
0.009-0.490	2400/F(kHz)	300
0.490-1.705	24000/F(kHz)	30
1.705-30.0	30	30

ISED General field strength limits at frequencies below 30 MHz

Table 6 – General field strength limits at frequencies below 30 MHz		
Frequency	Magnetic field strength (H-Field) (µA/m)	Measurement distance (m)
9 - 490 kHz ^{Note 1}	6.37/F (F in kHz)	300
490 - 1705 kHz	63.7/F (F in kHz)	30
1.705 - 30 MHz	0.08	30

Note 1: The emission limits for the ranges 9-90 kHz and 110-490 kHz are based on measurements employing a linear average detector.

ISED Restricted bands refer to ISED RSS-GEN Clause 8.10

Table 7 – Restricted frequency bands ^{Note 1}		
MHz	MHz	GHz
0.090 - 0.110	149.9 - 150.05	9.0 - 9.2
0.495 - 0.505	156.52475 - 156.52525	9.3 - 9.5
2.1735 - 2.1905	156.7 - 156.9	10.8 - 12.7
3.020 - 3.028	162.0125 - 167.17	13.25 - 13.4
4.125 - 4.128	167.72 - 173.2	14.47 - 14.5
4.17725 - 4.17775	240 - 285	15.35 - 16.2
4.20725 - 4.20775	322 - 335.4	17.7 - 21.4
5.677 - 5.683	399.9 - 410	22.01 - 23.12
6.215 - 6.218	608 - 614	23.6 - 24.0
6.26775 - 6.26825	960 - 1427	31.2 - 31.8
6.31175 - 6.31225	1435 - 1626.5	36.43 - 36.5
8.291 - 8.294	1645.5 - 1646.5	Above 38.6
8.362 - 8.366	1660 - 1710	
8.37625 - 8.38675	1718.8 - 1722.2	
8.41425 - 8.41475	2200 - 2300	
12.29 - 12.293	2310 - 2390	
12.51975 - 12.52025	2483.5 - 2500	
12.57675 - 12.57725	2655 - 2900	
13.36 - 13.41	3260 - 3267	
16.42 - 16.423	3332 - 3339	
16.69475 - 16.69525	3345.8 - 3358	
16.80425 - 16.80475	3500 - 4400	
25.5 - 25.67	4500 - 5150	
37.5 - 38.25	5350 - 5480	
73 - 74.6	7250 - 7750	
74.8 - 75.2	8025 - 8500	
108 - 138		

Note 1: Certain frequency bands listed in table 7 and in bands above 38.6 GHz are designated for licence-exempt applications. These frequency bands and the requirements that apply to related devices are set out in the 200 and 300 series of RSSs.

FCC Restricted bands of operation refer to FCC §15.205 (a):

MHz	MHz	MHz	GHz
0.090-0.110	16.42-16.423	399.9-410	4.5-5.15
¹ 0.495-0.505	16.69475-16.69525	608-614	5.35-5.46
2.1735-2.1905	16.80425-16.80475	960-1240	7.25-7.75
4.125-4.128	25.5-25.67	1300-1427	8.025-8.5
4.17725-4.17775	37.5-38.25	1435-1626.5	9.0-9.2
4.20725-4.20775	73-74.6	1645.5-1646.5	9.3-9.5
6.215-6.218	74.8-75.2	1660-1710	10.6-12.7
6.26775-6.26825	108-121.94	1718.8-1722.2	13.25-13.4
6.31175-6.31225	123-138	2200-2300	14.47-14.5
8.291-8.294	149.9-150.05	2310-2390	15.35-16.2
8.362-8.366	156.52475-156.52525	2483.5-2500	17.7-21.4
8.37625-8.38675	156.7-156.9	2690-2900	22.01-23.12
8.41425-8.41475	162.0125-167.17	3260-3267	23.6-24.0
12.29-12.293	167.72-173.2	3332-3339	31.2-31.8
12.51975-12.52025	240-285	3345.8-3358	36.43-36.5
12.57675-12.57725	322-335.4	3600-4400	(²)
13.36-13.41			

Note: ¹Until February 1, 1999, this restricted band shall be 0.490-0.510 MHz.

²Above 38.6c

Limits of unwanted/undesirable emission out of the restricted bands refer to CFR 47 FCC §15.407 (b) (6) and ISED RSS-247 4.6.

For transmitters operating within the 5.925-7.125 GHz band: Any emissions outside of the 5.925-7.125 GHz band must not exceed an e.i.r.p. of -27 dBm/MHz.

TEST PROCEDURE

Below 30 MHz

The setting of the spectrum analyzer

RBW	200 Hz (From 9 kHz to 0.15 MHz)/ 9 kHz (From 0.15 MHz to 30 MHz)
VBW	200 Hz (From 9 kHz to 0.15 MHz)/ 9 kHz (From 0.15 MHz to 30 MHz)
Sweep	Auto

1. The testing follows the guidelines in ANSI C63.10-2013 clause 6.4.
2. The EUT was arranged to its worst case and then turntable (from 0 degree to 360 degrees) to find the maximum reading. A pre-amp and a high pass filter are used for the test in order to get better signal level. Both Horizontal, Face-on and Face-off polarizations of the antenna are set to make the measurement.
3. The EUT was placed on a turntable with 80 cm above ground.
4. The EUT was set 3 meters from the interference receiving antenna, which was mounted on the top of a 1 m height antenna tower.
5. The radiated emission limits are based on measurements employing a CISPR quasi-peak detector except for the frequency bands 9-90 kHz, 110-490 kHz and above 1000 MHz Radiated emission limits in these three bands are based on measurements employing an average detector.
6. For measurement below 1 GHz, the initial step in collecting conducted emission data is a spectrum analyzer peak detector mode pre-scanning the measurement frequency range. Significant peaks are then marked and then Quasi Peak and average detector mode re-measured. If the emission level of the EUT measured by the peak detector is 3 dB lower than the applicable limit, the peak emission level will be reported. Otherwise, the emission measurement will be repeated using the quasi-peak and average detector and reported.
7. Although these tests were performed other than open field site, adequate comparison measurements were confirmed against 30m open field site. Therefore sufficient tests were made to demonstrate that the alternative site produces results that correlate with the ones of tests made in an open field site based on KDB 414788.
8. The limits in CFR 47, Part 15, Subpart C, paragraph 15.209 (a), are identical to those in RSS-GEN Section 8.9, Table 6, since the measurements are performed in terms of magnetic field strength and converted to electric field strength levels (as reported in the table) using the free space impedance of 377Ω . For example, the measurement frequency X KHz resulted in a level of Y dBuV/m, which is equivalent to $Y-51.5 = Z$ dBuA/m, which has the same margin, W dB, to the corresponding RSS-GEN Table 6 limit as it has to be 15.209(a) limit.

Below 1 GHz and above 30 MHz

The setting of the spectrum analyzer

RBW	120 kHz
VBW	300 kHz
Sweep	Auto
Detector	Peak/QP
Trace	Max hold

1. The testing follows the guidelines in ANSI C63.10-2013 clause 6.5.
2. The EUT was arranged to its worst case and then tune the antenna tower (from 1 m to 4 m) and turntable (from 0 degree to 360 degrees) to find the maximum reading. A pre-amp and a high pass filter are used for the test in order to get better signal level. Both horizontal and vertical polarizations of the antenna are set to make the measurement.
3. The EUT was placed on a turntable with 80 cm above ground.
4. The EUT was set 3 meters from the interference receiving antenna, which was mounted on the top of a variable height antenna tower.
5. For measurement below 1 GHz, the initial step in collecting conducted emission data is a spectrum analyzer peak detector mode pre-scanning the measurement frequency range. Significant peaks are then marked and then Quasi Peak detector mode re-measured. If the emission level of the EUT measured by the peak detector is 3 dB lower than the applicable limit, the peak emission level will be reported. Otherwise, the emission measurement will be repeated using the quasi-peak detector and reported.

Above 1 GHz

The setting of the spectrum analyzer

RBW	1 MHz
VBW	PEAK: 3 MHz AVG: see note 6
Sweep	Auto
Detector	Peak
Trace	Max hold

1. The testing follows the guidelines in KDB 789033 D02 General U-NII Test Procedures New Rules v02r01 section II.G.3 ~ II.G.6.
2. The EUT was arranged to its worst case and then tune the antenna tower (from 1 m to 4 m) and turntable (from 0 degree to 360 degrees) to find the maximum reading. A pre-amp and a high pass filter are used for the test in order to get better signal level. Both horizontal and vertical polarizations of the antenna are set to make the measurement.
3. The EUT was placed on a turntable with 1.5 m above ground.
4. The EUT was set 3 meters from the interference receiving antenna, which was mounted on the top of a variable height antenna tower.
5. For measurement above 1 GHz, the emission measurement will be measured by the peak detector. This peak level, once corrected, must comply with the limit specified in Section 15.209.
6. For measurements above 1 GHz the resolution bandwidth is set to 1 MHz, then the video bandwidth is set to 3 MHz for peak measurements and 1 MHz resolution bandwidth with 1/T video bandwidth with peak detector for average measurements. For the Duty Cycle please refer to clause 7.1.ON TIME AND DUTY CYCLE.

X axis, Y axis, Z axis positions:

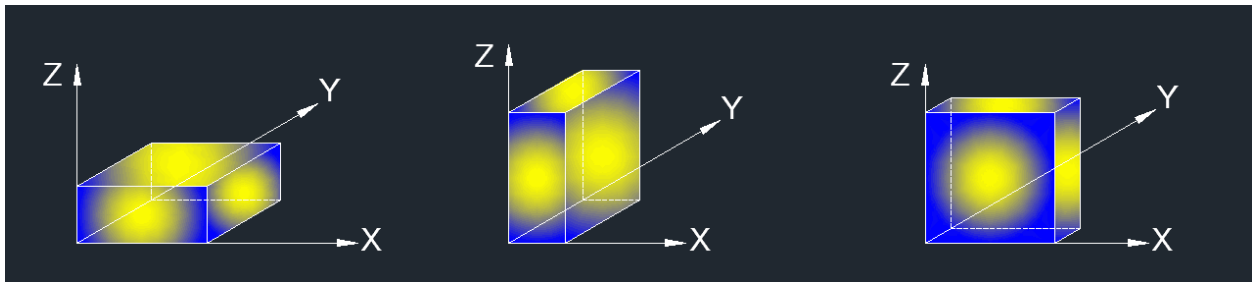

Note 1: For all radiated test, EUT in each of three orthogonal axis emissions had been tested, but only the worst case (X axis) data recorded in the report.

Note 2: The EUT was fully exercised with external accessories during the test. In the case of multiple accessory external ports, an external accessory shall be connected to one of each type of port.

For Restricted Bandedge:

Note:

1. Measurement = Reading Level + Correct Factor.
2. If the peak values are less than the average limit of 54 dBuV/m, the average result is deemed to comply with average limit.
3. Peak: Peak detector.
4. AVG: $VBW=1/Ton$, where: Ton is the transmitting duration.
5. For the transmitting duration, please refer to clause 7.1.
6. Only the worst data was recorded, if it complies with the limit, the other emissions deemed to comply with the limit.
7. Both horizontal and vertical have been tested, only the worst data was recorded in the report.
8. All modes, channels and antennas have been tested, only the worst data was recorded in the report.

For Radiate Spurious emission (9 kHz ~ 30 MHz):

Note:

1. Measurement = Reading Level + Correct Factor.
2. If the peak values are less than the QP limit, the QP result is deemed to comply with QP limit.
3. All 3 polarizations (Horizontal, Face-on and Face-off) of the loop antenna had been tested, but only the worst data recorded in the report.
4. All modes, channels and antennas have been tested, only the worst data was recorded in the report.

For Radiate Spurious Emission (30 MHz ~ 1 GHz):

Note:

1. Result Level = Read Level + Correct Factor.
2. If the peak values are less than the QP limit, the QP result is deemed to comply with QP limit.
3. All modes, channels and antennas have been tested, only the worst data was recorded in the report.

For Radiate Spurious Emission (1 GHz ~ 7 GHz):

1. Measurement = Reading Level + Correct Factor.
2. If the peak values are less than the average limit of 54 dBuV/m, the average result is deemed to comply with average limit.
3. Peak: Peak detector.
4. AVG: $VBW=1/Ton$, where: Ton is the transmitting duration.
5. For the transmitting duration, please refer to clause 7.1.
6. Filter losses were only considered in the spurious frequency bands and the authorized band was not corrected for Band reject filter losses.
7. Proper operation of the transmitter prior to adding the filter to the measurement chain.
8. Since non-restricted band peak emissions are less than the average limit, they also comply with the -27dBm/MHz (68.2dBuV/m) limit.
9. All modes, channels and antennas have been tested, only the worst data was recorded in the report.

For Radiate Spurious Emission (7 GHz ~ 18 GHz):

Note:

1. Peak Result = Reading Level + Correct Factor.
2. If the peak values are less than the average limit of 54 dBuV/m, the average result is deemed to comply with average limit.
3. Peak: Peak detector.
4. AVG: VBW=1/Ton, where: Ton is the transmitting duration.
5. For the transmitting duration, please refer to clause 7.1.
6. Filter losses were only considered in the spurious frequency bands and the authorized band was not corrected for High Pass Filter losses.
7. Proper operation of the transmitter prior to adding the filter to the measurement chain.
8. Since non-restricted band peak emissions are less than the average limit, they also comply with the -27dBm/MHz (68.2dBuV/m) limit.
9. All modes, channels and antennas have been tested, only the worst data was recorded in the report.

For Radiate Spurious emission (18 GHz ~ 26 GHz):

Note:

1. Measurement = Reading Level + Correct Factor.
2. If the peak values are less than the average limit of 54 dBuV/m, the average result is deemed to comply with average limit.
3. Peak: Peak detector.
4. All modes, channels and antennas have been tested, only the worst data was recorded in the report.

For Radiate Spurious emission (26 GHz ~ 40 GHz):

Note:

1. Measurement = Reading Level + Correct Factor.
2. If the peak values are less than the average limit of 54 dBuV/m, the average result is deemed to comply with average limit.
3. Peak: Peak detector.
4. All modes, channels and antennas have been tested, only the worst data was recorded in the report.

TEST SETUP

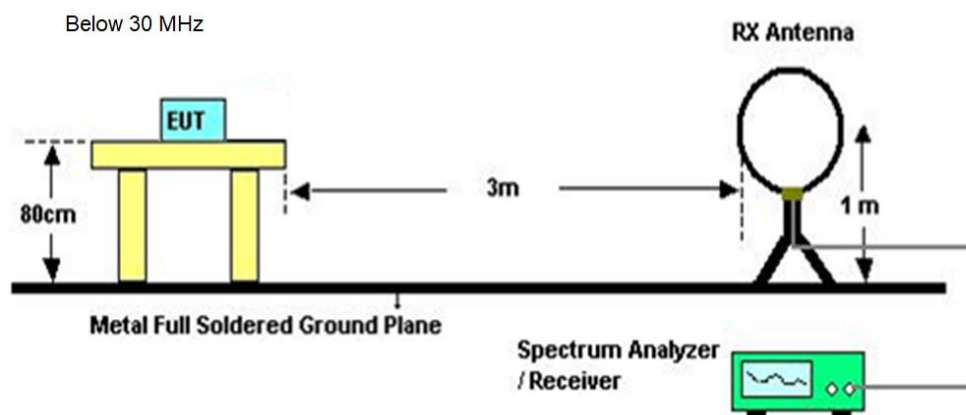

Below 1 GHz and above 30 MHz

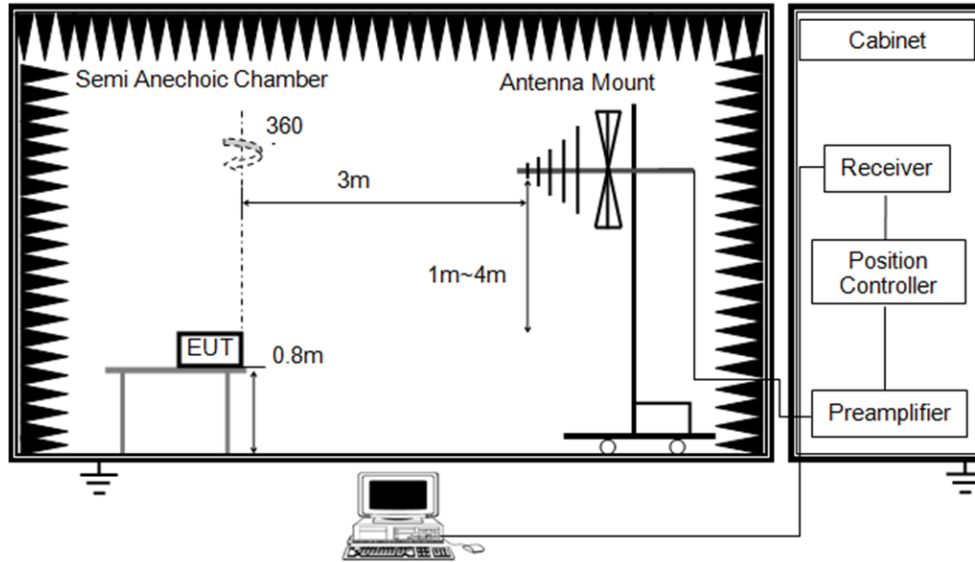

Above 1 GHz

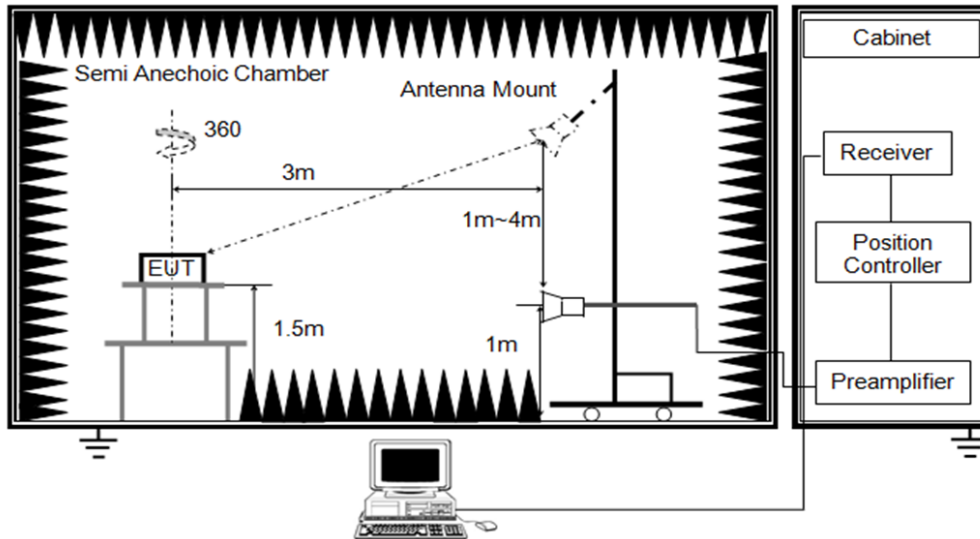

TEST ENVIRONMENT

Temperature	24.8°C	Relative Humidity	61%
Atmosphere Pressure	101kPa	Test Voltage	

TEST DATE / ENGINEER

Test Date	June 16, 2023	Test By	Rex Huang
-----------	---------------	---------	-----------

TEST RESULTS

8.1. RESTRICTED BANDEDGE

Test Mode:	802.11ax HE20 PK	Channel:	6115
Polarity:	Vertical	Test Voltage:	AC 120V_60Hz

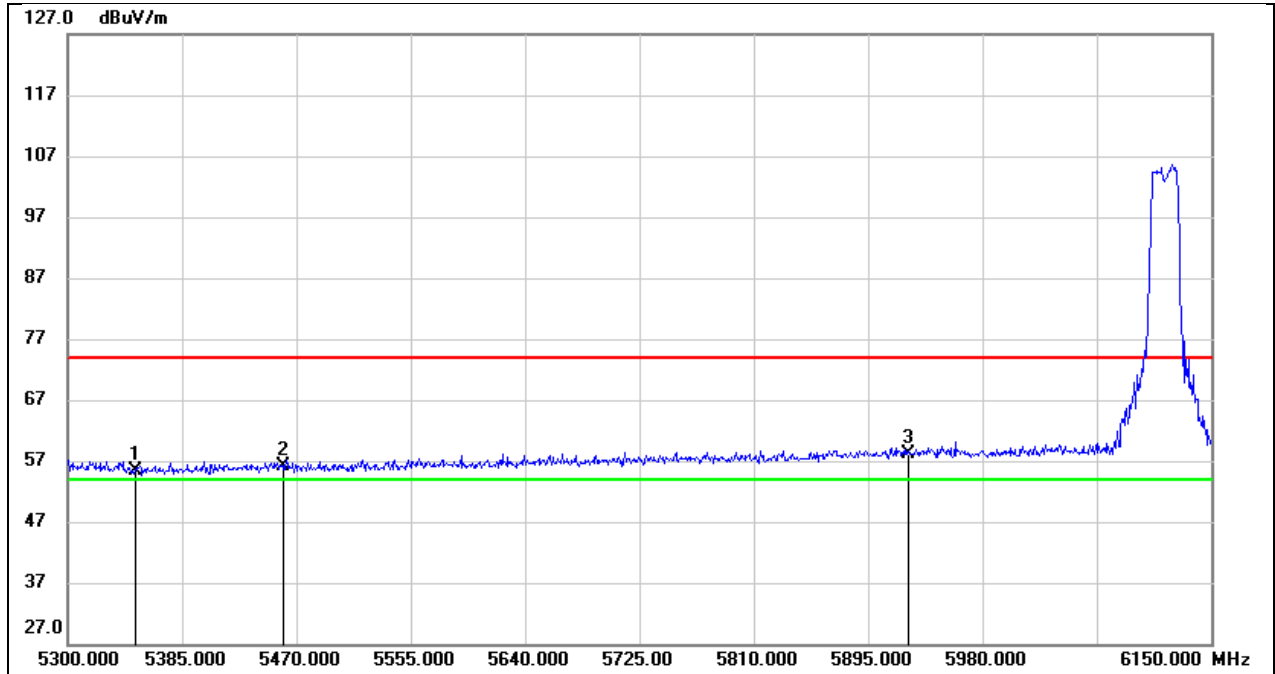

No.	Frequency (MHz)	Reading (dBuV)	Correct (dB/m)	Result (dBuV/m)	Limit (dBuV/m)	Margin (dB)	Remark
1	5350.000	14.81	40.49	55.30	74.00	-18.70	peak
2	5460.000	15.43	40.62	56.05	74.00	-17.95	peak
3	5925.000	16.40	41.80	58.20	74.00	-15.80	peak

Test Mode:	802.11ax HE20 AV	Channel:	6115
Polarity:	Vertical	Test Voltage:	AC 120V_60Hz

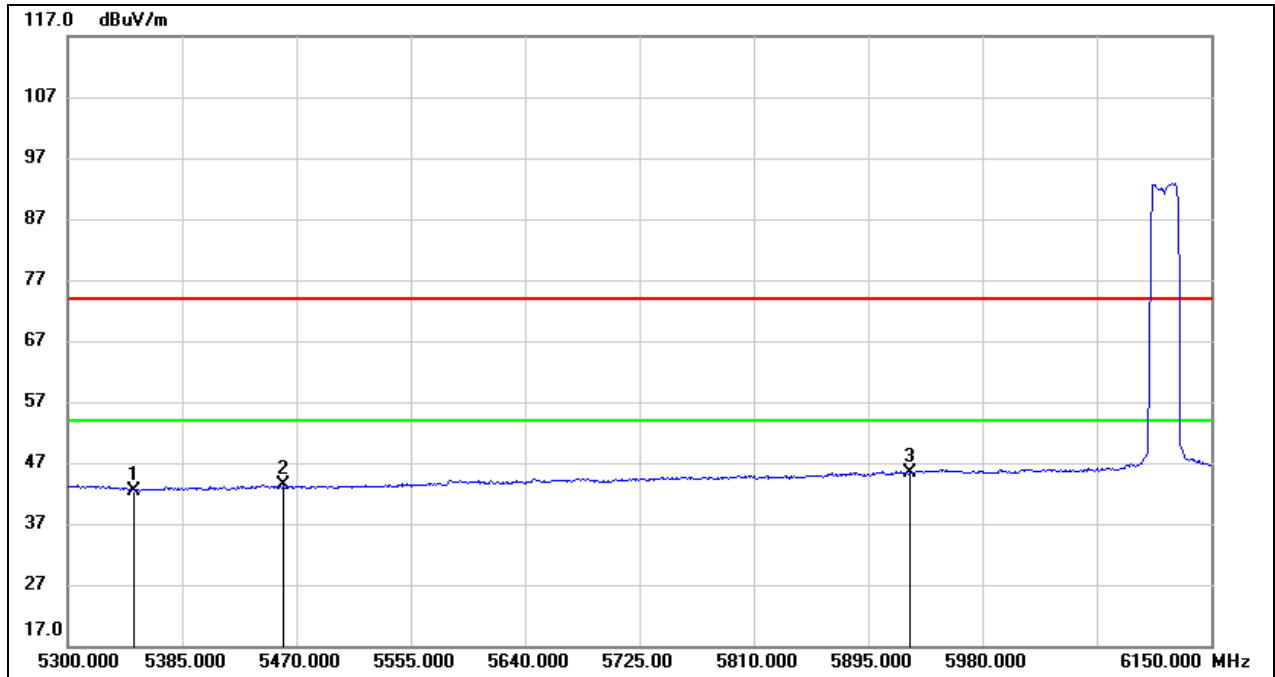

No.	Frequency (MHz)	Reading (dBuV)	Correct (dB/m)	Result (dBuV/m)	Limit (dBuV/m)	Margin (dB)	Remark
1	5350.000	1.96	40.49	42.45	54.00	-11.55	AVG
2	5460.000	2.64	40.62	43.26	54.00	-10.74	AVG
3	5925.000	3.55	41.80	45.35	54.00	-8.65	AVG

Test Mode:	802.11ax HE20 PK	Channel:	7095
Polarity:	Vertical	Test Voltage:	AC 120V_60Hz

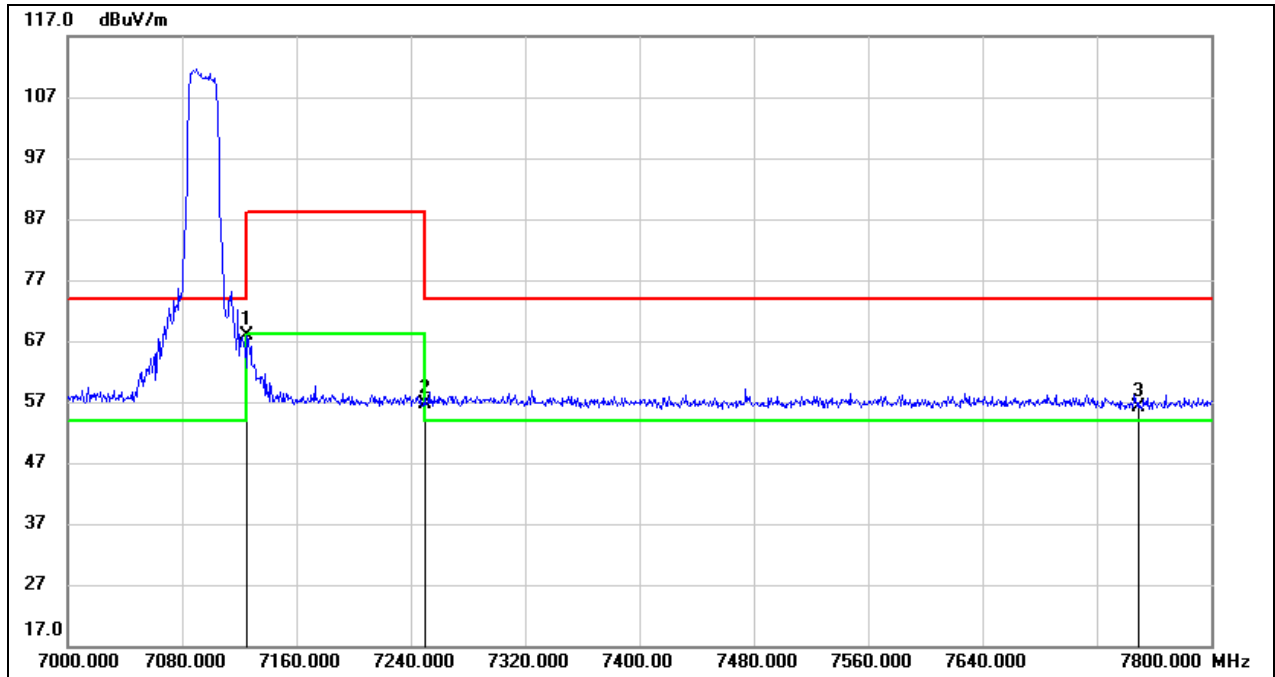

No.	Frequency (MHz)	Reading (dBuV)	Correct (dB/m)	Result (dBuV/m)	Limit (dBuV/m)	Margin (dB)	Remark
1	7125.000	22.53	45.36	67.89	74.00	-6.11	peak
2	7250.000	11.35	45.27	56.62	74.00	-17.38	peak
3	7750.000	10.95	45.08	56.03	74.00	-17.97	peak

Test Mode:	802.11ax HE20 AV	Channel:	7095
Polarity:	Vertical	Test Voltage:	AC 120V_60Hz

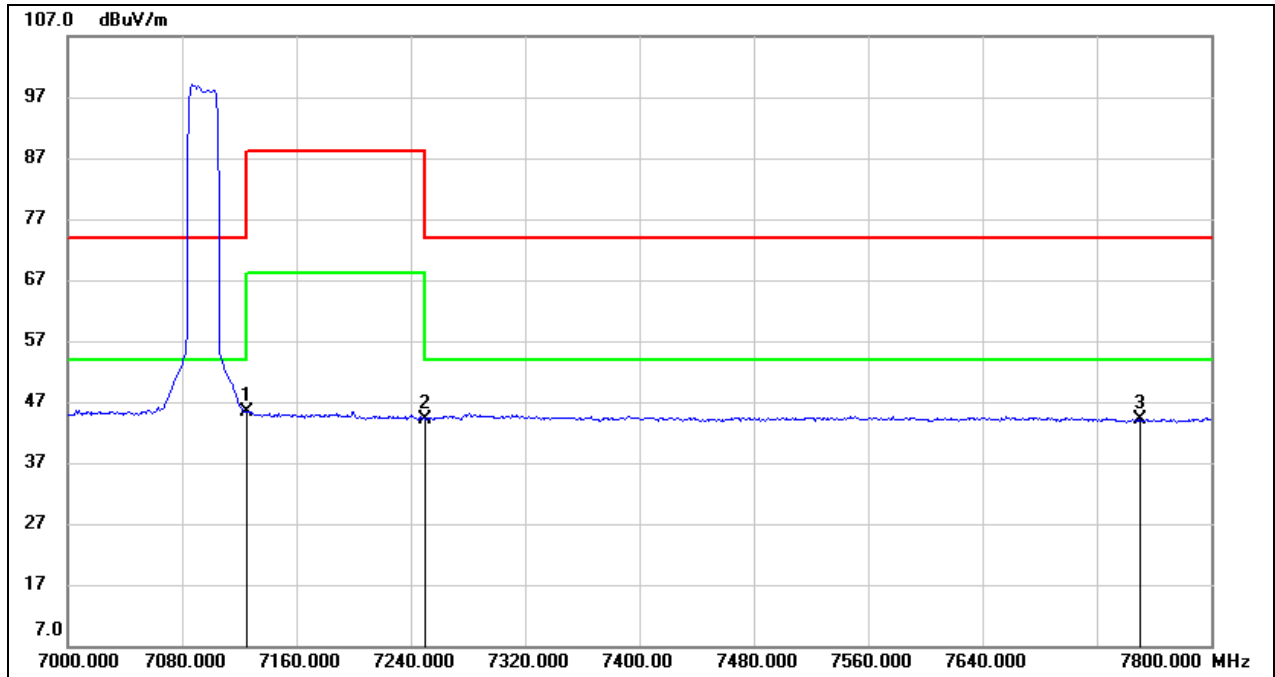

No.	Frequency (MHz)	Reading (dBuV)	Correct (dB/m)	Result (dBuV/m)	Limit (dBuV/m)	Margin (dB)	Remark
1	7125.000	-0.09	45.36	45.27	54.00	-8.73	AVG
2	7250.000	-1.06	45.27	44.21	54.00	-9.79	AVG
3	7750.000	-0.97	45.08	44.11	54.00	-9.89	AVG

Test Mode:	802.11ax HE20 PK	Channel:	7115
Polarity:	Vertical	Test Voltage:	AC 120V_60Hz

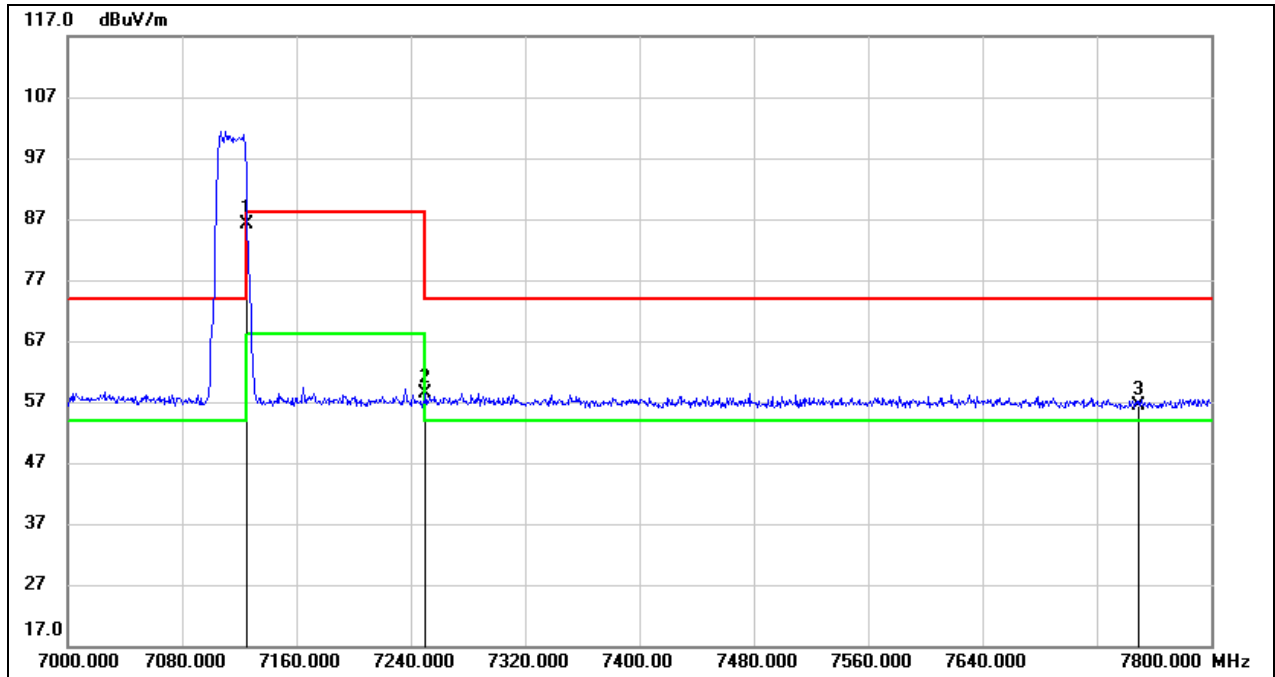

No.	Frequency (MHz)	Reading (dBuV)	Correct (dB/m)	Result (dBuV/m)	Limit (dBuV/m)	Margin (dB)	Remark
1	7125.000	40.88	45.36	86.24	74.00	12.24	peak
2	7250.000	13.13	45.27	58.40	74.00	-15.60	peak
3	7750.000	11.34	45.08	56.42	74.00	-17.58	peak

Test Mode:	802.11ax HE20 AV	Channel:	7115
Polarity:	Vertical	Test Voltage:	AC 120V_60Hz

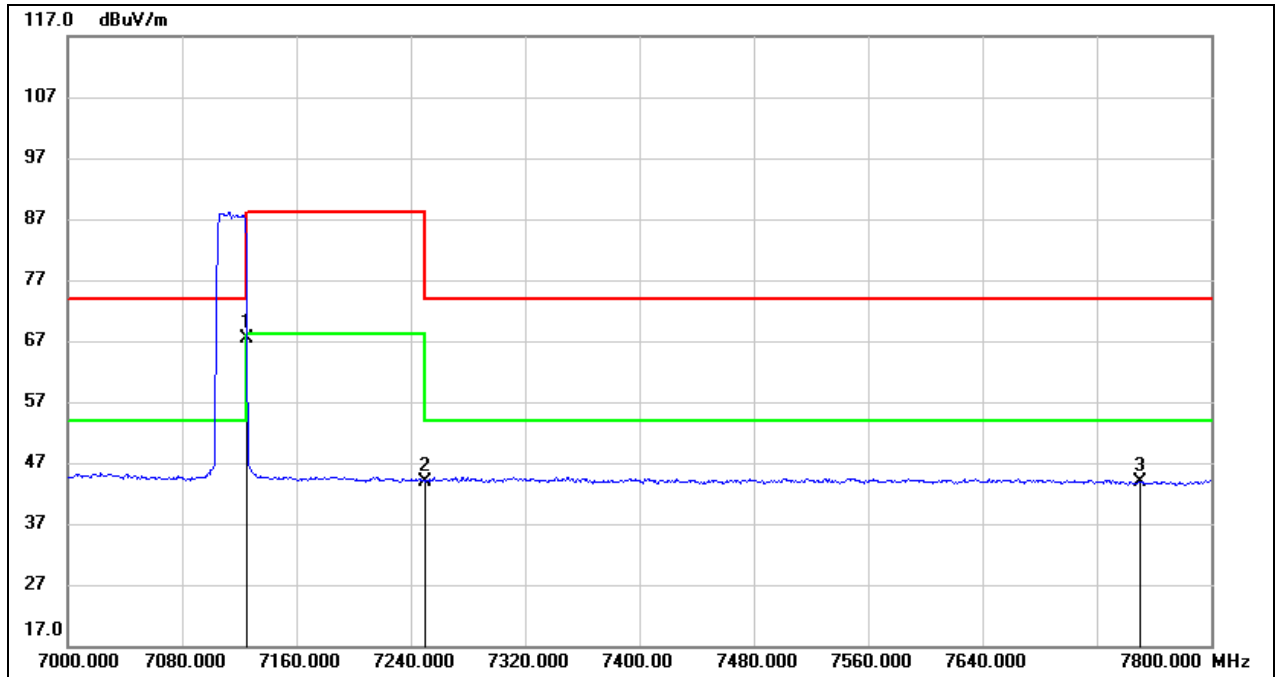

No.	Frequency (MHz)	Reading (dBuV)	Correct (dB/m)	Result (dBuV/m)	Limit (dBuV/m)	Margin (dB)	Remark
1	7125.000	22.10	45.36	67.46	54.00	13.46	AVG
2	7250.000	-1.44	45.27	43.83	54.00	-10.17	AVG
3	7750.000	-1.25	45.08	43.83	54.00	-10.17	AVG

Test Mode:	802.11ax HE40 PK	Channel:	6125
Polarity:	Vertical	Test Voltage:	AC 120V_60Hz

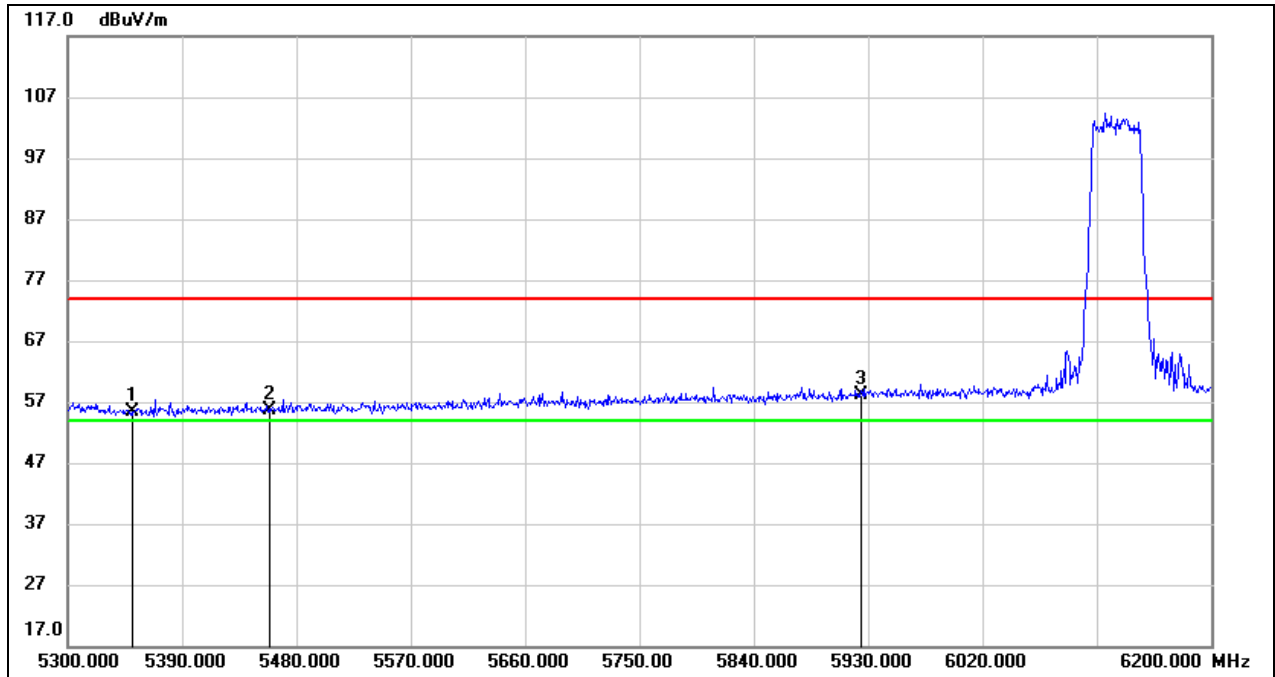

No.	Frequency (MHz)	Reading (dBuV)	Correct (dB/m)	Result (dBuV/m)	Limit (dBuV/m)	Margin (dB)	Remark
1	5350.000	14.79	40.49	55.28	74.00	-18.72	peak
2	5460.000	15.09	40.62	55.71	74.00	-18.29	peak
3	5925.000	16.40	41.80	58.20	74.00	-15.80	peak

Test Mode:	802.11ax HE40 AV	Channel:	6125
Polarity:	Vertical	Test Voltage:	AC 120V_60Hz

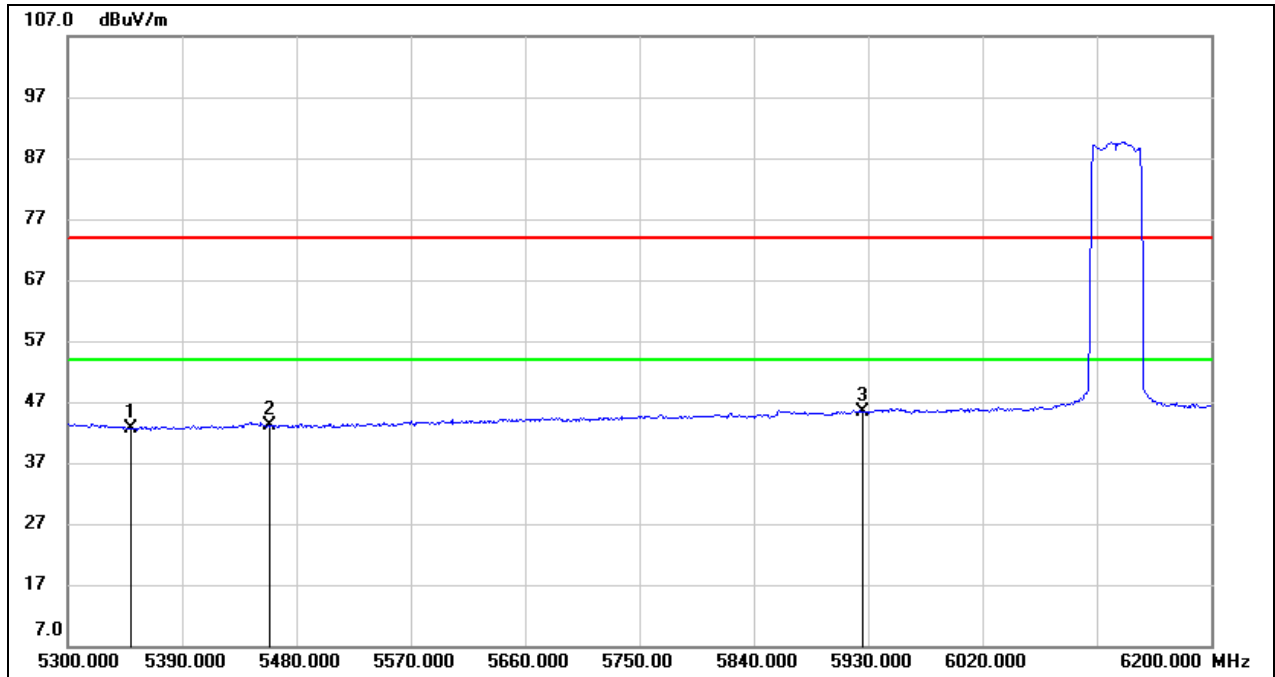

No.	Frequency (MHz)	Reading (dBuV)	Correct (dB/m)	Result (dBuV/m)	Limit (dBuV/m)	Margin (dB)	Remark
1	5350.000	2.05	40.49	42.54	54.00	-11.46	AVG
2	5460.000	2.43	40.62	43.05	54.00	-10.95	AVG
3	5925.000	3.55	41.80	45.35	54.00	-8.65	AVG

Test Mode:	802.11ax HE40 PK	Channel:	7085
Polarity:	Vertical	Test Voltage:	AC 120V_60Hz

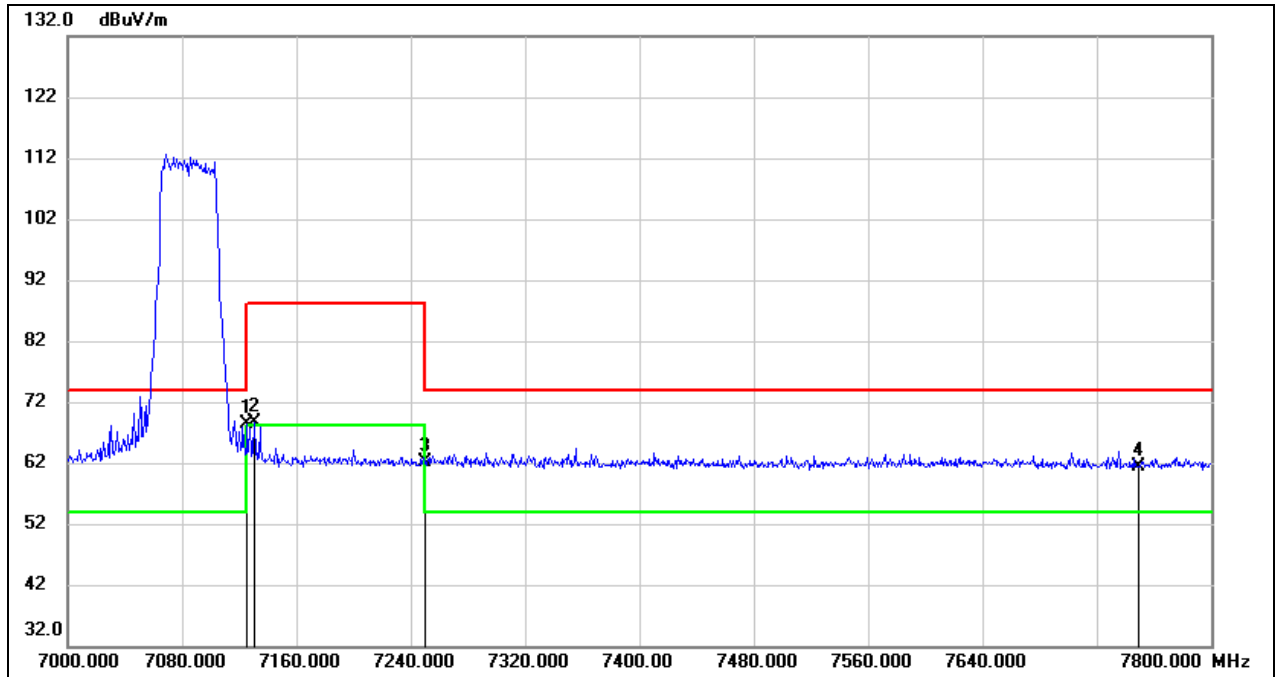

No.	Frequency (MHz)	Reading (dBuV)	Correct (dB/m)	Result (dBuV/m)	Limit (dBuV/m)	Margin (dB)	Remark
1	7125.000	22.94	45.36	68.30	74.00	-5.70	peak
2	7130.400	23.17	45.36	68.53	88.20	-19.67	peak
3	7250.000	16.94	45.27	62.21	74.00	-11.79	peak
4	7750.000	16.19	45.08	61.27	74.00	-12.73	peak

Test Mode:	802.11ax HE40 AV	Channel:	7085
Polarity:	Vertical	Test Voltage:	AC 120V_60Hz

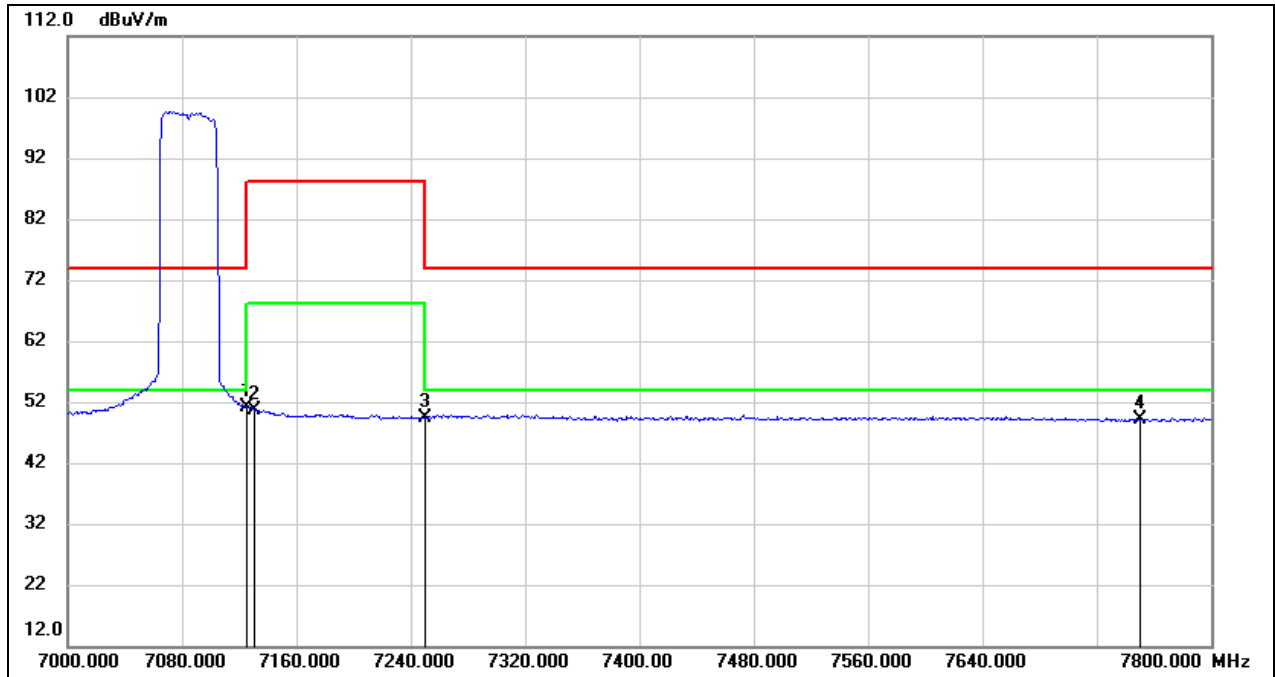

No.	Frequency (MHz)	Reading (dBuV)	Correct (dB/m)	Result (dBuV/m)	Limit (dBuV/m)	Margin (dB)	Remark
1	7125.000	5.74	45.36	51.10	54.00	-2.90	AVG
2	7130.400	5.32	45.36	50.68	68.20	-17.52	AVG
3	7250.000	4.09	45.27	49.36	54.00	-4.64	AVG
4	7750.000	4.13	45.08	49.21	54.00	-4.79	AVG

Test Mode:	802.11ax HE80 PK	Channel:	6145
Polarity:	Vertical	Test Voltage:	AC 120V_60Hz

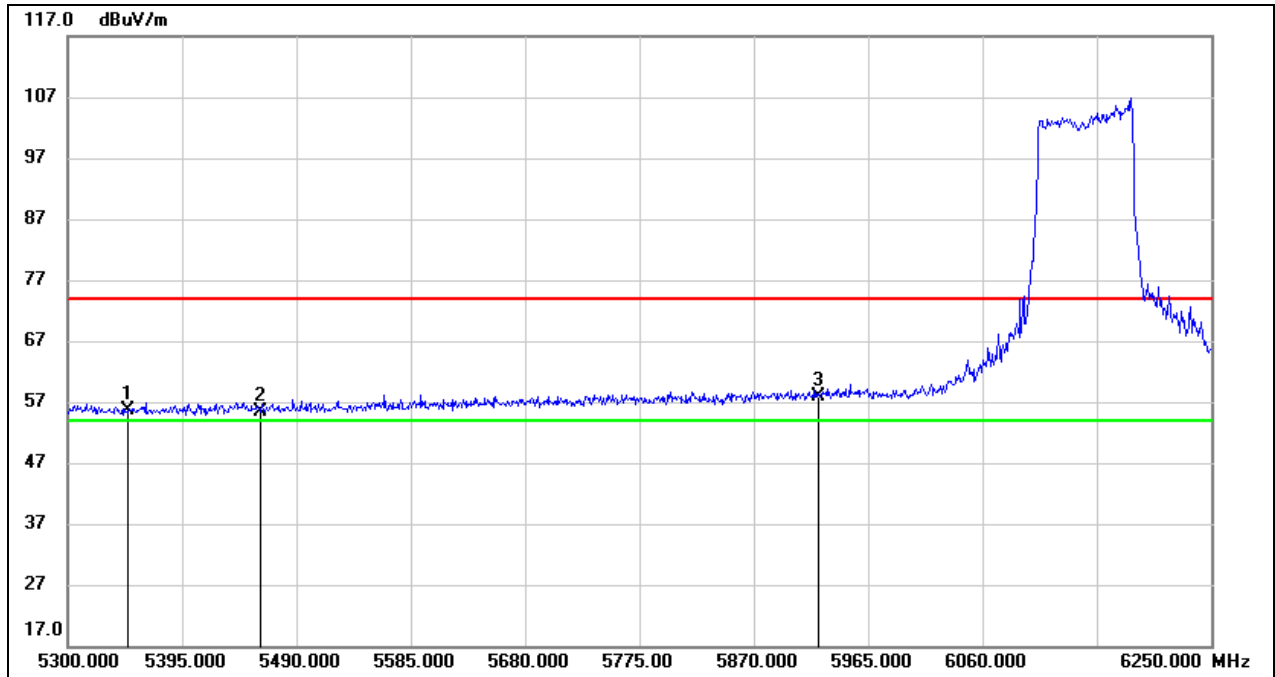

No.	Frequency (MHz)	Reading (dBuV)	Correct (dB/m)	Result (dBuV/m)	Limit (dBuV/m)	Margin (dB)	Remark
1	5350.000	15.07	40.49	55.56	74.00	-18.44	peak
2	5460.000	14.67	40.62	55.29	74.00	-18.71	peak
3	5925.000	16.06	41.80	57.86	74.00	-16.14	peak

Test Mode:	802.11ax HE80 AV	Channel:	6145
Polarity:	Vertical	Test Voltage:	AC 120V_60Hz

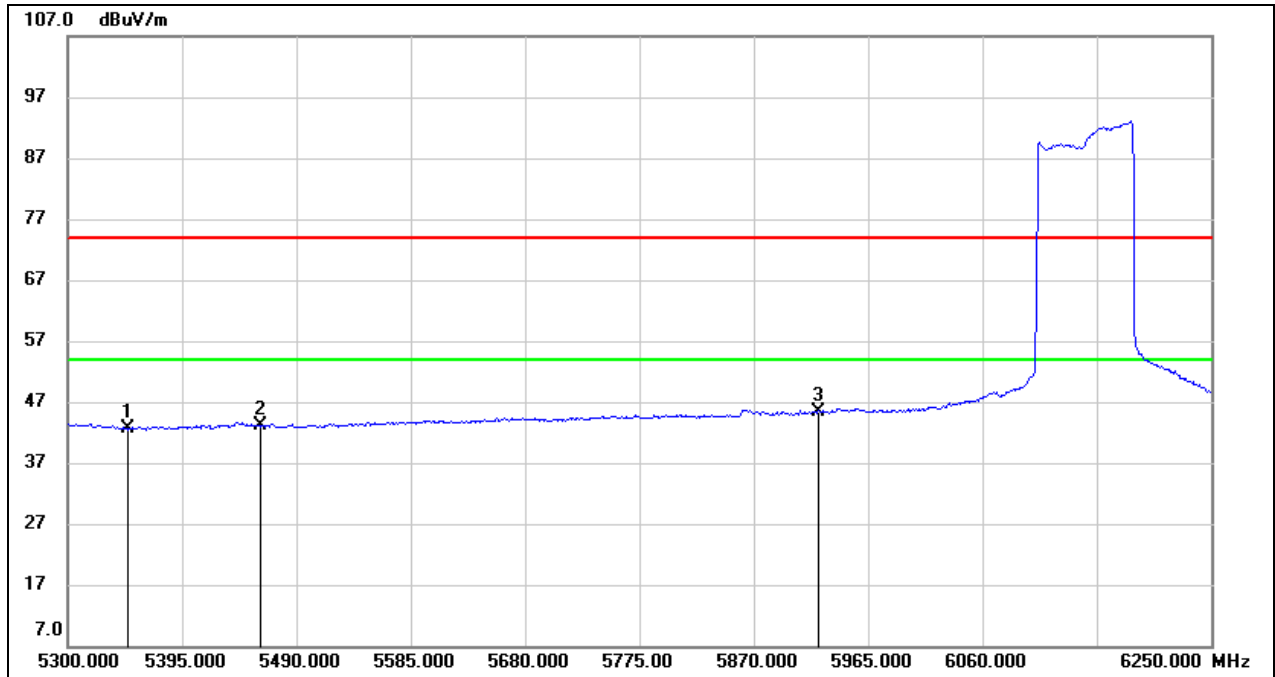

No.	Frequency (MHz)	Reading (dBuV)	Correct (dB/m)	Result (dBuV/m)	Limit (dBuV/m)	Margin (dB)	Remark
1	5350.000	2.13	40.49	42.62	54.00	-11.38	AVG
2	5460.000	2.48	40.62	43.10	54.00	-10.90	AVG
3	5925.000	3.53	41.80	45.33	54.00	-8.67	AVG

Test Mode:	802.11ax HE80 PK	Channel:	7025
Polarity:	Vertical	Test Voltage:	AC 120V_60Hz

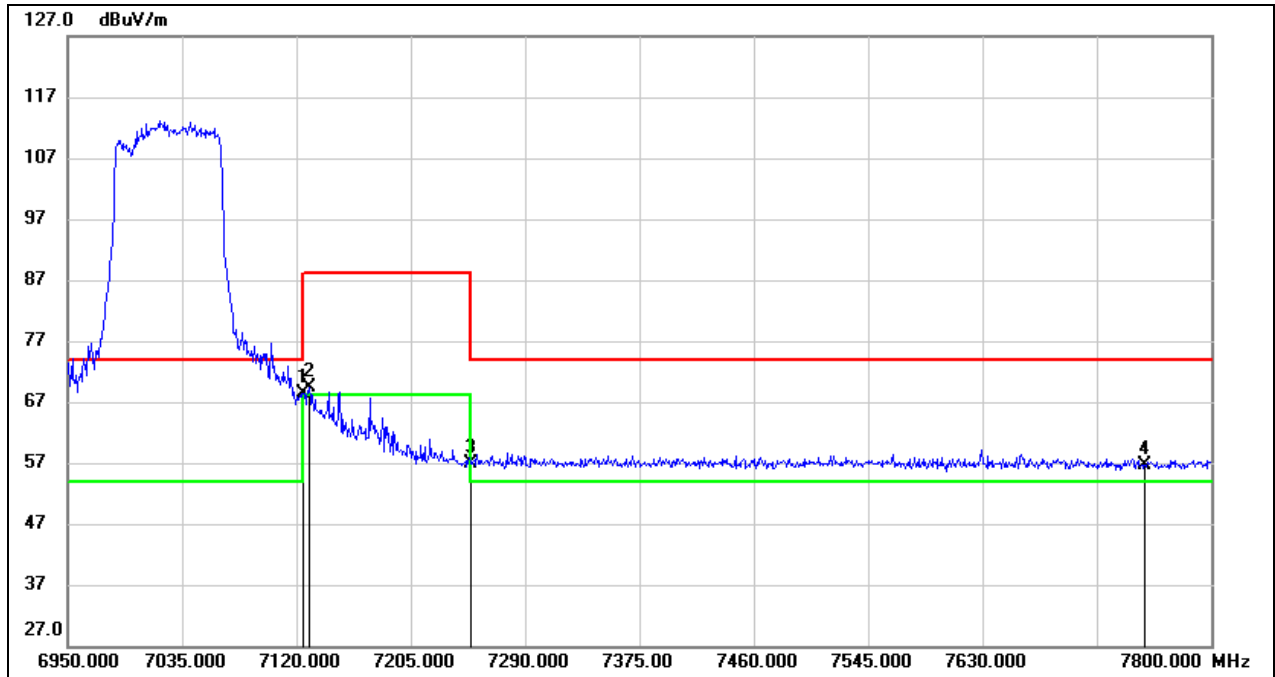

No.	Frequency (MHz)	Reading (dBuV)	Correct (dB/m)	Result (dBuV/m)	Limit (dBuV/m)	Margin (dB)	Remark
1	7125.000	23.05	45.36	68.41	74.00	-5.59	peak
2	7129.350	24.04	45.36	69.40	88.20	-18.80	peak
3	7250.000	11.53	45.27	56.80	74.00	-17.20	peak
4	7750.000	11.50	45.08	56.58	74.00	-17.42	peak

Test Mode:	802.11ax HE80 AV	Channel:	7025
Polarity:	Vertical	Test Voltage:	AC 120V_60Hz

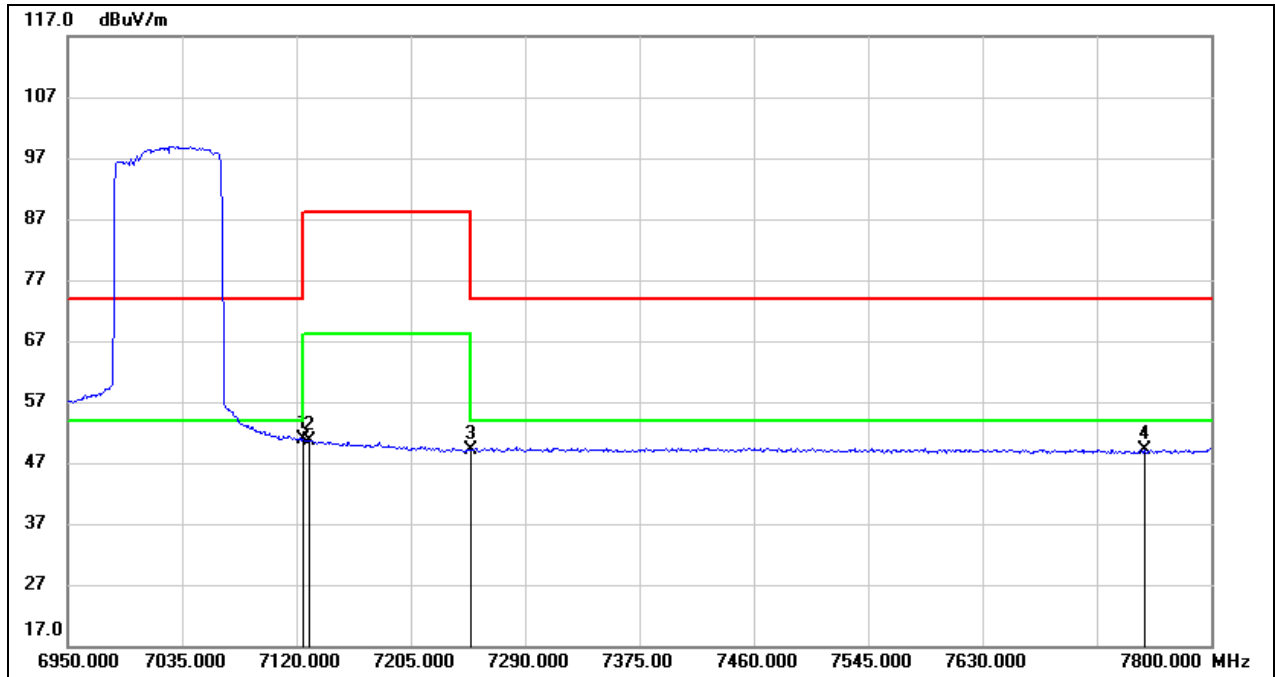

No.	Frequency (MHz)	Reading (dBuV)	Correct (dB/m)	Result (dBuV/m)	Limit (dBuV/m)	Margin (dB)	Remark
1	7125.000	5.42	45.36	50.78	54.00	-3.22	AVG
2	7129.350	5.26	45.36	50.62	68.20	-17.58	AVG
3	7250.000	3.84	45.27	49.11	54.00	-4.89	AVG
4	7750.000	3.96	45.08	49.04	54.00	-4.96	AVG

Test Mode:	802.11ax HE160 PK	Channel:	6185
Polarity:	Vertical	Test Voltage:	AC 120V_60Hz

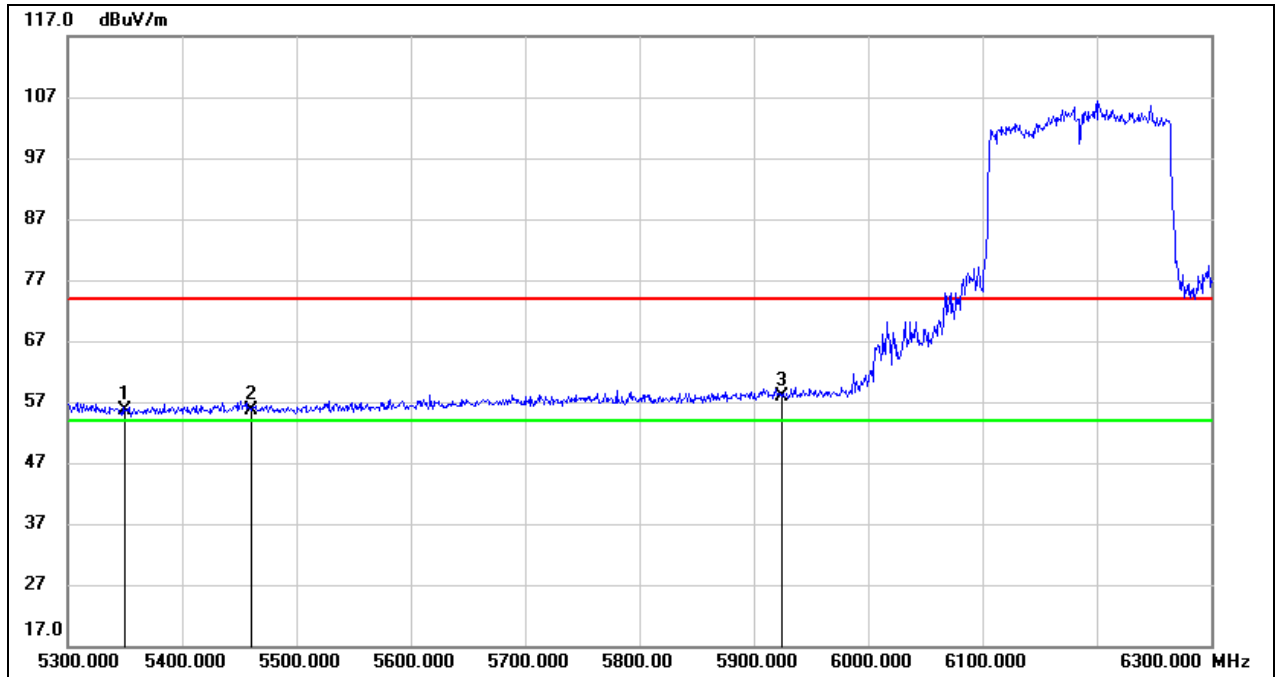

No.	Frequency (MHz)	Reading (dBuV)	Correct (dB/m)	Result (dBuV/m)	Limit (dBuV/m)	Margin (dB)	Remark
1	5350.000	15.14	40.49	55.63	74.00	-18.37	peak
2	5460.000	14.97	40.62	55.59	74.00	-18.41	peak
3	5925.000	16.08	41.80	57.88	74.00	-16.12	peak

Test Mode:	802.11ax HE160 AV	Channel:	6185
Polarity:	Vertical	Test Voltage:	AC 120V_60Hz

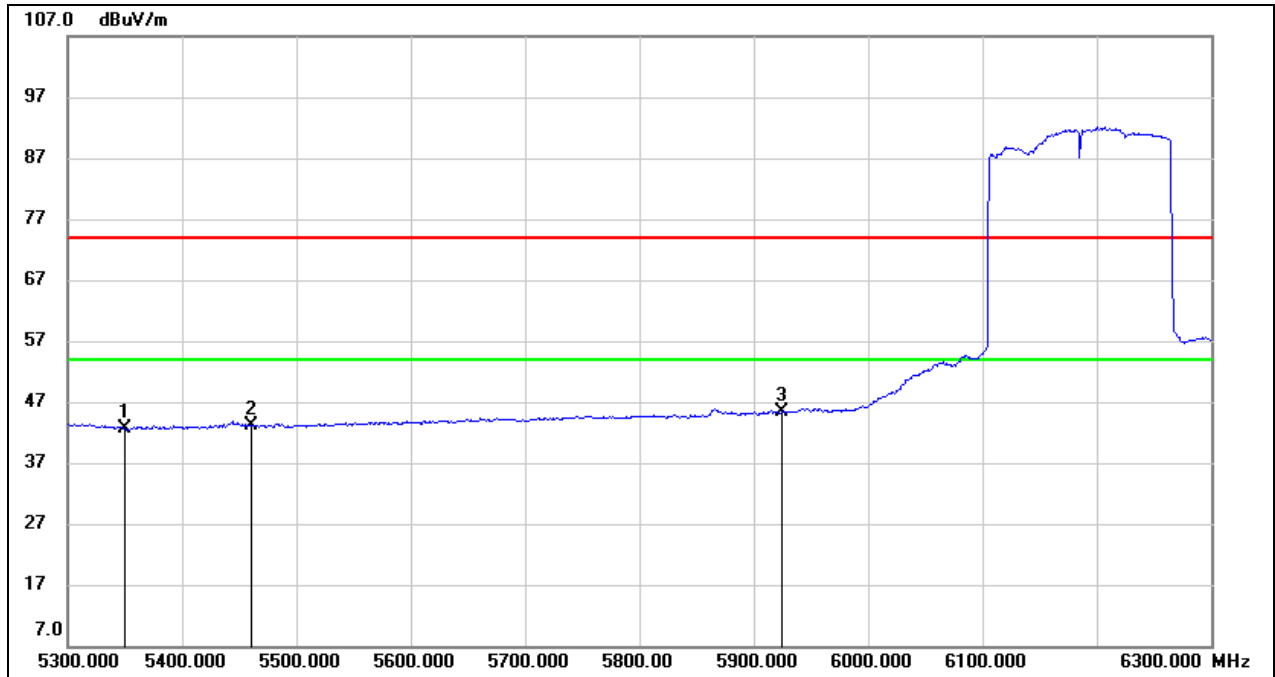

No.	Frequency (MHz)	Reading (dBuV)	Correct (dB/m)	Result (dBuV/m)	Limit (dBuV/m)	Margin (dB)	Remark
1	5350.000	2.20	40.49	42.69	54.00	-11.31	AVG
2	5460.000	2.46	40.62	43.08	54.00	-10.92	AVG
3	5925.000	3.65	41.80	45.45	54.00	-8.55	AVG

Test Mode:	802.11ax HE160 PK	Channel:	6985
Polarity:	Vertical	Test Voltage:	AC 120V_60Hz

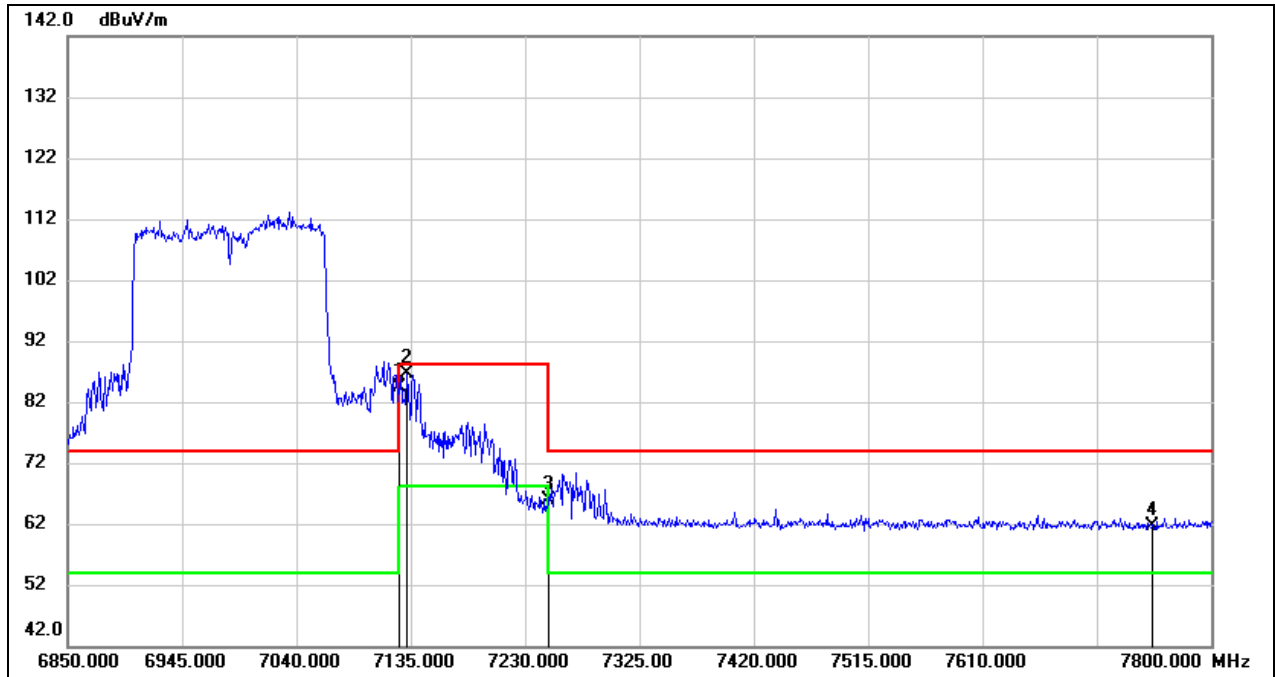

No.	Frequency (MHz)	Reading (dBuV)	Correct (dB/m)	Result (dBuV/m)	Limit (dBuV/m)	Margin (dB)	Remark
1	7125.000	38.93	45.36	84.29	74.00	10.29	peak
2	7131.200	41.18	45.36	86.54	88.20	-1.66	peak
3	7250.000	20.56	45.27	65.83	74.00	-8.17	peak
4	7750.000	16.49	45.08	61.57	74.00	-12.43	peak

Test Mode:	802.11ax HE160 AV	Channel:	6985
Polarity:	Vertical	Test Voltage:	AC 120V_60Hz

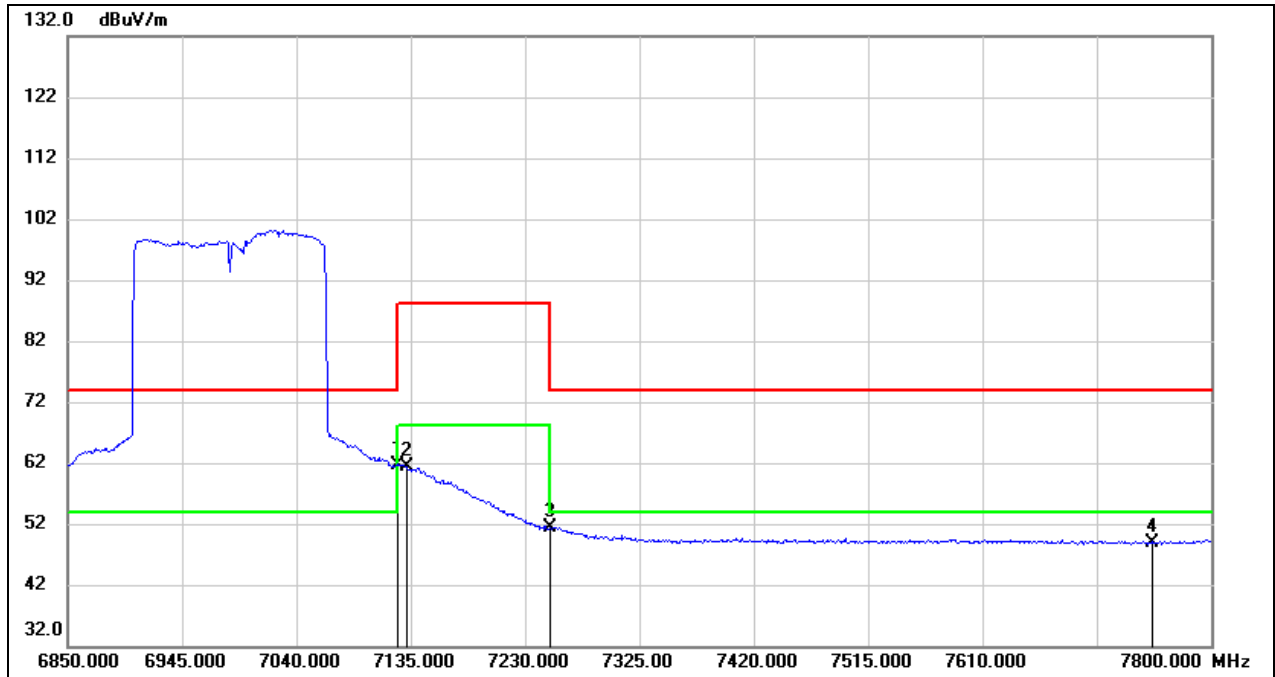

No.	Frequency (MHz)	Reading (dBuV)	Correct (dB/m)	Result (dBuV/m)	Limit (dBuV/m)	Margin (dB)	Remark
1	7125.000	16.17	45.36	61.53	54.00	7.53	AVG
2	7131.200	16.12	45.36	61.48	68.20	-6.72	AVG
3	7250.000	5.99	45.27	51.26	54.00	-2.74	AVG
4	7750.000	3.78	45.08	48.86	54.00	-5.14	AVG

8.2. SPURIOUS EMISSIONS(1 GHZ~9 GHZ)

Test Mode:	802.11ax HE20	Channel:	6115
Polarity:	Horizontal	Test Voltage:	AC 120V_60Hz

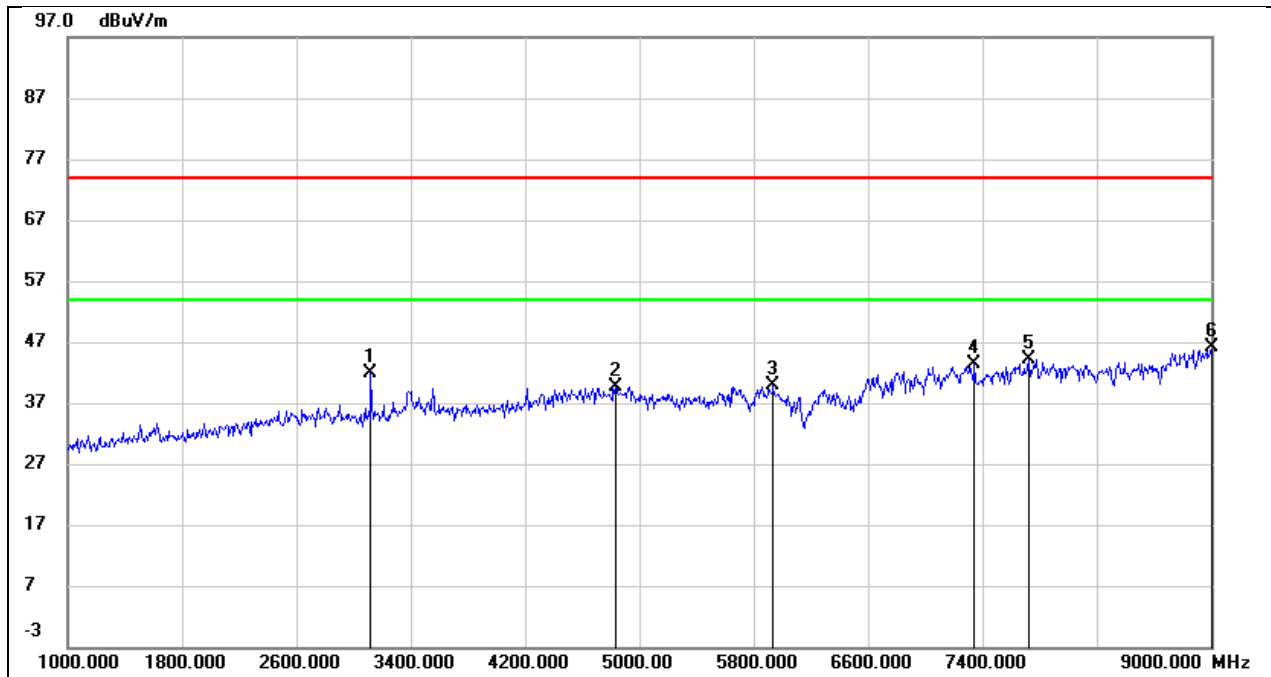

No.	Frequency (MHz)	Reading (dBuV)	Correct (dB/m)	Result (dBuV/m)	Limit (dBuV/m)	Margin (dB)	Remark
1	3120.000	48.68	-6.71	41.97	74.00	-32.03	peak
2	4832.000	40.58	-0.83	39.75	74.00	-34.25	peak
3	5936.000	38.09	1.67	39.76	74.00	-34.24	peak
4	7344.000	37.48	5.85	43.33	74.00	-30.67	peak
5	7720.000	38.50	5.67	44.17	74.00	-29.83	peak
6	9000.000	36.31	9.74	46.05	74.00	-27.95	peak

Test Mode:	802.11ax HE20	Channel:	6115
Polarity:	Vertical	Test Voltage:	AC 120V_60Hz

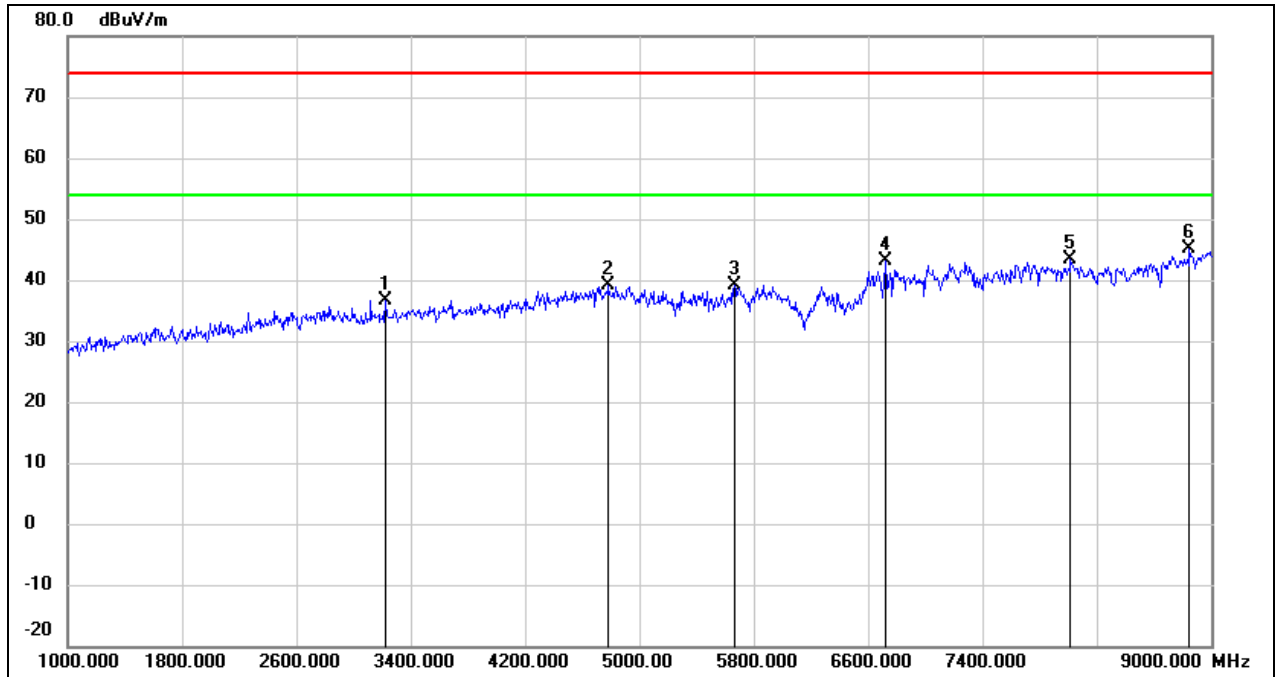

No.	Frequency (MHz)	Reading (dBuV)	Correct (dB/m)	Result (dBuV/m)	Limit (dBuV/m)	Margin (dB)	Remark
1	3224.000	43.15	-6.47	36.68	74.00	-37.32	peak
2	4784.000	40.22	-1.01	39.21	74.00	-34.79	peak
3	5664.000	38.19	0.89	39.08	74.00	-34.92	peak
4	6720.000	38.29	4.81	43.10	74.00	-30.90	peak
5	8016.000	37.65	5.67	43.32	74.00	-30.68	peak
6	8848.000	36.51	8.67	45.18	74.00	-28.82	peak

Test Mode:	802.11ax HE20	Channel:	6275
Polarity:	Horizontal	Test Voltage:	AC 120V_60Hz

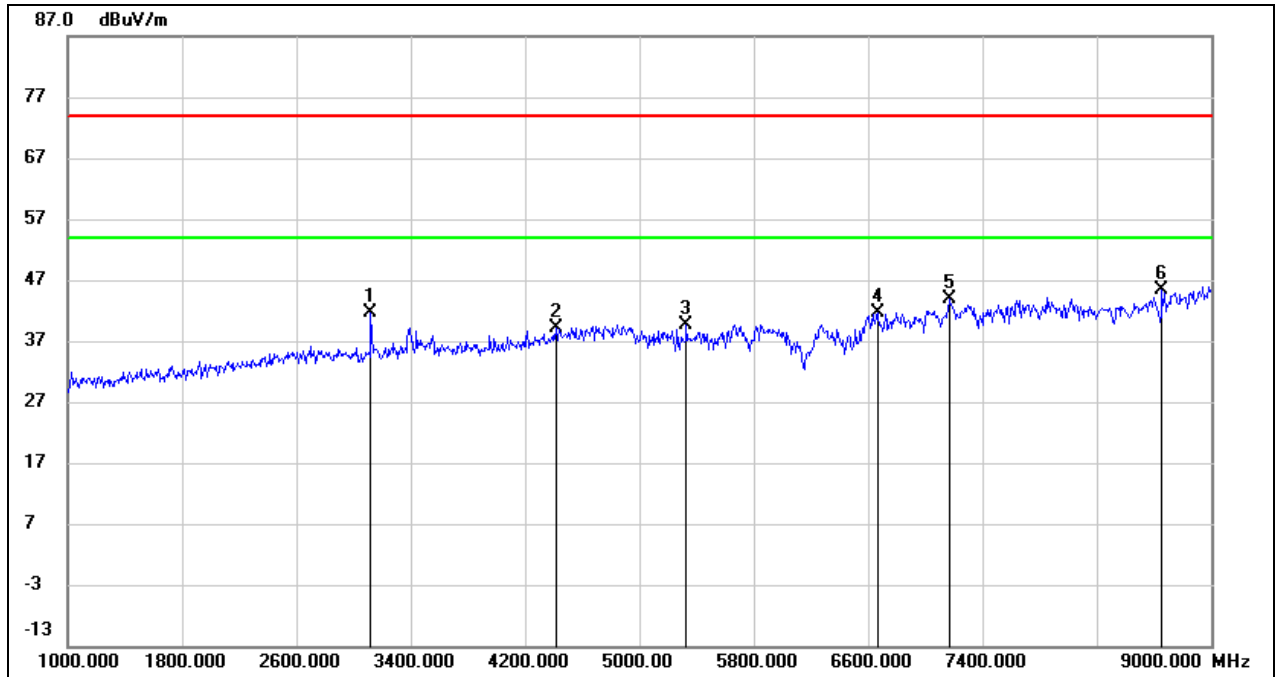

No.	Frequency (MHz)	Reading (dBuV)	Correct (dB/m)	Result (dBuV/m)	Limit (dBuV/m)	Margin (dB)	Remark
1	3120.000	48.33	-6.71	41.62	74.00	-32.38	peak
2	4416.000	41.60	-2.54	39.06	74.00	-34.94	peak
3	5328.000	39.51	0.23	39.74	74.00	-34.26	peak
4	6664.000	37.00	4.54	41.54	74.00	-32.46	peak
5	7168.000	37.78	6.02	43.80	74.00	-30.20	peak
6	8656.000	38.10	7.33	45.43	74.00	-28.57	peak

Test Mode:	802.11ax HE20	Channel:	6275
Polarity:	Vertical	Test Voltage:	AC 120V_60Hz

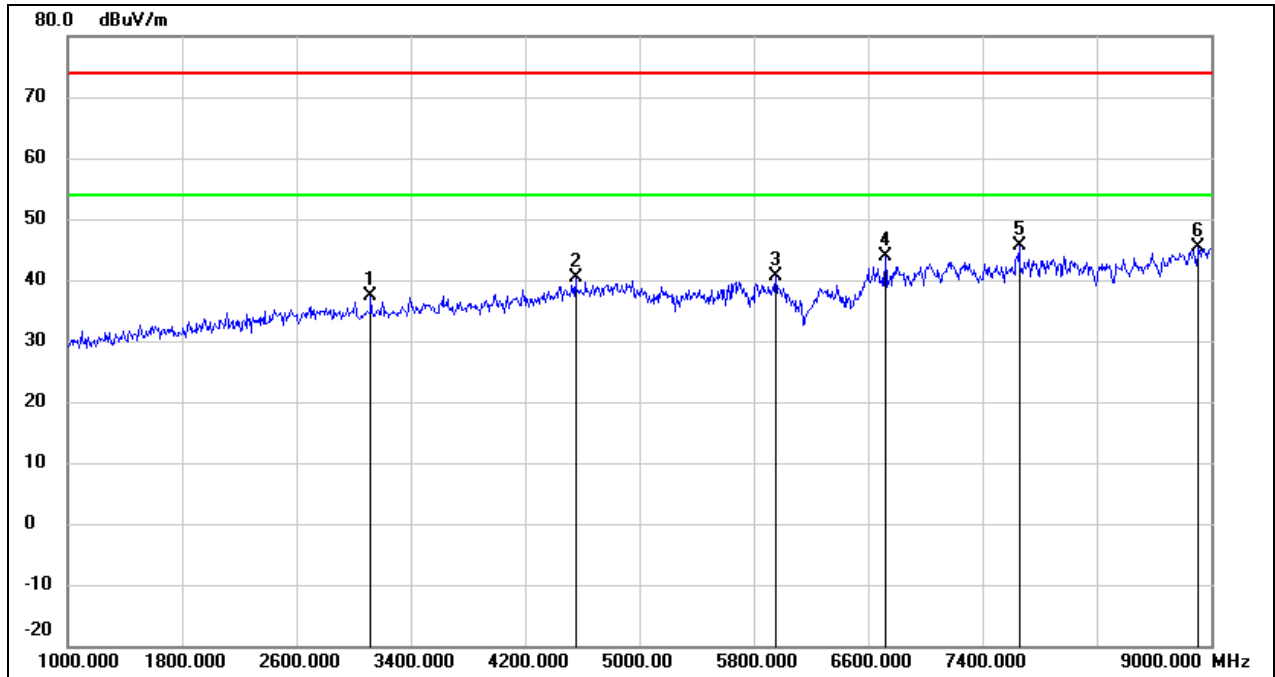

No.	Frequency (MHz)	Reading (dBuV)	Correct (dB/m)	Result (dBuV/m)	Limit (dBuV/m)	Margin (dB)	Remark
1	3120.000	43.97	-6.71	37.26	74.00	-36.74	peak
2	4552.000	42.20	-1.93	40.27	74.00	-33.73	peak
3	5952.000	38.85	1.72	40.57	74.00	-33.43	peak
4	6720.000	38.95	4.81	43.76	74.00	-30.24	peak
5	7656.000	40.01	5.67	45.68	74.00	-28.32	peak
6	8912.000	36.21	9.11	45.32	74.00	-28.68	peak

Test Mode:	802.11ax HE20	Channel:	6415
Polarity:	Horizontal	Test Voltage:	AC 120V_60Hz

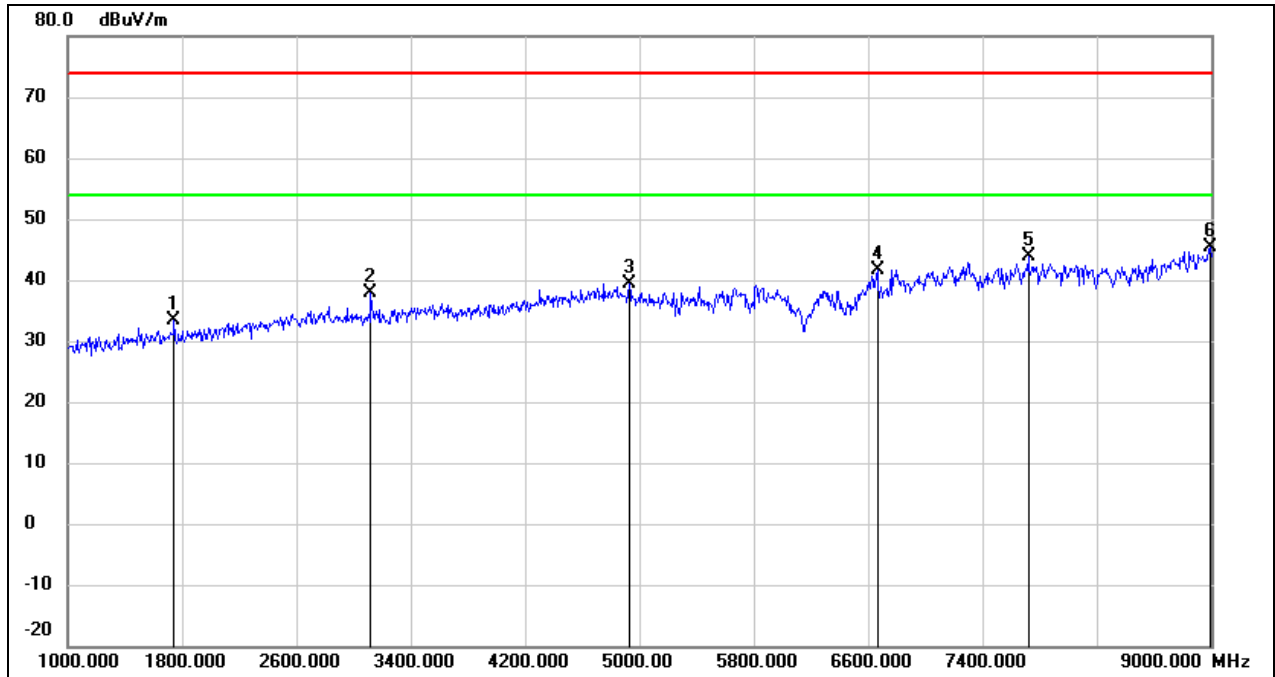

No.	Frequency (MHz)	Reading (dBuV)	Correct (dB/m)	Result (dBuV/m)	Limit (dBuV/m)	Margin (dB)	Remark
1	1744.000	45.23	-11.90	33.33	74.00	-40.67	peak
2	3120.000	44.62	-6.71	37.91	74.00	-36.09	peak
3	4928.000	39.73	-0.44	39.29	74.00	-34.71	peak
4	6664.000	37.17	4.54	41.71	74.00	-32.29	peak
5	7720.000	38.12	5.67	43.79	74.00	-30.21	peak
6	8992.000	35.62	9.68	45.30	74.00	-28.70	peak

Test Mode:	802.11ax HE20	Channel:	6415
Polarity:	Vertical	Test Voltage:	AC 120V_60Hz

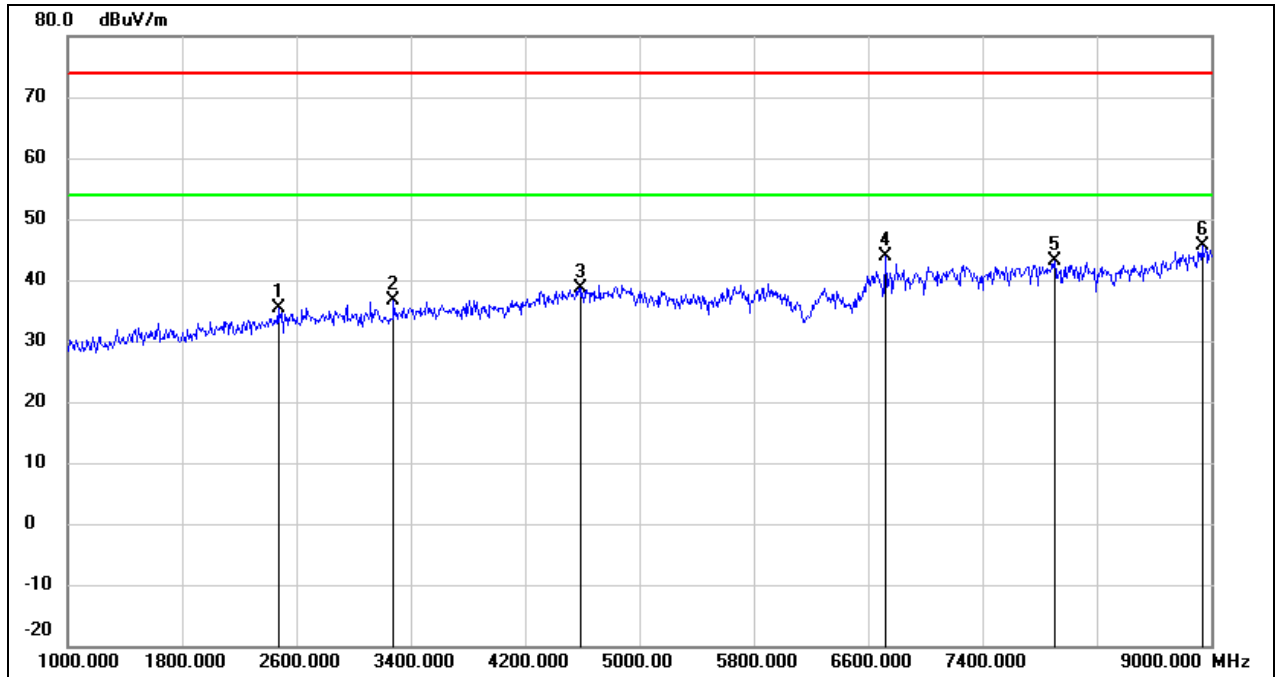

No.	Frequency (MHz)	Reading (dBuV)	Correct (dB/m)	Result (dBuV/m)	Limit (dBuV/m)	Margin (dB)	Remark
1	2472.000	44.12	-8.63	35.49	74.00	-38.51	peak
2	3280.000	42.89	-6.35	36.54	74.00	-37.46	peak
3	4592.000	40.41	-1.78	38.63	74.00	-35.37	peak
4	6720.000	38.99	4.81	43.80	74.00	-30.20	peak
5	7904.000	37.45	5.66	43.11	74.00	-30.89	peak
6	8936.000	36.46	9.29	45.75	74.00	-28.25	peak

Test Mode:	802.11ax HE20	Channel:	6435
Polarity:	Horizontal	Test Voltage:	AC 120V_60Hz

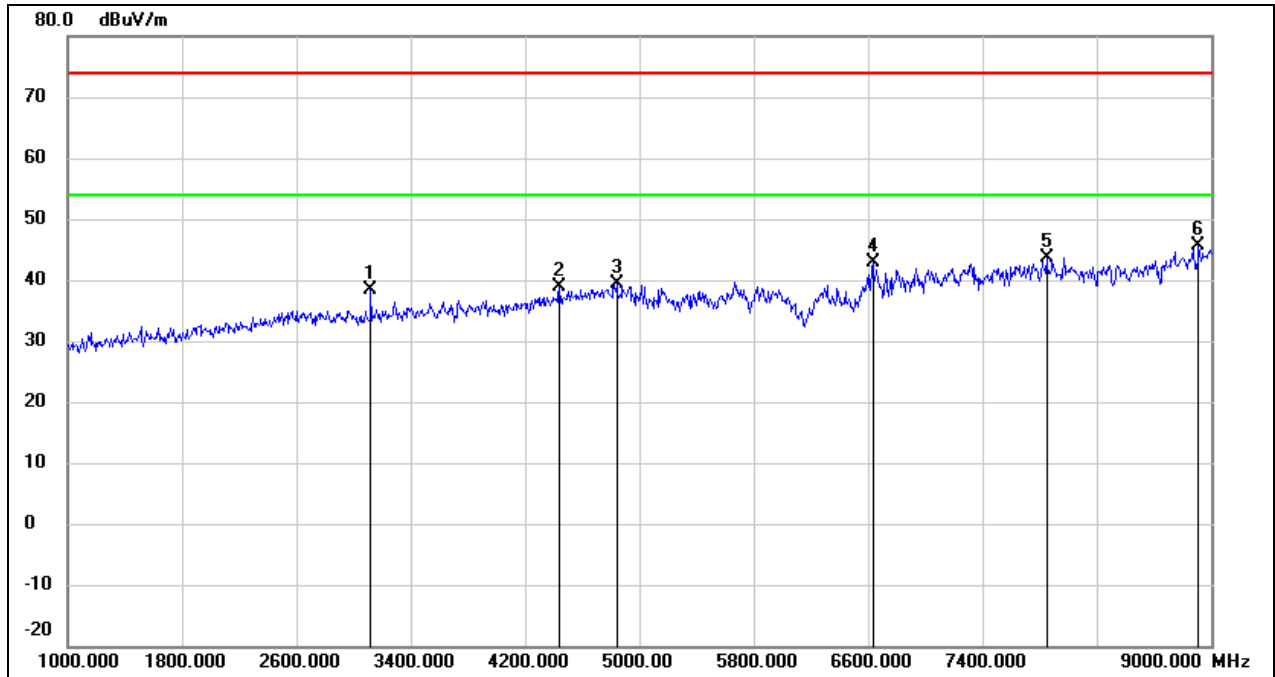

No.	Frequency (MHz)	Reading (dBuV)	Correct (dB/m)	Result (dBuV/m)	Limit (dBuV/m)	Margin (dB)	Remark
1	3120.000	44.98	-6.71	38.27	74.00	-35.73	peak
2	4440.000	41.25	-2.42	38.83	74.00	-35.17	peak
3	4840.000	40.15	-0.78	39.37	74.00	-34.63	peak
4	6632.000	38.59	4.38	42.97	74.00	-31.03	peak
5	7848.000	38.07	5.67	43.74	74.00	-30.26	peak
6	8912.000	36.43	9.11	45.54	74.00	-28.46	peak

Test Mode:	802.11ax HE20	Channel:	6435
Polarity:	Vertical	Test Voltage:	AC 120V_60Hz

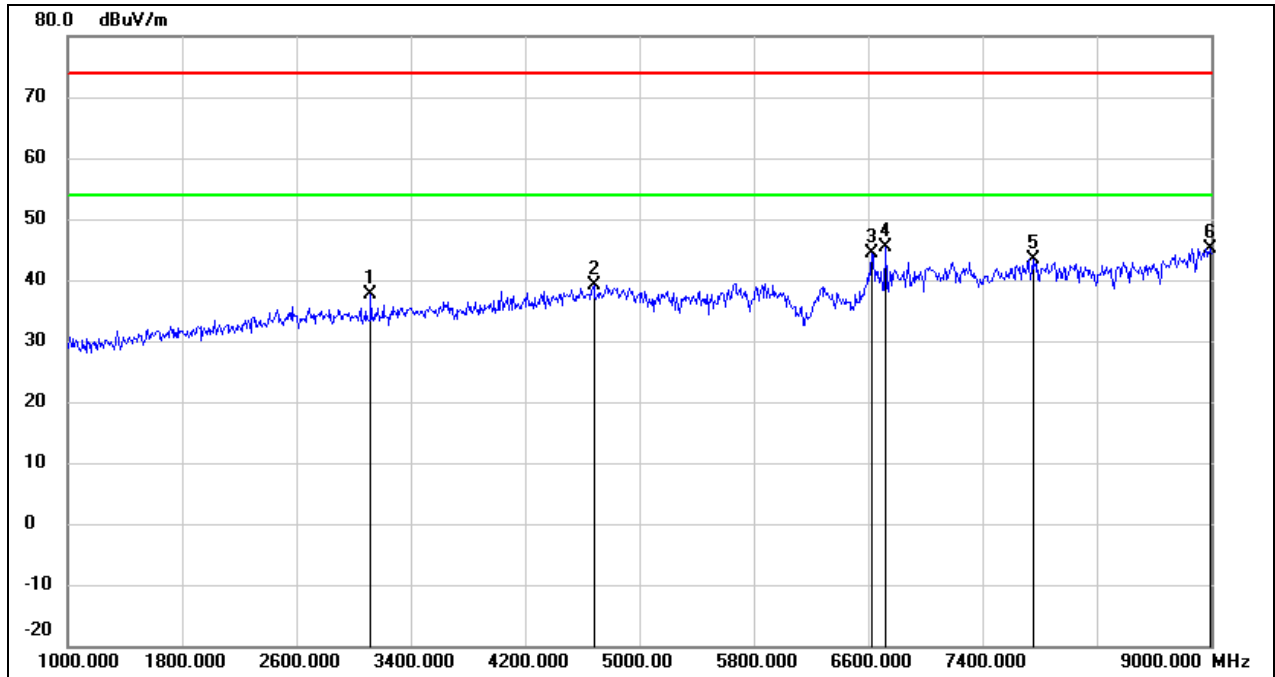

No.	Frequency (MHz)	Reading (dBuV)	Correct (dB/m)	Result (dBuV/m)	Limit (dBuV/m)	Margin (dB)	Remark
1	3120.000	44.36	-6.71	37.65	74.00	-36.35	peak
2	4680.000	40.61	-1.42	39.19	74.00	-34.81	peak
3	6624.000	39.99	4.33	44.32	74.00	-29.68	peak
4	6720.000	40.59	4.81	45.40	74.00	-28.60	peak
5	7752.000	37.67	5.66	43.33	74.00	-30.67	peak
6	8992.000	35.53	9.68	45.21	74.00	-28.79	peak

Test Mode:	802.11ax HE20	Channel:	6475
Polarity:	Horizontal	Test Voltage:	AC 120V_60Hz

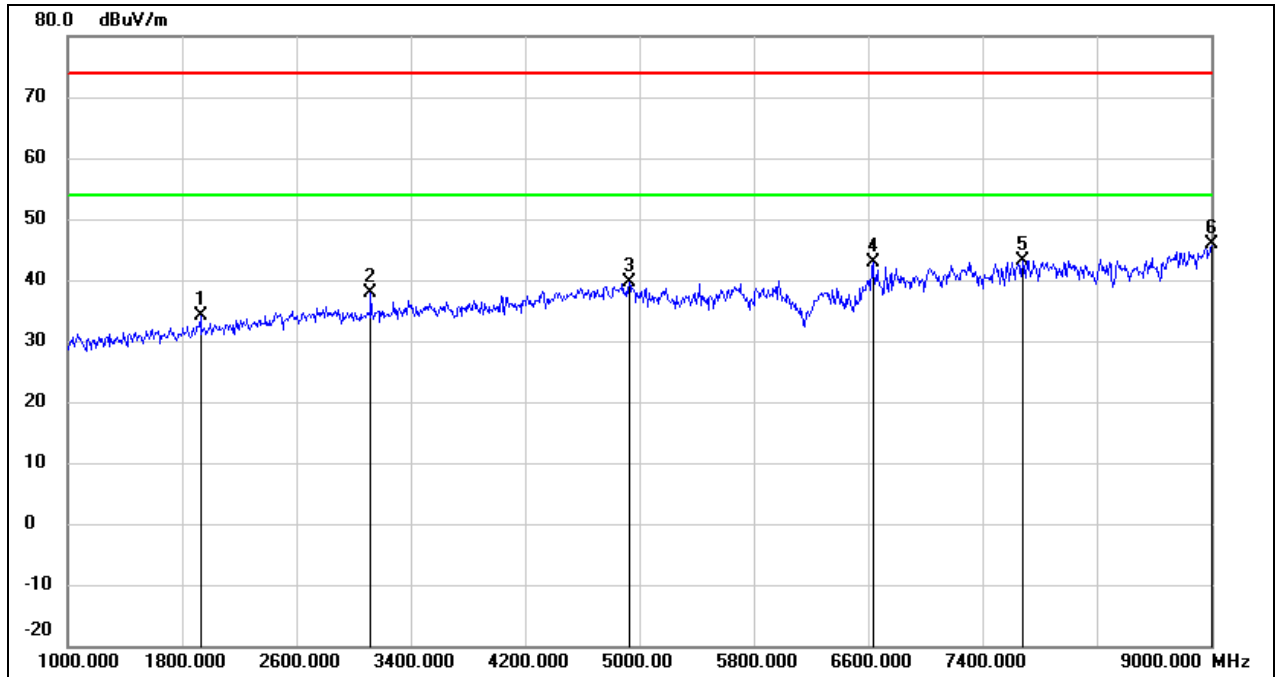

No.	Frequency (MHz)	Reading (dBuV)	Correct (dB/m)	Result (dBuV/m)	Limit (dBuV/m)	Margin (dB)	Remark
1	1928.000	45.44	-11.29	34.15	74.00	-39.85	peak
2	3120.000	44.60	-6.71	37.89	74.00	-36.11	peak
3	4928.000	40.10	-0.44	39.66	74.00	-34.34	peak
4	6632.000	38.43	4.38	42.81	74.00	-31.19	peak
5	7680.000	37.57	5.68	43.25	74.00	-30.75	peak
6	9000.000	36.04	9.74	45.78	74.00	-28.22	peak

Test Mode:	802.11ax HE20	Channel:	6475
Polarity:	Vertical	Test Voltage:	AC 120V_60Hz

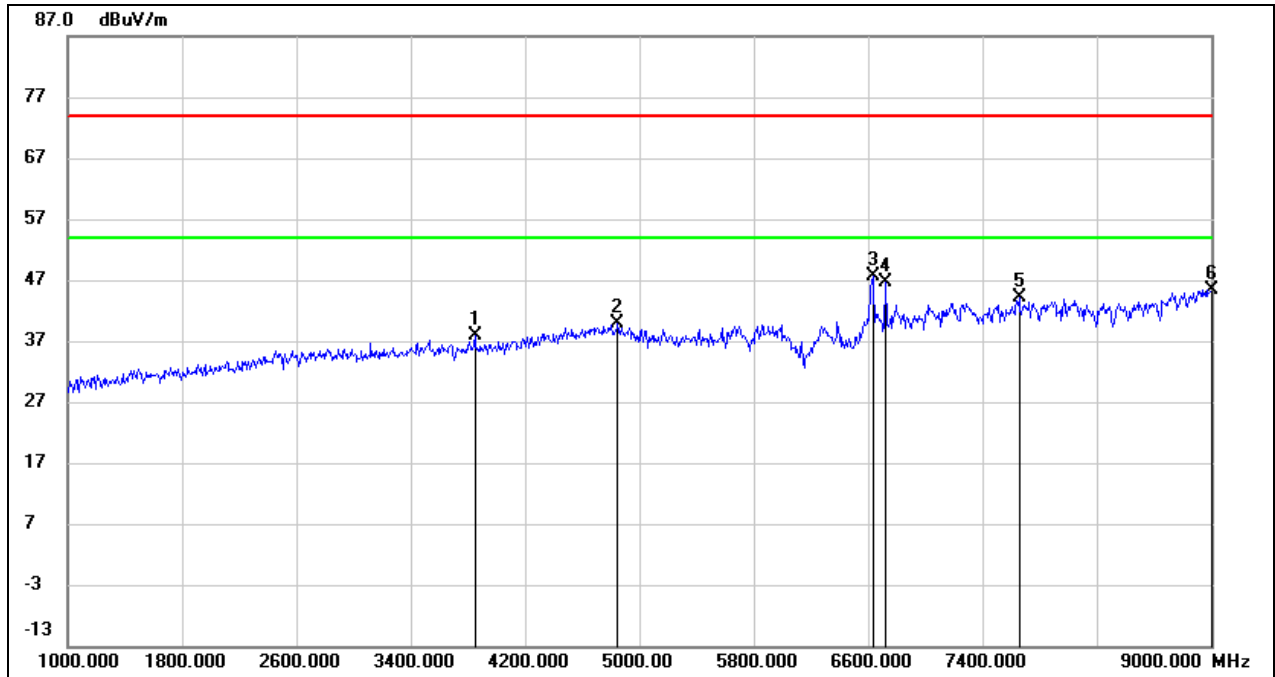

No.	Frequency (MHz)	Reading (dBuV)	Correct (dB/m)	Result (dBuV/m)	Limit (dBuV/m)	Margin (dB)	Remark
1	3848.000	42.81	-4.89	37.92	74.00	-36.08	peak
2	4848.000	40.58	-0.76	39.82	74.00	-34.18	peak
3	6632.000	43.25	4.38	47.63	74.00	-26.37	peak
4	6720.000	41.72	4.81	46.53	74.00	-27.47	peak
5	7656.000	38.48	5.67	44.15	74.00	-29.85	peak
6	9000.000	35.74	9.74	45.48	74.00	-28.52	peak

Test Mode:	802.11ax HE20	Channel:	6515
Polarity:	Horizontal	Test Voltage:	AC 120V_60Hz

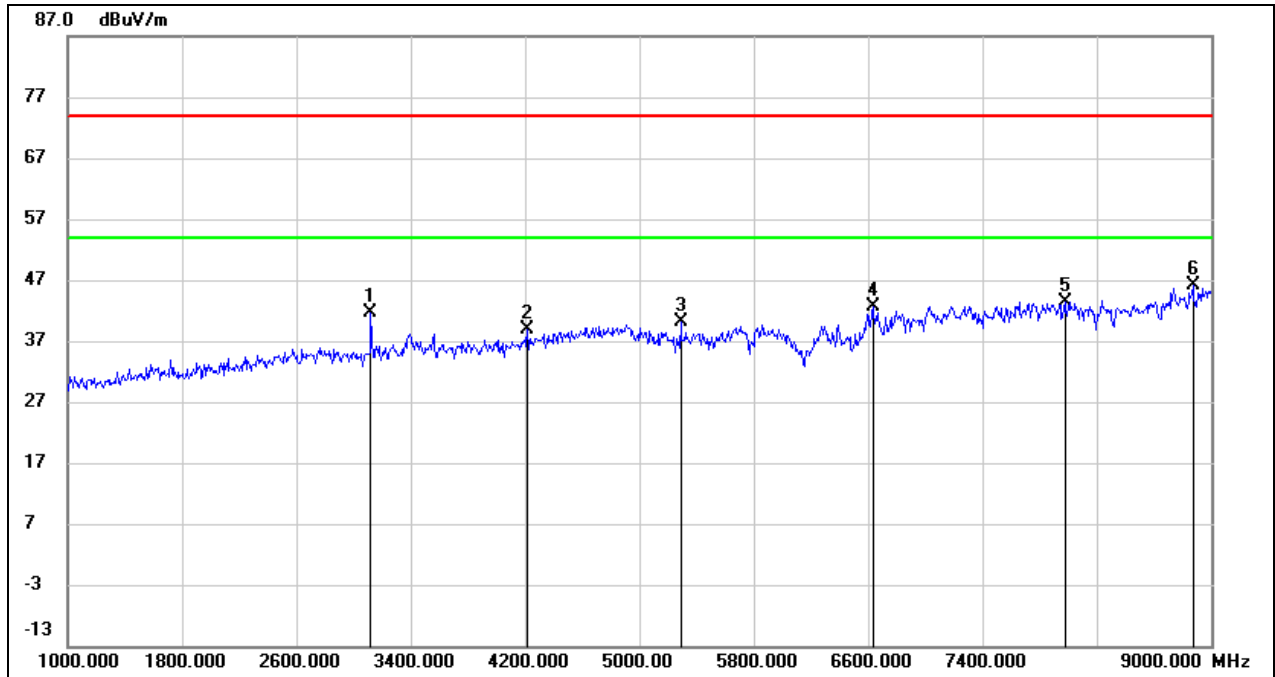

No.	Frequency (MHz)	Reading (dBuV)	Correct (dB/m)	Result (dBuV/m)	Limit (dBuV/m)	Margin (dB)	Remark
1	3120.000	48.28	-6.71	41.57	74.00	-32.43	peak
2	4216.000	42.28	-3.47	38.81	74.00	-35.19	peak
3	5288.000	40.07	0.18	40.25	74.00	-33.75	peak
4	6632.000	38.14	4.38	42.52	74.00	-31.48	peak
5	7976.000	37.77	5.65	43.42	74.00	-30.58	peak
6	8872.000	37.16	8.85	46.01	74.00	-27.99	peak

Test Mode:	802.11ax HE20	Channel:	6515
Polarity:	Vertical	Test Voltage:	AC 120V_60Hz

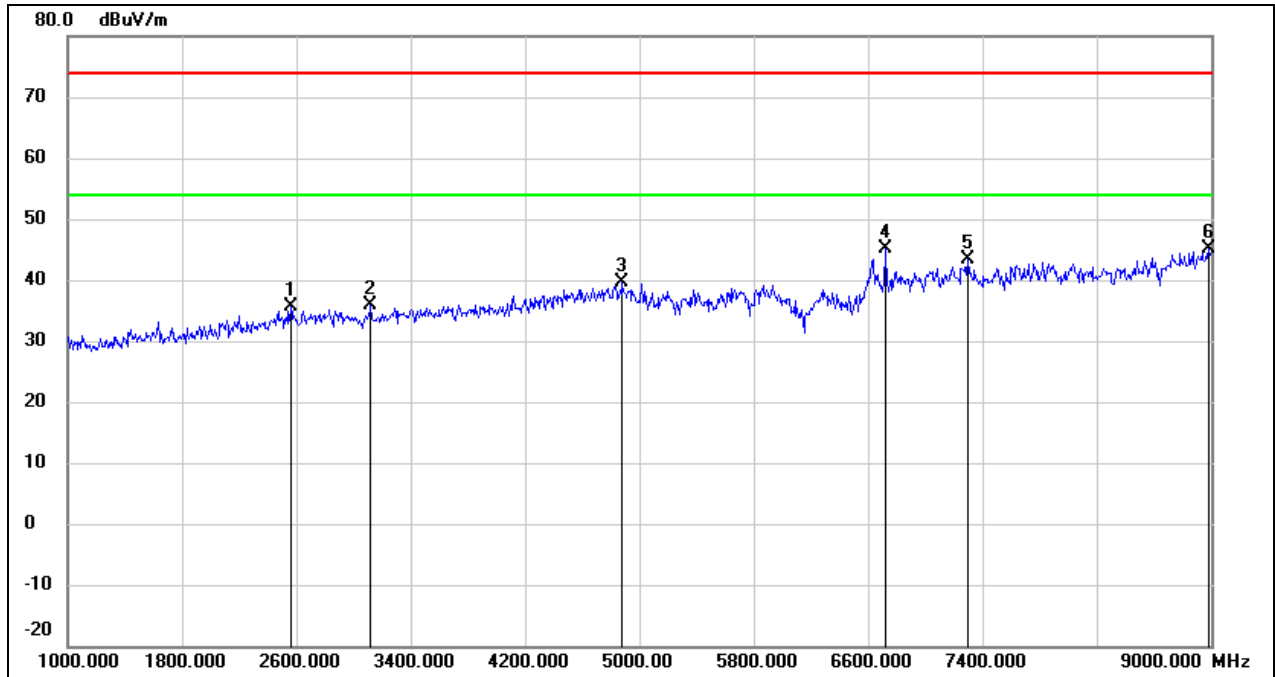

No.	Frequency (MHz)	Reading (dBuV)	Correct (dB/m)	Result (dBuV/m)	Limit (dBuV/m)	Margin (dB)	Remark
1	2560.000	43.87	-8.31	35.56	74.00	-38.44	peak
2	3120.000	42.52	-6.71	35.81	74.00	-38.19	peak
3	4880.000	40.15	-0.63	39.52	74.00	-34.48	peak
4	6720.000	40.44	4.81	45.25	74.00	-28.75	peak
5	7296.000	37.48	5.90	43.38	74.00	-30.62	peak
6	8984.000	35.55	9.62	45.17	74.00	-28.83	peak

Test Mode:	802.11ax HE20	Channel:	6535
Polarity:	Horizontal	Test Voltage:	AC 120V_60Hz

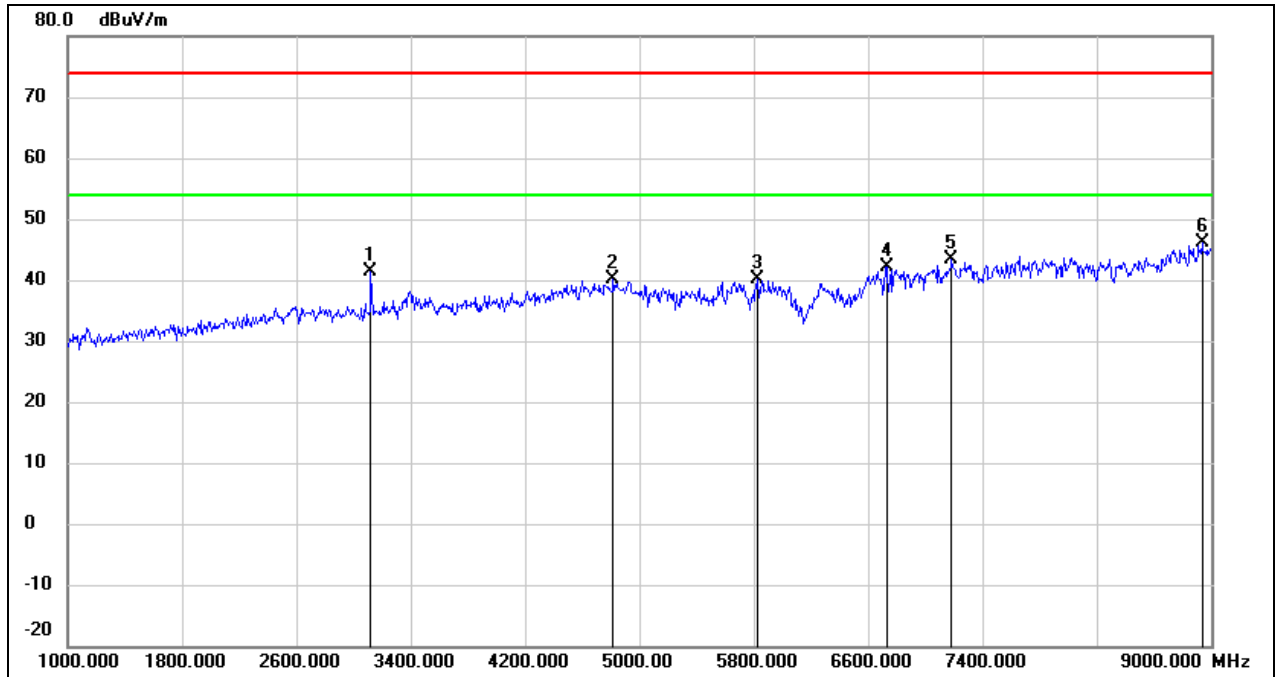

No.	Frequency (MHz)	Reading (dBuV)	Correct (dB/m)	Result (dBuV/m)	Limit (dBuV/m)	Margin (dB)	Remark
1	3120.000	47.97	-6.71	41.26	74.00	-32.74	peak
2	4816.000	40.95	-0.89	40.06	74.00	-33.94	peak
3	5824.000	38.85	1.34	40.19	74.00	-33.81	peak
4	6728.000	37.33	4.85	42.18	74.00	-31.82	peak
5	7184.000	37.42	6.01	43.43	74.00	-30.57	peak
6	8936.000	36.91	9.29	46.20	74.00	-27.80	peak

Test Mode:	802.11ax HE20	Channel:	6535
Polarity:	Vertical	Test Voltage:	AC 120V_60Hz

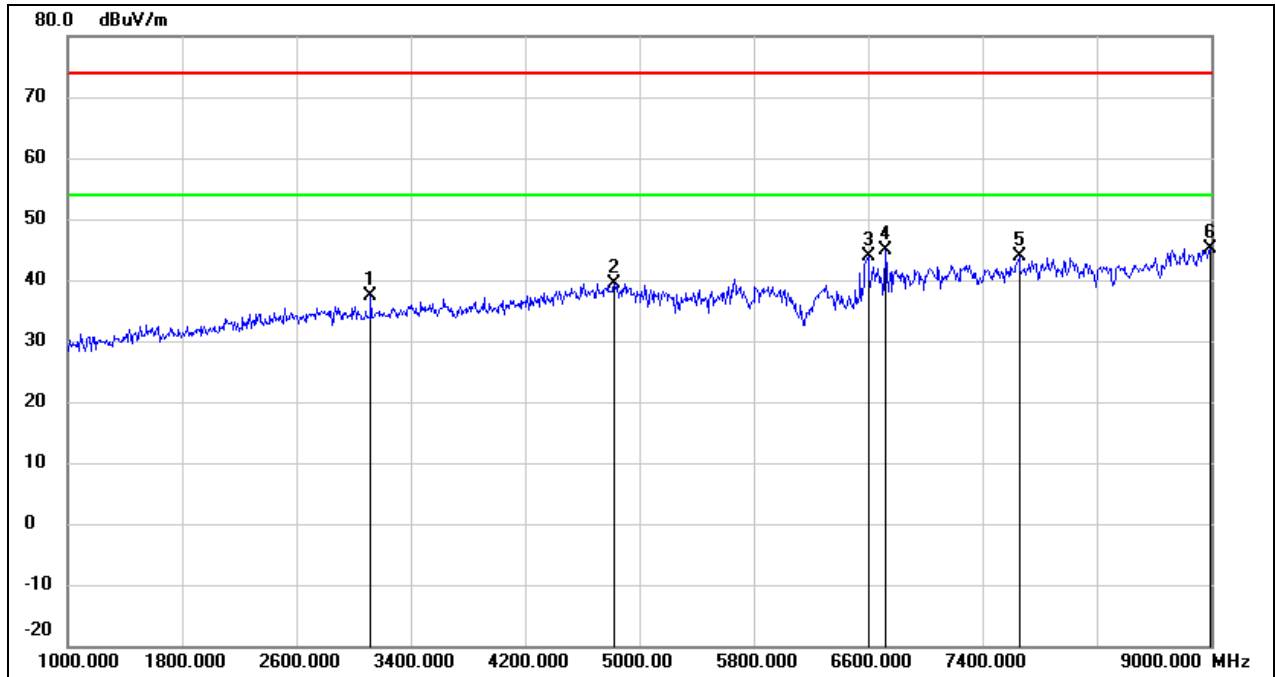

No.	Frequency (MHz)	Reading (dBuV)	Correct (dB/m)	Result (dBuV/m)	Limit (dBuV/m)	Margin (dB)	Remark
1	3120.000	44.08	-6.71	37.37	74.00	-36.63	peak
2	4824.000	40.29	-0.85	39.44	74.00	-34.56	peak
3	6600.000	39.61	4.22	43.83	74.00	-30.17	peak
4	6720.000	40.17	4.81	44.98	74.00	-29.02	peak
5	7656.000	38.24	5.67	43.91	74.00	-30.09	peak
6	8992.000	35.45	9.68	45.13	74.00	-28.87	peak

Test Mode:	802.11ax HE20	Channel:	6715
Polarity:	Horizontal	Test Voltage:	AC 120V_60Hz

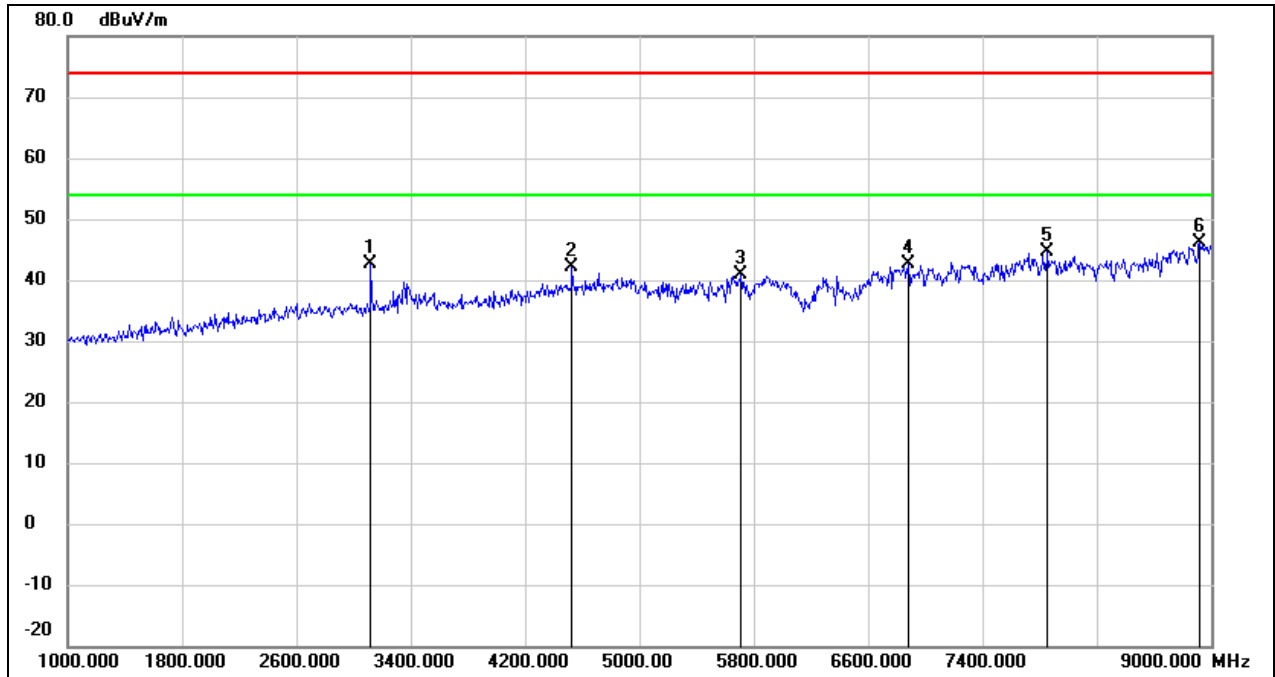

No.	Frequency (MHz)	Reading (dBuV)	Correct (dB/m)	Result (dBuV/m)	Limit (dBuV/m)	Margin (dB)	Remark
1	3120.000	49.39	-6.71	42.68	74.00	-31.32	peak
2	4528.000	44.09	-2.03	42.06	74.00	-31.94	peak
3	5712.000	39.81	1.02	40.83	74.00	-33.17	peak
4	6880.000	37.08	5.60	42.68	74.00	-31.32	peak
5	7856.000	38.94	5.65	44.59	74.00	-29.41	peak
6	8920.000	36.98	9.17	46.15	74.00	-27.85	peak

Test Mode:	802.11ax HE20	Channel:	6715
Polarity:	Vertical	Test Voltage:	AC 120V_60Hz

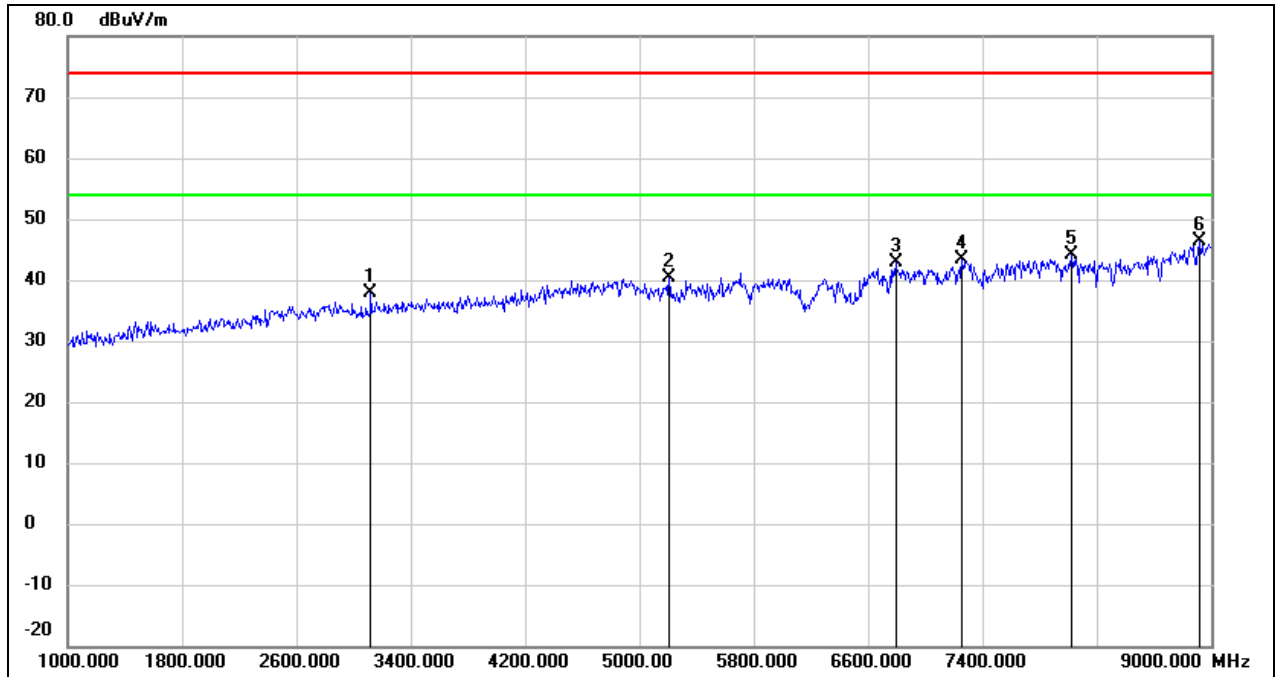

No.	Frequency (MHz)	Reading (dBuV)	Correct (dB/m)	Result (dBuV/m)	Limit (dBuV/m)	Margin (dB)	Remark
1	3120.000	44.69	-6.71	37.98	74.00	-36.02	peak
2	5208.000	40.35	0.09	40.44	74.00	-33.56	peak
3	6792.000	37.59	5.18	42.77	74.00	-31.23	peak
4	7256.000	37.40	5.94	43.34	74.00	-30.66	peak
5	8024.000	38.33	5.68	44.01	74.00	-29.99	peak
6	8920.000	37.27	9.17	46.44	74.00	-27.56	peak

Test Mode:	802.11ax HE20	Channel:	6875
Polarity:	Horizontal	Test Voltage:	AC 120V_60Hz

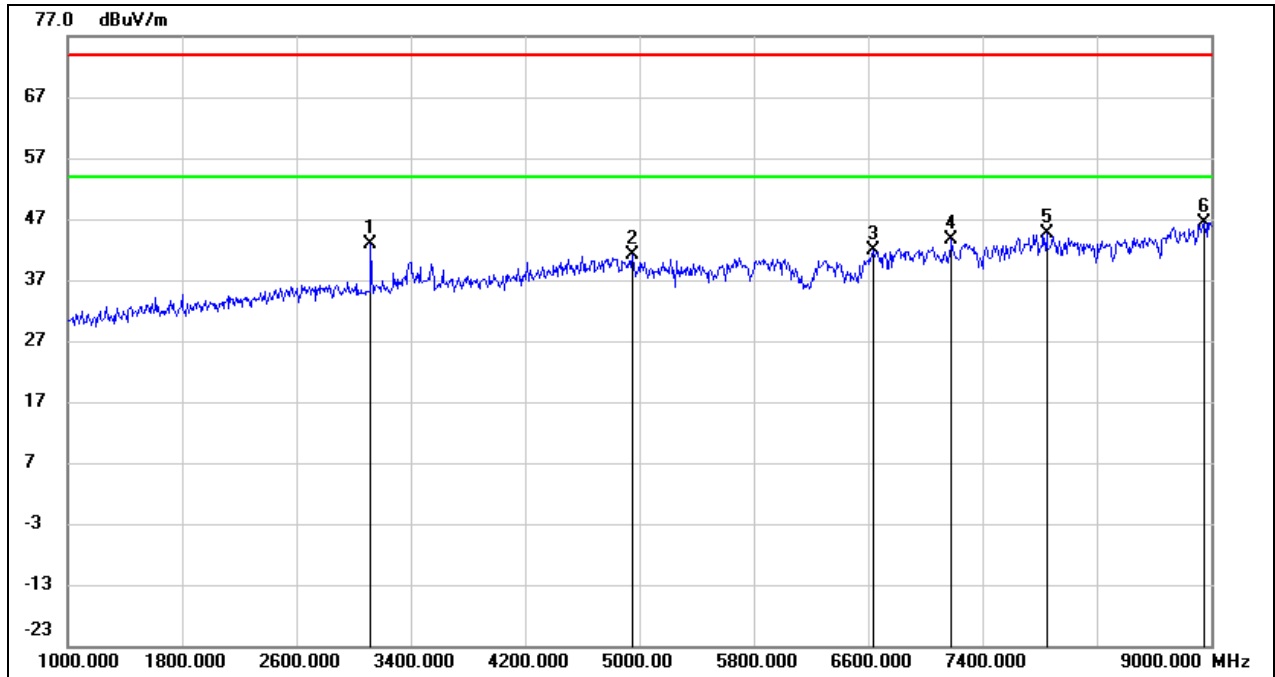

No.	Frequency (MHz)	Reading (dBuV)	Correct (dB/m)	Result (dBuV/m)	Limit (dBuV/m)	Margin (dB)	Remark
1	3120.000	49.67	-6.71	42.96	74.00	-31.04	peak
2	4952.000	41.37	-0.34	41.03	74.00	-32.97	peak
3	6632.000	37.47	4.38	41.85	74.00	-32.15	peak
4	7184.000	37.53	6.01	43.54	74.00	-30.46	peak
5	7848.000	38.98	5.67	44.65	74.00	-29.35	peak
6	8952.000	36.91	9.40	46.31	74.00	-27.69	peak

Test Mode:	802.11ax HE20	Channel:	6875
Polarity:	Vertical	Test Voltage:	AC 120V_60Hz

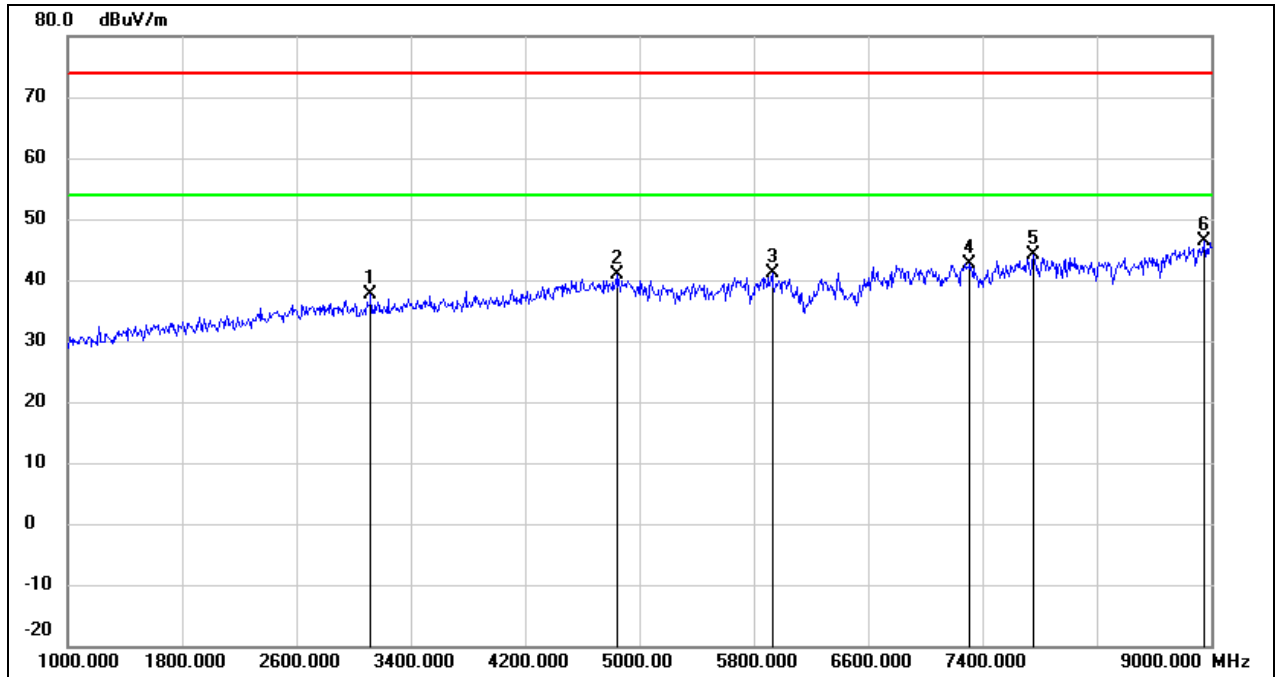

No.	Frequency (MHz)	Reading (dBuV)	Correct (dB/m)	Result (dBuV/m)	Limit (dBuV/m)	Margin (dB)	Remark
1	3120.000	44.36	-6.71	37.65	74.00	-36.35	peak
2	4840.000	41.54	-0.78	40.76	74.00	-33.24	peak
3	5928.000	39.41	1.64	41.05	74.00	-32.95	peak
4	7312.000	36.75	5.88	42.63	74.00	-31.37	peak
5	7752.000	38.49	5.66	44.15	74.00	-29.85	peak
6	8952.000	36.91	9.40	46.31	74.00	-27.69	peak

Test Mode:	802.11ax HE20	Channel:	6895
Polarity:	Horizontal	Test Voltage:	AC 120V_60Hz

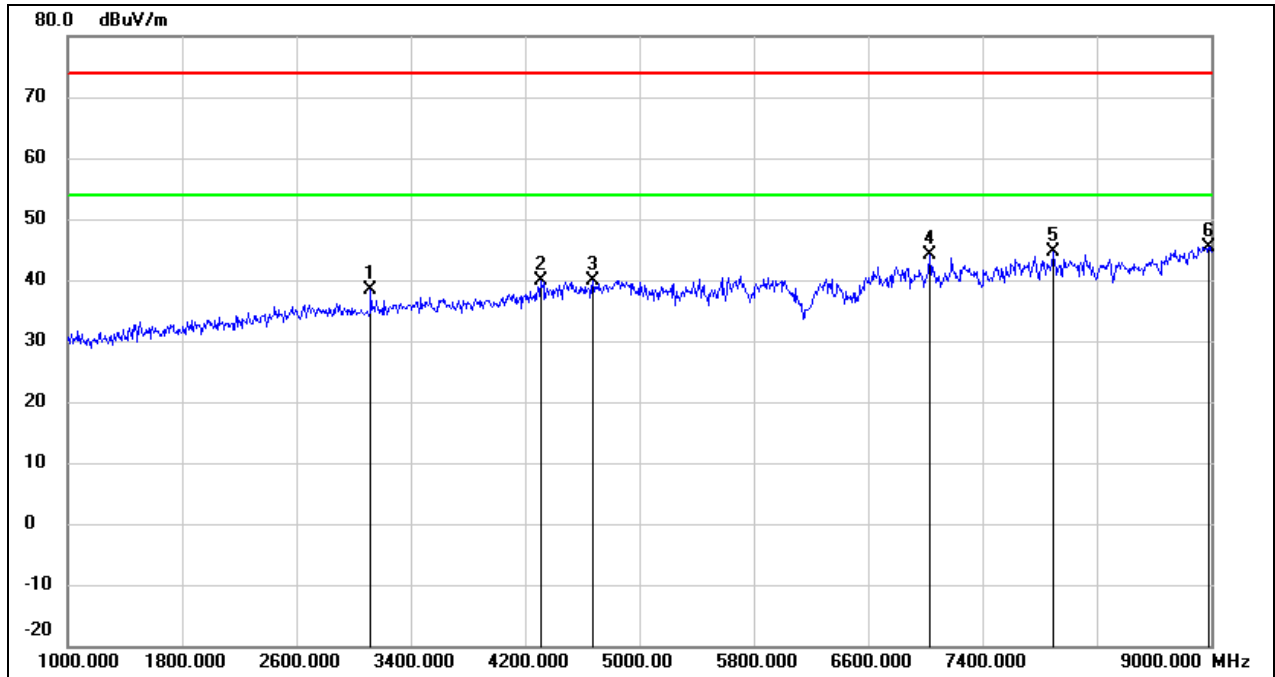

No.	Frequency (MHz)	Reading (dBuV)	Correct (dB/m)	Result (dBuV/m)	Limit (dBuV/m)	Margin (dB)	Remark
1	3120.000	45.04	-6.71	38.33	74.00	-35.67	peak
2	4312.000	42.93	-3.02	39.91	74.00	-34.09	peak
3	4672.000	41.42	-1.46	39.96	74.00	-34.04	peak
4	7032.000	37.98	6.17	44.15	74.00	-29.85	peak
5	7896.000	39.06	5.66	44.72	74.00	-29.28	peak
6	8984.000	35.85	9.62	45.47	74.00	-28.53	peak

Test Mode:	802.11ax HE20	Channel:	6895
Polarity:	Vertical	Test Voltage:	AC 120V_60Hz

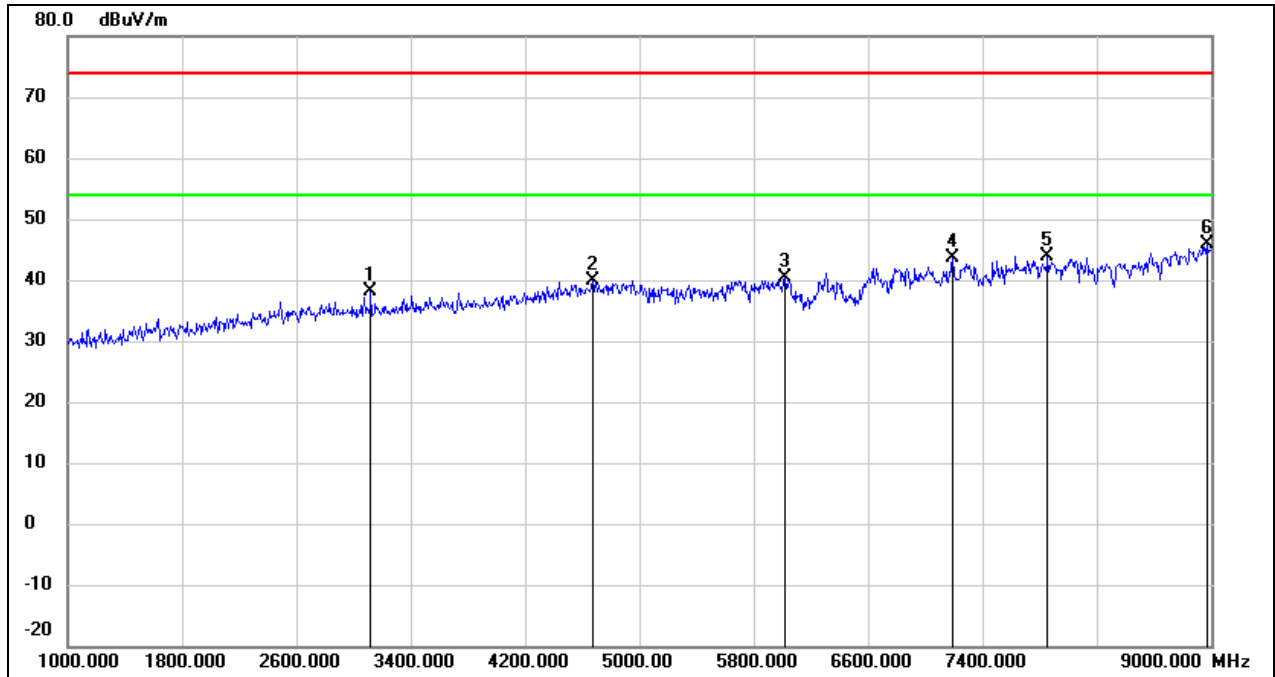

No.	Frequency (MHz)	Reading (dBuV)	Correct (dB/m)	Result (dBuV/m)	Limit (dBuV/m)	Margin (dB)	Remark
1	3120.000	44.87	-6.71	38.16	74.00	-35.84	peak
2	4672.000	41.35	-1.46	39.89	74.00	-34.11	peak
3	6016.000	38.57	1.91	40.48	74.00	-33.52	peak
4	7192.000	37.56	6.00	43.56	74.00	-30.44	peak
5	7856.000	38.21	5.65	43.86	74.00	-30.14	peak
6	8968.000	36.48	9.51	45.99	74.00	-28.01	peak

Test Mode:	802.11ax HE20	Channel:	7015
Polarity:	Horizontal	Test Voltage:	AC 120V_60Hz

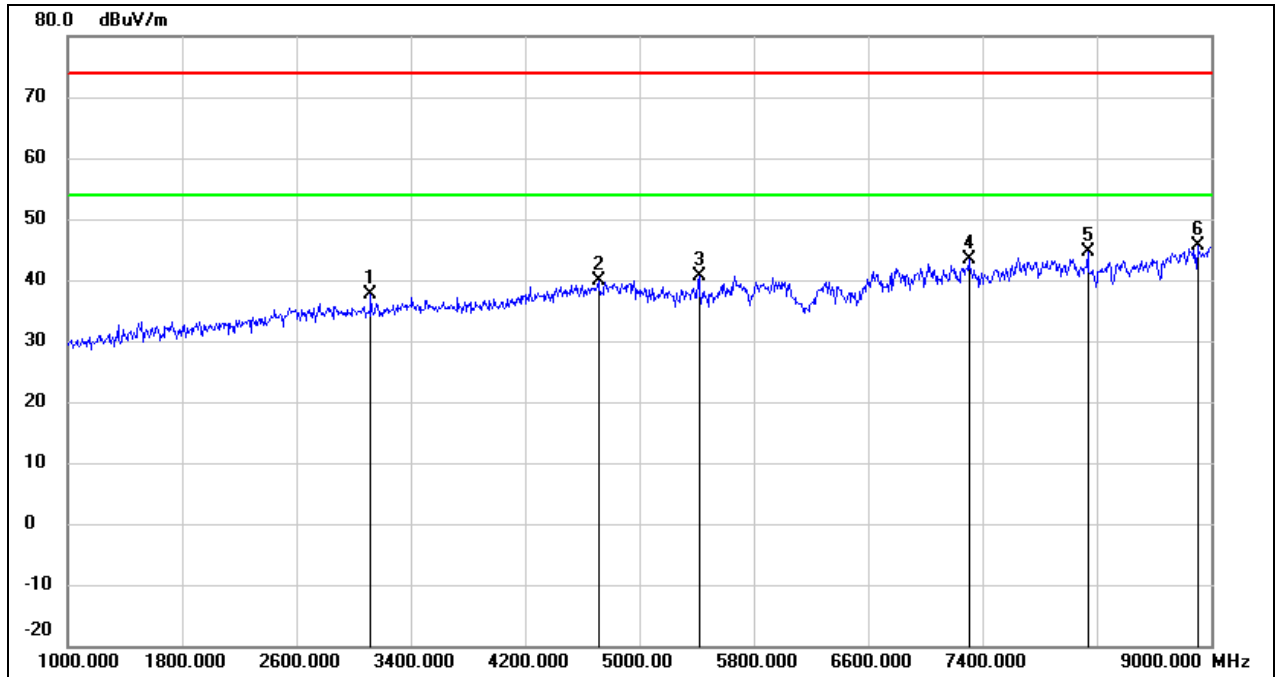

No.	Frequency (MHz)	Reading (dBuV)	Correct (dB/m)	Result (dBuV/m)	Limit (dBuV/m)	Margin (dB)	Remark
1	3120.000	44.45	-6.71	37.74	74.00	-36.26	peak
2	4712.000	41.10	-1.29	39.81	74.00	-34.19	peak
3	5416.000	40.31	0.32	40.63	74.00	-33.37	peak
4	7304.000	37.56	5.89	43.45	74.00	-30.55	peak
5	8136.000	38.82	5.81	44.63	74.00	-29.37	peak
6	8904.000	36.51	9.06	45.57	74.00	-28.43	peak

Test Mode:	802.11ax HE20	Channel:	7015
Polarity:	Vertical	Test Voltage:	AC 120V_60Hz

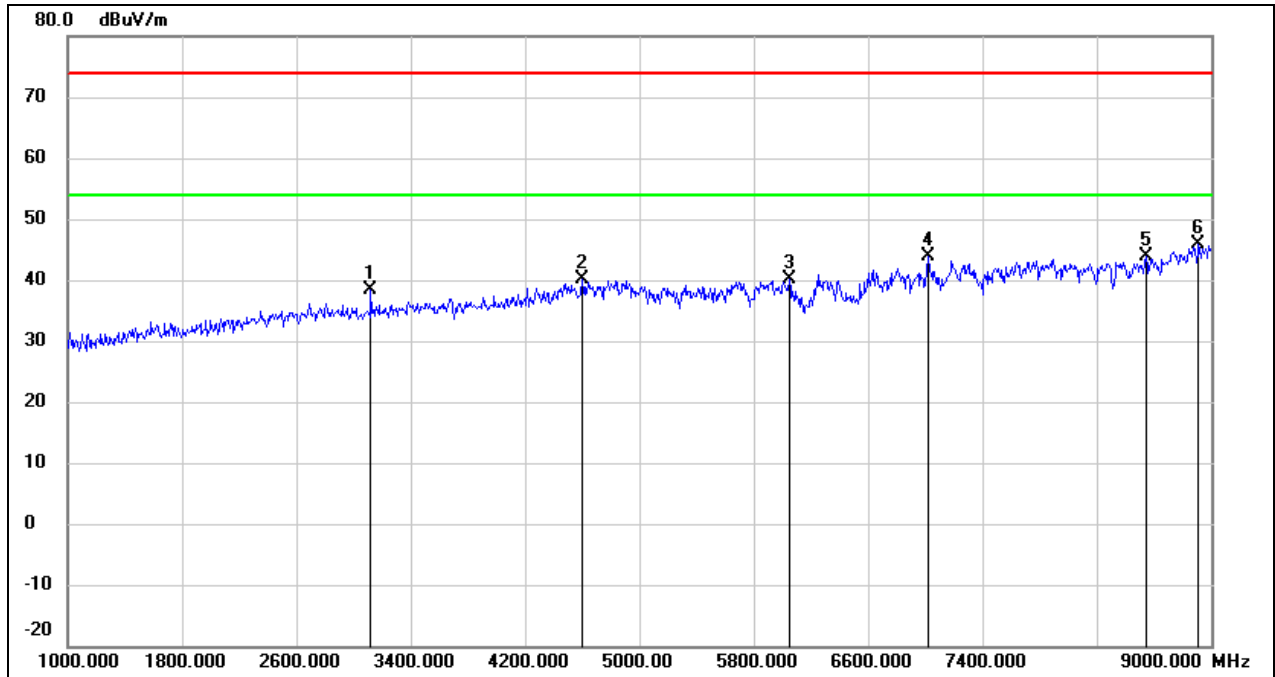

No.	Frequency (MHz)	Reading (dBuV)	Correct (dB/m)	Result (dBuV/m)	Limit (dBuV/m)	Margin (dB)	Remark
1	3120.000	45.04	-6.71	38.33	74.00	-35.67	peak
2	4600.000	41.78	-1.74	40.04	74.00	-33.96	peak
3	6048.000	38.14	2.03	40.17	74.00	-33.83	peak
4	7024.000	37.62	6.18	43.80	74.00	-30.20	peak
5	8544.000	37.36	6.54	43.90	74.00	-30.10	peak
6	8912.000	36.71	9.11	45.82	74.00	-28.18	peak

Test Mode:	802.11ax HE20	Channel:	7095
Polarity:	Horizontal	Test Voltage:	AC 120V_60Hz

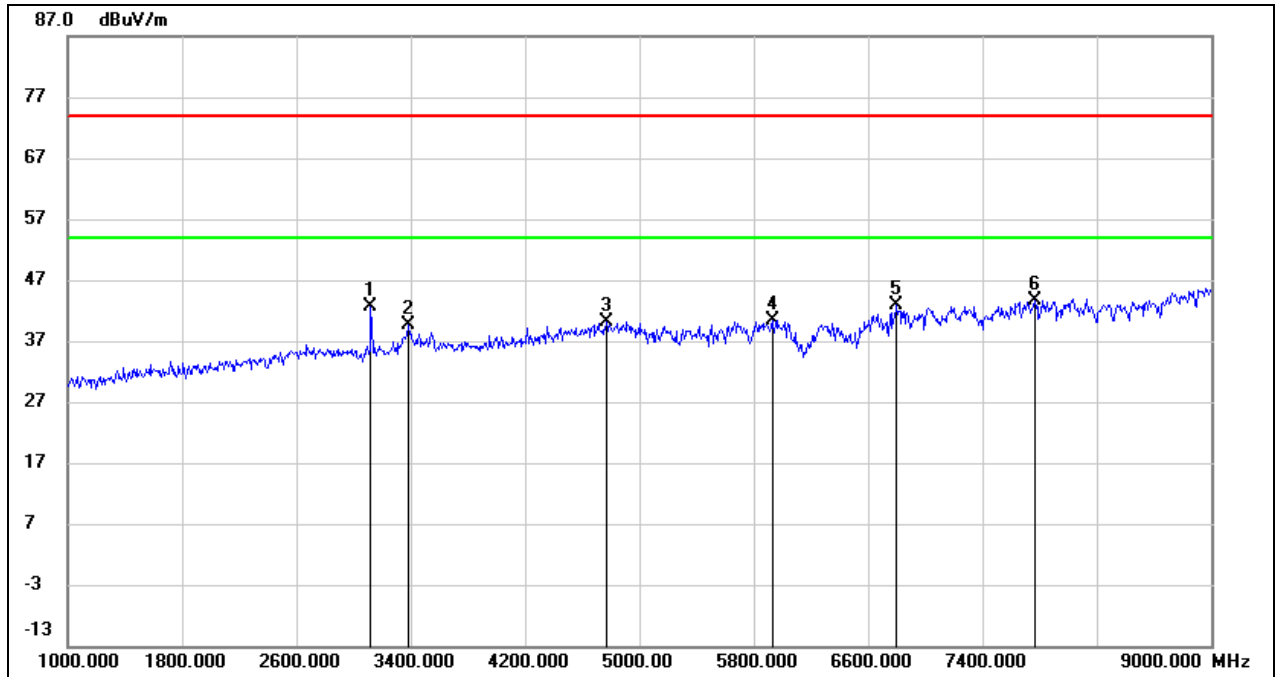

No.	Frequency (MHz)	Reading (dBuV)	Correct (dB/m)	Result (dBuV/m)	Limit (dBuV/m)	Margin (dB)	Remark
1	3120.000	49.40	-6.71	42.69	74.00	-31.31	peak
2	3384.000	45.67	-6.12	39.55	74.00	-34.45	peak
3	4768.000	41.21	-1.07	40.14	74.00	-33.86	peak
4	5928.000	38.80	1.64	40.44	74.00	-33.56	peak
5	6800.000	37.61	5.21	42.82	74.00	-31.18	peak
6	7768.000	37.88	5.66	43.54	74.00	-30.46	peak

Test Mode:	802.11ax HE20	Channel:	7095
Polarity:	Vertical	Test Voltage:	AC 120V_60Hz

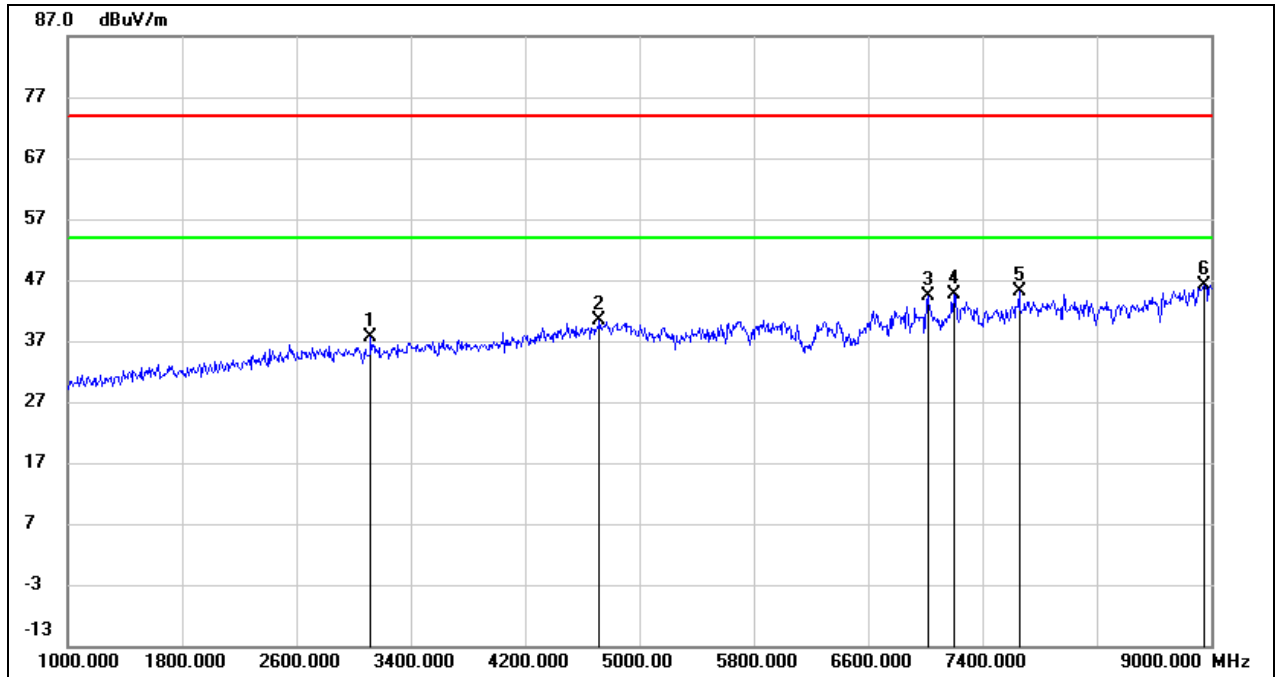

No.	Frequency (MHz)	Reading (dBuV)	Correct (dB/m)	Result (dBuV/m)	Limit (dBuV/m)	Margin (dB)	Remark
1	3120.000	44.32	-6.71	37.61	74.00	-36.39	peak
2	4720.000	41.68	-1.27	40.41	74.00	-33.59	peak
3	7016.000	38.12	6.19	44.31	74.00	-29.69	peak
4	7200.000	38.63	6.00	44.63	74.00	-29.37	peak
5	7656.000	39.38	5.67	45.05	74.00	-28.95	peak
6	8952.000	36.81	9.40	46.21	74.00	-27.79	peak

Test Mode:	802.11ax HE20	Channel:	7115
Polarity:	Horizontal	Test Voltage:	AC 120V_60Hz

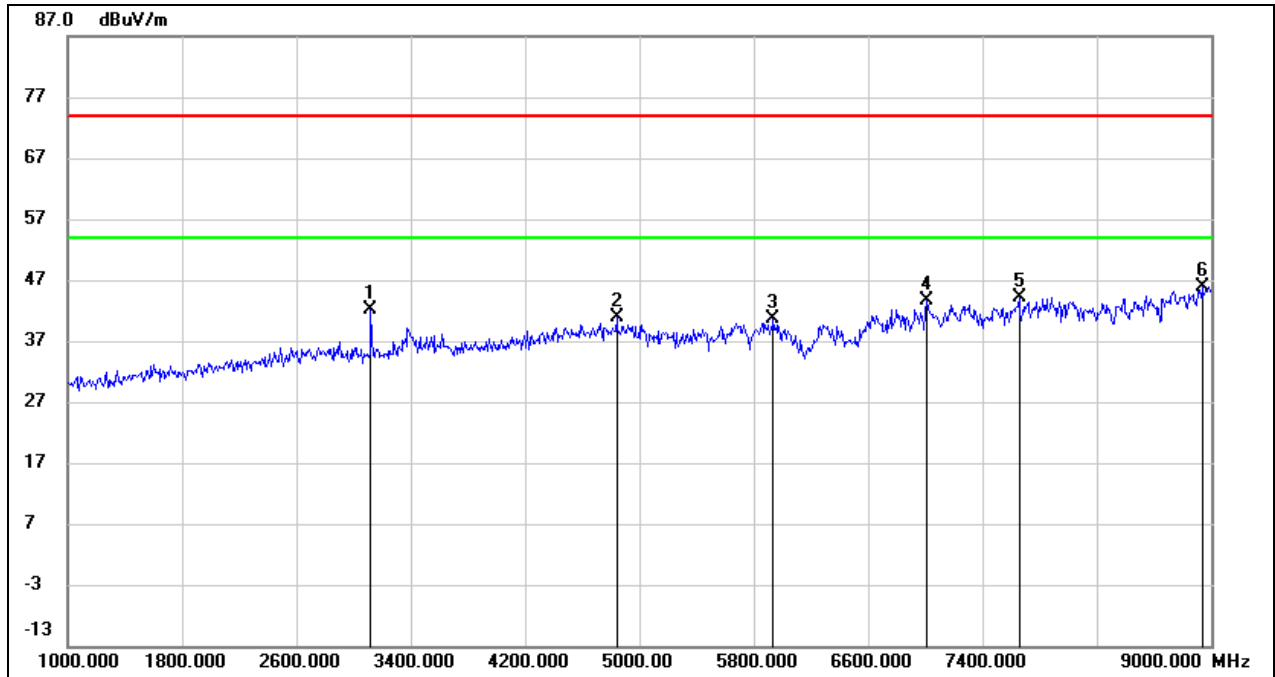

No.	Frequency (MHz)	Reading (dBuV)	Correct (dB/m)	Result (dBuV/m)	Limit (dBuV/m)	Margin (dB)	Remark
1	3120.000	48.84	-6.71	42.13	74.00	-31.87	peak
2	4840.000	41.56	-0.78	40.78	74.00	-33.22	peak
3	5936.000	39.06	1.67	40.73	74.00	-33.27	peak
4	7008.000	37.53	6.19	43.72	74.00	-30.28	peak
5	7656.000	38.49	5.67	44.16	74.00	-29.84	peak
6	8936.000	36.49	9.29	45.78	74.00	-28.22	peak

Test Mode:	802.11ax HE20	Channel:	7115
Polarity:	Vertical	Test Voltage:	AC 120V_60Hz

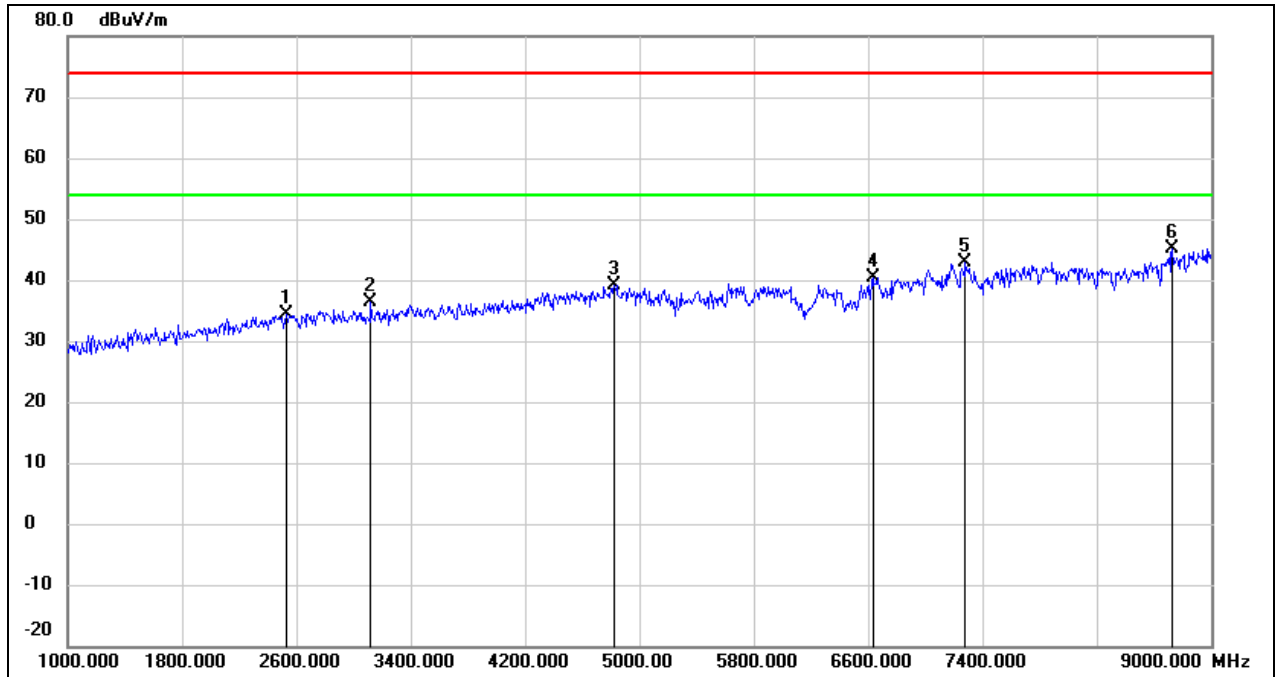

No.	Frequency (MHz)	Reading (dBuV)	Correct (dB/m)	Result (dBuV/m)	Limit (dBuV/m)	Margin (dB)	Remark
1	2528.000	42.81	-8.41	34.40	74.00	-39.60	peak
2	3120.000	43.08	-6.71	36.37	74.00	-37.63	peak
3	4824.000	39.95	-0.85	39.10	74.00	-34.90	peak
4	6632.000	36.03	4.38	40.41	74.00	-33.59	peak
5	7280.000	36.84	5.92	42.76	74.00	-31.24	peak
6	8728.000	37.22	7.83	45.05	74.00	-28.95	peak

8.3. SPURIOUS EMISSIONS(9 GHZ~18 GHZ)

Test Mode:	802.11ax HE20	Channel:	6115
Polarity:	Horizontal	Test Voltage:	AC 120V_60Hz

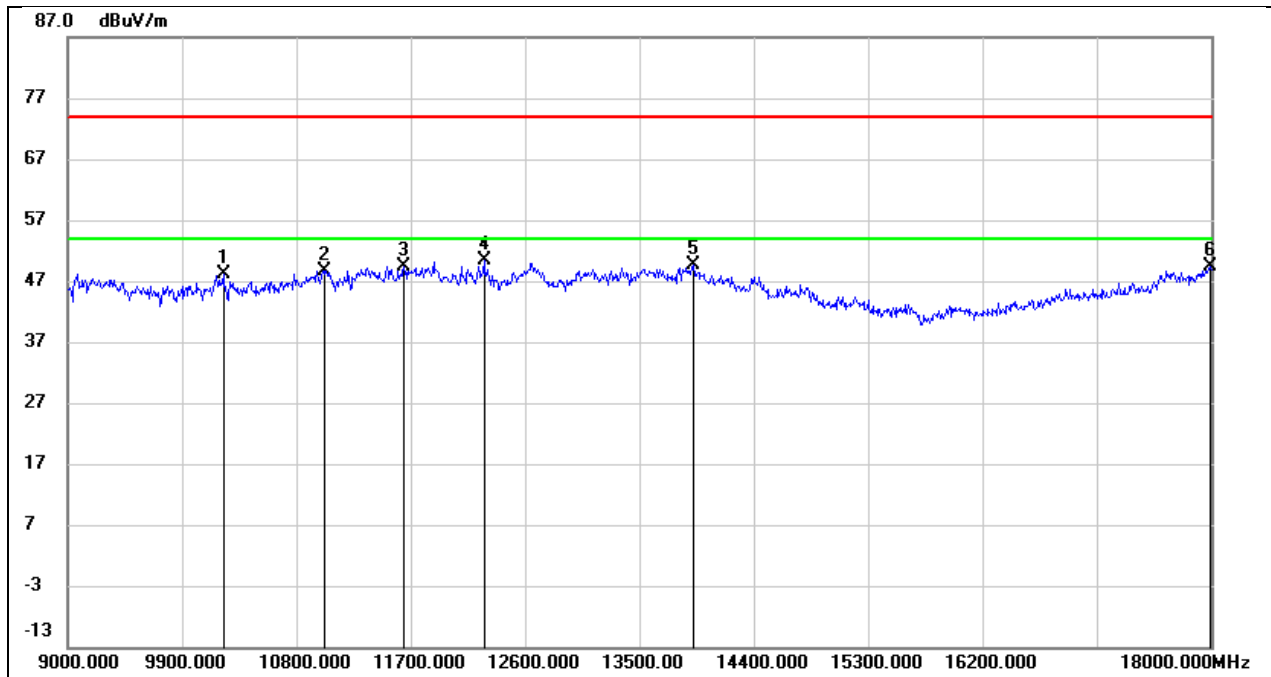

No.	Frequency (MHz)	Reading (dBuV)	Correct (dB/m)	Result (dBuV/m)	Limit (dBuV/m)	Margin (dB)	Remark
1	10224.000	35.52	12.55	48.07	74.00	-25.93	peak
2	11016.000	33.92	14.81	48.73	74.00	-25.27	peak
3	11646.000	32.46	16.94	49.40	74.00	-24.60	peak
4	12276.000	32.62	17.70	50.32	74.00	-23.68	peak
5	13923.000	27.87	21.72	49.59	74.00	-24.41	peak
6	17991.000	24.19	25.11	49.30	74.00	-24.70	peak

Test Mode:	802.11ax HE20	Channel:	6115
Polarity:	Vertical	Test Voltage:	AC 120V_60Hz

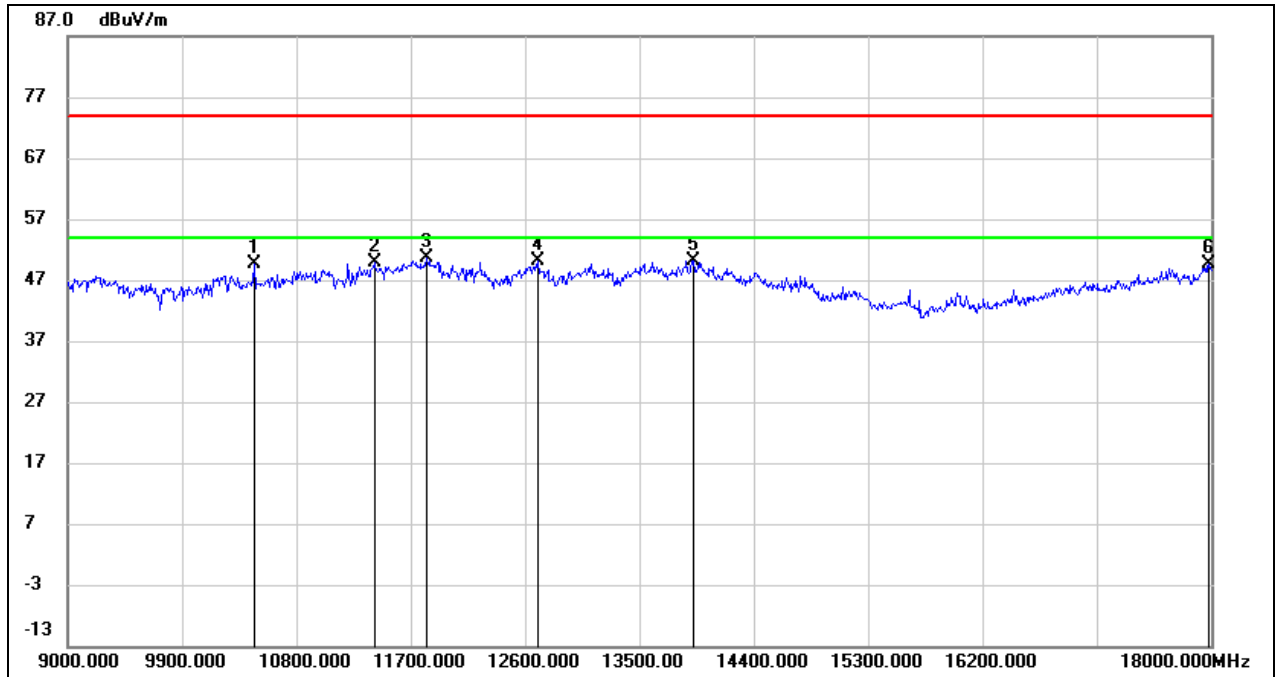

No.	Frequency (MHz)	Reading (dBuV)	Correct (dB/m)	Result (dBuV/m)	Limit (dBuV/m)	Margin (dB)	Remark
1	10467.000	36.51	13.05	49.56	74.00	-24.44	peak
2	11412.000	33.66	16.22	49.88	74.00	-24.12	peak
3	11826.000	33.30	17.42	50.72	74.00	-23.28	peak
4	12699.000	32.05	18.07	50.12	74.00	-23.88	peak
5	13923.000	28.50	21.72	50.22	74.00	-23.78	peak
6	17982.000	24.48	25.04	49.52	74.00	-24.48	peak

Test Mode:	802.11ax HE20	Channel:	6275
Polarity:	Horizontal	Test Voltage:	AC 120V_60Hz

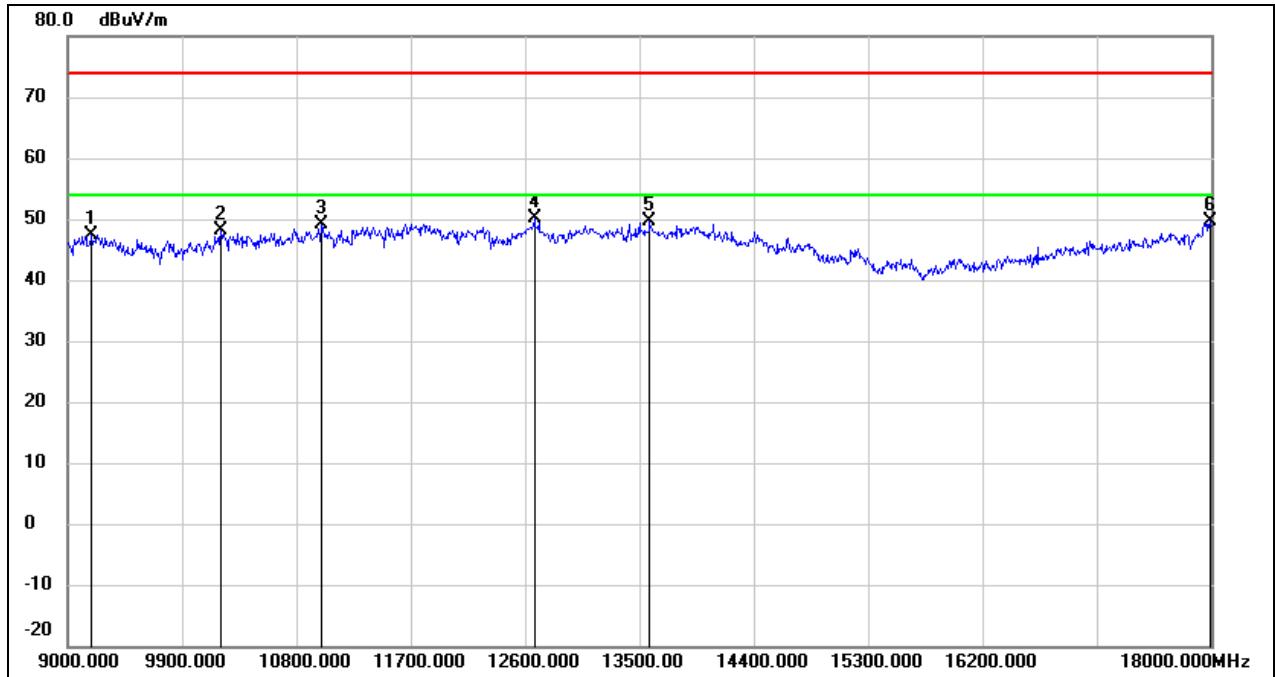

No.	Frequency (MHz)	Reading (dBuV)	Correct (dB/m)	Result (dBuV/m)	Limit (dBuV/m)	Margin (dB)	Remark
1	9189.000	36.57	10.84	47.41	74.00	-26.59	peak
2	10206.000	35.67	12.51	48.18	74.00	-25.82	peak
3	10998.000	34.34	14.75	49.09	74.00	-24.91	peak
4	12672.000	32.08	18.00	50.08	74.00	-23.92	peak
5	13581.000	28.53	20.99	49.52	74.00	-24.48	peak
6	17991.000	24.64	25.11	49.75	74.00	-24.25	peak

Test Mode:	802.11ax HE20	Channel:	6275
Polarity:	Vertical	Test Voltage:	AC 120V_60Hz

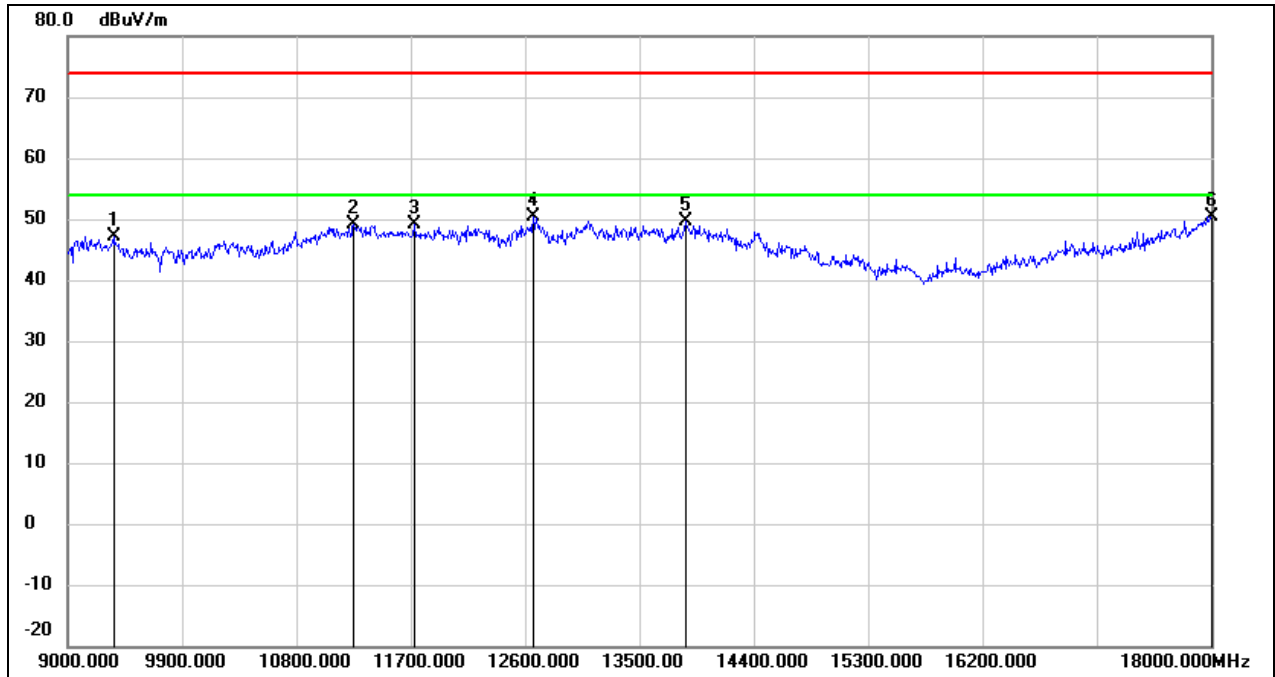

No.	Frequency (MHz)	Reading (dBuV)	Correct (dB/m)	Result (dBuV/m)	Limit (dBuV/m)	Margin (dB)	Remark
1	9360.000	36.37	10.87	47.24	74.00	-26.76	peak
2	11250.000	33.37	15.64	49.01	74.00	-24.99	peak
3	11727.000	31.87	17.16	49.03	74.00	-24.97	peak
4	12663.000	32.37	17.98	50.35	74.00	-23.65	peak
5	13869.000	27.93	21.59	49.52	74.00	-24.48	peak
6	18000.000	25.32	25.16	50.48	74.00	-23.52	peak

Test Mode:	802.11ax HE20	Channel:	6415
Polarity:	Horizontal	Test Voltage:	AC 120V_60Hz

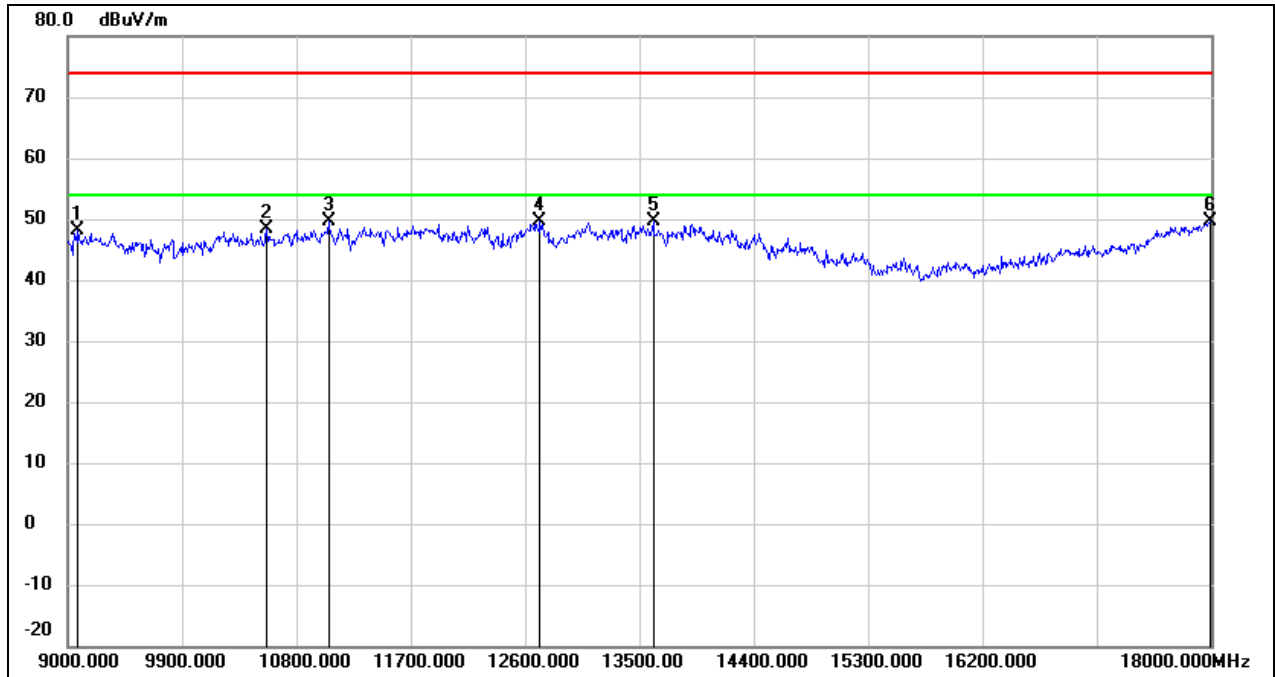

No.	Frequency (MHz)	Reading (dBuV)	Correct (dB/m)	Result (dBuV/m)	Limit (dBuV/m)	Margin (dB)	Remark
1	9081.000	37.37	10.82	48.19	74.00	-25.81	peak
2	10566.000	35.02	13.33	48.35	74.00	-25.65	peak
3	11052.000	34.65	14.94	49.59	74.00	-24.41	peak
4	12717.000	31.47	18.11	49.58	74.00	-24.42	peak
5	13608.000	28.54	21.05	49.59	74.00	-24.41	peak
6	17991.000	24.52	25.11	49.63	74.00	-24.37	peak

Test Mode:	802.11ax HE20	Channel:	6415
Polarity:	Vertical	Test Voltage:	AC 120V_60Hz

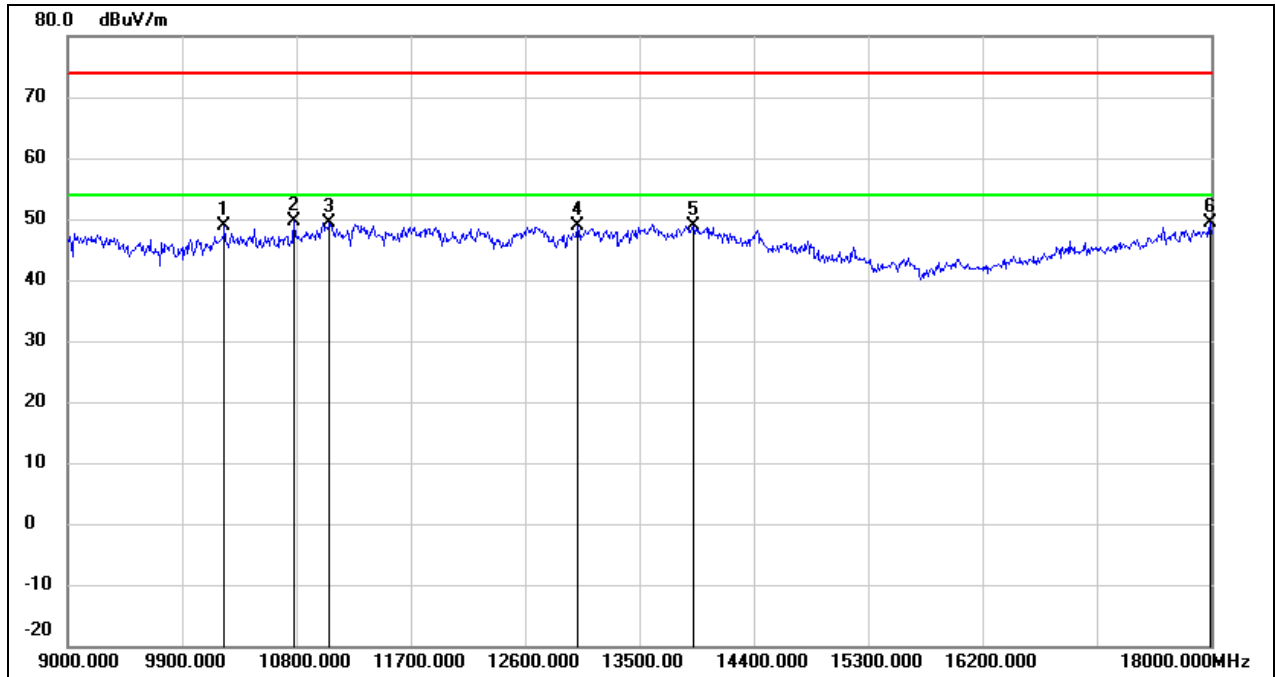

No.	Frequency (MHz)	Reading (dBuV)	Correct (dB/m)	Result (dBuV/m)	Limit (dBuV/m)	Margin (dB)	Remark
1	10233.000	36.43	12.57	49.00	74.00	-25.00	peak
2	10782.000	35.53	14.03	49.56	74.00	-24.44	peak
3	11061.000	34.50	14.96	49.46	74.00	-24.54	peak
4	13014.000	30.03	18.94	48.97	74.00	-25.03	peak
5	13923.000	27.17	21.72	48.89	74.00	-25.11	peak
6	17991.000	24.30	25.11	49.41	74.00	-24.59	peak

Test Mode:	802.11ax HE20	Channel:	6435
Polarity:	Horizontal	Test Voltage:	AC 120V_60Hz

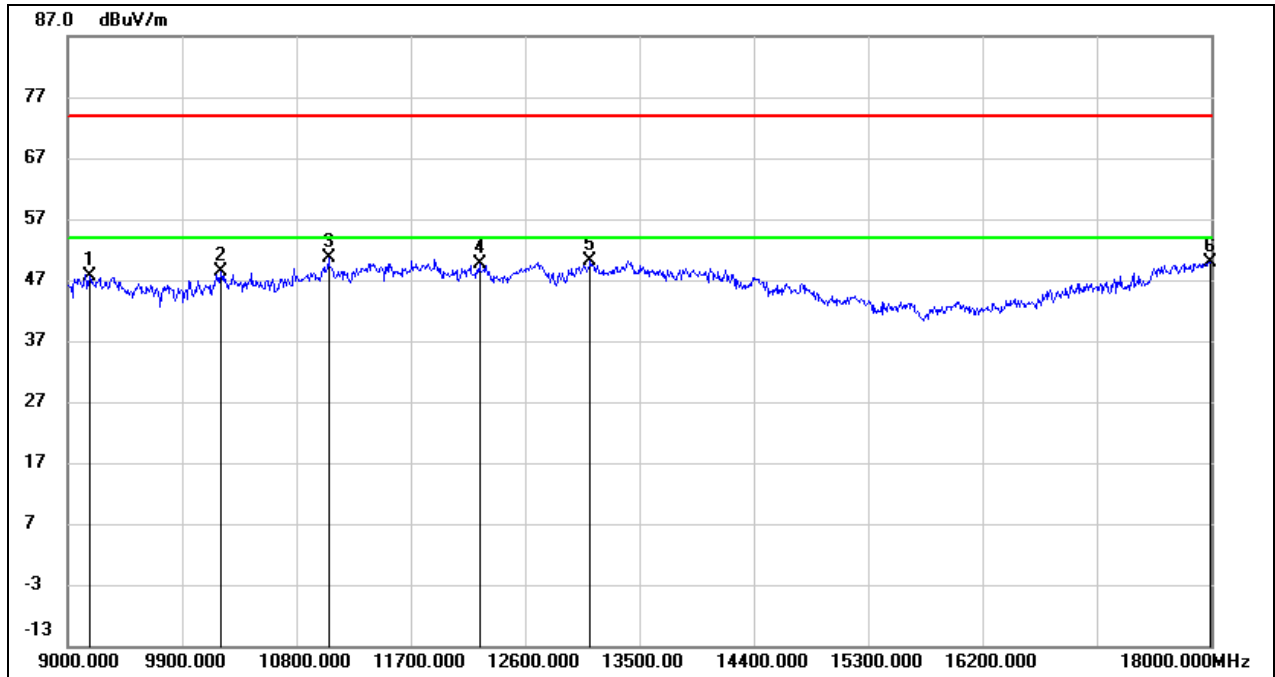

No.	Frequency (MHz)	Reading (dBuV)	Correct (dB/m)	Result (dBuV/m)	Limit (dBuV/m)	Margin (dB)	Remark
1	9171.000	36.72	10.83	47.55	74.00	-26.45	peak
2	10206.000	35.86	12.51	48.37	74.00	-25.63	peak
3	11052.000	35.63	14.94	50.57	74.00	-23.43	peak
4	12240.000	31.98	17.73	49.71	74.00	-24.29	peak
5	13113.000	30.86	19.33	50.19	74.00	-23.81	peak
6	17991.000	24.73	25.11	49.84	74.00	-24.16	peak

Test Mode:	802.11ax HE20	Channel:	6435
Polarity:	Vertical	Test Voltage:	AC 120V_60Hz

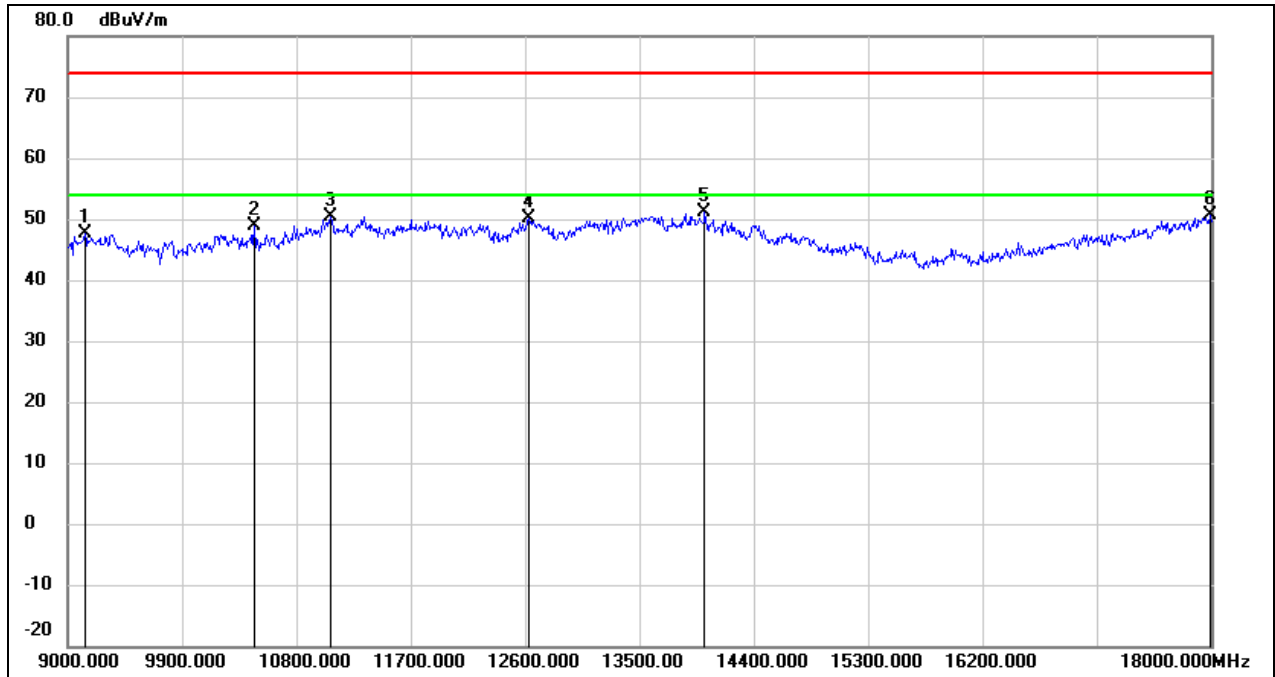

No.	Frequency (MHz)	Reading (dBuV)	Correct (dB/m)	Result (dBuV/m)	Limit (dBuV/m)	Margin (dB)	Remark
1	9135.000	36.86	10.84	47.70	74.00	-26.30	peak
2	10467.000	35.83	13.05	48.88	74.00	-25.12	peak
3	11070.000	35.42	15.00	50.42	74.00	-23.58	peak
4	12627.000	32.28	17.87	50.15	74.00	-23.85	peak
5	14013.000	29.19	21.82	51.01	74.00	-22.99	peak
6	17991.000	25.57	25.11	50.68	74.00	-23.32	peak

Test Mode:	802.11ax HE20	Channel:	6475
Polarity:	Horizontal	Test Voltage:	AC 120V_60Hz

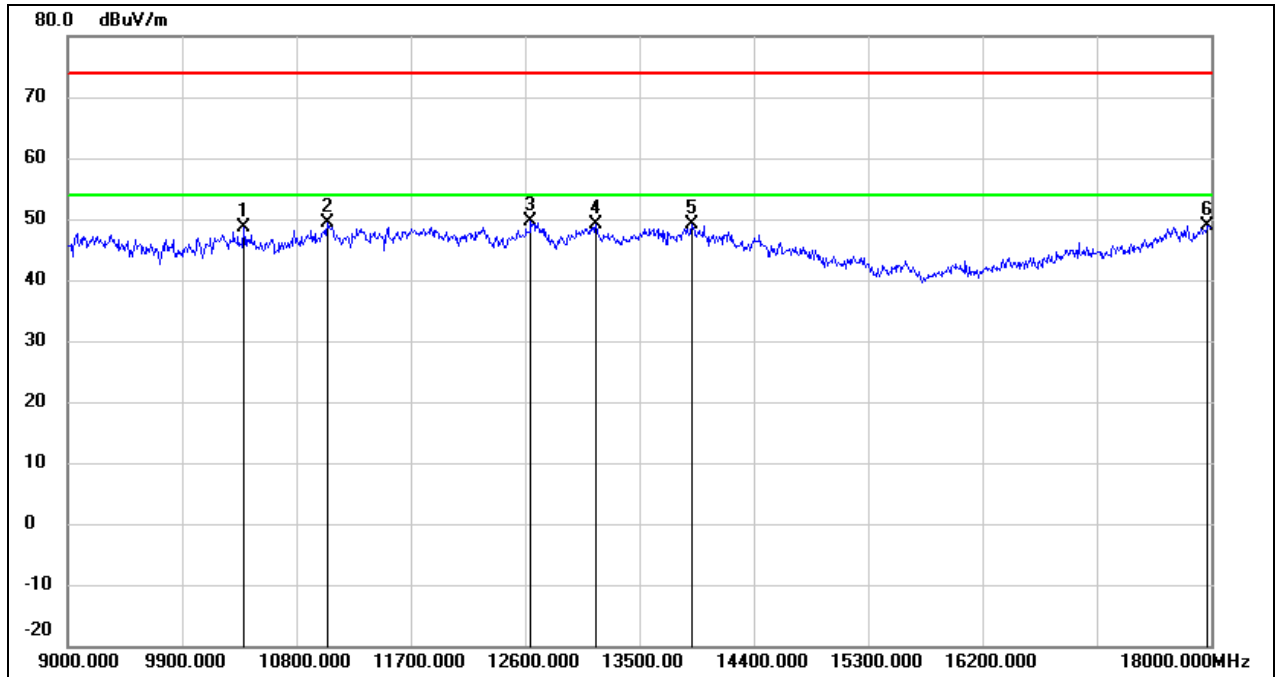

No.	Frequency (MHz)	Reading (dBuV)	Correct (dB/m)	Result (dBuV/m)	Limit (dBuV/m)	Margin (dB)	Remark
1	10386.000	35.80	12.89	48.69	74.00	-25.31	peak
2	11043.000	34.60	14.90	49.50	74.00	-24.50	peak
3	12645.000	31.77	17.92	49.69	74.00	-24.31	peak
4	13158.000	29.57	19.50	49.07	74.00	-24.93	peak
5	13914.000	27.55	21.69	49.24	74.00	-24.76	peak
6	17973.000	24.01	24.99	49.00	74.00	-25.00	peak

Test Mode:	802.11ax HE20	Channel:	6475
Polarity:	Vertical	Test Voltage:	AC 120V_60Hz

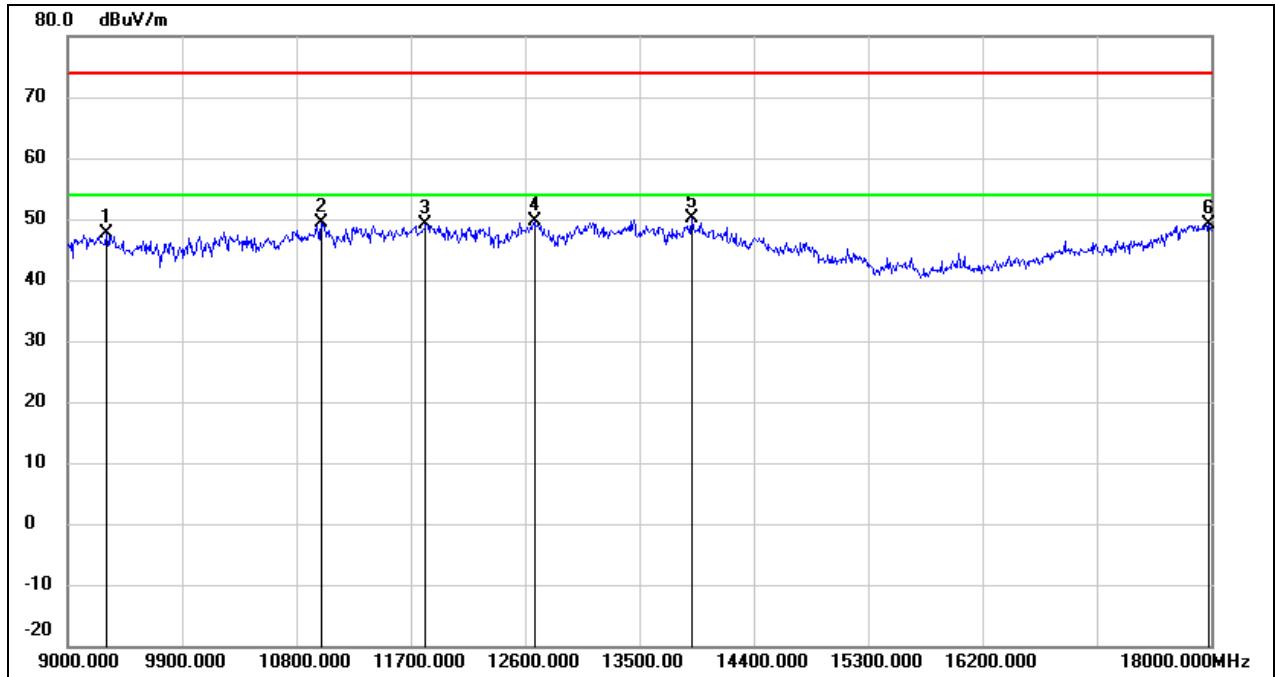

No.	Frequency (MHz)	Reading (dBuV)	Correct (dB/m)	Result (dBuV/m)	Limit (dBuV/m)	Margin (dB)	Remark
1	9306.000	36.83	10.86	47.69	74.00	-26.31	peak
2	10998.000	34.65	14.75	49.40	74.00	-24.60	peak
3	11817.000	31.80	17.40	49.20	74.00	-24.80	peak
4	12672.000	31.58	18.00	49.58	74.00	-24.42	peak
5	13914.000	28.35	21.69	50.04	74.00	-23.96	peak
6	17982.000	24.20	25.04	49.24	74.00	-24.76	peak

Test Mode:	802.11ax HE20	Channel:	6515
Polarity:	Horizontal	Test Voltage:	AC 120V_60Hz

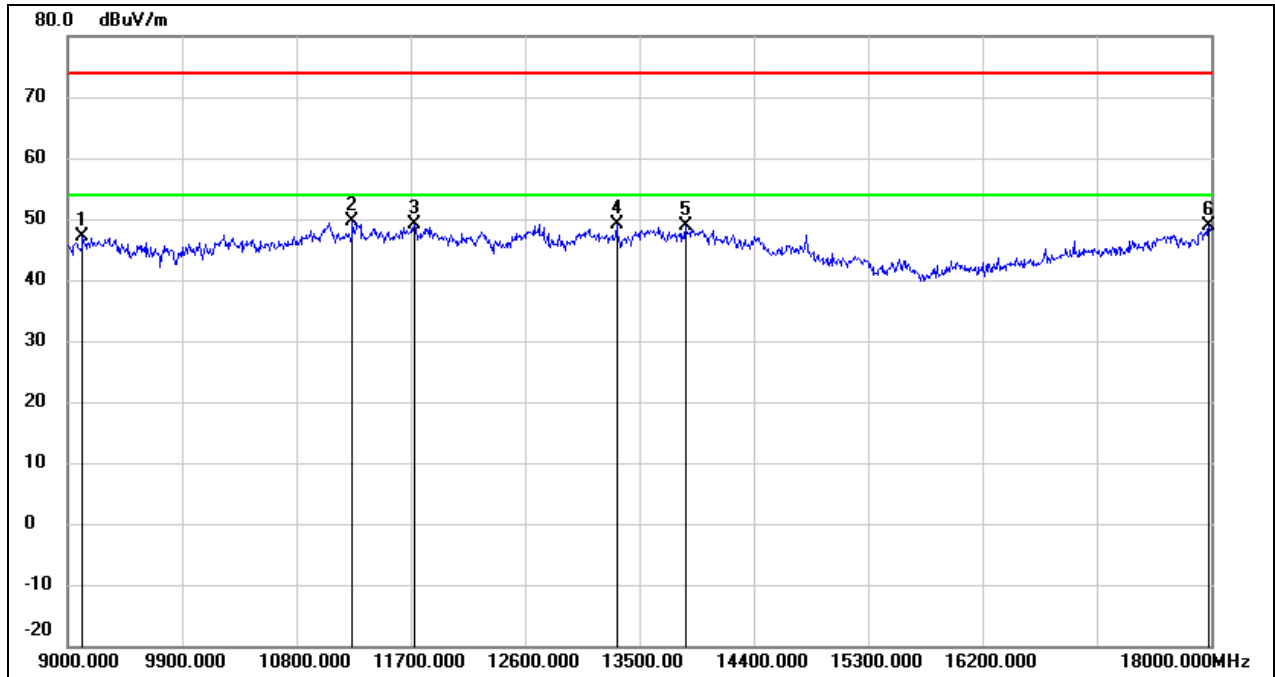

No.	Frequency (MHz)	Reading (dBuV)	Correct (dB/m)	Result (dBuV/m)	Limit (dBuV/m)	Margin (dB)	Remark
1	9117.000	36.40	10.83	47.23	74.00	-26.77	peak
2	11241.000	33.91	15.61	49.52	74.00	-24.48	peak
3	11727.000	31.93	17.16	49.09	74.00	-24.91	peak
4	13320.000	28.95	20.11	49.06	74.00	-24.94	peak
5	13860.000	27.20	21.59	48.79	74.00	-25.21	peak
6	17982.000	23.77	25.04	48.81	74.00	-25.19	peak

Test Mode:	802.11ax HE20	Channel:	6515
Polarity:	Vertical	Test Voltage:	AC 120V_60Hz

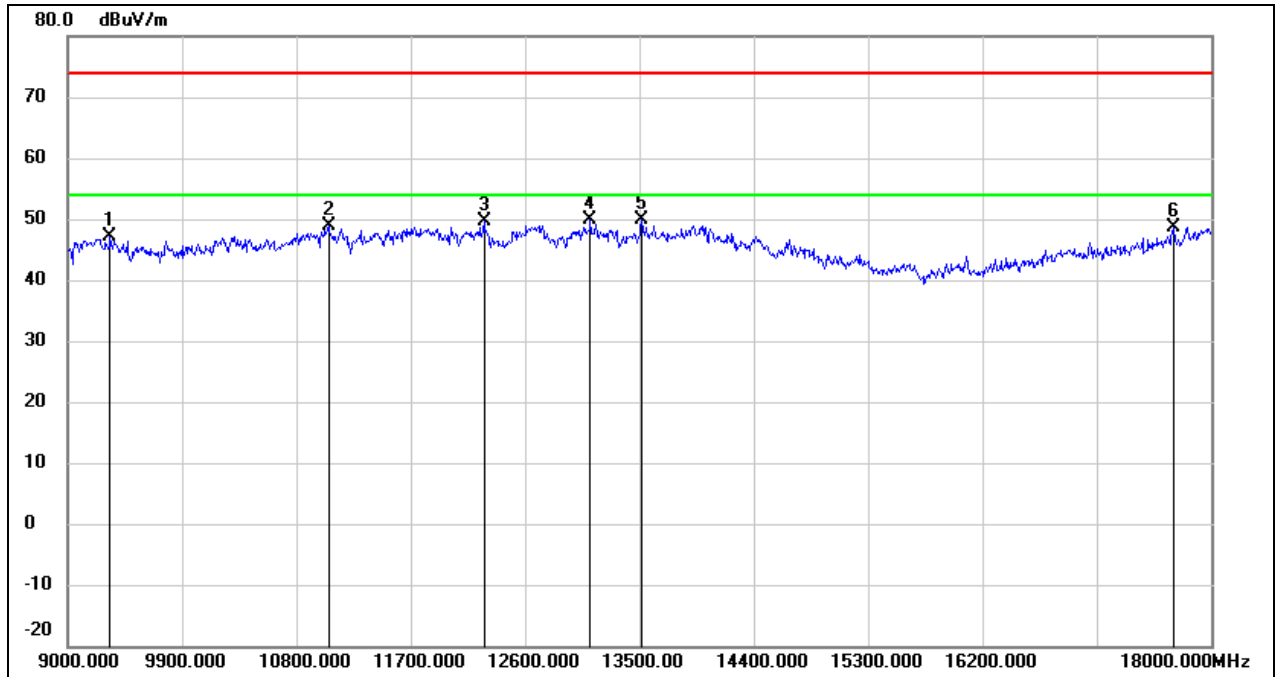

No.	Frequency (MHz)	Reading (dBuV)	Correct (dB/m)	Result (dBuV/m)	Limit (dBuV/m)	Margin (dB)	Remark
1	9333.000	36.15	10.86	47.01	74.00	-26.99	peak
2	11052.000	34.06	14.94	49.00	74.00	-25.00	peak
3	12276.000	31.91	17.70	49.61	74.00	-24.39	peak
4	13113.000	30.51	19.33	49.84	74.00	-24.16	peak
5	13518.000	28.96	20.85	49.81	74.00	-24.19	peak
6	17703.000	25.36	23.26	48.62	74.00	-25.38	peak

Test Mode:	802.11ax HE20	Channel:	6535
Polarity:	Horizontal	Test Voltage:	AC 120V_60Hz

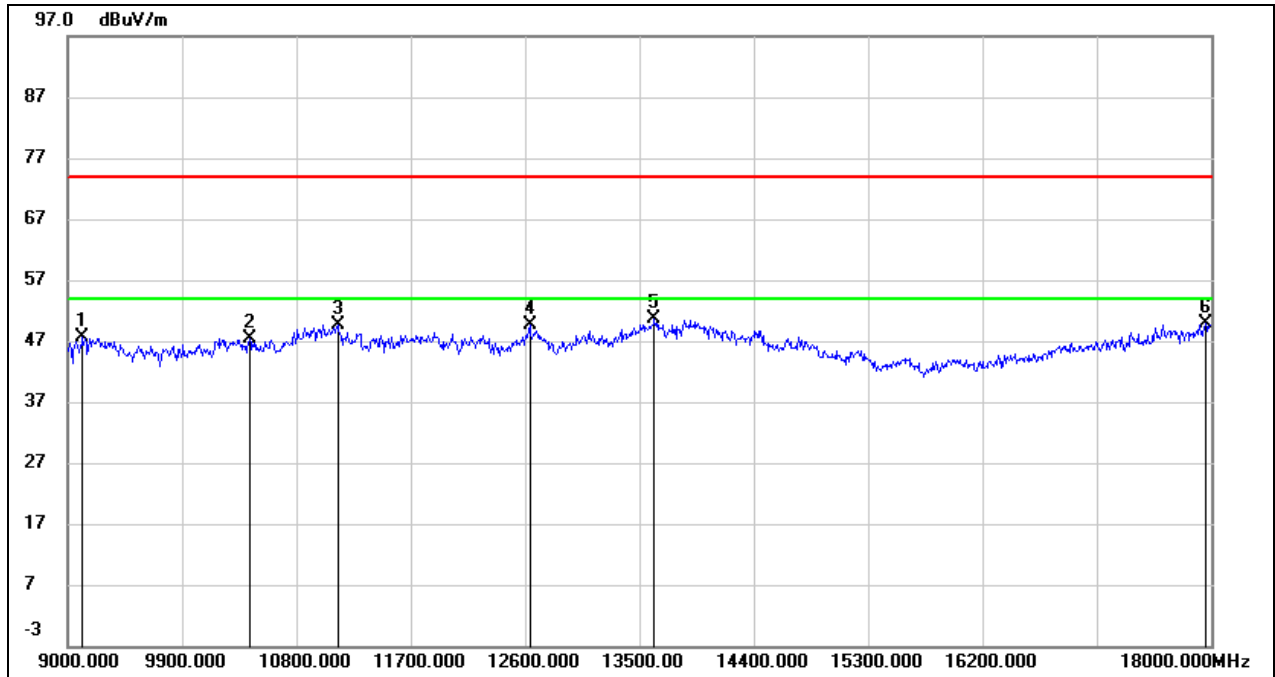

No.	Frequency (MHz)	Reading (dBuV)	Correct (dB/m)	Result (dBuV/m)	Limit (dBuV/m)	Margin (dB)	Remark
1	9117.000	36.77	10.83	47.60	74.00	-26.40	peak
2	10431.000	34.52	12.97	47.49	74.00	-26.51	peak
3	11124.000	34.50	15.19	49.69	74.00	-24.31	peak
4	12636.000	31.63	17.90	49.53	74.00	-24.47	peak
5	13617.000	29.51	21.06	50.57	74.00	-23.43	peak
6	17955.000	24.92	24.87	49.79	74.00	-24.21	peak

Test Mode:	802.11ax HE20	Channel:	6535
Polarity:	Vertical	Test Voltage:	AC 120V_60Hz

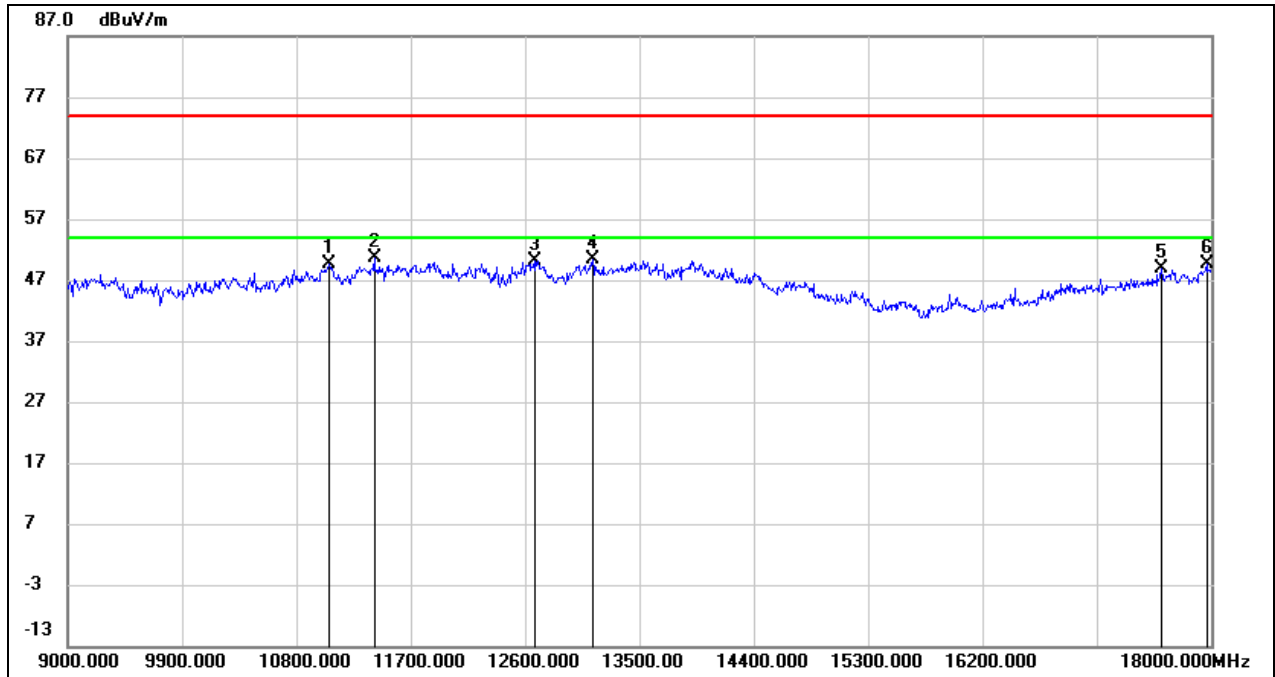

No.	Frequency (MHz)	Reading (dBuV)	Correct (dB/m)	Result (dBuV/m)	Limit (dBuV/m)	Margin (dB)	Remark
1	11061.000	34.70	14.96	49.66	74.00	-24.34	peak
2	11412.000	34.47	16.22	50.69	74.00	-23.31	peak
3	12672.000	32.12	18.00	50.12	74.00	-23.88	peak
4	13131.000	30.95	19.40	50.35	74.00	-23.65	peak
5	17604.000	26.16	22.62	48.78	74.00	-25.22	peak
6	17964.000	24.76	24.92	49.68	74.00	-24.32	peak

Test Mode:	802.11ax HE20	Channel:	6715
Polarity:	Horizontal	Test Voltage:	AC 120V_60Hz

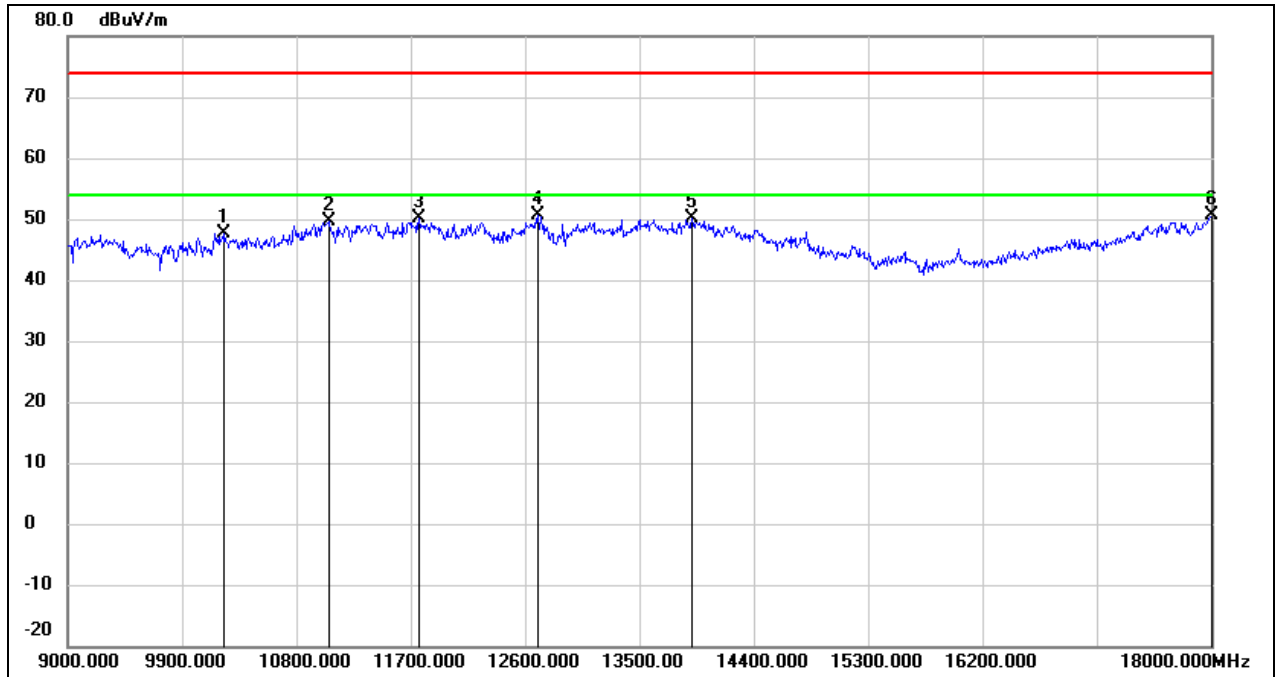

No.	Frequency (MHz)	Reading (dBuV)	Correct (dB/m)	Result (dBuV/m)	Limit (dBuV/m)	Margin (dB)	Remark
1	10233.000	35.11	12.57	47.68	74.00	-26.32	peak
2	11052.000	34.62	14.94	49.56	74.00	-24.44	peak
3	11763.000	32.80	17.26	50.06	74.00	-23.94	peak
4	12699.000	32.60	18.07	50.67	74.00	-23.33	peak
5	13914.000	28.40	21.69	50.09	74.00	-23.91	peak
6	18000.000	25.43	25.16	50.59	74.00	-23.41	peak

Test Mode:	802.11ax HE20	Channel:	6715
Polarity:	Vertical	Test Voltage:	AC 120V_60Hz

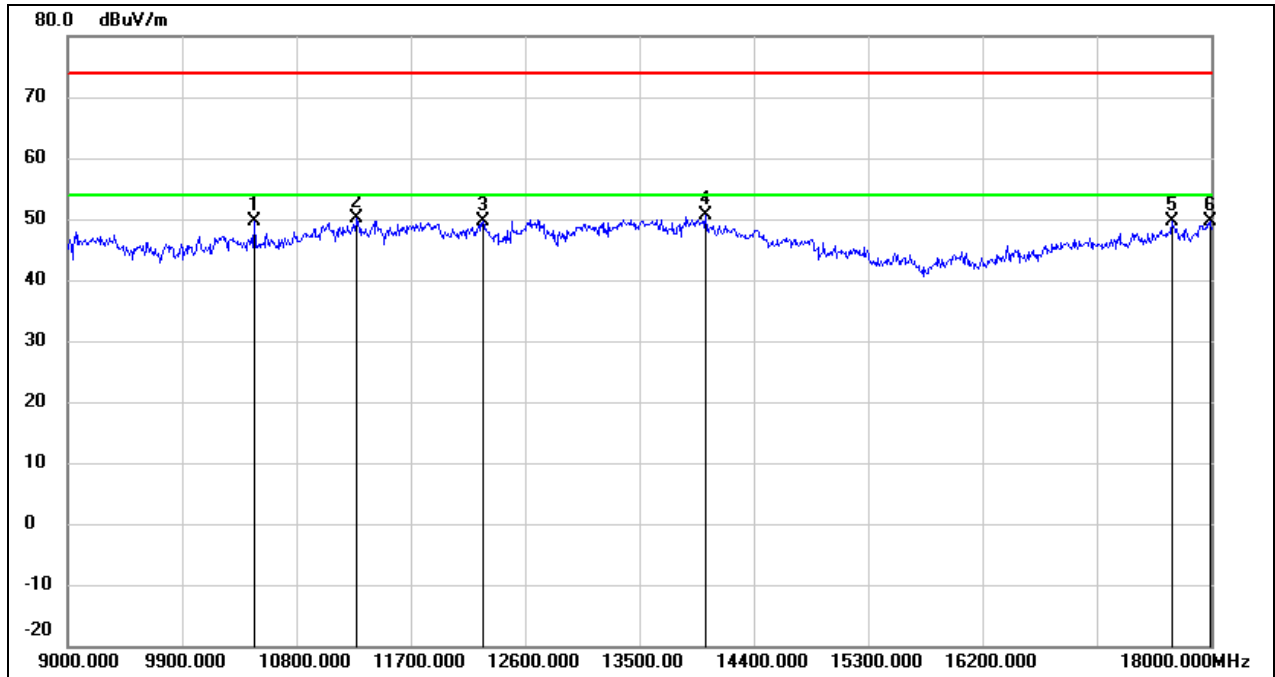

No.	Frequency (MHz)	Reading (dBuV)	Correct (dB/m)	Result (dBuV/m)	Limit (dBuV/m)	Margin (dB)	Remark
1	10467.000	36.62	13.05	49.67	74.00	-24.33	peak
2	11277.000	34.32	15.73	50.05	74.00	-23.95	peak
3	12267.000	32.00	17.71	49.71	74.00	-24.29	peak
4	14022.000	28.76	21.79	50.55	74.00	-23.45	peak
5	17694.000	26.33	23.20	49.53	74.00	-24.47	peak
6	17991.000	24.47	25.11	49.58	74.00	-24.42	peak

Test Mode:	802.11ax HE20	Channel:	6875
Polarity:	Horizontal	Test Voltage:	AC 120V_60Hz

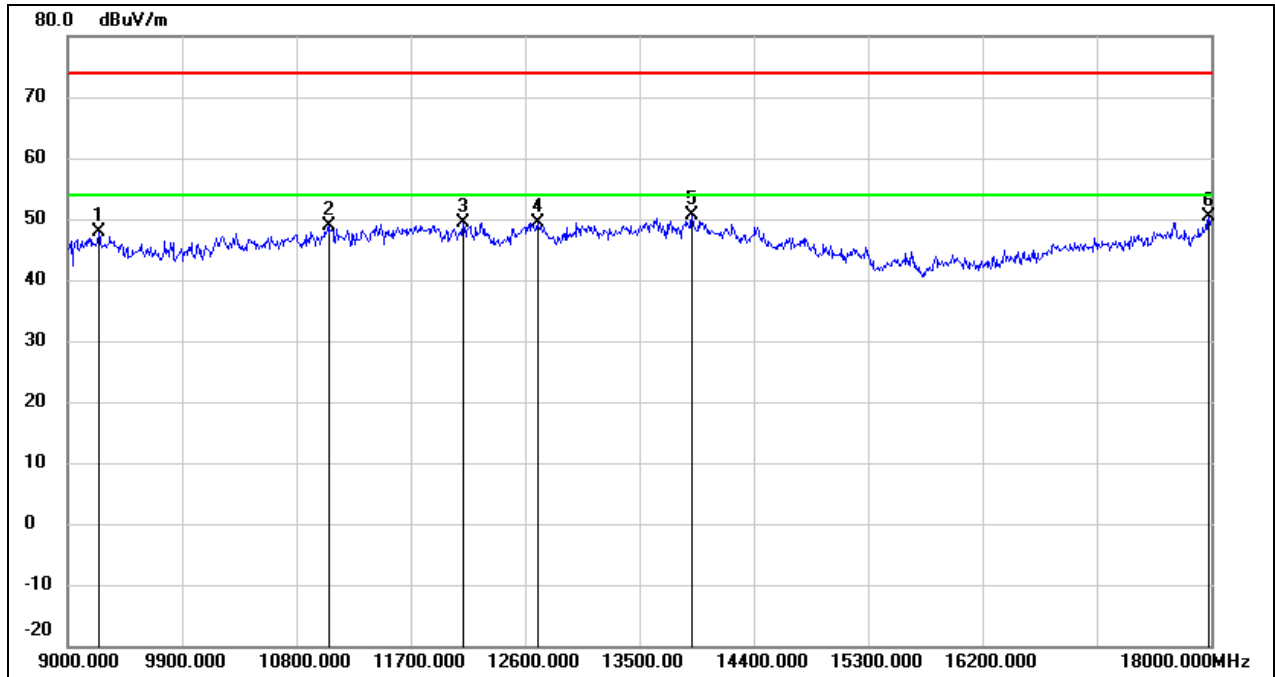

No.	Frequency (MHz)	Reading (dBuV)	Correct (dB/m)	Result (dBuV/m)	Limit (dBuV/m)	Margin (dB)	Remark
1	9243.000	37.07	10.85	47.92	74.00	-26.08	peak
2	11052.000	34.03	14.94	48.97	74.00	-25.03	peak
3	12114.000	31.65	17.83	49.48	74.00	-24.52	peak
4	12699.000	31.39	18.07	49.46	74.00	-24.54	peak
5	13914.000	29.04	21.69	50.73	74.00	-23.27	peak
6	17982.000	25.36	25.04	50.40	74.00	-23.60	peak

Test Mode:	802.11ax HE20	Channel:	6875
Polarity:	Vertical	Test Voltage:	AC 120V_60Hz

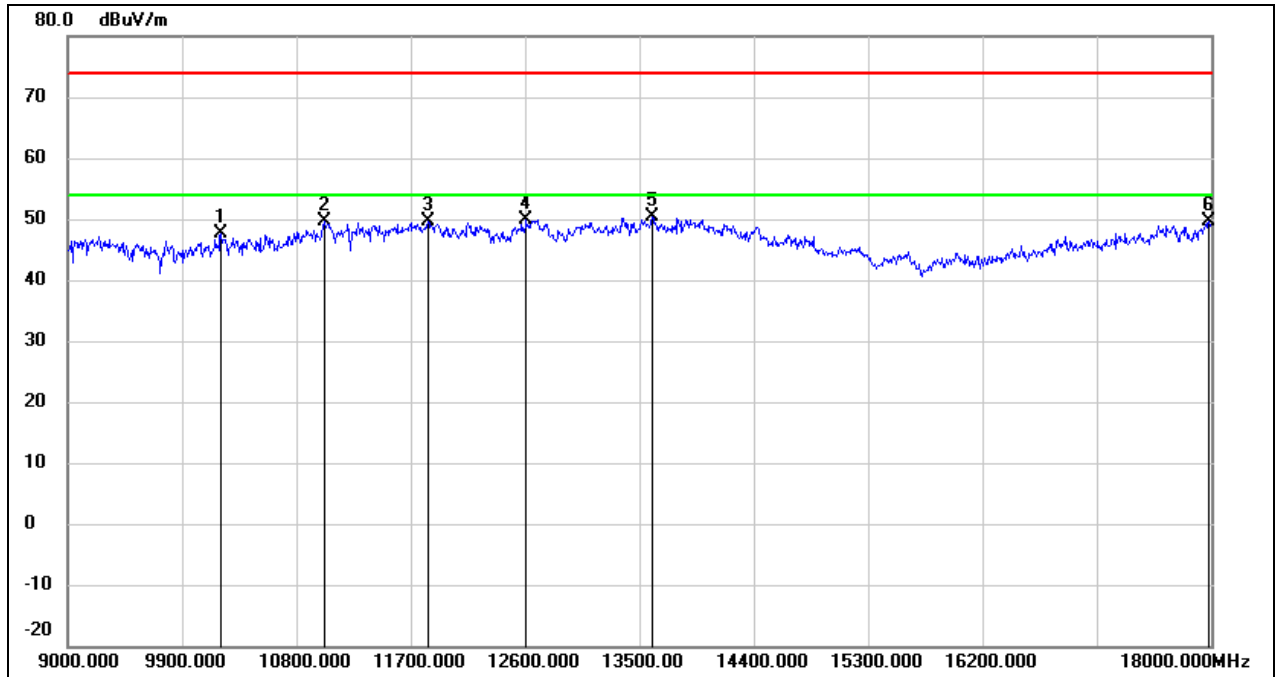

No.	Frequency (MHz)	Reading (dBuV)	Correct (dB/m)	Result (dBuV/m)	Limit (dBuV/m)	Margin (dB)	Remark
1	10206.000	35.12	12.51	47.63	74.00	-26.37	peak
2	11025.000	34.86	14.83	49.69	74.00	-24.31	peak
3	11835.000	32.09	17.46	49.55	74.00	-24.45	peak
4	12609.000	31.98	17.83	49.81	74.00	-24.19	peak
5	13599.000	29.36	21.02	50.38	74.00	-23.62	peak
6	17982.000	24.62	25.04	49.66	74.00	-24.34	peak

Test Mode:	802.11ax HE20	Channel:	6895
Polarity:	Horizontal	Test Voltage:	AC 120V_60Hz

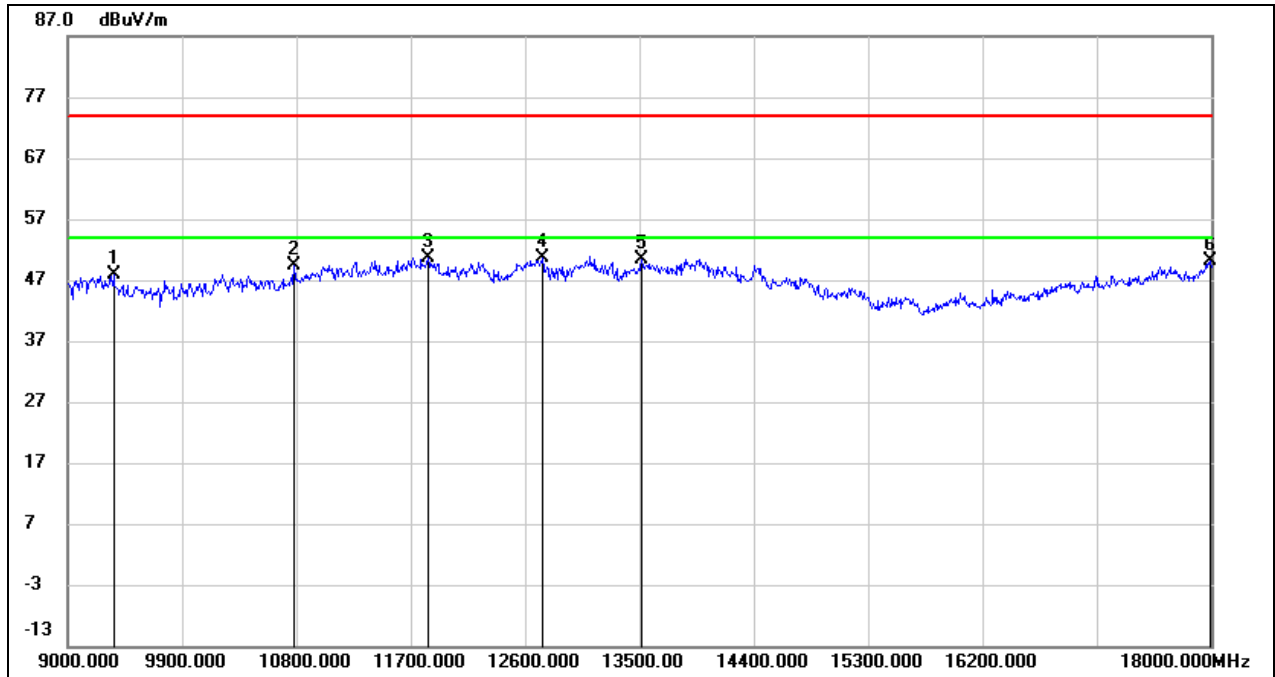

No.	Frequency (MHz)	Reading (dBuV)	Correct (dB/m)	Result (dBuV/m)	Limit (dBuV/m)	Margin (dB)	Remark
1	9360.000	36.96	10.87	47.83	74.00	-26.17	peak
2	10782.000	35.41	14.03	49.44	74.00	-24.56	peak
3	11835.000	33.13	17.46	50.59	74.00	-23.41	peak
4	12735.000	32.43	18.17	50.60	74.00	-23.40	peak
5	13518.000	29.60	20.85	50.45	74.00	-23.55	peak
6	17991.000	25.09	25.11	50.20	74.00	-23.80	peak

Test Mode:	802.11ax HE20	Channel:	6895
Polarity:	Vertical	Test Voltage:	AC 120V_60Hz

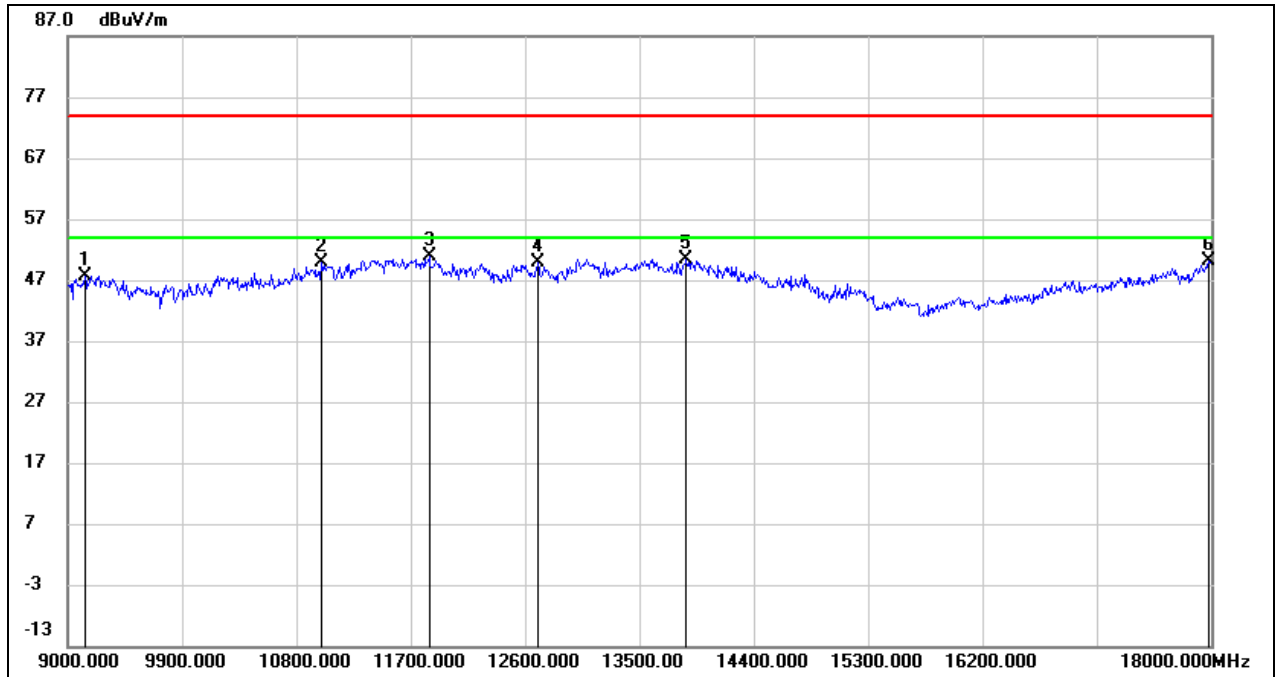

No.	Frequency (MHz)	Reading (dBuV)	Correct (dB/m)	Result (dBuV/m)	Limit (dBuV/m)	Margin (dB)	Remark
1	9135.000	36.90	10.84	47.74	74.00	-26.26	peak
2	10998.000	35.05	14.75	49.80	74.00	-24.20	peak
3	11844.000	33.42	17.48	50.90	74.00	-23.10	peak
4	12699.000	31.88	18.07	49.95	74.00	-24.05	peak
5	13869.000	28.76	21.59	50.35	74.00	-23.65	peak
6	17982.000	25.07	25.04	50.11	74.00	-23.89	peak

Test Mode:	802.11ax HE20	Channel:	7015
Polarity:	Horizontal	Test Voltage:	AC 120V_60Hz

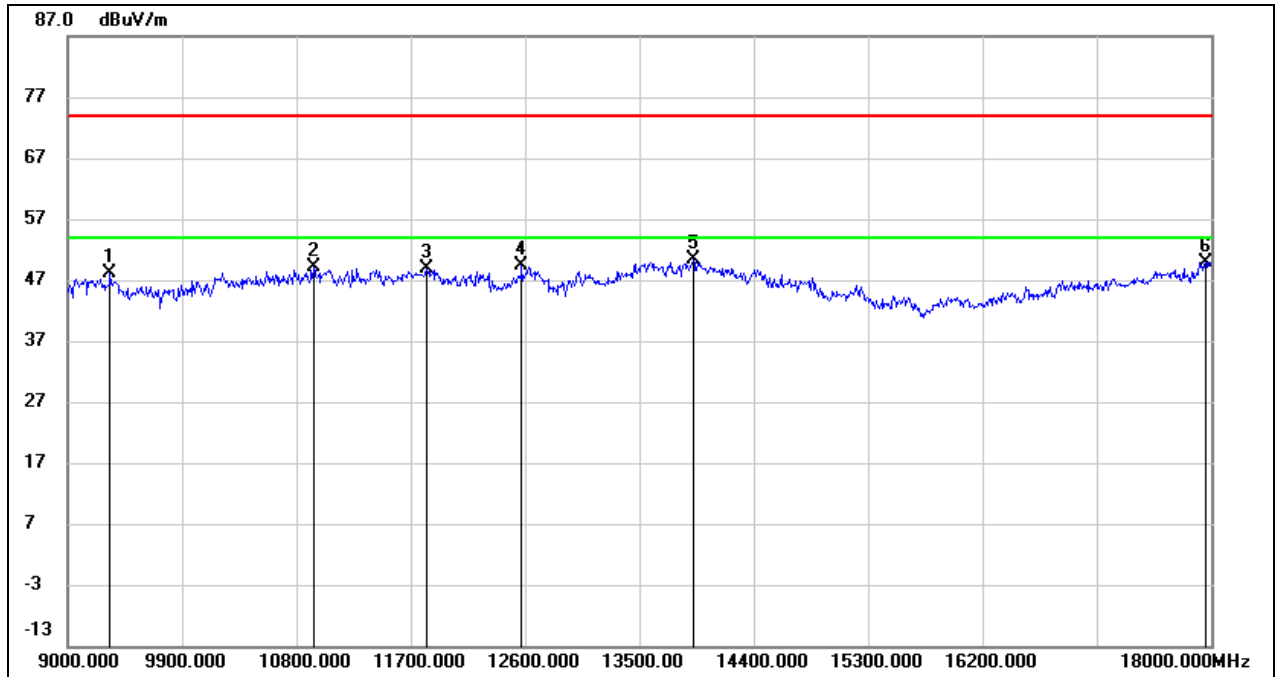

No.	Frequency (MHz)	Reading (dBuV)	Correct (dB/m)	Result (dBuV/m)	Limit (dBuV/m)	Margin (dB)	Remark
1	9333.000	37.22	10.86	48.08	74.00	-25.92	peak
2	10935.000	34.58	14.54	49.12	74.00	-24.88	peak
3	11826.000	31.40	17.42	48.82	74.00	-25.18	peak
4	12573.000	31.70	17.73	49.43	74.00	-24.57	peak
5	13923.000	28.55	21.72	50.27	74.00	-23.73	peak
6	17955.000	25.08	24.87	49.95	74.00	-24.05	peak

Test Mode:	802.11ax HE20	Channel:	7015
Polarity:	Vertical	Test Voltage:	AC 120V_60Hz

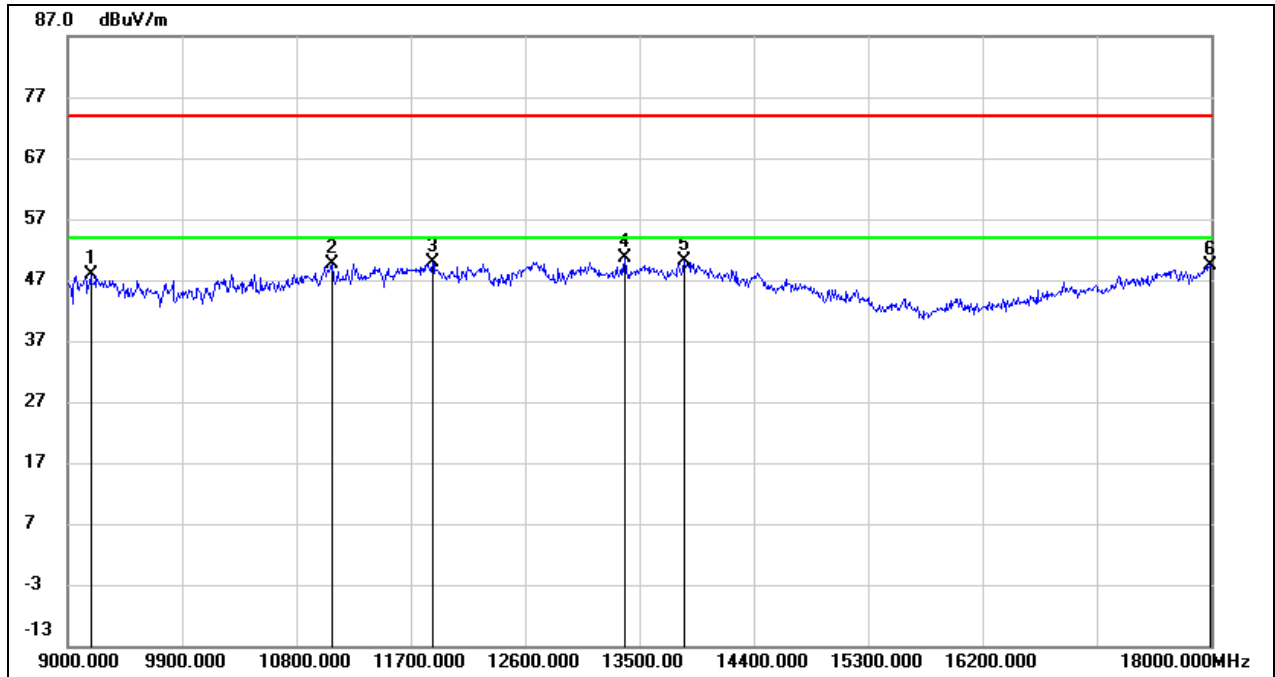

No.	Frequency (MHz)	Reading (dBuV)	Correct (dB/m)	Result (dBuV/m)	Limit (dBuV/m)	Margin (dB)	Remark
1	9180.000	37.09	10.84	47.93	74.00	-26.07	peak
2	11079.000	34.63	15.03	49.66	74.00	-24.34	peak
3	11871.000	32.22	17.56	49.78	74.00	-24.22	peak
4	13383.000	30.22	20.35	50.57	74.00	-23.43	peak
5	13851.000	28.45	21.56	50.01	74.00	-23.99	peak
6	17991.000	24.33	25.11	49.44	74.00	-24.56	peak

Test Mode:	802.11ax HE20	Channel:	7095
Polarity:	Horizontal	Test Voltage:	AC 120V_60Hz

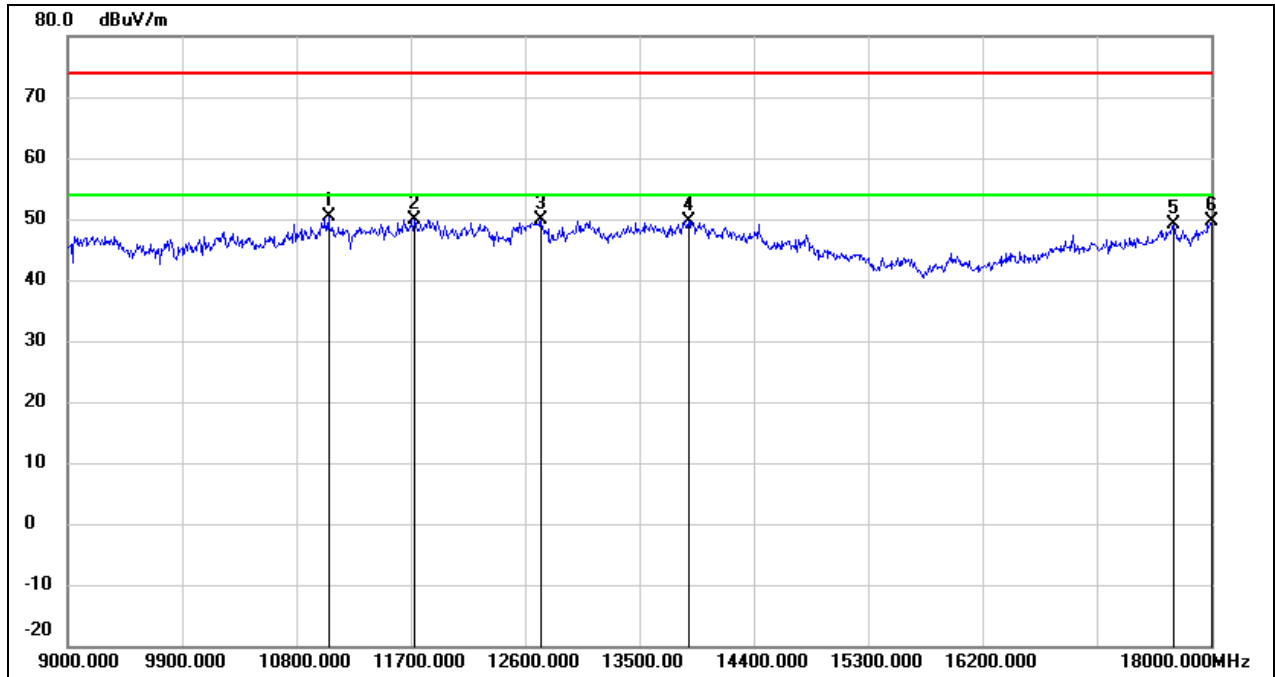

No.	Frequency (MHz)	Reading (dBuV)	Correct (dB/m)	Result (dBuV/m)	Limit (dBuV/m)	Margin (dB)	Remark
1	11052.000	35.44	14.94	50.38	74.00	-23.62	peak
2	11727.000	32.76	17.16	49.92	74.00	-24.08	peak
3	12726.000	31.71	18.14	49.85	74.00	-24.15	peak
4	13887.000	28.08	21.64	49.72	74.00	-24.28	peak
5	17703.000	25.89	23.26	49.15	74.00	-24.85	peak
6	18000.000	24.44	25.16	49.60	74.00	-24.40	peak

Test Mode:	802.11ax HE20	Channel:	7095
Polarity:	Vertical	Test Voltage:	AC 120V_60Hz

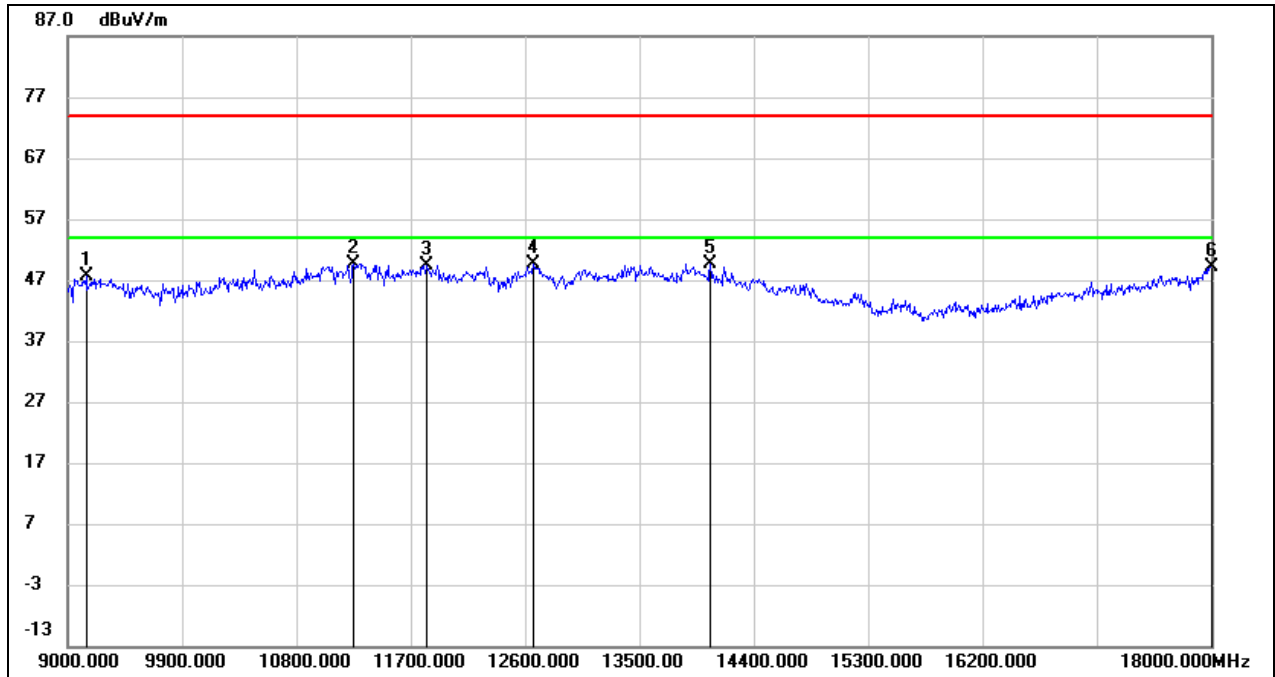

No.	Frequency (MHz)	Reading (dBuV)	Correct (dB/m)	Result (dBuV/m)	Limit (dBuV/m)	Margin (dB)	Remark
1	9144.000	36.71	10.83	47.54	74.00	-26.46	peak
2	11250.000	34.02	15.64	49.66	74.00	-24.34	peak
3	11826.000	32.08	17.42	49.50	74.00	-24.50	peak
4	12663.000	31.74	17.98	49.72	74.00	-24.28	peak
5	14058.000	28.06	21.62	49.68	74.00	-24.32	peak
6	18000.000	23.97	25.16	49.13	74.00	-24.87	peak

Test Mode:	802.11ax HE20	Channel:	7115
Polarity:	Horizontal	Test Voltage:	AC 120V_60Hz

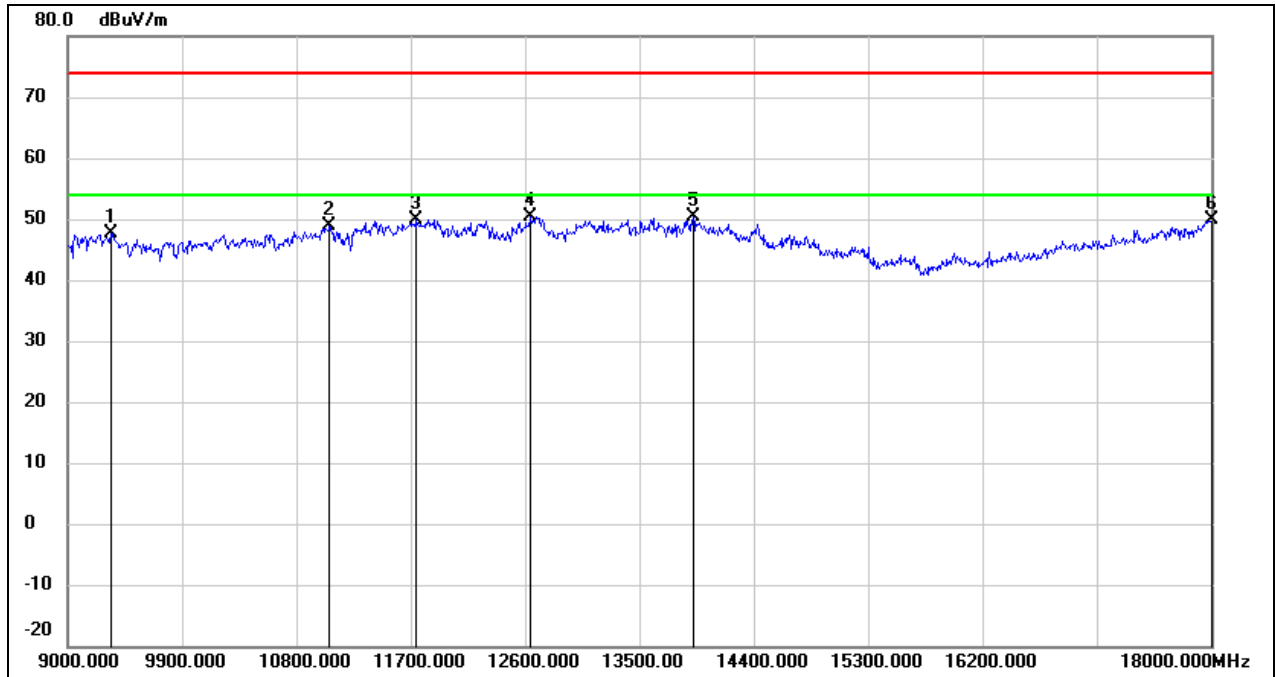

No.	Frequency (MHz)	Reading (dBuV)	Correct (dB/m)	Result (dBuV/m)	Limit (dBuV/m)	Margin (dB)	Remark
1	9342.000	36.88	10.87	47.75	74.00	-26.25	peak
2	11061.000	33.89	14.96	48.85	74.00	-25.15	peak
3	11745.000	32.70	17.21	49.91	74.00	-24.09	peak
4	12645.000	32.39	17.92	50.31	74.00	-23.69	peak
5	13923.000	28.54	21.72	50.26	74.00	-23.74	peak
6	18000.000	24.63	25.16	49.79	74.00	-24.21	peak

Test Mode:	802.11ax HE20	Channel:	7115
Polarity:	Vertical	Test Voltage:	AC 120V_60Hz

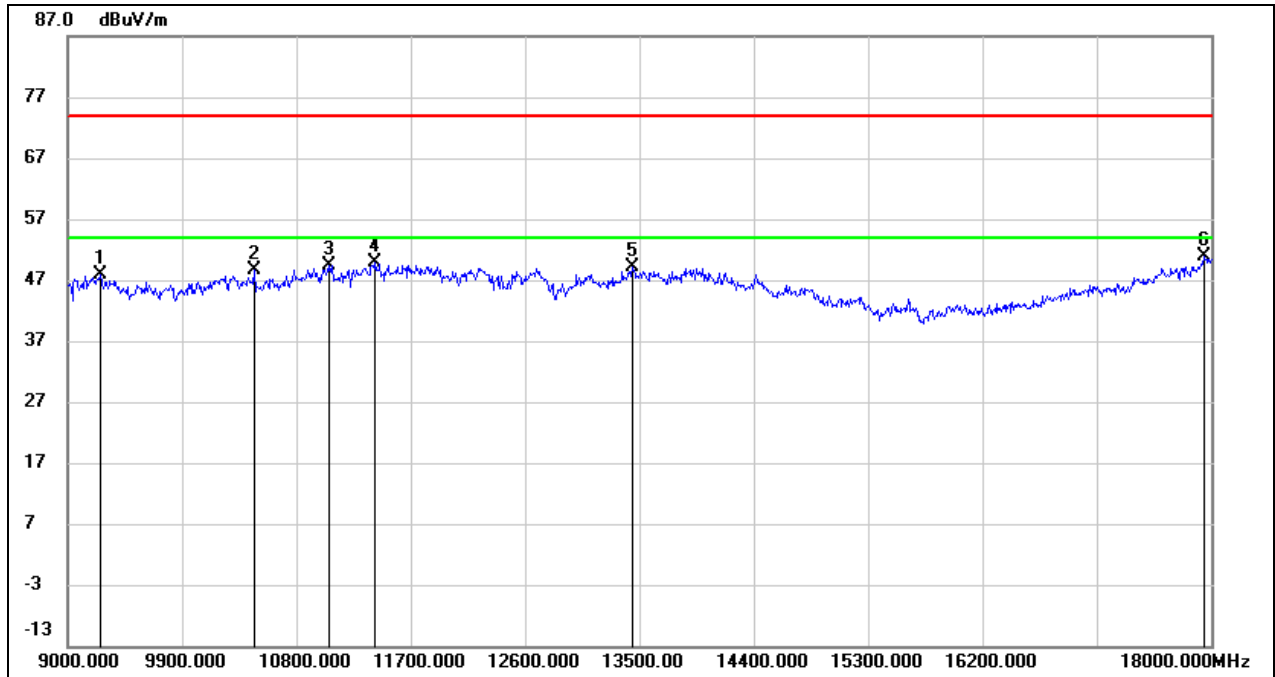

No.	Frequency (MHz)	Reading (dBuV)	Correct (dB/m)	Result (dBuV/m)	Limit (dBuV/m)	Margin (dB)	Remark
1	9261.000	37.04	10.85	47.89	74.00	-26.11	peak
2	10467.000	35.60	13.05	48.65	74.00	-25.35	peak
3	11052.000	34.35	14.94	49.29	74.00	-24.71	peak
4	11421.000	33.64	16.25	49.89	74.00	-24.11	peak
5	13446.000	28.50	20.60	49.10	74.00	-24.90	peak
6	17946.000	26.05	24.82	50.87	74.00	-23.13	peak

Test Mode:	802.11ax HE40	Channel:	6125
Polarity:	Horizontal	Test Voltage:	AC 120V_60Hz

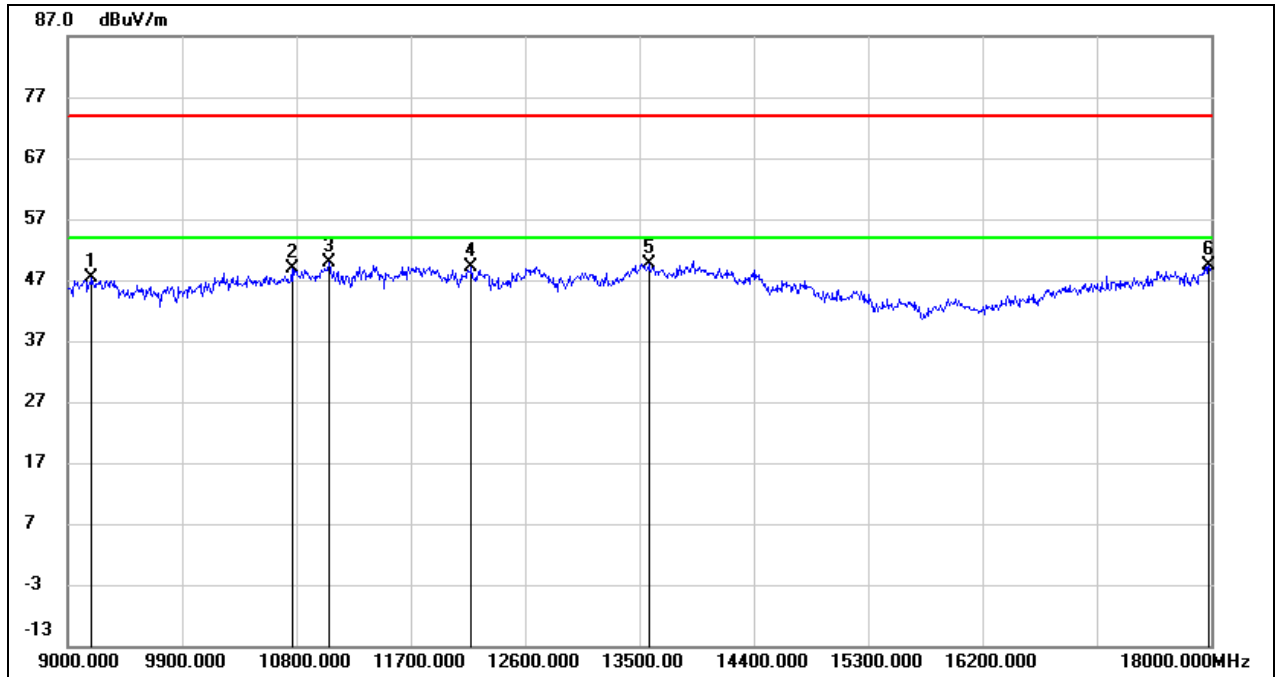

No.	Frequency (MHz)	Reading (dBuV)	Correct (dB/m)	Result (dBuV/m)	Limit (dBuV/m)	Margin (dB)	Remark
1	9189.000	36.45	10.84	47.29	74.00	-26.71	peak
2	10764.000	34.84	13.98	48.82	74.00	-25.18	peak
3	11052.000	34.98	14.94	49.92	74.00	-24.08	peak
4	12177.000	31.36	17.77	49.13	74.00	-24.87	peak
5	13572.000	28.77	20.96	49.73	74.00	-24.27	peak
6	17982.000	24.23	25.04	49.27	74.00	-24.73	peak

Test Mode:	802.11ax HE40	Channel:	6125
Polarity:	Vertical	Test Voltage:	AC 120V_60Hz

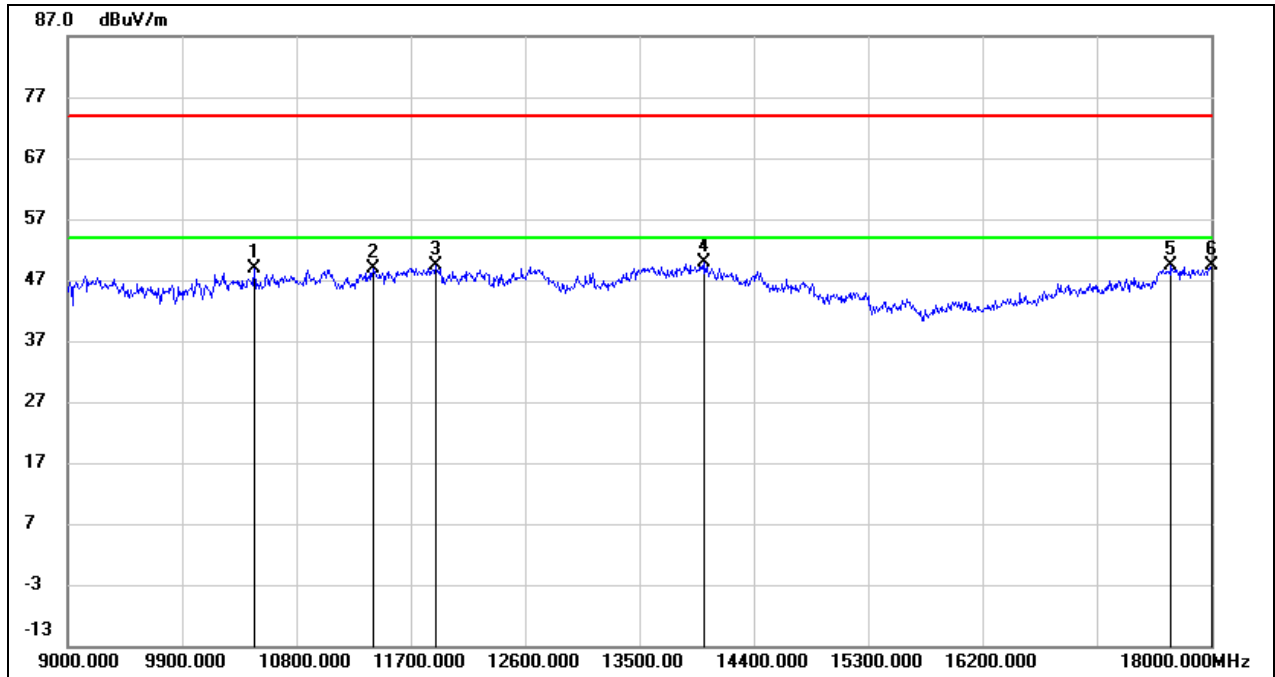

No.	Frequency (MHz)	Reading (dBuV)	Correct (dB/m)	Result (dBuV/m)	Limit (dBuV/m)	Margin (dB)	Remark
1	10467.000	35.73	13.05	48.78	74.00	-25.22	peak
2	11403.000	32.75	16.19	48.94	74.00	-25.06	peak
3	11898.000	31.78	17.63	49.41	74.00	-24.59	peak
4	14013.000	27.94	21.82	49.76	74.00	-24.24	peak
5	17685.000	26.14	23.14	49.28	74.00	-24.72	peak
6	18000.000	24.27	25.16	49.43	74.00	-24.57	peak

Test Mode:	802.11ax HE40	Channel:	6285
Polarity:	Horizontal	Test Voltage:	AC 120V_60Hz

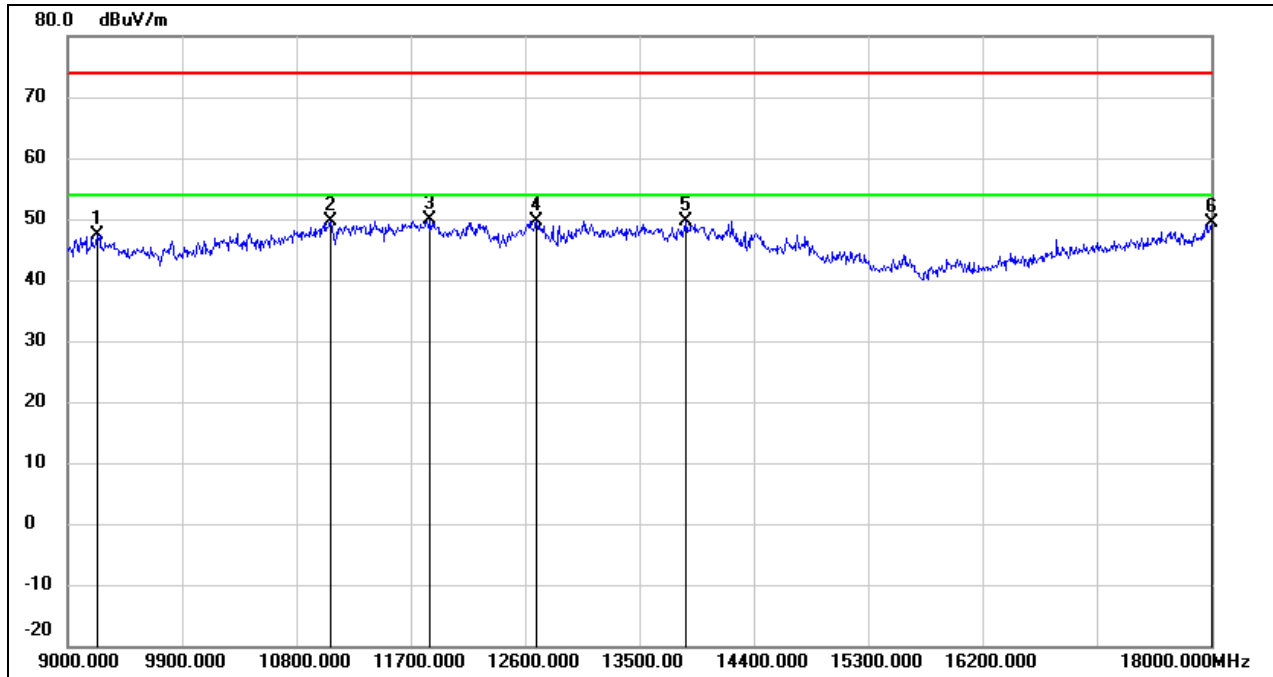

No.	Frequency (MHz)	Reading (dBuV)	Correct (dB/m)	Result (dBuV/m)	Limit (dBuV/m)	Margin (dB)	Remark
1	9234.000	36.61	10.84	47.45	74.00	-26.55	peak
2	11070.000	34.51	15.00	49.51	74.00	-24.49	peak
3	11853.000	32.46	17.50	49.96	74.00	-24.04	peak
4	12690.000	31.70	18.05	49.75	74.00	-24.25	peak
5	13869.000	28.08	21.59	49.67	74.00	-24.33	peak
6	18000.000	24.21	25.16	49.37	74.00	-24.63	peak

Test Mode:	802.11ax HE40	Channel:	6285
Polarity:	Vertical	Test Voltage:	AC 120V_60Hz

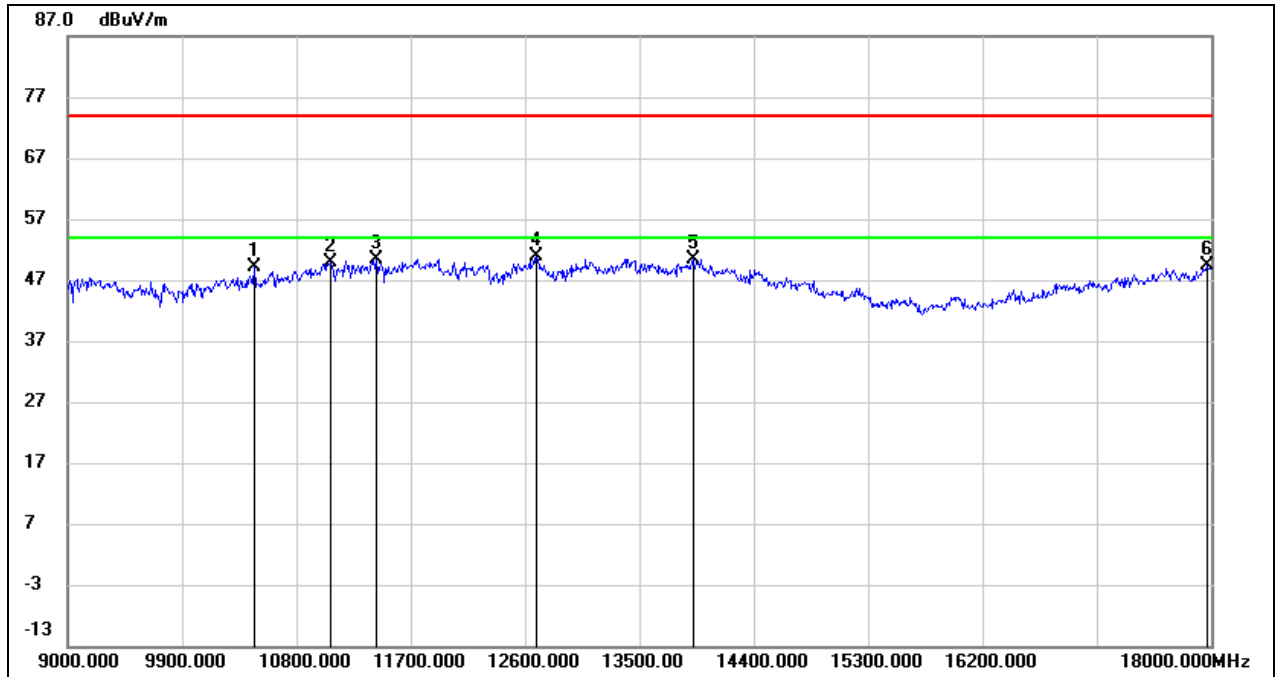

No.	Frequency (MHz)	Reading (dBuV)	Correct (dB/m)	Result (dBuV/m)	Limit (dBuV/m)	Margin (dB)	Remark
1	10467.000	35.96	13.05	49.01	74.00	-24.99	peak
2	11070.000	34.89	15.00	49.89	74.00	-24.11	peak
3	11430.000	34.14	16.28	50.42	74.00	-23.58	peak
4	12690.000	32.81	18.05	50.86	74.00	-23.14	peak
5	13923.000	28.68	21.72	50.40	74.00	-23.60	peak
6	17973.000	24.34	24.99	49.33	74.00	-24.67	peak

Test Mode:	802.11ax HE40	Channel:	6405
Polarity:	Horizontal	Test Voltage:	AC 120V_60Hz

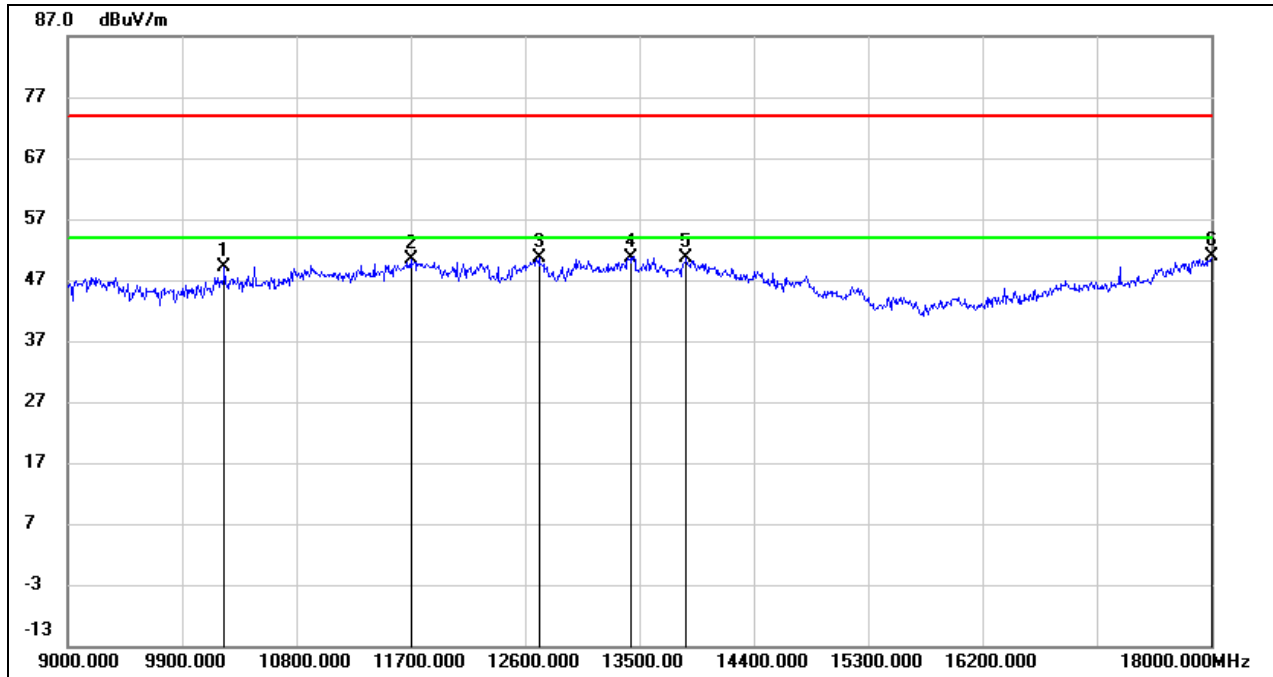

No.	Frequency (MHz)	Reading (dBuV)	Correct (dB/m)	Result (dBuV/m)	Limit (dBuV/m)	Margin (dB)	Remark
1	10233.000	36.68	12.57	49.25	74.00	-24.75	peak
2	11700.000	33.38	17.08	50.46	74.00	-23.54	peak
3	12708.000	32.52	18.10	50.62	74.00	-23.38	peak
4	13428.000	30.12	20.53	50.65	74.00	-23.35	peak
5	13869.000	29.09	21.59	50.68	74.00	-23.32	peak
6	18000.000	25.79	25.16	50.95	74.00	-23.05	peak

Test Mode:	802.11ax HE40	Channel:	6405
Polarity:	Vertical	Test Voltage:	AC 120V_60Hz

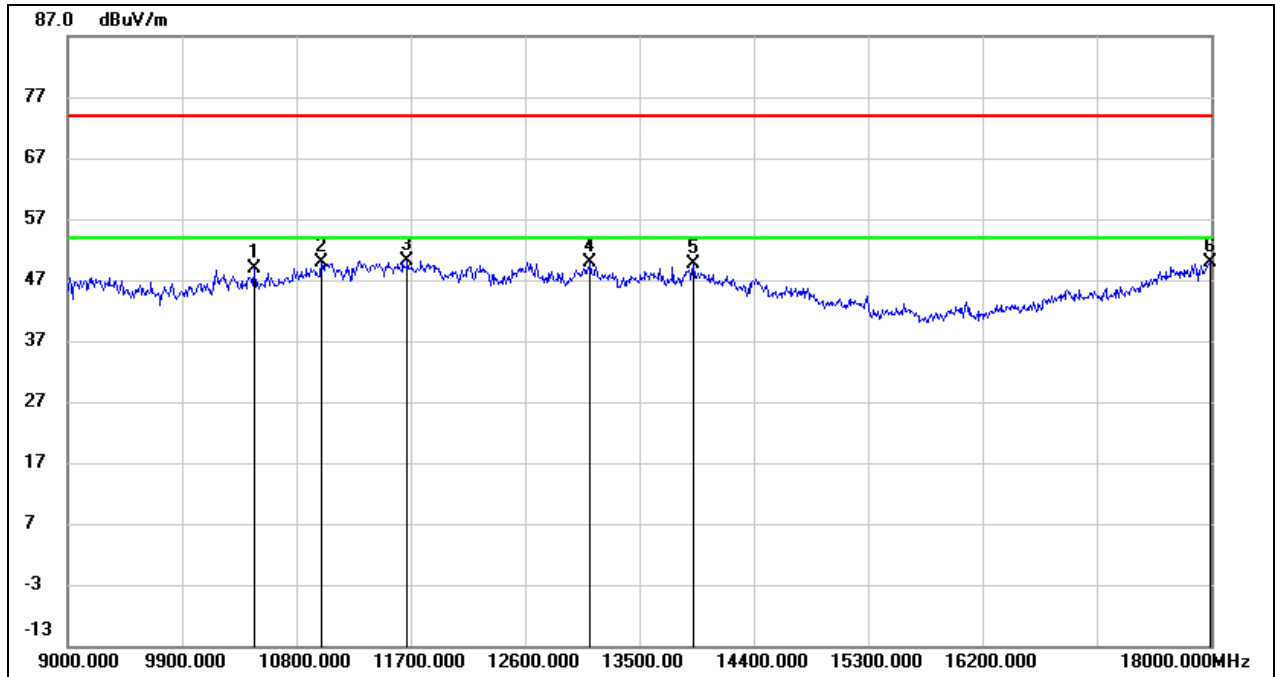

No.	Frequency (MHz)	Reading (dBuV)	Correct (dB/m)	Result (dBuV/m)	Limit (dBuV/m)	Margin (dB)	Remark
1	10467.000	35.77	13.05	48.82	74.00	-25.18	peak
2	10998.000	35.01	14.75	49.76	74.00	-24.24	peak
3	11673.000	33.25	17.00	50.25	74.00	-23.75	peak
4	13113.000	30.67	19.33	50.00	74.00	-24.00	peak
5	13923.000	27.92	21.72	49.64	74.00	-24.36	peak
6	17991.000	24.88	25.11	49.99	74.00	-24.01	peak

Test Mode:	802.11ax HE40	Channel:	6445
Polarity:	Horizontal	Test Voltage:	AC 120V_60Hz

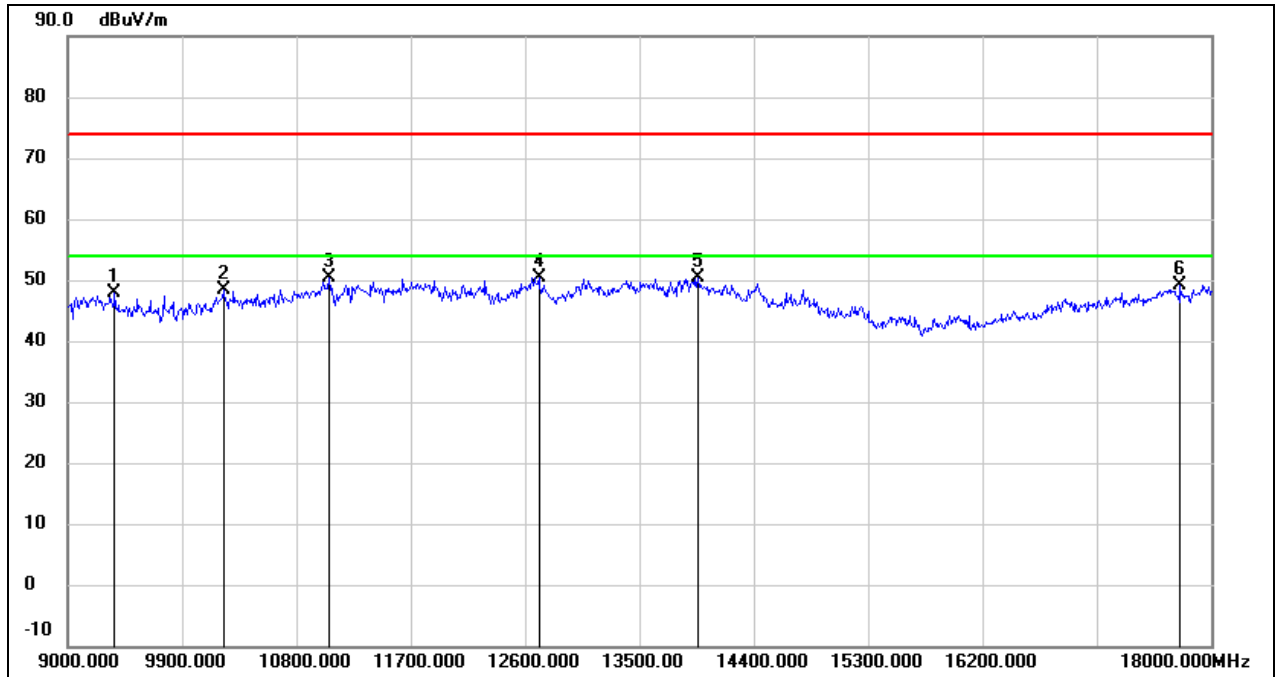

No.	Frequency (MHz)	Reading (dBuV)	Correct (dB/m)	Result (dBuV/m)	Limit (dBuV/m)	Margin (dB)	Remark
1	9369.000	36.93	10.87	47.80	74.00	-26.20	peak
2	10224.000	35.87	12.55	48.42	74.00	-25.58	peak
3	11061.000	35.31	14.96	50.27	74.00	-23.73	peak
4	12708.000	32.25	18.10	50.35	74.00	-23.65	peak
5	13959.000	28.56	21.79	50.35	74.00	-23.65	peak
6	17757.000	25.63	23.60	49.23	74.00	-24.77	peak

Test Mode:	802.11ax HE40	Channel:	6445
Polarity:	Vertical	Test Voltage:	AC 120V_60Hz

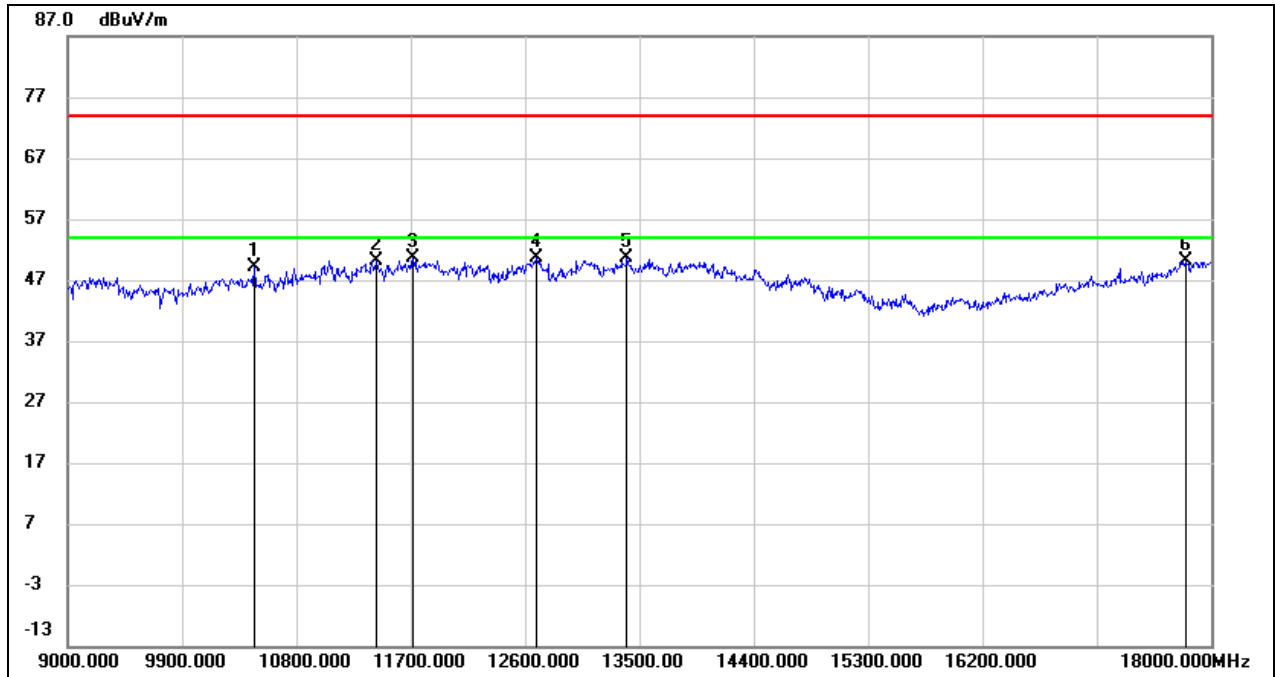

No.	Frequency (MHz)	Reading (dBuV)	Correct (dB/m)	Result (dBuV/m)	Limit (dBuV/m)	Margin (dB)	Remark
1	10467.000	36.03	13.05	49.08	74.00	-24.92	peak
2	11430.000	33.96	16.28	50.24	74.00	-23.76	peak
3	11718.000	33.46	17.13	50.59	74.00	-23.41	peak
4	12690.000	32.57	18.05	50.62	74.00	-23.38	peak
5	13401.000	30.15	20.43	50.58	74.00	-23.42	peak
6	17802.000	26.21	23.89	50.10	74.00	-23.90	peak

Test Mode:	802.11ax HE40	Channel:	6485
Polarity:	Horizontal	Test Voltage:	AC 120V_60Hz

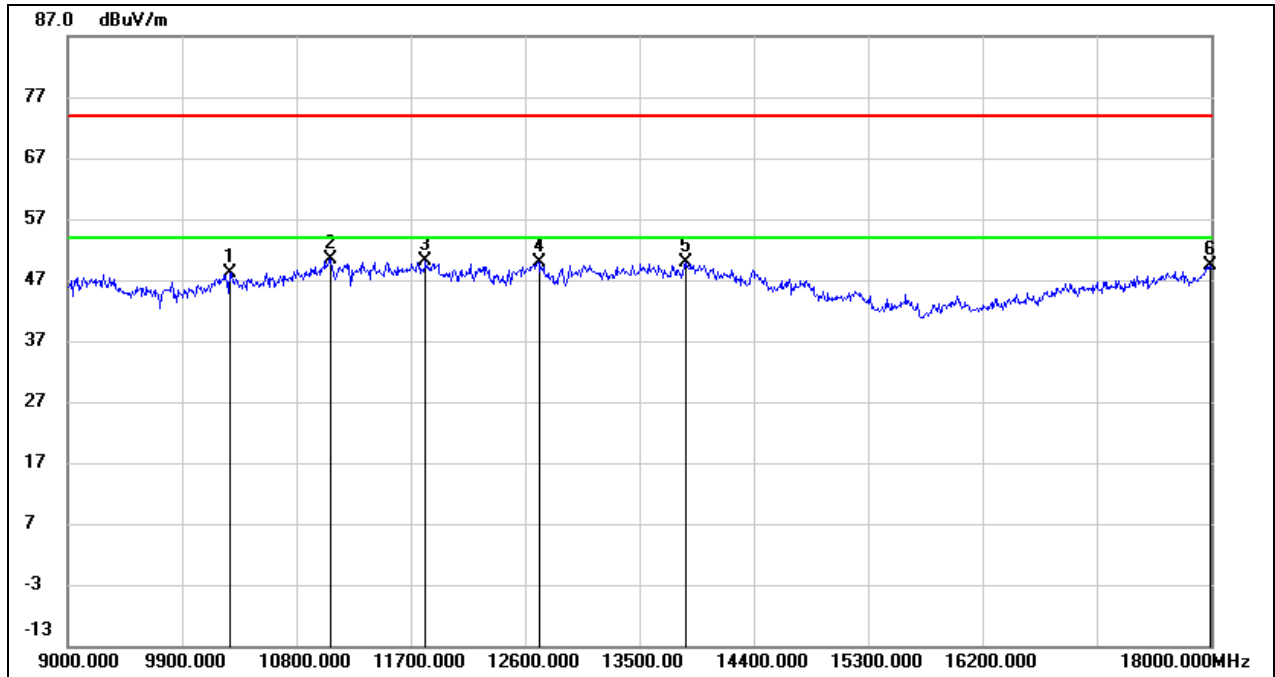

No.	Frequency (MHz)	Reading (dBuV)	Correct (dB/m)	Result (dBuV/m)	Limit (dBuV/m)	Margin (dB)	Remark
1	10278.000	35.54	12.66	48.20	74.00	-25.80	peak
2	11070.000	35.39	15.00	50.39	74.00	-23.61	peak
3	11817.000	32.73	17.40	50.13	74.00	-23.87	peak
4	12708.000	31.73	18.10	49.83	74.00	-24.17	peak
5	13869.000	28.30	21.59	49.89	74.00	-24.11	peak
6	17991.000	24.26	25.11	49.37	74.00	-24.63	peak

Test Mode:	802.11ax HE40	Channel:	6485
Polarity:	Vertical	Test Voltage:	AC 120V_60Hz

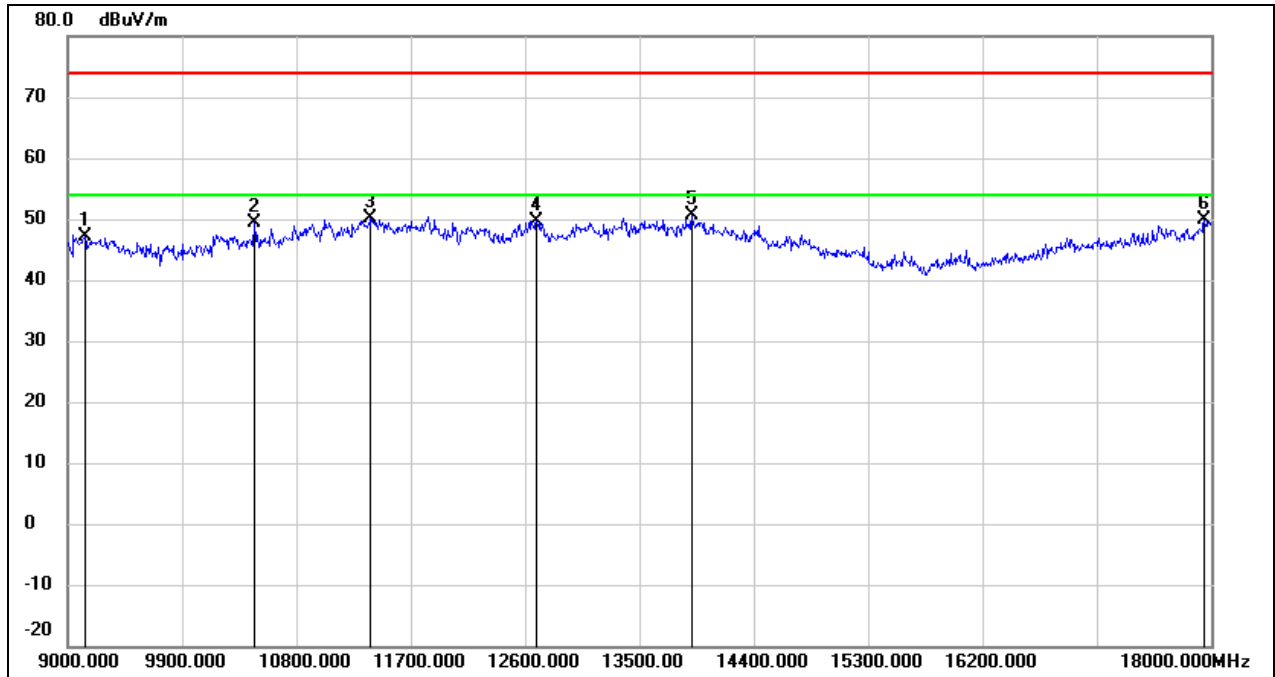

No.	Frequency (MHz)	Reading (dBuV)	Correct (dB/m)	Result (dBuV/m)	Limit (dBuV/m)	Margin (dB)	Remark
1	9135.000	36.22	10.84	47.06	74.00	-26.94	peak
2	10467.000	36.36	13.05	49.41	74.00	-24.59	peak
3	11385.000	33.99	16.12	50.11	74.00	-23.89	peak
4	12690.000	31.66	18.05	49.71	74.00	-24.29	peak
5	13914.000	28.91	21.69	50.60	74.00	-23.40	peak
6	17946.000	25.10	24.82	49.92	74.00	-24.08	peak

Test Mode:	802.11ax HE40	Channel:	6525
Polarity:	Horizontal	Test Voltage:	AC 120V_60Hz

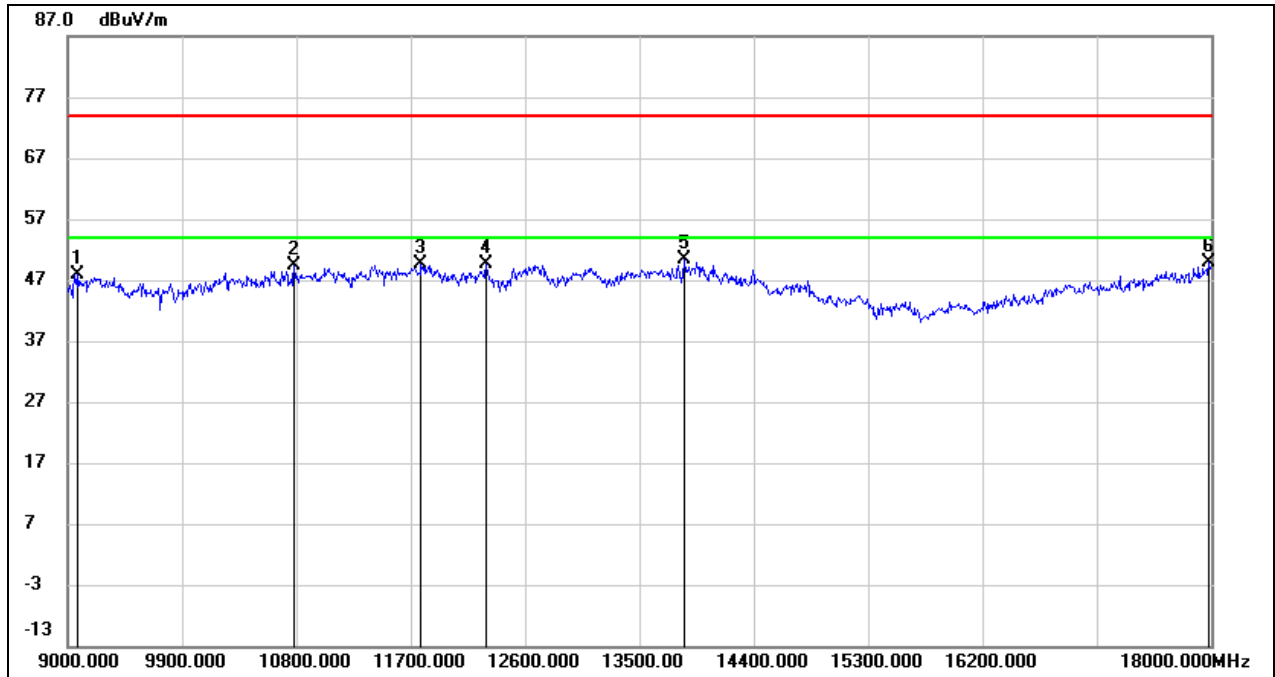

No.	Frequency (MHz)	Reading (dBuV)	Correct (dB/m)	Result (dBuV/m)	Limit (dBuV/m)	Margin (dB)	Remark
1	9081.000	37.10	10.82	47.92	74.00	-26.08	peak
2	10782.000	35.45	14.03	49.48	74.00	-24.52	peak
3	11781.000	32.32	17.30	49.62	74.00	-24.38	peak
4	12294.000	31.91	17.68	49.59	74.00	-24.41	peak
5	13851.000	28.89	21.56	50.45	74.00	-23.55	peak
6	17982.000	24.93	25.04	49.97	74.00	-24.03	peak

Test Mode:	802.11ax HE40	Channel:	6525
Polarity:	Vertical	Test Voltage:	AC 120V_60Hz

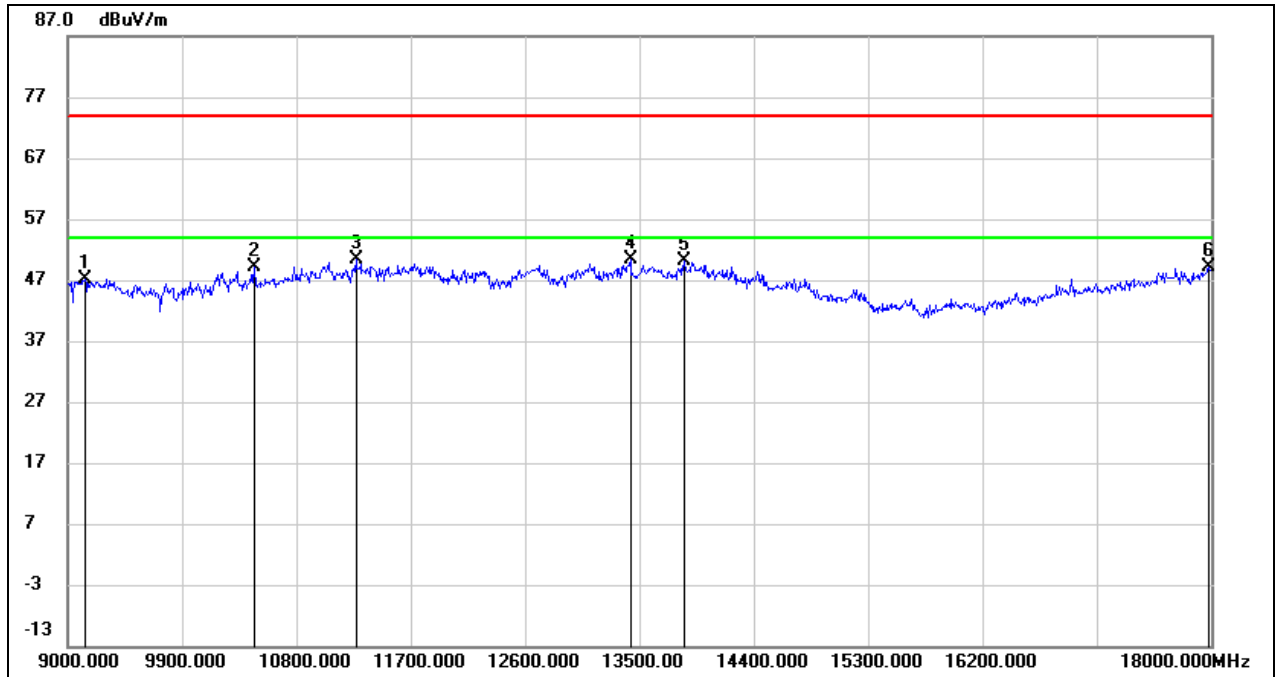

No.	Frequency (MHz)	Reading (dBuV)	Correct (dB/m)	Result (dBuV/m)	Limit (dBuV/m)	Margin (dB)	Remark
1	9135.000	36.39	10.84	47.23	74.00	-26.77	peak
2	10467.000	36.06	13.05	49.11	74.00	-24.89	peak
3	11268.000	34.63	15.71	50.34	74.00	-23.66	peak
4	13428.000	29.94	20.53	50.47	74.00	-23.53	peak
5	13851.000	28.48	21.56	50.04	74.00	-23.96	peak
6	17982.000	24.09	25.04	49.13	74.00	-24.87	peak

Test Mode:	802.11ax HE40	Channel:	6725
Polarity:	Horizontal	Test Voltage:	AC 120V_60Hz

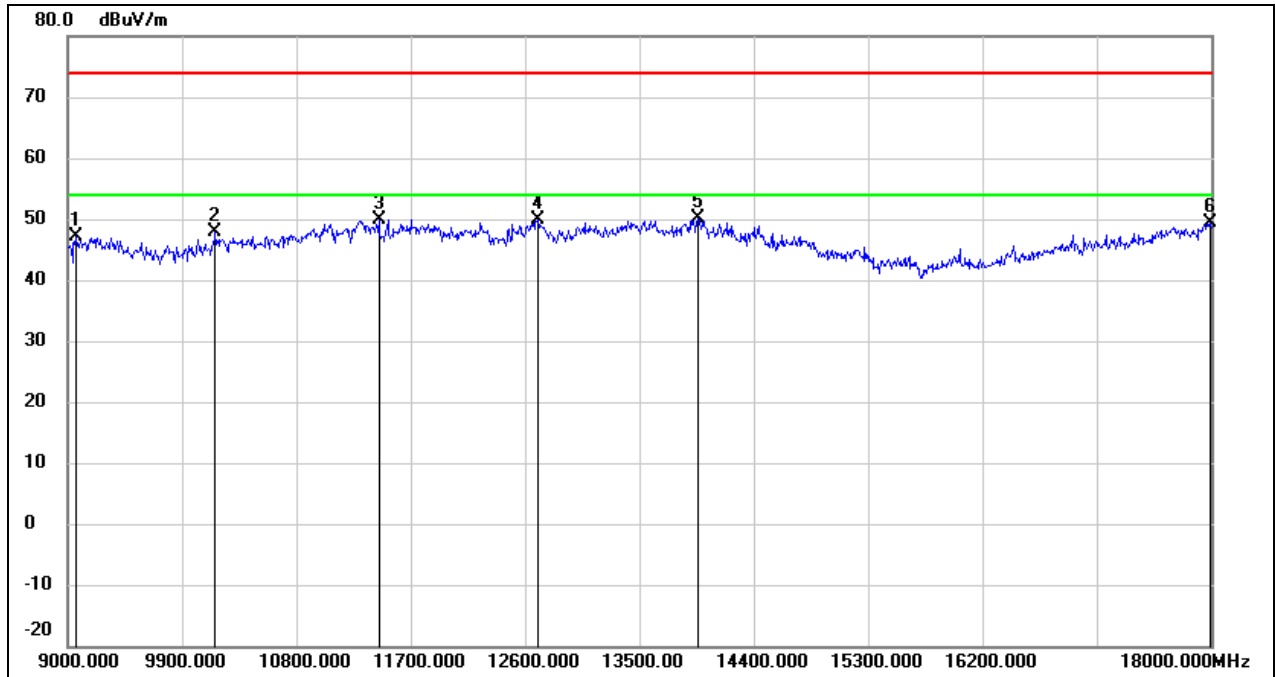

No.	Frequency (MHz)	Reading (dBuV)	Correct (dB/m)	Result (dBuV/m)	Limit (dBuV/m)	Margin (dB)	Remark
1	9063.000	36.21	10.82	47.03	74.00	-26.97	peak
2	10161.000	35.54	12.42	47.96	74.00	-26.04	peak
3	11448.000	33.57	16.34	49.91	74.00	-24.09	peak
4	12699.000	31.70	18.07	49.77	74.00	-24.23	peak
5	13959.000	28.45	21.79	50.24	74.00	-23.76	peak
6	17991.000	24.39	25.11	49.50	74.00	-24.50	peak

Test Mode:	802.11ax HE40	Channel:	6725
Polarity:	Vertical	Test Voltage:	AC 120V_60Hz

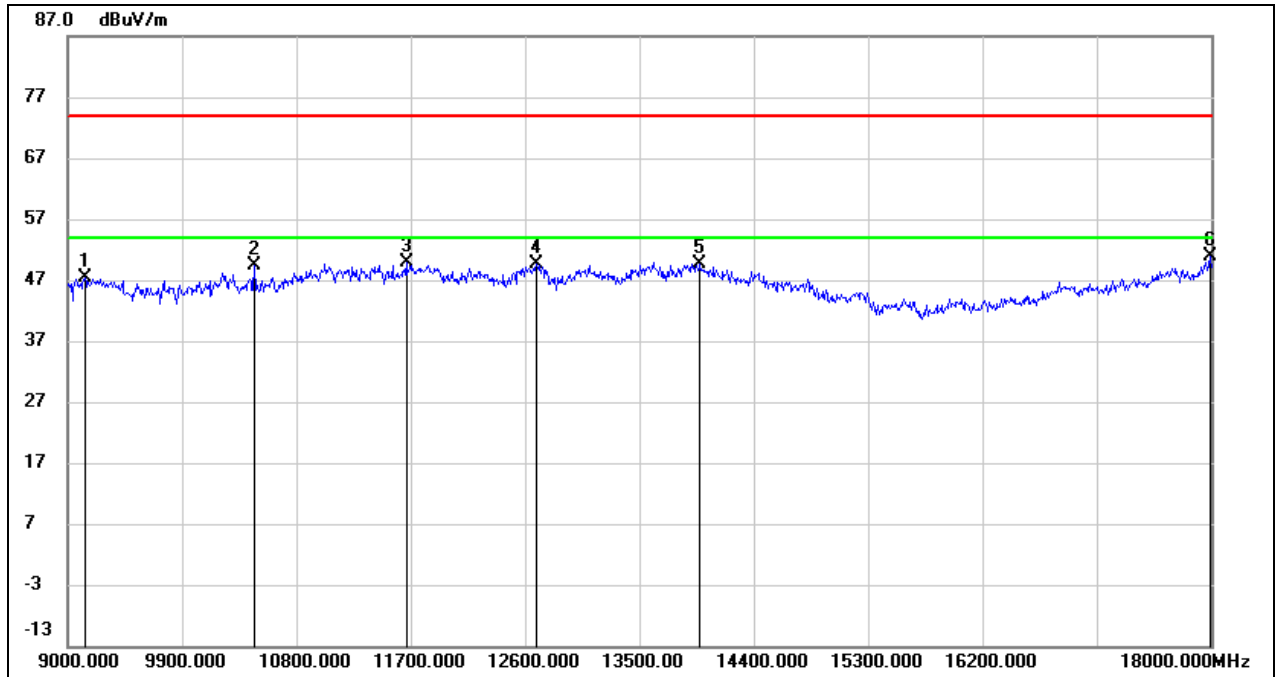

No.	Frequency (MHz)	Reading (dBuV)	Correct (dB/m)	Result (dBuV/m)	Limit (dBuV/m)	Margin (dB)	Remark
1	9135.000	36.53	10.84	47.37	74.00	-26.63	peak
2	10467.000	36.34	13.05	49.39	74.00	-24.61	peak
3	11664.000	32.80	16.98	49.78	74.00	-24.22	peak
4	12690.000	31.56	18.05	49.61	74.00	-24.39	peak
5	13977.000	27.81	21.83	49.64	74.00	-24.36	peak
6	17991.000	25.88	25.11	50.99	74.00	-23.01	peak

Test Mode:	802.11ax HE40	Channel:	6845
Polarity:	Horizontal	Test Voltage:	AC 120V_60Hz

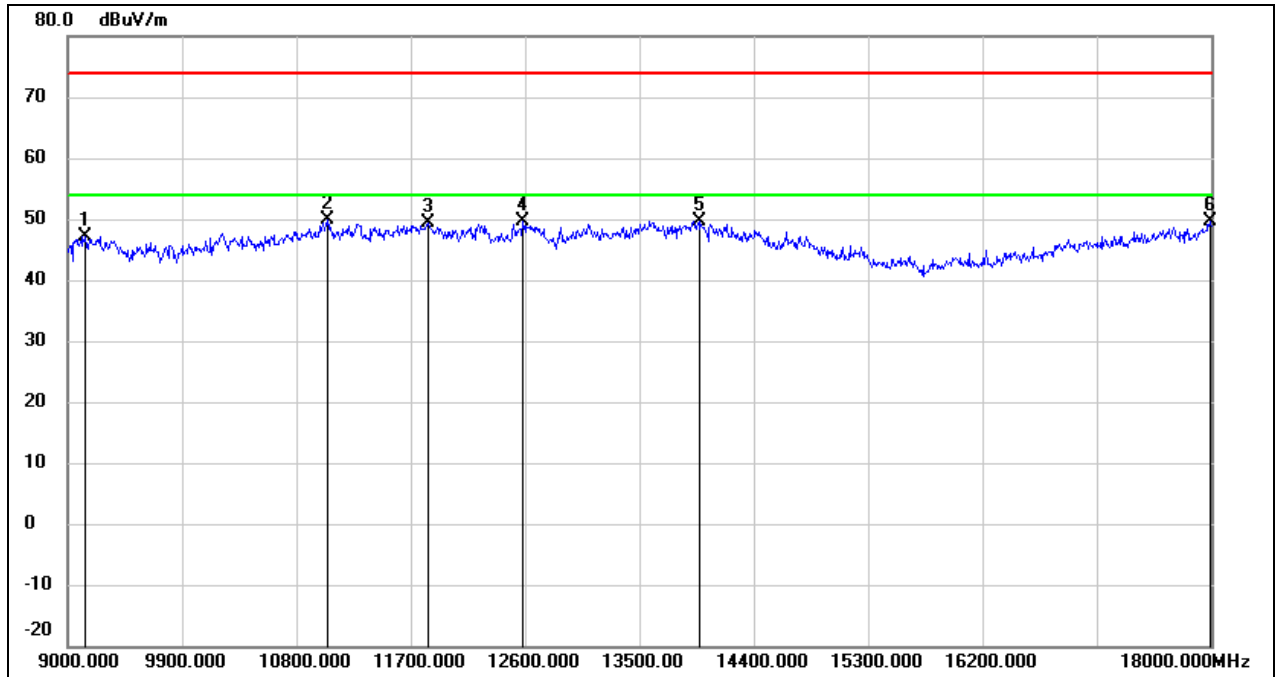

No.	Frequency (MHz)	Reading (dBuV)	Correct (dB/m)	Result (dBuV/m)	Limit (dBuV/m)	Margin (dB)	Remark
1	9135.000	36.21	10.84	47.05	74.00	-26.95	peak
2	11043.000	34.95	14.90	49.85	74.00	-24.15	peak
3	11835.000	31.98	17.46	49.44	74.00	-24.56	peak
4	12582.000	31.84	17.76	49.60	74.00	-24.40	peak
5	13968.000	27.87	21.81	49.68	74.00	-24.32	peak
6	17991.000	24.42	25.11	49.53	74.00	-24.47	peak

Test Mode:	802.11ax HE40	Channel:	6845
Polarity:	Vertical	Test Voltage:	AC 120V_60Hz

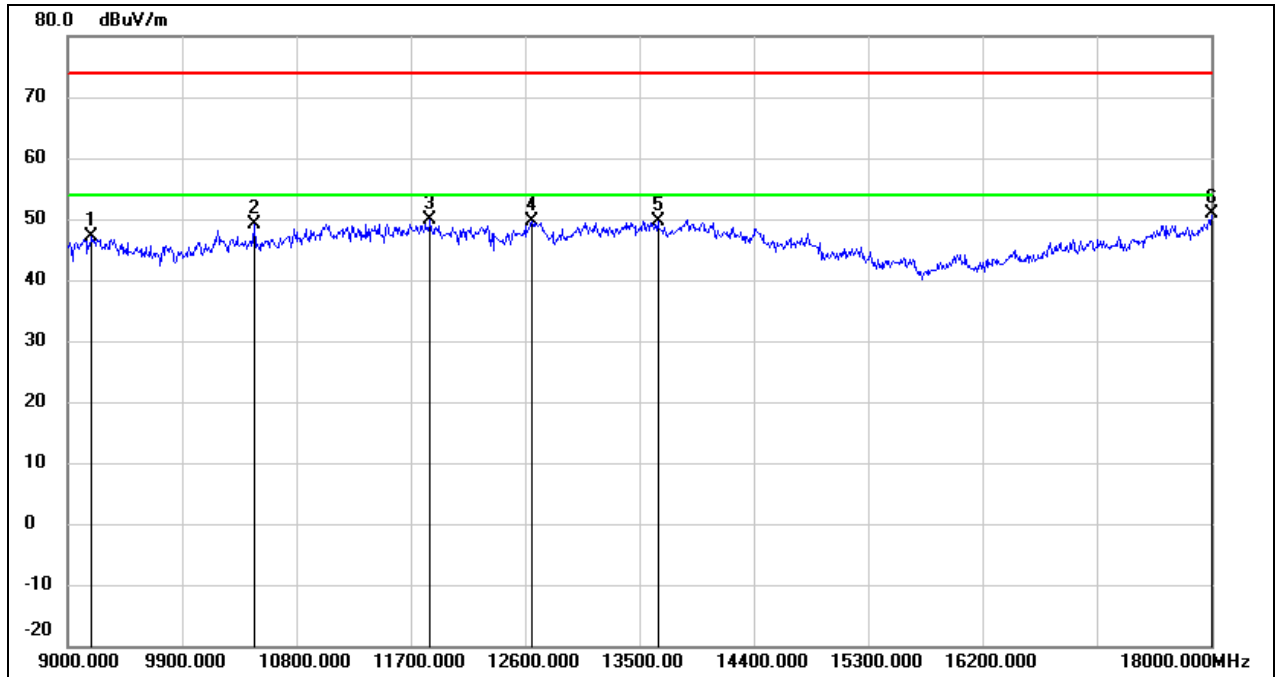

No.	Frequency (MHz)	Reading (dBuV)	Correct (dB/m)	Result (dBuV/m)	Limit (dBuV/m)	Margin (dB)	Remark
1	9189.000	36.29	10.84	47.13	74.00	-26.87	peak
2	10467.000	36.02	13.05	49.07	74.00	-24.93	peak
3	11853.000	32.41	17.50	49.91	74.00	-24.09	peak
4	12654.000	31.75	17.94	49.69	74.00	-24.31	peak
5	13644.000	28.61	21.11	49.72	74.00	-24.28	peak
6	18000.000	25.62	25.16	50.78	74.00	-23.22	peak

Test Mode:	802.11ax HE40	Channel:	6885
Polarity:	Horizontal	Test Voltage:	AC 120V_60Hz

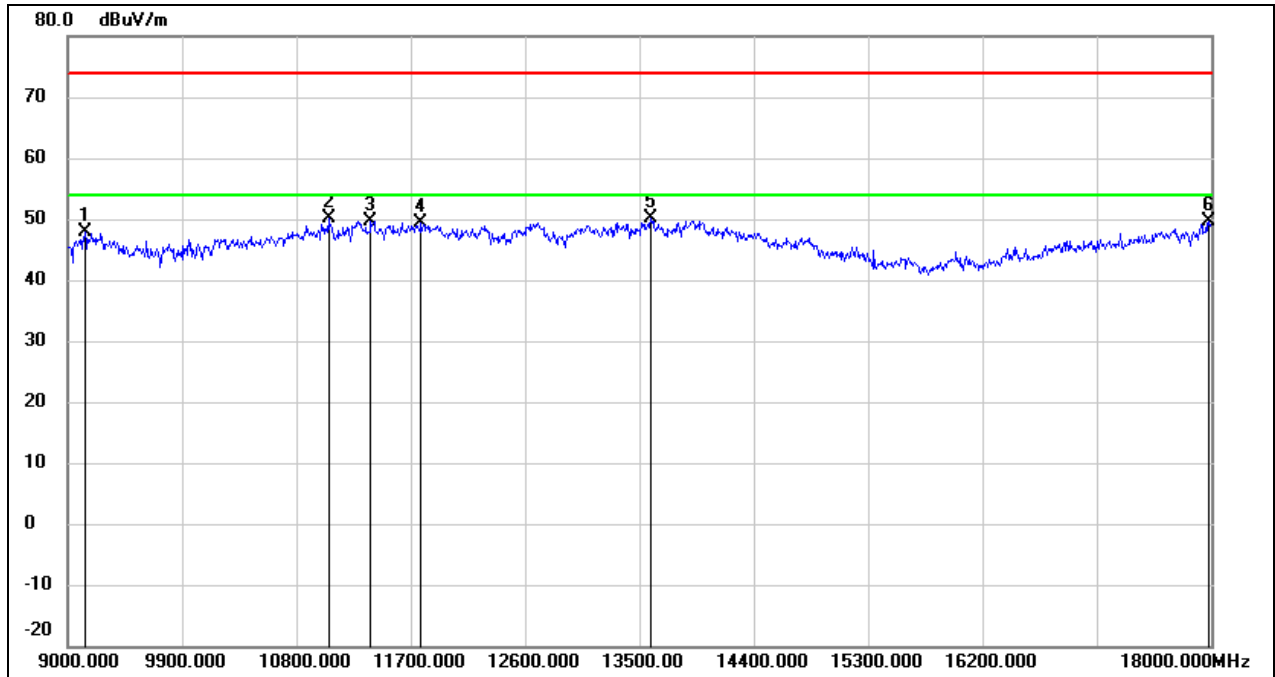

No.	Frequency (MHz)	Reading (dBuV)	Correct (dB/m)	Result (dBuV/m)	Limit (dBuV/m)	Margin (dB)	Remark
1	9135.000	36.98	10.84	47.82	74.00	-26.18	peak
2	11052.000	35.11	14.94	50.05	74.00	-23.95	peak
3	11385.000	33.63	16.12	49.75	74.00	-24.25	peak
4	11781.000	32.13	17.30	49.43	74.00	-24.57	peak
5	13590.000	29.01	21.00	50.01	74.00	-23.99	peak
6	17982.000	24.70	25.04	49.74	74.00	-24.26	peak

Test Mode:	802.11ax HE40	Channel:	6885
Polarity:	Vertical	Test Voltage:	AC 120V_60Hz

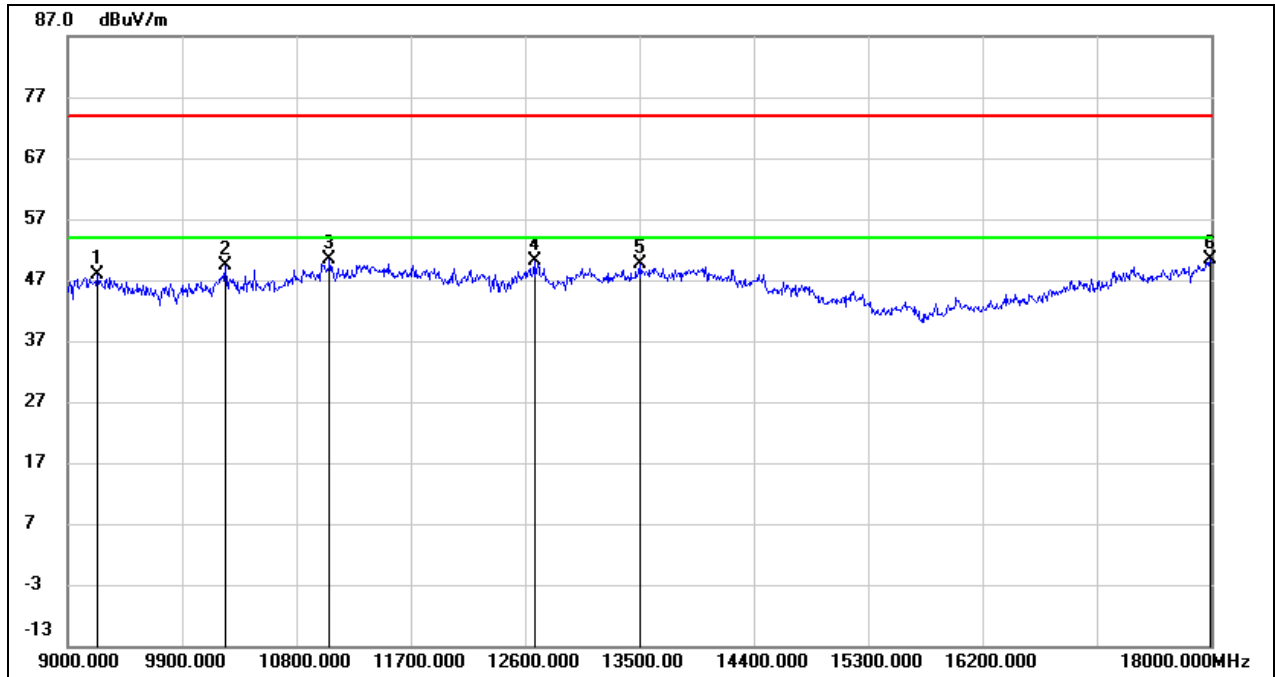

No.	Frequency (MHz)	Reading (dBuV)	Correct (dB/m)	Result (dBuV/m)	Limit (dBuV/m)	Margin (dB)	Remark
1	9234.000	36.99	10.84	47.83	74.00	-26.17	peak
2	10242.000	36.89	12.58	49.47	74.00	-24.53	peak
3	11061.000	35.38	14.96	50.34	74.00	-23.66	peak
4	12672.000	32.23	18.00	50.23	74.00	-23.77	peak
5	13500.000	28.77	20.81	49.58	74.00	-24.42	peak
6	17991.000	25.23	25.11	50.34	74.00	-23.66	peak

Test Mode:	802.11ax HE40	Channel:	7005
Polarity:	Horizontal	Test Voltage:	AC 120V_60Hz

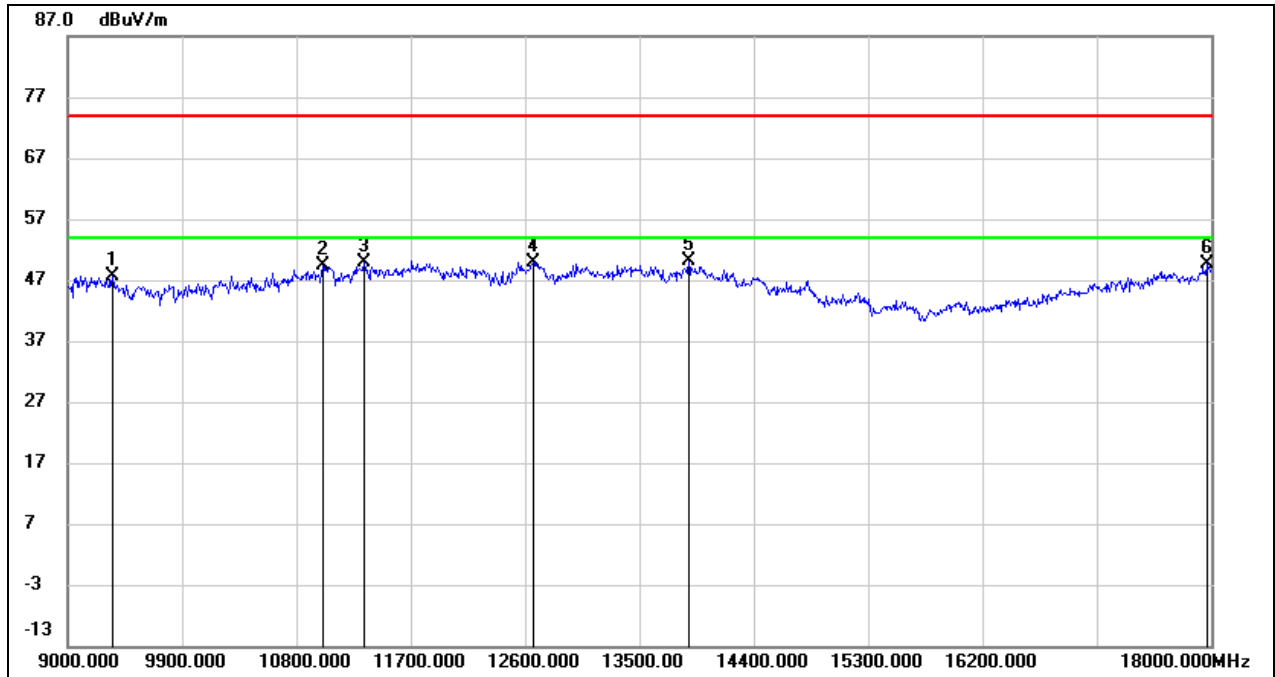

No.	Frequency (MHz)	Reading (dBuV)	Correct (dB/m)	Result (dBuV/m)	Limit (dBuV/m)	Margin (dB)	Remark
1	9351.000	36.76	10.86	47.62	74.00	-26.38	peak
2	11007.000	34.64	14.77	49.41	74.00	-24.59	peak
3	11331.000	34.01	15.93	49.94	74.00	-24.06	peak
4	12663.000	31.93	17.98	49.91	74.00	-24.09	peak
5	13887.000	28.42	21.64	50.06	74.00	-23.94	peak
6	17964.000	24.81	24.92	49.73	74.00	-24.27	peak

Test Mode:	802.11ax HE40	Channel:	7005
Polarity:	Vertical	Test Voltage:	AC 120V_60Hz

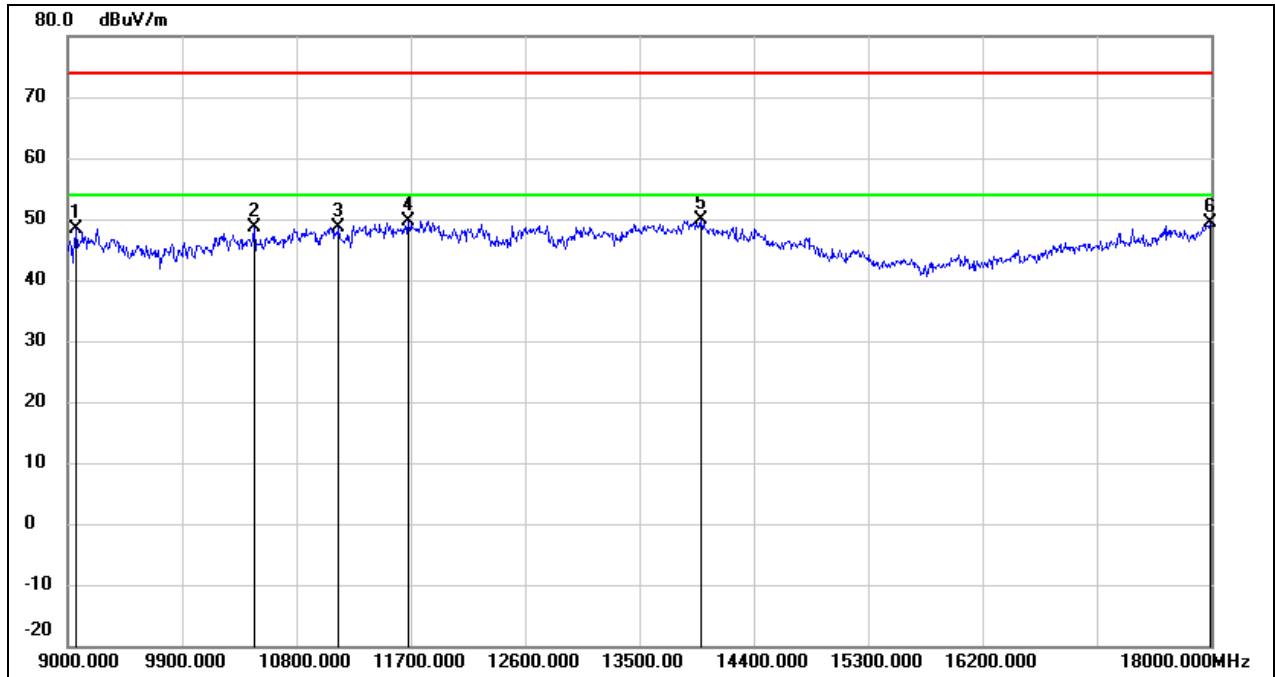

No.	Frequency (MHz)	Reading (dBuV)	Correct (dB/m)	Result (dBuV/m)	Limit (dBuV/m)	Margin (dB)	Remark
1	9063.000	37.56	10.82	48.38	74.00	-25.62	peak
2	10467.000	35.58	13.05	48.63	74.00	-25.37	peak
3	11133.000	33.47	15.23	48.70	74.00	-25.30	peak
4	11682.000	32.63	17.04	49.67	74.00	-24.33	peak
5	13986.000	28.00	21.85	49.85	74.00	-24.15	peak
6	17991.000	24.19	25.11	49.30	74.00	-24.70	peak

Test Mode:	802.11ax HE40	Channel:	7085
Polarity:	Horizontal	Test Voltage:	AC 120V_60Hz

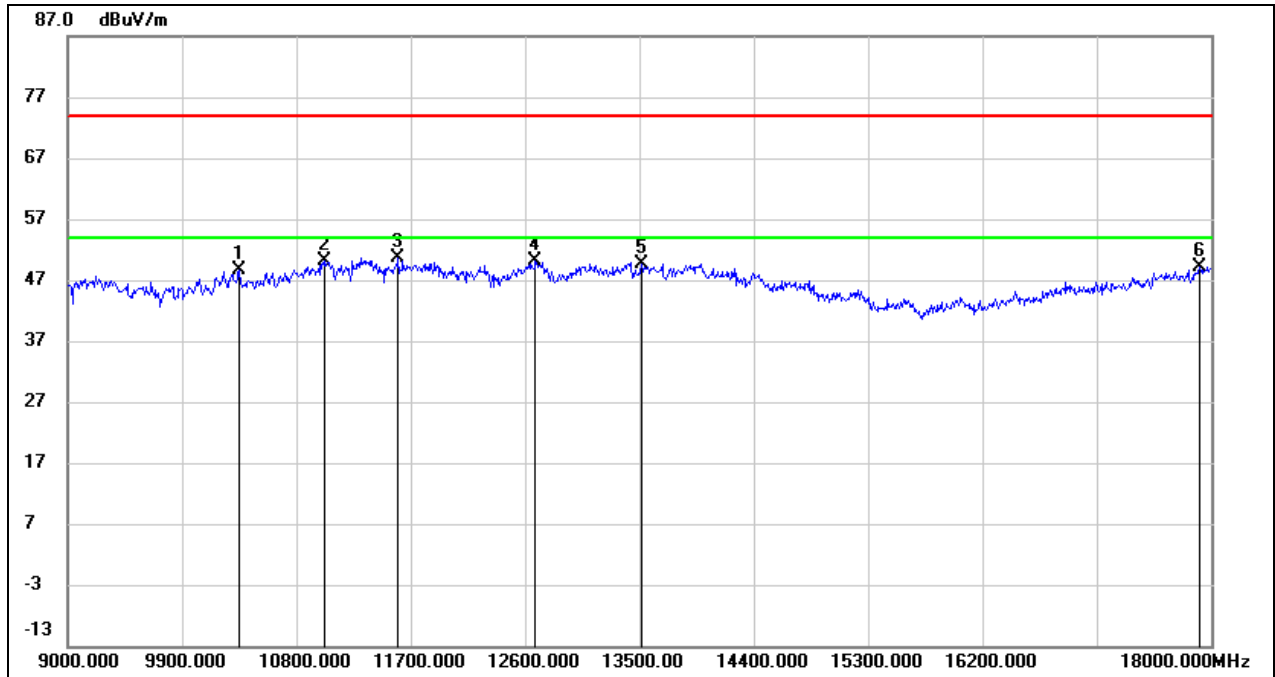

No.	Frequency (MHz)	Reading (dBuV)	Correct (dB/m)	Result (dBuV/m)	Limit (dBuV/m)	Margin (dB)	Remark
1	10350.000	35.93	12.81	48.74	74.00	-25.26	peak
2	11025.000	35.39	14.83	50.22	74.00	-23.78	peak
3	11601.000	33.77	16.81	50.58	74.00	-23.42	peak
4	12681.000	32.13	18.03	50.16	74.00	-23.84	peak
5	13518.000	28.82	20.85	49.67	74.00	-24.33	peak
6	17910.000	24.63	24.59	49.22	74.00	-24.78	peak

Test Mode:	802.11ax HE40	Channel:	7085
Polarity:	Vertical	Test Voltage:	AC 120V_60Hz

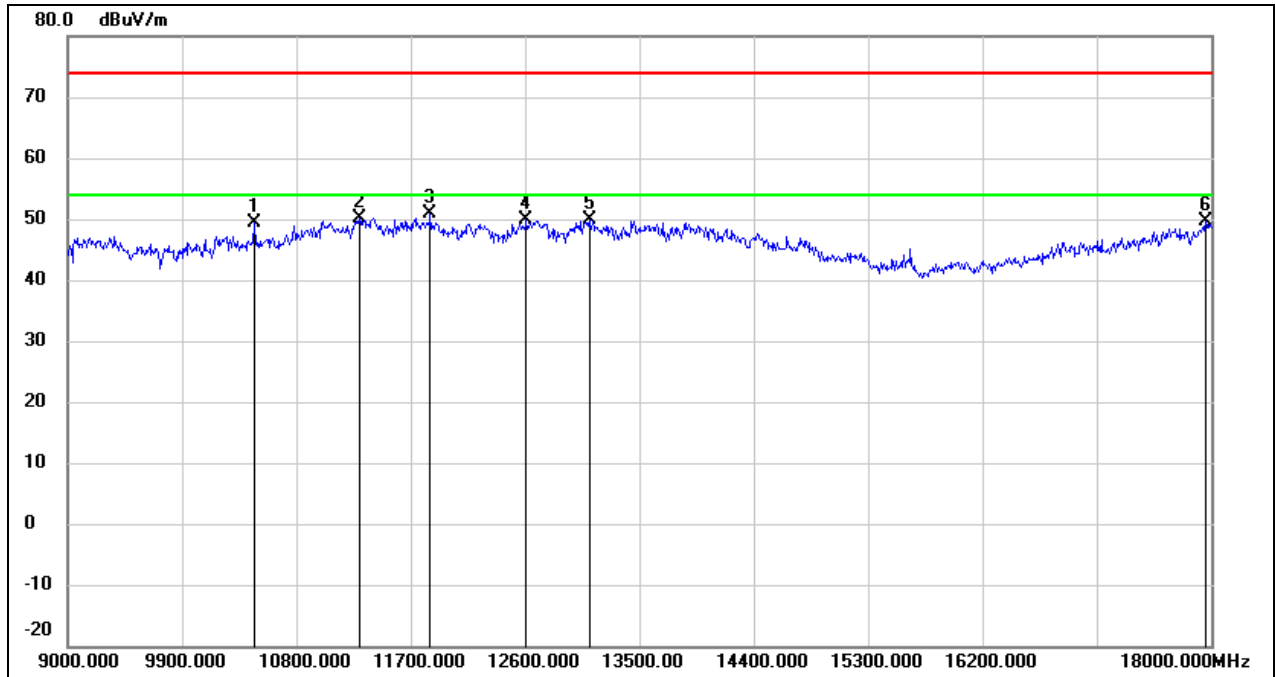

No.	Frequency (MHz)	Reading (dBuV)	Correct (dB/m)	Result (dBuV/m)	Limit (dBuV/m)	Margin (dB)	Remark
1	10467.000	36.25	13.05	49.30	74.00	-24.70	peak
2	11295.000	34.39	15.80	50.19	74.00	-23.81	peak
3	11853.000	33.27	17.50	50.77	74.00	-23.23	peak
4	12609.000	32.01	17.83	49.84	74.00	-24.16	peak
5	13104.000	30.55	19.29	49.84	74.00	-24.16	peak
6	17955.000	24.78	24.87	49.65	74.00	-24.35	peak

Test Mode:	802.11ax HE80	Channel:	6145
Polarity:	Horizontal	Test Voltage:	AC 120V_60Hz

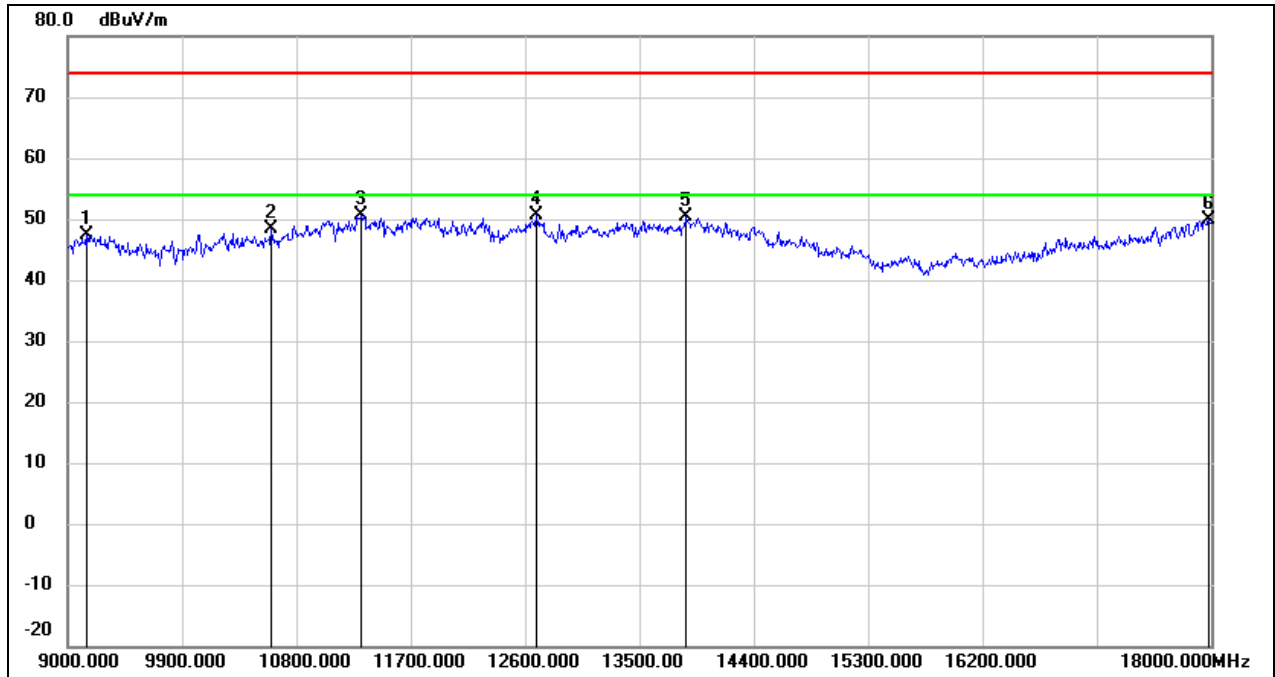

No.	Frequency (MHz)	Reading (dBuV)	Correct (dB/m)	Result (dBuV/m)	Limit (dBuV/m)	Margin (dB)	Remark
1	9144.000	36.61	10.83	47.44	74.00	-26.56	peak
2	10602.000	34.86	13.45	48.31	74.00	-25.69	peak
3	11313.000	34.76	15.86	50.62	74.00	-23.38	peak
4	12690.000	32.51	18.05	50.56	74.00	-23.44	peak
5	13869.000	28.78	21.59	50.37	74.00	-23.63	peak
6	17982.000	24.96	25.04	50.00	74.00	-24.00	peak

Test Mode:	802.11ax HE80	Channel:	6145
Polarity:	Vertical	Test Voltage:	AC 120V_60Hz

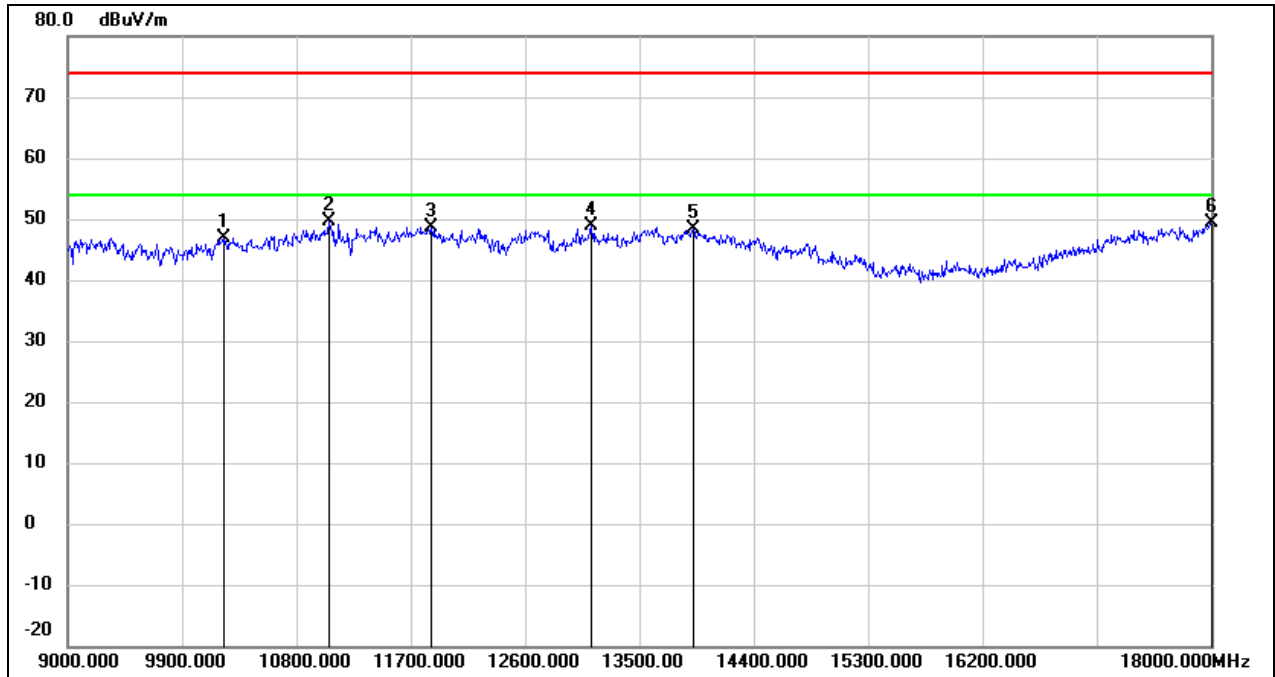

No.	Frequency (MHz)	Reading (dBuV)	Correct (dB/m)	Result (dBuV/m)	Limit (dBuV/m)	Margin (dB)	Remark
1	10224.000	34.35	12.55	46.90	74.00	-27.10	peak
2	11052.000	34.68	14.94	49.62	74.00	-24.38	peak
3	11862.000	31.16	17.53	48.69	74.00	-25.31	peak
4	13122.000	29.45	19.36	48.81	74.00	-25.19	peak
5	13923.000	26.58	21.72	48.30	74.00	-25.70	peak
6	18000.000	24.31	25.16	49.47	74.00	-24.53	peak

Test Mode:	802.11ax HE80	Channel:	6225
Polarity:	Horizontal	Test Voltage:	AC 120V_60Hz

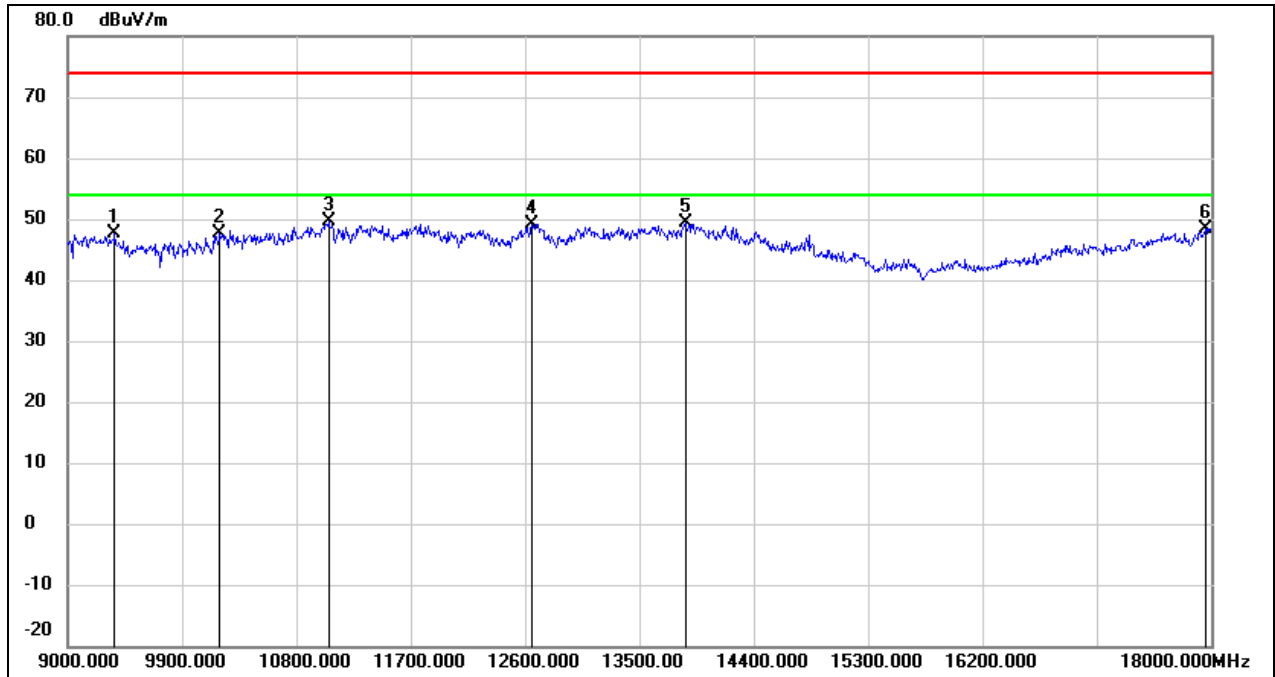

No.	Frequency (MHz)	Reading (dBuV)	Correct (dB/m)	Result (dBuV/m)	Limit (dBuV/m)	Margin (dB)	Remark
1	9369.000	36.85	10.87	47.72	74.00	-26.28	peak
2	10197.000	35.13	12.49	47.62	74.00	-26.38	peak
3	11052.000	34.67	14.94	49.61	74.00	-24.39	peak
4	12654.000	31.19	17.94	49.13	74.00	-24.87	peak
5	13860.000	27.88	21.59	49.47	74.00	-24.53	peak
6	17955.000	23.61	24.87	48.48	74.00	-25.52	peak

Test Mode:	802.11ax HE80	Channel:	6225
Polarity:	Vertical	Test Voltage:	AC 120V_60Hz

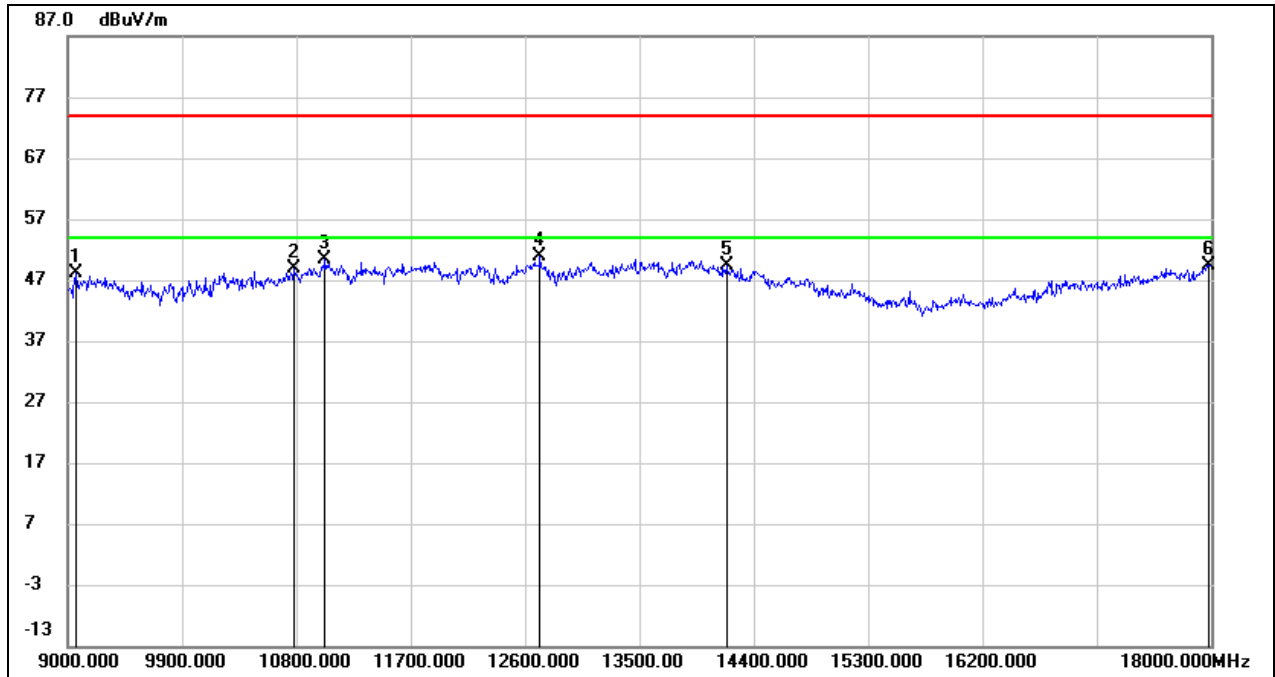

No.	Frequency (MHz)	Reading (dBuV)	Correct (dB/m)	Result (dBuV/m)	Limit (dBuV/m)	Margin (dB)	Remark
1	9063.000	37.29	10.82	48.11	74.00	-25.89	peak
2	10782.000	34.82	14.03	48.85	74.00	-25.15	peak
3	11025.000	35.53	14.83	50.36	74.00	-23.64	peak
4	12717.000	32.79	18.11	50.90	74.00	-23.10	peak
5	14184.000	28.28	21.06	49.34	74.00	-24.66	peak
6	17982.000	24.42	25.04	49.46	74.00	-24.54	peak

Test Mode:	802.11ax HE80	Channel:	6385
Polarity:	Horizontal	Test Voltage:	AC 120V_60Hz

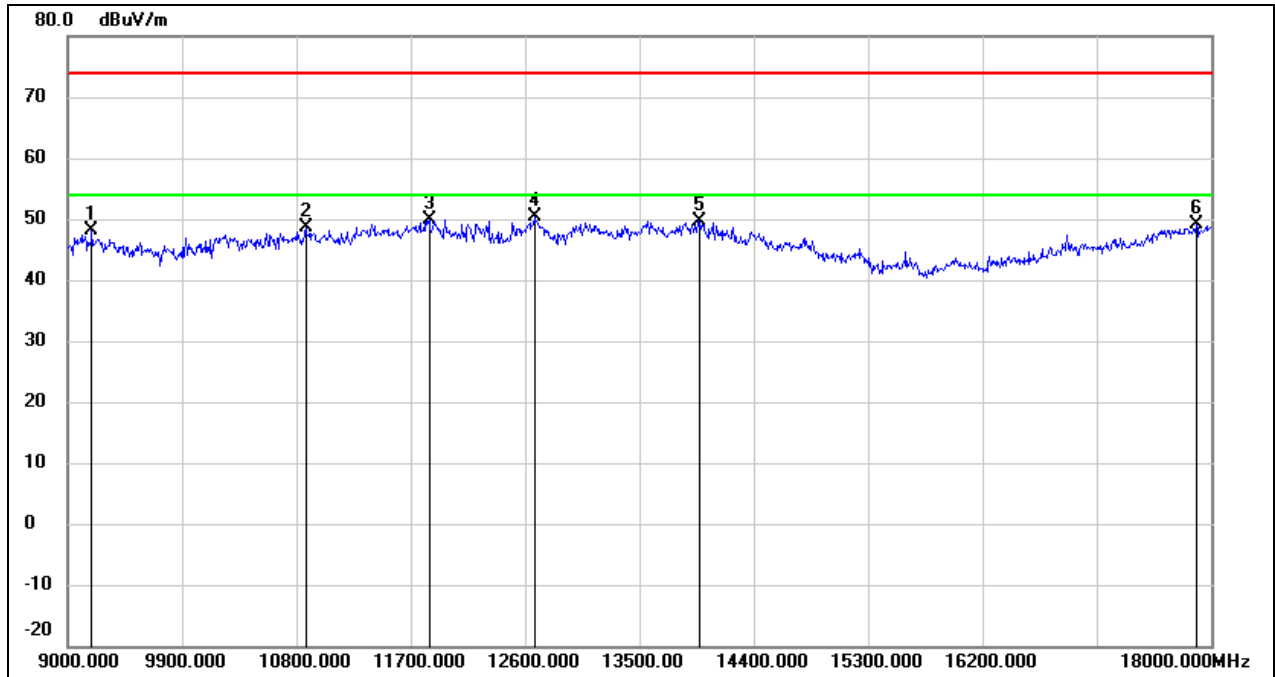

No.	Frequency (MHz)	Reading (dBuV)	Correct (dB/m)	Result (dBuV/m)	Limit (dBuV/m)	Margin (dB)	Remark
1	9189.000	37.25	10.84	48.09	74.00	-25.91	peak
2	10872.000	34.32	14.33	48.65	74.00	-25.35	peak
3	11844.000	32.48	17.48	49.96	74.00	-24.04	peak
4	12672.000	32.38	18.00	50.38	74.00	-23.62	peak
5	13977.000	27.81	21.83	49.64	74.00	-24.36	peak
6	17883.000	24.82	24.41	49.23	74.00	-24.77	peak

Test Mode:	802.11ax HE80	Channel:	6385
Polarity:	Vertical	Test Voltage:	AC 120V_60Hz

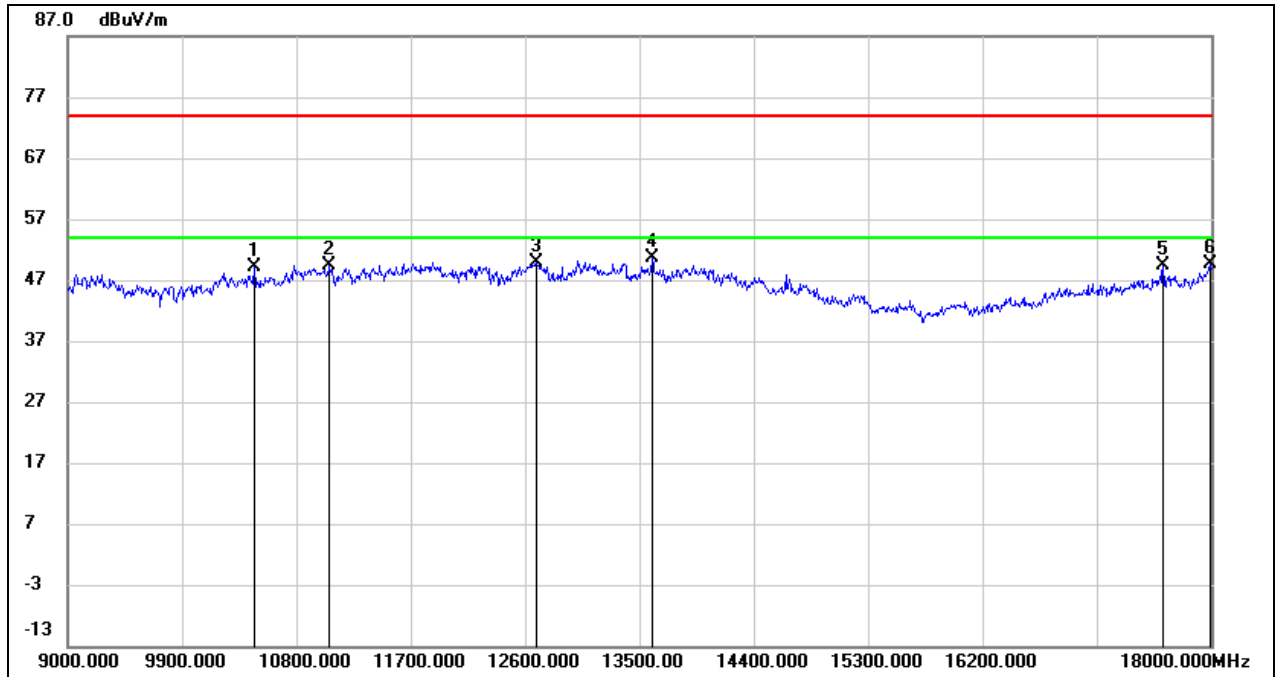

No.	Frequency (MHz)	Reading (dBuV)	Correct (dB/m)	Result (dBuV/m)	Limit (dBuV/m)	Margin (dB)	Remark
1	10467.000	35.98	13.05	49.03	74.00	-24.97	peak
2	11061.000	34.45	14.96	49.41	74.00	-24.59	peak
3	12690.000	31.82	18.05	49.87	74.00	-24.13	peak
4	13599.000	29.71	21.02	50.73	74.00	-23.27	peak
5	17622.000	26.66	22.74	49.40	74.00	-24.60	peak
6	17991.000	24.63	25.11	49.74	74.00	-24.26	peak

Test Mode:	802.11ax HE80	Channel:	6465
Polarity:	Horizontal	Test Voltage:	AC 120V_60Hz

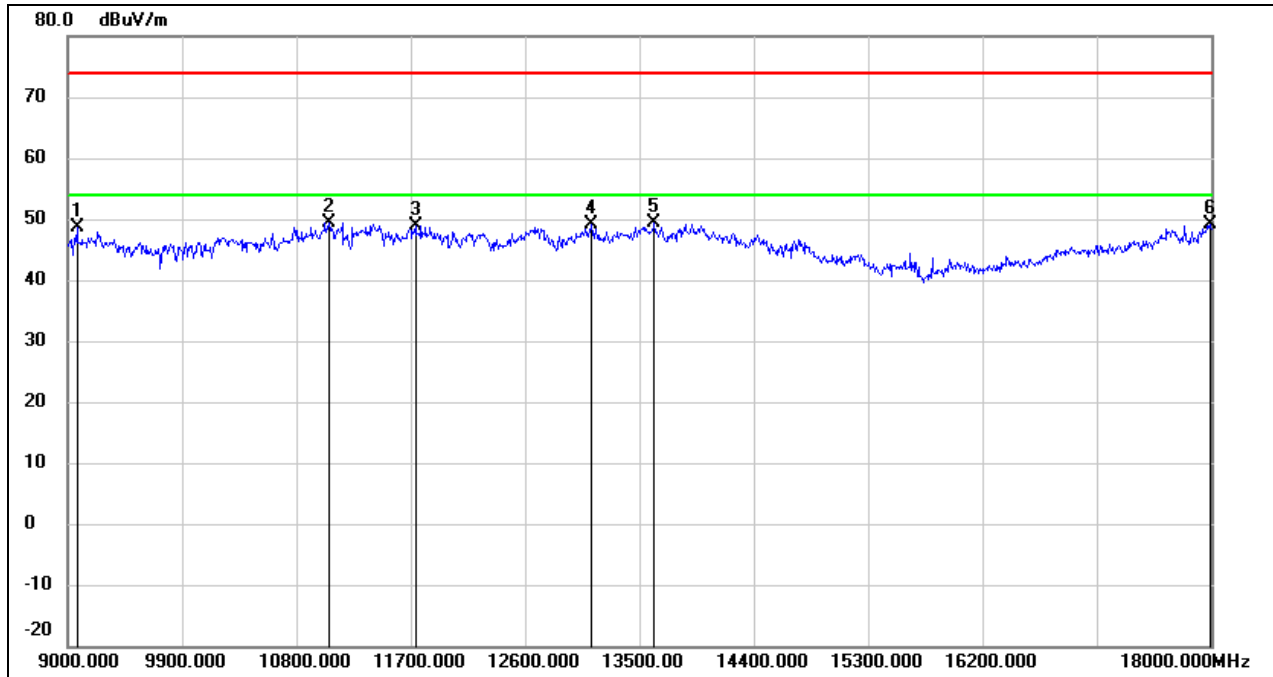

No.	Frequency (MHz)	Reading (dBuV)	Correct (dB/m)	Result (dBuV/m)	Limit (dBuV/m)	Margin (dB)	Remark
1	9072.000	37.70	10.82	48.52	74.00	-25.48	peak
2	11061.000	34.43	14.96	49.39	74.00	-24.61	peak
3	11736.000	31.62	17.18	48.80	74.00	-25.20	peak
4	13122.000	29.75	19.36	49.11	74.00	-24.89	peak
5	13617.000	28.33	21.06	49.39	74.00	-24.61	peak
6	17991.000	24.01	25.11	49.12	74.00	-24.88	peak

Test Mode:	802.11ax HE80	Channel:	6465
Polarity:	Vertical	Test Voltage:	AC 120V_60Hz

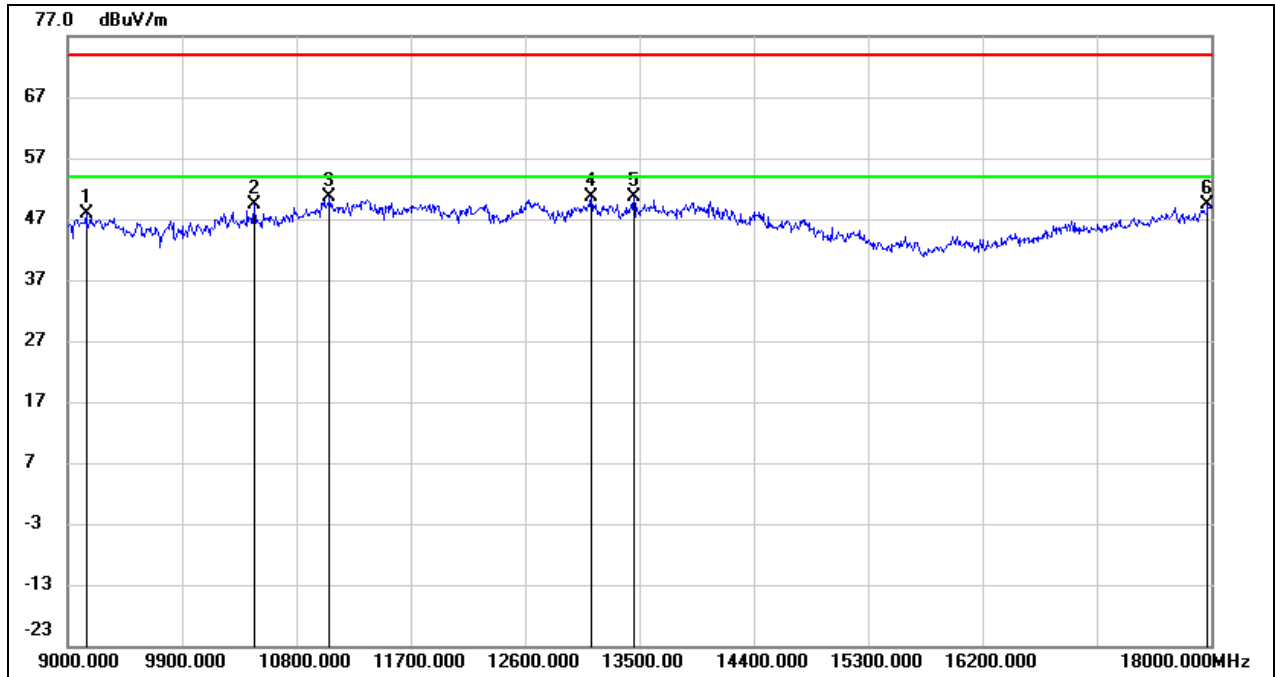

No.	Frequency (MHz)	Reading (dBuV)	Correct (dB/m)	Result (dBuV/m)	Limit (dBuV/m)	Margin (dB)	Remark
1	9144.000	36.98	10.83	47.81	74.00	-26.19	peak
2	10467.000	36.38	13.05	49.43	74.00	-24.57	peak
3	11061.000	35.66	14.96	50.62	74.00	-23.38	peak
4	13122.000	31.20	19.36	50.56	74.00	-23.44	peak
5	13455.000	29.91	20.64	50.55	74.00	-23.45	peak
6	17973.000	24.39	24.99	49.38	74.00	-24.62	peak

Test Mode:	802.11ax HE80	Channel:	6545
Polarity:	Horizontal	Test Voltage:	AC 120V_60Hz

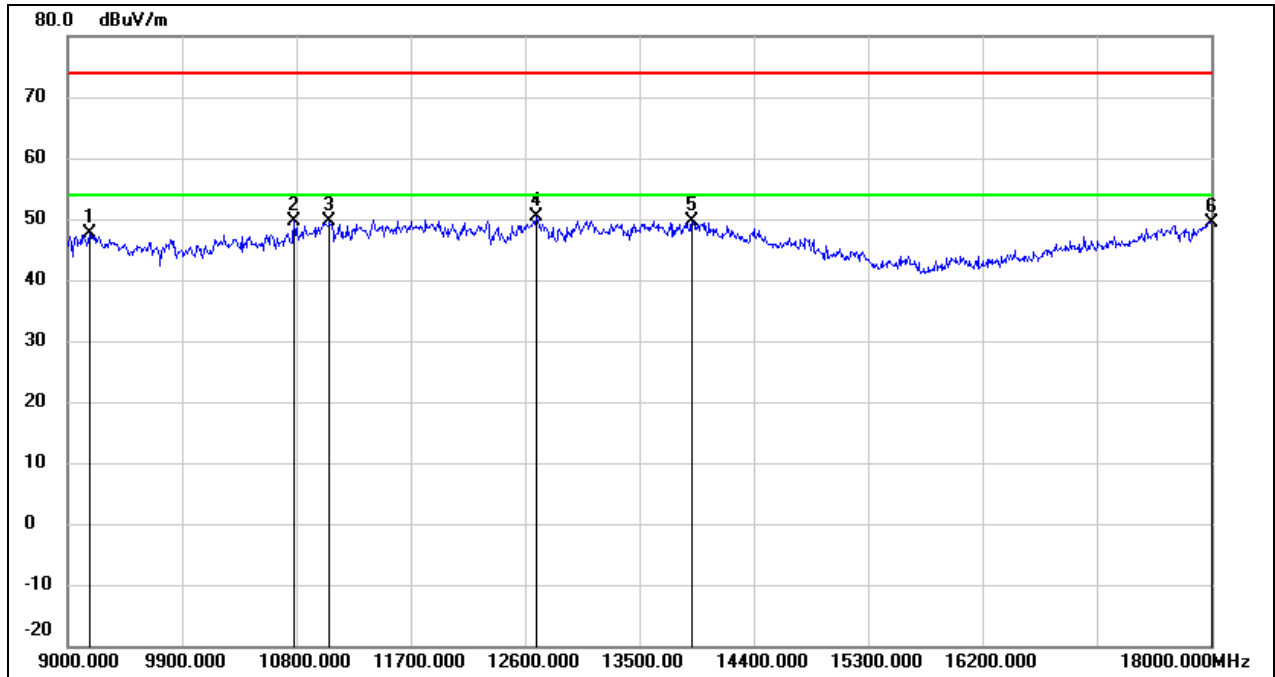

No.	Frequency (MHz)	Reading (dBuV)	Correct (dB/m)	Result (dBuV/m)	Limit (dBuV/m)	Margin (dB)	Remark
1	9171.000	36.70	10.83	47.53	74.00	-26.47	peak
2	10782.000	35.54	14.03	49.57	74.00	-24.43	peak
3	11061.000	34.62	14.96	49.58	74.00	-24.42	peak
4	12690.000	32.25	18.05	50.30	74.00	-23.70	peak
5	13914.000	28.00	21.69	49.69	74.00	-24.31	peak
6	18000.000	24.28	25.16	49.44	74.00	-24.56	peak

Test Mode:	802.11ax HE80	Channel:	6545
Polarity:	Vertical	Test Voltage:	AC 120V_60Hz

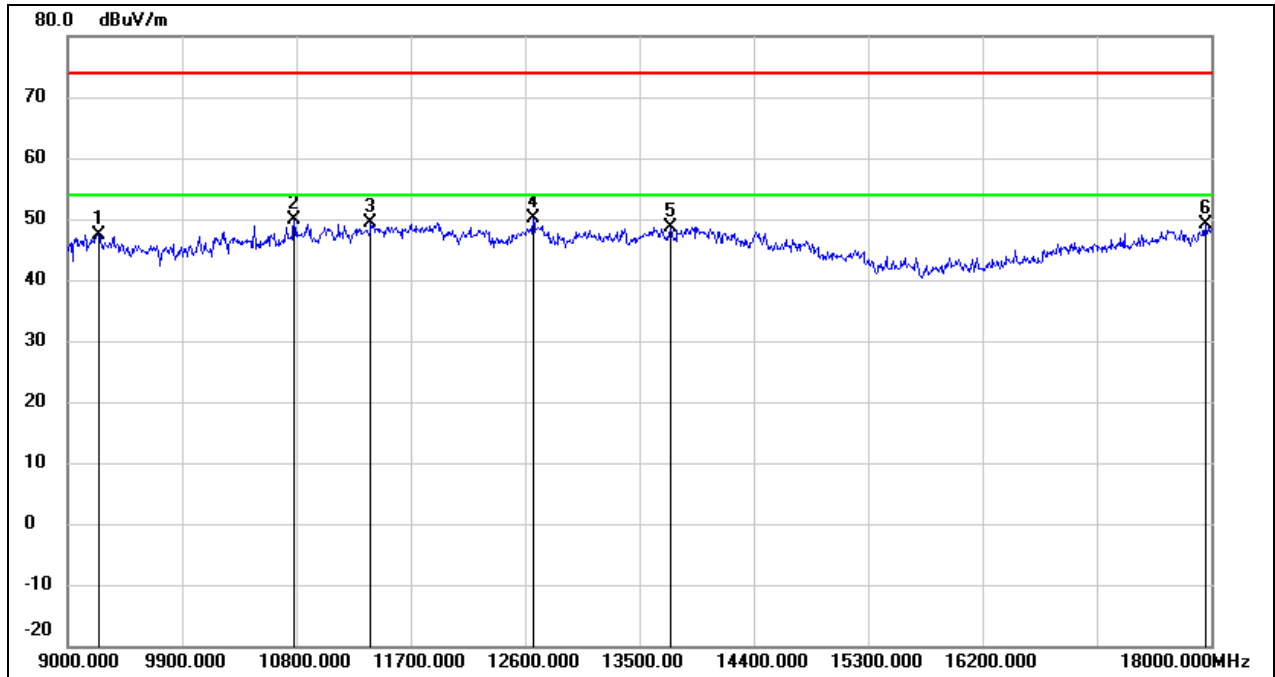

No.	Frequency (MHz)	Reading (dBuV)	Correct (dB/m)	Result (dBuV/m)	Limit (dBuV/m)	Margin (dB)	Remark
1	9243.000	36.62	10.85	47.47	74.00	-26.53	peak
2	10782.000	35.94	14.03	49.97	74.00	-24.03	peak
3	11385.000	33.20	16.12	49.32	74.00	-24.68	peak
4	12663.000	32.08	17.98	50.06	74.00	-23.94	peak
5	13743.000	27.29	21.33	48.62	74.00	-25.38	peak
6	17955.000	24.23	24.87	49.10	74.00	-24.90	peak

Test Mode:	802.11ax HE80	Channel:	6705
Polarity:	Horizontal	Test Voltage:	AC 120V_60Hz

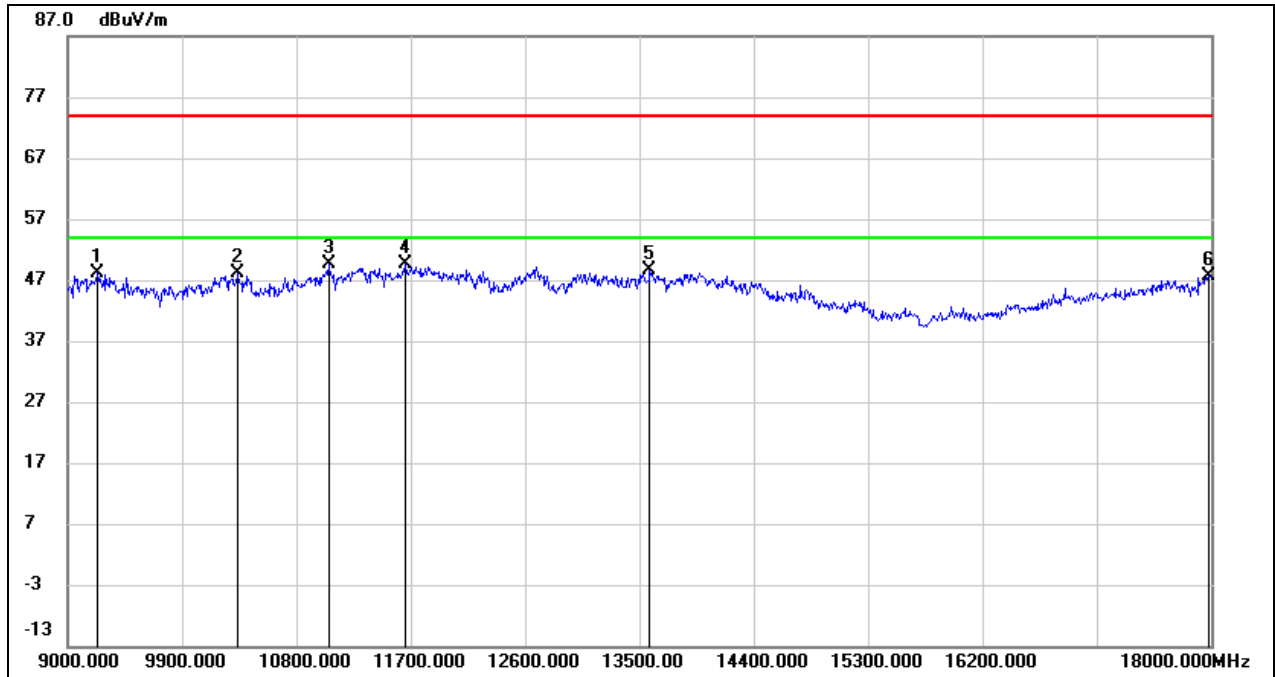

No.	Frequency (MHz)	Reading (dBuV)	Correct (dB/m)	Result (dBuV/m)	Limit (dBuV/m)	Margin (dB)	Remark
1	9234.000	37.33	10.84	48.17	74.00	-25.83	peak
2	10341.000	35.39	12.79	48.18	74.00	-25.82	peak
3	11052.000	34.60	14.94	49.54	74.00	-24.46	peak
4	11655.000	32.76	16.95	49.71	74.00	-24.29	peak
5	13581.000	27.54	20.99	48.53	74.00	-25.47	peak
6	17982.000	22.71	25.04	47.75	74.00	-26.25	peak

Test Mode:	802.11ax HE80	Channel:	6705
Polarity:	Vertical	Test Voltage:	AC 120V_60Hz

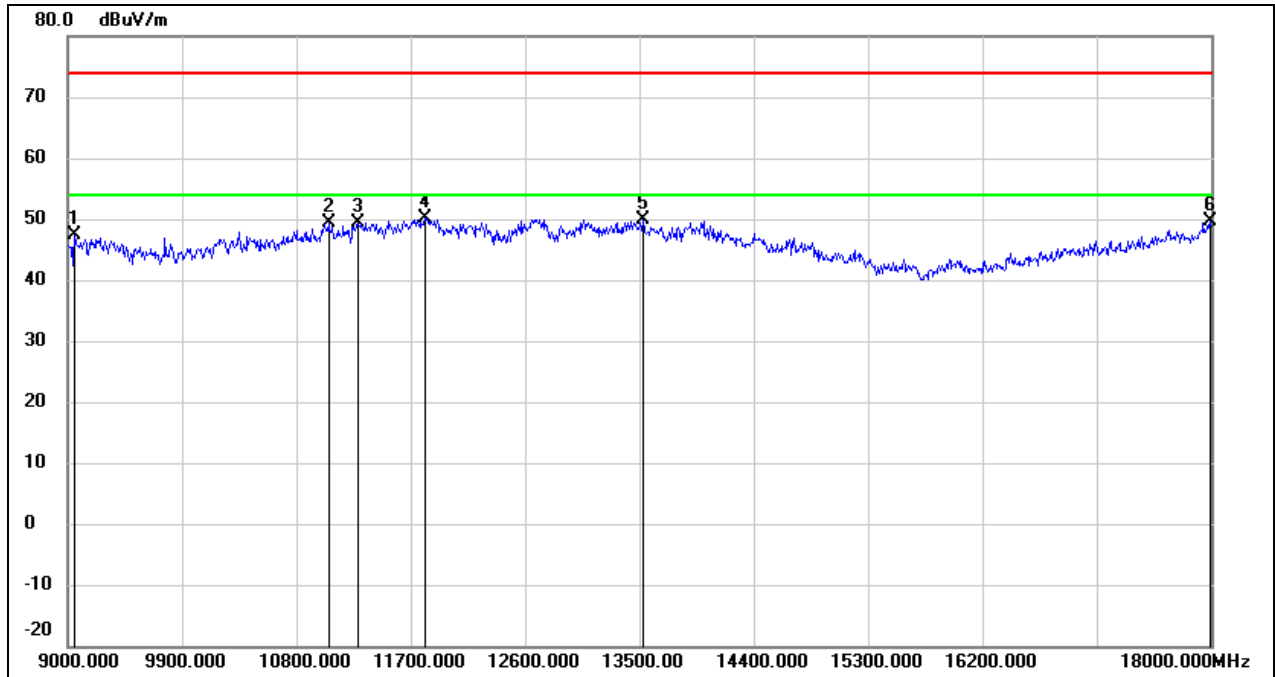

No.	Frequency (MHz)	Reading (dBuV)	Correct (dB/m)	Result (dBuV/m)	Limit (dBuV/m)	Margin (dB)	Remark
1	9054.000	36.44	10.82	47.26	74.00	-26.74	peak
2	11052.000	34.34	14.94	49.28	74.00	-24.72	peak
3	11286.000	33.72	15.77	49.49	74.00	-24.51	peak
4	11808.000	32.81	17.38	50.19	74.00	-23.81	peak
5	13527.000	29.11	20.87	49.98	74.00	-24.02	peak
6	17991.000	24.62	25.11	49.73	74.00	-24.27	peak

Test Mode:	802.11ax HE80	Channel:	6865
Polarity:	Horizontal	Test Voltage:	AC 120V_60Hz

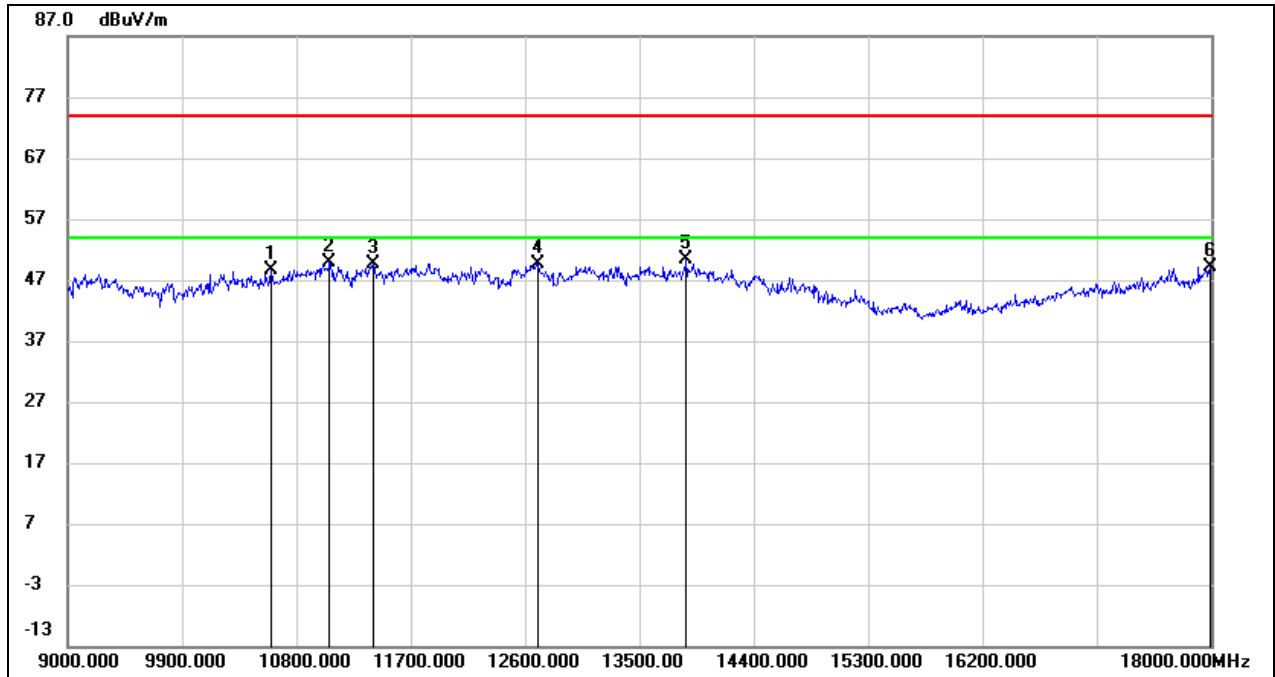

No.	Frequency (MHz)	Reading (dBuV)	Correct (dB/m)	Result (dBuV/m)	Limit (dBuV/m)	Margin (dB)	Remark
1	10602.000	35.15	13.45	48.60	74.00	-25.40	peak
2	11061.000	34.93	14.96	49.89	74.00	-24.11	peak
3	11403.000	33.54	16.19	49.73	74.00	-24.27	peak
4	12699.000	31.66	18.07	49.73	74.00	-24.27	peak
5	13869.000	28.87	21.59	50.46	74.00	-23.54	peak
6	17991.000	23.97	25.11	49.08	74.00	-24.92	peak

Test Mode:	802.11ax HE80	Channel:	6865
Polarity:	Vertical	Test Voltage:	AC 120V_60Hz

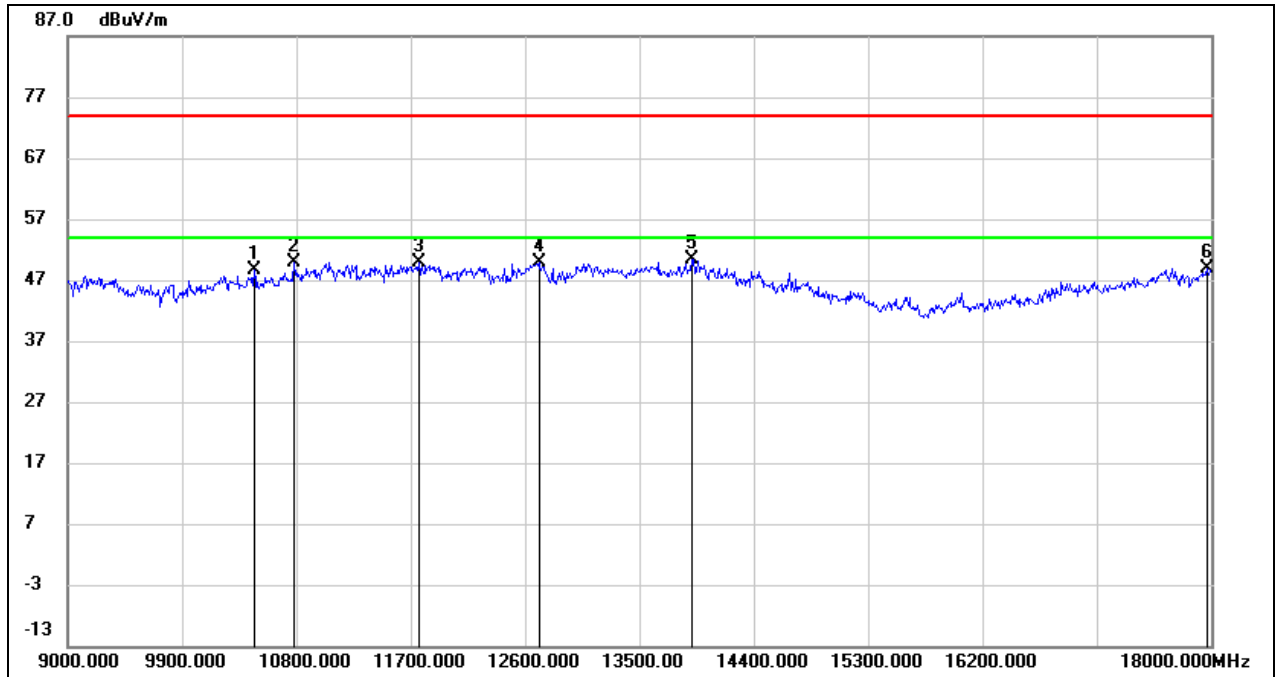

No.	Frequency (MHz)	Reading (dBuV)	Correct (dB/m)	Result (dBuV/m)	Limit (dBuV/m)	Margin (dB)	Remark
1	10467.000	35.47	13.05	48.52	74.00	-25.48	peak
2	10782.000	35.86	14.03	49.89	74.00	-24.11	peak
3	11763.000	32.73	17.26	49.99	74.00	-24.01	peak
4	12708.000	31.73	18.10	49.83	74.00	-24.17	peak
5	13914.000	28.73	21.69	50.42	74.00	-23.58	peak
6	17964.000	23.90	24.92	48.82	74.00	-25.18	peak

Test Mode:	802.11ax HE80	Channel:	6945
Polarity:	Horizontal	Test Voltage:	AC 120V_60Hz

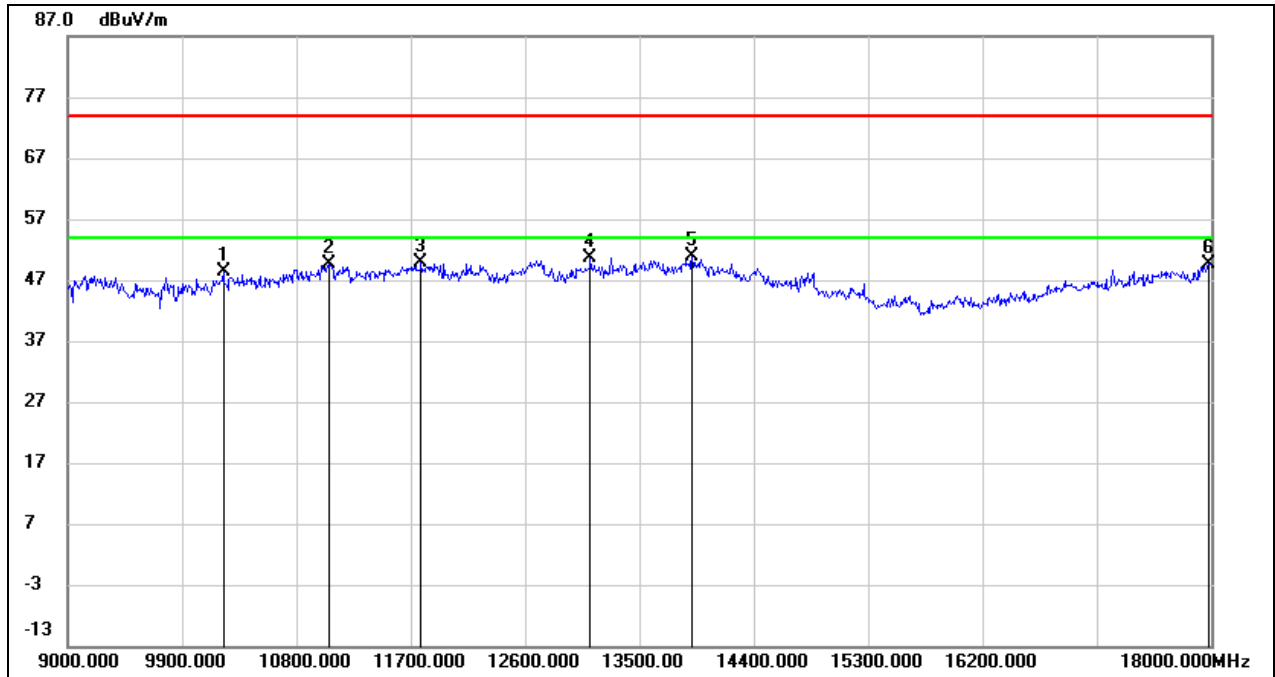

No.	Frequency (MHz)	Reading (dBuV)	Correct (dB/m)	Result (dBuV/m)	Limit (dBuV/m)	Margin (dB)	Remark
1	10224.000	35.91	12.55	48.46	74.00	-25.54	peak
2	11052.000	34.73	14.94	49.67	74.00	-24.33	peak
3	11781.000	32.47	17.30	49.77	74.00	-24.23	peak
4	13113.000	31.19	19.33	50.52	74.00	-23.48	peak
5	13914.000	29.11	21.69	50.80	74.00	-23.20	peak
6	17982.000	24.62	25.04	49.66	74.00	-24.34	peak

Test Mode:	802.11ax HE80	Channel:	6945
Polarity:	Vertical	Test Voltage:	AC 120V_60Hz

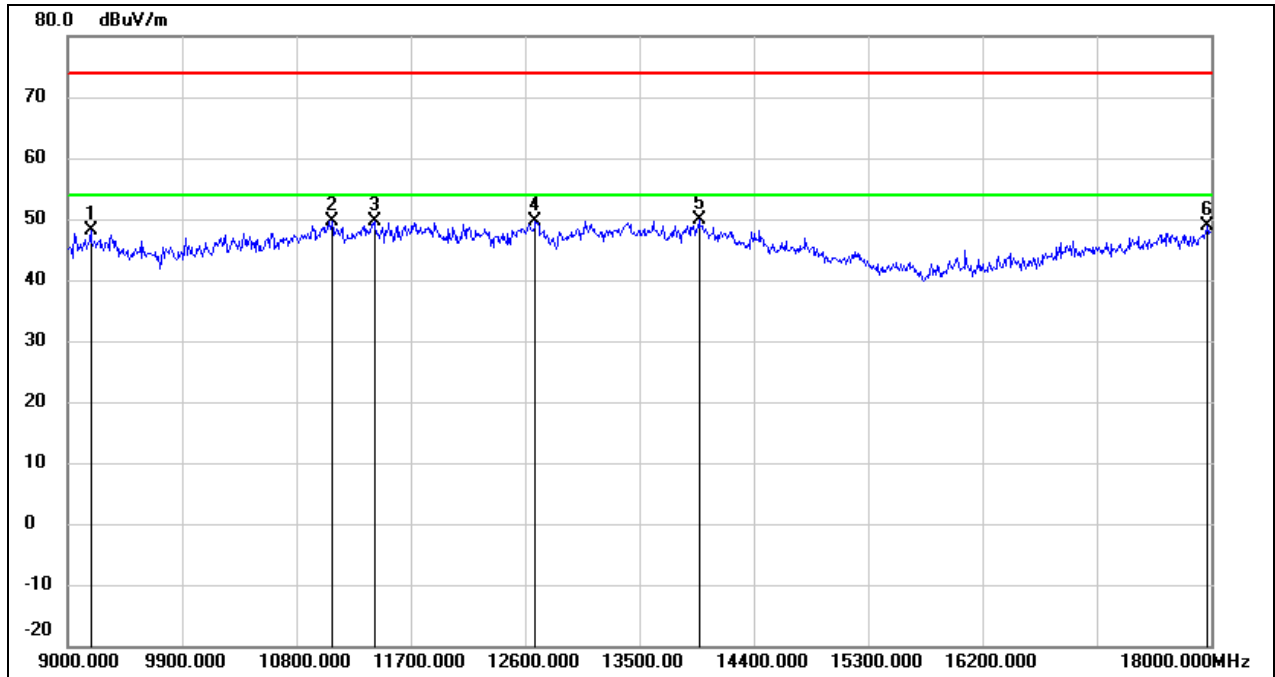

No.	Frequency (MHz)	Reading (dBuV)	Correct (dB/m)	Result (dBuV/m)	Limit (dBuV/m)	Margin (dB)	Remark
1	9180.000	37.21	10.84	48.05	74.00	-25.95	peak
2	11079.000	34.66	15.03	49.69	74.00	-24.31	peak
3	11412.000	33.39	16.22	49.61	74.00	-24.39	peak
4	12681.000	31.59	18.03	49.62	74.00	-24.38	peak
5	13968.000	28.08	21.81	49.89	74.00	-24.11	peak
6	17973.000	23.88	24.99	48.87	74.00	-25.13	peak

Test Mode:	802.11ax HE80	Channel:	7025
Polarity:	Horizontal	Test Voltage:	AC 120V_60Hz

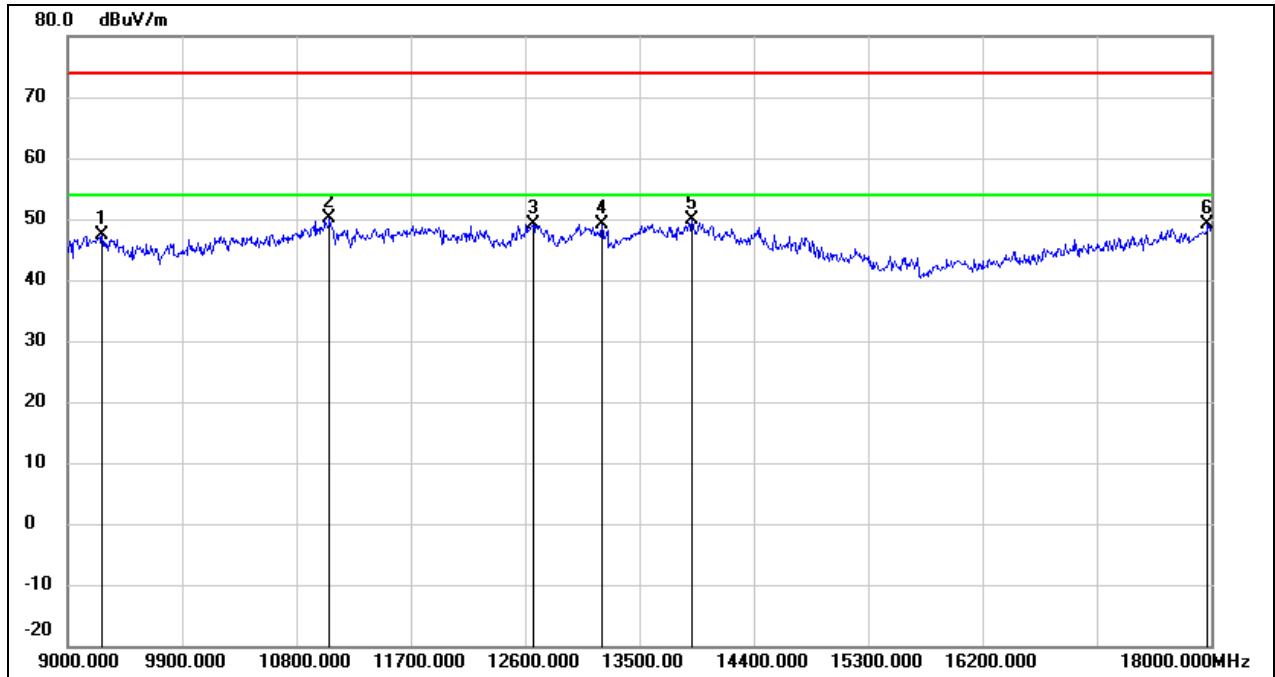

No.	Frequency (MHz)	Reading (dBuV)	Correct (dB/m)	Result (dBuV/m)	Limit (dBuV/m)	Margin (dB)	Remark
1	9270.000	36.42	10.85	47.27	74.00	-26.73	peak
2	11061.000	35.17	14.96	50.13	74.00	-23.87	peak
3	12663.000	31.09	17.98	49.07	74.00	-24.93	peak
4	13203.000	29.37	19.68	49.05	74.00	-24.95	peak
5	13914.000	28.24	21.69	49.93	74.00	-24.07	peak
6	17973.000	24.05	24.99	49.04	74.00	-24.96	peak

Test Mode:	802.11ax HE80	Channel:	7025
Polarity:	Vertical	Test Voltage:	AC 120V_60Hz

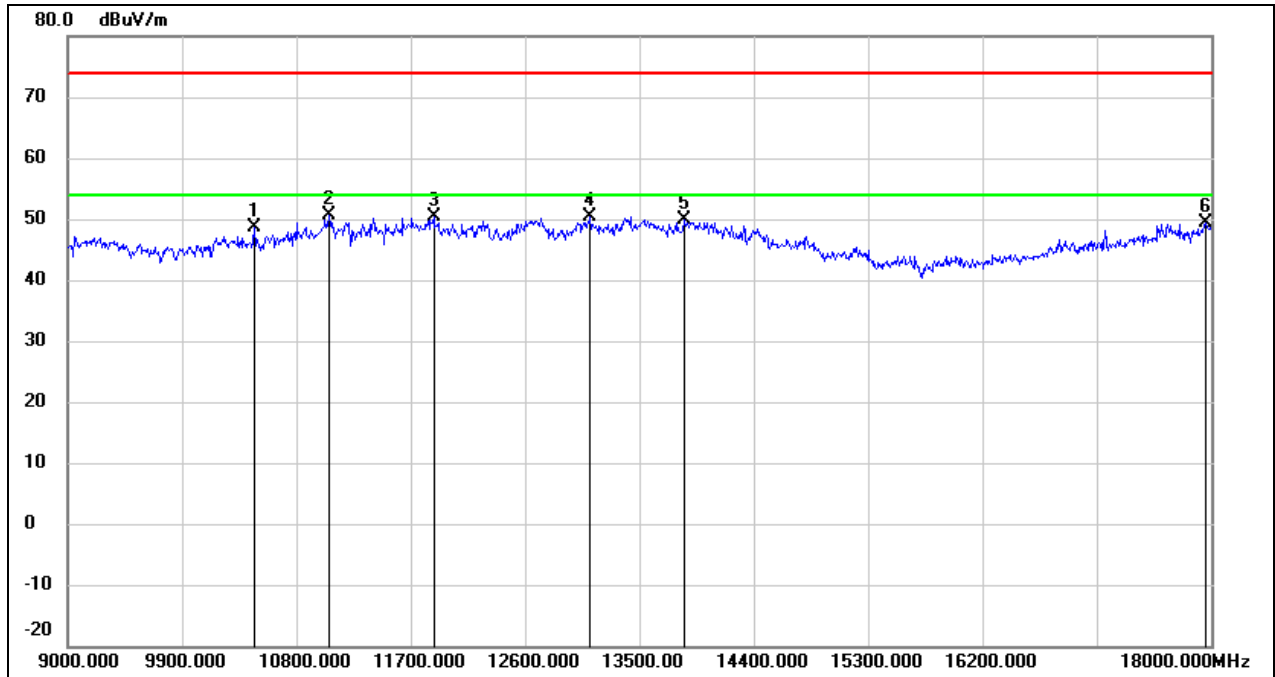

No.	Frequency (MHz)	Reading (dBuV)	Correct (dB/m)	Result (dBuV/m)	Limit (dBuV/m)	Margin (dB)	Remark
1	10467.000	35.56	13.05	48.61	74.00	-25.39	peak
2	11061.000	35.59	14.96	50.55	74.00	-23.45	peak
3	11880.000	32.84	17.58	50.42	74.00	-23.58	peak
4	13113.000	31.07	19.33	50.40	74.00	-23.60	peak
5	13851.000	28.22	21.56	49.78	74.00	-24.22	peak
6	17955.000	24.59	24.87	49.46	74.00	-24.54	peak

Test Mode:	802.11ax HE160	Channel:	6185
Polarity:	Horizontal	Test Voltage:	AC 120V_60Hz

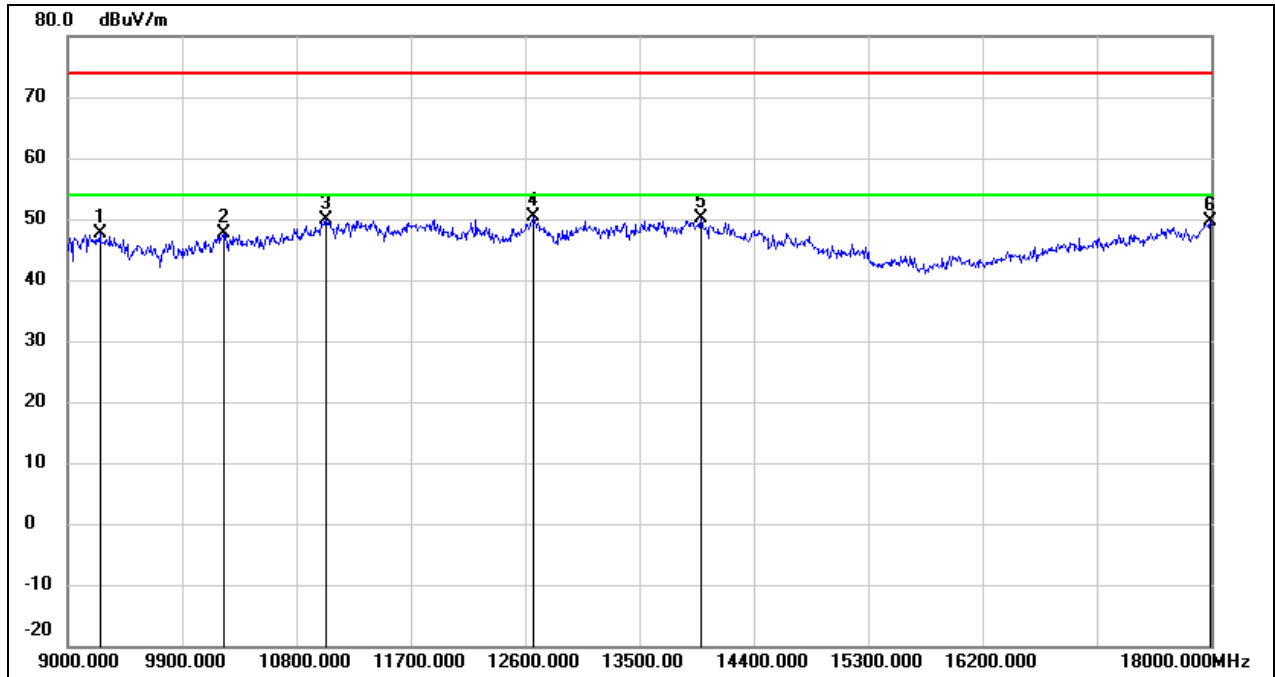

No.	Frequency (MHz)	Reading (dBuV)	Correct (dB/m)	Result (dBuV/m)	Limit (dBuV/m)	Margin (dB)	Remark
1	9252.000	36.76	10.85	47.61	74.00	-26.39	peak
2	10233.000	34.98	12.57	47.55	74.00	-26.45	peak
3	11034.000	34.91	14.87	49.78	74.00	-24.22	peak
4	12663.000	32.52	17.98	50.50	74.00	-23.50	peak
5	13986.000	28.29	21.85	50.14	74.00	-23.86	peak
6	17991.000	24.59	25.11	49.70	74.00	-24.30	peak

Test Mode:	802.11ax HE160	Channel:	6185
Polarity:	Vertical	Test Voltage:	AC 120V_60Hz

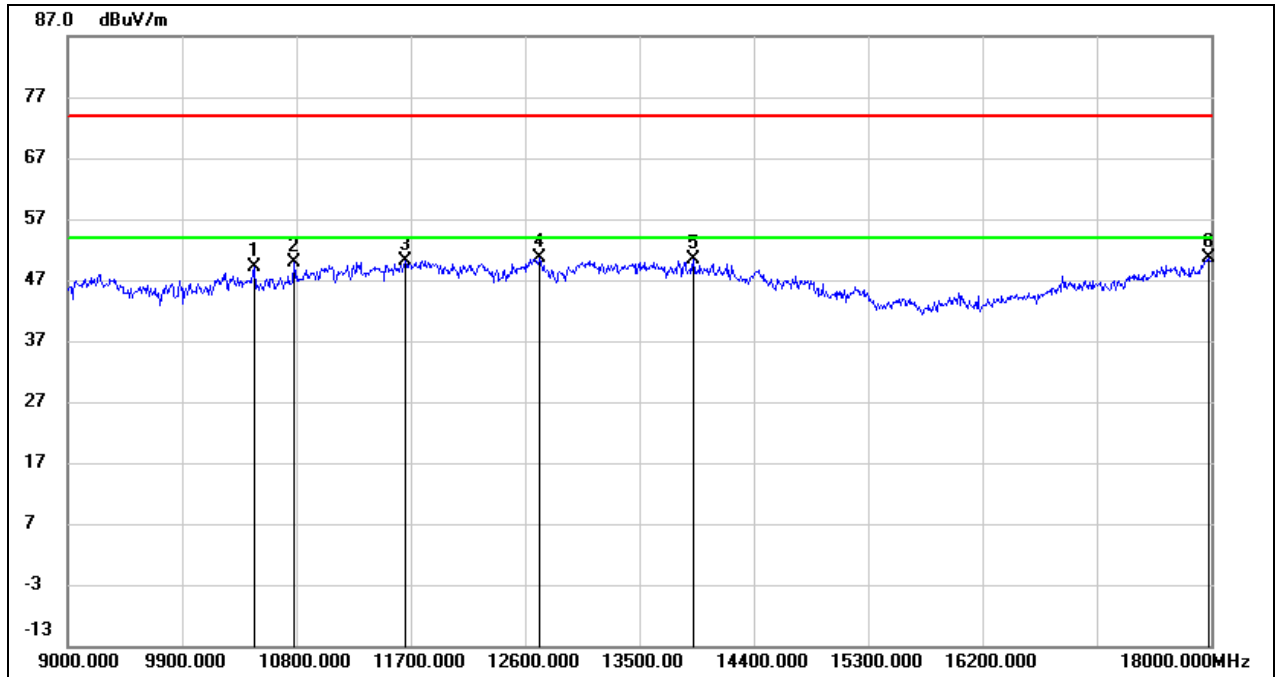

No.	Frequency (MHz)	Reading (dBuV)	Correct (dB/m)	Result (dBuV/m)	Limit (dBuV/m)	Margin (dB)	Remark
1	10467.000	35.97	13.05	49.02	74.00	-24.98	peak
2	10782.000	35.85	14.03	49.88	74.00	-24.12	peak
3	11655.000	33.21	16.95	50.16	74.00	-23.84	peak
4	12717.000	32.45	18.11	50.56	74.00	-23.44	peak
5	13923.000	28.59	21.72	50.31	74.00	-23.69	peak
6	17982.000	25.54	25.04	50.58	74.00	-23.42	peak

Test Mode:	802.11ax HE160	Channel:	6345
Polarity:	Horizontal	Test Voltage:	AC 120V_60Hz

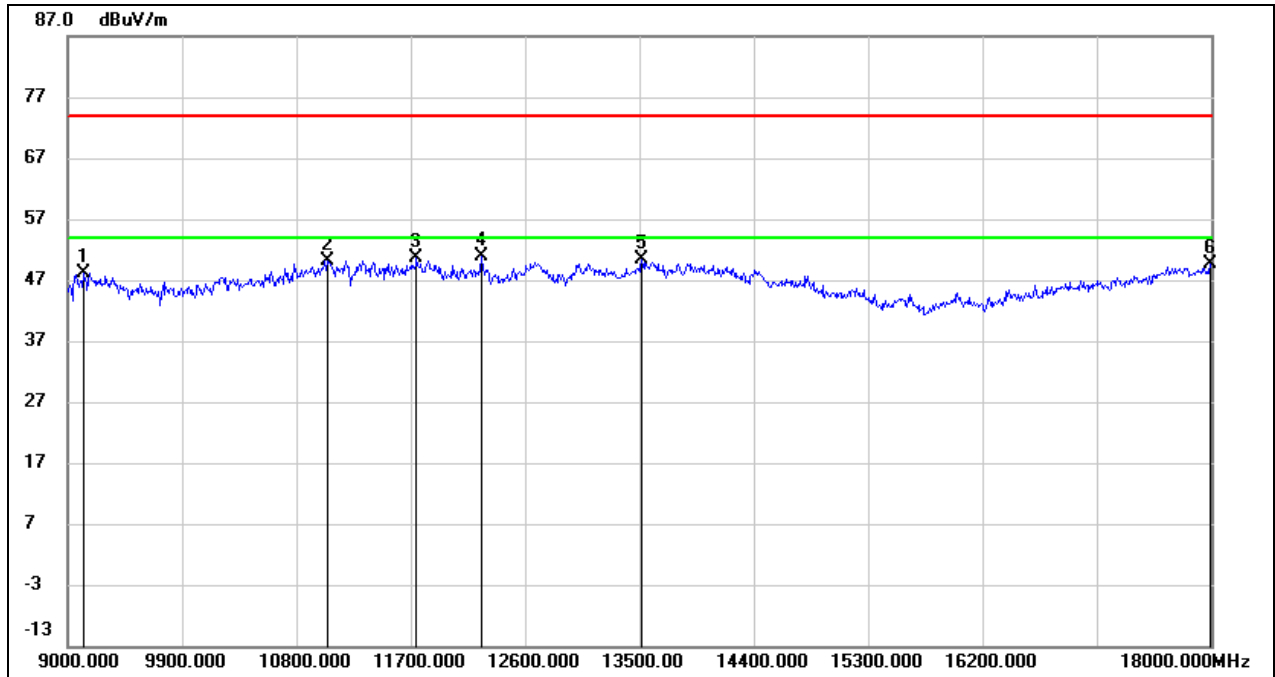

No.	Frequency (MHz)	Reading (dBuV)	Correct (dB/m)	Result (dBuV/m)	Limit (dBuV/m)	Margin (dB)	Remark
1	9126.000	37.31	10.83	48.14	74.00	-25.86	peak
2	11043.000	35.31	14.90	50.21	74.00	-23.79	peak
3	11745.000	33.31	17.21	50.52	74.00	-23.48	peak
4	12258.000	33.18	17.72	50.90	74.00	-23.10	peak
5	13518.000	29.58	20.85	50.43	74.00	-23.57	peak
6	17991.000	24.52	25.11	49.63	74.00	-24.37	peak

Test Mode:	802.11ax HE160	Channel:	6345
Polarity:	Vertical	Test Voltage:	AC 120V_60Hz

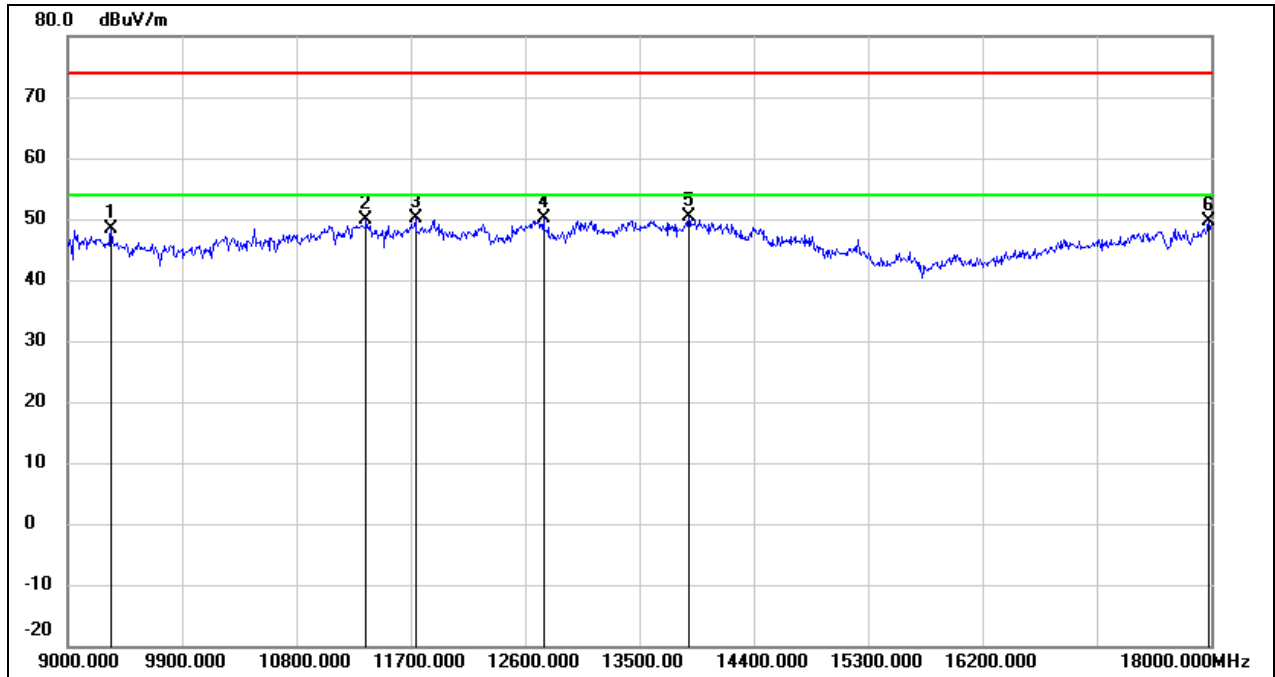

No.	Frequency (MHz)	Reading (dBuV)	Correct (dB/m)	Result (dBuV/m)	Limit (dBuV/m)	Margin (dB)	Remark
1	9342.000	37.42	10.87	48.29	74.00	-25.71	peak
2	11349.000	33.98	15.99	49.97	74.00	-24.03	peak
3	11736.000	33.01	17.18	50.19	74.00	-23.81	peak
4	12744.000	31.82	18.19	50.01	74.00	-23.99	peak
5	13887.000	28.72	21.64	50.36	74.00	-23.64	peak
6	17982.000	24.52	25.04	49.56	74.00	-24.44	peak

Test Mode:	802.11ax HE160	Channel:	6505
Polarity:	Horizontal	Test Voltage:	AC 120V_60Hz

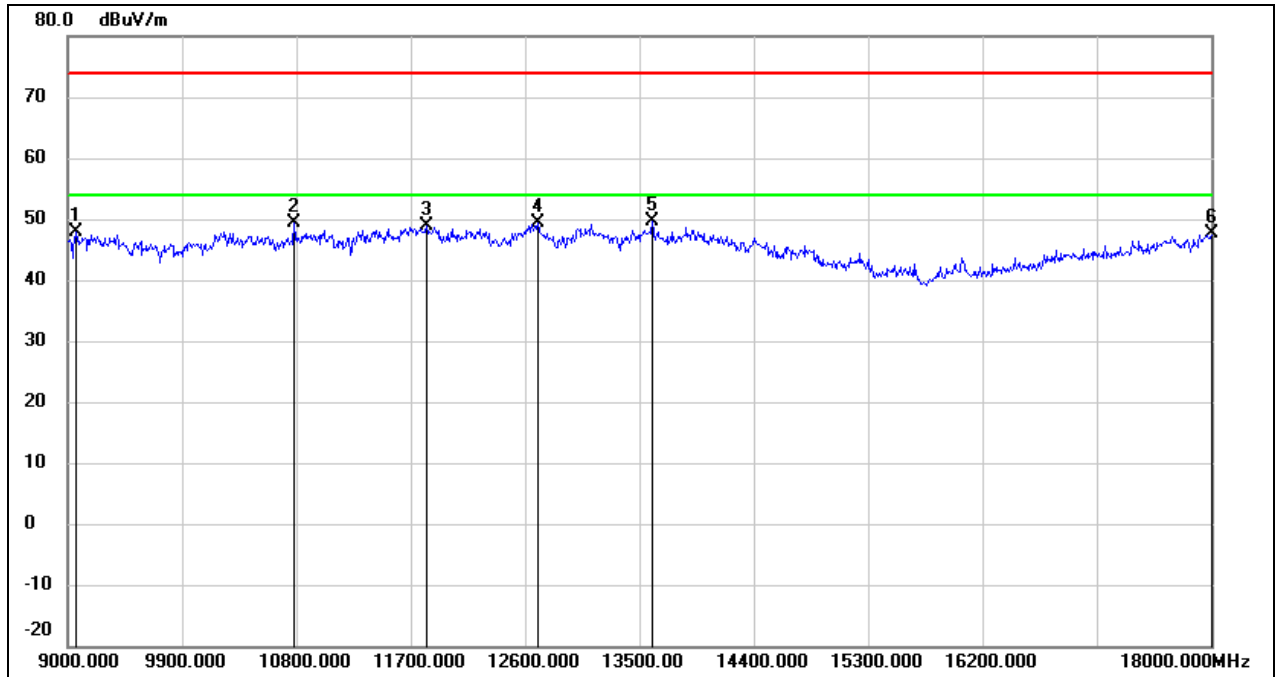

No.	Frequency (MHz)	Reading (dBuV)	Correct (dB/m)	Result (dBuV/m)	Limit (dBuV/m)	Margin (dB)	Remark
1	9063.000	36.94	10.82	47.76	74.00	-26.24	peak
2	10782.000	35.25	14.03	49.28	74.00	-24.72	peak
3	11826.000	31.55	17.42	48.97	74.00	-25.03	peak
4	12699.000	31.34	18.07	49.41	74.00	-24.59	peak
5	13599.000	28.56	21.02	49.58	74.00	-24.42	peak
6	18000.000	22.59	25.16	47.75	74.00	-26.25	peak

Test Mode:	802.11ax HE160	Channel:	6505
Polarity:	Vertical	Test Voltage:	AC 120V_60Hz

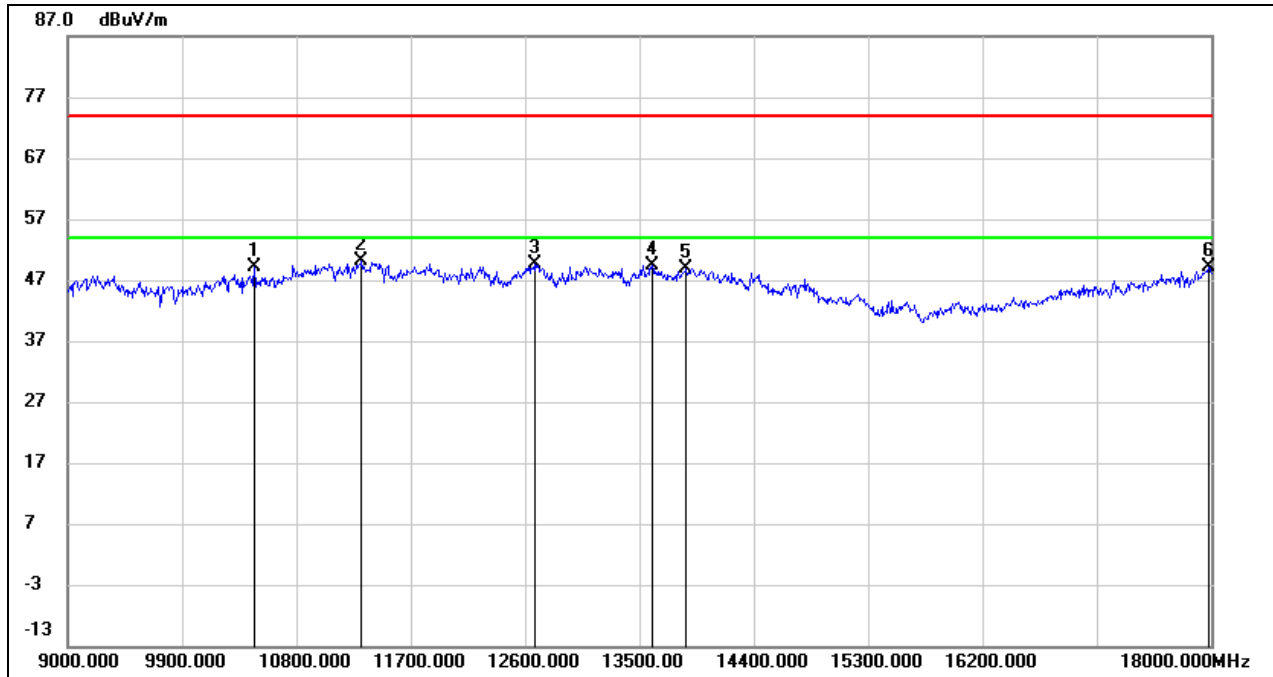

No.	Frequency (MHz)	Reading (dBuV)	Correct (dB/m)	Result (dBuV/m)	Limit (dBuV/m)	Margin (dB)	Remark
1	10467.000	36.09	13.05	49.14	74.00	-24.86	peak
2	11313.000	34.27	15.86	50.13	74.00	-23.87	peak
3	12672.000	31.65	18.00	49.65	74.00	-24.35	peak
4	13599.000	28.42	21.02	49.44	74.00	-24.56	peak
5	13869.000	27.23	21.59	48.82	74.00	-25.18	peak
6	17982.000	24.10	25.04	49.14	74.00	-24.86	peak

Test Mode:	802.11ax HE160	Channel:	6665
Polarity:	Horizontal	Test Voltage:	AC 120V_60Hz

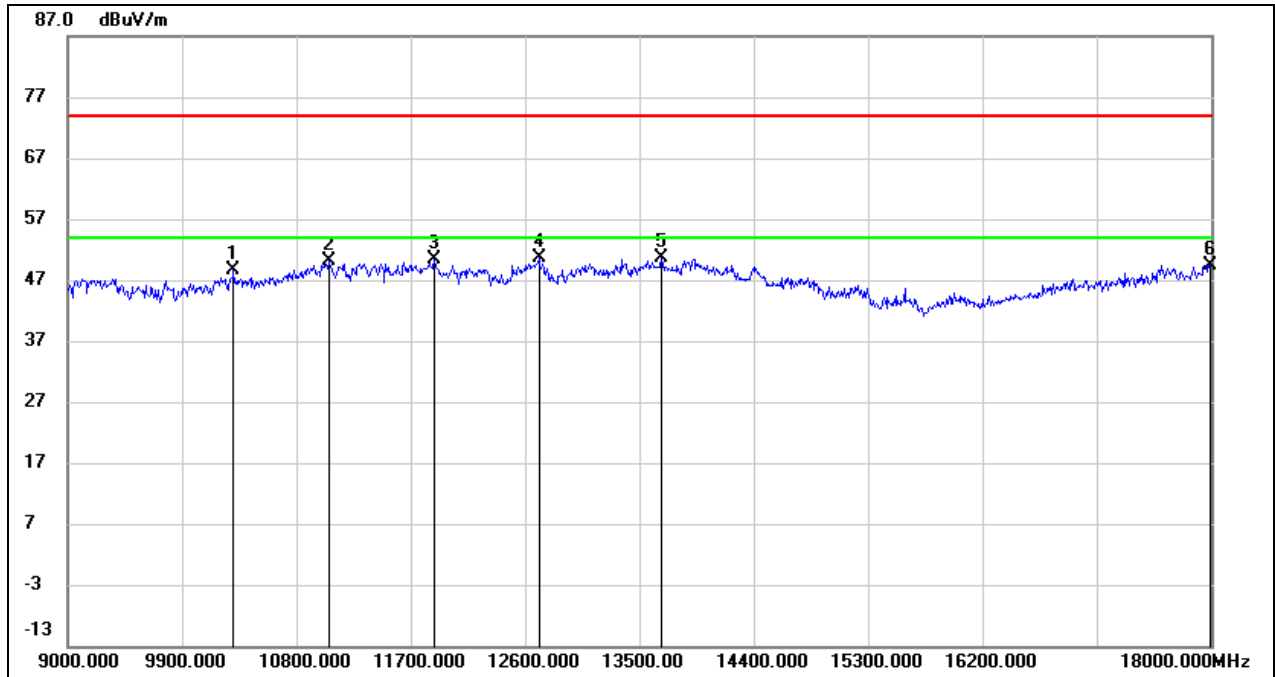

No.	Frequency (MHz)	Reading (dBuV)	Correct (dB/m)	Result (dBuV/m)	Limit (dBuV/m)	Margin (dB)	Remark
1	10305.000	35.83	12.72	48.55	74.00	-25.45	peak
2	11061.000	35.28	14.96	50.24	74.00	-23.76	peak
3	11889.000	32.68	17.60	50.28	74.00	-23.72	peak
4	12708.000	32.63	18.10	50.73	74.00	-23.27	peak
5	13671.000	29.43	21.18	50.61	74.00	-23.39	peak
6	17991.000	24.37	25.11	49.48	74.00	-24.52	peak

Test Mode:	802.11ax HE160	Channel:	6665
Polarity:	Vertical	Test Voltage:	AC 120V_60Hz

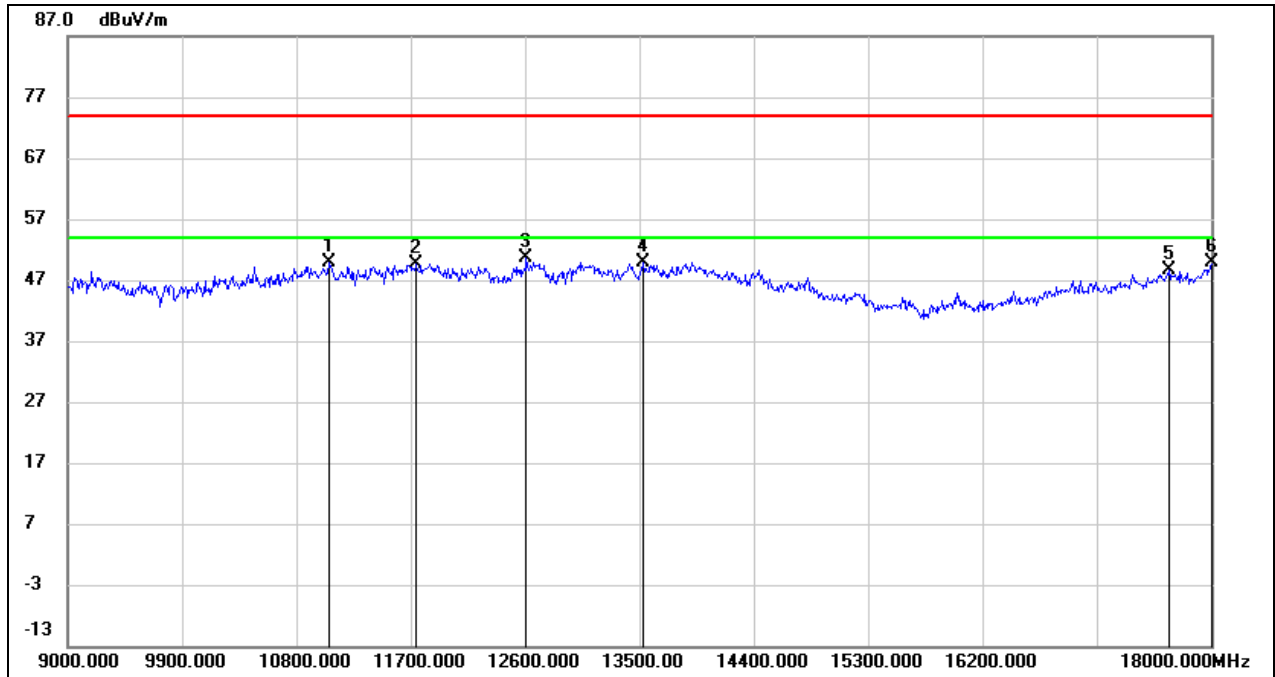

No.	Frequency (MHz)	Reading (dBuV)	Correct (dB/m)	Result (dBuV/m)	Limit (dBuV/m)	Margin (dB)	Remark
1	11052.000	35.04	14.94	49.98	74.00	-24.02	peak
2	11745.000	32.51	17.21	49.72	74.00	-24.28	peak
3	12609.000	32.91	17.83	50.74	74.00	-23.26	peak
4	13527.000	28.98	20.87	49.85	74.00	-24.15	peak
5	17667.000	25.69	23.02	48.71	74.00	-25.29	peak
6	18000.000	24.66	25.16	49.82	74.00	-24.18	peak

Test Mode:	802.11ax HE160	Channel:	6825
Polarity:	Horizontal	Test Voltage:	AC 120V_60Hz

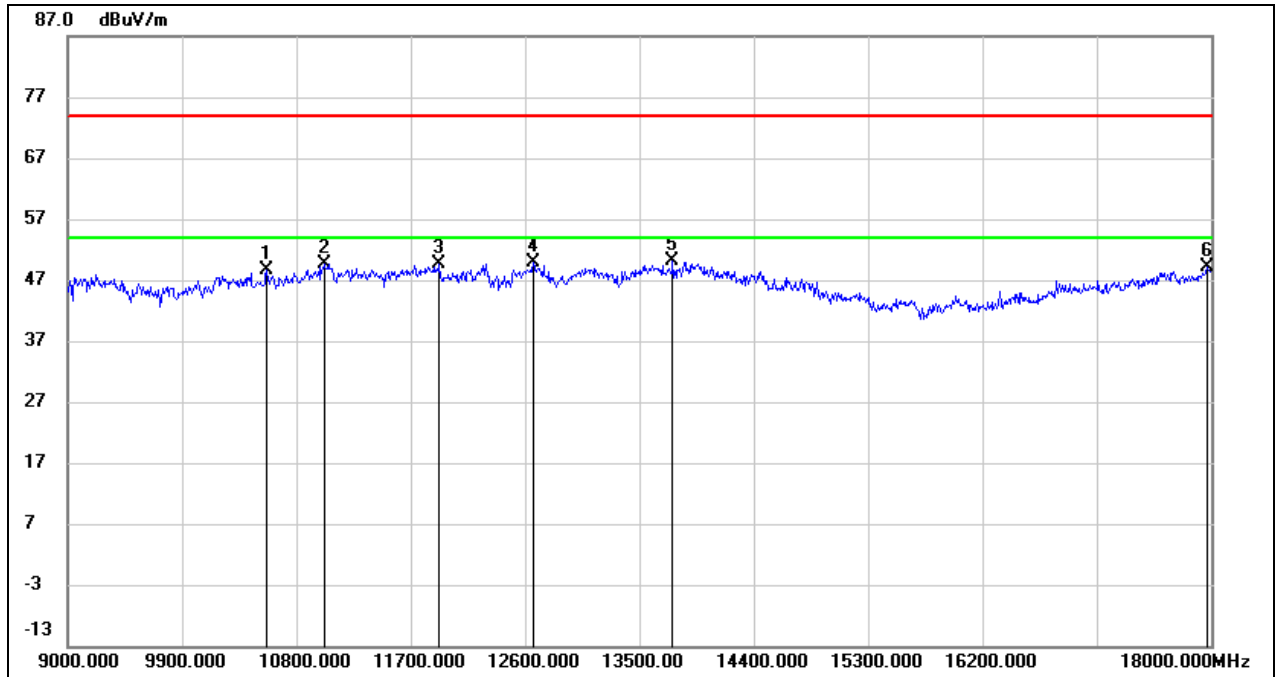

No.	Frequency (MHz)	Reading (dBuV)	Correct (dB/m)	Result (dBuV/m)	Limit (dBuV/m)	Margin (dB)	Remark
1	10566.000	35.25	13.33	48.58	74.00	-25.42	peak
2	11016.000	34.85	14.81	49.66	74.00	-24.34	peak
3	11925.000	31.91	17.70	49.61	74.00	-24.39	peak
4	12663.000	31.82	17.98	49.80	74.00	-24.20	peak
5	13761.000	28.68	21.37	50.05	74.00	-23.95	peak
6	17964.000	24.20	24.92	49.12	74.00	-24.88	peak

Test Mode:	802.11ax HE160	Channel:	6825
Polarity:	Vertical	Test Voltage:	AC 120V_60Hz

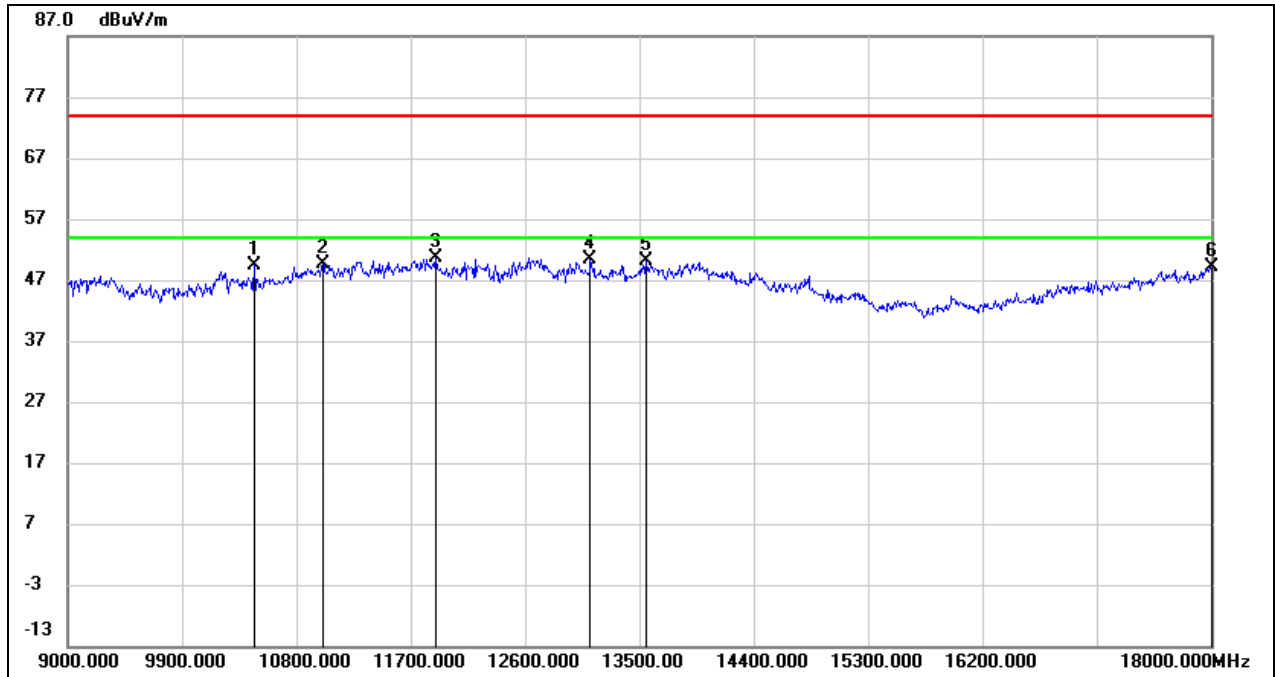

No.	Frequency (MHz)	Reading (dBuV)	Correct (dB/m)	Result (dBuV/m)	Limit (dBuV/m)	Margin (dB)	Remark
1	10467.000	36.39	13.05	49.44	74.00	-24.56	peak
2	11007.000	34.89	14.77	49.66	74.00	-24.34	peak
3	11898.000	33.12	17.63	50.75	74.00	-23.25	peak
4	13113.000	31.03	19.33	50.36	74.00	-23.64	peak
5	13554.000	29.12	20.92	50.04	74.00	-23.96	peak
6	18000.000	23.98	25.16	49.14	74.00	-24.86	peak

Test Mode:	802.11ax HE160	Channel:	6985
Polarity:	Horizontal	Test Voltage:	AC 120V_60Hz

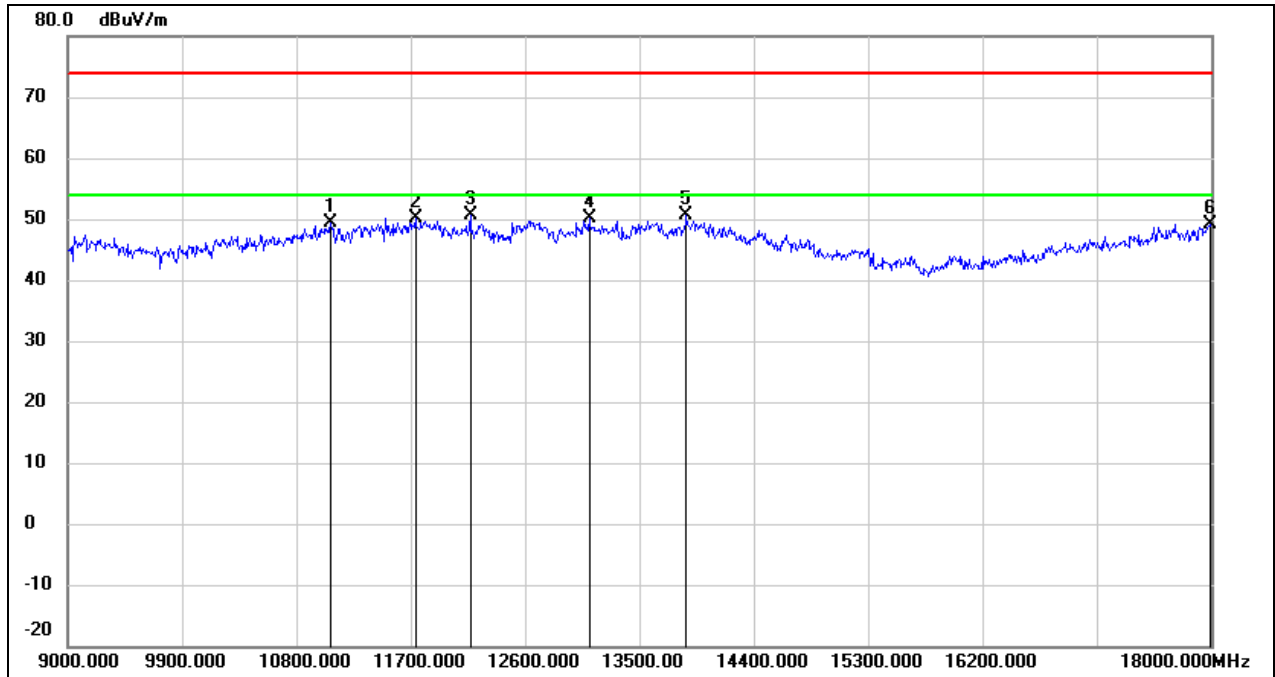

No.	Frequency (MHz)	Reading (dBuV)	Correct (dB/m)	Result (dBuV/m)	Limit (dBuV/m)	Margin (dB)	Remark
1	11070.000	34.44	15.00	49.44	74.00	-24.56	peak
2	11736.000	33.01	17.18	50.19	74.00	-23.81	peak
3	12168.000	32.74	17.78	50.52	74.00	-23.48	peak
4	13104.000	30.96	19.29	50.25	74.00	-23.75	peak
5	13869.000	29.15	21.59	50.74	74.00	-23.26	peak
6	17991.000	24.00	25.11	49.11	74.00	-24.89	peak

Test Mode:	802.11ax HE160	Channel:	6985
Polarity:	Vertical	Test Voltage:	AC 120V_60Hz

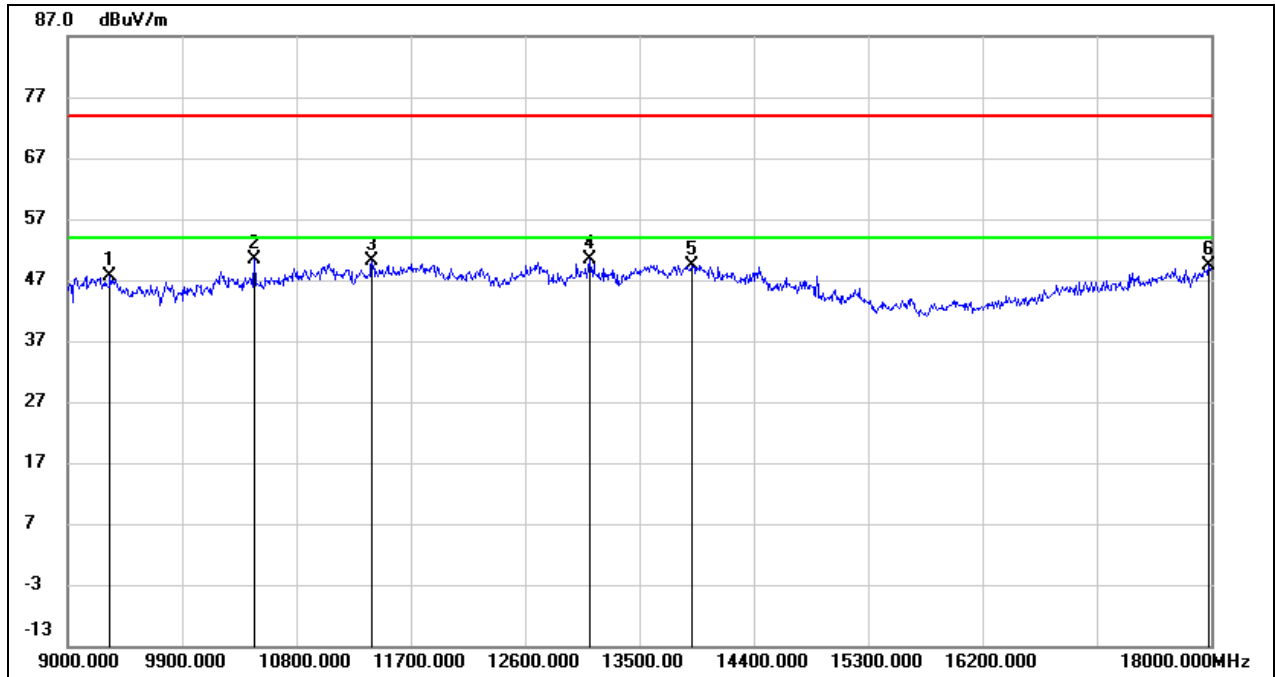

No.	Frequency (MHz)	Reading (dBuV)	Correct (dB/m)	Result (dBuV/m)	Limit (dBuV/m)	Margin (dB)	Remark
1	9333.000	36.82	10.86	47.68	74.00	-26.32	peak
2	10467.000	37.25	13.05	50.30	74.00	-23.70	peak
3	11394.000	33.86	16.15	50.01	74.00	-23.99	peak
4	13104.000	30.97	19.29	50.26	74.00	-23.74	peak
5	13914.000	27.74	21.69	49.43	74.00	-24.57	peak
6	17982.000	24.33	25.04	49.37	74.00	-24.63	peak

8.4. SPURIOUS EMISSIONS(9 KHZ~30 MHZ)

Test Mode:	802.11ax HE20	Channel:	6115
Polarity:	Horizontal	Test Voltage:	DC 12 V

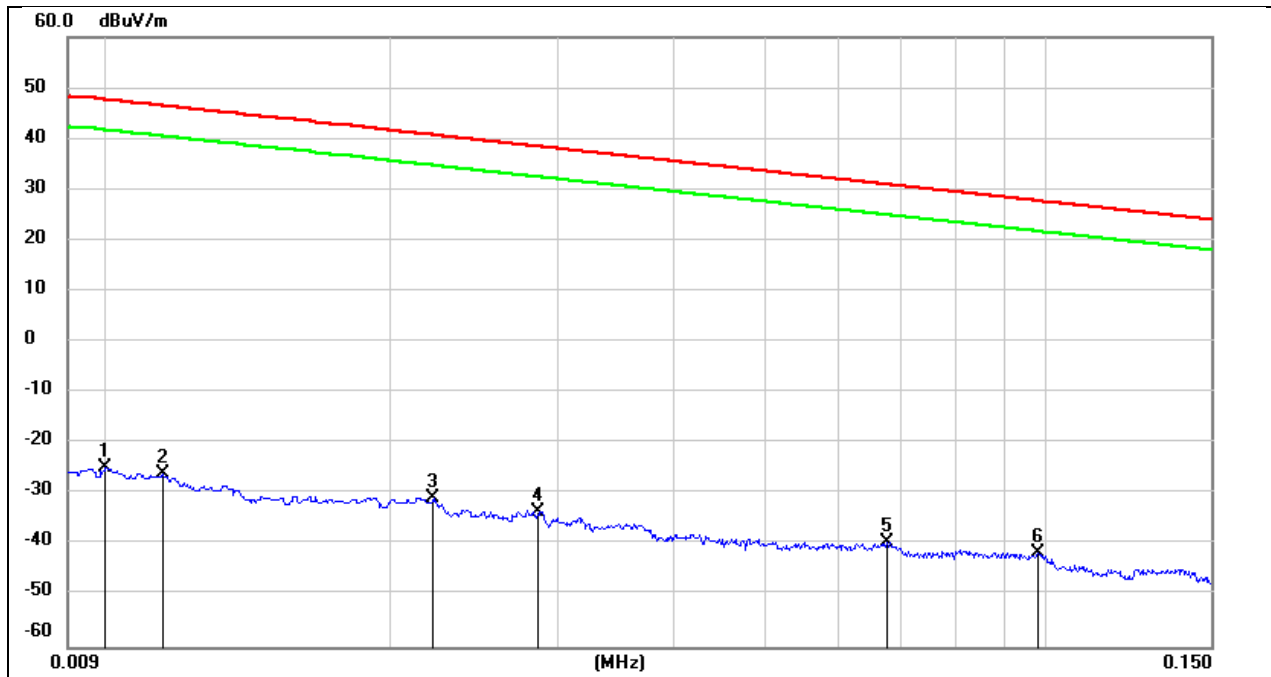

No.	Frequency (MHz)	Reading (dBuV)	Correct (dB/m)	Result (dBuV/m)	Limit (dBuV/m)	Margin (dB)	Remark
1	0.0100	76.72	-101.40	-24.68	47.60	-72.28	peak
2	0.0114	75.38	-101.40	-26.02	46.46	-72.48	peak
3	0.0221	70.63	-101.35	-30.72	40.71	-71.43	peak
4	0.0286	67.96	-101.38	-33.42	38.47	-71.89	peak
5	0.0675	62.14	-101.56	-39.42	31.02	-70.44	peak
6	0.0981	60.27	-101.78	-41.51	27.77	-69.28	peak

Test Mode:	802.11ax HE20	Channel:	6115
Polarity:	Horizontal	Test Voltage:	DC 12 V

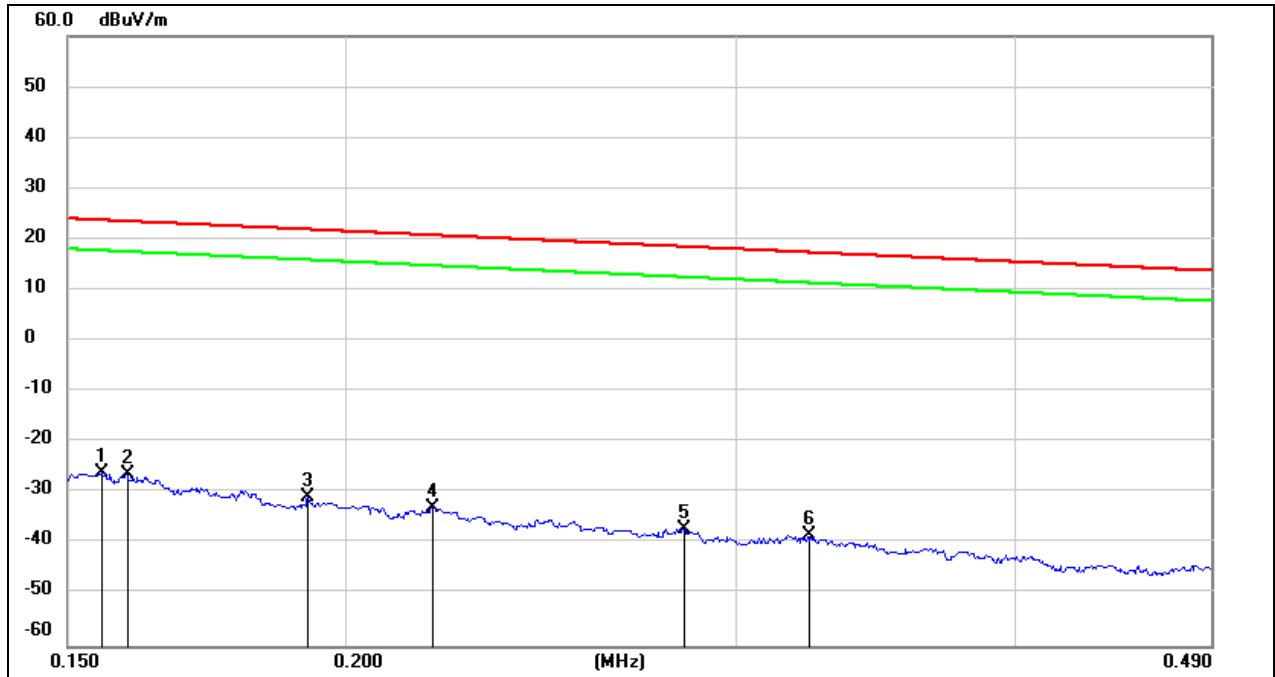

No.	Frequency (MHz)	Reading (dBuV)	Correct (dB/m)	Result (dBuV/m)	Limit (dBuV/m)	Margin (dB)	Remark
1	0.1554	75.77	-101.65	-25.88	23.77	-49.65	peak
2	0.1595	75.36	-101.65	-26.29	23.55	-49.84	peak
3	0.1925	70.96	-101.70	-30.74	21.92	-52.66	peak
4	0.2190	68.77	-101.75	-32.98	20.79	-53.77	peak
5	0.2837	64.72	-101.83	-37.11	18.54	-55.65	peak
6	0.3234	63.48	-101.88	-38.40	17.41	-55.81	peak

Test Mode:	802.11ax HE20	Channel:	6115
Polarity:	Horizontal	Test Voltage:	DC 12 V

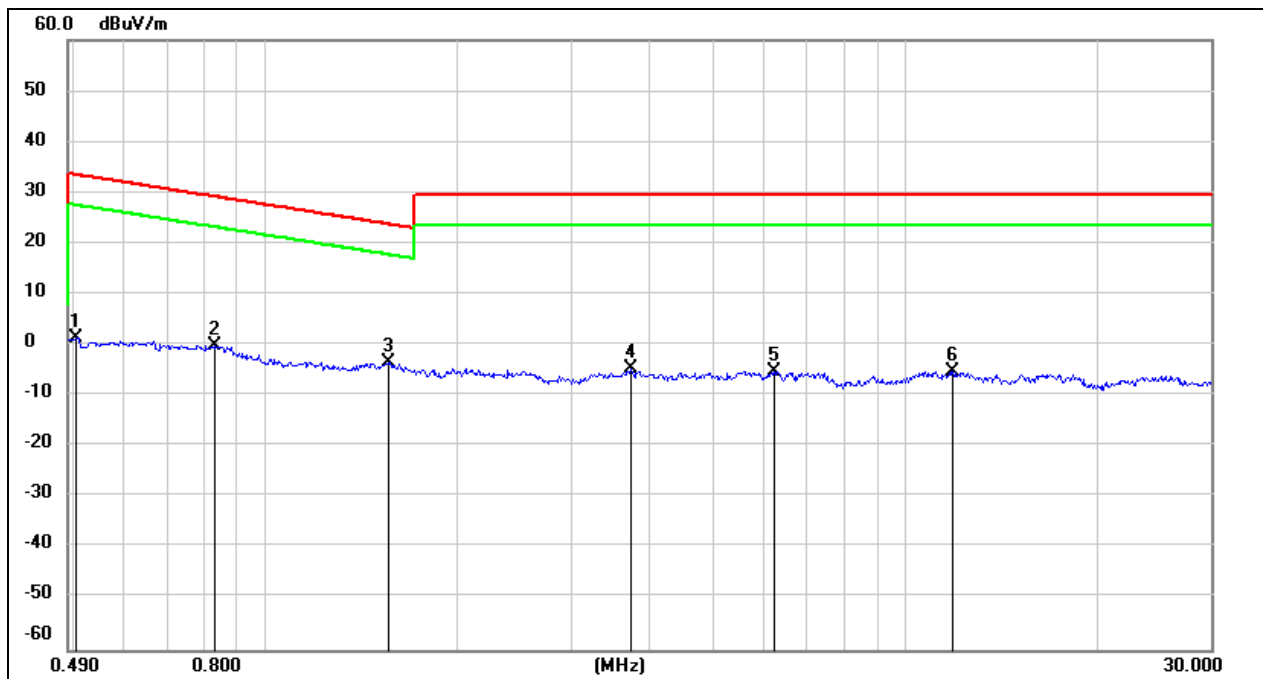

No.	Frequency (MHz)	Reading (dBuV)	Correct (dB/m)	Result (dBuV/m)	Limit (dBuV/m)	Margin (dB)	Remark
1	0.5039	63.43	-62.07	1.36	33.56	-32.20	peak
2	0.8296	61.94	-62.17	-0.23	29.23	-29.46	peak
3	1.5564	58.68	-62.02	-3.34	23.76	-27.10	peak
4	3.7100	56.70	-61.41	-4.71	29.54	-34.25	peak
5	6.2445	56.13	-61.32	-5.19	29.54	-34.73	peak
6	11.8513	55.56	-60.88	-5.32	29.54	-34.86	peak

8.5. SPURIOUS EMISSIONS(18 GHZ~26 GHZ)

Test Mode:	802.11ax HE20	Channel:	6115
Polarity:	Horizontal	Test Voltage:	DC 12 V

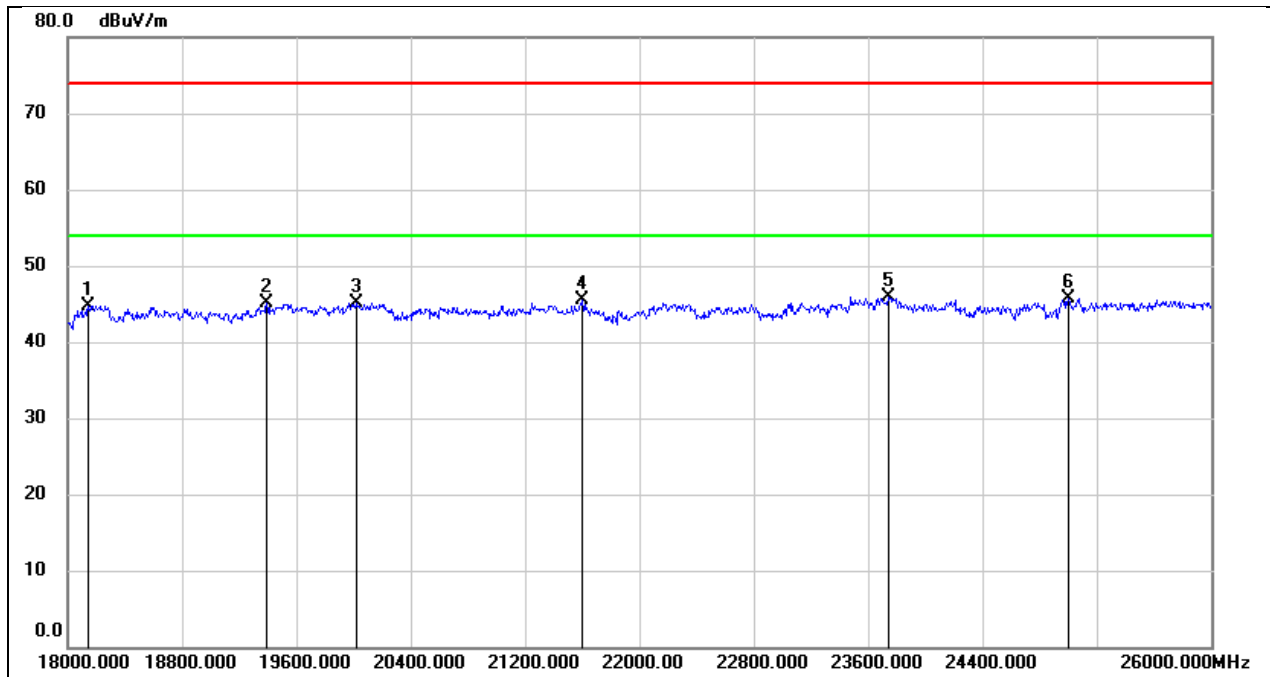

No.	Frequency (MHz)	Reading (dBuV)	Correct (dB/m)	Result (dBuV/m)	Limit (dBuV/m)	Margin (dB)	Remark
1	18144.000	50.27	-5.48	44.79	74.00	-29.21	peak
2	19392.000	50.62	-5.57	45.05	74.00	-28.95	peak
3	20016.000	50.56	-5.47	45.09	74.00	-28.91	peak
4	21600.000	50.02	-4.54	45.48	74.00	-28.52	peak
5	23744.000	49.15	-3.20	45.95	74.00	-28.05	peak
6	25000.000	47.86	-2.10	45.76	74.00	-28.24	peak

Test Mode:	802.11ax HE20	Channel:	6115
Polarity:	Vertical	Test Voltage:	DC 12 V

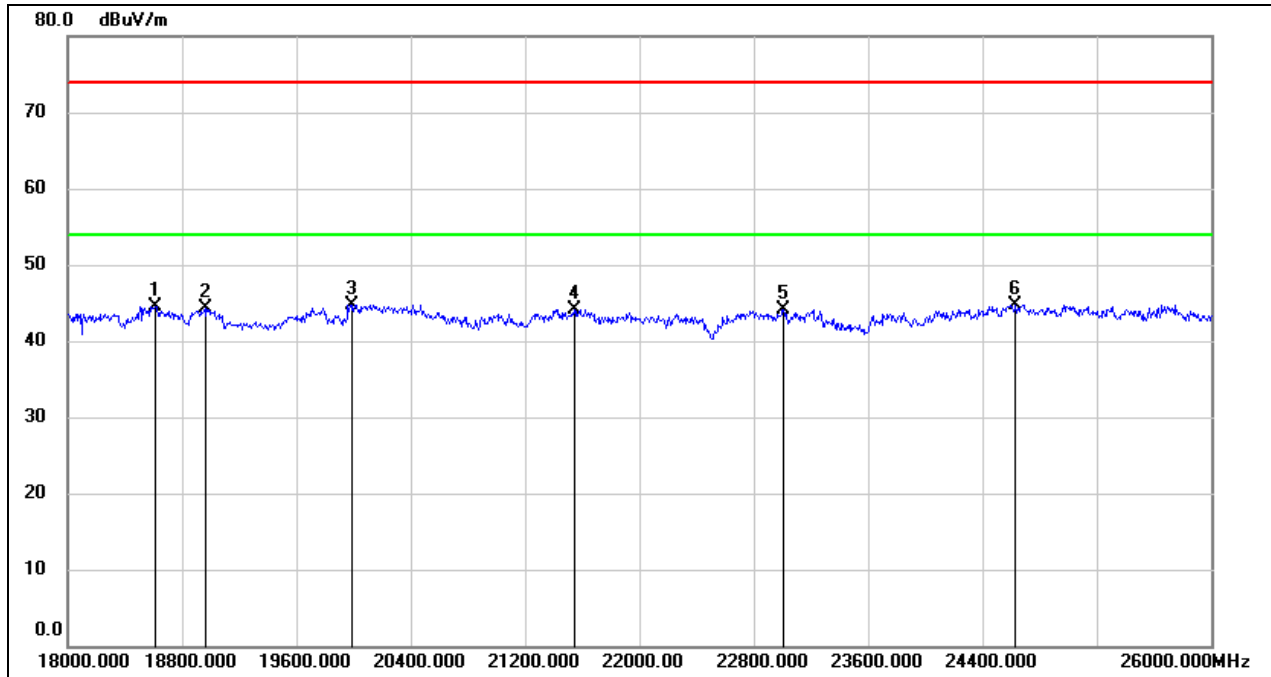

No.	Frequency (MHz)	Reading (dBuV)	Correct (dB/m)	Result (dBuV/m)	Limit (dBuV/m)	Margin (dB)	Remark
1	18616.000	49.89	-5.34	44.55	74.00	-29.45	peak
2	18960.000	49.51	-5.25	44.26	74.00	-29.74	peak
3	19984.000	50.21	-5.44	44.77	74.00	-29.23	peak
4	21544.000	48.76	-4.63	44.13	74.00	-29.87	peak
5	23008.000	47.60	-3.44	44.16	74.00	-29.84	peak
6	24632.000	46.96	-2.31	44.65	74.00	-29.35	peak

8.6. SPURIOUS EMISSIONS(26 GHZ~40 GHZ)

Test Mode:	802.11ax HE20	Channel:	6115
Polarity:	Horizontal	Test Voltage:	DC 12 V

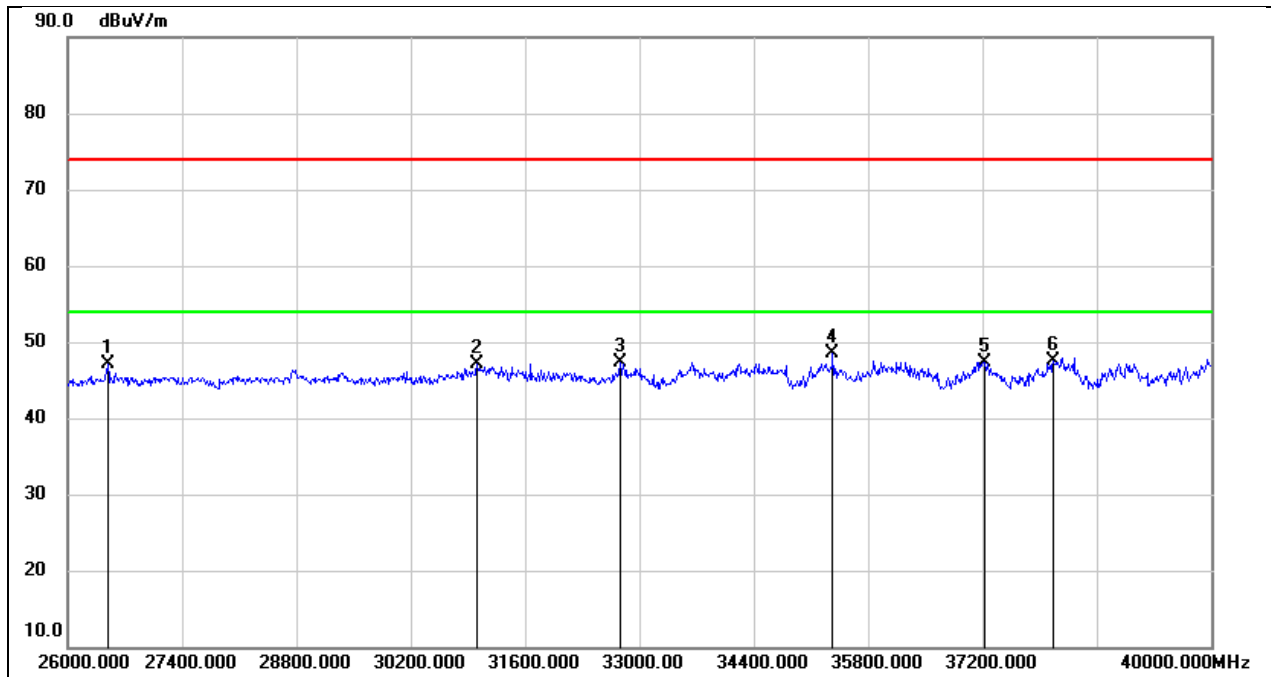

No.	Frequency (MHz)	Reading (dBuV)	Correct (dB/m)	Result (dBuV/m)	Limit (dBuV/m)	Margin (dB)	Remark
1	26490.000	51.79	-4.74	47.05	74.00	-26.95	peak
2	31012.000	47.83	-0.71	47.12	74.00	-26.88	peak
3	32762.000	48.45	-1.21	47.24	74.00	-26.76	peak
4	35366.000	45.90	2.59	48.49	74.00	-25.51	peak
5	37228.000	44.23	3.14	47.37	74.00	-26.63	peak
6	38068.000	44.06	3.42	47.48	74.00	-26.52	peak

Test Mode:	802.11ax HE20	Channel:	6115
Polarity:	Vertical	Test Voltage:	DC 12 V

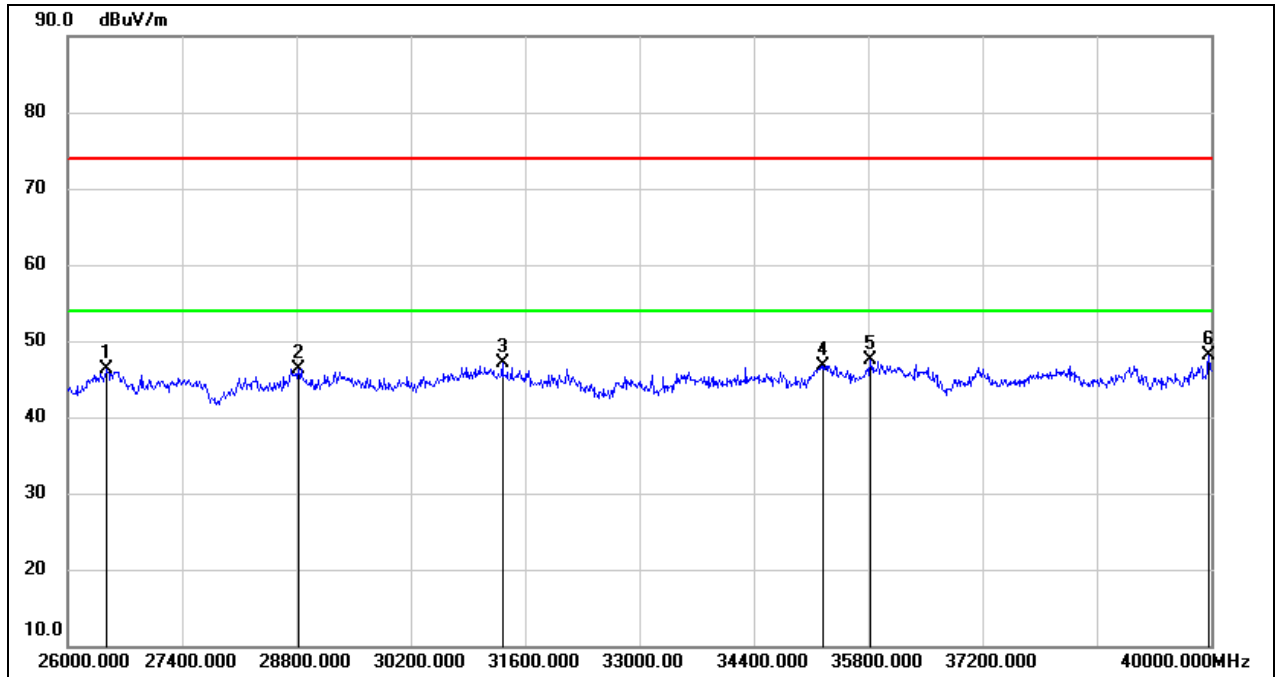

No.	Frequency (MHz)	Reading (dBuV)	Correct (dB/m)	Result (dBuV/m)	Limit (dBuV/m)	Margin (dB)	Remark
1	26476.000	51.03	-4.78	46.25	74.00	-27.75	peak
2	28828.000	47.13	-0.79	46.34	74.00	-27.66	peak
3	31320.000	48.11	-0.93	47.18	74.00	-26.82	peak
4	35254.000	44.12	2.65	46.77	74.00	-27.23	peak
5	35828.000	43.75	3.67	47.42	74.00	-26.58	peak
6	39972.000	42.95	5.13	48.08	74.00	-25.92	peak

8.7. SPURIOUS EMISSIONS(30 MHZ~1 GHZ)

Test Mode:	802.11ax HE20	Channel:	6115
Polarity:	Horizontal	Test Voltage:	DC 12 V

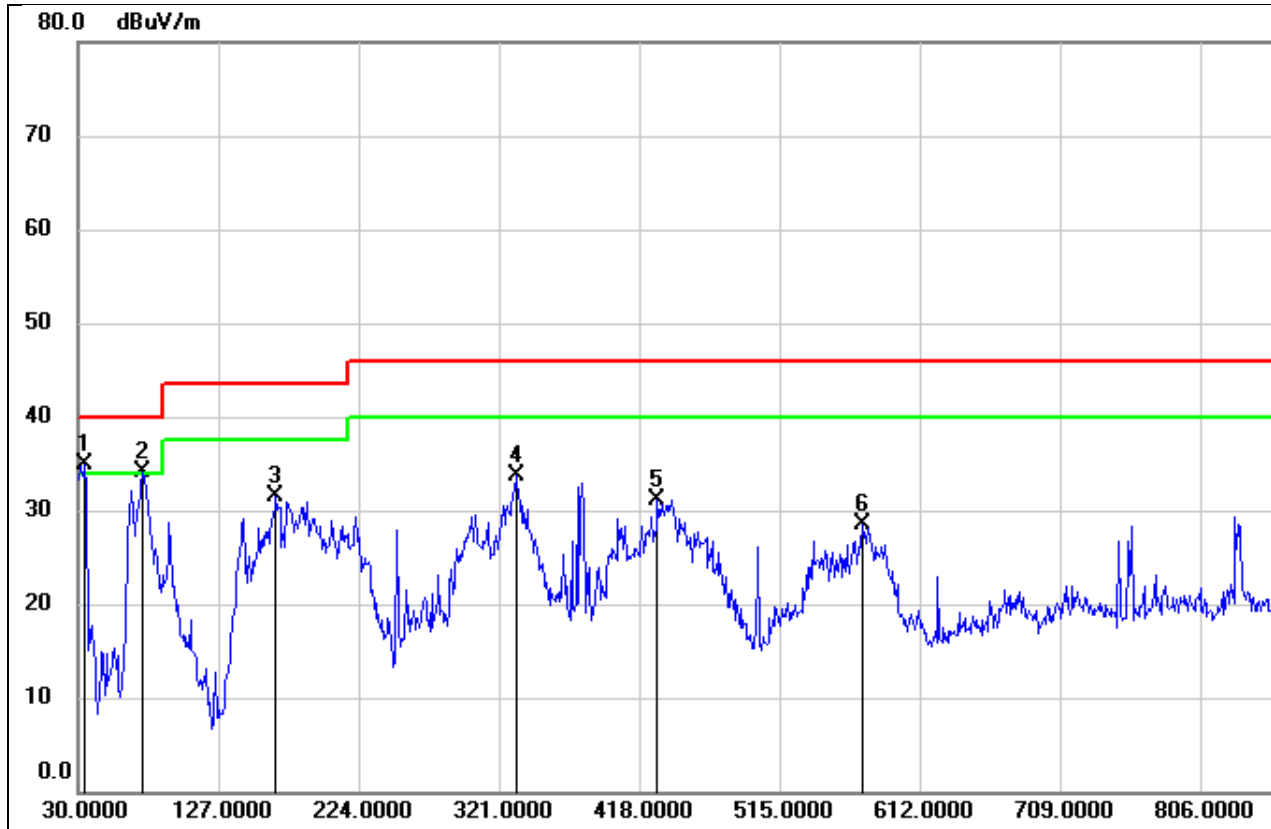

No.	Frequency (MHz)	Reading (dBuV)	Correct (dB/m)	Result (dBuV/m)	Limit (dBuV/m)	Margin (dB)	Remark
1	34.8500	53.96	-18.99	34.97	40.00	-5.03	QP
2	74.6200	55.31	-21.12	34.19	40.00	-5.81	QP
3	166.7700	48.69	-17.13	31.56	43.50	-11.94	QP
4	333.6099	47.44	-13.68	33.76	46.00	-12.24	QP
5	430.6100	43.33	-12.15	31.18	46.00	-14.82	QP
6	572.2300	38.47	-9.95	28.52	46.00	-17.48	QP

Test Mode:	802.11ax HE20	Channel:	6115
Polarity:	Vertical	Test Voltage:	DC 12 V

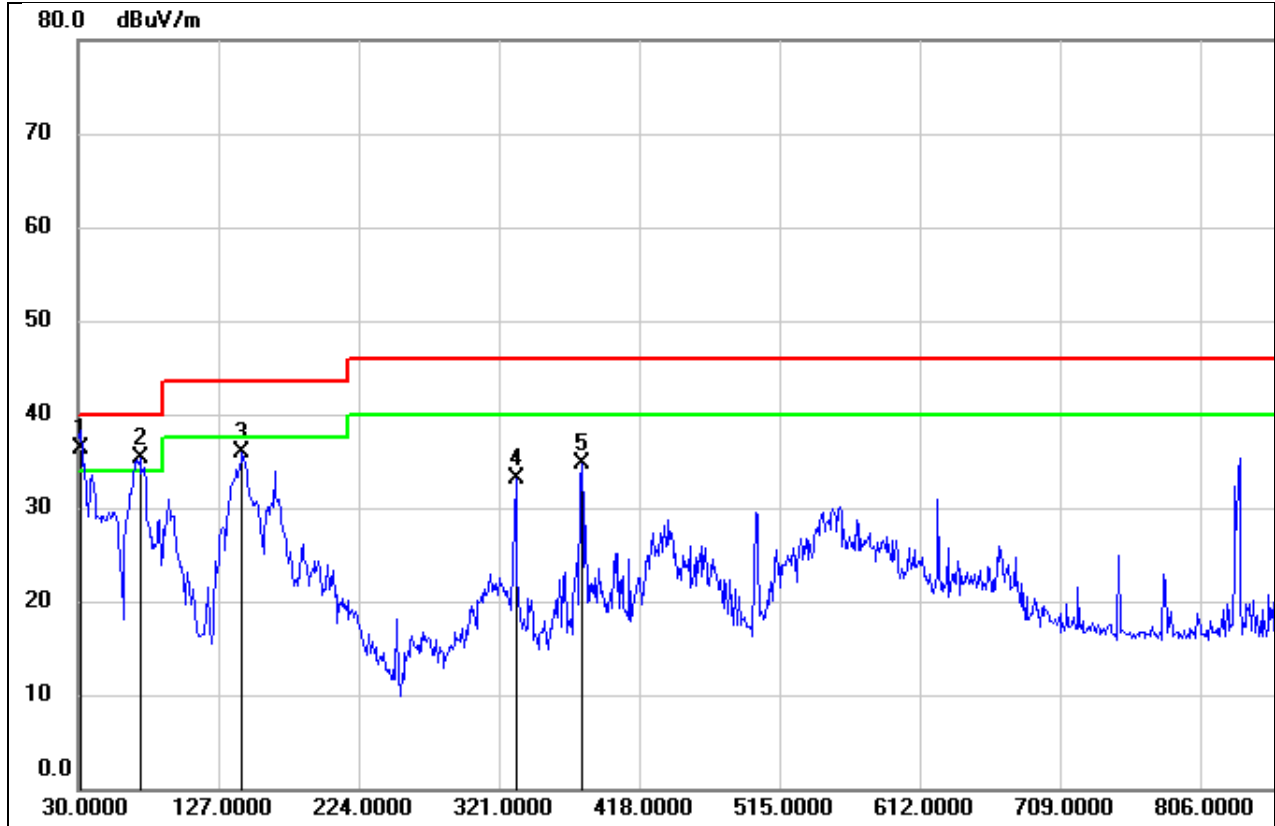

No.	Frequency (MHz)	Reading (dBuV)	Correct (dB/m)	Result (dBuV/m)	Limit (dBuV/m)	Margin (dB)	Remark
1	31.9400	54.82	-18.55	36.27	40.00	-3.73	QP
2	72.6800	56.32	-20.96	35.36	40.00	-4.64	QP
3	143.4900	54.50	-18.69	35.81	43.50	-7.69	QP
4	332.6400	46.77	-13.74	33.03	46.00	-12.97	QP
5	378.2300	47.56	-12.89	34.67	46.00	-11.33	QP
6	950.5300	41.12	-4.66	36.46	46.00	-9.54	QP

8.8. SIMULTANEOUSLY TRANSMISSION SPURIOUS EMISSIONS

(1 GHz~18 GHz) (Worst case)

Test Mode:	WIFI 2.4G 802.11b Mode 2437 MHz & WIFI 5G 802.11a Mode 5745 MHz & WIFI 6G 802.11ax HE20 Mode 6115 MHz		
Polarity:	Horizontal	Test Voltage:	DC 12 V

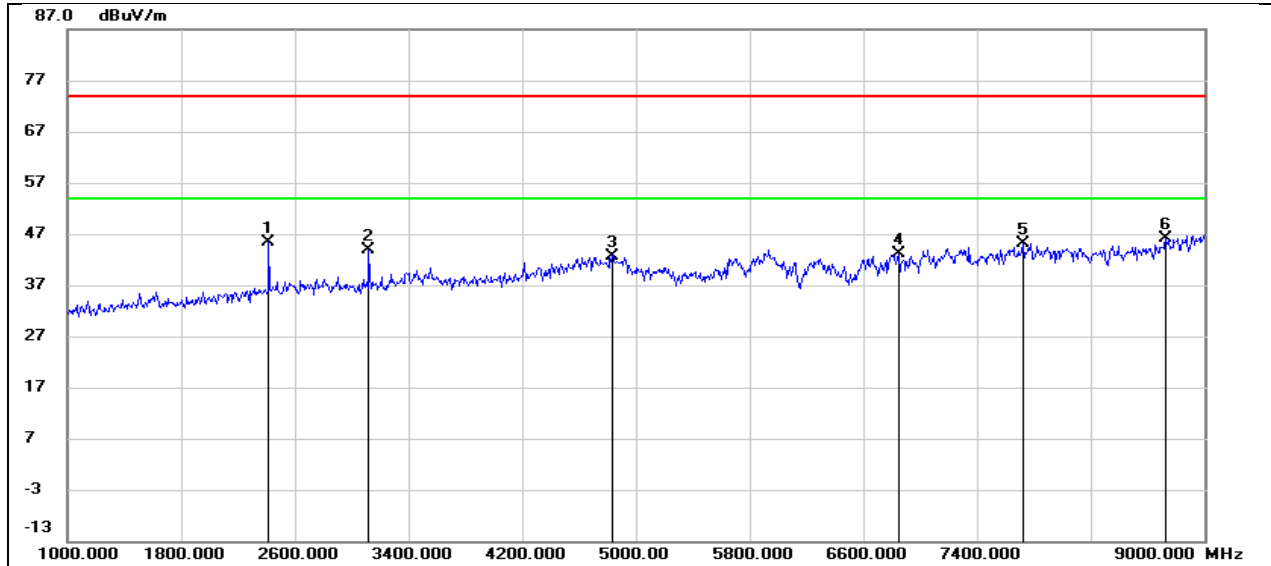

No.	Frequency (MHz)	Reading (dBuV)	Correct (dB/m)	Result (dBuV/m)	Limit (dBuV/m)	Margin (dB)	Remark
1	2412.000	54.39	-8.94	45.45	74.00	-28.55	peak
2	3120.000	50.68	-6.71	43.97	74.00	-30.03	peak
3	4832.000	43.58	-0.83	42.75	74.00	-31.25	peak
4	6848.000	37.73	5.45	43.18	74.00	-30.82	peak
5	7720.000	39.50	5.67	45.17	74.00	-28.83	peak
6	8728.000	38.38	7.83	46.21	74.00	-27.79	peak

Test Mode:	WIFI 2.4G 802.11b Mode 2437 MHz & WIFI 5G 802.11a Mode 5745 MHz & WIFI 6G 802.11ax HE Mode 6115 MHz		
Polarity:	Vertical	Test Voltage:	DC 12 V

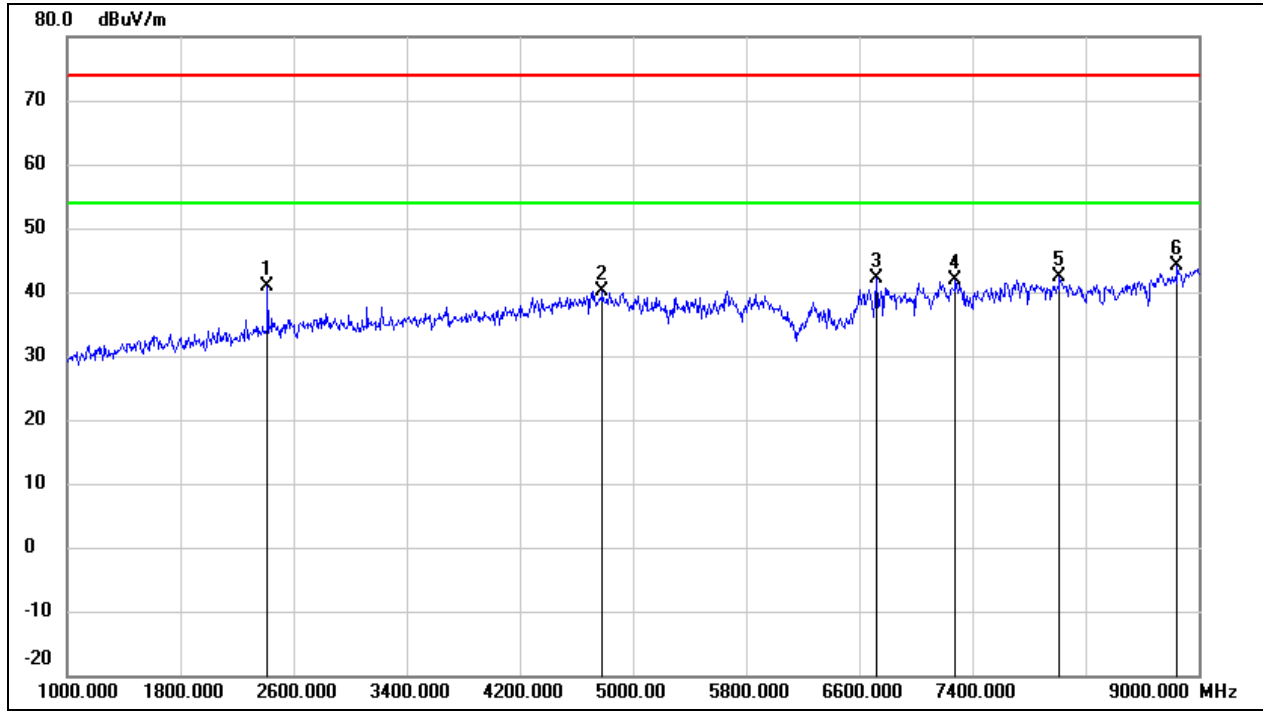

No.	Frequency (MHz)	Reading (dBuV)	Correct (dB/m)	Result (dBuV/m)	Limit (dBuV/m)	Margin (dB)	Remark
1	2412.000	49.72	-8.94	40.78	74.00	-33.22	peak
2	4784.000	41.22	-1.01	40.21	74.00	-33.79	peak
3	6720.000	37.29	4.81	42.10	74.00	-31.90	peak
4	7280.000	36.02	5.92	41.94	74.00	-32.06	peak
5	8016.000	36.65	5.67	42.32	74.00	-31.68	peak
6	8848.000	35.51	8.67	44.18	74.00	-29.82	peak

Test Mode:	WIFI 2.4G 802.11b Mode 2437 MHz & WIFI 5G 802.11a Mode 5745 MHz & WIFI 6G 802.11ax HE Mode 6115 MHz		
Polarity:	Horizontal	Test Voltage:	DC 12 V

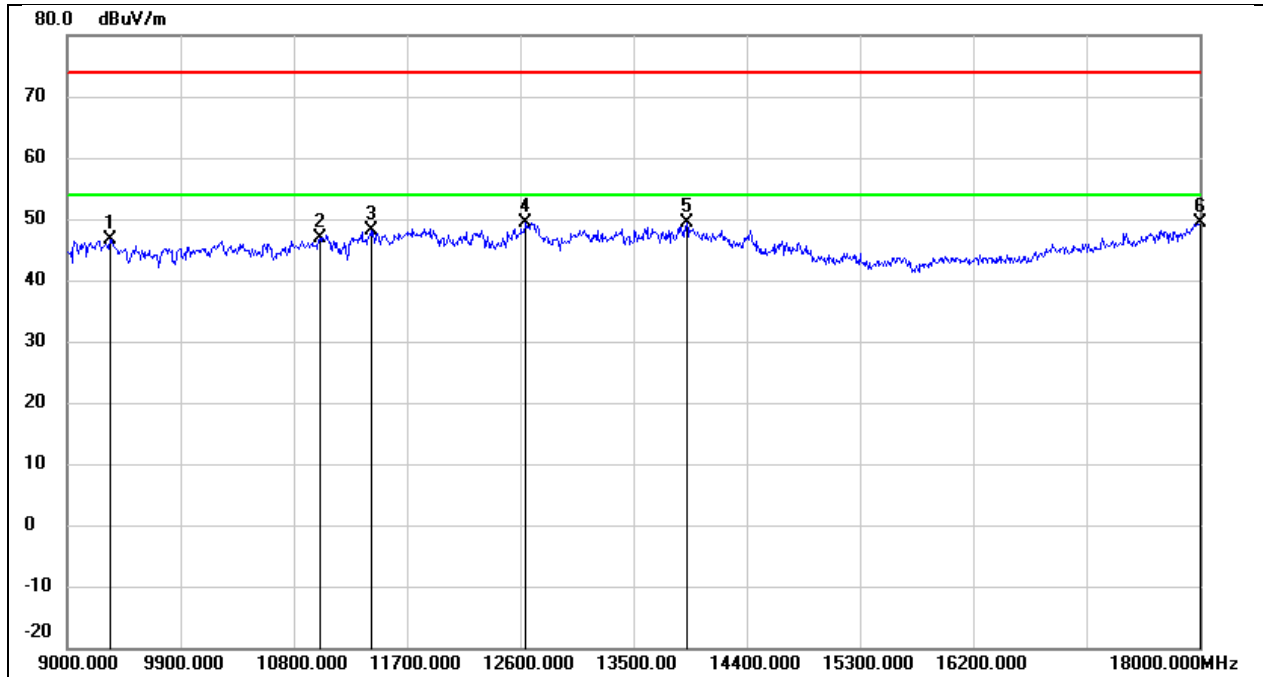

No.	Frequency (MHz)	Reading (dBuV)	Correct (dB/m)	Result (dBuV/m)	Limit (dBuV/m)	Margin (dB)	Remark
1	9342.000	35.88	10.87	46.75	74.00	-27.25	peak
2	11007.000	32.18	14.77	46.95	74.00	-27.05	peak
3	11412.000	31.86	16.22	48.08	74.00	-25.92	peak
4	12645.000	31.39	17.92	49.31	74.00	-24.69	peak
5	13923.000	27.54	21.72	49.26	74.00	-24.74	peak
6	18000.000	24.13	25.16	49.29	74.00	-24.71	peak

Test Mode:	WIFI 2.4G 802.11b Mode 2437 MHz & WIFI 5G 802.11a Mode 5745 MHz & WIFI 6G 802.11ax HE Mode 6115 MHz		
Polarity:	Vertical	Test Voltage:	DC 12 V

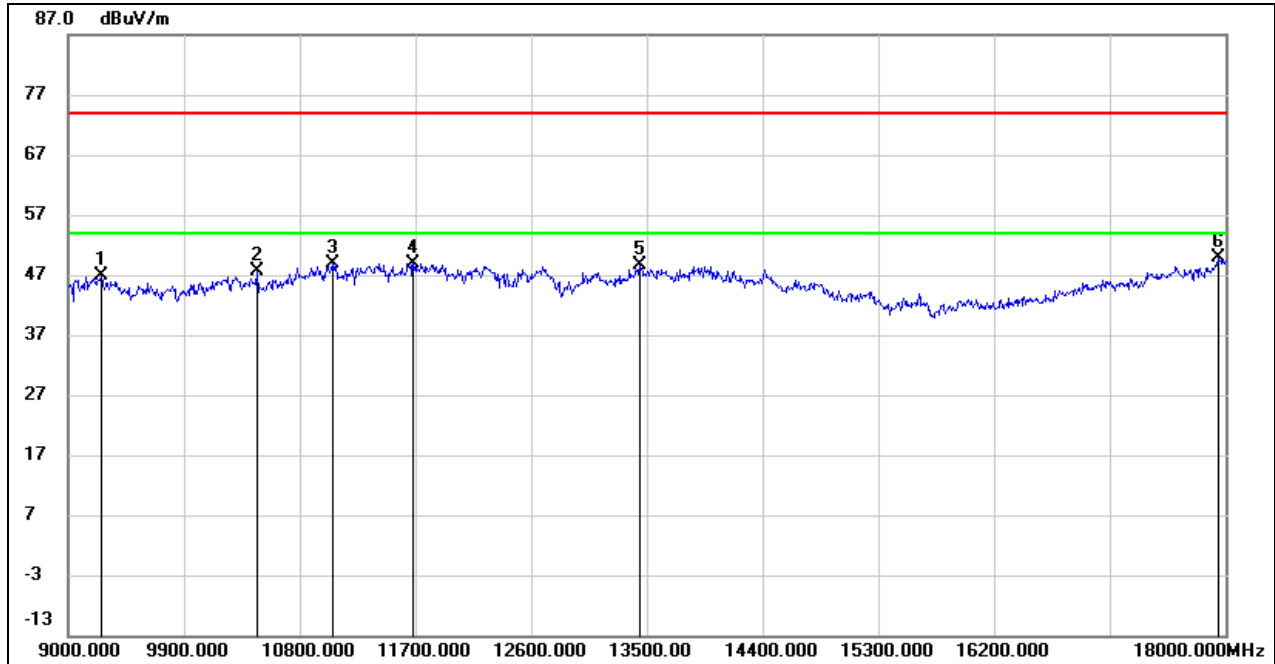

No.	Frequency (MHz)	Reading (dBuV)	Correct (dB/m)	Result (dBuV/m)	Limit (dBuV/m)	Margin (dB)	Remark
1	9261.000	36.04	10.85	46.89	74.00	-27.11	peak
2	10467.000	34.60	13.05	47.65	74.00	-26.35	peak
3	11052.000	33.85	14.94	48.79	74.00	-25.21	peak
4	11682.000	31.96	17.04	49.00	74.00	-25.00	peak
5	13446.000	28.00	20.60	48.60	74.00	-25.40	peak
6	17946.000	25.05	24.82	49.87	74.00	-24.13	peak

9. AC POWER LINE CONDUCTED EMISSION

LIMITS

Please refer to CFR 47 FCC §15.207 (a) and ISED RSS-Gen Clause 8.8

FREQUENCY (MHz)	Quasi-peak	Average
0.15 -0.5	66 - 56 *	56 - 46 *
0.50 -5.0	56.00	46.00
5.0 -30.0	60.00	50.00

TEST PROCEDURE

Refer to ANSI C63.10-2013 clause 6.2.

The EUT is put on a table of non-conducting material that is 80 cm high. The vertical conducting wall of shielding is located 40 cm to the rear of the EUT. The power line of the EUT is connected to the AC mains through a Artificial Mains Network (A.M.N.). A EMI Measurement Receiver (R&S Test Receiver ESR3) is used to test the emissions from both sides of AC line. According to the requirements in Section 6.2 of ANSI C63.10-2013. Conducted emissions from the EUT measured in the frequency range between 0.15 MHz and 30 MHz using CISPR Quasi-Peak and average detector mode. The bandwidth of EMI test receiver is set at 9 kHz.

The arrangement of the equipment is installed to meet the standards and operating in a manner, which tends to maximize its emission characteristics in a normal application.

TEST SETUP

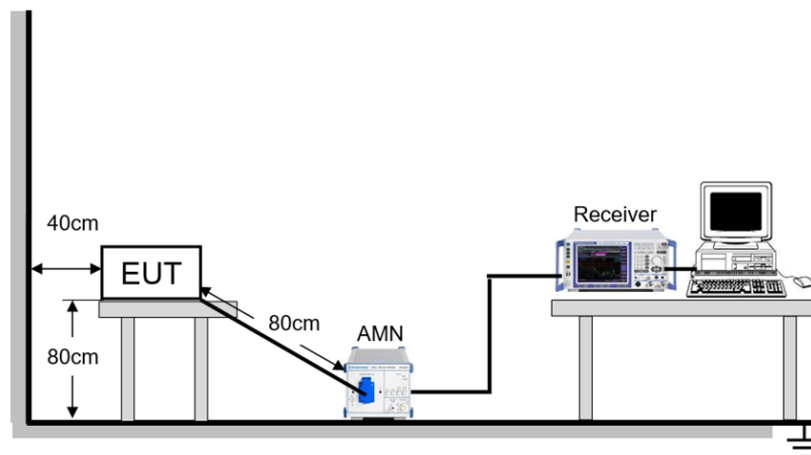

TEST ENVIRONMENT

Temperature	26.8°C	Relative Humidity	57%
Atmosphere Pressure	101kPa	Test Voltage	AC 120 V, 60 Hz

TEST DATE / ENGINEER

Test Date	June 16, 2023	Test By	Wite Chen
-----------	---------------	---------	-----------

TEST RESULTS

Test Mode:	802.11ax HE20	Channel:	6115
Line:	Line	Test Voltage:	AC 120 V, 60 Hz

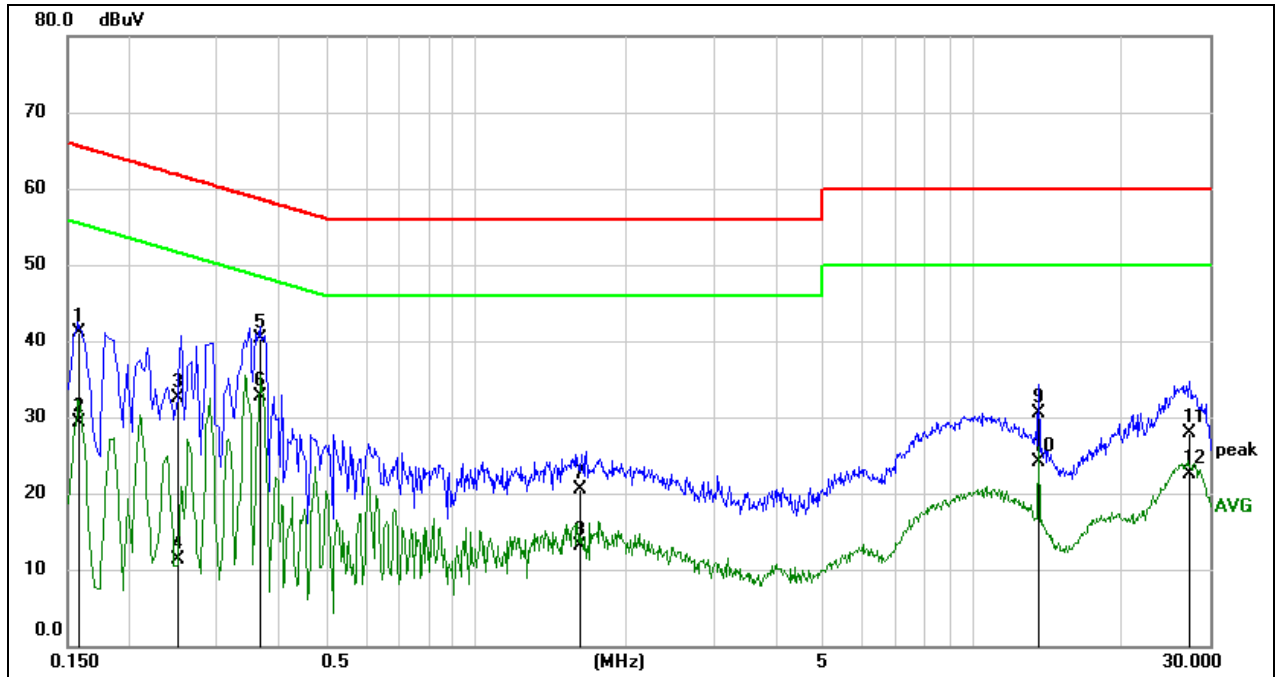

No.	Frequency (MHz)	Reading (dBuV)	Correct (dB)	Result (dBuV)	Limit (dBuV)	Margin (dB)	Remark
1	0.1587	31.60	9.59	41.19	65.53	-24.34	QP
2	0.1587	19.81	9.59	29.40	55.53	-26.13	AVG
3	0.2507	22.88	9.59	32.47	61.73	-29.26	QP
4	0.2507	1.78	9.59	11.37	51.73	-40.36	AVG
5	0.3636	30.72	9.59	40.31	58.65	-18.34	QP
6	0.3636	23.11	9.59	32.70	48.65	-15.95	AVG
7	1.6057	10.86	9.62	20.48	56.00	-35.52	QP
8	1.6057	3.49	9.62	13.11	46.00	-32.89	AVG
9	13.5595	20.66	9.76	30.42	60.00	-29.58	QP
10	13.5595	14.34	9.76	24.10	50.00	-25.90	AVG
11	27.2883	18.18	9.74	27.92	60.00	-32.08	QP
12	27.2883	12.83	9.74	22.57	50.00	-27.43	AVG

Note:

1. Result = Reading + Correct Factor.
2. If QP Result complies with AV limit, AV Result is deemed to comply with AV limit.
3. Test setup: RBW: 200 Hz (9 kHz ~ 150 kHz), 9 kHz (150 kHz ~ 30 MHz).
4. Step size: 80 Hz (0.009 MHz ~ 0.15 MHz), 4 kHz (0.15 MHz ~ 30 MHz), Scan time: auto.

Note: All the modes have been tested, only the worst data was recorded in the report.

Test Mode:	802.11ax HE20	Channel:	6115
Line:	Neutral	Test Voltage:	AC 120 V, 60 Hz

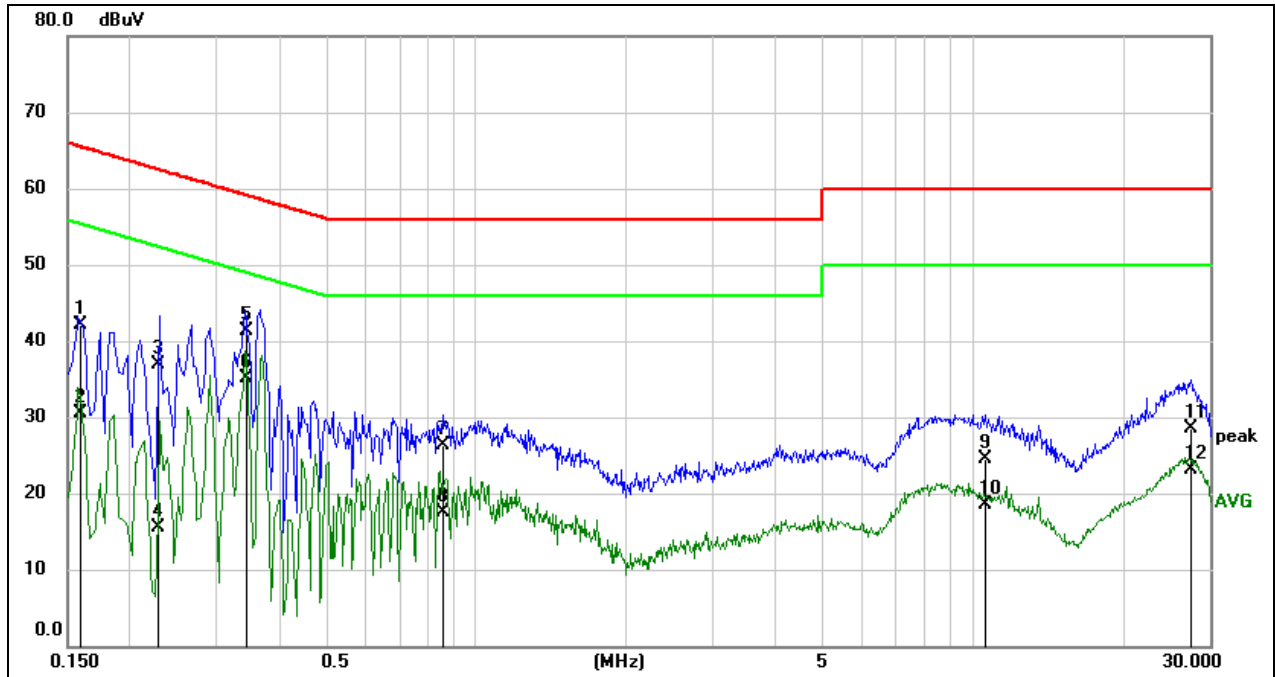

No.	Frequency (MHz)	Reading (dBuV)	Correct (dB)	Result (dBuV)	Limit (dBuV)	Margin (dB)	Remark
1	0.1590	32.58	9.51	42.09	65.52	-23.43	QP
2	0.1590	21.06	9.51	30.57	55.52	-24.95	AVG
3	0.2276	27.33	9.58	36.91	62.54	-25.63	QP
4	0.2276	5.99	9.58	15.57	52.54	-36.97	AVG
5	0.3462	31.70	9.54	41.24	59.05	-17.81	QP
6	0.3462	25.55	9.54	35.09	49.05	-13.96	AVG
7	0.8540	16.72	9.50	26.22	56.00	-29.78	QP
8	0.8540	8.10	9.50	17.60	46.00	-28.40	AVG
9	10.5589	14.89	9.63	24.52	60.00	-35.48	QP
10	10.5589	8.82	9.63	18.45	50.00	-31.55	AVG
11	27.4683	18.79	9.73	28.52	60.00	-31.48	QP
12	27.4683	13.37	9.73	23.10	50.00	-26.90	AVG

Note:

1. Result = Reading + Correct Factor.
2. If QP Result complies with AV limit, AV Result is deemed to comply with AV limit.
3. Test setup: RBW: 200 Hz (9 kHz ~ 150 kHz), 9 kHz (150 kHz ~ 30 MHz).
4. Step size: 80 Hz (0.009 MHz ~ 0.15 MHz), 4 kHz (0.15 MHz ~ 30 MHz), Scan time: auto.

Note: All the modes have been tested, only the worst data was recorded in the report.

10. ANTENNA REQUIREMENT

REQUIREMENT

Please refer to FCC part 15.203

An intentional radiator shall be designed to ensure that no antenna other than that furnished by the responsible party shall be used with the device. The use of a permanently attached antenna or of an antenna that uses a unique coupling to the intentional radiator shall be considered sufficient to comply with the provisions of this section. The manufacturer may design the unit so that a broken antenna can be replaced by the user, but the use of a standard antenna jack or electrical connector is prohibited.

Please refer to FCC part 15.407(a)

For an indoor access point operating in the band 5.15-5.25 GHz, the maximum conducted output power over the frequency band of operation shall not exceed 1 W provided the maximum antenna gain does not exceed 6 dBi. In addition, the maximum power spectral density shall not exceed 17 dBm in any 1 megahertz band. If transmitting antennas of directional gain greater than 6 dBi are used, both the maximum conducted output power and the maximum power spectral density shall be reduced by the amount in dB that the directional gain of the antenna exceeds 6 dBi.

DESCRIPTION

Pass

11. TEST DATA

11.1. APPENDIX A: EMISSION BANDWIDTH

11.1.1. Test Result

TestMode	Antenna	Frequency[MHz]	26db EBW [MHz]	FL[MHz]	FH[MHz]	Verdict
11AX20MIMO	Ant1	6115	22.52	6103.68	6126.20	PASS
	Ant3	6115	22.44	6103.72	6126.16	PASS
	Ant1	6275	22.16	6263.80	6285.96	PASS
	Ant3	6275	22.12	6263.88	6286.00	PASS
	Ant1	6415	22.00	6403.96	6425.96	PASS
	Ant3	6415	22.04	6404.08	6426.12	PASS
	Ant1	6435	22.08	6424.00	6446.08	PASS
	Ant3	6435	22.08	6423.96	6446.04	PASS
	Ant1	6475	22.08	6464.00	6486.08	PASS
	Ant3	6475	21.68	6464.16	6485.84	PASS
	Ant1	6515	22.00	6503.96	6525.96	PASS
	Ant3	6515	21.76	6504.16	6525.92	PASS
	Ant1	6535	21.88	6524.04	6545.92	PASS
	Ant3	6535	21.84	6524.08	6545.92	PASS
	Ant1	6715	22.56	6703.84	6726.40	PASS
	Ant3	6715	22.56	6703.80	6726.36	PASS
	Ant1	6875	22.16	6863.88	6886.04	PASS
	Ant3	6875	21.76	6864.08	6885.84	PASS
	Ant1	6895	22.32	6883.80	6906.12	PASS
	Ant3	6895	22.00	6883.96	6905.96	PASS
Ant1	7015	22.44	7003.72	7026.16	PASS	
Ant3	7015	21.84	7004.08	7025.92	PASS	
Ant1	7095	21.96	7084.00	7105.96	PASS	
Ant3	7095	21.76	7084.08	7105.84	PASS	
Ant1	7115	21.92	7103.92	7125.84	PASS	
Ant3	7115	21.60	7104.20	7125.80	PASS	
11AX40MIMO	Ant1	6125	44.24	6103.16	6147.40	PASS
	Ant3	6125	43.92	6102.92	6146.84	PASS
	Ant1	6285	43.68	6262.60	6306.28	PASS
	Ant3	6285	43.36	6263.24	6306.60	PASS
	Ant1	6405	43.68	6383.08	6426.76	PASS
	Ant3	6405	44.56	6382.60	6427.16	PASS
	Ant1	6445	43.84	6422.84	6466.68	PASS
	Ant3	6445	43.76	6423.08	6466.84	PASS
	Ant1	6485	44.00	6463.00	6507.00	PASS
	Ant3	6485	44.16	6462.76	6506.92	PASS
	Ant1	6525	44.88	6502.36	6547.24	PASS
	Ant3	6525	43.60	6503.24	6546.84	PASS
	Ant1	6725	44.08	6702.76	6746.84	PASS
	Ant3	6725	44.32	6702.44	6746.76	PASS
	Ant1	6845	44.08	6822.84	6866.92	PASS
	Ant3	6845	43.20	6823.40	6866.60	PASS
	Ant1	6885	44.64	6862.28	6906.92	PASS
	Ant3	6885	43.60	6863.24	6906.84	PASS
	Ant1	7005	43.44	6983.40	7026.84	PASS
	Ant3	7005	44.08	6982.76	7026.84	PASS
Ant1	7085	44.40	7062.60	7107.00	PASS	
Ant3	7085	43.76	7063.24	7107.00	PASS	
11AX80MIMO	Ant1	6145	88.80	6100.04	6188.84	PASS
	Ant3	6145	88.00	6100.84	6188.84	PASS
	Ant1	6225	87.84	6180.36	6268.20	PASS
	Ant3	6225	86.56	6181.80	6268.36	PASS

	Ant1	6385	87.20	6341.32	6428.52	PASS
	Ant3	6385	85.76	6341.80	6427.56	PASS
	Ant1	6465	88.96	6420.68	6509.64	PASS
	Ant3	6465	87.68	6420.68	6508.36	PASS
	Ant1	6545	87.84	6501.32	6589.16	PASS
	Ant3	6545	88.00	6501.16	6589.16	PASS
	Ant1	6705	89.60	6660.04	6749.64	PASS
	Ant3	6705	87.04	6660.36	6747.40	PASS
	Ant1	6865	86.72	6821.80	6908.52	PASS
	Ant3	6865	88.48	6820.04	6908.52	PASS
	Ant1	6945	88.16	6900.36	6988.52	PASS
	Ant3	6945	89.44	6899.88	6989.32	PASS
	Ant1	7025	87.04	6981.32	7068.36	PASS
	Ant3	7025	87.20	6981.16	7068.36	PASS
11AX160MIMO	Ant1	6185	169.60	6099.88	6269.48	PASS
	Ant3	6185	169.28	6100.84	6270.12	PASS
	Ant1	6345	171.84	6258.60	6430.44	PASS
	Ant3	6345	168.96	6259.56	6428.52	PASS
	Ant1	6505	170.88	6419.56	6590.44	PASS
	Ant3	6505	171.20	6419.88	6591.08	PASS
	Ant1	6665	171.20	6579.88	6751.08	PASS
	Ant3	6665	168.00	6580.52	6748.52	PASS
	Ant1	6825	169.60	6739.24	6908.84	PASS
	Ant3	6825	168.64	6740.20	6908.84	PASS
	Ant1	6985	170.24	6899.56	7069.80	PASS
	Ant3	6985	169.60	6900.52	7070.12	PASS

11.1.2. Test Graphs

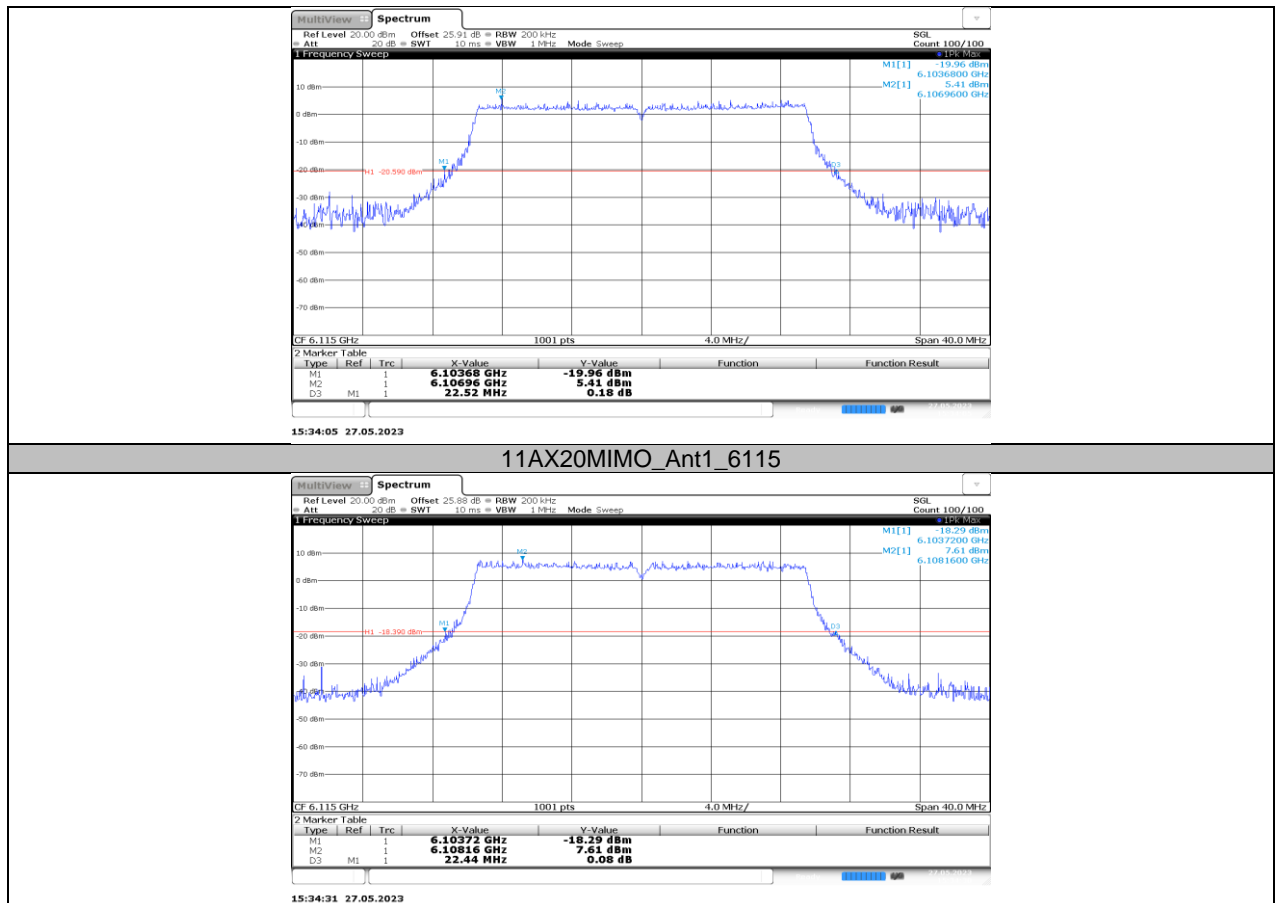

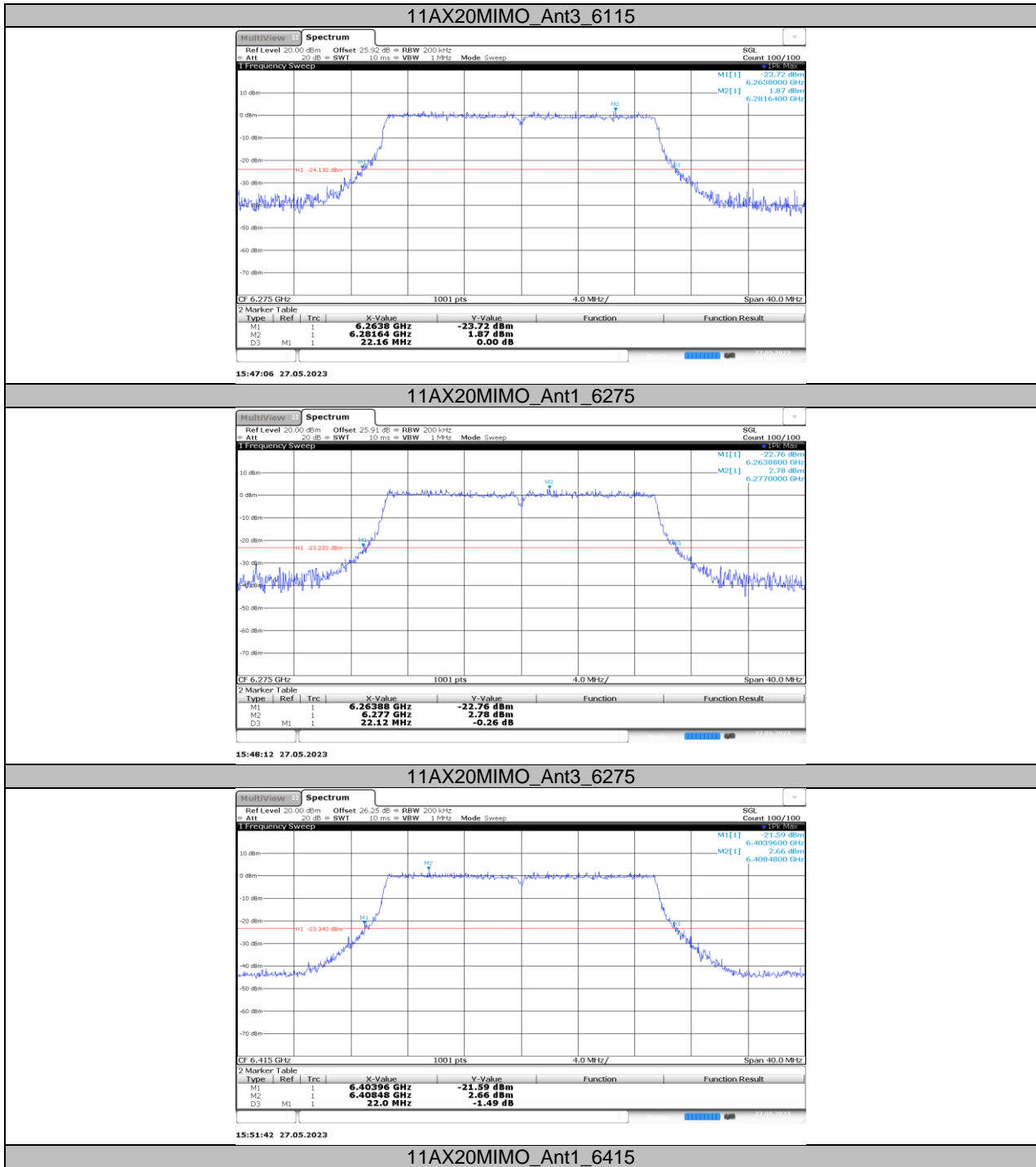

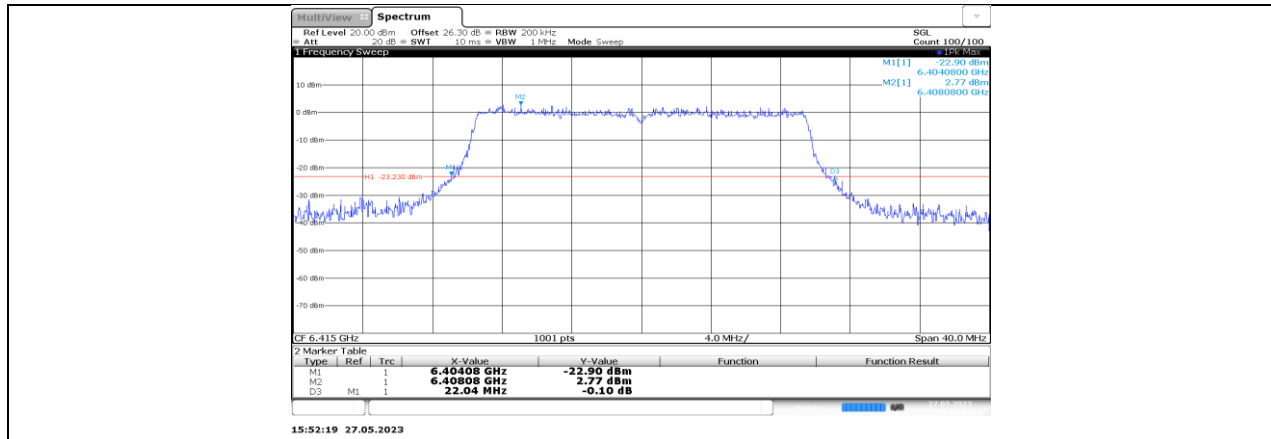

11AX20MIMO_Ant3_6415

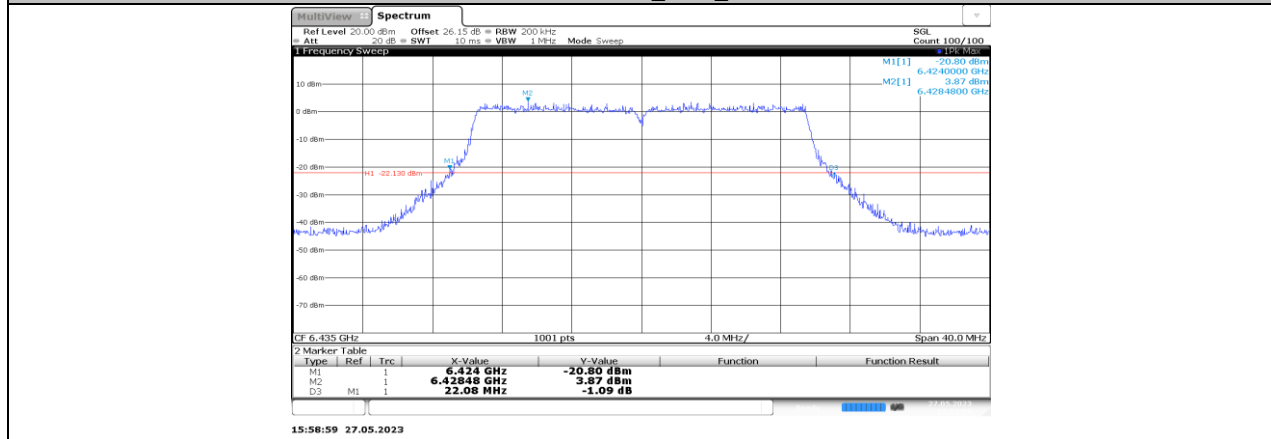

11AX20MIMO_Ant1_6435

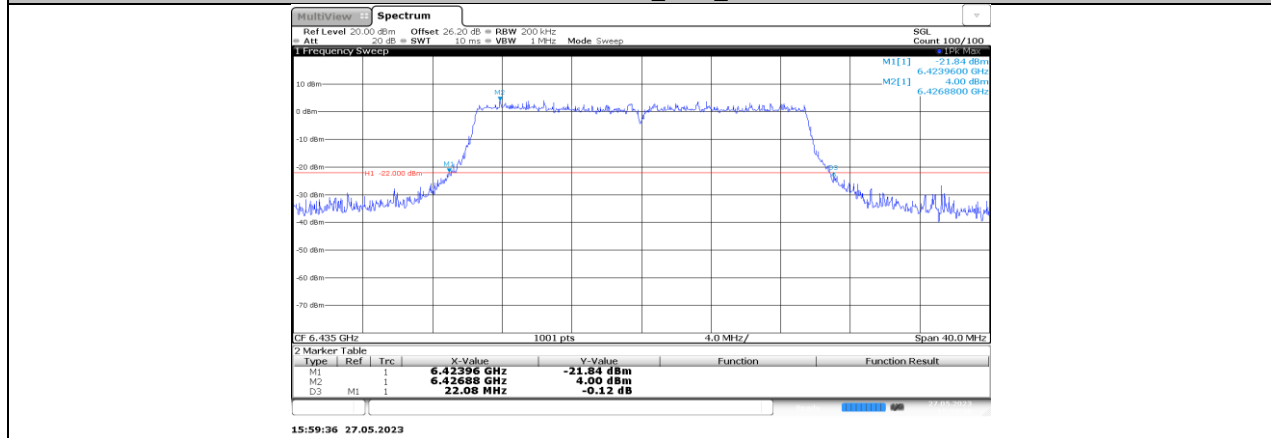

11AX20MIMO_Ant3_6435

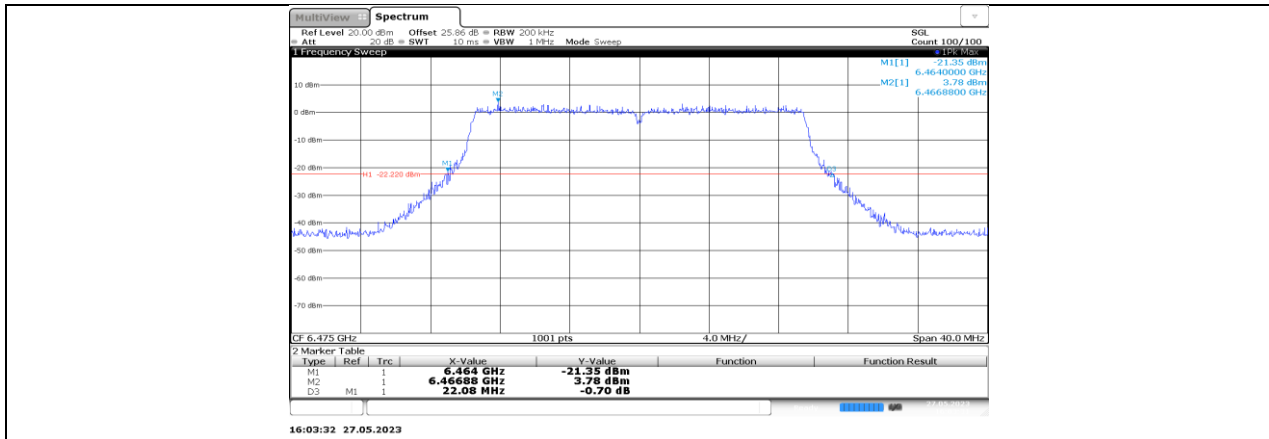

11AX20MIMO_Ant1_6475

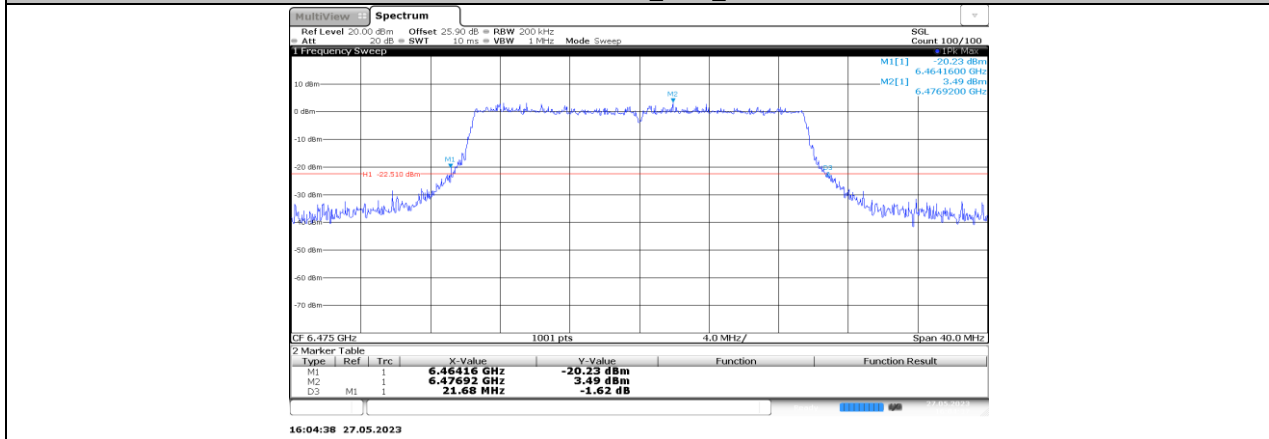

11AX20MIMO_Ant3_6475

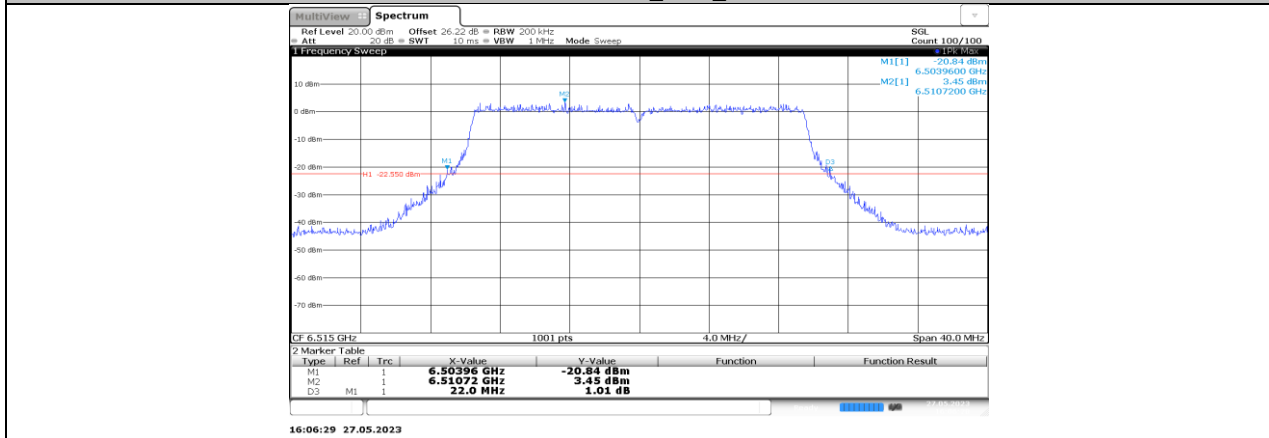

11AX20MIMO_Ant1_6515

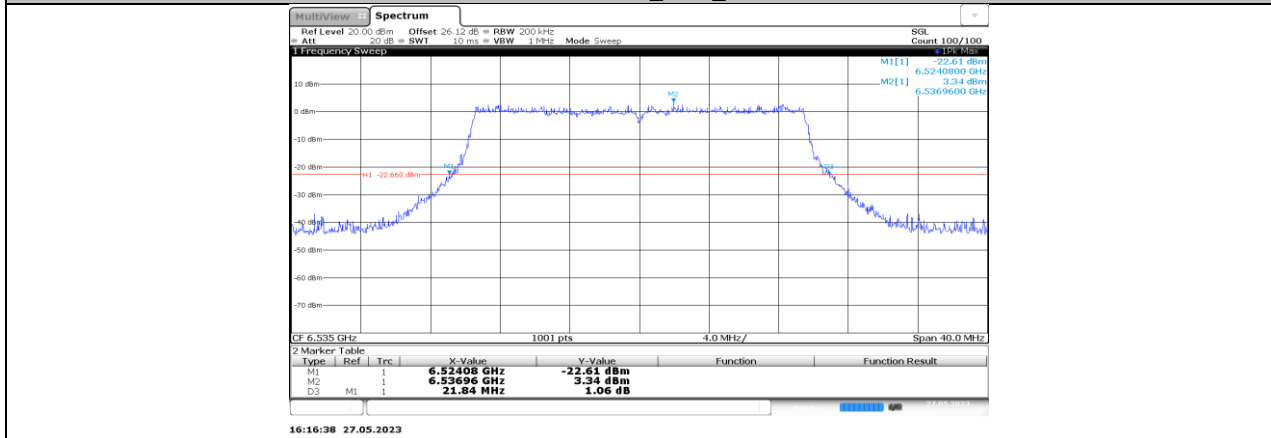
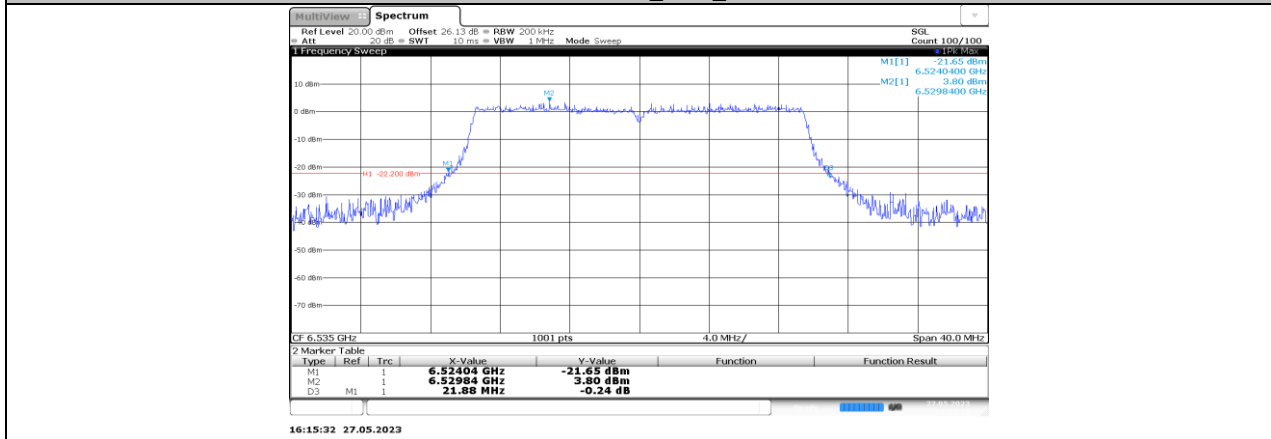
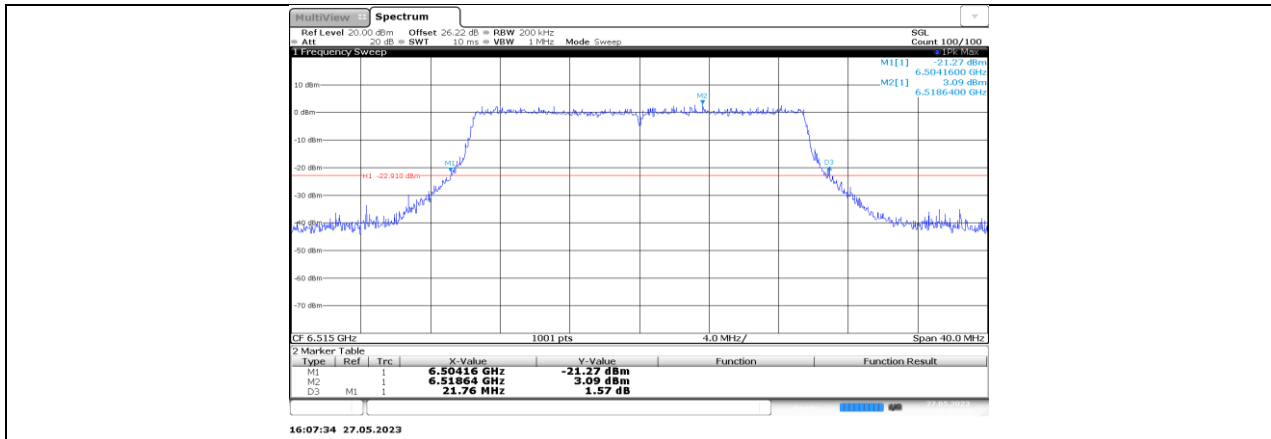

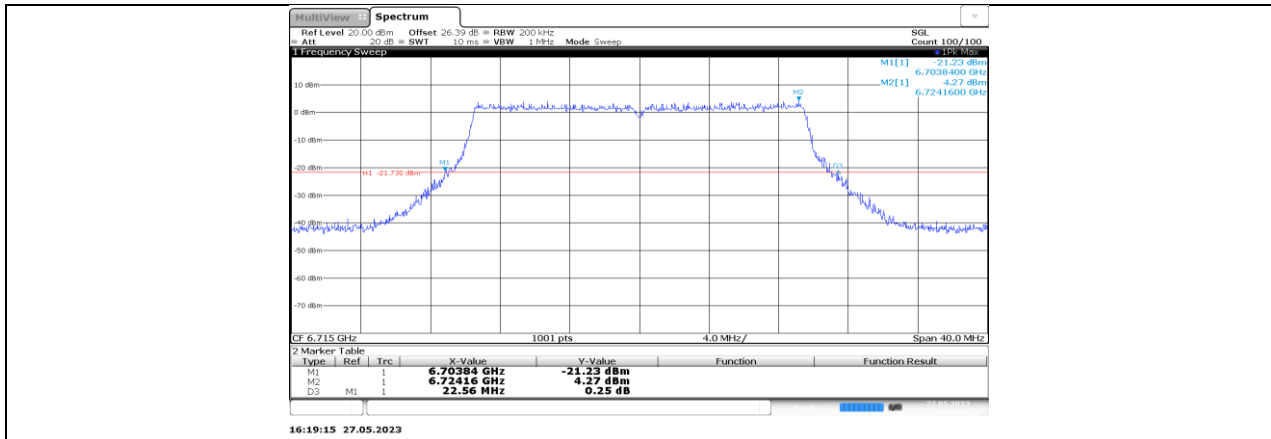

11AX20MIMO_Ant1_6715

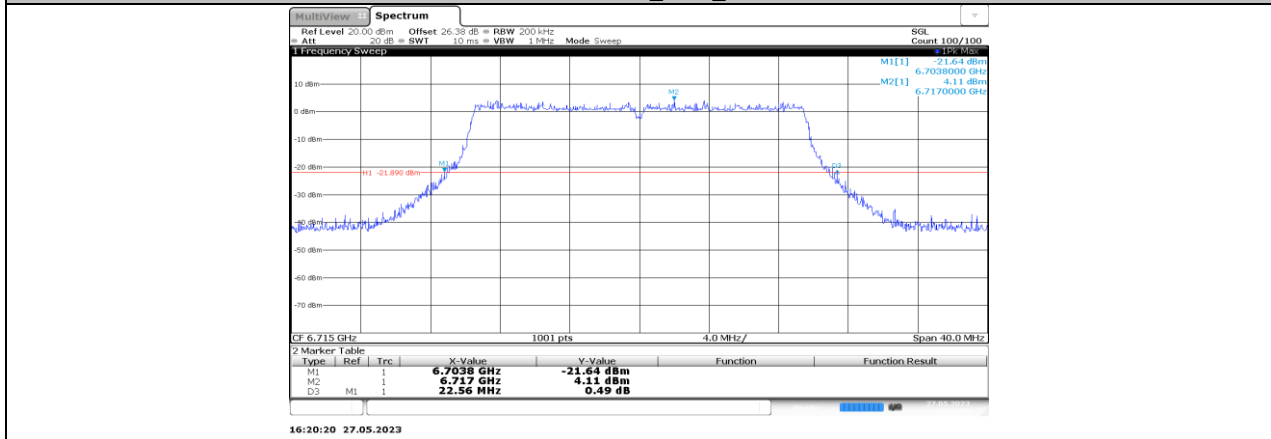

11AX20MIMO_Ant3_6715

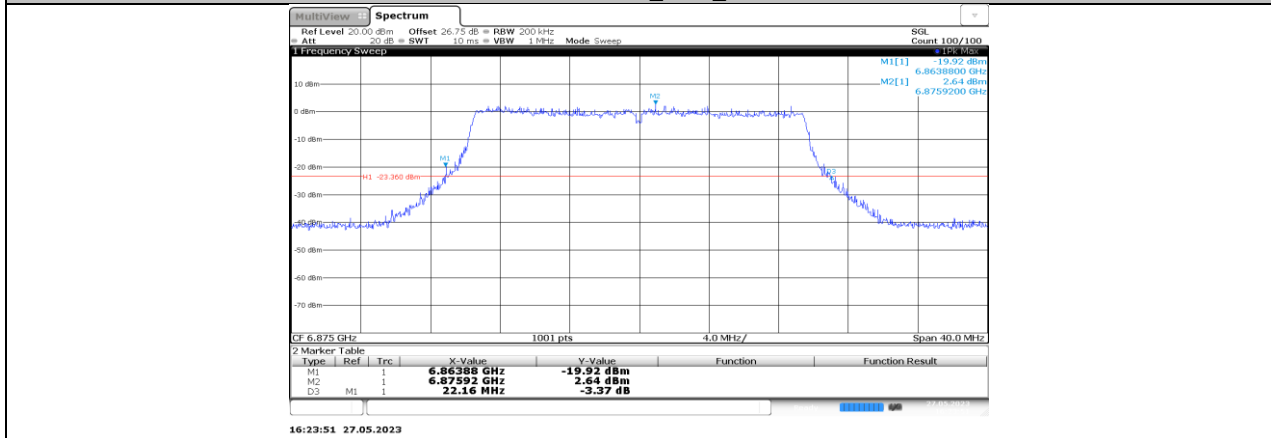

11AX20MIMO_Ant1_6875

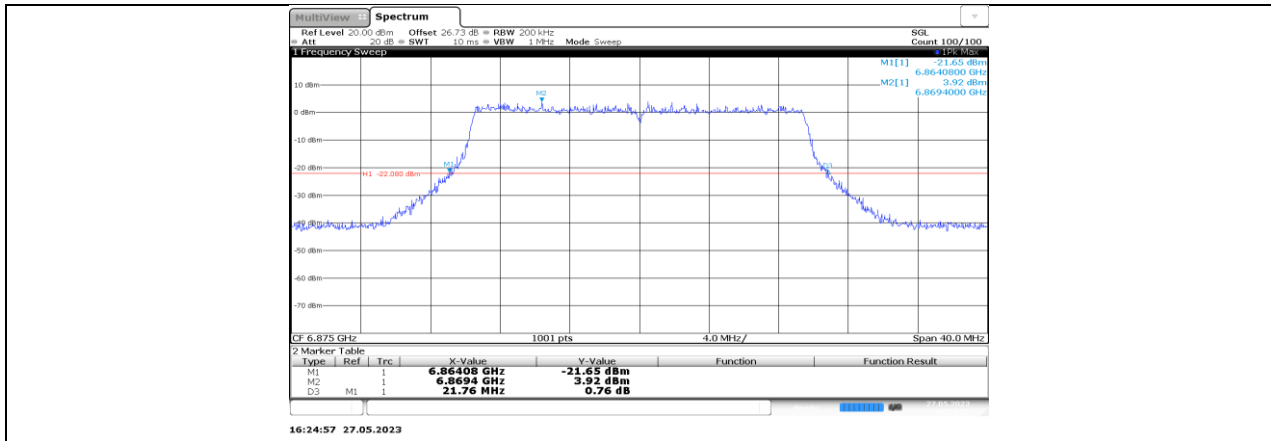

11AX20MIMO_Ant3_6875

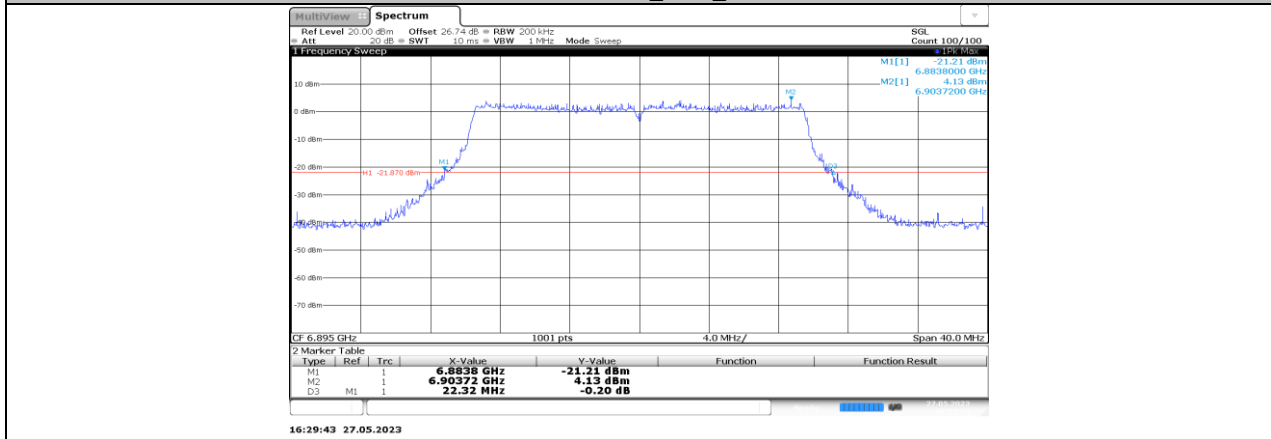

11AX20MIMO_Ant1_6895

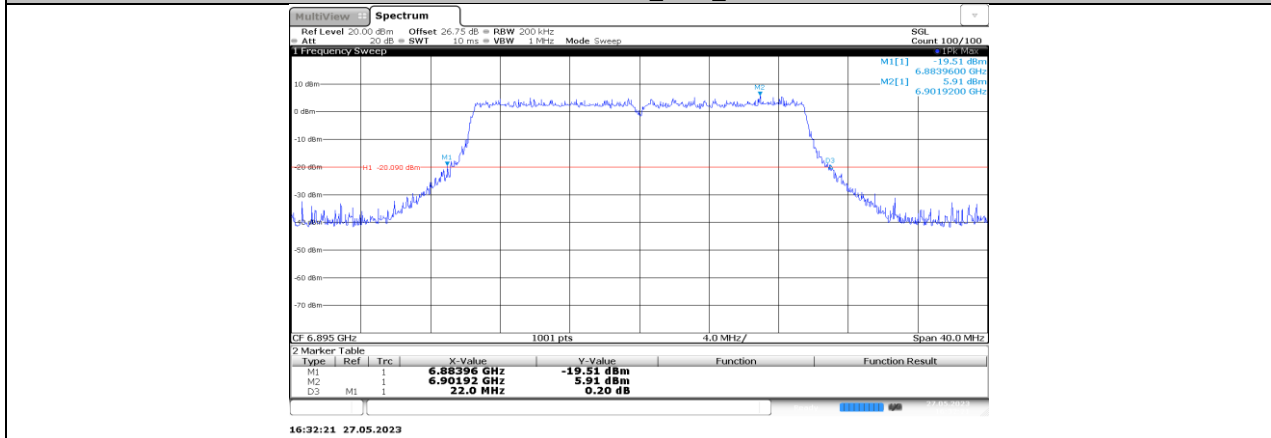

11AX20MIMO_Ant3_6895

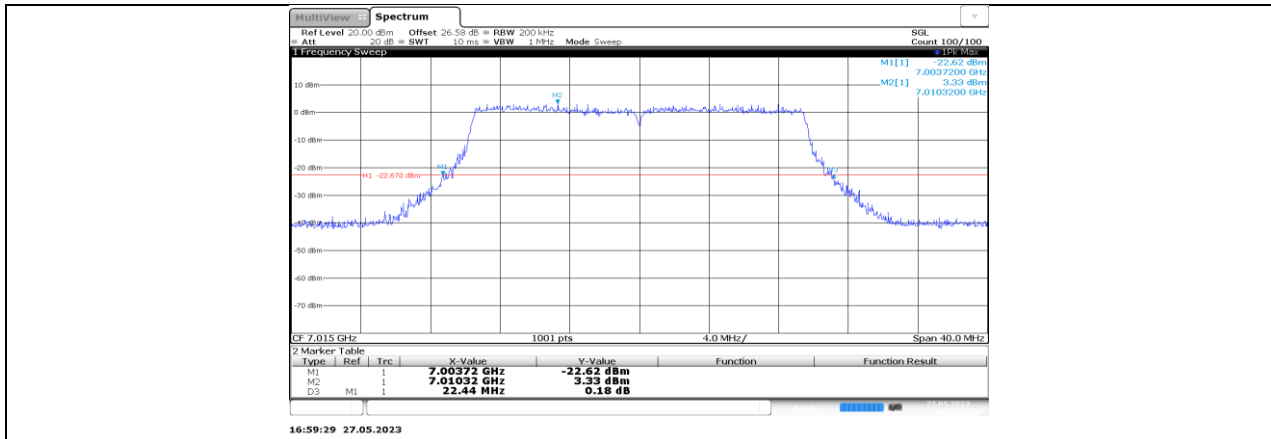

11AX20MIMO_Ant1_7015

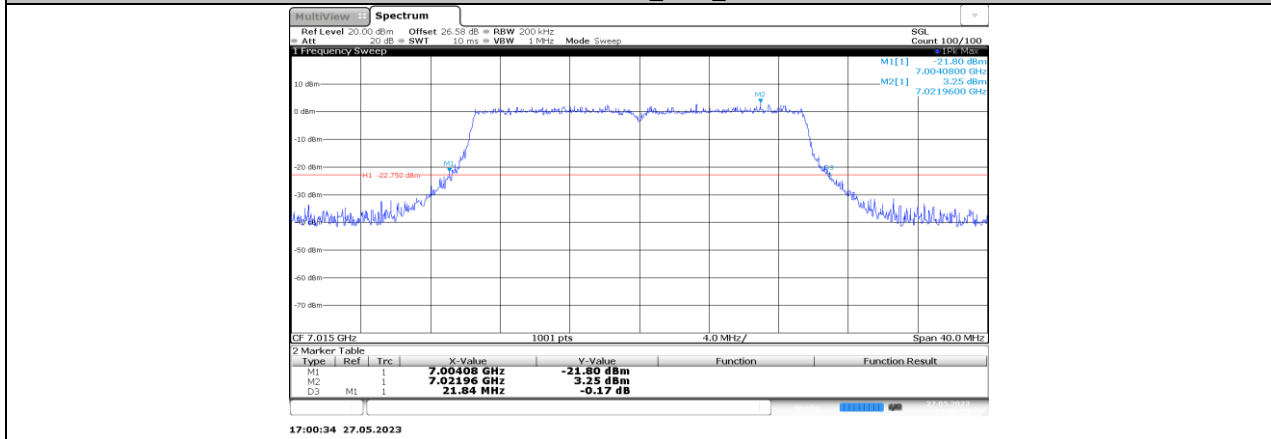

11AX20MIMO_Ant3_7015

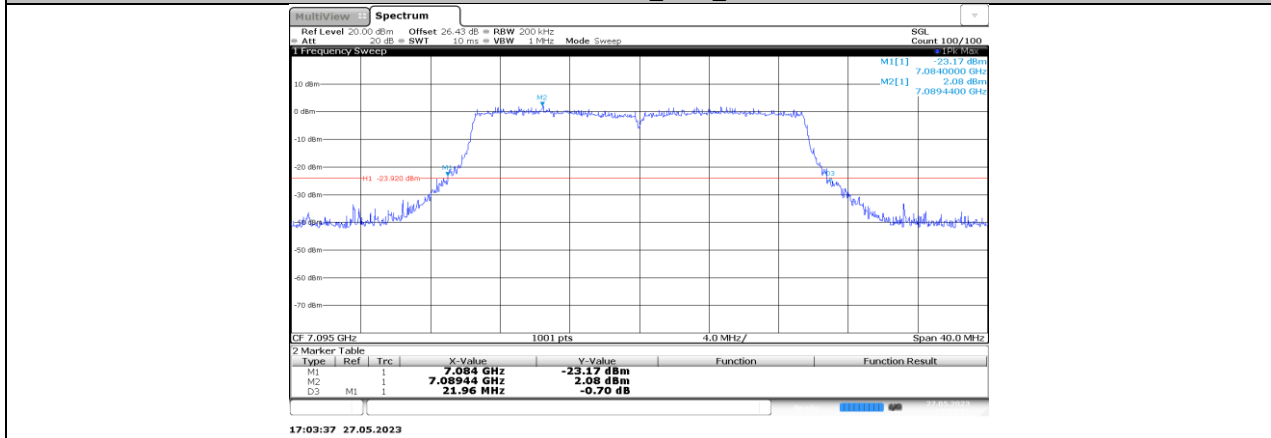

11AX20MIMO_Ant1_7095

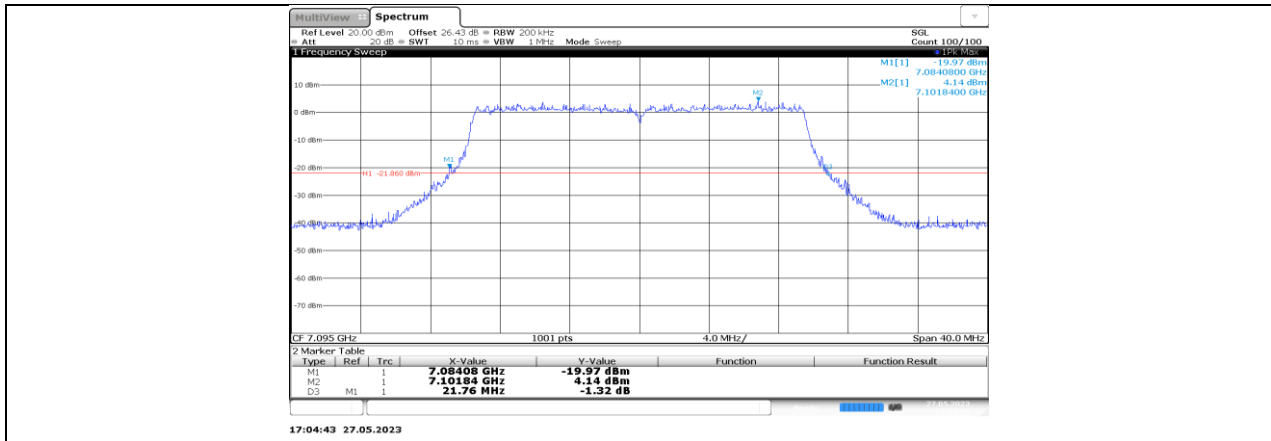

11AX20MIMO_Ant3_7095

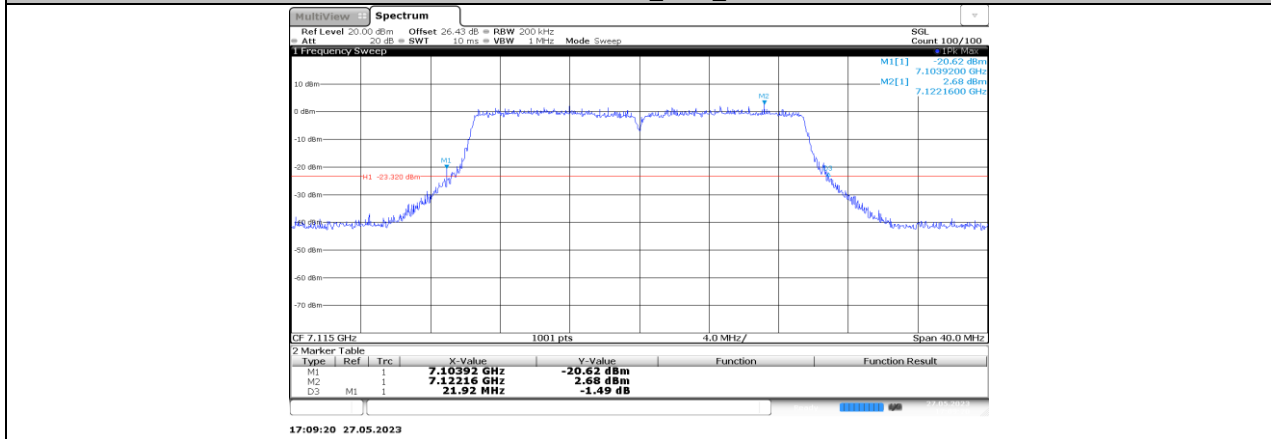

11AX20MIMO_Ant1_7115

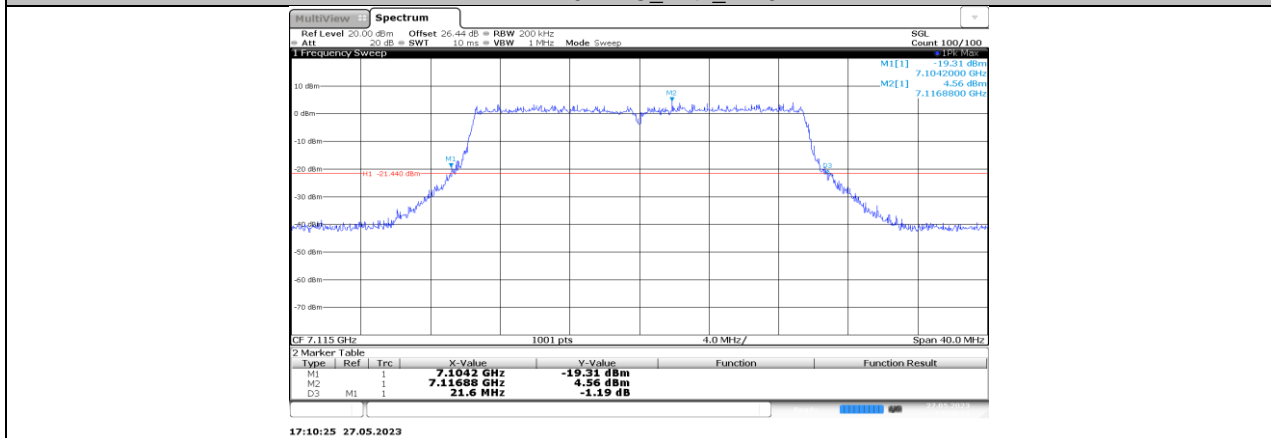

11AX20MIMO_Ant3_7115