

Product Name: Smart Phone	Report No: ITEZA2-202400259RF7
Product Model: S200, S200 S, S200 SE, S200 E, S200 X, S200 Plus, S200 Ultra, S200 Max, S200 XS, S200 X Pro, S200 X Plus, S200 X Max, S200 Mini, S200 Note, S200 Air, S200 Lite	Security Classification: Open
Version: V1.0	Total Page: 56

TIRT Testing Report

Prepared By:	Checked By:	Approved By:	
Aaron Long	Stone Tang	Joky Wang	
<i>Aaron Long</i>	<i>Stone Tang</i>	<i>Joky Wang</i>	

RF TEST REPORT

FCC ID: 2AX4YS200

According to

FCC CFR Title 47 Part 2
FCC CFR Title 47 Part 22 Subpart H
FCC CFR Title 47 Part 24 Subpart E
FCC CFR Title 47 Part 27 Subpart C
FCC CFR Title 47 Part 90 Subpart S
ANSI C63.26:2015

KDB 971168 D01 Power Meas License Digital Systems v03r01

Applicant:	Shenzhen DOOGEE Hengtong Technology CO.,LTD
Address:	B, 2/F, Building A4, Silicon Valley Power Digital Industrial Park, No. 22, Longhua New District, Shenzhen, China
Manufacturer:	Shenzhen DOOGEE Hengtong Technology CO.,LTD
Address:	B, 2/F, Building A4, Silicon Valley Power Digital Industrial Park, No. 22, Longhua New District, Shenzhen, China
Sample No:	1000040010
Product Name:	Smart Phone
Brand Name:	DOOGEE
Model No.:	S200, S200 S, S200 SE, S200 E, S200 X, S200 Plus, S200 Ultra, S200 Max, S200 XS, S200 X Pro, S200 X Plus, S200 X Max, S200 Mini, S200 Note, S200 Air, S200 Lite
Test No.:	S200

Date of Receipt:	2024/07/01
Date of Test:	2024/07/01~2024/07/14
Issued Date:	2024/07/14
Testing Lab:	TIRT

Note: This report shall not be reproduced except in full, without the written approval of Beijing TIRT Technology Service Co.,Ltd Shenzhen.Laboratory.
This document may be altered or revised by Beijing TIRT Technology Service Co.,Ltd Shenzhen. Laboratory.Personnel only, and shall be noted in the revision section of the document. The test results of this report relate only to the tested sample identified in this report.

TABLE OF CONTENTS

Description	Page
1 TEST SUMMARY	5
2 GENERAL INFORMATION	7
2.1 GENERAL DESCRIPTION OF EUT	7
2.2 RELATED SUBMITTAL(S) / GRANT (S)	8
2.3 TEST FACILITY	8
2.4 ACCESSORIES OF DEVICE (EUT)	8
2.5 TESTED SUPPORTING SYSTEM DETAILS	8
2.6 TEST CONDITIONS	8
2.7 MEASUREMENT UNCERTAINTY	9
3 TEST INSTRUMENTS LIST	10
4 SYSTEM TEST CONFIGURATION	11
4.1 TEST MODE	11
4.2 CONFIGURATION OF TESTED SYSTEM	11
4.3 CONDUCTED OUTPUT POWER	12
4.4 PEAK-TO-AVERAGE RATIO	13
4.5 OCCUPY BANDWIDTH	14
4.6 MODULATION CHARACTERISTIC	15
4.7 OUT OF BAND EMISSION AT ANTENNA TERMINALS	16
4.8 ERP, EIRP MEASUREMENT	17
4.9 FIELD STRENGTH OF SPURIOUS RADIATION MEASUREMENT	19
4.10 FREQUENCY STABILITY V.S. TEMPERATURE MEASUREMENT	43
4.11 FREQUENCY STABILITY V.S. VOLTAGE MEASUREMENT	44
4.12 TEST SETUP PHOTO	45

History of this test report

Original Report Issue Date: 2024.07.14

- No additional attachment
- Additional attachments were issued following record

Attachment No.	Issue Date	Description

1 TEST SUMMARY

Test Item	Section in CFR 47	Result
RF Exposure (SAR)	Part 1.1307 Part 2.1093	Pass*(Please refer to SAR Report)
RF Output Power	Part 2.1046 Part 22.913(a) Part 24.232(b) Part 27.50(b) Part 27.50(c) Part 27.50(d) Part 27.50(h) Part 90.635	Pass
Peak-To-Average Ratio	Part 2.1046 Part 22.913(d) Part 24.232 (d) Part 27.50(d)	Pass
Modulation Characteristics	Part 2.1047	N/A
99% & -26 dB Occupied Bandwidth	Part 2.1049 Part 22.917 Part 24.238 Part 27.53(a)	Pass
Spurious Emissions at Antenna Terminal	Part 2.1051 Part 22.917 Part 24.238 Part 27.53(c)(f) Part 27.53(g) Part 27.53(h) Part 27.53(m) Part 90.691	Pass
Field Strength of Spurious Radiation	Part 2.1053 Part 22.917 Part 24.238 Part 27.53(c)(f) Part 27.53(g) Part 27.53(h) Part 27.53(m) Part 90.691	Pass

Out of band emission, Band Edge	Part 2.1051 Part 22.917 Part 24.238 Part 27.53(c)(f) Part 27.53(g) Part 27.53(h) Part 27.53(m) Part 90.691	Pass
Frequency stability vs. temperature	Part 2.1055(a)(1)(b) Part 22.355 Part 24.235 Part 27.54 Part 90.213	Pass
Frequency stability vs. voltage	Part 2.1055(d)(1)(2) Part 22.355 Part 24.235 Part 27.54 Part 90.213	Pass

Note: 1. Pass: The EUT complies with the essential requirements in the standard.

2. The conclusion of this test report is judged by actual test data without considering measurement uncertainty.

2 GENERAL INFORMATION

2.1 GENERAL DESCRIPTION OF EUT

Description of Device (EUT)

EUT Name : Smart Phone

Model No. : S200, S200 S, S200 SE, S200 E, S200 X, S200 Plus, S200 Ultra, S200 Max, S200 XS, S200 X Pro, S200 X Plus, S200 X Max, S200 Mini, S200 Note, S200 Air, S200 Lite

DIFF. : There is no difference except the name of the model. All tests are made with the S200 model.

Power supply : DC 3.87V from battery or DC 11V from adapter

Support Bands : LTE Band 2/4/5/7/19/25/26/38//41/66

Channel Bandwidth : LTE Band 2: 1.4MHz, 3MHz, 5MHz, 10MHz, 15MHz, 20MHz
 LTE Band 4: 1.4MHz, 3MHz, 5MHz, 10MHz, 15MHz, 20MHz
 LTE Band 5: 1.4MHz, 3MHz, 5MHz, 10MHz
 LTE Band 7: 5MHz, 10MHz, 15MHz, 20MHz
 LTE Band 19: 5MHz, 10MHz, 15MHz
 LTE Band 25: 1.4MHz, 3MHz, 5MHz, 10MHz, 15MHz, 20MHz
 LTE Band 26: 1.4MHz, 3MHz, 5MHz, 10MHz, 15MHz
 LTE Band 38: 5MHz, 10MHz, 15MHz, 20MHz
 LTE Band 41: 5MHz, 10MHz, 15MHz, 20MHz
 LTE Band 66: 1.4MHz, 3MHz, 5MHz, 10MHz, 15MHz, 20MHz

TX Frequency : LTE Band 2: 1850 ~ 1910 MHz
 LTE Band 4: 1710 ~ 1755 MHz
 LTE Band 5: 824 ~ 849 MHz
 LTE Band 7: 2500 ~2570 MHz
 LTE Band 19: 830 ~845MHz
 LTE Band 25: 1850 MHz ~ 1915 MHz
 LTE Band 26: 814 MHz ~ 849 MHz
 LTE Band 38: 2570 MHz ~ 2620 MHz
 LTE Band 41: 2535MHz ~ 2655MHz
 LTE Band 66: 1710 MHz ~ 1780 MHz

Modulation type : QPSK, 16QAM

Antenna Type : PIFA antenna,
 LTE Band 2: Maximum Gain is -1.17dBi.
 LTE Band 4: Maximum Gain is -0.42dBi.
 LTE Band 5: Maximum Gain is -0.77dBi.
 LTE Band 7: Maximum Gain is -1.67Bi.
 LTE Band 19: Maximum Gain is -0.77dBi.
 LTE Band 25: Maximum Gain is 1.17dBi.
 LTE Band 26: Maximum Gain is -0.77dBi.
 LTE Band 38: Maximum Gain is -1.67dBi.
 LTE Band 41: Maximum Gain is -1.67dBi.
 LTE Band 66: Maximum Gain is -0.42dBi.
 Antenna information is provided by applicant.
 There is WWAN diversity antenna inside the product, which is only for receiving function.

Software version : DOOGEE-S200-Android14.0-20240614_20240614-1857

Hardware version : M162-MUB-V2

Remark 1: The worst-case simultaneous transmission configuration was evaluated with no non-compliance found. Results in this report are only for 4G function, and there is no other transmitter involved.

2: The LTE Band41 supports frequency is 2535-2655MHz, Due to actual customer needs

Using software, the prototype can only operate at 2535-2655 MHZ, other frequencies have been blocked

2.2 RELATED SUBMITTAL(S) / GRANT (S)

This submittal(s) (test report) is filing to comply with Section Part 22 subpart H and Part 24 subpart E of the FCC CFR 47 Rules.

2.3 TEST FACILITY

Company:	Beijing TIRT Technology Service Co.,Ltd Shenzhen
Address:	104 Building C, Xinmingsheng Industrial Park No.132, Zhangge Old Village East Zone, Zhangge Community, Fucheng Street, Longhua District, Shenzhen, Guangdong, P. R. China
CNAS Registration Number:	CNAS L14158
A2LA Registration Number:	6049.01
FCC Accredited Lab.Designation Number:	CN1366
FCC Test Firm Registration Number:	820690
Telephone:	+86-0755-27087573

2.4 ACCESSORIES OF DEVICE (EUT)

Accessories : AC Adapter

Manufacturer : /

Model : TP303C-US

Input: AC100-240V~ 50/60Hz 0.7A Max

Ratings : Output USB-C: 5.0V=3.0A 15.0W; 9.0V=3.0A 27.0W, 12.0V=2.5A 30.0W;
15.0V=2.0A 30.0W; 20.0V=1.5A 30.0W

PPS: 5.0V-11.0V=3.0A 33.0W

Power: 33.0W Max

2.5 TESTED SUPPORTING SYSTEM DETAILS

No.	Description	Manufacturer	Model	Serial Number	Certification or SDoC
1	N/A	N/A	N/A	N/A	N/A

2.6 TEST CONDITIONS

Items	Required	Actual
Temperature range:	15-35°C	24°C
Humidity range:	25-75%	56%
Pressure range:	86-106kPa	98kPa

2.7 MEASUREMENT UNCERTAINTY

Uncertainty	
Parameter	Uncertainty
Occupied Channel Bandwidth	± 142.12 KHz
RF power conducted	± 0.74 dB
RF power radiated	± 3.25 dB
Spurious emissions, conducted	± 1.78 dB
Spurious emissions, radiated (9KHz~30MHz)	± 2.56 dB
Spurious emissions, radiated (30MHz~1GHz)	± 4.6 dB
Spurious emissions, radiated (Above 1GHz)	± 4.9 dB
Conduction Emissions(150kHz~30MHz)	± 3.1 dB
Humidity	$\pm 4.6\%$
Temperature	$\pm 0.7^{\circ}\text{C}$
Time	$\pm 1.25\%$

3 TEST INSTRUMENTS LIST

Name of Equipment	Manufacturer	Model Number	Serial Number	Last Calibration	Due Calibration
EMI Receiver	Rohde&Schwarz	ESIB 40	YH-TIRT-SAC-966 -20220911	2024/01/05	2025/01/04
Integral Antenna	Schwarzbeck	VULB 9163	01314	2022.12.11	2024.12.10
Integral Antenna	Rohde&Schwarz	HF907	RSM2991424	2022.12.11	2024.12.10
Preamplifier	Emtrace	RP01A	'02017	2024/01/05	2025/01/04
Preamplifier	Schwarzbeck	BBV9744	00143	2024/01/05	2025/01/04
Loop Antenna	ZHINAN	ZN30900A	12024	2024/01/05	2025/01/04
Exposure Level Tester	narda	ELT-400	N-0925	2024/01/05	2025/01/04
Horn Antenna	Schwarzbeck	BBHA9170	00956	2024/01/05	2025/01/04
RF Cable	/	LMR400UF-NMNM-7. 0M	/	2024/01/05	2025/01/04
RF Cable	/	SFT2050PUR-NMNM -7.0M	/	2024/01/05	2025/01/04
EMI Receiver	Rohde&Schwarz	ESR7	1316.3003K07-10 2611-mk	2023/11/02	2024/11/01
LISN	Rohde&Schwarz	ENV216	3560.655.12-1029 15-Bp	2023/11/02	2024/11/01
ISN	Schwarzbeck	ENY81	1309.8510.03	2024/01/05	2025/01/04
ISN	Schwarzbeck	ENY81-CAT6	1309.8526.03-101 976-kh	2024/01/05	2025/01/04
RF Cable	\	SFT2050PUR-NMNM -2.0M	\	2024/01/05	2025/01/04
CMW500	ROHDE&SCHWARZ	CMW500	120434	2024/01/05	2025/01/04
Spectrum analyzer	ROHDE&SCHWARZ	FSU26	200732	2024/01/05	2025/01/04
Spectrum analyzer	ROHDE&SCHWARZ	FSV40-N	101722	2024/01/05	2025/01/04
vector Signal Generator	KEYSIGHT	N5182B	MY56200458	2024/01/05	2025/01/04
vector Signal Generator	HEWLETT PACKARD	83752A	3610A02458	2024/01/05	2025/01/04
Filter	HEWLETT PACKARD	JS0806-F	19K8060209	2024/01/05	2025/01/04
Wireless comprehensive tester	ANRISTU	MT8821C	SN6262170409	2024/01/05	2025/01/04
Wireless comprehensive tester	ANRISTU	MT8000A	SN6262166782	2024/01/05	2025/01/04

ROB ANT	Hubei world for communication Co., LTD	SW-700/2700XP-4	/	/	/
---------	--	-----------------	---	---	---

4 SYSTEM TEST CONFIGURATION

4.1 TEST MODE

During all testing, EUT is in link mode with base station emulator at maximum power level. The spurious emission measurements were carried out in semi-anechoic chamber with 3-meter test range, and EUT is rotated on three test planes to find out the worst emission.

Test modes		
Band	Radiated	Conducted
LTE Band 2	■ QPSK link, 16QAM link	■ QPSK link, 16QAM link
LTE Band 4	■ QPSK link, 16QAM link	■ QPSK link, 16QAM link
LTE Band 5	■ QPSK link, 16QAM link	■ QPSK link, 16QAM link
LTE Band 7	■ QPSK link, 16QAM link	■ QPSK link, 16QAM link
LTE Band 19	■ QPSK link, 16QAM link	■ QPSK link, 16QAM link
LTE Band 25	■ QPSK link, 16QAM link	■ QPSK link, 16QAM link
LTE Band 26	■ QPSK link, 16QAM link	■ QPSK link, 16QAM link
LTE Band 38	■ QPSK link, 16QAM link	■ QPSK link, 16QAM link
LTE Band 41	■ QPSK link, 16QAM link	■ QPSK link, 16QAM link
LTE Band 66	■ QPSK link, 16QAM link	■ QPSK link, 16QAM link

Note: Antenna port conducted and radiated test items were performed according to KDB 971168 D01 Power Meas License Digital Systems v03r1 with maximum output power.

Radiated measurements were performed with rotating EUT in different three orthogonal test planes to find the maximum emission.

4.2 CONFIGURATION OF TESTED SYSTEM

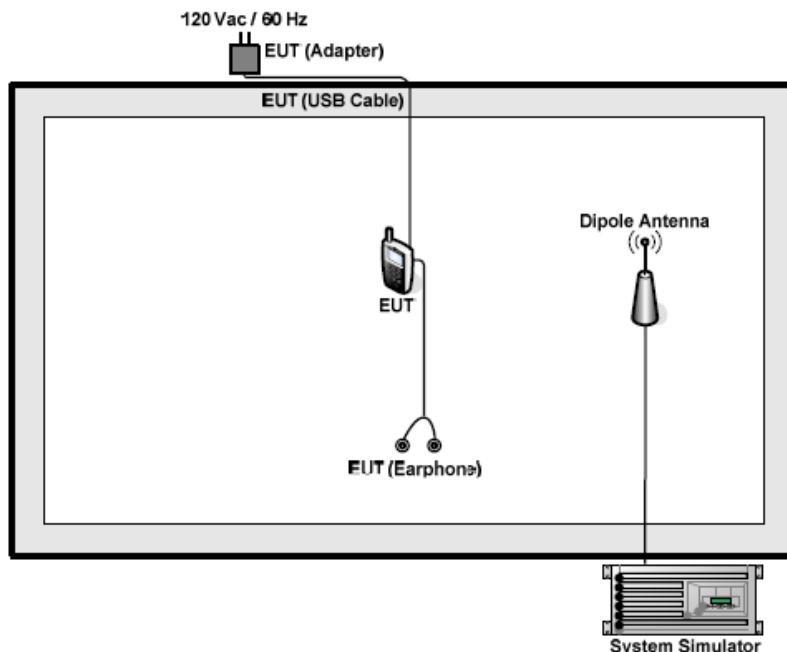

4.3 CONDUCTED OUTPUT POWER

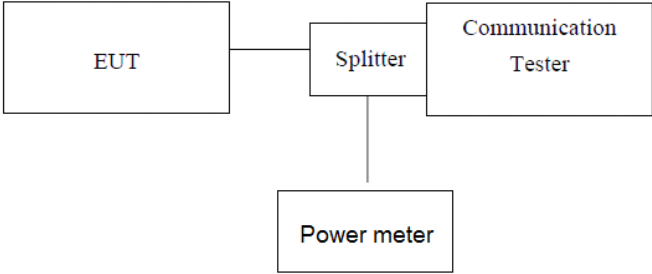
Test Requirement:	Part 2.1046, Part 22.913(a), Part 24.232(c), Part 27.50(b), Part 27.50(c), Part 27.50(d), Part 27.50(h), Part 90.635
Test Method:	ANSI C63.26:2015
Limit:	LTE Band 2: 2W LTE Band 4: 1W LTE Band 5/19: 7W LTE Band 7: 2W LTE Band 25: 2W LTE Band 26: 100W LTE Band 38: 2W LTE Band 41: 2W LTE Band 66: 1W
Test setup:	 <p style="text-align: center;"><i>Note: Measurement setup for testing on Antenna connector</i></p>
Test Procedure:	<ol style="list-style-type: none"> 1. The transmitter output port was connected to base station. 2. The RF output of EUT was connected to the power meter by RF cable and attenuator, the path loss was compensated to the results for each measurement. 3. Set EUT at maximum power through base station. 4. Select lowest, middle, and highest channels for each band and different modulation. 5. Measure the maximum burst average power.
Test Instruments:	Refer to section 3 for details
Test mode:	Refer to section 4.1 for details
Test results:	Pass

Note: Please refer to Appendix A of the Appendix Test Data.

4.4 PEAK-TO-AVERAGE RATIO

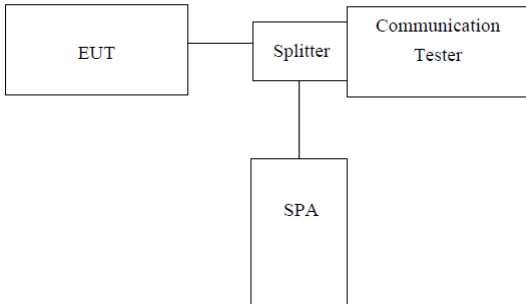
Test Requirement:	Part 22.913(d), FCC part24.232(d) and FCC part27.50(d)(5)
Test Method:	ANSI C63.26:2015
Test Limit:	Used complementary cumulative distribution function (CCDF) of analyzer to determine that PAPR will not exceed 13 dB for more than 0.1 percent of the time
Test setup:	 <p style="text-align: center;"><i>Note: Measurement setup for testing on Antenna connector</i></p>
Test Procedure:	<ol style="list-style-type: none"> 1. The testing follows FCC KDB 971168 D01 v03r01 Section 5.7 2. The EUT was connected to spectrum and system simulator via a power divider 3. Using the CCDF measurement of spectrum analyzer; 4. Set $RBW \geq OBW$ or specified reference bandwidth; 5. Set the number of counts to a value that stabilizes the measured CCDF curve; 6. Set the measurement interval as 1ms 7. Record the maximum PAPR level associated with a probability of 0.1%.
Test Instruments:	Refer to section 3 for details
Test mode:	Refer to section 4.1 for details
Test results:	Pass

Note: Please refer to Appendix B of the Appendix Test Data.

4.5 OCCUPY BANDWIDTH

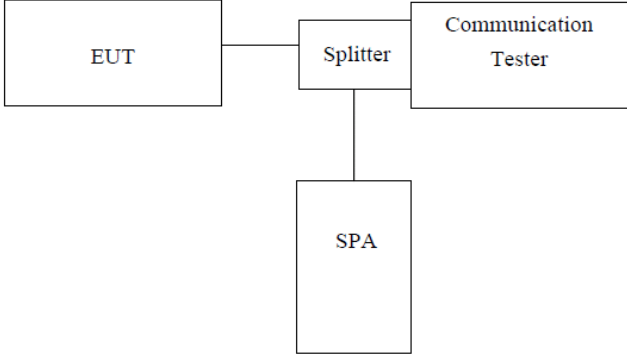
Test Requirement:	FCC part22.913(a), FCC part24.232(b) and FCC part27.53(a), FCC part 90.209
Test Method:	ANSI C63.26:2015
Test setup:	 <p><i>Note: Measurement setup for testing on Antenna connector</i></p>
Test Procedure:	<ol style="list-style-type: none"> 1.The EUT’s output RF connector was connected with a short cable to the spectrum analyzer, set center frequency to channel center frequency. 2.RBW was set to about 1%-5% of emission OBW, VBW\geq 3 X RBW. 3.Set spectrum analyzer detection mode to peak, and the trace mode to max hold. 4. Use the 99% OBW function, The 99% power OBW can be found on the plot, determine the “-26dB amplitude” as equal to reference value -26dB.
Test Instruments:	Refer to section 3 for details
Test mode:	Refer to section 4.1 for details
Test results:	Pass

Note: Please refer to Appendix C of the Appendix Test Data.

4.6 MODULATION CHARACTERISTIC

According to FCC § 2.1047(d), Part 24E & Part 27 there is no specific requirement for digital modulation, therefore modulation characteristic is not presented.

4.7 OUT OF BAND EMISSION AT ANTENNA TERMINALS

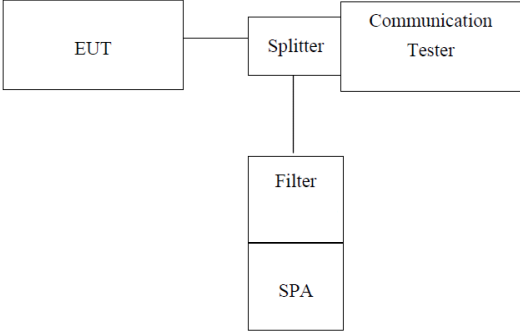
Test Requirement:	Part 2.1051 Part 22.917 Part 24.238 Part 27.53(c)(f) Part 27.53(g) Part 27.53(h) Part 27.53(m) Part 90.691
Test Method:	ANSI C63.26:2015
Limit:	≤ -13dBm(LTE Band5,19, 26(824-849MHz)) ≤ -13dBm(LTE Band2,25) ≤ -13dBm(LTE Band4,66) ≤ -25dBm(LTE Band 7, 38, 41) ≤ -13dBm(LTE Band26(814-824MHz))
Test setup:	 <p style="text-align: center;"><i>Note: Measurement setup for testing on Antenna connector</i></p>
Test Procedure:	<ol style="list-style-type: none"> 1 The RF output of the transceiver was connected to a spectrum analyzer through appropriate attenuation. 2 The resolution bandwidth of the spectrum analyzer was set at 1MHz, sufficient scans were taken to show the out of band Emissions if any up to 10th harmonic. 3 For the out of band: Set the RBW=1MHz, VBW = 3MHz, Start=30MHz, Stop= 10th harmonic. 4 Band Edge Requirements: In the 1 MHz bands immediately outside and adjacent to the frequency block, a resolution bandwidth of at least 1 percent of the emission bandwidth of the fundamental emission of the transmitter may be employed to measure the out of band Emissions.
Test Instruments:	Refer to section 3 for details
Test mode:	Refer to section 4.1 for details
Test results:	Pass

Note: Please refer to Appendix D of the Appendix Test Data.

4.8 ERP, EIRP MEASUREMENT

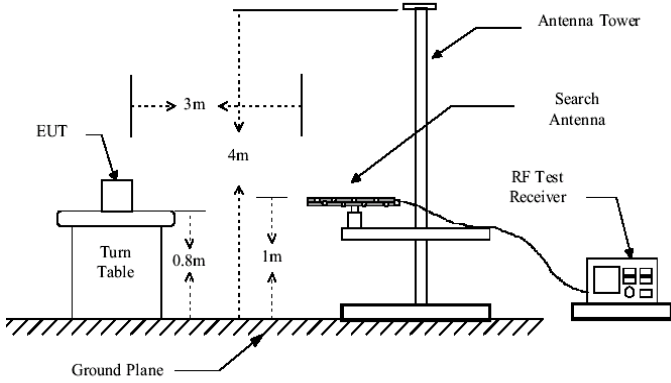
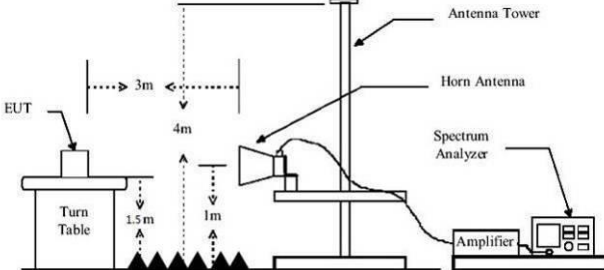
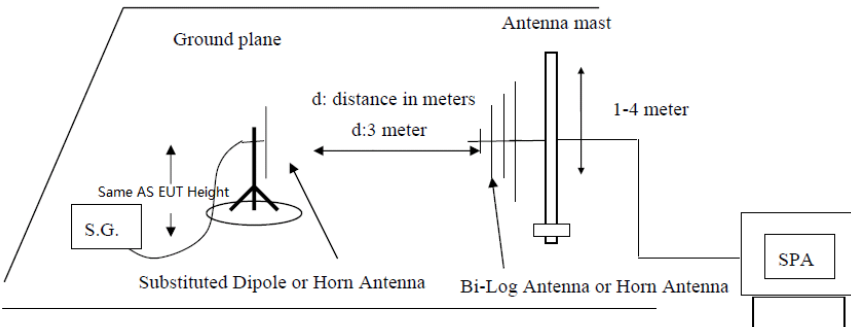
Test Requirement:	Part 2.1046, Part 22.913(a), Part 24.232(b), Part 27.50(b), Part 27.50(c), Part 27.50(d), Part 27.50(h), Part 90.635
Test Method:	ANSI C63.26:2015
Limit:	ERP ≤ 7W(38.45dBm) (LTE Band 5,19, 26(824-849MHz)) EIRP ≤ 2W(33.00dBm) (LTE Band 2,25) EIRP ≤ 1W(30.00dBm) (LTE Band 4,66) EIRP ≤ 2W(33.00dBm) (LTE Band 7,38,41) ERP ≤ 100W(50.00dBm) (LTE Band 26(814-824MHz))
Test setup:	<p>Below 1GHz</p>  <p>Above 1GHz</p>  <p>Substituted method:</p> 

<p>Test Procedure:</p>	<ol style="list-style-type: none"> 1. The EUT was placed on an non-conductive turntable using a non-conductive support. The radiated emission at the fundamental frequency was measured at 3 m with a test antenna and EMI spectrum analyzer. 2. During the measurement, the EUT was communication with the station. The highest emission was recorded with the rotation of the turntable and the lowering of the test antenna from 4m to 1m. The reading was recorded and the field strength (E in dBuV/m) was calculated. 3. ERP were measured using a substitution method. The EUT was replaced by dipole antenna connected, the S.G. output was recorded and ERP was calculated asfollows: $\text{ERP} = \text{S.G. output (dBm)} + \text{Antenna Gain (dBd)} - \text{Cable Loss (dB)}$ 4. EIRP were measured using a substitution method. The EUT was replaced by or horn antenna connected, the S.G. output was recorded and EIRP was calculated asfollows: $\text{EIRP} = \text{S.G. output (dBm)} + \text{Antenna Gain (dBi)} - \text{Cable Loss (dB)}$
<p>Test Instruments:</p>	<p>Refer to section 3 for details</p>
<p>Test mode:</p>	<p>Refer to section 4.1 for details</p>
<p>Test results:</p>	<p>Pass</p>
<p>Remark:</p>	<p>H,E1,E2 mean for EUT polarization of X, Y, Z</p>

Note: Please refer to Appendix A of the Appendix Test Data.

4.9 FIELD STRENGTH OF SPURIOUS RADIATION MEASUREMENT

Test Requirement:	Part 2.1053 Part 22.917 Part 24.238 Part 27.53(c)(f) Part 27.53(g) Part 27.53(h) Part 27.53(m) Part 90.691
Test Method:	ANSI C63.26:2015
Limit:	$\leq -13\text{dBm}$ (LTE Band 5, 19, 26(824-849MHz)) $\leq -13\text{dBm}$ (LTE Band 2,25) $\leq -13\text{dBm}$ (LTE Band 4,66) $\leq -25\text{dBm}$ (LTE Band 7, 38, 41) $\leq -13\text{dBm}$ (LTE Band 26(814-824MHz))
Test setup:	<p>Below 1GHz</p> <p>Above 1GHz</p> <p>Substituted method:</p>

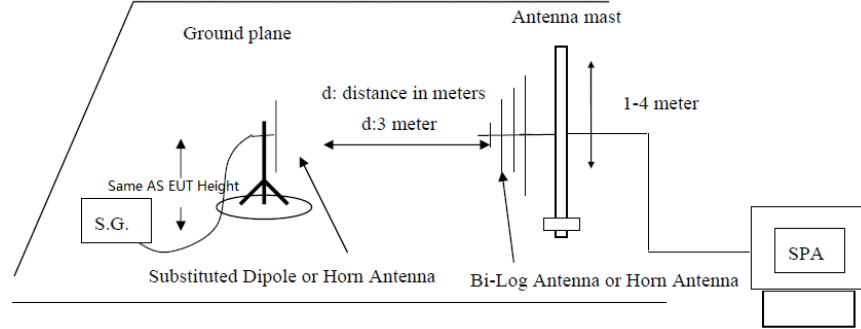
Test Procedure:

1. The EUT was placed on a non-conductive turntable using a non-conductive support. The radiated emission at the fundamental frequency was measured at 3 m with a test antenna and EMI spectrum analyzer.
2. During the tests, the antenna height and the EUT azimuth were varied in order to identify the maximum level of emissions from the EUT. This maximization process was repeated with the EUT positioned in each of its three orthogonal orientations.
3. The frequency range up to tenth harmonic was investigated for each of three fundamental frequency (low, middle and high channels). Once spurious emission was identified, the power of the emission was determined using the substitution method.
4. The spurious emissions attenuation was calculated as the difference between radiated power at the fundamental frequency and the spurious emissions frequency.

$$\text{ERP / EIRP} = \text{S.G. output (dBm)} + \text{Antenna Gain (dB/dBi)} - \text{Cable Loss (dB)}$$

Test Instruments:

Refer to section 3 for details

Test mode:

Refer to section 4.1 for details

Test results:

Pass

Measurement Data:

QPSK Mode:

Test mode:		LTE Band 2(1.4MHz)		Test channel:	Lowest
Frequency (MHz)	Spurious Emission		Limit (dBm)	Result	
	Polarization	Level (dBm)			
3731.25	Vertical	-31.73	-13.00	Pass	
5599.09	V	-31.71			
7429.75	V	-31.09			
9284.59	V	-42.96			
11256.65	V	---			
3732.31	Horizontal	-33.09	-13.00	Pass	
5524.72	H	-32.10			
7406.15	H	-37.65			
9245.19	H	-42.34			
11233.83	H	---			
Test mode:		LTE Band 2(1.4MHz)		Test channel:	Middle
Frequency (MHz)	Spurious Emission		Limit (dBm)	Result	
	Polarization	Level (dBm)			
3731.24	Vertical	-31.00	-13.00	Pass	
5641.56	V	-31.71			
7507.62	V	-33.17			
9485.08	V	-44.34			
11408.46	V	---			
3716.55	Horizontal	-32.86	-13.00	Pass	
5673.42	H	-32.16			
7531.68	H	-39.72			
9426.35	H	-39.31			
11329.93	H	---			
Test mode:		LTE Band 2(1.4MHz)		Test channel:	Highest
Frequency (MHz)	Spurious Emission		Limit (dBm)	Result	
	Polarization	Level (dBm)			
3832.78	Vertical	-31.73	-13.00	Pass	
5744.07	V	-32.23			
7649.32	V	-33.90			
9520.54	V	-44.34			
11606.66	V	---			
3833.84	Horizontal	-32.80	-13.00	Pass	
5746.72	H	-32.10			
7625.12	H	-38.65			
9578.13	H	-41.71			
11531.63	H	---			

Remark :

1. The emission behaviour belongs to narrowband spurious emission,all modes investigated and only worst case is reported.
2. Remark"---" means that the emission level is too low (20dB lower than the limit) to be measured
3. The emission levels of below 1 GHz are very lower (20dB lower than the limit) than the limit and not show in test report.

Test mode:		LTE Band 4(1.4MHz)		Test channel:	Lowest
Frequency (MHz)	Spurious Emission		Limit (dBm)	Result	
	Polarization	Level (dBm)			
3428.25	Vertical	-32.76	-13.00	Pass	
5145.53	V	-29.12			
6871.62	V	-33.80			
8541.21	V	-45.23			
10329.62	V	---			
3428.73	Horizontal	-31.55	-13.00	Pass	
5131.09	H	-40.07			
6869.72	H	-37.42			
8604.81	H	-34.97			
10244.51	H	---			
Test mode:		LTE Band 4(1.4MHz)		Test channel:	Middle
Frequency (MHz)	Spurious Emission		Limit (dBm)	Result	
	Polarization	Level (dBm)			
3442.48	Vertical	-31.76	-13.00	Pass	
5141.09	V	-31.17			
6979.60	V	-35.19			
8666.79	V	-44.27			
10475.42	V	---			
3471.56	Horizontal	-32.90	-13.00	Pass	
5118.73	H	-39.21			
6964.78	H	-37.67			
8716.44	H	-35.91			
10319.32	H	---			
Test mode:		LTE Band 4(1.4MHz)		Test channel:	Highest
Frequency (MHz)	Spurious Emission		Limit (dBm)	Result	
	Polarization	Level (dBm)			
3515.38	Vertical	-31.24	-13.00	Pass	
5223.22	V	-29.17			
7031.74	V	-32.23			
8770.48	V	-44.50			
10666.52	V	---			
3544.97	Horizontal	-32.50	-13.00	Pass	
5251.63	H	-39.01			
7059.94	H	-36.96			
8822.48	H	-37.66			
10547.01	H	---			

Remark:

1. The emission behaviour belongs to narrowband spurious emission, all modes investigated and only worst case is reported.
2. Remark"---" means that the emission level is too low (20dB lower than the limit) to be measured
3. The emission levels of below 1 GHz are very lower (20dB lower than the limit) than the limit and not show in test report.

Test mode:		LTE Band 5(1.4MHz)		Test channel:	Lowest
Frequency (MHz)	Spurious Emission		Limit (dBm)	Result	
	Polarization	Level (dBm)			
1614.65	Vertical	-33.00	-13.00	Pass	
2445.71	V	-33.35			
3224.28	V	-33.70			
4143.72	V	-44.34			
5073.35	V	---			
1811.69	Horizontal	-31.60	-13.00	Pass	
2504.15	H	-40.27			
3885.25	H	-36.13			
4312.17	H	-33.92			
5147.64	H	---			
Test mode:		LTE Band 5(1.4MHz)		Test channel:	Middle
Frequency (MHz)	Spurious Emission		Limit (dBm)	Result	
	Polarization	Level (dBm)			
1638.25	Vertical	-31.75	-13.00	Pass	
2422.07	V	-30.15			
3251.66	V	-32.86			
4287.72	V	-44.43			
5159.61	V	---			
4749.99	Horizontal	-31.75	-13.00	Pass	
2667.16	H	-38.62			
3856.37	H	-36.48			
4425.43	H	-36.17			
5147.64	H	---			
Test mode:		LTE Band 5(1.4MHz)		Test channel:	Highest
Frequency (MHz)	Spurious Emission		Limit (dBm)	Result	
	Polarization	Level (dBm)			
1703.22	Vertical	-34.76	-13.00	Pass	
2561.16	V	-33.15			
3420.08	V	-32.79			
4369.78	V	-44.34			
5260.08	V	---			
1751.69	Horizontal	-32.60	-13.00	Pass	
2876.09	H	-39.28			
3440.28	H	-38.01			
4394.74	H	-36.83			
5147.62	H	---			

Remark :

1. The emission behaviour belongs to narrowband spurious emission,all modes investigated and only worst case is reported.
2. Remark"---" means that the emission level is too low (20dB lower than the limit) to be measured
3. The emission levels of below 1 GHz are very lower (20dB lower than the limit) than the limit and not show in test report.

Test mode:		LTE Band 7(5MHz)		Test channel:	Lowest
Frequency (MHz)	Spurious Emission		Limit (dBm)	Result	
	Polarization	Level (dBm)			
5228.95	Vertical	-31.65	-25.00	Pass	
4861.20	V	-29.86			
10094.75	V	-33.05			
13594.08	V	-44.96			
15233.61	V	---			
5138.46	Horizontal	-31.70	-25.00	Pass	
7945.32	H	-39.13			
10155.22	H	-36.29			
12812.37	H	-36.65			
15137.62	H	---			
Test mode:		LTE Band 7(5MHz)		Test channel:	Middle
Frequency (MHz)	Spurious Emission		Limit (dBm)	Result	
	Polarization	Level (dBm)			
5157.65	Vertical	-30.60	-25.00	Pass	
7640.74	V	-31.83			
10224.74	V	-32.12			
13285.20	V	-44.98			
15636.95	V	---			
5130.78	Horizontal	-34.15	-25.00	Pass	
7738.63	H	-39.18			
10278.51	H	-35.92			
13877.90	H	-33.91			
15363.11	H	---			
Test mode:		LTE Band 7(5MHz)		Test channel:	Highest
Frequency (MHz)	Spurious Emission		Limit (dBm)	Result	
	Polarization	Level (dBm)			
5240.15	Vertical	-33.76	-25.00	Pass	
7884.13	V	-35.25			
10348.75	V	-31.76			
12924.08	V	-45.24			
15441.66	V	---			
5226.56	Horizontal	-32.46	-25.00	Pass	
7738.89	H	-39.05			
10357.85	H	-36.94			
12778.43	H	-36.78			
15363.52	H	---			

Remark :

1. The emission behaviour belongs to narrowband spurious emission,all modes investigated and only worst case is reported.
2. Remark"---" means that the emission level is too low (20dB lower than the limit) to be measured
3. The emission levels of below 1 GHz are very lower (20dB lower than the limit) than the limit and not show in test report.

Test mode:		LTE Band 19(5MHz)		Test channel:	Lowest
Frequency (MHz)	Spurious Emission		Limit (dBm)	Result	
	Polarization	Level (dBm)			
1362.25	Vertical	-31.73	-13.00	Pass	
2696.09	V	-34.86			
3350.59	V	-32.06			
4219.78	V	-42.93			
5064.58	V	---			
1407.33	Horizontal	-29.87	-13.00	Pass	
2504.60	H	-39.01			
3642.95	H	-33.48			
4328.43	H	-30.91			
5147.01	H	---			
Test mode:		LTE Band 19(5MHz)		Test channel:	Middle
Frequency (MHz)	Spurious Emission		Limit (dBm)	Result	
	Polarization	Level (dBm)			
1536.85	Vertical	-30.50	-13.00	Pass	
2648.70	V	-33.15			
3450.29	V	-33.10			
4321.23	V	-44.29			
5255.92	V	---			
4844.97	Horizontal	-29.67	-13.00	Pass	
2555.59	H	-35.58			
3955.72	H	-35.41			
4336.36	H	-35.22			
5364.62	H	---			
Test mode:		LTE Band 19(5MHz)		Test channel:	Highest
Frequency (MHz)	Spurious Emission		Limit (dBm)	Result	
	Polarization	Level (dBm)			
1526.38	Vertical	-35.77	-13.00	Pass	
2318.47	V	-32.12			
3586.22	V	-33.16			
4421.21	V	-43.49			
5404.62	V	---			
1744.96	Horizontal	-30.84	-13.00	Pass	
2867.70	H	-38.22			
3566.71	H	-36.22			
4412.18	H	-35.64			
5147.01	H	---			

Test mode:	LTE Band 25(5MHz)		Test channel:	Lowest
Frequency (MHz)	Spurious Emission		Limit (dBm)	Result
	Polarization	Level (dBm)		
5134.38	Vertical	-33.24	-13.00	Pass
7637.97	V	-31.31		
10124.80	V	-34.94		
12262.49	V	-41.30		
15330.47	V	---		
5048.99	Horizontal	-34.13	-13.00	Pass
7540.91	H	-36.05		
10559.25	H	-31.47		
12621.81	H	-33.51		
15241.25	H	---		
Test mode:	LTE Band 25(5MHz)		Test channel:	Middle
Frequency (MHz)	Spurious Emission		Limit (dBm)	Result
	Polarization	Level (dBm)		
5251.85	Vertical	-31.50	-13.00	Pass
7642.70	V	-29.22		
10226.22	V	-30.83		
12542.74	V	-42.23		
15513.98	V	---		
5220.26	Horizontal	-28.56	-13.00	Pass
7521.19	H	-32.07		
10266.72	H	-35.45		
13592.21	H	-35.64		
15318.81	H	---		
Test mode:	LTE Band 25(5MHz)		Test channel:	Highest
Frequency (MHz)	Spurious Emission		Limit (dBm)	Result
	Polarization	Level (dBm)		
5211.25	Vertical	-30.50	-13.00	Pass
7863.20	V	-32.08		
10012.36	V	-30.19		
12236.52	V	-44.34		
15504.62	V	---		
5307.20	Horizontal	-34.13	-13.00	Pass
7824.86	H	-38.62		
10404.22	H	-35.91		
12266.68	H	-34.08		
15326.75	H	---		

Remark :

- 1 The emission behaviour belongs to narrowband spurious emission,all modes investigated and only worst case is reported.
- 2 Remark"---" means that the emission level is too low (20dB lower than the limit) to be measured
- 3 The emission levels of below 1 GHz are very lower (20dB lower than the limit) than the limit and not show in test report.

Test mode(814-824MHz):		LTE Band 26(5MHz)		Test channel:	Lowest
Frequency (MHz)	Spurious Emission		Limit (dBm)	Result	
	Polarization	Level (dBm)			
3430.25	Vertical	-31.75	-13.00	Pass	
7818.80	V	-31.86			
10131.15	V	-30.05			
12316.48	V	-44.34			
16342.86	V	---			
5193.20	Horizontal	-27.94	-13.00	Pass	
7621.19	H	-39.15			
10263.35	H	-36.95			
12592.67	H	-34.15			
15219.02	H	---			
Test mode(814-824MHz):		LTE Band 26(5MHz)		Test channel:	Middle
Frequency (MHz)	Spurious Emission		Limit (dBm)	Result	
	Polarization	Level (dBm)			
5131.25	Vertical	-29.56	-13.00	Pass	
7643.60	V	-28.88			
10247.77	V	-31.60			
13279.23	V	-42.07			
15649.86	V	---			
5236.80	Horizontal	-28.89	-13.00	Pass	
7700.30	H	-33.12			
10284.98	H	-35.73			
12661.47	H	-35.19			
15268.26	H	---			
Test mode(814-824MHz):		LTE Band 26(5MHz)		Test channel:	Highest
Frequency (MHz)	Spurious Emission		Limit (dBm)	Result	
	Polarization	Level (dBm)			
5228.03	Vertical	-33.60	-13.00	Pass	
7827.18	V	-29.84			
10349.29	V	-33.89			
12869.19	V	-42.35			
15444.19	V	---			
5143.12	Horizontal	-31.95	-13.00	Pass	
7824.43	H	-37.85			
10343.94	H	-34.81			
12997.44	H	-35.47			
15270.25	H	---			

Remark :

- 1 The emission behaviour belongs to narrowband spurious emission,all modes investigated and only worst case is reported.
- 2 Remark"---" means that the emission level is too low (20dB lower than the limit) to be measured
- 3 The emission levels of below 1 GHz are very lower (20dB lower than the limit) than the limit and not show in test report.

Test mode(824-849MHz):		LTE Band 26(5MHz)		Test channel:	Lowest
Frequency (MHz)	Spurious Emission		Limit (dBm)	Result	
	Polarization	Level (dBm)			
3915.22	Vertical	-32.56	-13.00	Pass	
5703.26	V	-29.17			
10251.62	V	-30.78			
12295.08	V	-44.34			
13526.39	V	---			
3845.56	Horizontal	-34.45	-13.00	Pass	
7267.89	H	-36.85			
10306.85	H	-36.25			
12122.41	H	-36.64			
13343.08	H	---			
Test mode(824-849MHz):		LTE Band 26(5MHz)		Test channel:	Middle
Frequency (MHz)	Spurious Emission		Limit (dBm)	Result	
	Polarization	Level (dBm)			
3691.76	Vertical	-32.37	-13.00	Pass	
7910.08	V	-29.15			
10451.29	V	-30.76			
12033.29	V	-43.90			
15887.92	V	---			
3845.30	Horizontal	-31.61	-13.00	Pass	
7584.60	H	-39.02			
10487.11	H	-35.32			
12533.74	H	-35.76			
15336.12	H	---			
Test mode(824-849MHz):		LTE Band 26(5MHz)		Test channel:	Highest
Frequency (MHz)	Spurious Emission		Limit (dBm)	Result	
	Polarization	Level (dBm)			
3865.85	Vertical	-29.44	-13.00	Pass	
7830.97	V	-26.11			
10451.62	V	-32.93			
12341.21	V	-44.34			
15617.59	V	---			
3903.96	Horizontal	-29.71	-13.00	Pass	
7838.63	H	-36.08			
10457.78	H	-36.25			
12384.01	H	-36.75			
15287.35	H	---			

Remark :

- 1 The emission behaviour belongs to narrowband spurious emission,all modes investigated and only worst case is reported.
- 2 Remark"---" means that the emission level is too low (20dB lower than the limit) to be measured
- 3 The emission levels of below 1 GHz are very lower (20dB lower than the limit) than the limit and not show in test report.

Test mode		LTE Band 38(5MHz)		Test channel:	Lowest
Frequency (MHz)	Spurious Emission		Limit (dBm)	Result	
	Polarization	Level (dBm)			
2628.76	Vertical	-31.71	-25.00	Pass	
5255.96	V	-31.94			
10564.44	V	-31.30			
12217.02	V	-44.21			
13697.26	V	---			
2642.59	Horizontal	-33.92	-25.00	Pass	
5232.81	H	-38.80			
10852.39	H	-37.84			
12304.19	H	-37.64			
13263.88	H	---			
Test mode		LTE Band 38(5MHz)		Test channel:	Middle
Frequency (MHz)	Spurious Emission		Limit (dBm)	Result	
	Polarization	Level (dBm)			
2758.57	Vertical	-29.51	-25.00	Pass	
5484.17	V	-33.60			
10639.19	V	-31.79			
12866.63	V	-46.19			
15709.40	V	---			
2687.59	Horizontal	-33.65	-25.00	Pass	
5436.34	H	-37.59			
10840.43	H	-37.30			
12309.39	H	-36.62			
15330.53	H	---			
Test mode		LTE Band 38(5MHz)		Test channel:	Highest
Frequency (MHz)	Spurious Emission		Limit (dBm)	Result	
	Polarization	Level (dBm)			
2626.38	Vertical	-30.98	-25.00	Pass	
6894.18	V	-33.23			
10439.23	V	-31.27			
12726.50	V	-44.05			
15637.77	V	---			
2689.19	Horizontal	-28.92	-25.00	Pass	
5192.01	H	-37.61			
10761.32	H	-37.30			
13307.28	H	-37.00			
16260.15	H	---			

Remark :

- 1 The emission behaviour belongs to narrowband spurious emission,all modes investigated and only worst case is reported.
- 2 Remark"---" means that the emission level is too low (20dB lower than the limit) to be measured
- 3 The emission levels of below 1 GHz are very lower (20dB lower than the limit) than the limit and not show in test report.

Test mode		LTE Band 41(5MHz)		Test channel:	Lowest
Frequency (MHz)	Spurious Emission		Limit (dBm)	Result	
	Polarization	Level (dBm)			
3675.67	Vertical	-28.92	-25.00	Pass	
8633.86	V	-33.33			
10232.24	V	-34.30			
12662.00	V	-44.40			
13374.86	V	---			
3991.18	Horizontal	-32.37	-25.00	Pass	
9810.74	H	-39.54			
10273.23	H	-37.61			
12317.39	H	-35.31			
13164.06	H	---			
Test mode		LTE Band 41(5MHz)		Test channel:	Middle
Frequency (MHz)	Spurious Emission		Limit (dBm)	Result	
	Polarization	Level (dBm)			
3577.41	Vertical	-31.73	-25.00	Pass	
5975.86	V	-32.99			
8944.13	V	-33.31			
10238.50	V	-44.24			
13802.11	V	---			
5869.68	Horizontal	-30.40	-25.00	Pass	
7235.61	H	-41.73			
10341.50	H	-35.32			
12304.80	H	-27.05			
13261.66	H	---			
Test mode		LTE Band 41(5MHz)		Test channel:	Highest
Frequency (MHz)	Spurious Emission		Limit (dBm)	Result	
	Polarization	Level (dBm)			
3115.86	Vertical	-34.09	-25.00	Pass	
5636.98	V	-33.72			
8943.13	V	-34.29			
10362.00	V	-44.34			
12876.10	V	---			
5131.73	Horizontal	-33.34	-25.00	Pass	
8675.25	H	-39.12			
10302.42	H	-36.25			
12710.19	H	-36.75			
13591.73	H	---			

Remark :

- 1 The emission behaviour belongs to narrowband spurious emission,all modes investigated and only worst case is reported.
- 2 Remark"---" means that the emission level is too low (20dB lower than the limit) to be measured
- 3 The emission levels of below 1 GHz are very lower (20dB lower than the limit) than the limit and not show in test report.

Test mode:	LTE Band 66(1.4MHz)		Test channel:	Lowest
Frequency (MHz)	Spurious Emission		Limit (dBm)	Result
	Polarization	Level (dBm)		
3316.07	Vertical	-31.74	-13.00	Pass
5688.71	V	-33.46		
7306.21	V	-32.60		
8299.69	V	-45.09		
10441.60	V	---		
3334.61	Horizontal	-33.65	-13.00	Pass
5230.74	H	-39.41		
6951.23	H	-37.91		
8916.28	H	-37.46		
10269.53	H	---		
Test mode:	LTE Band 66(1.4MHz)		Test channel:	Middle
Frequency (MHz)	Spurious Emission		Limit (dBm)	Result
	Polarization	Level (dBm)		
2886.86	Vertical	-36.21	-13.00	Pass
5370.54	V	-35.07		
7517.13	V	-35.55		
9866.50	V	-45.45		
10368.50	V	---		
3021.68	Horizontal	-33.65	-13.00	Pass
5235.59	H	-38.83		
7651.96	H	-37.36		
8885.82	H	-36.20		
10400.52	H	---		
Test mode:	LTE Band 66(1.4MHz)		Test channel:	Highest
Frequency (MHz)	Spurious Emission		Limit (dBm)	Result
	Polarization	Level (dBm)		
3749.16	Vertical	-32.32	-13.00	Pass
5314.11	V	-28.20		
7234.06	V	-33.91		
8632.03	V	-47.32		
10574.56	V	---		
3335.47	Horizontal	-33.65	-13.00	Pass
5292.23	H	-41.27		
7328.83	H	-38.23		
8879.38	H	-37.35		
10127.98	H	---		

Remark :

- 1 The emission behaviour belongs to narrowband spurious emission,all modes investigated and only worst case is reported.
- 2 Remark"---" means that the emission level is too low (20dB lower than the limit) to be measured
- 3 The emission levels of below 1 GHz are very lower (20dB lower than the limit) than the limit and not show in test report.

The emission behaviour belongs to narrowband spurious emission,all modes investigated and only worst

16 QAM Mode:

Test mode:		LTE Band 2 (1.4MHz)		Test channel:	Lowest
Frequency (MHz)	Spurious Emission		Limit (dBm)	Result	
	Polarization	Level (dBm)			
3532.70	Vertical	-33.43	-13.00	Pass	
5714.09	V	-39.83			
8612.39	V	-32.75			
9731.04	V	-46.32			
11404.45	V	---			
3651.48	Horizontal	-33.22	-13.00	Pass	
5558.12	H	-36.32			
7725.71	H	-41.13			
9384.56	H	-39.43			
12395.33	H	---			
Test mode:		LTE Band 2 (1.4MHz)		Test channel:	Middle
Frequency (MHz)	Spurious Emission		Limit (dBm)	Result	
	Polarization	Level (dBm)			
3870.34	Vertical	-33.96	-13.00	Pass	
5850.90	V	-40.06			
7913.70	V	-32.02			
9390.64	V	-46.65			
12164.80	V	---			
3354.95	Horizontal	-37.21	-13.00	Pass	
5547.01	H	-38.24			
7958.68	H	-41.26			
9908.83	H	-41.16			
11343.40	H	---			
Test mode:		LTE Band 2 (1.4MHz)		Test channel:	Highest
Frequency (MHz)	Spurious Emission		Limit (dBm)	Result	
	Polarization	Level (dBm)			
2898.13	Vertical	-33.73	-13.00	Pass	
5651.03	V	-42.79			
7842.15	V	-34.75			
9309.11	V	-41.92			
12193.10	V	---			
3789.97	Horizontal	-37.21	-13.00	Pass	
5667.28	H	-37.99			
7558.04	H	-40.51			
9502.30	H	-39.48			
11486.92	H	---			

Remark :

- 1 The emission behaviour belongs to narrowband spurious emission,all modes investigated and only worst case is reported.
- 2 Remark"---" means that the emission level is too low (20dB lower than the limit) to be measured
- 3 The emission levels of below 1 GHz are very lower (20dB lower than the limit) than the limit and not show in test report.

Test mode:		LTE Band 4(1.4MHz)		Test channel:	Lowest
Frequency (MHz)	Spurious Emission		Limit (dBm)	Result	
	Polarization	Level (dBm)			
3416.50	Vertical	-33.50	-13.00	Pass	
5274.32	V	-41.10			
6305.20	V	-30.02			
8715.64	V	-49.38			
11294.50	V	---			
3352.27	Horizontal	-34.97	-13.00	Pass	
4932.12	H	-37.32			
7716.21	H	-41.20			
9646.96	H	-41.18			
10416.86	H	---			
Test mode:		LTE Band 4(1.4MHz)		Test channel:	Middle
Frequency (MHz)	Spurious Emission		Limit (dBm)	Result	
	Polarization	Level (dBm)			
3290.90	Vertical	-38.04	-13.00	Pass	
5274.63	V	-40.52			
7310.23	V	-33.64			
8993.58	V	-46.32			
10296.37	V	---			
3385.69	Horizontal	-37.10	-13.00	Pass	
5226.53	H	-35.92			
6896.24	H	-41.13			
9344.29	H	-38.33			
10456.84	H	---			
Test mode:		LTE Band 4(1.4MHz)		Test channel:	Highest
Frequency (MHz)	Spurious Emission		Limit (dBm)	Result	
	Polarization	Level (dBm)			
3235.87	Vertical	-35.83	-13.00	Pass	
5145.62	V	-41.80			
8613.04	V	-30.74			
9569.08	V	-48.65			
11305.97	V	---			
3539.23	Horizontal	-35.64	-13.00	Pass	
5337.62	H	-37.27			
7283.67	H	-41.20			
8952.28	H	-37.59			
10359.86	H	---			

Remark:

- 1 The emission behaviour belongs to narrowband spurious emission,all modes investigated and only worst case is reported.
- 2 Remark"---" means that the emission level is too low (20dB lower than the limit) to be measured
- 3 The emission levels of below 1 GHz are very lower (20dB lower than the limit) than the limit and not show in test report.

Test mode:		LTE Band 5(1.4MHz)		Test channel:	Lowest
Frequency (MHz)	Spurious Emission		Limit (dBm)	Result	
	Polarization	Level (dBm)			
1964.41	Vertical	-37.07	-13.00	Pass	
2536.09	V	-41.44			
3628.43	V	-36.14			
4267.07	V	-46.25			
5679.37	V	---			
1676.19	Horizontal	-35.34	-13.00	Pass	
2442.66	H	-38.17			
3326.05	H	-41.13			
4267.59	H	-40.43			
5079.86	H	---			
Test mode:		LTE Band 5(1.4MHz)		Test channel:	Middle
Frequency (MHz)	Spurious Emission		Limit (dBm)	Result	
	Polarization	Level (dBm)			
1684.41	Vertical	-35.80	-13.00	Pass	
2532.33	V	-39.33			
3439.48	V	-36.22			
4231.58	V	-47.18			
5164.10	V	---			
1588.46	Horizontal	-37.41	-13.00	Pass	
2281.66	H	-39.48			
3482.81	H	-41.51			
4199.07	H	-42.62			
5559.86	H	---			
Test mode:		LTE Band 5(1.4MHz)		Test channel:	Highest
Frequency (MHz)	Spurious Emission		Limit (dBm)	Result	
	Polarization	Level (dBm)			
1171.14	Vertical	-37.80	-13.00	Pass	
2378.90	V	-37.33			
3213.79	V	-30.75			
4258.25	V	-45.92			
5165.99	V	---			
1701.59	Horizontal	-32.57	-13.00	Pass	
2512.53	H	-30.23			
3425.21	H	-39.23			
4259.16	H	-37.72			
5120.97	H	---			

Remark :

- 1 The emission behaviour belongs to narrowband spurious emission,all modes investigated and only worst case is reported.
- 2 Remark"---" means that the emission level is too low (20dB lower than the limit) to be measured
- 3 The emission levels of below 1 GHz are very lower (20dB lower than the limit) than the limit and not show in test report.

Test mode:		LTE Band 19(5MHz)		Test channel:	Lowest
Frequency (MHz)	Spurious Emission		Limit (dBm)	Result	
	Polarization	Level (dBm)			
1977.06	Vertical	-35.80	-13.00	Pass	
2548.74	V	-40.17			
3641.08	V	-34.87			
4279.72	V	-44.98			
5692.02	V	---			
1688.84	Horizontal	-34.07	-13.00	Pass	
2455.31	H	-36.90			
3338.70	H	-39.86			
4280.24	H	-39.16			
5092.51	H	---			
Test mode:		LTE Band 19(5MHz)		Test channel:	Middle
Frequency (MHz)	Spurious Emission		Limit (dBm)	Result	
	Polarization	Level (dBm)			
1697.06	Vertical	-34.53	-13.00	Pass	
2544.98	V	-38.06			
3452.13	V	-34.95			
4244.23	V	-45.91			
5176.75	V	---			
1601.11	Horizontal	-36.14	-13.00	Pass	
2294.31	H	-38.21			
3495.46	H	-40.24			
4211.72	H	-41.35			
5572.51	H	---			
Test mode:		LTE Band19(5MHz)		Test channel:	Highest
Frequency (MHz)	Spurious Emission		Limit (dBm)	Result	
	Polarization	Level (dBm)			
1183.79	Vertical	-36.53	-13.00	Pass	
2391.55	V	-36.06			
3226.44	V	-29.48			
4270.90	V	-44.65			
5178.64	V	---			
1714.24	Horizontal	-31.30	-13.00	Pass	
2525.18	H	-28.96			
3437.86	H	-37.96			
4271.81	H	-36.45			
5133.62	H	---			

Remark :

- 4 The emission behaviour belongs to narrowband spurious emission,all modes investigated and only worst case is reported.
- 5 Remark"---" means that the emission level is too low (20dB lower than the limit) to be measured
- 6 The emission levels of below 1 GHz are very lower (20dB lower than the limit) than the limit and not show in test report.

Test mode:		LTE Band 7(5MHz)		Test channel:	Lowest
Frequency (MHz)	Spurious Emission		Limit (dBm)	Result	
	Polarization	Level (dBm)			
5151.54	Vertical	-32.22	-25.00	Pass	
7373.26	V	-39.97			
9046.42	V	-32.27			
12422.81	V	-44.96			
15423.85	V	---			
5177.07	Horizontal	-31.69	-25.00	Pass	
7322.16	H	-35.98			
9682.92	H	-39.26			
12496.96	H	-39.91			
15324.62	H	---			
Test mode:		LTE Band 7(5MHz)		Test channel:	Middle
Frequency (MHz)	Spurious Emission		Limit (dBm)	Result	
	Polarization	Level (dBm)			
5151.34	Vertical	-32.22	-25.00	Pass	
7734.04	V	-38.92			
10133.67	V	-36.50			
12716.84	V	-46.99			
15293.42	V	---			
5179.70	Horizontal	-37.32	-25.00	Pass	
7620.79	H	-39.30			
10310.90	H	-38.88			
12356.19	H	-39.34			
15384.71	H	---			
Test mode:		LTE Band 7(5MHz)		Test channel:	Highest
Frequency (MHz)	Spurious Emission		Limit (dBm)	Result	
	Polarization	Level (dBm)			
5054.34	Vertical	-34.32	-25.00	Pass	
7883.37	V	-40.11			
10320.80	V	-30.21			
13020.35	V	-45.56			
15696.73	V	---			
5180.69	Horizontal	-31.69	-25.00	Pass	
7826.41	H	-37.20			
10252.92	H	-42.09			
12903.93	H	-41.38			
15557.38	H	---			

Remark :

- 1 The emission behaviour belongs to narrowband spurious emission,all modes investigated and only worst case is reported.
- 2 Remark"---" means that the emission level is too low (20dB lower than the limit) to be measured
- 3 The emission levels of below 1 GHz are very lower (20dB lower than the limit) than the limit and not show in test report.

Test mode:		LTE Band 25(5MHz)		Test channel:	Lowest
Frequency (MHz)	Spurious Emission		Limit (dBm)	Result	
	Polarization	Level (dBm)			
5154.34	Vertical	-31.78	-13.00	Pass	
7404.26	V	-40.48			
10134.51	V	-32.49			
12296.81	V	-44.80			
13566.27	V	---			
5186.87	Horizontal	-35.96	-13.00	Pass	
7522.57	H	-37.21			
10177.41	H	-39.99			
12061.50	H	-38.18			
13584.17	H	---			
Test mode:		LTE Band 25(5MHz)		Test channel:	Middle
Frequency (MHz)	Spurious Emission		Limit (dBm)	Result	
	Polarization	Level (dBm)			
5051.88	Vertical	-32.22	-13.00	Pass	
7328.03	V	-35.81			
10034.51	V	-32.26			
12748.81	V	-45.29			
15518.24	V	---			
5099.93	Horizontal	-34.85	-13.00	Pass	
7624.80	H	-39.20			
10303.43	H	-37.37			
12062.03	H	-39.80			
15514.11	H	---			
Test mode:		LTE Band 25(5MHz)		Test channel:	Highest
Frequency (MHz)	Spurious Emission		Limit (dBm)	Result	
	Polarization	Level (dBm)			
5229.24	Vertical	-31.09	-13.00	Pass	
7772.64	V	-36.81			
10257.87	V	-34.50			
12769.08	V	-44.67			
15517.73	V	---			
5263.93	Horizontal	-34.95	-13.00	Pass	
7774.40	H	-36.11			
10325.06	H	-39.88			
12755.70	H	-39.18			
15579.50	H	---			

Remark :

- 4 The emission behaviour belongs to narrowband spurious emission,all modes investigated and only worst case is reported.
- 5 Remark"---" means that the emission level is too low (20dB lower than the limit) to be measured
- 6 The emission levels of below 1 GHz are very lower (20dB lower than the limit) than the limit and not show in test report.

Test mode(814-824MHz):		LTE Band 26(5MHz)		Test channel:	Lowest
Frequency (MHz)	Spurious Emission		Limit (dBm)	Result	
	Polarization	Level (dBm)			
3271.65	Vertical	-32.48	-13.00	Pass	
7290.13	V	-35.70			
10131.11	V	-27.93			
12509.81	V	-47.29			
15193.36	V	---			
3709.55	Horizontal	-34.95	-13.00	Pass	
7521.86	H	-36.60			
10141.00	H	-39.88			
12527.03	H	-39.20			
15184.14	H	---			
Test mode(814-824MHz):		LTE Band 26(5MHz)		Test channel:	Middle
Frequency (MHz)	Spurious Emission		Limit (dBm)	Result	
	Polarization	Level (dBm)			
5053.24	Vertical	-31.09	-13.00	Pass	
7673.82	V	-36.82			
10331.41	V	-32.26			
12744.86	V	-45.83			
15383.27	V	---			
5176.84	Horizontal	-35.00	-13.00	Pass	
7207.60	H	-37.30			
10306.45	H	-39.89			
12766.34	H	-39.91			
15381.11	H	---			
Test mode(814-824MHz):		LTE Band 26(5MHz)		Test channel:	Highest
Frequency (MHz)	Spurious Emission		Limit (dBm)	Result	
	Polarization	Level (dBm)			
5238.81	Vertical	-32.25	-13.00	Pass	
7773.73	V	-38.50			
10320.18	V	-31.70			
12911.09	V	-47.29			
15601.45	V	---			
5352.66	Horizontal	-34.96	-13.00	Pass	
7822.96	H	-37.20			
10210.10	H	-39.61			
12876.93	H	-40.11			
15385.65	H	---			

Remark :

- 4 The emission behaviour belongs to narrowband spurious emission,all modes investigated and only worst case is reported.
- 5 Remark"---" means that the emission level is too low (20dB lower than the limit) to be measured
- 6 The emission levels of below 1 GHz are very lower (20dB lower than the limit) than the limit and not show in test report.

Test mode(824-849MHz):		LTE Band 26(5MHz)		Test channel:	Lowest
Frequency (MHz)	Spurious Emission		Limit (dBm)	Result	
	Polarization	Level (dBm)			
3938.54	Vertical	-34.65	-13.00	Pass	
7681.10	V	-40.77			
10051.27	V	-33.54			
12643.59	V	-45.29			
13661.32	V	---			
3987.92	Horizontal	-35.96	-13.00	Pass	
7655.40	H	-39.60			
10177.41	H	-39.88			
12353.19	H	-39.80			
13342.98	H	---			
Test mode(824-849MHz):		LTE Band 26(5MHz)		Test channel:	Middle
Frequency (MHz)	Spurious Emission		Limit (dBm)	Result	
	Polarization	Level (dBm)			
3838.61	Vertical	-34.81	-13.00	Pass	
7681.26	V	-36.08			
10331.40	V	-29.39			
12532.74	V	-45.29			
15450.72	V	---			
3863.82	Horizontal	-36.96	-13.00	Pass	
7604.13	H	-36.31			
10410.41	H	-39.68			
12768.90	H	-36.80			
15414.42	H	---			
Test mode(824-849MHz):		LTE Band 26(5MHz)		Test channel:	Highest
Frequency (MHz)	Spurious Emission		Limit (dBm)	Result	
	Polarization	Level (dBm)			
3784.64	Vertical	-35.71	-13.00	Pass	
7881.37	V	-38.70			
10321.40	V	-33.66			
12527.23	V	-45.29			
15590.07	V	---			
3878.33	Horizontal	-35.96	-13.00	Pass	
7804.29	H	-36.31			
10283.08	H	-39.88			
12545.72	H	-37.11			
15310.29	H	---			

Remark :

- 4 The emission behaviour belongs to narrowband spurious emission,all modes investigated and only worst case is reported.
- 5 Remark"---" means that the emission level is too low (20dB lower than the limit) to be measured
- 6 The emission levels of below 1 GHz are very lower (20dB lower than the limit) than the limit and not show in test report.

Test mode		LTE Band 38(5MHz)		Test channel:	Lowest
Frequency (MHz)	Spurious Emission		Limit (dBm)	Result	
	Polarization	Level (dBm)			
2390.39	Vertical	-32.99	-25.00	Pass	
5320.93	V	-41.70			
10254.27	V	-35.39			
12950.57	V	-46.40			
13548.44	V	---			
3153.66	Horizontal	-35.96	-25.00	Pass	
5270.49	H	-38.61			
10079.38	H	-37.99			
12798.76	H	-41.92			
13083.44	H	---			
Test mode		LTE Band 38(5MHz)		Test channel:	Middle
Frequency (MHz)	Spurious Emission		Limit (dBm)	Result	
	Polarization	Level (dBm)			
2612.40	Vertical	-33.82	-25.00	Pass	
5318.93	V	-40.21			
10579.78	V	-32.61			
12814.92	V	-45.57			
15696.88	V	---			
2619.38	Horizontal	-31.85	-25.00	Pass	
5240.90	H	-37.21			
10913.19	H	-39.52			
12409.87	H	-42.18			
15512.87	H	---			
Test mode		LTE Band 38(5MHz)		Test channel:	Highest
Frequency (MHz)	Spurious Emission		Limit (dBm)	Result	
	Polarization	Level (dBm)			
2604.77	Vertical	-34.88	-25.00	Pass	
5803.17	V	-40.98			
10662.70	V	-34.50			
12739.21	V	-47.40			
16343.53	V	---			
2680.94	Horizontal	-36.84	-25.00	Pass	
5495.19	H	-38.58			
10327.41	H	-40.88			
13038.19	H	-39.08			
16437.14	H	---			

Remark :

- 4 The emission behaviour belongs to narrowband spurious emission,all modes investigated and only worst case is reported.
- 5 Remark"---" means that the emission level is too low (20dB lower than the limit) to be measured
- 6 The emission levels of below 1 GHz are very lower (20dB lower than the limit) than the limit and not show in test report.

Test mode		LTE Band 41(5MHz)		Test channel:	Lowest
Frequency (MHz)	Spurious Emission		Limit (dBm)	Result	
	Polarization	Level (dBm)			
4862.15	Vertical	-35.29	-25.00	Pass	
9975.57	V	-38.72			
10259.79	V	-30.90			
12344.43	V	-46.29			
13093.44	V	---			
4959.46	Horizontal	-33.95	-25.00	Pass	
9904.30	H	-40.19			
10152.02	H	-37.86			
12609.47	H	-38.80			
13274.11	H	---			
Test mode		LTE Band 41(5MHz)		Test channel:	Middle
Frequency (MHz)	Spurious Emission		Limit (dBm)	Result	
	Polarization	Level (dBm)			
5100.08	Vertical	-34.80	-25.00	Pass	
10054.87	V	-39.98			
12224.09	V	-33.47			
13514.93	V	-44.66			
15383.29	V	---			
5089.75	Horizontal	-35.04	-25.00	Pass	
10117.60	H	-36.47			
12510.02	H	-39.99			
13294.47	H	-37.80			
15527.06	H	---			
Test mode		LTE Band 41(5MHz)		Test channel:	Highest
Frequency (MHz)	Spurious Emission		Limit (dBm)	Result	
	Polarization	Level (dBm)			
5151.41	Vertical	-34.99	-25.00	Pass	
10191.89	V	-40.48			
12128.68	V	-29.66			
13298.43	V	-45.29			
15323.37	V	---			
5065.41	Horizontal	-35.09	-25.00	Pass	
10319.33	H	-37.73			
12803.08	H	-39.49			
13634.08	H	-39.11			
15310.07	H	---			

Remark :

- 4 The emission behaviour belongs to narrowband spurious emission,all modes investigated and only worst case is reported.
- 5 Remark"---" means that the emission level is too low (20dB lower than the limit) to be measured
- 6 The emission levels of below 1 GHz are very lower (20dB lower than the limit) than the limit and not show in test report.

Test mode:	LTE Band 66(1.4MHz)		Test channel:	Lowest
Frequency (MHz)	Spurious Emission		Limit (dBm)	Result
	Polarization	Level (dBm)		
3439.24	Vertical	-32.82	-13.00	Pass
5280.76	V	-40.48		
6711.27	V	-30.37		
8385.54	V	-45.56		
10286.73	V	---		
3463.87	Horizontal	-35.00	-13.00	Pass
5199.29	H	-36.02		
6909.52	H	-38.99		
8576.62	H	-39.91		
10329.11	H	---		
Test mode:	LTE Band 66(1.4MHz)		Test channel:	Middle
Frequency (MHz)	Spurious Emission		Limit (dBm)	Result
	Polarization	Level (dBm)		
3460.92	Vertical	-35.02	-13.00	Pass
5171.01	V	-38.81		
6946.85	V	-33.77		
8781.80	V	-44.60		
10417.98	V	---		
3381.69	Horizontal	-33.85	-13.00	Pass
5252.98	H	-37.25		
6993.77	H	-39.15		
8744.68	H	-38.80		
10640.85	H	---		
Test mode:	LTE Band 66(1.4MHz)		Test channel:	Highest
Frequency (MHz)	Spurious Emission		Limit (dBm)	Result
	Polarization	Level (dBm)		
3354.64	Vertical	-31.71	-13.00	Pass
5168.26	V	-34.04		
7044.93	V	-29.70		
8759.35	V	-46.40		
10598.88	V	---		
3584.20	Horizontal	-34.96	-13.00	Pass
5265.41	H	-33.48		
7082.69	H	-39.26		
8833.73	H	-39.91		
10583.91	H	---		

Remark :

- 1 The emission behaviour belongs to narrowband spurious emission,all modes investigated and only worst case is reported.
- 2 Remark"---" means that the emission level is too low (20dB lower than the limit) to be measured
- 3 The emission levels of below 1 GHz are very lower (20dB lower than the limit) than the limit and not show in test report.

4.10 FREQUENCY STABILITY V.S. TEMPERATURE MEASUREMENT

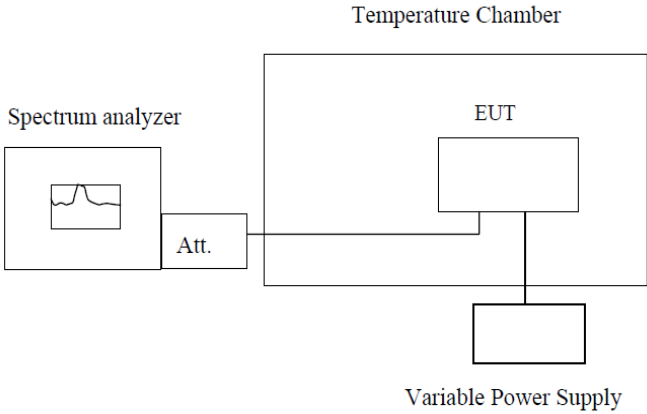
Test Requirement:	Part 2.1055(a)(1)(b), Part 22.355 Part 24.235 , Part 27.54, Part 90.213
Test Method:	ANSI C63.26:2015
Limit:	2.5ppm(Part 22) Within the authorized bands of operation(Part 24, Part 27)
Test setup:	<div style="text-align: center;">  <p style="text-align: center;">Temperature Chamber</p> <p style="text-align: center;">Spectrum analyzer</p> <p style="text-align: center;">Att.</p> <p style="text-align: center;">EUT</p> <p style="text-align: center;">Variable Power Supply</p> </div> <p>Note : Measurement setup for testing on Antenna connector</p>
Test procedure:	<ol style="list-style-type: none"> 1. The equipment under test was connected to an external DC power supply and input rated voltage. 2. RF output was connected to a frequency counter or spectrum analyzer via feed through attenuators. 3. The EUT was placed inside the temperature chamber. 4. Set the spectrum analyzer RBW low enough to obtain the desired frequency resolution and measure EUT 25°C operating frequency as reference frequency. 5. Turn EUT off and set the chamber temperature to –20°C. After the temperature stabilized for approximately 30 minutes recorded the frequency. 6. Repeat step measure with 10°C increased per stage until the highest temperature of +50°C reached.
Test Instruments:	Refer to section 3 for details
Test mode:	Refer to section 4.1 for details
Test results:	Pass
Remark:	If all frequencies stability are comply with the lower limit, then all results can be considered qualified

Note: Please refer to Appendix F of the Appendix Test Data.

4.11 FREQUENCY STABILITY V.S. VOLTAGE MEASUREMENT

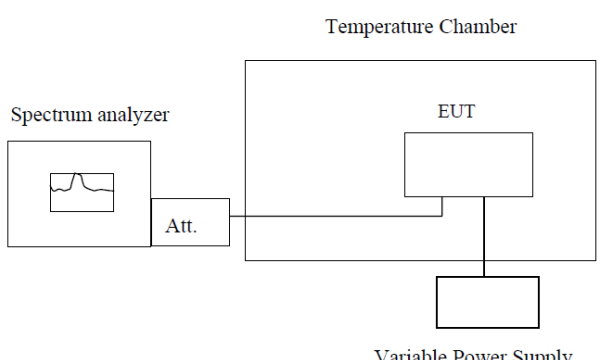
Test Requirement:	Part 2.1055(d)(1)(2) Part 22.355 Part 24.235 Part 27.54 Part 90.213
Test Method:	ANSI C63.26:2015
Limit:	2.5ppm Band II & Band VII should be within authorized band.
Test setup:	 <p style="text-align: center;">Temperature Chamber</p> <p style="text-align: center;">Spectrum analyzer Att. EUT</p> <p style="text-align: center;">Variable Power Supply</p> <p>Note : Measurement setup for testing on Antenna connector</p>
Test procedure:	<ol style="list-style-type: none"> 1. Set chamber temperature to 20°C. Use a variable DC power source to power the EUT and set the voltage to rated voltage. 2. Set the spectrum analyzer RBW low enough to obtain the desired frequency resolution and recorded the frequency. 3. Reduce the input voltage to specified extreme voltage variation (+/- 15%) and endpoint, record the maximum frequency change.
Test Instruments:	Refer to section 3 for details
Test mode:	Refer to section 4.1 for details
Test results:	Pass
Remark:	<ol style="list-style-type: none"> 1. Manufacturer specified the battery operating end point voltage is 3.61VDC, max voltage is 4.18VDC. 2. If all frequencies stability are comply with the lower limit, then all results can be considered qualified

Note: Please refer to Appendix F of the Appendix Test Data.

4.12 TEST SETUP PHOTO

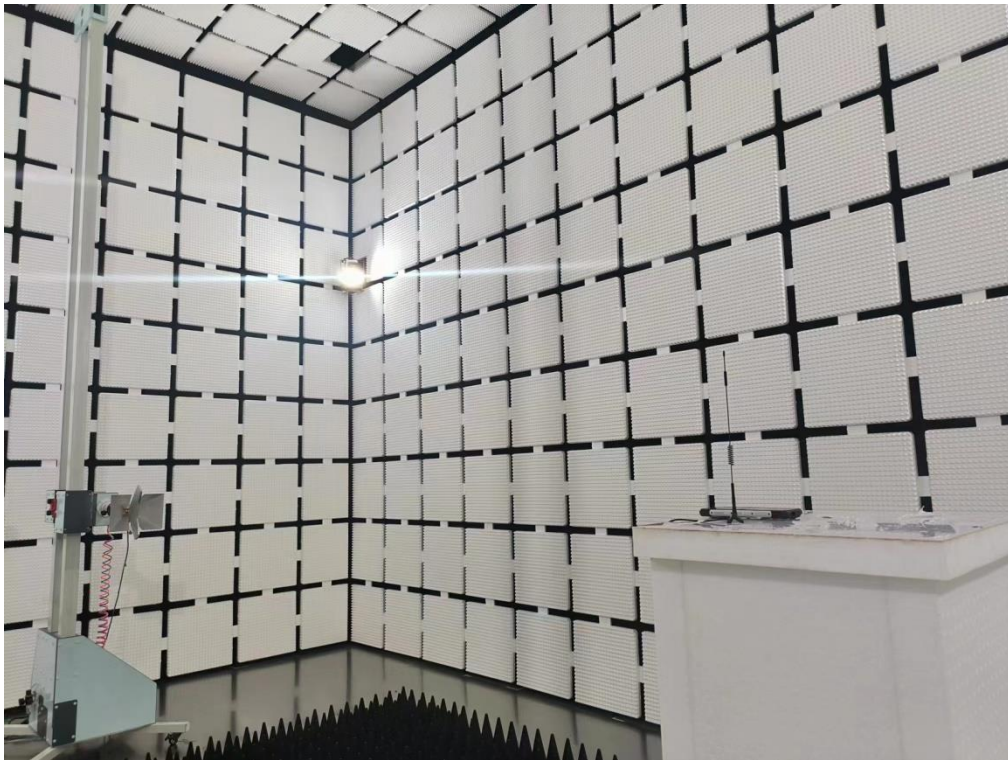
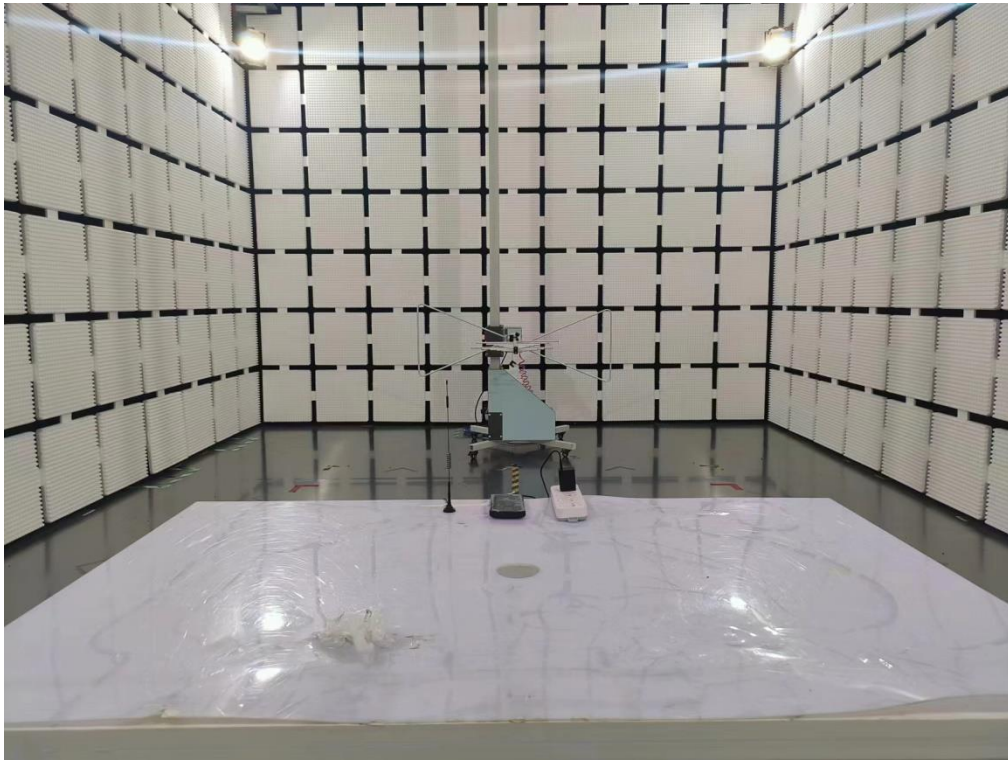

4.13 PHOTOS OF EUT



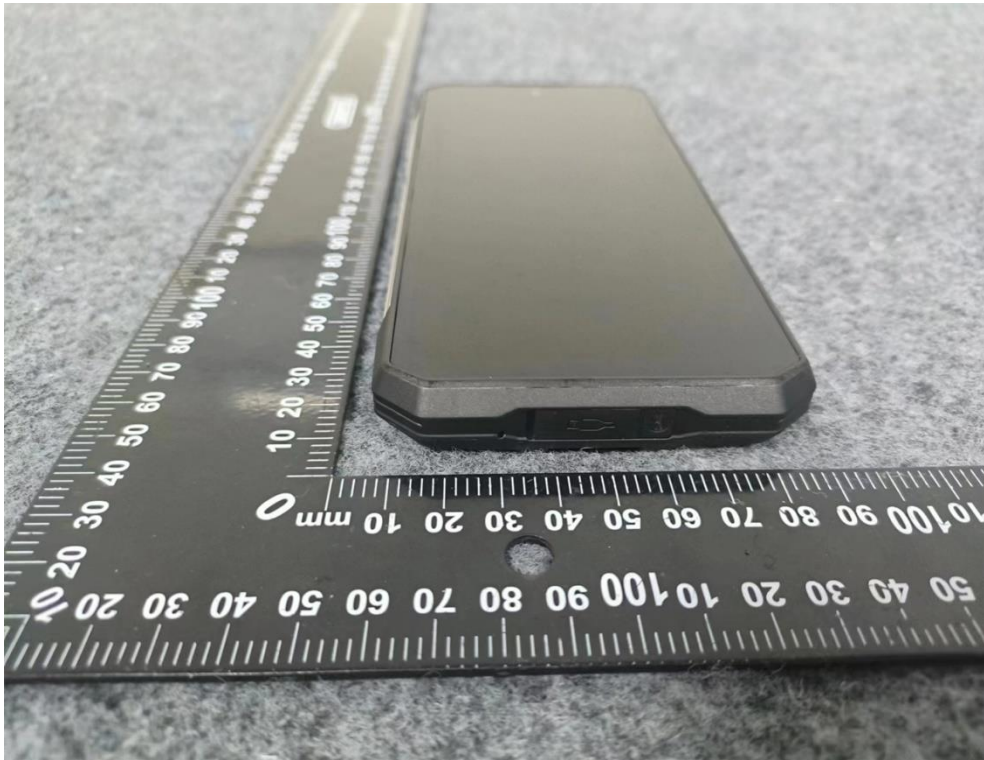







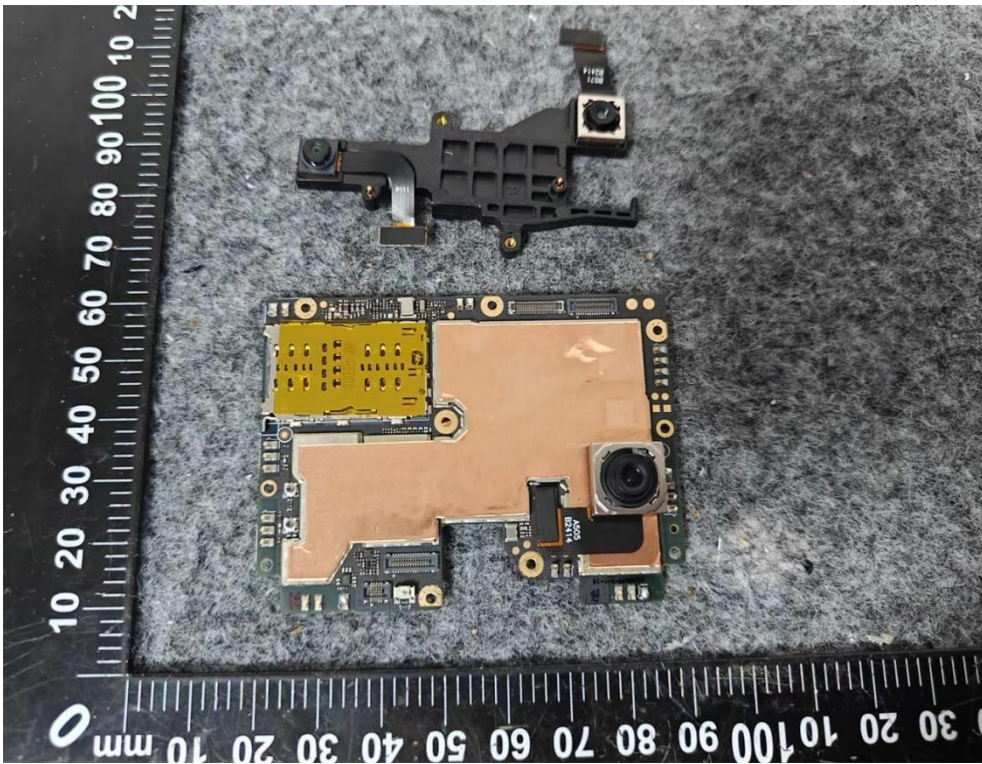

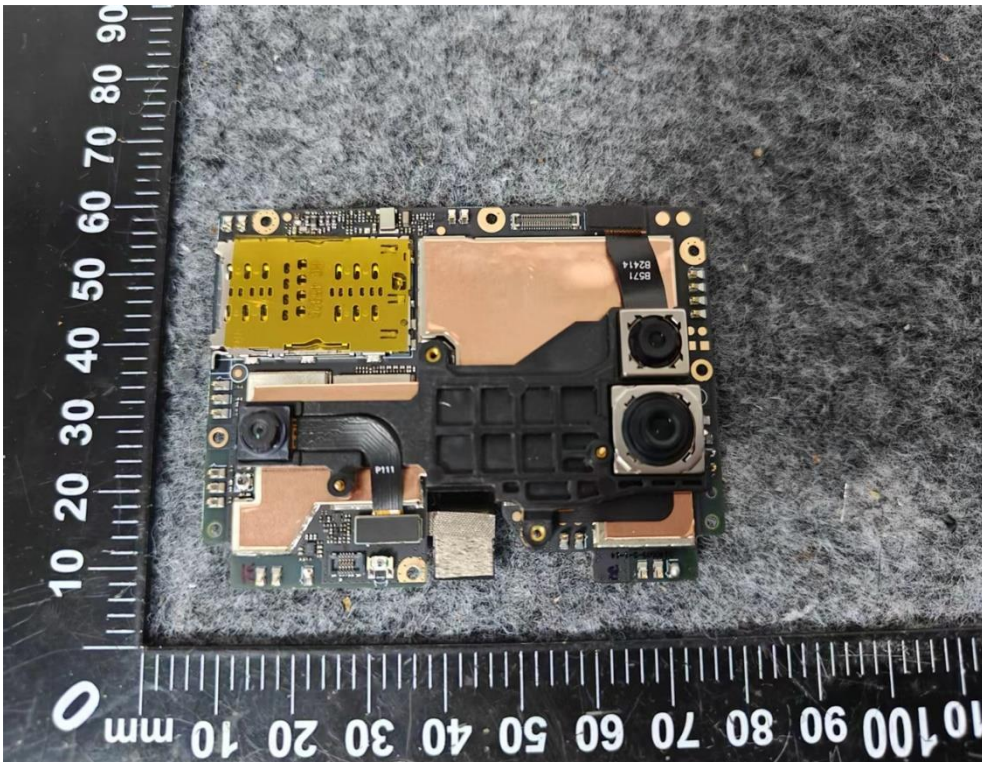

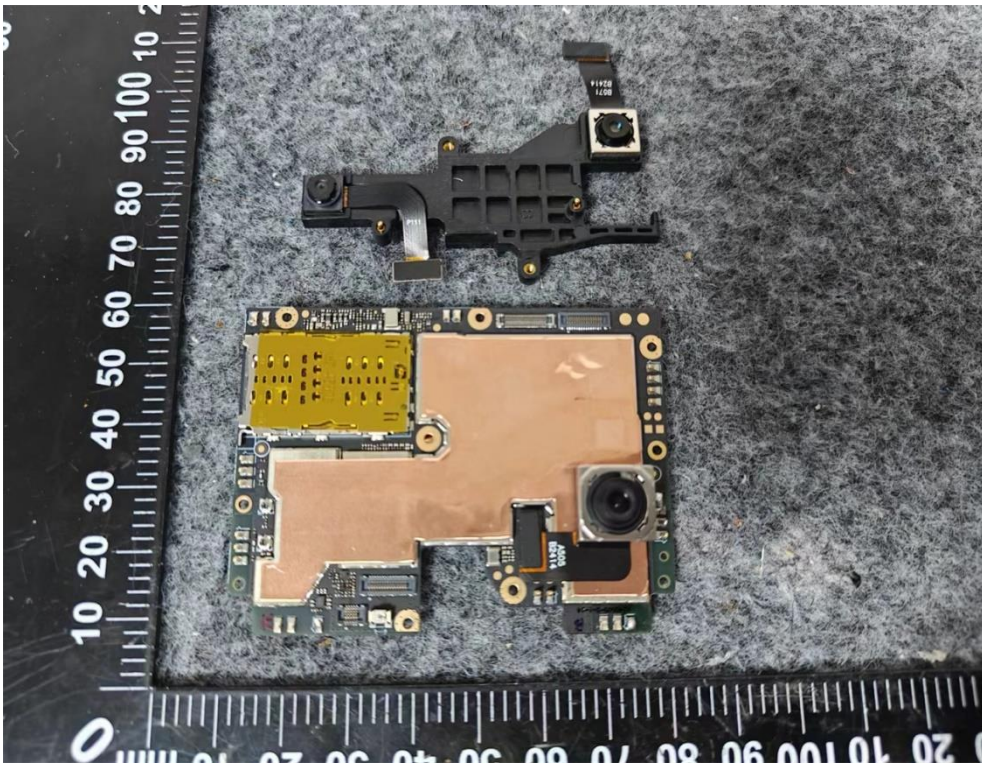
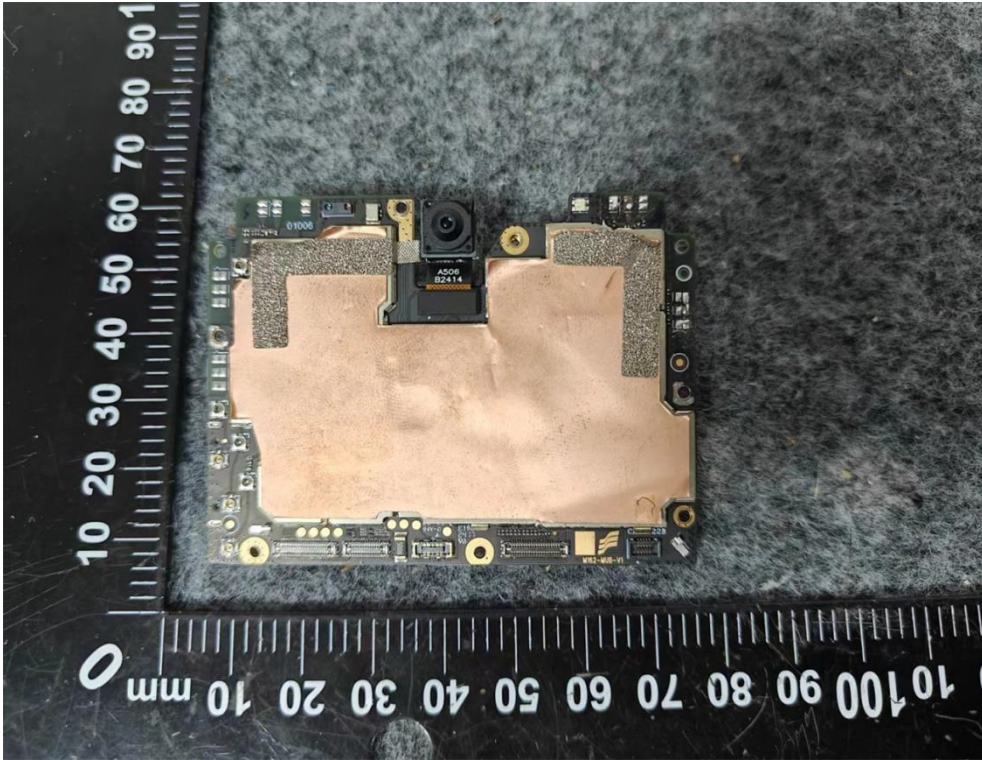

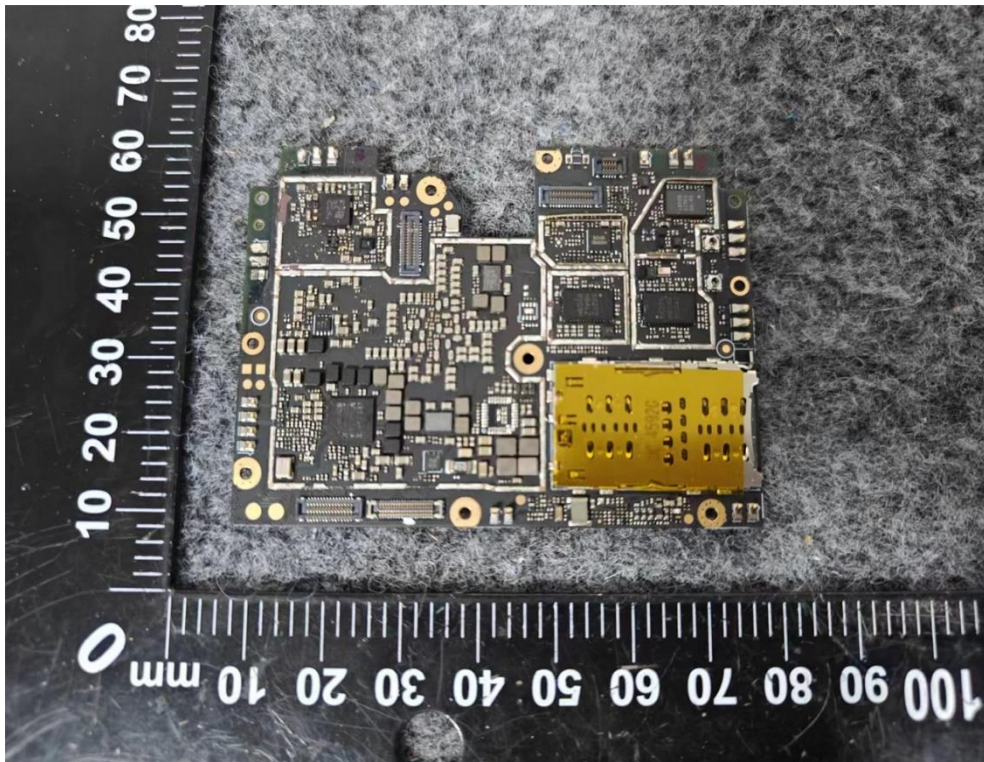
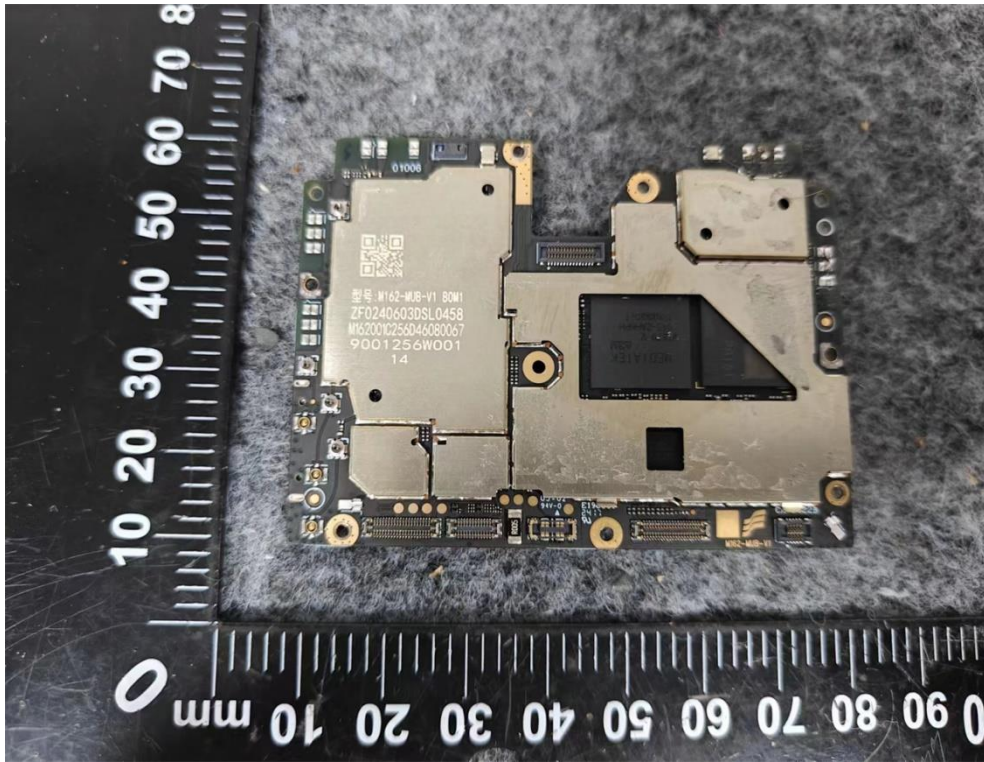

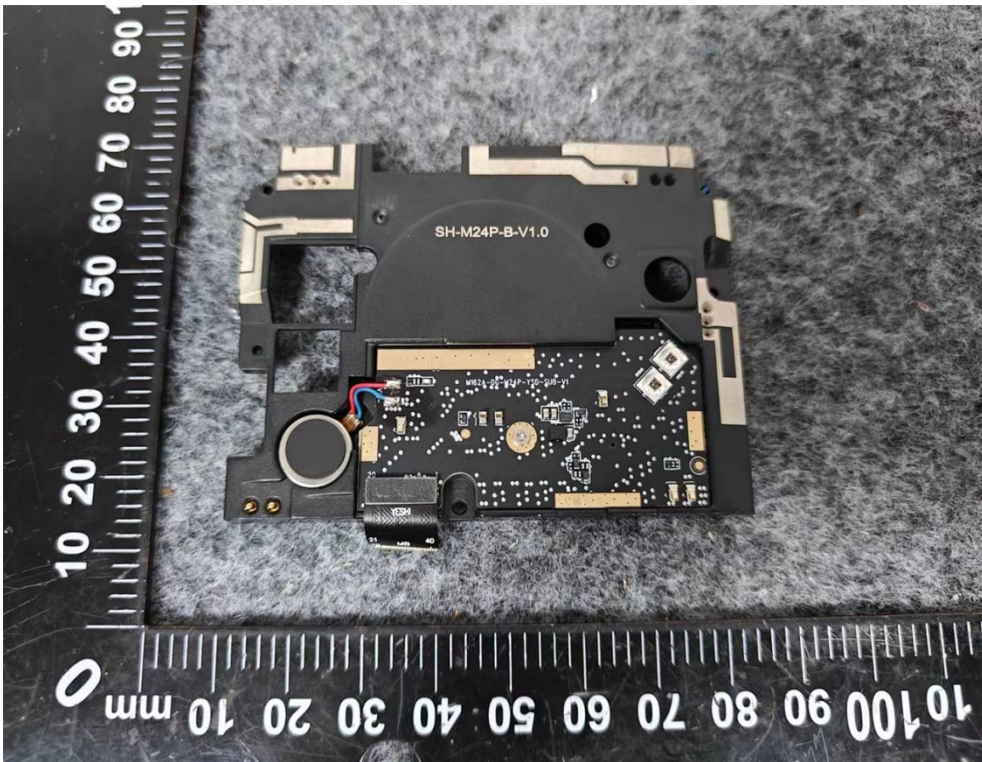
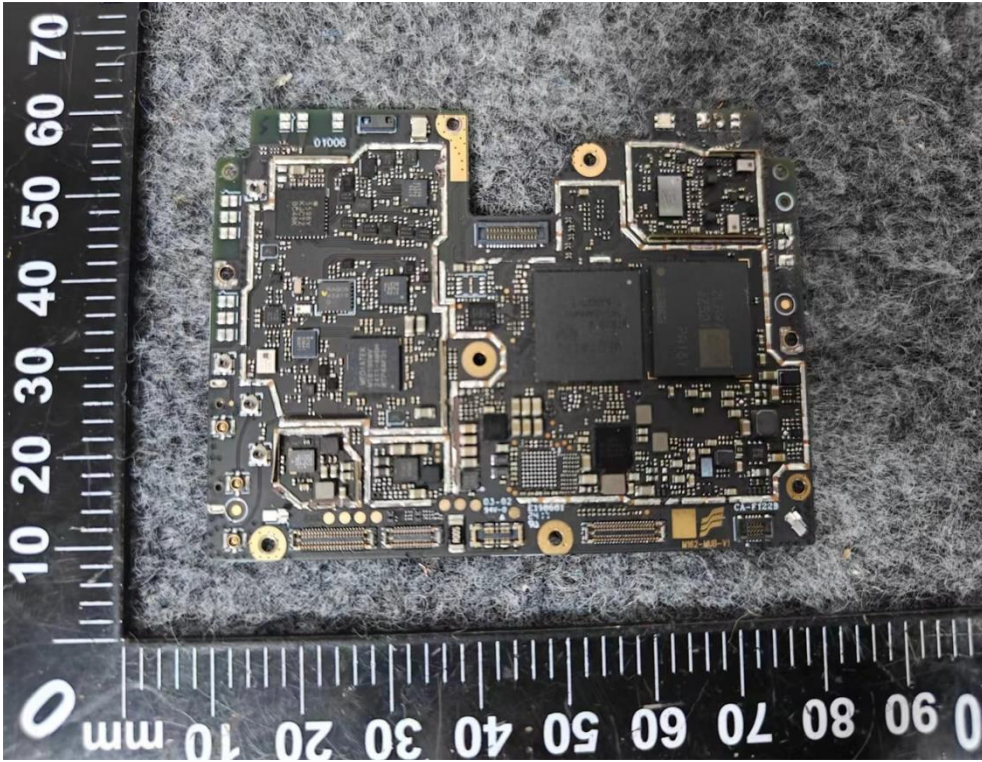

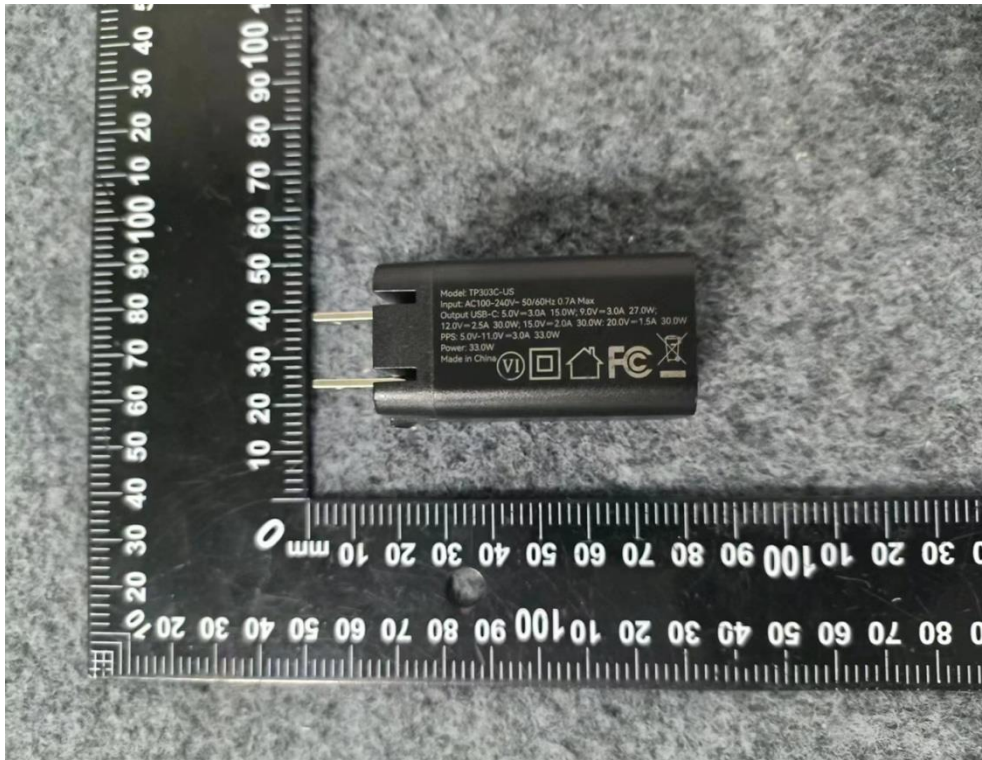

-----END OF REPORT-----