

# User Manual

## Product Information

### Safety and Compliance Information

#### Using Your Device Around Other Electronic Devices

The Device, uses, and can radiate radio frequency (RF) energy and, if not used in accordance with its instructions, may cause interference to radio communications and electronic equipment. External RF signals may affect improperly installed or inadequately shielded electronic operating systems, entertainment systems, and personal medical devices.

While most modern electronic equipment is shielded from external RF signals, if in doubt, check with the manufacturer. For personal medical devices (such as pacemakers and hearing aids), consult with your physician or the manufacturer to determine if they are adequately shielded from external RF signals.

There are some places where RF signals could constitute a hazard, such as health care facilities, and construction sites. If you are not sure, look around for signs indicating that two-way radios or mobile phones should be turned off.

### FCC Compliance Information

#### Radio Frequency Information

This device complies with part 15 of the FCC Rules. Operation is subject to the following two conditions: (1) This device may not cause harmful interference, and (2) this device must accept any interference received, including interference that may cause undesired operation.

Note: This equipment has been tested and found to comply with the limits for a Class B digital device, pursuant to part 15 of the FCC Rules. These limits are designed to provide reasonable protection against harmful interference in a residential installation.

This equipment generates, uses and can radiate radio frequency energy and, if not installed and used in accordance with the instructions, may cause harmful interference to radio communications. However, there is no guarantee that interference will not occur in a particular installation. If this equipment does cause harmful interference to radio or television reception, which can be determined by turning the equipment off and on, the user is encouraged to try to correct the interference by one or more of the following measures:

- Reorient or relocate the receiving antenna.
- Increase the separation between the equipment and receiver.
- Connect the equipment into an outlet on a circuit different from that to which the receiver is connected.
- Consult the dealer or an experienced radio/TV technician for help.

Changes or modifications that are not expressly approved by the party responsible for compliance could make the device no longer comply with the FCC Rules.

Information on your device is on file with the FCC and can be found by inputting your device's FCC ID, which can be found on the back of Device, into the FCC ID Search form available at [transition.fcc.gov/oet/ea/fccid](http://transition.fcc.gov/oet/ea/fccid).

## IC Compliance Information

### IC Compliance Information

#### Radio Frequency Information

This device complies with Industry Canada's license-exempt RSSs. Operation is subject to the following two conditions:

- (1) This device may not cause interference; and
- (2) This device must accept any interference, including interference that may cause undesired operation of the device.

Le présent appareil est conforme aux CNR d'Industrie Canada applicables aux appareils radio exempts de licence. L'exploitation est autorisée aux deux conditions suivantes:

- (1) l'appareil ne doit pas produire de brouillage, et
- (2) l'utilisateur de l'appareil doit accepter tout brouillage radioélectrique subi, même si le brouillage est susceptible d'en compromettre le fonctionnement."

The device could automatically discontinue transmission in case of absence of information to transmit, or operational failure. Note that this is not intended to prohibit transmission of control or signaling information or the use of repetitive codes where required by the technology.

The device for operation in the band 5150-5250 MHz is only for indoor use to reduce the potential for harmful interference to co-channel mobile satellite systems;

Les dispositifs fonctionnant dans la bande de 5150 à 5250 MHz sont réservés uniquement pour une utilisation à l'intérieur afin de réduire les risques de brouillage préjudiciable aux systèmes de satellites mobiles utilisant les mêmes canaux.

CAN ICES-3(B)/NMB-3(B)

#### Product Specifications

Model Number: P5N8EC

Electrical Rating: 5V = 3A

Connectivity: **Bluetooth**, Bluetooth Low Energy, Wifi 2.4 GHz and 5 GHz, NFC, GNSS RX, WPT RX







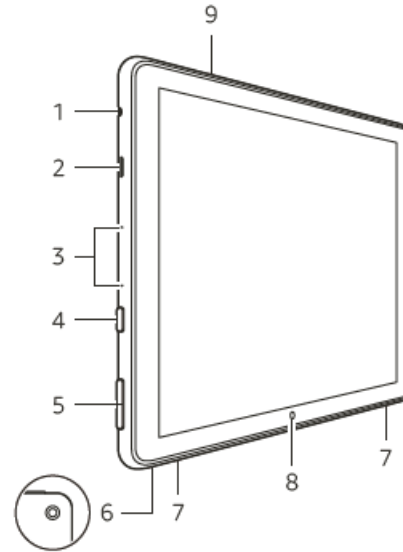
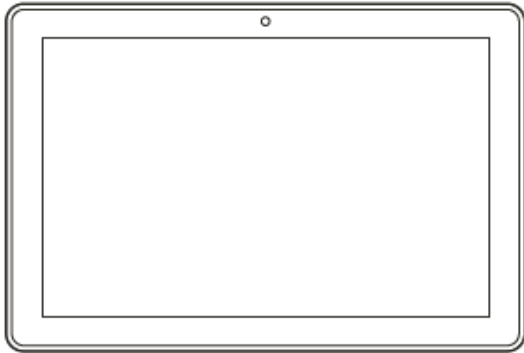

Temperature Rating: 0°C to 35°C

Operating temperature: 0°C to 35°C

## How to use

### What's in the box



- |   |   |
|---|---|
| 1.  Headphone jack   | 6.  Rear camera                            |
| 2.  USB-C port       | 7.  Speakers                               |
| 3.  Microphones      | 8.  Front camera                           |
| 4.  Power button     | 9.  microSD slot<br>(card sold separately) |
| 5.  Volume up/down |   |

### Getting started

1. Power on your tablet.

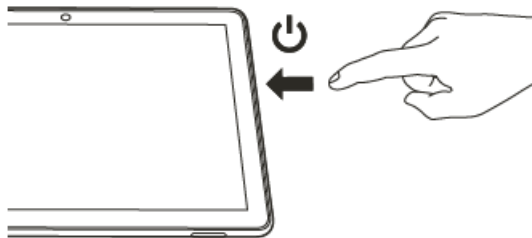

2. Swipe up to unlock.

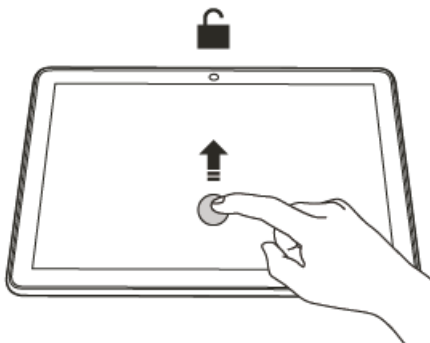

3. Follow the on-screen prompts to connect to a wifi network, then sign into an existing account or register to create a new account.

### Charging your tablet

We would not provide the USB cable and adapter in the box.

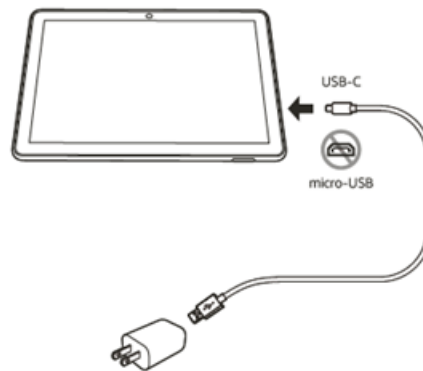

UK  
CA

CE

