



# MARA

BY REFLIKO

## User Manual

### Quick Starter Guide

For the optimal out of box MARA experience, please follow the below steps out of box:

1. Assembly
2. Enable [WiFi](#)
3. Enable [Rotation Manager](#) for full portrait mode.
4. Enable [Floating Keyboard](#).
5. Enable [App Store set up](#) to download and install apps.



[www.refliko.com](http://www.refliko.com)



# M A R A

BY REFLIKO

Parts List	4
Installation of stand to device	5
Turning on device	7
Home Bar	8
Mirror Mode On/Off	8
Setting up Wifi	8
Setting up the Rotation Manager	11
Setting up the Floating Keyboard	16
Android 7 Nougat	23
How to Login to App Store	23
How to Download and Install Apps	23
<b>TECHNICAL SPECIFICATIONS</b>	<b>24</b>
<b>FCC</b>	<b>26</b>
Federal Communications Commission (FCC) Statement	26
Important Safety Instructions	27
Danger - To reduce the risk of electric shock:	27
Warning - To reduce the risk of burns, fire, electric shock, or injury to persons:	27
Warnings	28
Cleaning REFLIKO MARA	28



# MARA

BY REFLIKO





# M A R A

BY REFLIKO

## Parts List

Power Cord  
x1

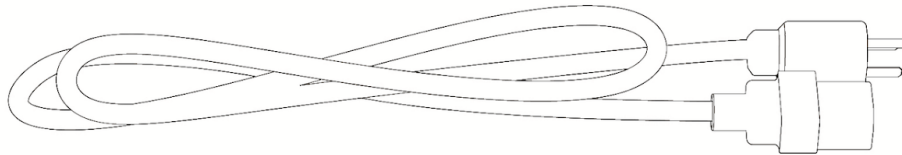

Antenna  
x1



Hexagonal Screws  
Washers  
x6

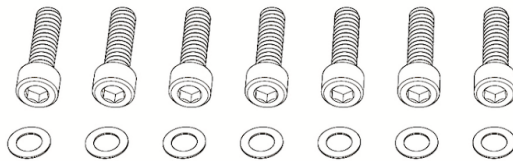

Screw  
x8



Anti-Tip Clip  
x2

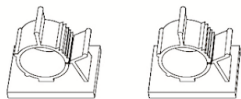

Allen Wrench  
x1





# M A R A

BY REFLIKO

## Installation of stand to device

Step 1: Lay mirror face down on soft cloth on floor.

Step 2: Attach cross beams to stand legs with screws.

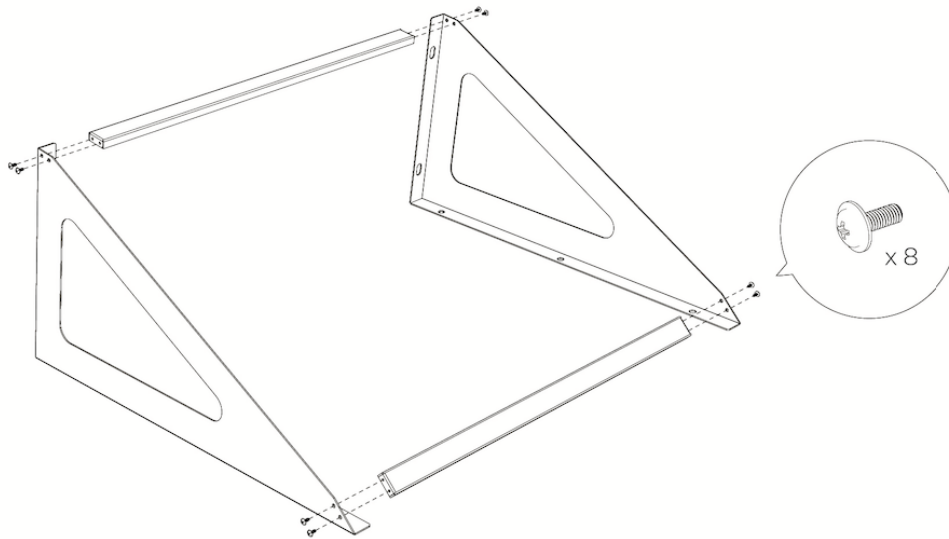

Step 3: Attach assembled stand to back of mirror with 6 hexagonal screws and washers using the allen wrench.

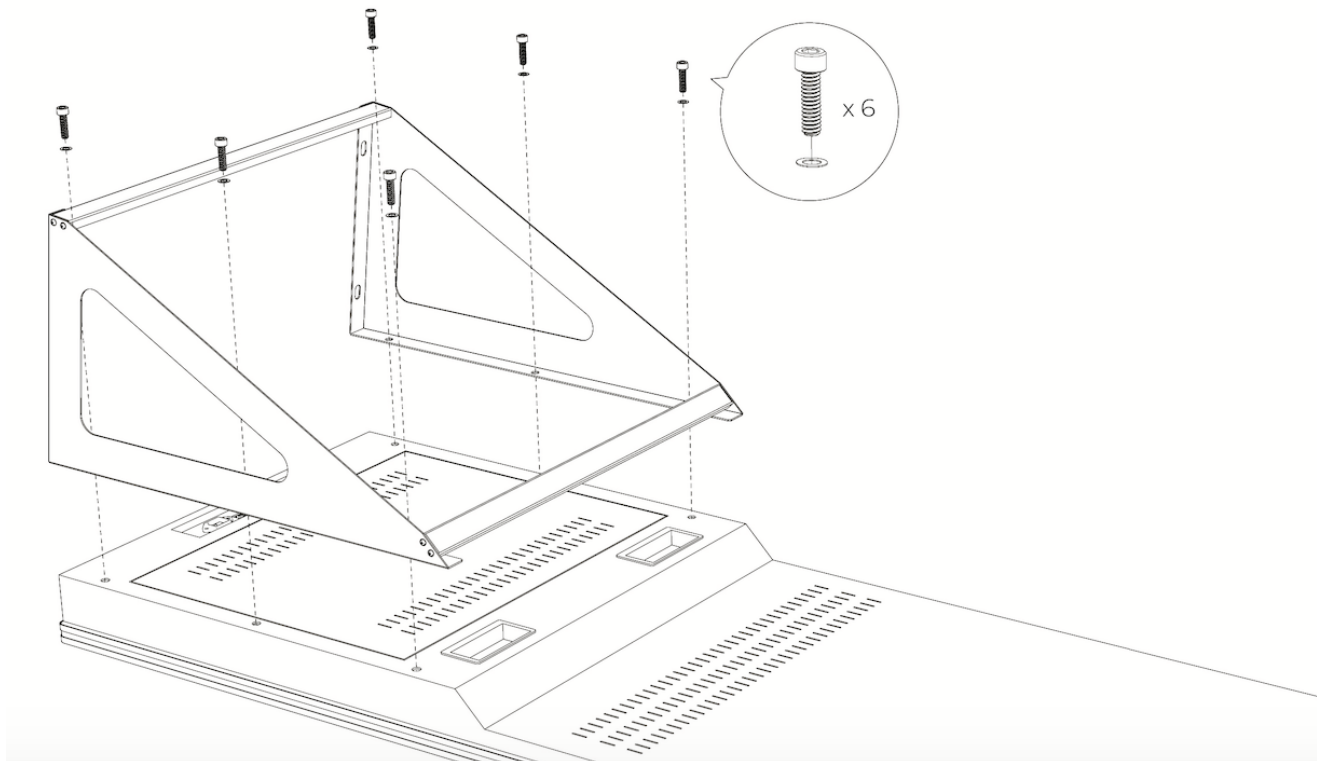



# M A R A

BY REFLIKO

Step 4: Remove film off the back of the Anti-tip clips and adhere them to the back top of the mirror. Orient the clips as indicated below.

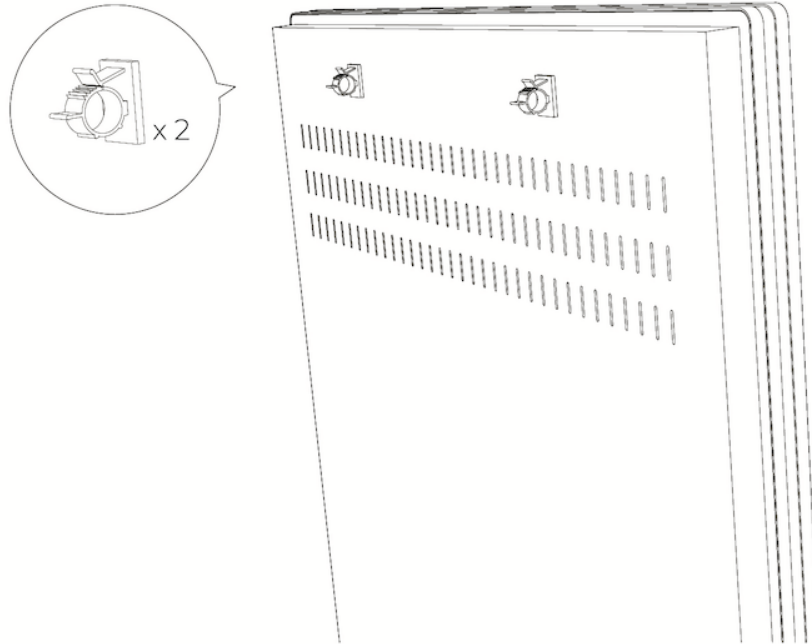

Step 5: Flip mirror right-side up making sure mirror bottom edge is protected with cloth.  
Use two people to lift.

Step 6: Attach power cord and antenna to the back of the mirror.



# M A R A

BY REFLIKO

## Turning on device

Press the Red Switch to the "I" position to turn on





# MARA

BY REFLIKO

## Home Bar



## Mirror Mode On/Off

1. Tap the icon "Display Off" to turn the display off to make MARA into a normal mirror.
2. Tap anywhere on the display, to wake up the device.

## Setting up Wifi

1. Swipe down from top of screen
2. Click and hold on WiFi Icon until WiFi Settings appears

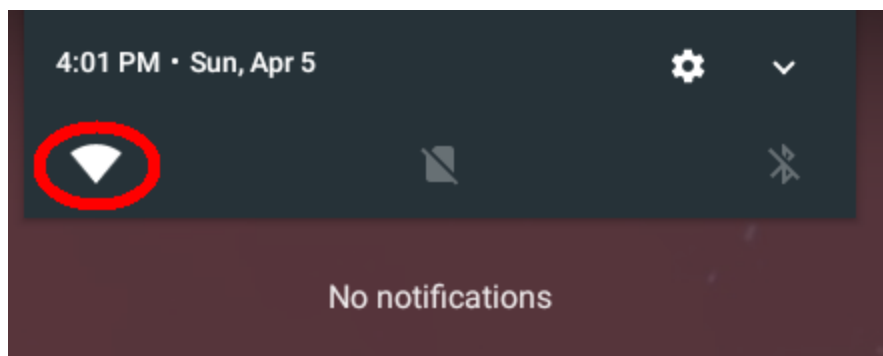
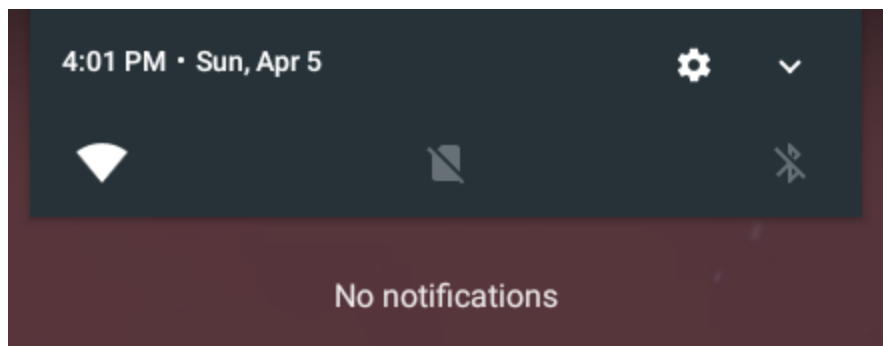





# MAR A

BY REFLIKO

### 3. Find Your WiFi Network

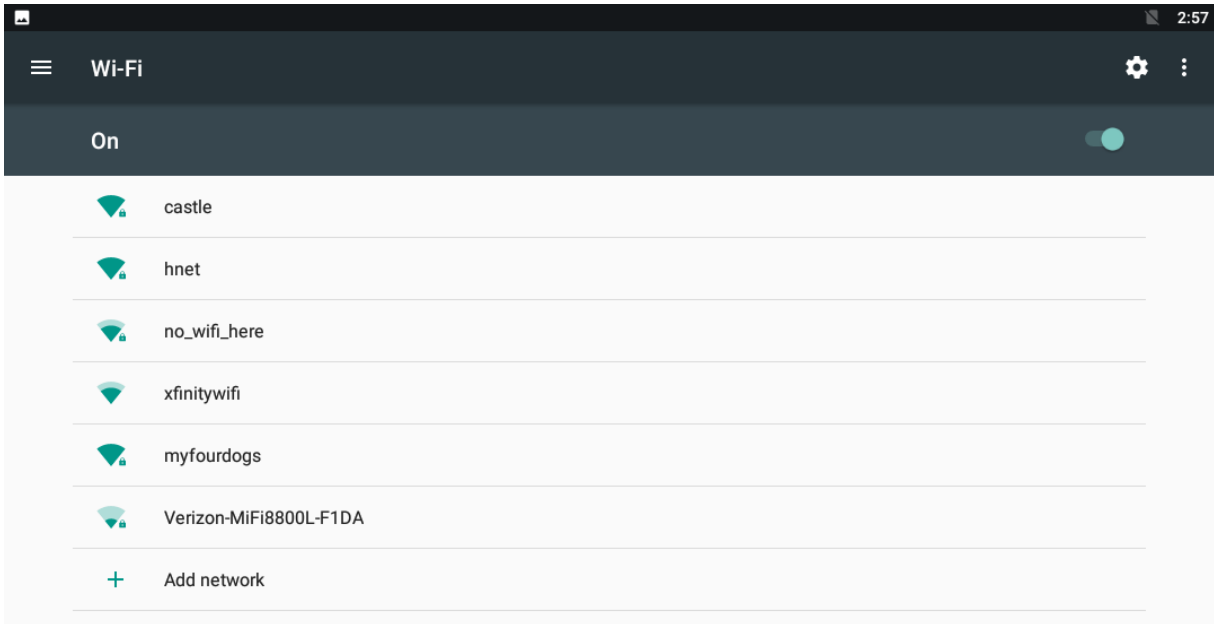

### 4. Select Your WiFi Network

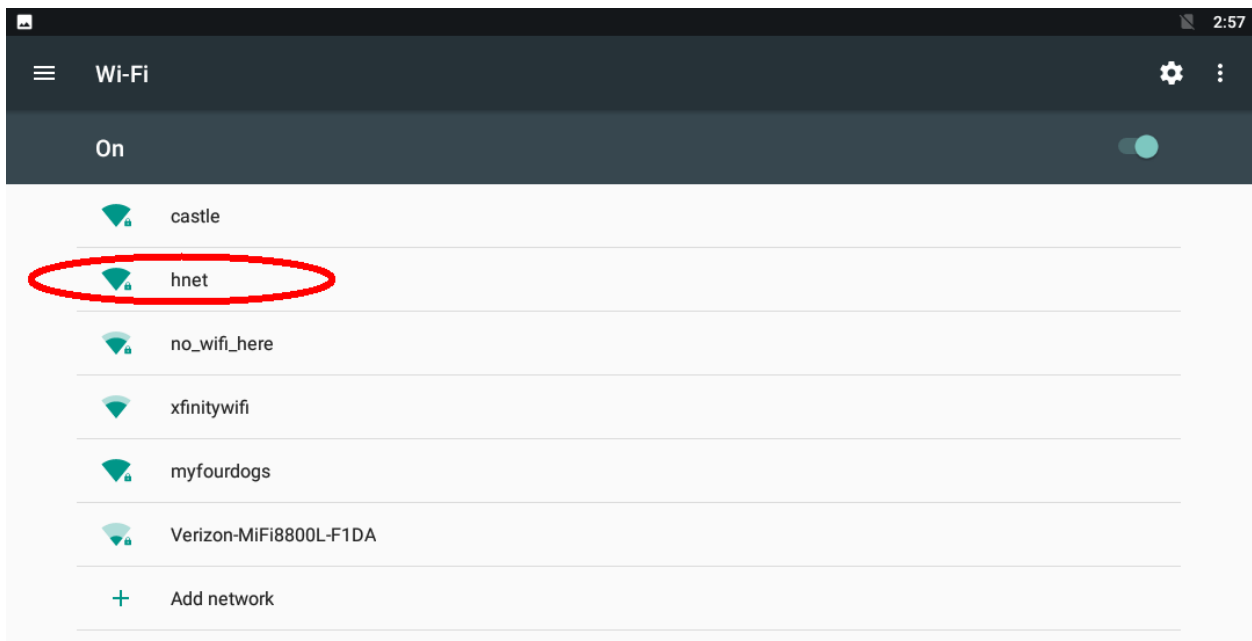



# M A R A

BY REFLIKO

5. If prompted, enter your WiFi password

A screenshot of a mobile device's WiFi connection screen. The network name 'hnet' is displayed at the top. Below it, the word 'Password' is followed by a text input field containing ten black dots. Underneath the input field is a teal horizontal line. To the left of the line is a checkbox labeled 'Show password'. Below that is the text 'Advanced options' with a downward-pointing chevron icon on the right. At the bottom right of the screen are two buttons: 'CANCEL' and 'CONNECT', both in teal text.

6. After entering password, click Connect

A screenshot of the same mobile device's WiFi connection screen as in the previous image. The network name 'hnet' is at the top, followed by 'Password' and a text input field with ten black dots. A teal horizontal line is below the input field. To the left is a checkbox labeled 'Show password'. Below that is 'Advanced options' with a downward-pointing chevron icon on the right. At the bottom right are two buttons: 'CANCEL' and 'CONNECT'. The 'CONNECT' button is circled in red.



# MAR A

BY REFLIKO

## Setting up the Rotation Manager

1. Swipe up from Bottom of the Screen

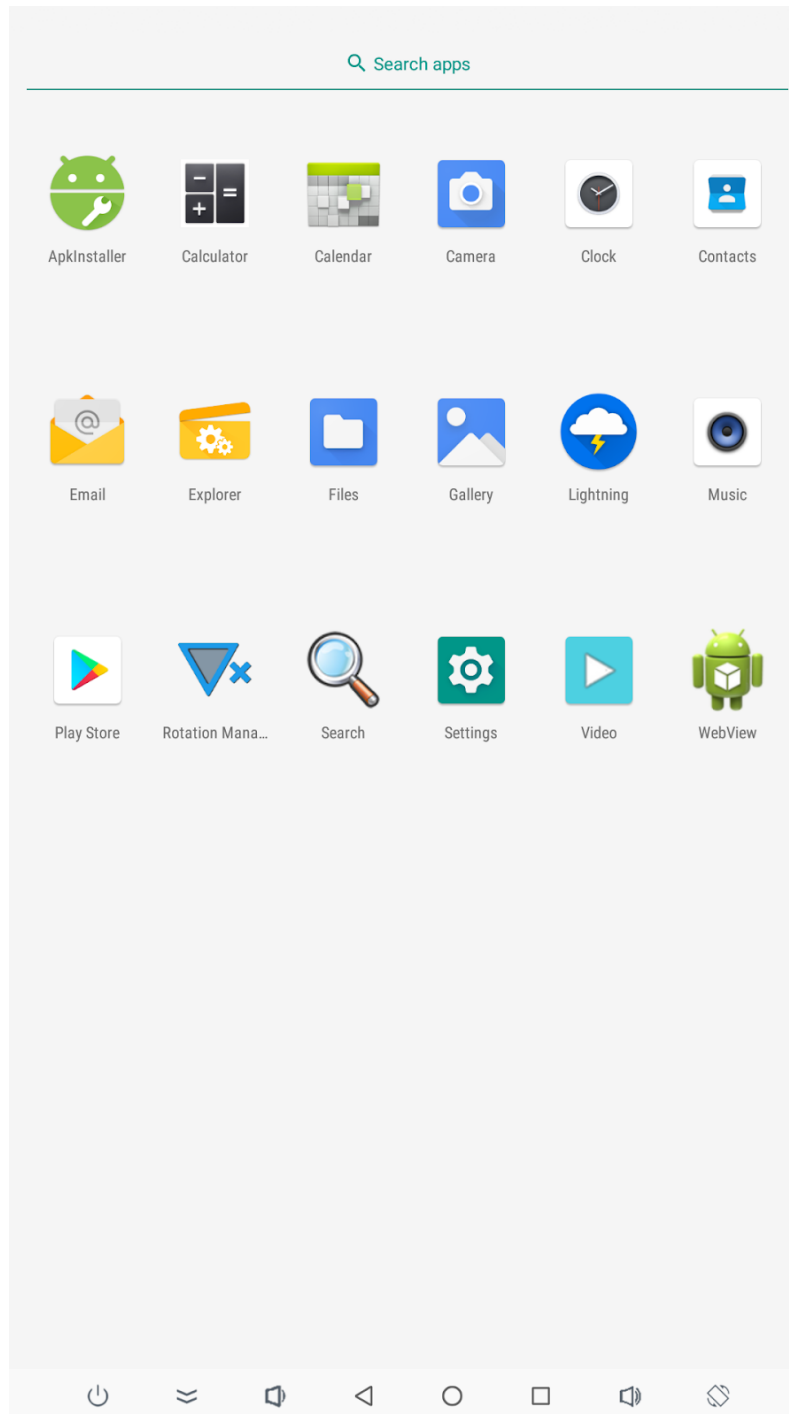



# M A R A

BY REFLIKO

2. Open Rotation Manager App

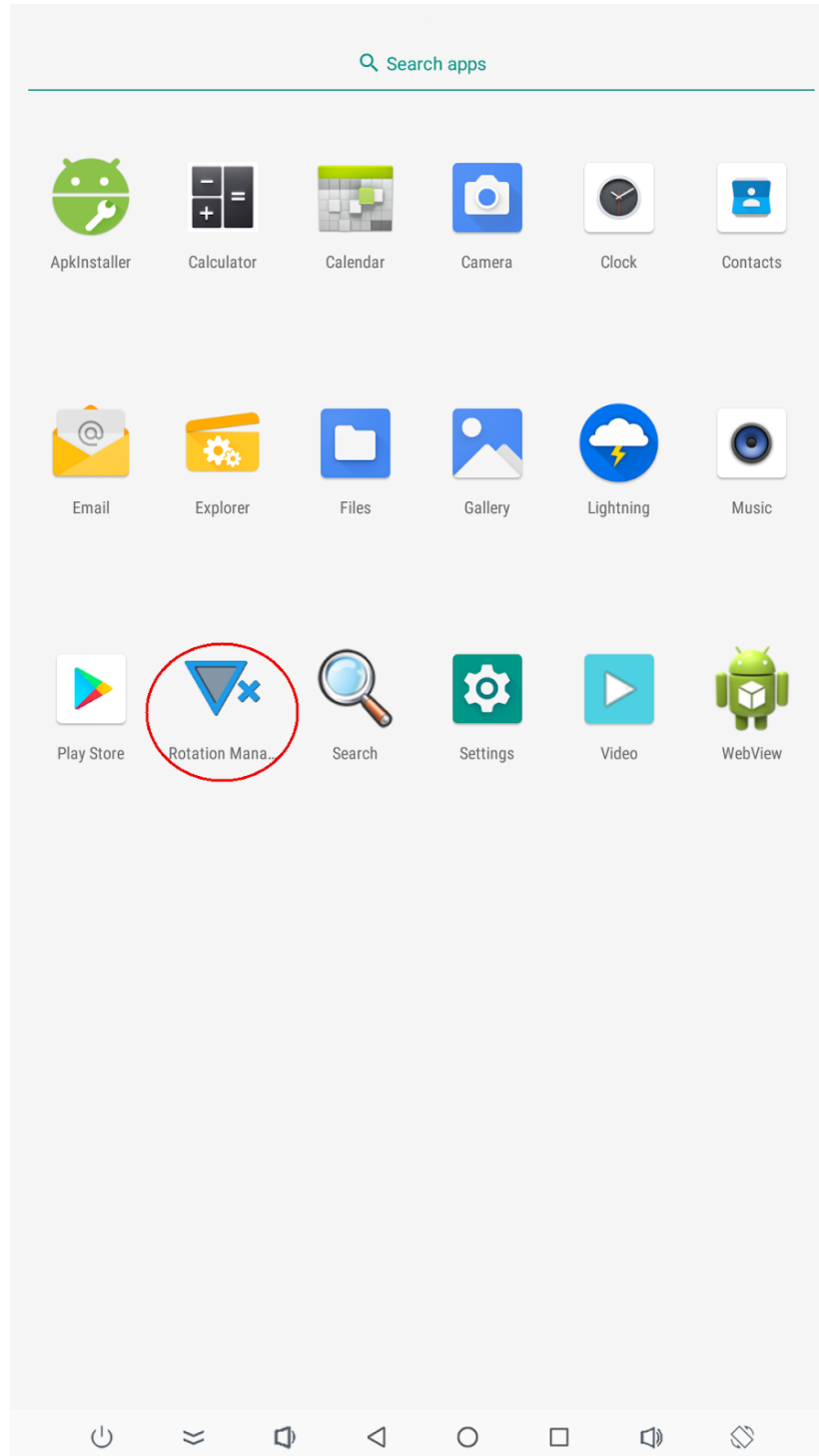



# M A R A

BY REFLIKO

### 3. Swipe Left to Continue





# MARA

BY REFLIKO

4. Click on the icon until you see "Forced Portrait"

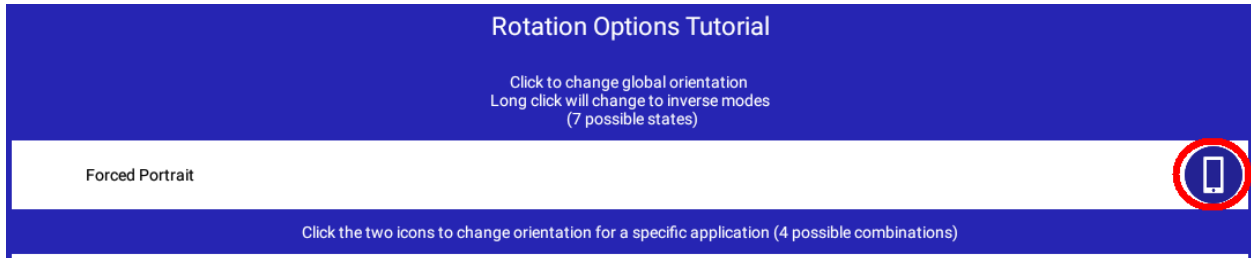

5. Swipe Left

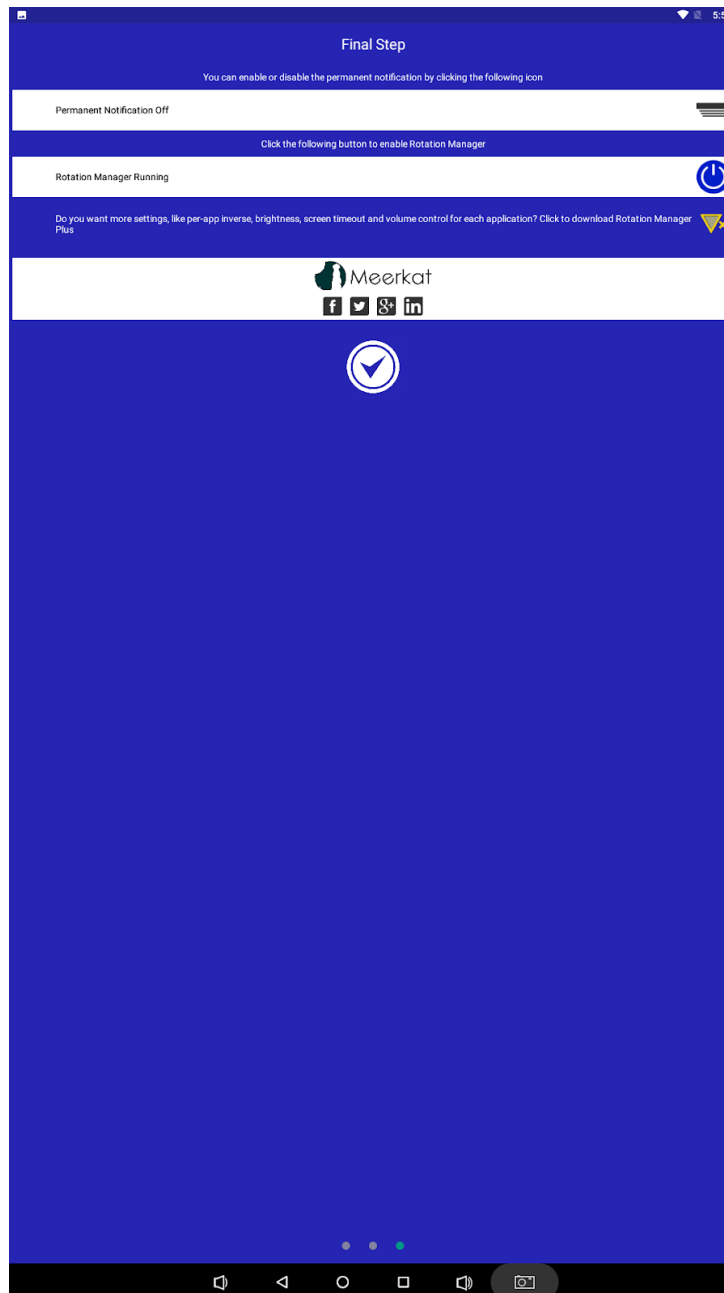



# MAR A

BY REFLIKO

6. Click on the highlighted icon until "Permanent Notification Off" is seen



7. Click on the highlighted icon until "Rotation Manager Running" is seen

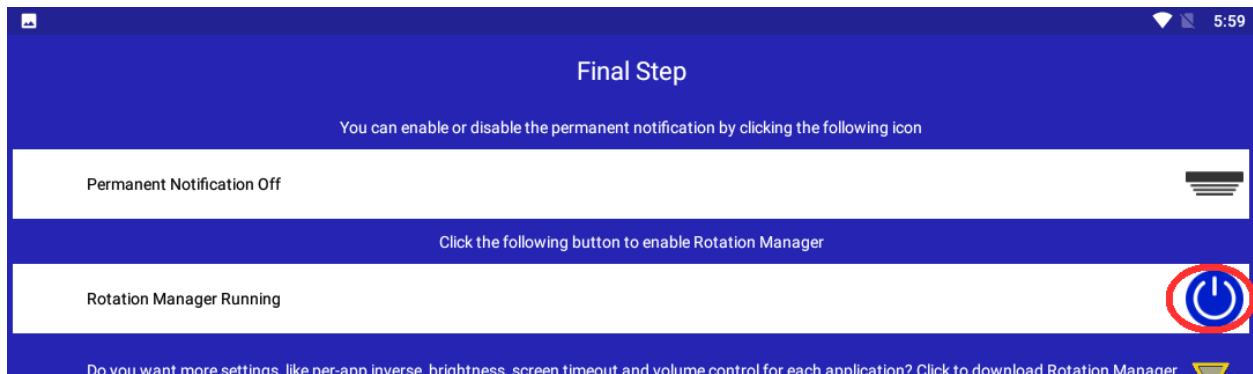

8. Click the highlighted check mark to finish

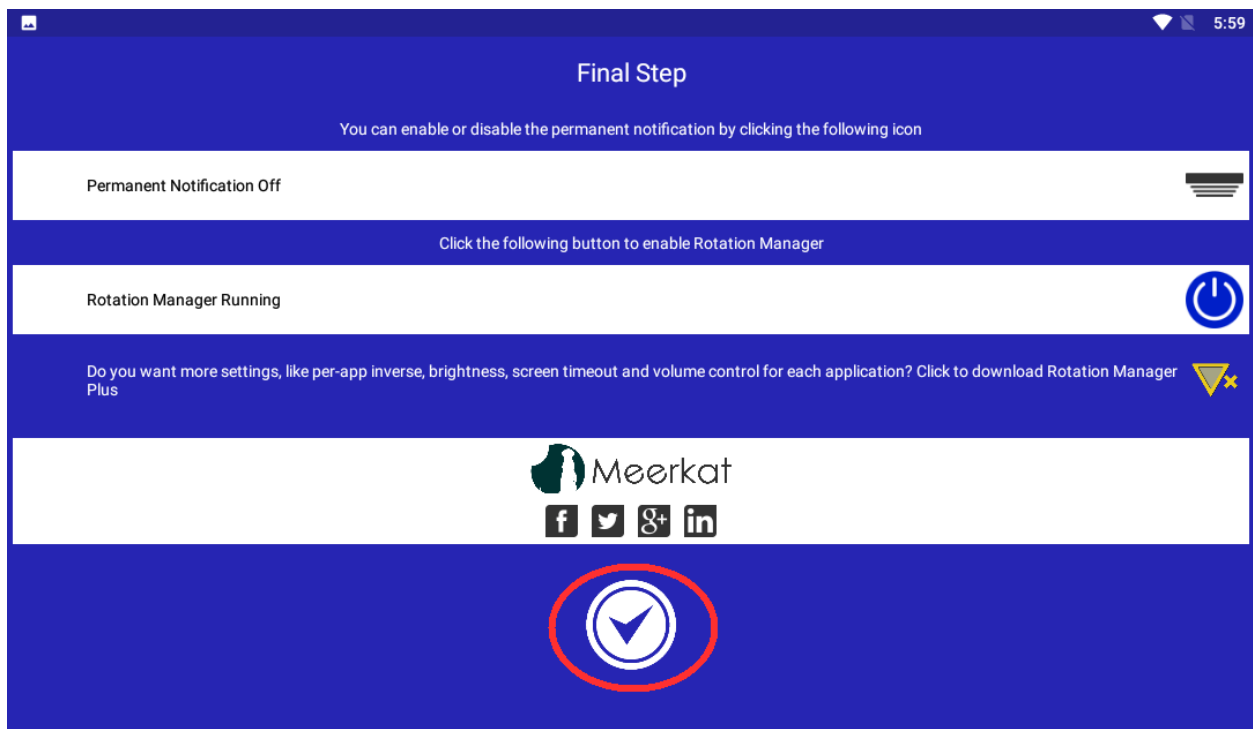



# MAR A

BY REFLIKO

## Setting up the Floating Keyboard

1. Swipe down from top of screen

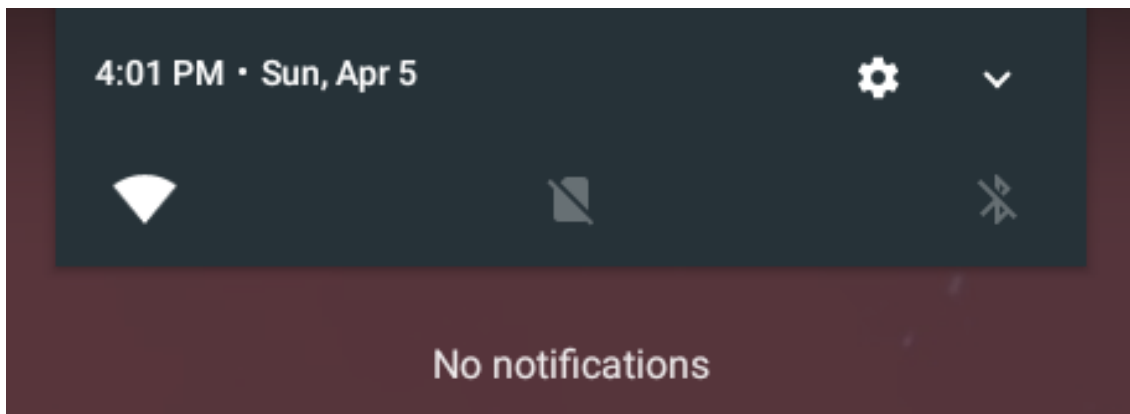

2. Click on the Settings Icon

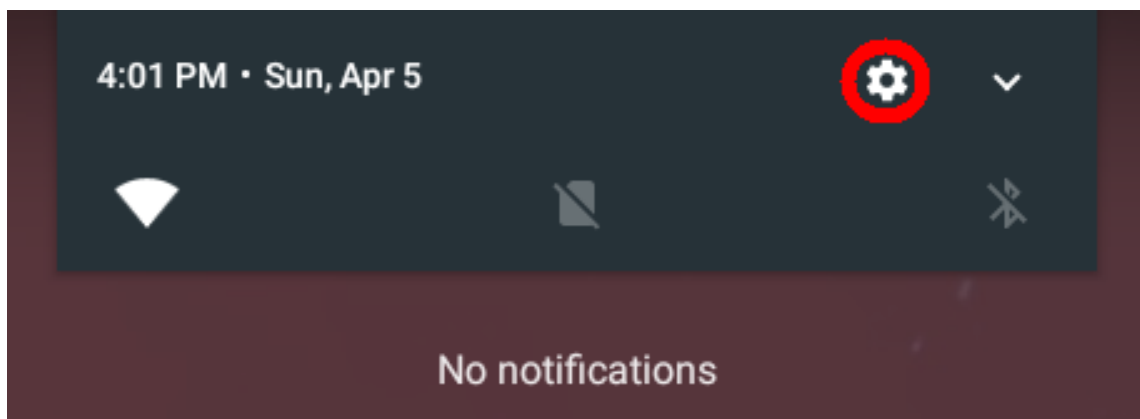

3. Click on Languages & Input

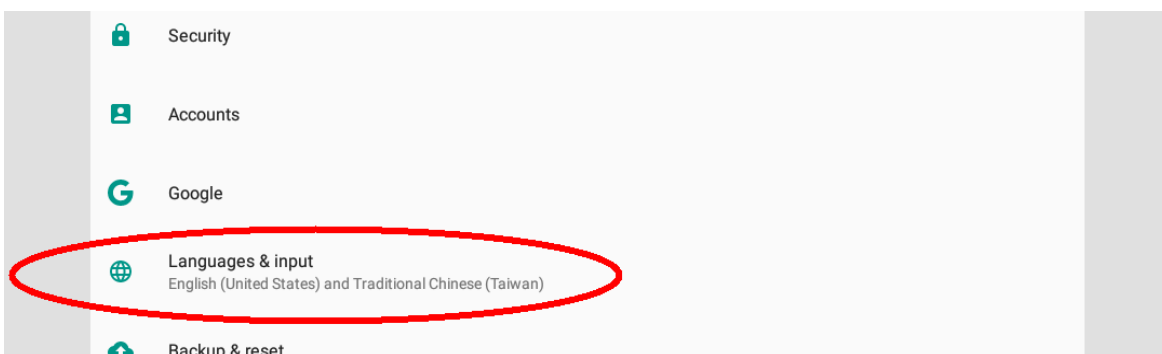



4. Click on Virtual Keyboard

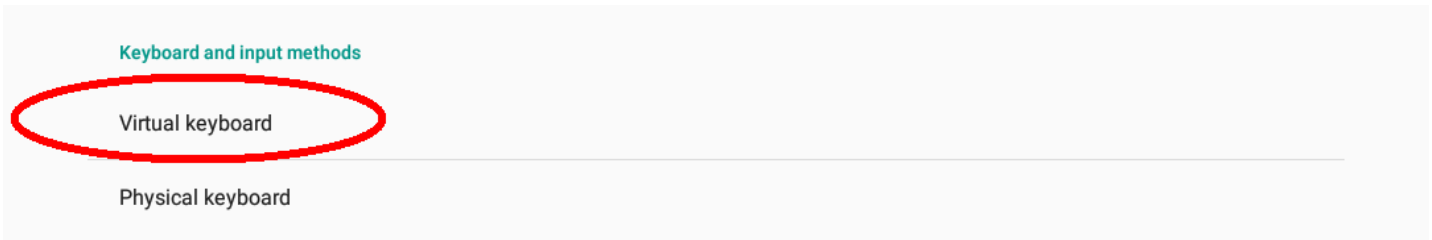

5. Click on Manage Keyboards

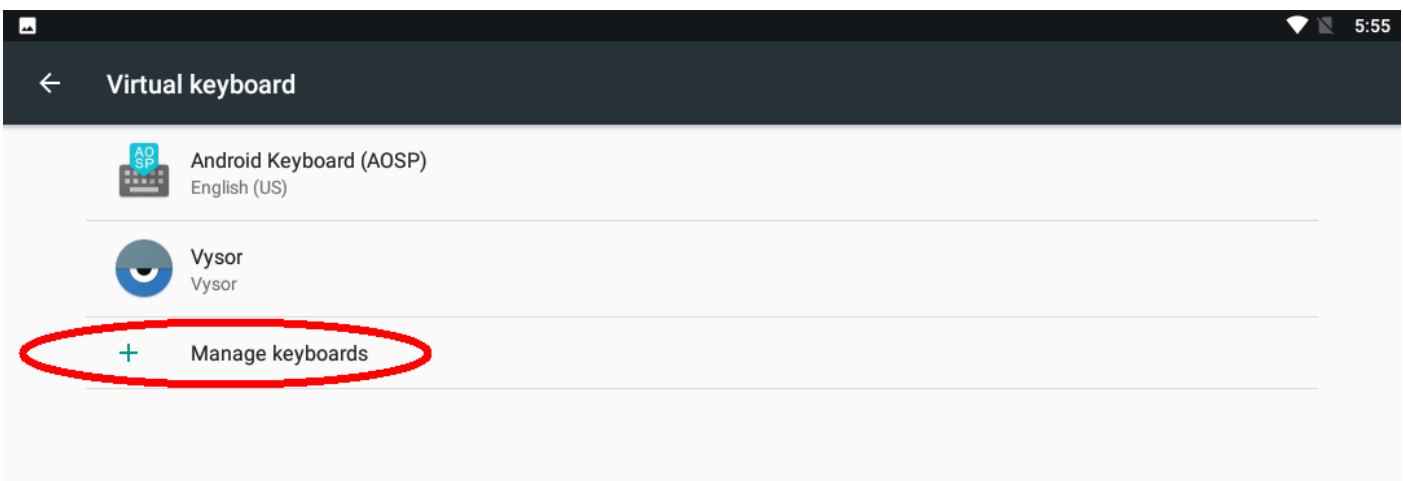

6. Enable Gboard

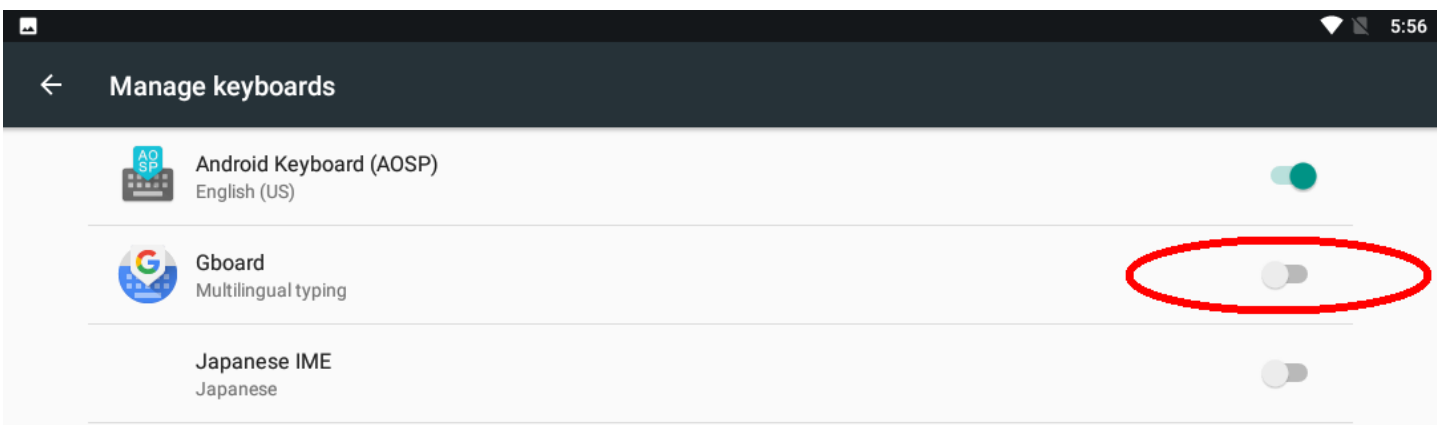



# MAR A

BY REFLIKO

7. Click OK to allow Gboard to be used

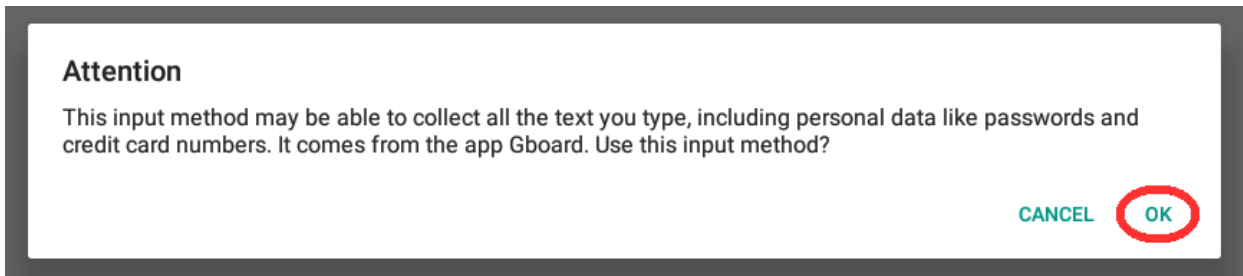

8. Swipe from Left of Screen

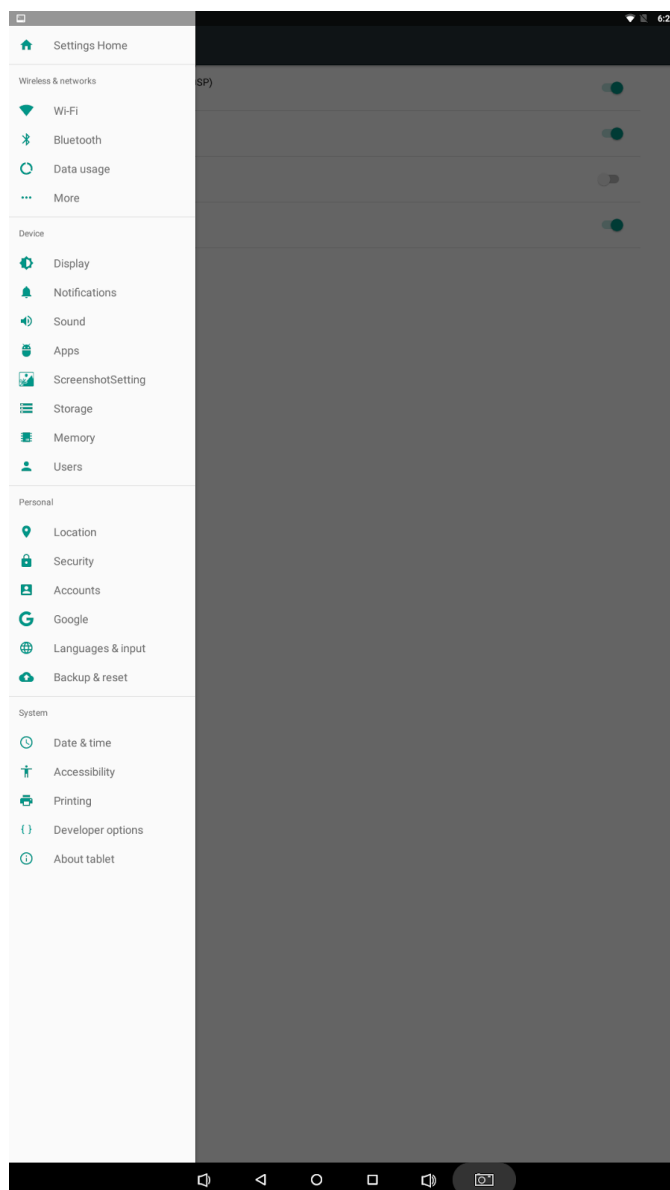



# MARA

BY REFLIKO

9. Click on Settings Home

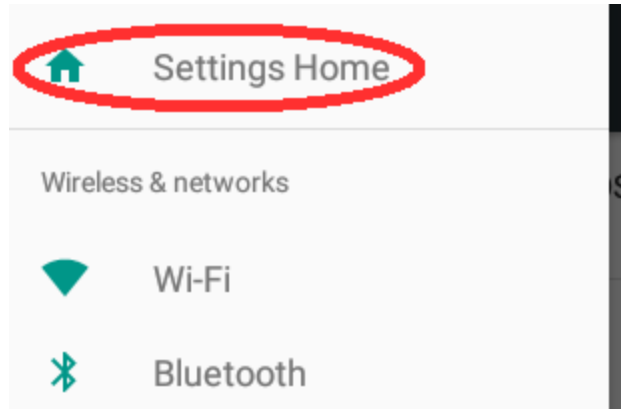

10. Click on the Search Icon

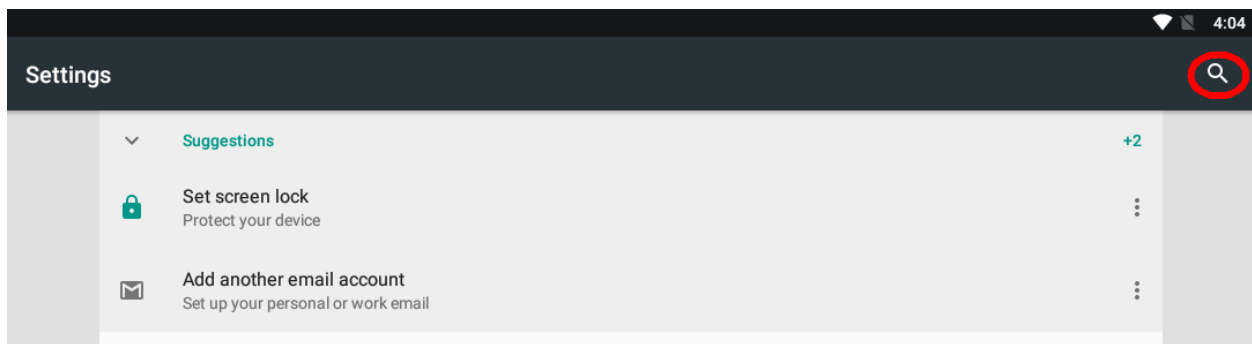

11. Select the keyboard option

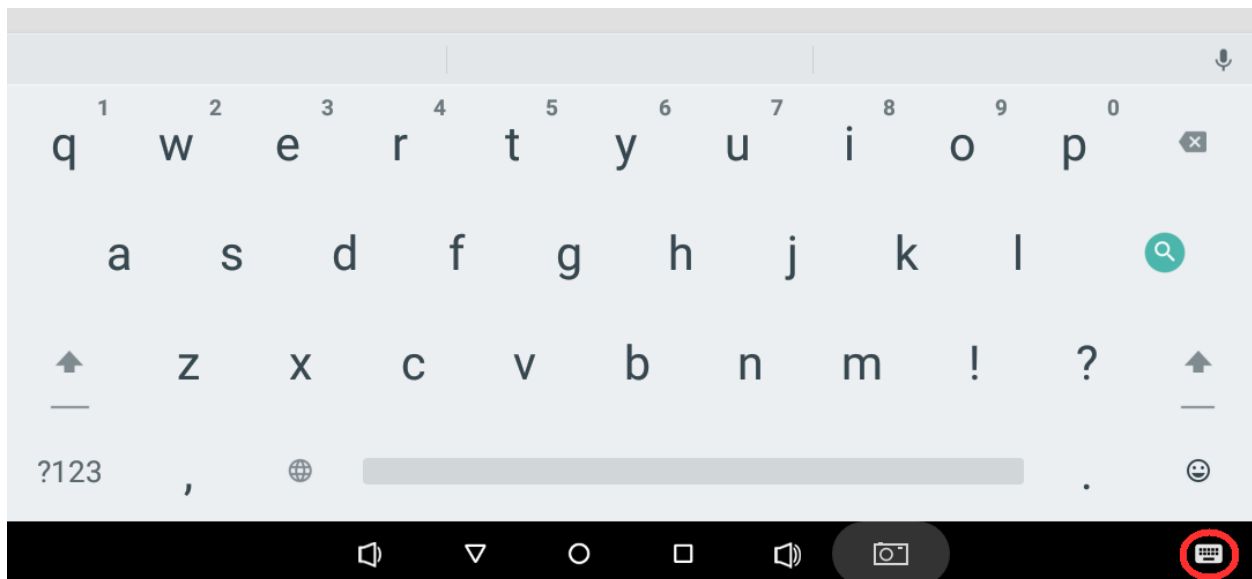



# MARA

BY REFLIKO

12. Enable GBoard



13. Click on the Google logo until you see the ellipsis

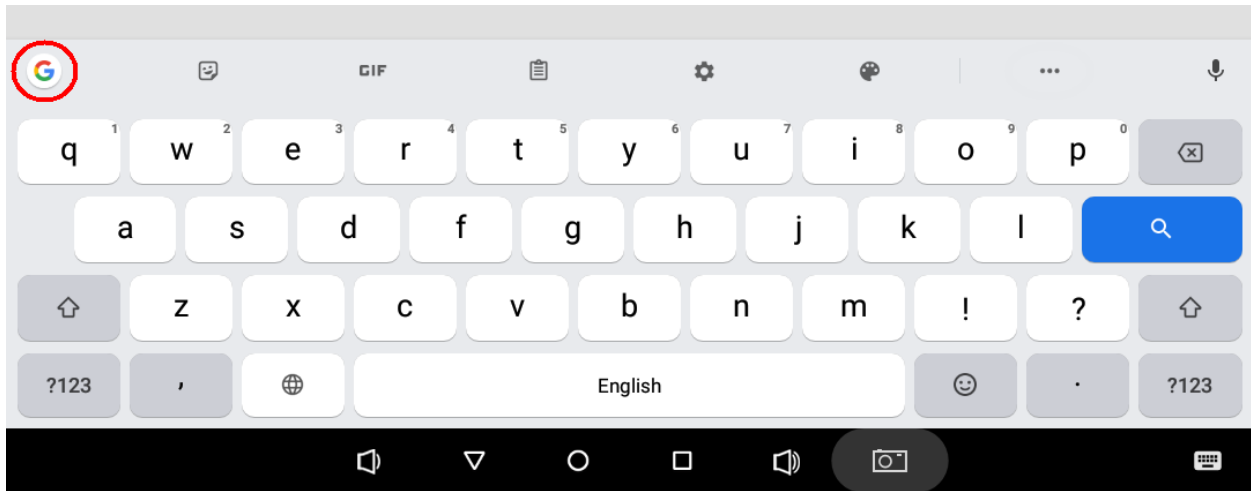

14. Click on the ellipsis

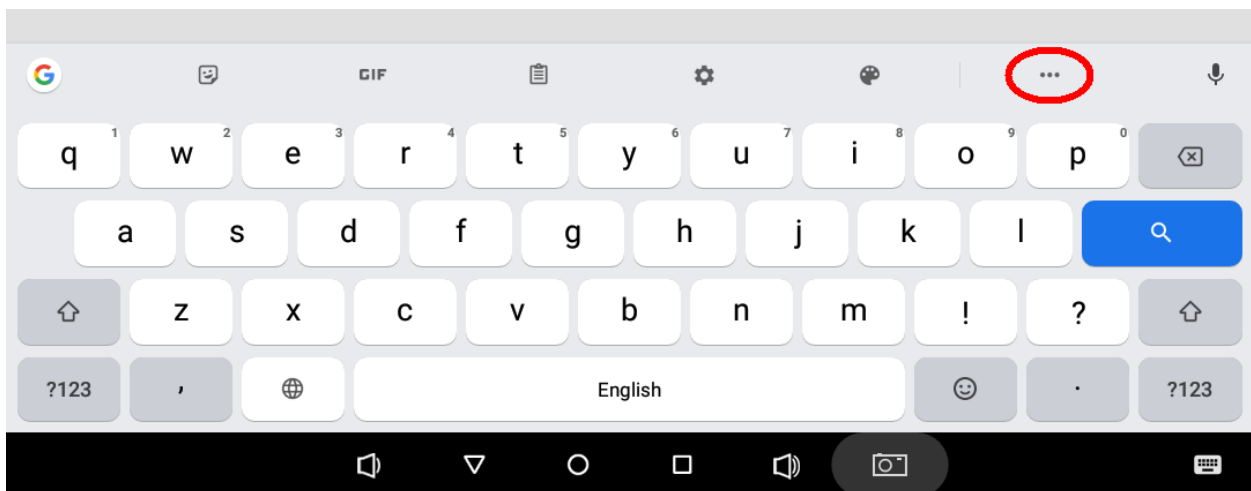



# M A R A

BY REFLIKO

15. Click on Floating

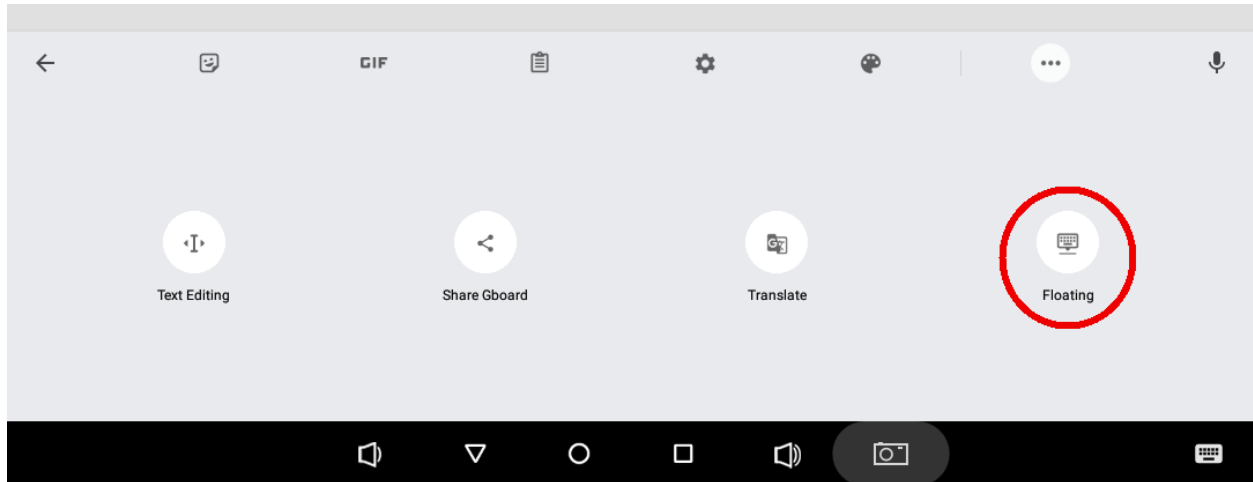



# M A R A

BY REFLIKO

16. Keyboard should now be floating

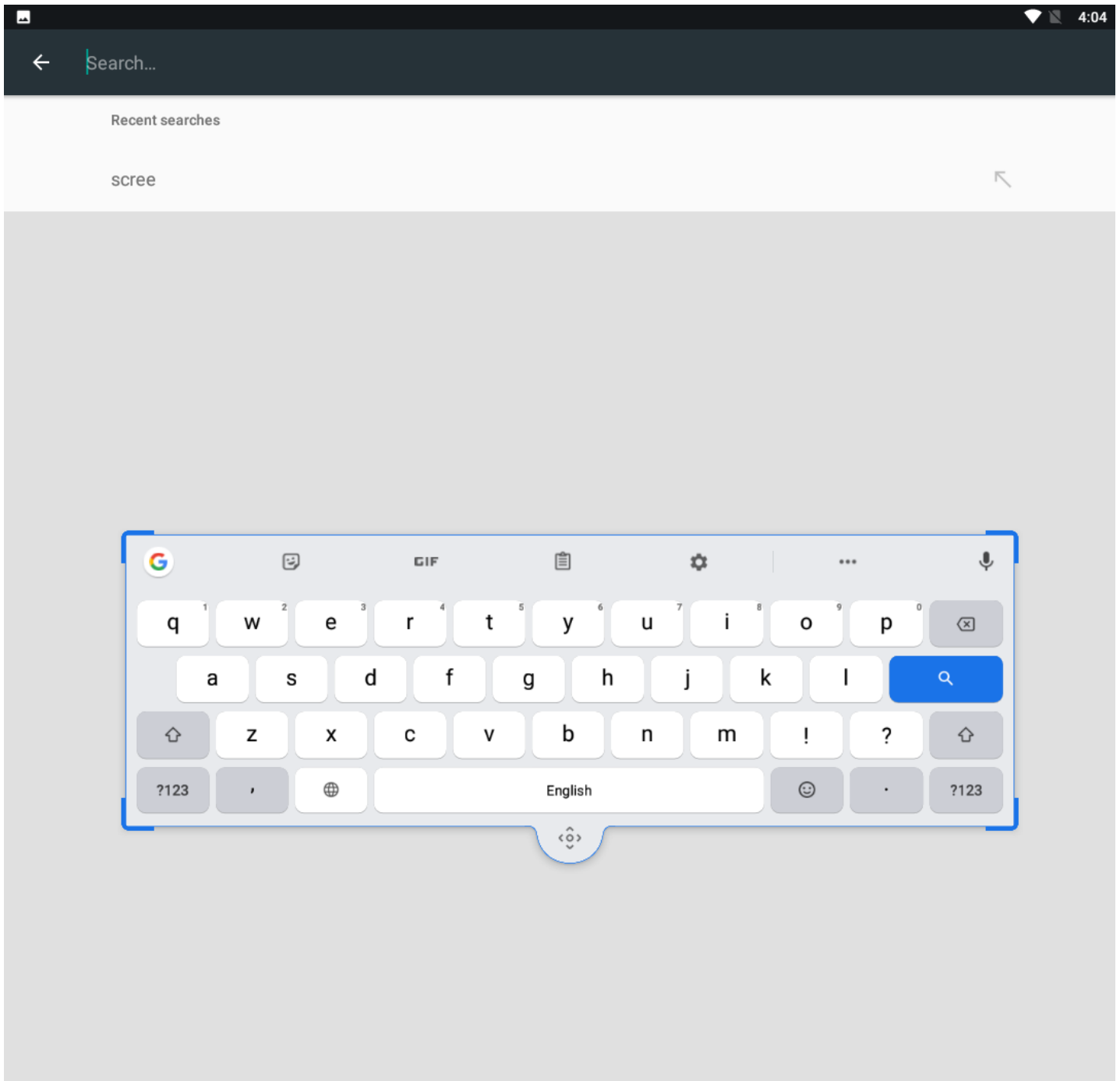



# M A R A

BY REFLIKO

## Android 7 Nougat

REFLIKO MARA runs on “Pure and Stock” Android 7 Nougat.

This means you get the ideal experience as the operating system was originally designed and intended.

There are a number of available tutorials on how to use Android that can be found online by searching keywords “Android 7 tutorial”

Here are some of our suggested tutorials:

Written: <https://www.androidauthority.com/android-7-0-features-673002/>

Video: <https://www.youtube.com/watch?v=6JKve8YLwu4>

For iOS users: <https://www.youtube.com/watch?v=Fg05ZPfyEyA>

## How to Login to App Store

How to add account to MARA: <https://support.google.com/googleplay/answer/2521798?hl=en>

## How to Download and Install Apps

How to download and install apps to MARA:

[https://support.google.com/googleplay/answer/113409?hl=en&ref\\_topic=2450266#](https://support.google.com/googleplay/answer/113409?hl=en&ref_topic=2450266#)



# M A R A

BY REFLIKO

## TECHNICAL SPECIFICATIONS

M A R A BY REFLIKO

### The specs.

- 73" Mirror Glass
- 43" HD Touch Display
- Pure Android 7
- HD Front Camera
- Omni-Directional Microphone
- Dual Speakers
- Wifi, ethernet, Bluetooth
- 32GB Storage
- 4GB RAM
- Hexa-core 64-bit ARM CPU
- Install millions of Android apps
- Dimensions: W24" x H69" x D16"
- Weight 99 lbs







# M A R A

BY REFLIKO

## Seeing is believing.

The HD camera with wide field view gives video calls extra depth and dimensionality.  
The hardwired green-light LED *always* lets you know when the camera is on.  
The omnidirectional mic lets you talk naturally from any angle and still come through loud and clear.

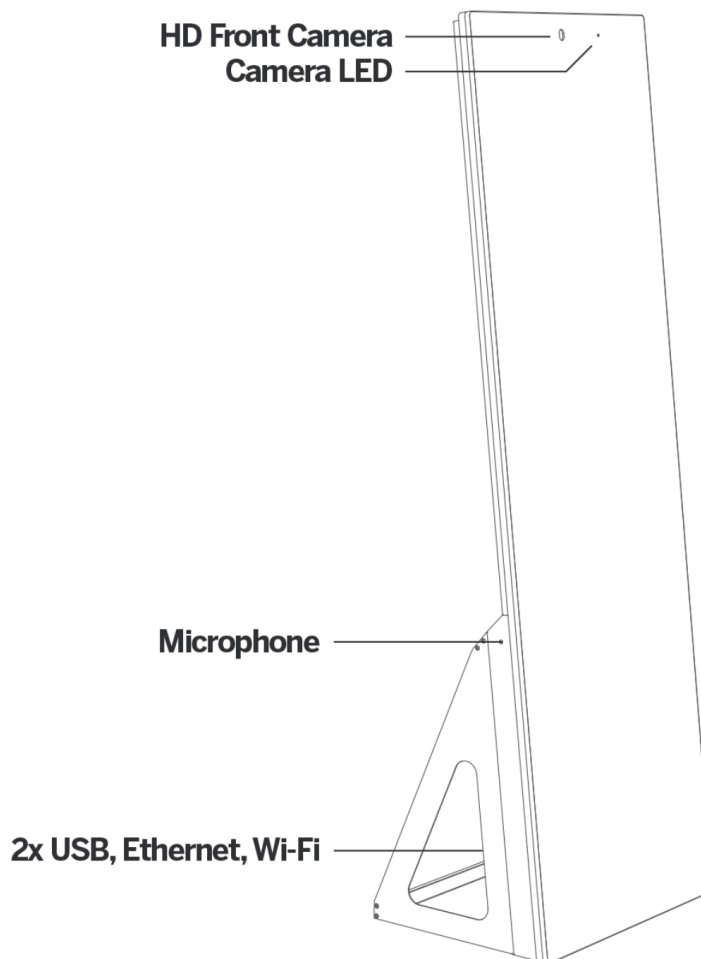



M A R A  
BY REFLIKO

## Important Safety Instructions

When using an electrical appliance, basic precautions should always be followed, including the following:

Read all instructions before using the REFLIKO MARA.

### Danger - To reduce the risk of electric shock:

Always unplug this appliance from the electrical outlet immediately after using and before cleaning.

### Warning - To reduce the risk of burns, fire, electric shock, or injury to persons:

1. An appliance should never be left unattended when plugged in. Unplug from outlet when not in use, and before putting on or taking off parts.
2. Do not operate under blanket or pillow. Excessive heating can occur and cause fire, electric shock or injury to persons.
3. This appliance is not intended for use by persons with reduced physical, sensory or mental capabilities, or lack of experience and knowledge, unless they have been given supervision or instruction concerning use of the appliance by a person responsible for their safety. Keep children under the age of 13 away from this machine.
4. Use this appliance only for its intended use as described in this manual. Do not use attachment not recommended by the manufacturer.
5. Never operate this appliance if it has a damaged cord or plug, if it is not working properly, if it has been dropped or damaged, or dropped in water.
6. Do not carry this appliance by the supply cord or use the cord as a handle.
7. Keep the cord away from heated surfaces
8. Never operate the appliance with the air openings blocked.
9. Never drop or insert any object into any opening.
10. Do not use outdoors
11. Do not operate where aerosol spray products are being used or where oxygen is being administered.



# M A R A

BY REFLIKO

## Warnings

1. Always ensure that the REFLIKO MARA is wiped down after each use to keep it sanitary.
2. Cleaning and user maintenance shall not be made by children without supervision.
3. This appliance is suitable for moderate climates only.
4. The ventilation must not be impaired by covering the appliance with items such as newspapers, table cloths, curtains, etc.
5. Naked flame sources, such as candles, must not be placed on appliance.
6. In case of broken cords or plugs, the cable must be replaced.
7. The appliance is suitable for indoor use only.

## Cleaning REFLIKO MARA

While cleaning your REFLIKO MARA, use a clean microfiber or soft cloth to wipe down the mirror. Avoid using cleaning fluids as this could damage the oleophobic coating on the glass.

This device complies with Part 15 of the FCC Rules. Operation is subject to the following two conditions: (1) this device may not cause harmful interference, and (2) this device must accept any interference received, including interference that may cause undesired operation

NOTE: This equipment has been tested and found to comply with the limits for a Class B digital device, pursuant to Part 15 of the FCC Rules. These limits are designed to provide reasonable protection against harmful interference in a residential installation. This equipment generates, uses and can radiate radio frequency energy and, if not installed and used in accordance with the instructions, may cause harmful interference to radio communications. However, there is no guarantee that interference will not occur in a particular installation. If this equipment does cause harmful interference to radio or television reception, which can be determined by turning the equipment off and on, the user is encouraged to try to correct the interference by one or more of the following measures:

- Reorient or relocate the receiving antenna.
- Increase the separation between the equipment and receiver.
- Connect the equipment into an outlet on a circuit different from that to which the receiver is connected.
- Consult the dealer or an experienced radio/TV technician for help.

Warning: changes or modifications not expressly approved by the party responsible for compliance could void the user's authority to operate the equipment

Radiation exposure statement: this equipment complies with FCC radiation exposure limits set forth for uncontrolled environments. This equipment should be installed and operated with a minimum distance of 20cm between the radiator and your body.