



TEST REPORT

Report Reference No...... : **CHTEW20060097** Report Verification: 

Project No...... : **SHT2005010401EW**

FCC ID..... : **2AWG5-AO02**

Applicant's name..... : **Balwick S.A.**

Address..... : Ruta 8 KM 17500 deposito #33, zona america, Montevideo, Uruguay

Manufacturer..... : DONGGUAN IPRODA TECHNOLOGY CO.,LTD

Address..... : DONGGUAN FACTORY ADDRESS No.99,C Building,Yadinan 1st Road,Shanhe Village,Qiaotou Town,Dongguan City,Guangdong province,China

Test item description : **A2169**

Trade Mark : Balwick S.A.

Model/Type reference..... : AO02

Listed Model(s) : -

Standard : **47 CFR FCC Part 15 Subpart B**

Date of receipt of test sample..... : May. 20, 2020

Date of testing..... : May. 21, 2020- Jun. 12, 2020

Date of issue..... : Jun. 13, 2020

Result..... : **Pass**

Compiled by
 (position+printed name+signature)..: File administrators Silvia Li 

Supervised by
 (position+printed name+signature)..: Project Engineer Chengxiao 

Approved by
 (position+printed name+signature)..: RF Manager Hans Hu 

Testing Laboratory Name : **Shenzhen Huatongwei International Inspection Co., Ltd.**

Address..... : 1/F, Bldg 3, Hongfa Hi-tech Industrial Park, Genyu Road, Tianliao, Gongming, Shenzhen, China

Shenzhen Huatongwei International Inspection Co., Ltd. All rights reserved.

This publication may be reproduced in whole or in part for non-commercial purposes as long as the Shenzhen Huatongwei International Inspection Co., Ltd. is acknowledged as copyright owner and source of the material. Shenzhen Huatongwei International Inspection Co., Ltd. takes no responsibility for and will not assume liability for damages resulting from the reader's interpretation of the reproduced material due to its placement and context.

The test report merely corresponds to the test sample.

Contents

1.	<u>TEST STANDARDS AND REPORT VERSION</u>	<u>3</u>
1.1.	Test Standards	3
1.2.	Report version information	3
2.	<u>TEST DESCRIPTION</u>	<u>4</u>
3.	<u>SUMMARY.....</u>	<u>5</u>
3.1.	Client Information	5
3.2.	Product Description	5
3.3.	EUT operation mode	5
3.4.	Support unit used in test configuration	5
4.	<u>TEST ENVIRONMENT</u>	<u>6</u>
4.1.	Address of the test laboratory	6
4.2.	Test Facility	6
4.3.	Environmental conditions	7
4.4.	Statement of the measurement uncertainty	7
4.5.	Equipments Used during the Test	8
5.	<u>TEST CONDITIONS AND RESULTS</u>	<u>9</u>
5.1.	Conducted Emissions Test	9
5.2.	Radiated Emissions Test	12
6.	<u>TEST SETUP PHOTOS OF THE EUT</u>	<u>16</u>
7.	<u>EXTERNAL AND INTERNAL PHOTOS OF THE EUT</u>	<u>17</u>

1. TEST STANDARDS AND REPORT VERSION

1.1. Test Standards

The tests were performed according to following standards:

[47 CFR FCC Part 15 Subpart B](#) - Unintentional Radiators

[ANSI C63.4: 2014](#) – American National Standard for Methods of Measurement of Radio-Noise Emissions from Low-Voltage Electrical and Electronic Equipment in the Range of 9 kHz to 40GHz

1.2. Report version information

Revision No.	Date of issue	Description
N/A	2020-06-12	Original

2. TEST DESCRIPTION

Test Item	Section in CFR 47	Result	Test Engineer
Conducted Emissions	15.107(a)	PASS	Jianquan Wu
Radiated Emissions	15.109(a)	PASS	Pan Xie

Note: The measurement uncertainty is not included in the test result.

3. SUMMARY

3.1. Client Information

Applicant:	Balwick S.A.
Address:	Ruta 8 KM 17500 deposito #33, zona america, Montevideo, Uruguay
Manufacturer:	DONGGUAN IPRODA TECHNOLOGY CO.,LTD
Address:	DONGGUAN FACTORY ADDRESS No.99,C Building,Yadinan 1st Road,Shanhe Village,Qiaotou Town,Dongguan City,Guangdong province,China

3.2. Product Description

Name of EUT:	A2169
Trade Mark:	Balwick S.A.
Model No.:	AO02
Listed Model(s)	-
Power supply:	DC 12V
Adapter information:	Model:YQ-1203000 Input: AC100-240V, 50/60Hz 1.0A Output: 12Vdc,3.0A

3.3. EUT operation mode

Test mode	Describe
USB 3.0 Data exchange	Keep the EUT in Data exchange with U disk
LAN Data exchange	Keep the EUT in Data exchange with PC status
Playing Video	Keep the EUT in Video Playing status
SD card Data exchange	Keep the EUT in Data exchange with SD card
HDMI Playing	Keep the EUT in Video Playing with monitor

Pre-scan all of above modes. Only show Playing Video mode which is the worst case on the report.

3.4. Support unit used in test configuration

Item	Equipment	Manufacturer	Model No.	FCC ID / FCC DoC	Data Cable	Power Cord
1	PC	DELL	OptiPlex 3020 MT	FCC DoC	N/A	Unshielded 1.8m
2	Monitor	DELL	E1912Hf	FCC DoC	N/A	Unshielded 1.8m
3	Keyboard	DELL	SK8115	FCC DoC	Unshielded, 1.5m	N/A
4	Mouse	DELL	MS111-T	FCC DoC	Unshielded, 1.5m	N/A

4. TEST ENVIRONMENT

4.1. Address of the test laboratory

Laboratory: Shenzhen Huatongwei International Inspection Co., Ltd.

Address: 1/F, Bldg 3, Hongfa Hi-tech Industrial Park, Genyu Road, Tianliao, Gongming, Shenzhen, China

Phone: 86-755-26748019 Fax: 86-755-26748089

4.2. Test Facility

The test facility is recognized, certified, or accredited by the following organizations:

CNAS-Lab Code: L1225

Shenzhen Huatongwei International Inspection Co., Ltd. has been assessed and proved to be in compliance with CNAS-CL01 Accreditation Criteria for Testing and Calibration Laboratories (identical to ISO/IEC17025: 2005 General Requirements) for the Competence of Testing and Calibration Laboratories.

A2LA-Lab Cert. No. 3902.01

Shenzhen Huatongwei International Inspection Co., Ltd. EMC Laboratory has been accredited by A2LA for technical competence in the field of electrical testing, and proved to be in compliance with ISO/IEC 17025: 2005 General Requirements for the Competence of Testing and Calibration Laboratories and any additional program requirements in the identified field of testing.

FCC-Registration No.: 762235

Shenzhen Huatongwei International Inspection Co., Ltd. EMC Laboratory has been registered and fully described in a report filed with the FCC (Federal Communications Commission). The acceptance letter from the FCC is maintained in our files. Registration 762235.

IC-Registration No.: 5377A

Two 3m Alternate Test Site of Shenzhen Huatongwei International Inspection Co., Ltd. has been registered by Certification and Engineering Bureau of Industry Canada for the performance of radiated measurements with Registration No. 5377A.

ACA

Shenzhen Huatongwei International Inspection Co., Ltd. EMC Laboratory can also perform testing for the Australian C-Tick mark as a result of our A2LA accreditation.

4.3. Environmental conditions

During the measurement the environmental conditions were within the listed ranges:

Temperature:	15~35°C
Relative Humidity:	30~60 %
Air Pressure:	950~1050mba

4.4. Statement of the measurement uncertainty

The data and results referenced in this document are true and accurate. The reader is cautioned that there may be errors within the calibration limits of the equipment and facilities. The measurement uncertainty was calculated for all measurements listed in this test report acc. to CISPR 16 - 4 „Specification for radio disturbance and immunity measuring apparatus and methods – Part 4: Uncertainty in EMC Measurements“ and is documented in the Shenzhen Huatongwei International Inspection Co., Ltd quality system acc. to DIN EN ISO/IEC 17025. Furthermore, component and process variability of devices similar to that tested may result in additional deviation. The manufacturer has the sole responsibility of continued compliance of the device.

Hereafter the best measurement capability for Shenzhen Huatongwei laboratory is reported:

Test	Range	Measurement Uncertainty	Notes
Radiated Emissions	30~1000MHz	4.90 dB	(1)
Radiated Emissions	1~18GHz	4.96 dB	(1)
Conducted Disturbance	0.15~30MHz	3.02 dB	(1)

(1) This uncertainty represents an expanded uncertainty expressed at approximately the 95% confidence level using a coverage factor of $k=1.96$.

4.5. Equipments Used during the Test

● Conducted Emission							
Used	Test Equipment	Manufacturer	Equipment No.	Model No.	Serial No.	Last Cal. Date (YY-MM-DD)	Next Cal. Date (YY-MM-DD)
●	Shielded Room	Albatross projects	HTWE0114	N/A	N/A	2018/09/28	2023/09/27
●	EMI Test Receiver	R&S	HTWE0111	ESCI	101247	2019/10/26	2020/10/25
●	Artificial Mains	SCHWARZBECK	HTWE0113	NNLK 8121	573	2019/10/23	2020/10/22
●	Pulse Limiter	R&S	HTWE0033	ESH3-Z2	100499	2019/10/23	2020/10/22
●	RF Connection Cable	HUBER+SUHNER	HTWE0113-02	ENVIROFLE X_142	EF-NM-BNCM-2M	2019/10/23	2020/10/22
●	Test Software	R&S	N/A	ES-K1	N/A	N/A	N/A

● Radiated emission-6th test site							
Used	Test Equipment	Manufacturer	Equipment No.	Model No.	Serial No.	Last Cal. Date (YY-MM-DD)	Next Cal. Date (YY-MM-DD)
●	Semi-Anechoic Chamber	Albatross projects	HTWE0127	SAC-3m-02	C11121	2018/09/30	2021/09/29
●	EMI Test Receiver	R&S	HTWE0099	ESCI	100900	2019/10/26	2020/10/25
●	Loop Antenna	R&S	HTWE0170	HFH2-Z2	100020	2018/04/02	2021/04/01
●	Ultra-Broadband Antenna	SCHWARZBECK	HTWE0119	VULB9163	546	2018/04/04	2021/04/03
●	Pre-Amplifier	SCHWARZBECK	HTWE0295	BBV 9742	N/A	2019/11/14	2020/11/13
●	RF Connection Cable	HUBER+SUHNER	HTWE0062-01	N/A	N/A	2019/08/21	2020/08/20
●	RF Connection Cable	HUBER+SUHNER	HTWE0062-02	SUCOFLEX 104	501184/4	2020/05/27	2021/05/26
●	Test Software	R&S	N/A	ES-K1	N/A	N/A	N/A

● Radiated emission-7th test site							
Used	Test Equipment	Manufacturer	Equipment No.	Model No.	Serial No.	Last Cal. Date (YY-MM-DD)	Next Cal. Date (YY-MM-DD)
●	Semi-Anechoic Chamber	Albatross projects	HTWE0122	SAC-3m-01	N/A	2018/09/27	2021/09/26
●	Spectrum Analyzer	R&S	HTWE0098	FSP40	100597	2019/10/26	2020/10/25
●	Horn Antenna	SCHWARZBECK	HTWE0126	9120D	1011	2020/04/01	2023/03/31
●	Horn Antenna	SCHWARZBECK	HTWE0103	BBHA9170	25841	2018/10/11	2021/10/10
●	Broadband Horn Antenna	SCHWARZBECK	HTWE0103	BBHA9170	BBHA9170472	2018/10/11	2021/10/10
●	Pre-amplifier	CD	HTWE0071	PAP-0102	12004	2019/11/14	2020/11/13
●	Broadband Pre-amplifier	SCHWARZBECK	HTWE0201	BBV 9718	9718-248	2020/05/23	2021/05/22
●	RF Connection Cable	HUBER+SUHNER	HTWE0120-01	6m 18GHz S Serisa	N/A	2020/05/10	2021/05/09
●	RF Connection Cable	HUBER+SUHNER	HTWE0120-02	6m 3GHz RG Serisa	N/A	2020/05/10	2021/05/09
●	RF Connection Cable	HUBER+SUHNER	HTWE0120-03	6m 3GHz RG Serisa	N/A	2020/05/10	2021/05/09
●	RF Connection Cable	HUBER+SUHNER	HTWE0120-04	6m 3GHz RG Serisa	N/A	2020/05/10	2021/05/09
●	RF Connection Cable	HUBER+SUHNER	HTWE0121-01	6m 18GHz S Serisa	N/A	2020/05/10	2021/05/09
●	Test Software	Audix	N/A	E3	N/A	N/A	N/A

5. TEST CONDITIONS AND RESULTS

5.1. Conducted Emissions Test

LIMIT

FCC CFR Title 47 Part 15 Subpart B Section 15.107:

Frequency range (MHz)	Limit (dBuV)	
	Quasi-peak	Average
0.15-0.5	66 to 56*	56 to 46*
0.5-5	56	46
5-30	60	50

* Decreases with the logarithm of the frequency.

TEST CONFIGURATION

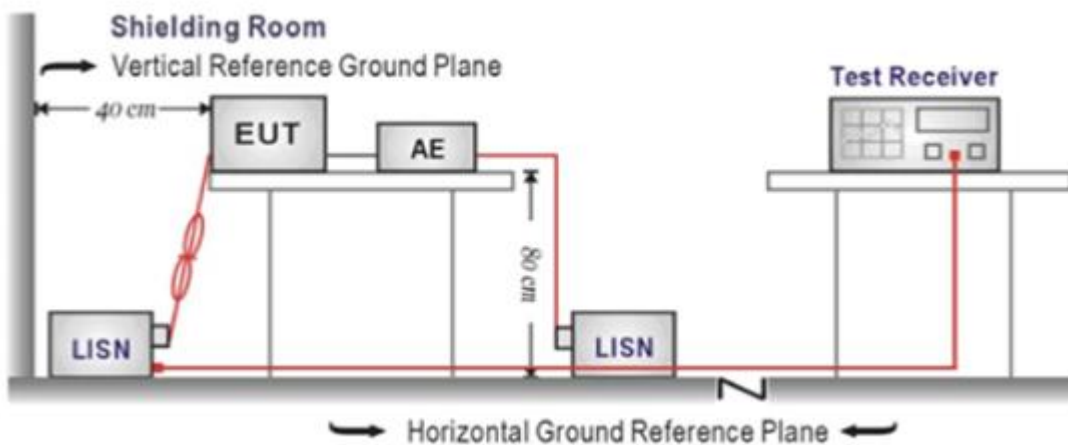

TEST PROCEDURE

1. The EUT was setup according to ANSI C63.4:2014
2. The EUT was placed on a platform of nominal size, 1 m by 1.5 m, raised 10 cm above the conducting ground plane. The vertical conducting plane was located 40 cm to the rear of the EUT. All other surfaces of EUT were at least 10 cm from any other grounded conducting surface.
3. The EUT and simulators are connected to the main power through a line impedance stabilization network (LISN). The LISN provides a 50ohm / 50uH coupling impedance for the measuring equipment.
4. The peripheral devices are also connected to the main power through a LISN. (Please refer to the block diagram of the test setup and photographs)
5. Each current-carrying conductor of the EUT power cord, except the ground (safety) conductor, was individually connected through a LISN to the input power source.
6. The excess length of the power cord between the EUT and the LISN receptacle were folded back and forth at the center of the lead to form a bundle not exceeding 40 cm in length.
7. Conducted emissions were investigated over the frequency range from 0.15MHz to 30MHz using a receiver bandwidth of 9 kHz.
8. During the above scans, the emissions were maximized by cable manipulation.

TEST MODE:

Please refer to the clause 3.3

TEST RESULTS

Passed Not Applicable

Test Line:

L

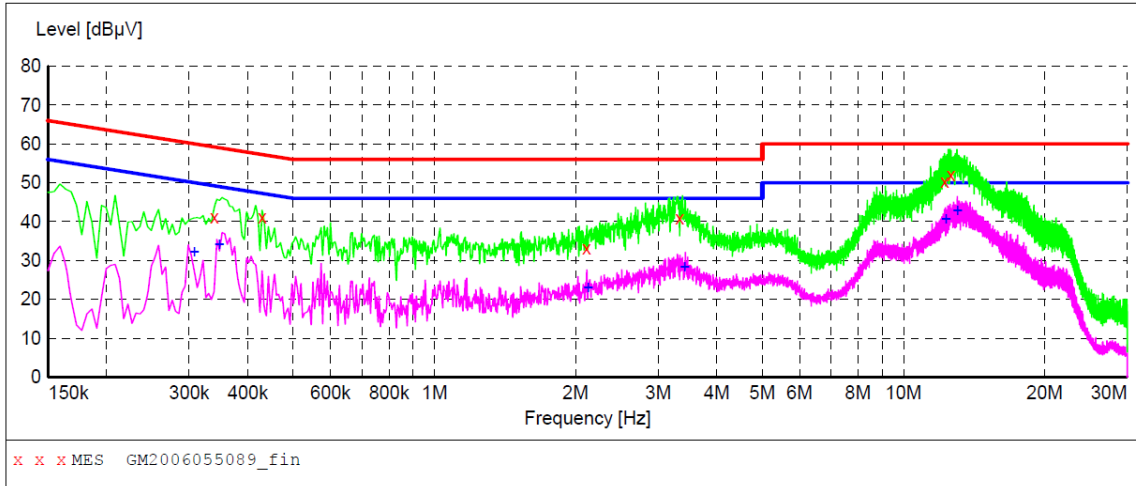

MEASUREMENT RESULT: "GM2006055089_fin"

6/5/2020 5:14PM

Frequency MHz	Level dBµV	Transd dB	Limit dBµV	Margin dB	Detector	Line	PE
0.339000	41.10	10.1	59	18.1	QP	L1	GND
0.429000	41.20	10.1	57	16.1	QP	L1	GND
2.107500	33.10	10.1	56	22.9	QP	L1	GND
3.331500	40.80	10.2	56	15.2	QP	L1	GND
12.223500	50.20	10.4	60	9.8	QP	L1	GND
12.606000	52.00	10.4	60	8.0	QP	L1	GND

MEASUREMENT RESULT: "GM2006055089_fin2"

6/5/2020 5:14PM

Frequency MHz	Level dBµV	Transd dB	Limit dBµV	Margin dB	Detector	Line	PE
0.307500	32.10	10.1	50	17.9	AV	L1	GND
0.348000	34.10	10.1	49	14.9	AV	L1	GND
2.125500	23.00	10.1	46	23.0	AV	L1	GND
3.417000	28.40	10.2	46	17.6	AV	L1	GND
12.309000	40.60	10.4	50	9.4	AV	L1	GND
13.033500	42.80	10.4	50	7.2	AV	L1	GND

Test Line: N

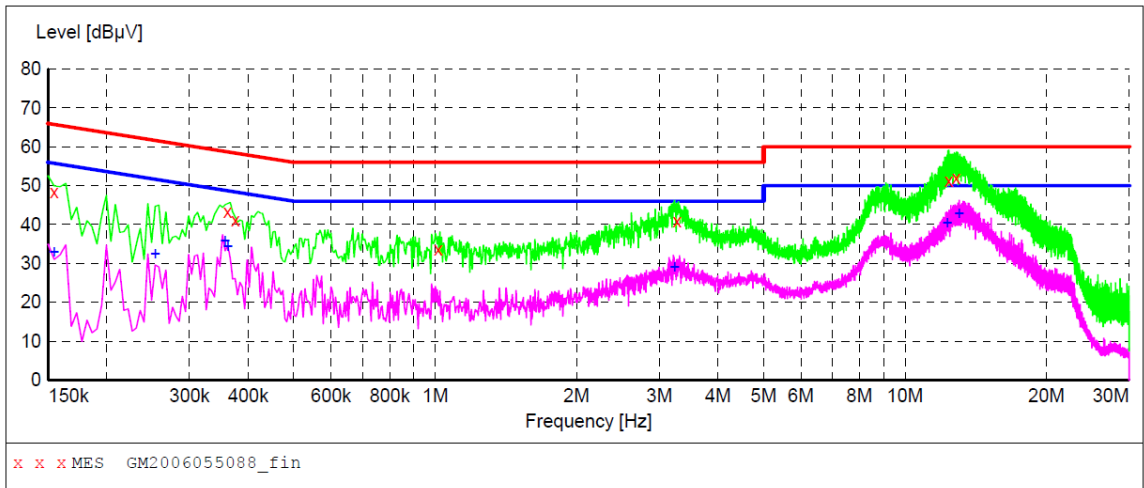

MEASUREMENT RESULT: "GM2006055088_fin"

6/5/2020 5:11PM

Frequency MHz	Level dBµV	Transd dB	Limit dBµV	Margin dB	Detector	Line	PE
0.154500	48.50	10.0	66	17.3	QP	N	GND
0.361500	43.40	10.1	59	15.3	QP	N	GND
0.375000	41.00	10.1	58	17.4	QP	N	GND
1.014000	33.60	10.1	56	22.4	QP	N	GND
3.268500	40.90	10.2	56	15.1	QP	N	GND
12.385500	51.30	10.4	60	8.7	QP	N	GND
12.835500	52.10	10.4	60	7.9	QP	N	GND

MEASUREMENT RESULT: "GM2006055088_fin2"

6/5/2020 5:11PM

Frequency MHz	Level dBµV	Transd dB	Limit dBµV	Margin dB	Detector	Line	PE
0.154500	32.90	10.0	56	22.9	AV	N	GND
0.253500	32.30	10.0	52	19.3	AV	N	GND
0.357000	35.80	10.1	49	13.0	AV	N	GND
0.361500	34.30	10.1	49	14.4	AV	N	GND
3.232500	28.90	10.2	46	17.1	AV	N	GND
12.291000	40.40	10.4	50	9.6	AV	N	GND
13.024500	42.70	10.4	50	7.3	AV	N	GND

5.2. Radiated Emissions Test

LIMIT

FCC CFR Title 47 Part 15 Subpart B Section 15.109

Frequency	Limit (dBuV/m @3m)	Value
30MHz-88MHz	40.00	Quasi-peak
88MHz-216MHz	43.50	Quasi-peak
216MHz-960MHz	46.00	Quasi-peak
960MHz-1GHz	54.00	Quasi-peak
Above 1GHz	54.00	Average
	74.00	Peak

TEST CONFIGURATION

➤ 30MHz ~ 1GHz

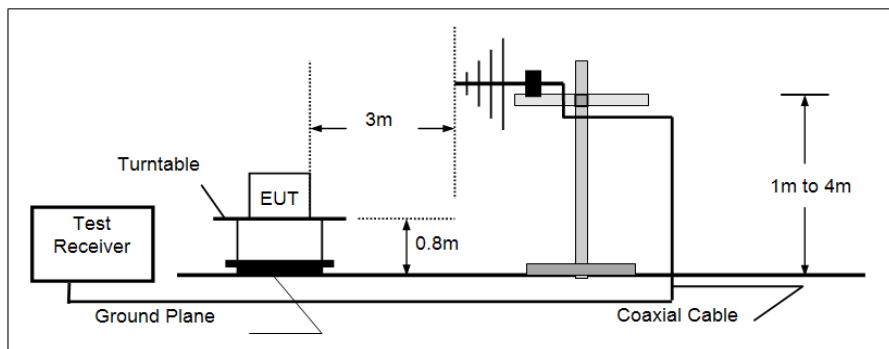

➤ Above 1GHz

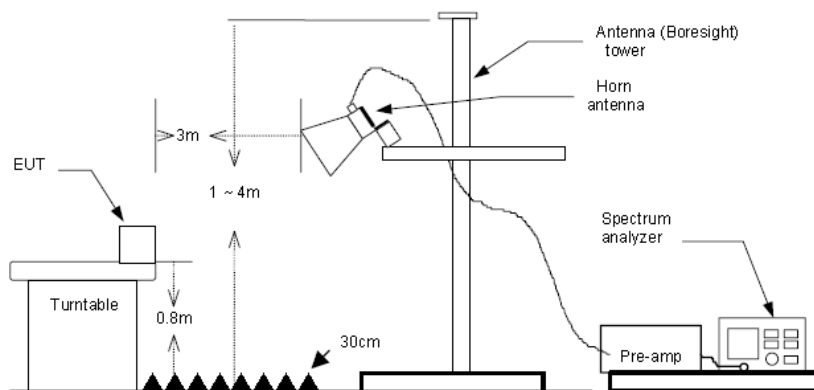

TEST PROCEDURE

- The EUT was tested according to ANSI C63.4:2014.
- The EUT is placed on a turn table which is 0.8 meter above ground.
- The turn table is rotated 360 degrees to determine the position of the maximum emission level.
- The EUT was positioned such that the distance from antenna to the EUT was 3 meters.
- The antenna is scanned from 1 meter to 4 meters to find out the maximum emission level. This is repeated for both horizontal and vertical polarization of the antenna.
- Use the following spectrum analyzer settings
 - Span shall wide enough to fully capture the emission being measured;
 - Below 1GHz,
RBW=120KHz, VBW=300KHz, Sweep=auto, Detector function=peak, Trace=max hold;
If the emission level of the EUT measured by the peak detector is 3 dB lower than the applicable limit, the peak emission level will be reported. Otherwise, the emission measurement will be repeated using the quasi-peak detector and reported.
 - From 1GHz to 5th harmonic, RBW=1MHz, VBW=3MHz

TEST MODE:

Please refer to the clause 3.3

TEST RESULTS

Passed **Not Applicable**

Note: Final Level =Receiver Read level + Antenna Factor + Cable Loss – Preamplifier Factor
The emission levels of frequency above 6GHz are very lower than limit and not show in test report.

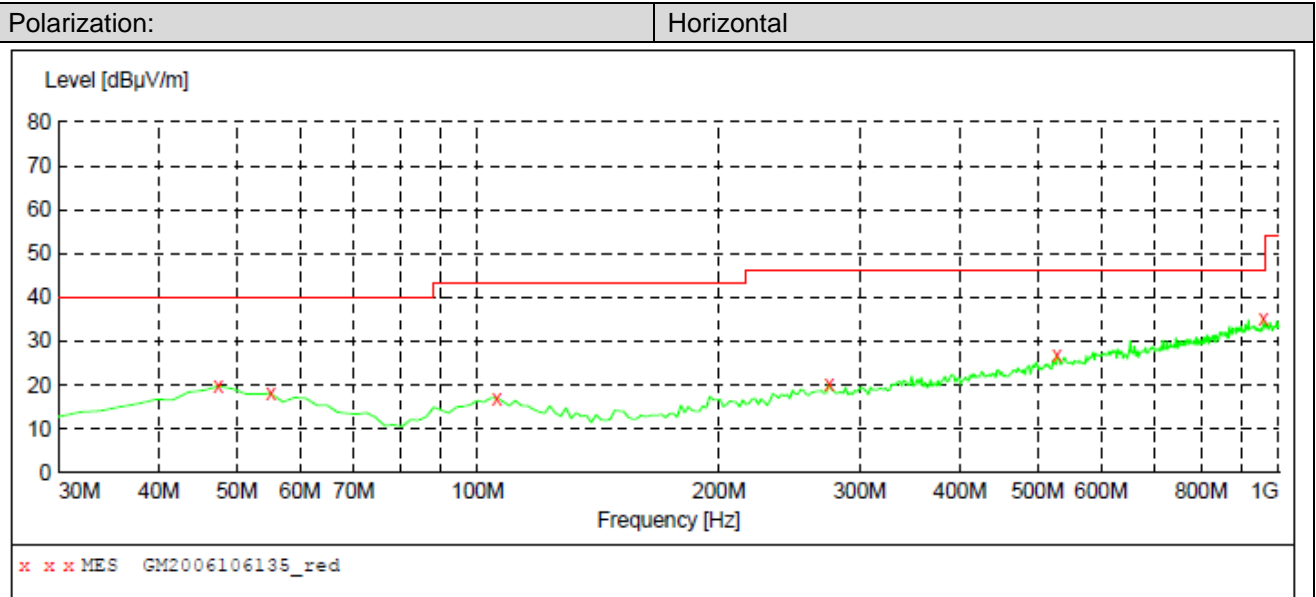

MEASUREMENT RESULT: "GM2006106135_red"

Frequency MHz	Level dBuV/m	Transd dB	Limit dBuV/m	Margin dB	Det.	Height cm	Azimuth deg	Polarization
47.460000	19.80	-8.9	40.0	20.2	QP	100.0	57.00	HORIZONTAL
55.220000	18.10	-9.3	40.0	21.9	QP	100.0	342.00	HORIZONTAL
105.660000	17.10	-10.7	43.5	26.4	QP	100.0	105.00	HORIZONTAL
274.440000	20.10	-8.1	46.0	25.9	QP	100.0	300.00	HORIZONTAL
528.580000	26.70	-1.5	46.0	19.3	QP	100.0	201.00	HORIZONTAL
957.320000	35.00	6.9	46.0	11.0	QP	100.0	71.00	HORIZONTAL

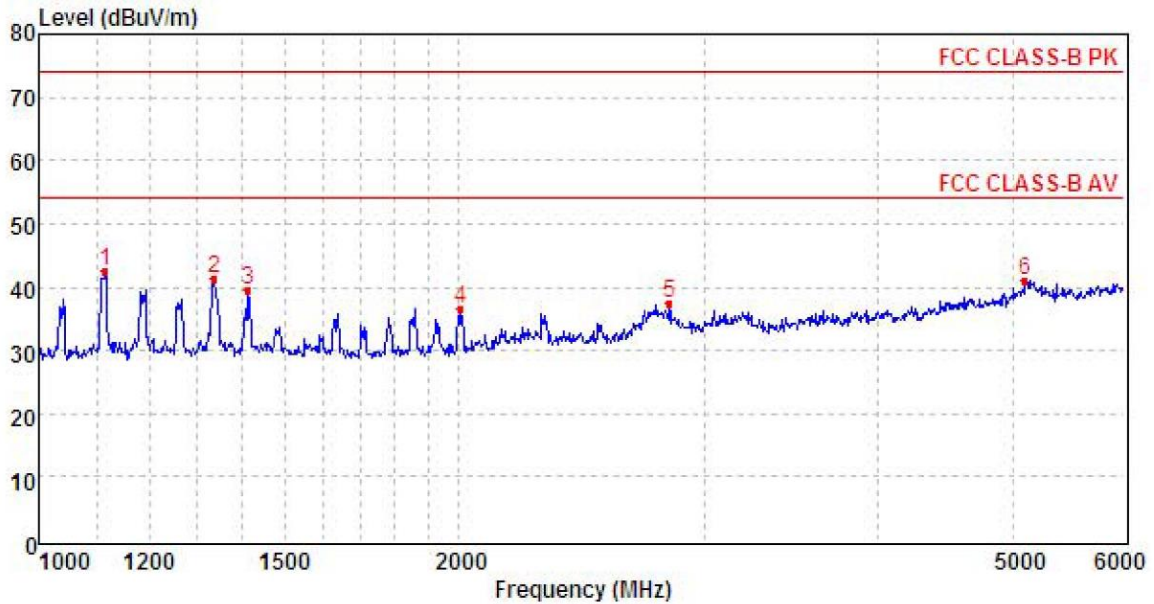

Mark	Frequency MHz	Reading dBuV/m	Antenna dB	Cable dB	Preamp dB	Level dBuV/m	Limit dBuV/m	Over limit	Remark
1	1115.49	49.37	25.40	5.29	37.58	42.48	74.00	-31.52	Peak
2	1336.78	46.48	26.22	5.88	37.28	41.30	74.00	-32.70	Peak
3	1413.13	44.83	26.10	6.06	37.56	39.43	74.00	-34.57	Peak
4	2007.71	41.24	26.16	7.18	38.14	36.44	74.00	-37.56	Peak
5	2832.08	35.83	28.53	8.91	35.80	37.47	74.00	-36.53	Peak
6	5097.29	31.94	32.20	12.03	35.14	41.03	74.00	-32.97	Peak

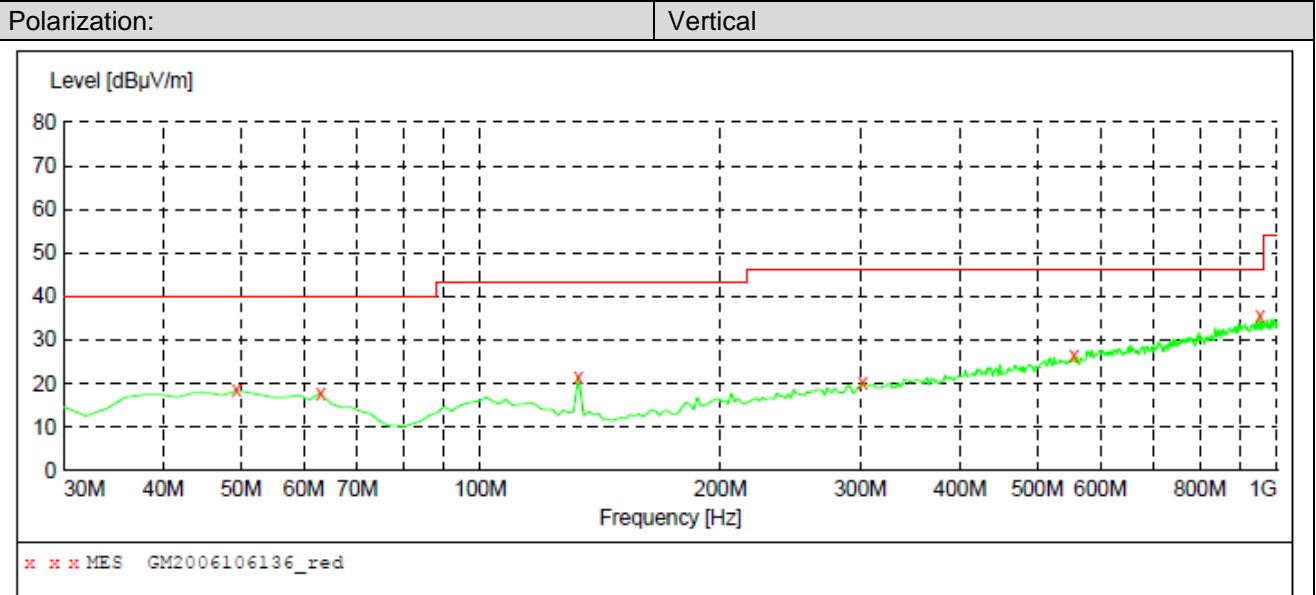

MEASUREMENT RESULT: "GM2006106136_red"

Frequency MHz	Level dBuV/m	Transd dB	Limit dBuV/m	Margin dB	Det.	Height cm	Azimuth deg	Polarization
49.400000	18.50	-8.8	40.0	21.5	QP	100.0	217.00	VERTICAL
62.980000	17.90	-10.9	40.0	22.1	QP	100.0	165.00	VERTICAL
132.820000	21.70	-13.8	43.5	21.8	QP	100.0	360.00	VERTICAL
301.600000	20.40	-7.5	46.0	25.6	QP	100.0	155.00	VERTICAL
555.740000	26.30	-0.9	46.0	19.7	QP	100.0	33.00	VERTICAL
951.500000	35.60	6.9	46.0	10.4	QP	100.0	53.00	VERTICAL

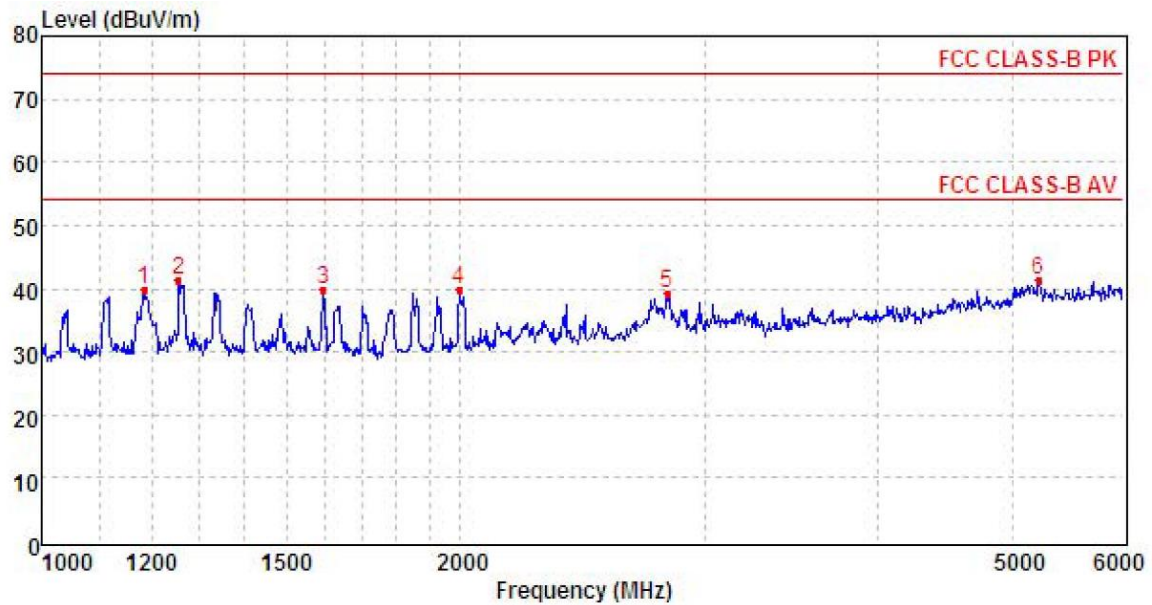

Mark	Frequency MHz	Reading dBuV/m	Antenna dB	Cable dB	Preamp dB	Level dBuV/m	Limit dBuV/m	Over limit	Remark
1	1185.56	46.50	25.54	5.48	37.65	39.87	74.00	-34.13	Peak
2	1255.53	47.47	25.91	5.67	37.65	41.40	74.00	-32.60	Peak
3	1593.38	45.73	25.41	6.38	37.58	39.94	74.00	-34.06	Peak
4	1996.95	44.71	26.09	7.15	38.17	39.78	74.00	-34.22	Peak
5	2816.90	37.17	28.47	8.92	35.39	39.17	74.00	-34.83	Peak
6	5217.42	32.22	31.60	12.11	34.68	41.25	74.00	-32.75	Peak

6. TEST SETUP PHOTOS OF THE EUT

Conducted Emissions (AC Mains)



Radiated Emissions (30MHz-1GHz)



Radiated Emissions (Above 1GHz)

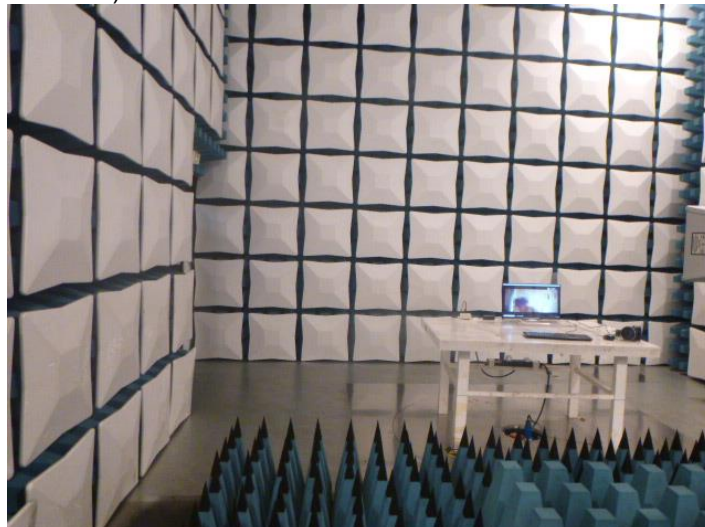

7. **EXTERNAL AND INTERNAL PHOTOS OF THE EUT**

Reference to the test report No.: CHTEW20060093

-----End of Report-----