



BSD3543W User Manual

BT-DA22W/BT-DB22W



About this manual

- This user manual is specially designed to explain functions and features of BT-DA22W/BT-DB22W, and it will be referred as the device hereinafter.
- The user manual provides information for service and safety operation.
- Be sure to read this manual thoroughly before using the device.
- Device specifications or contents of this manual may be changed without prior notice due to upgrade of detector functions.
- Images and screenshots are those of representative model of the series and may differ in appearance from the actual device.
- You are not allowed to reuse or distribute any part of this manual without prior permission.
- Only a physician or a legally certified operator should use this device.
- The device should be maintained in a safe and operable condition by maintenance personnel.
- Use only computers and image display monitors complying with IEC 60601-1 or IEC 60950-1, and under a system configuration complying with IEC 60601-1-1. For details, consult your sales representative.
- Use only the dedicated cables. Do not use any cables other than those supplied with this device.
- In no event shall BONTECH be liable for any damage or loss arising from fire, earthquake, any action or accident by a third party, any intentional or negligent action by users, any trial usage, or other usage under abnormal conditions.
- Roentgenography, image processing, image reading, and image data storage must be performed in accordance with the laws of the country or region in which the device is being used. The user is responsible for maintaining the privacy of image data.
- It is the responsibility of the attending physicians to provide medical care services. BONTECH will not be liable for faulty diagnoses.
- In no event shall BONTECH be liable for direct or indirect consequential damages arising from the use or unavailability of this device.
- BONTECH shall not be liable for any damage arising from moving, alteration, inspection or repair by a person other than authorized service engineers.
- Specifications, composition, and appearance of this device may change without prior notice.
- This product is a medical device.
- Service manuals are provided as hardcopy by default, and may also be provided as softcopy if necessary.

Copyright

This manual is protected under international copyright laws. No part of this manual may be reproduced, distributed, translated or transmitted in any form or by any means, electronic or mechanical, including photocopying, recording, or storing in any information storage and retrieval system, without the prior written permission of BONTECH.

Product specifications or the contents of this manual may be changed without prior notice due to an upgrade of the device's functions.

Trademarks

The BONTECH name and its logo are registered trademarks of BONTECH Co., Ltd.

Table of Contents

Safety Information.....	6
Notes.....	8
General Hazards.....	9
Regulatory.....	11
1. Overview.....	13
Features.....	13
ComponentsDescription.....	14
Detector Configuration.....	16
Labels and Symbols.....	17
2. Notes for Using the Instrument.....	20
3. Description.....	21
General Description.....	21
System Overview.....	22
4. Specifications.....	23
Main Specifications.....	23
5. Components.....	24
Detector (BSD3543W(BT-DA22W/BT-DB22W)).....	25
Control Box (BT-CB02).....	26
Charger.....	26
Battery pack.....	27
Other Accessories.....	27
6. Installation.....	28
Connection.....	28
X-ray Exposure Mode.....	31
Network Setting.....	34
Image Acquisition S/W.....	35

7. Calibration.....	43
General Principle.....	43
Calibration Steps.....	44
8. Acquisition.....	51
Obtaining Images.....	51
Importing Images.....	53
9. Inspection and Maintenance.....	54
10. Service Information.....	56
11. Reference of X-ray Exposure Condition.....	61

Safety Information



The BT-DA22W/BT-DB22W is designed to provide a reasonable protection against harmful interference in a typical medical installation.

If not installed used in accordance with the instructions, it may cause harmful interference to other devices in the vicinity. However, there is no guarantee that interference will not occur in a particular installation. If this Equipment does cause harmful interference to other devices, which can be determined by turning the equipment on and off, the user is encouraged to try correcting the interference by or more of the following measures.

The following safety notices are used to emphasize certain safety instruction. Follow the safety instructions in this manual along with warning and caution symbols. Ignoring such warnings or cautions while handling the device may result in serious injury or accident. It is important to read and understand the contents of this manual before attempting to use the device.

<To use right way for safety>

For Symbols: This Manual contains various symbols not only to use the product correctly but also to protect damages or losses of properties for users or people to be accessed. The marks and meanings are as follows.

 Caution (Attention)	Follow the instruction to avoid situations that could cause injury to yourself or others. (Suivez les instructions pour éviter les situations qui pourraient vous blesser ou blesser les autres.)
 Warning (Avertissement)	If you use the product without care of this mark, you could have possibility to be injured or death by wrong use or you could have incorrect measuring data. (Si vous utilisez le produit sans prendre soin de cette marque, vous pourriez avoir la possibilité d'être blessé ou de mourir par suite d'une mauvaise utilisation ou vous pourriez avoir des données de mesure incorrectes.)

The following safety symbols are found on BSD3543W(BT-DA22W/BT-DB22W) components. Remember them to avoid injury.

Caution(Attention)

- ☒ The device should be installed, maintained, and serviced according to BONTECH's maintenance procedures and by BONTECH's personnel or other qualified maintenance personnel approved in writing by BONTECH. Operation and maintenance should be done in strict compliance with the operation instructions contained in the manuals.
- ☒ L'appareil doit être installé, entretenu et entretenu conformément aux procédures d'entretien de BONTECH et par le personnel de BONTECH ou tout autre personnel d'entretien qualifié approuvé par écrit par BONTECH. L'exploitation et l'entretien doivent se faire en stricte conformité avec les instructions contenues dans les manuels.
- ☒ The system, in whole or in part, cannot be modified in any way without written approval from BONTECH.
- ☒ Le système, en tout ou en partie, ne peut être modifié en aucune façon sans l'autorisation écrite de BONTECH.
- ☒ Prevent unauthorized personnel from access to the system.
- ☒ Empêcher le personnel non autorisé d'accéder au système.

- ⊗ The other product or component which have not approved by BONTECH Co., Ltd, shall not be connected or attached to this product. It could cause disorder or not to protect patient's safety.
- ⊗ L'autre produit ou composant qui n'a pas été approuvé par BONTECH Co., Ltd, ne sera pas relié à ce produit. Elle pourrait causer des troubles ou ne pas protéger la sécurité du patient.
- ⊗ To avoid excessive product leakage current and maintain product compliance to medical protective earth and grounding requirements, the Control box's power code shall be connected directly to a hardwired AC Mains receptacle.
- ⊗ Afin d'éviter une fuite excessive du produit et de maintenir la conformité du produit aux exigences médicales relatives à la terre et à la mise à la terre, le code de puissance de la boîte de commande doit être raccordé directement à un réceptacle à courant alternatif fileté.
- ⊗ The operator must not touch part referred to in signal input and patient simultaneously.
- ⊗ L'opérateur ne doit pas toucher simultanément la partie mentionnée dans l'entrée du signal et dans le patient.
- ⊗ At least 30 minutes of warming up time is needed after power switch is turned on.
- ⊗ Au moins 30 minutes de temps d'échauffement sont nécessaires après que l'interrupteur d'alimentation est mis en marche.
- ⊗ In case of laymen of radiation uses, product can do breakdown and malfunction.
- ⊗ Dans le cas des non-spécialistes de l'utilisation des rayonnements, le produit peut provoquer une panne et un mauvais fonctionnement.

Warning (Avertissement)

- ⊗ Please keep the product away from high temperature or high humidity, and the shock shall be avoided.
- ⊗ S'il vous plaît, tenez le produit à l'écart des températures ou de l'humidité élevées, et évitez le choc.
- ⊗ Please keep the product away from electromagnetic field product (cell phone etc.)
- ⊗ Veuillez garder le produit à l'écart des produits à champ électromagnétique (cellulaire, etc.)
- ⊗ Pay attention to safety state such as slop, vibration, impact. It could cause device malfunction and damage of patient.
- ⊗ Attention à l'état de sécurité tel que pente, vibration, impact. Il pourrait causer un mauvais fonctionnement de l'appareil et endommager le patient.
- ⊗ Do not spray cleaning solution directly on the panel. Instead, motion a cloth with the solution and wire the panel with the clothe.
- ⊗ Ne pas vaporiser la solution de nettoyage directement sur le panneau. Déplacer plutôt un chiffon avec la solution et filtrer le panneau avec le trèfle.
- ⊗ Federal law restricts this device to sale by or on the order of a physician or a licensed practitioner.
- ⊗ La loi fédérale limite la vente de cet instrument par ou sur l'ordre d'un médecin ou d'un praticien autorisé.
- ⊗ Before authorizing any person to operate the system, verify that the person has read and fully understood the User Manual. You should make certain that only properly trained and qualified personnel are authorized to operate the device. An authorized operators list should be maintained.
- ⊗ Avant d'autoriser une personne à faire fonctionner le système, vérifier si elle a lu et bien compris le manuel de l'utilisateur. Vous devez vous assurer que seul le personnel dûment formé et qualifié est autorisé à faire fonctionner l'appareil. Une liste des opérateurs autorisés devrait être tenue à jour.
- ⊗ It is important that this User Manual be kept at hand, studied carefully and reviewed periodically by the authorized operators.
- ⊗ Il est important de garder ce manuel à portée de la main, de l'étudier attentivement et de le réviser

périodiquement par les opérateurs autorisés.

- ☒ You should ensure continuous power supply to the system, with voltage and current according to the product specifications. If power failures are frequent, an Uninterrupted Power Supply (UPS) should be installed to avoid loss of data.
- ☒ Vous devez assurer une alimentation continue du système, avec une tension et un courant conformes aux spécifications du produit. Si les pannes de courant sont fréquentes, un système d'alimentation électrique sans interruption (UPS) devrait être installé pour éviter la perte de données.
- ☒ If the product does not operate properly or if it fails to respond to the controls described in this manual, the operator should immediately contact BONTECH's field service representative.
- ☒ Si le produit ne fonctionne pas correctement ou s'il ne répond pas aux contrôles décrits dans le présent manuel, l'opérateur doit immédiatement communiquer avec le représentant du service extérieur de BONTECH.
- ☒ The user should be aware of the product specifications and of the system's accuracy and stability limitations. These limitations must be considered before making any decision based on quantitative values, in case of doubt, please consult a BONTECH's representative.
- ☒ L'utilisateur doit connaître les spécifications du produit et les limites de précision et de stabilité du système. Ces limites doivent être prises en considération avant de prendre toute décision basée sur des valeurs quantitatives. En cas de doute, veuillez consulter un représentant du BONTECH.
- ☒ The images and calculations provided in this system are intended to be used as tools for the competent user. They are explicitly not to be regarded as a sole incontrovertible basis for clinical diagnosis. Users are encouraged to study the literature and reach their own professional conclusions regarding the clinical utility of the system.
- ☒ Les images et les calculs fournis dans ce système sont destinés à être utilisés comme outils pour l'utilisateur compétent. Elles ne doivent explicitement pas être considérées comme une seule base incontestable pour le diagnostic clinique. Les utilisateurs sont incités à surveiller la documentation et à tirer leurs propres conclusions professionnelles concernant l'utilité clinique du système.
- ☒ Do not install the device in a location with the conditions listed below. Otherwise, it may result in failure, malfunction, fall, cause fire, or injury.
- ☒ N'installez pas l'appareil dans les conditions énumérées ci-dessous. Sinon, elle peut entraîner une défaillance, un mauvais fonctionnement, une chute, un incendie ou une blessure.
 - Close to facilities where water is used.
 - Près des installations où de l'eau est utilisée.
 - Locations exposed to direct sunlight.
 - Lieux exposés à la lumière directe du soleil.
 - Close to air-conditioner or ventilation equipment.
 - Près du climatiseur ou de l'équipement de ventilation.
 - Close to heat source such as a heater.
 - Près d'une source de chaleur comme un chauffe-eau.
 - Prone to vibration.
 - Prononcer aux vibrations.
 - Insecure place.
 - L'insécurité.
 - Dusty environment.
 - Environnement poussiéreux.
 - Saline or sulfurous environment.

- Milieu salin ou sulfuré.
- High humidity
- Haute humidité
- Ambient temperature is higher than the operating temperature stated in User Manual.
- La température ambiante est supérieure à la température de fonctionnement indiquée dans le manuel de l'utilisateur
- ☒ Do not inflict excessive shock and mechanical vibration. Otherwise, it may result in poor image quality caused by noise.
- ☒ N'infligez pas de chocs ou de vibrations mécaniques excessifs. Sinon, la qualité de l'image risque d'être diminuée par le bruit.
- ☒ Do not unscrew or loosen the screws on the detector surface since all the screws are secured properly at the time of shipment. Otherwise, it may result in poor image quality or damage to equipment.
- ☒ Ne pas dévisser ou desserrer les vis sur la surface du détecteur puisque toutes les vis sont bien fixées au moment de l'expédition. Sinon, elle peut entraîner une mauvaise qualité d'image ou endommager l'équipement.
- ☒ This device may malfunction due to electromagnetic interference (EMI) caused by telecommunication devices, transceivers, electronic devices, etc. To prevent the electromagnetic wave from badly influencing the device, be sure to avoid placing it in close proximity to the product. Or change direction or position of the product or move into the shielded place to reduce electromagnetic interference.
- ☒ Ce dispositif peut fonctionner en cas de brouillage électromagnétique causé par des dispositifs de télécommunication, des émetteurs-récepteurs, des dispositifs électroniques, etc. Pour éviter que l'onde électromagnétique n'influe gravement sur le dispositif, assurez-vous de ne pas le placer à proximité du produit. Ou changer la direction ou la position du produit ou se déplacer dans l'endroit blindé pour réduire l'interférence électromagnétique.
- ☒ To reduce the risk of electric shock, do not remove cover. No user-serviceable part inside. Refer servicing to qualified service personnel.
- ☒ Pour réduire le risque de choc électrique, n'enlevez pas le couvercle. Pas de pièce utilisable à l'intérieur. Diriger le service vers un personnel qualifié.

Notice

- ☒ The user must follow hospital cleaning and decontamination policies and procedure.
- ☒ This product calibration process is required to use.
- ☒ When you give this product to others, the User Manual shall be enclosed.
- ☒ Carbon plate of this product can have contact with patient's body parts occasionally.
- ☒ THE GRANTEE IS NOT RESPONSIBLE FOR ANY CHANGES OR MODIFICATIONS NOT EXPRESSLY APPROVED BY THE PARTY RESPONSIBLE FOR COMPLIANCE. SUCH MODIFICATIONS COULD VOID THE USER'S AUTHORITY TO OPERATE THE EQUIPMENT.

15.105(b):

NOTE: This equipment has been tested and found to comply with the limits for a Class B digital device, pursuant to part 15 of the FCC Rules. These limits are designed to provide reasonable protection against harmful interference in a residential installation. This equipment generates uses and can radiate radio frequency energy and, if not installed and used in accordance with the instructions, may cause harmful interference to radio

communications. However, there is no guarantee that interference will not occur in a particular installation. If this equipment does cause harmful interference to radio or television reception, which can be determined by turning the equipment off and on, the user is encouraged to try to correct the interference by one or more of the following measures:

- Reorient or relocate the receiving antenna
- Increase the separation between the equipment and receiver.
- Connect the equipment into an outlet on a circuit different from that to which the receiver is connected.
- Consult the dealer or an experienced radio/TV technician for help.

Notes

Note on Installation

Request your sales representative to install this device.

Note on Disposal of This Device

Disposal of this device in an unlawful manner may have a negative impact on health and on the environment. When disposing of this device, therefore, be absolutely sure to follow the procedure which is in conformity with the laws and regulations applicable in your area.



This symbol indicates that this product is not to be disposed of with your household waste, according to the WEEE Directive (2002/96/EC) and your national law. This product should be handed over to a designated collection point, e.g., on an authorized one-for-one basis when you buy a new similar product or to an authorized collection site for recycling waste electrical and electronic equipment (EEE). Improper handling of this type of waste could have a possible negative impact on the environment and human health due to potentially hazardous substances that are generally associated with EEE. At the same time, your cooperation in the correct disposal of this product will contribute to the effective usage of natural resources. For more information about where you can drop off your waste equipment for recycling, please contact your local city office, waste authority, approved WEEE scheme or your household waste disposal service. For more information regarding return and recycling of WEEE products, please visit www.bontech1.com.

(*EEA: Norway, Iceland and Liechtenstein)

General Hazards

Radiation Hazards

This system can be connected to X-ray generating equipment. Be certain to follow the safety instructions and specifications for wearing proper lead apron when X-ray exposures are planned or possible.

All personnel should wear protective equipment during all phases of installation, operation and maintenance of the system.

Electric Shock Hazards

To reduce the electric shock hazard, the system must be connected to an electrical ground. A three conductor AC power cable is supplied with this system to provide the proper electrical grounding. The power cable must be plugged into an UL-approved three-contact electrical outlet.

Do not disassemble or modify the product as it may result in fire or electric shock. There are no operator serviceable parts or adjustments inside the systems. Only trained and qualified personnel should be permitted access to the internal parts of the system.

Explosion Hazards

Do not operate the equipment in the presence of flammable or explosive liquids, vapors or gases. Do not plug in or turn on the system where hazardous substances are detected. If flammable substances are detected after the system has been turned on, do not attempt to turn off the system or unplug it. Evacuate and ventilate the area before turning the system off.

Implosion Hazards

Do not hit or drop the device. The device may be damaged if it receives a strong jolt, which may result in fire or electric shock if the device is used without it being repaired.

Owner's responsibility

The owner is responsible for ensuring that anyone using the system reads and understands the User Manual and other relevant literature, and fully understands them. BONTECH makes no representation, however, that the act of reading this manual renders the reader qualified to operate, test and calibrate the system.

Warning (Avertissement)

- ⊗ Do not use the system if unsafe conditions are known to exist. In case of hardware failure that could cause hazardous conditions (smoke, fire, and etc), turn the power OFF and unplug the power cords of all sub-systems.
- ⊗ N'utilisez pas le système s'il existe des conditions dangereuses. En cas de panne du matériel qui pourrait causer des conditions dangereuses (fumée, incendie, etc.), éteindre le courant et débrancher les cordons d'alimentation de tous les sous-systèmes.

Cleaning the System

Use a dry cloth to clean surfaces of the system. Do not use detergents or organic solvents to clean the system. Strong detergent, and organic cleaners may damage the finish and cause structural weakening. Do not clean the system when the power is on.

Disposal

Disposal of this product in an unlawful have negative effects on health and on the environment. When disposing of this product, therefore, be absolutely sure to follow the procedure which is in conformity with the laws and regulations applicable in your area.

Electrical Fire

This device is not suitable for use in the presence of a flammable anesthetic mixture with air or with oxygen or nitrous oxide. Conductive fluids that drain into the active circuit components of the system may cause short circuits that can result in electrical fire. Therefore, do not place fluids or food on any part of the system. To avoid electric shock and burns caused by use of the wrong type of fire extinguisher, make sure that the fire extinguisher at the site has been approved for used on electrical fires.

Handling the Device

The device must be handled with care to avoid personal injury damage to the internal image sensor.

Warning(Avertissement)

- ⊗ Do not hit or drop the device since the jolt may damage the detector.
- ⊗ Ne touchez pas l'appareil ou ne l'abaissez pas, car la salve pourrait endommager le détecteur.
- ⊗ Do not put pressure on the detector locally since it will cause permanent damage to the internal image sensor.
- ⊗ Ne pas exercer de pression sur le détecteur localement, car cela causerait des dommages permanents au capteur d'image interne.
- ⊗ Excessive weight on the device may damage the internal image sensor. It is recommended to used the case, in case if a patient should be positioned to put pressure on the detector while acquiring images.
- ⊗ Un poids excessif peut endommager le capteur d'image interne. Il est recommandé d'utiliser le cas, au cas où un patient devrait être positionné pour exercer une pression sur le détecteur tout en acquérant des images.

Dosimetry for Pediatric Patients

BT-DA22W/BT-DB22W detector is not particularly intended for the pediatric patients. However, the risk of radiation is higher for younger children. The operator must ensure the safety of the device when it is used on children. The following websites provide the additional guidance for pediatric use of radiographic imaging systems:

- American College of Radiology (ACR) www.acr.org
- Society of Pediatric Radiology (SPR)www.Pedra.org
- Image Gently www.imagegently.org
- FDA's Pediatric X-ray Imaging webpage

<http://www.fda.gov/RadiationEmittingProducts/RadiationEmittingProductsandProcedures/MedicalImaging/ucm298899.htm>

! Notice

☒ Refer to the X-ray exposure guideline provided by X-ray system manufacturer or generator manufacturer.

Regulatory

Medical Equipment Classifications

Type of protection against electrical shock Degree of protection against electric shock	Detector : Class 1 device, B-type Control Box : Class 1 device Adapter : Class 1 device
Degree of protection against ingress of water	IPX0
Mode of operation	Continuous Operation
Flammable anesthetics	NOT suitable for use in the presence of a flammable anesthetic mixture with air or with oxygen or nitrous oxide.

Guidance and Manufacturer's Declaration for EMC Directive

This device has been tested for EMI/EMC compliance, but interference can still occur in an electromagnetically noisy location. Attempt to maintain a suitable distance between electrical devices to prevent malfunction.

Electromagnetic Emissions

The Equipment Under Test (EUT) is intended for use in the electromagnetic environment specified below. The customer or user of the EUT should assure that it is used in such an environment.

Product safety standards

MDD	Council Directive 93/42/EEC as amended by Directive 2007/47/EC concerning medical devices
ISO 13485[2016]	Medical Device Quality management systems – Requirements for regulatory purpose
MEDDEV 2.12-1 Rev.8	Guidelines on a medical device vigilance system
CGMP	21 CFR PART 820- Quality System Regulation
EN ISO 14971 [2012]	Medical devices - Application of risk management to medical device (ISO 14971:2007, Corrected version 2007-10-01)
ISO 14644-1 [2015]	Cleanrooms and associated controlled environments Part 1 : Classification of air cleanliness by Particle concentration
ISO 14644-2 [2015]	Cleanrooms and associated controlled environments Part 2 : Monitoring to provide evidence of cleanroom performance related to air cleanliness by particle concentration
EN60601-1:2006+A1:2013+A12:2014	Medical electrical equipment – Part 1 : General requirements for basic safety and essential performance
EN 60601-1-2:2015	Medical electrical equipment - Part 1-2 : General requirements for basic safety and essential performance – Collateral standard : Electromagnetic compatibility – Requirements and tests
EN 62304:2006+A1:2015	Medical device software – Software life – cycle processes
EN ISO 15223-1:2016	Medical devices - Symbols to be used with medical device labels, labelling and information to be supplied - Part 1: General requirements
ISO 2248 [1985]	Packaging-Complete, filled transport Packages - Vertical impact test by dropping
MEDDEV 2.7.1 Rev.4	CLINICAL EVALUATION: A GUIDE FOR MANUFACTURERS AND NOTIFIED BODIES UNDER DIRECTIVES 93/42/EEC and 90/385/EEC
IEC 62366:2007/AMD 1:2014	Medical devices — Application of usability engineering to medical devices — Amendment 1
EN 1041:2008+A1:2013	Information supplied by the manufacturer of medical devices

Overview

BONTECH's BT-DA22W/BT-DB22W is a cassette type detector providing versatile usages with fantastic image quality. BT-DA22W/BT-DB22W provides large X-ray images which maximizes the area of anatomical view with minimal number of X-ray shots. The images transmitted from this system to the RawImageViewer(BT-IV01) are processed and transmitted to printers for output to film or to image servers for storage in place of the radiographic images of the conventional film system.

Features

Product Images

Front

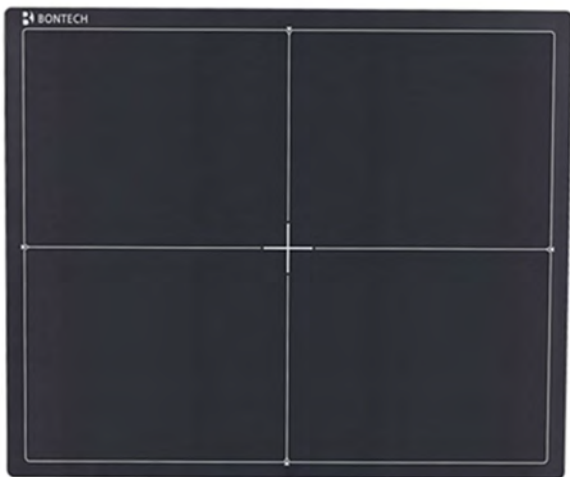

Back



Components Description

BSD3543W(BT-DA22W/BT-DB22W) has the following components:

- Flat Panel X-ray Detector (BSD3543W(BT-DA22W/BT-DB22W))
- Detector Handle (BT-DH02)
- Control Box (BT-CB02)
- Charger
- Battery pack
- Switching adaptor(MPU51-105)
- AC Power Supply Cord(BT-SC01)
- Main Cable (BT-MC06)
- Ethernet Cable (BT-EC02)
- Extended Cable (BT-MC05)
- X-ray Enable Signal Cable(sync cable) (BT-TC03)

Refer to p. 23~25 for more information on components.

Components

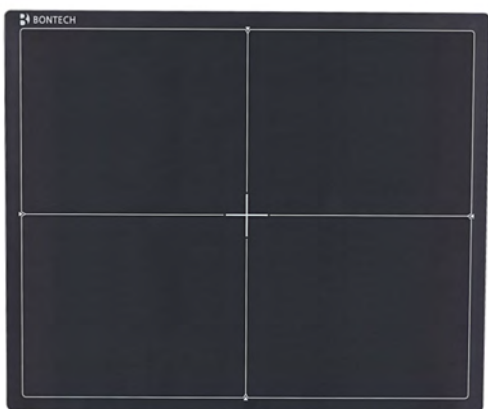

Flat Panel X-ray Detector
(BSD3543W(Csl:BT-DA22W, Gdos:BT-DB22W))



Detector Handle (BT-DH02)



Control Box (BT-CB02)



Charger



Battery pack



Switching adaptor (MPU51-105)



AC Power Supply Cord (BT-SC01)



Main Cable (BT-MC06)



Ethernet Cable (BT-EC02)



Extended Cable (BT-MC05)



X-ray Enable Signal Cable(Sync Cable) (BT-TC03)

Notice

- ☒ Compatible with not only new X-ray generators based on DR interface but also conventional X-ray generators.
- ☒ Check each component's identification label before installation.
- ☒ Contact BONTECH's representative or distributor if problem occurs with these parts or you need to purchase individual parts.

Detector Configuration

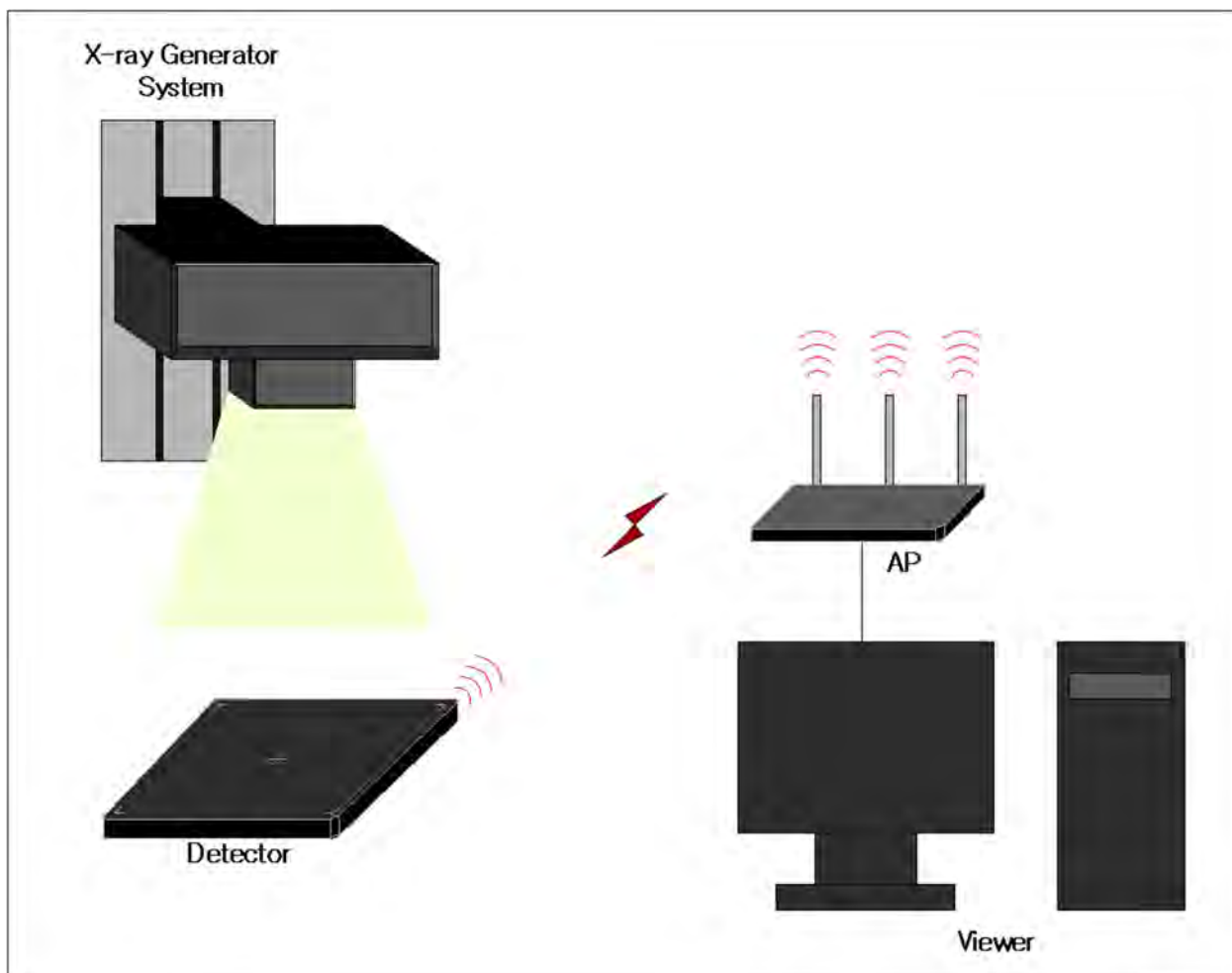

Labels and Symbols

Labels' different locations on the product and their description of the signs

Label on the bottom surface of the Detector (BSD3543W(BT-DA22W/BT-DB22W))

This label can be used for Detector Csl and GOS.

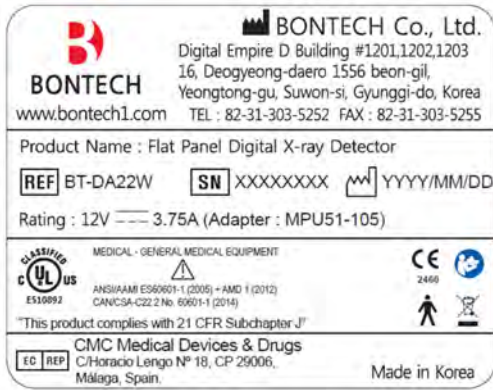

[Csl]

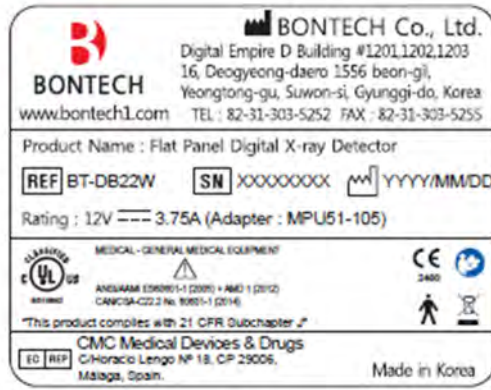

[Gdos]

Label on the bottom surface of the Control Box

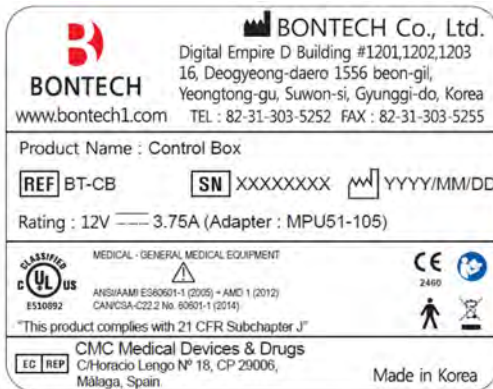

[Control Box]

Label on the bottom surface of the Battery Charger and Battery Pack























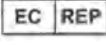





[Battert Pack]



[Charger]

Labels and their meanings

Sign	Description
	Product Model
	Serial number
	Caution
	Manufacturer
	Date of manufacture
	Type B applied part
	Follow Instruction for use
	Consult instructions for use
	Temperature limit
	Fragile, handle with care
	Humidity limitation
	Do not disassemble
	Earth ground
	Authorized representative in the European Community
	Alternating Current
	Direct Current
	"ON" (power: connection from the mains)
	"OFF" (only for a part of equipment)
	Keep dry

	Fragile, handle with care
	This way up
	Stack up to 4 boxes
	Handle with care
	Use no hooks
	Disposal instruction
	Authorized by CE
	<p>THE EQUIPMENT WITH RESPECT TO ELECTRIC SHOCK, FIRE AND MECHANICAL HAZARDS ONLY IN ACCORDANCE WITH UL 60601-1, CAN/CSA C22.2 No. 601.1 E510892</p>

Notes for Using the Instrument

Handling

The Equipment must be handled with care to avoid personal injury damage to the internal image sensor.

Caution(Attention)

- ⊗ Do not hit or drop the Equipment since the jolt may damage the detector.
- ⊗ Ne pas frapper ni laisser tomber l'équipement, car la salve pourrait endommager le détecteur.
- ⊗ Do not put pressure on the detector locally since it will cause permanent damage to the internal image sensor.
- ⊗ Ne pas exercer de pression sur le détecteur localement, car cela causerait des dommages permanents au capteur d'image interne.
- ⊗ Excessive weight on the equipment may damage the internal image sensor. It is recommended to use the case, in case if a patient should be positioned to put pressure on the detector while acquiring images.
- ⊗ Un poids excessif sur l'équipement peut endommager le capteur d'image interne. Il est recommandé d'utiliser le cas, au cas où un patient devrait être positionné pour exercer une pression sur le détecteur tout en acquérant des images.
- ⊗ Do not pull the cable or the sensor unit when the cable is tangled with something. Otherwise, the cable may be damaged, which may result in fire or electric shock.
- ⊗ Ne tirez pas le câble ou le capteur lorsque le câble est enchevêtré avec quelque chose. Sinon, le câble peut être endommagé, ce qui peut provoquer un incendie ou un choc électrique.

Before Exposure

Sudden heating of the room in cold areas will cause condensation to form on the instrument. In this case, wait until condensation disappears before performing exposure.

If the instrument is used with condensation formed on it, problems may occur in the quality of the instrument.

When an air-conditioner is going to be used, be sure to raise/lower the temperature gradually so that a

difference in temperature in the room and in the instrument does not occur, to prevent forming of condensation.

During Exposure

Do not apply excessive weight to the sensor unit. Otherwise, the sensor may be damaged.

During Cleaning

Do not use anything other than neutral detergent for cleaning the cover of the instrument. Otherwise, the coating will be corroded.

Storing

Be sure to store the sensor unit in a safe place where it will not fall or drop.

Description

General Description

The digital x-ray detector which uses a large area amorphous silicon sensor array allows the acquisition of x-ray exposures without the use of conventional film/screen system.

Warning(Avertissement)

- ☒ Please use the product to diagnose only.
- ☒ Veuillez utiliser le produit pour diagnostiquer seulement.

Intended Use for Ministry of Food and Drug Safety

The device converts medical image to digital form by using computer radiographic image device (CR), digital radiographic image device (DR) etc. to save image. Image transmission equipment and software is included at times.

Patient Group

Trauma / Internal injury Patient

User Profile

Doctor / Radiologist

Indication / Contraindication

Indication	Contraindication
Bone fractures	Patients who are pregnant or suspected of being pregnant unless the potential benefits of a procedure using radiation outweigh the risk of maternal and fetal damage
Infections (such as pneumonia)	
Calcifications (like kidney stones or vascular calcifications)	
Some tumors	
Arthritis in joints	
Bone loss (such as osteoporosis)	
Dental issues	
Heart problems (such as congestive heart failure)	
Digestive problems	
Foreign objects (such as items swallowed by children)	

Safety in Use

This device should be operated under radiology professional's presence only. The patient should not operate this device nor touch the device physically. This cassette size device is designed to be placed into a system, therefore the device would not touch the patient body directly.

Operation Principle

The X-ray information input to the image sensor from the outside is converted to visible light by Scintillator, and then through the amorphous silicon (a-Si), it is transferred to the photo Diode on the TFT Array and becomes converted back to an electrical signal. The converted electrical signal is amplified and converted to a digital signal and forms the image data. It is sent to computer through Ethernet Interface, and the obtained image will be displayed on the monitor screen.

X-ray Generator Requirement

The BSD3543W(BT-DA22W/BT-DB22W) is image acquisition sensor. So, it is not related with rating(W) and rated voltage etc, of X-ray generator tube. But, it is related with quality of X-ray. X-ray best condition is 50kVp~150kVP.

System Overview

The BSD3543W(BT-DA22W/BT-DB22W) is a flat panel X-ray detector used for radiological applications, part of a digital image acquisition system. The BSD3543W(BT-DA22W/BT-DB22W) detector is a X-ray image acquisition device that is based on flat panel. The digital X-ray detector uses a large area amorphous silicon sensor array with a scintillator. The panel will display high quality images in approximately 6 seconds over a wide range of dose setting.

This device should be integrated with an operating workstation [PC] and an x-ray generator. It can do to utilize as digitalizing X-ray images and transfer for radiography diagnostic. Also, it is intended to replace radiographic film/screen system in all general purpose diagnostic procedure.

The BSD3543W(BT-DA22W/BT-DB22W) device differs from traditional X-ray system in that, intended of exposing a film and chemically processing it to create a hard copy image, a device called a detector panel is used to capture image in electronic form.

Specifications

Main Specification

Item	Description
Model	BT-DA22W(CsI) BT-DB22W(GOS)
Purpose	General radiography
Image Matrix Size	2500 x 3052
Pixel Pitch	140 um
Effective Imaging Area	350 mm x 427.28 mm
Grayscale	16 bit, 65,536 grayscale
Scintillator	CsI GOS
Image Acquire & Transfer Time	Preview: less than 6 sec
Spatial Resolution	3.5lp/mm
Battery	7.5V, 5,500mAh
Battery performance	More than 4 hours
Durability	IP0
Interface	Wireless : IEEE 802.11ac
Dimensions	384 mm x 460 mm x 15 mm
Weight	2.92kg (Including battery)
Component	Battery charger / Control Box / AC Adapter

Item	Required Environment
Operation	Temperature: 15~35 °C Humidity: 30~85% (Non-Condensing) Atmospheric pressure: 70 ~ 106 kPa
Storage and transportation	Temperature: -15~+55 °C Humidity: 10~90% (Non-Condensing) Atmospheric pressure: 50~106 kPa

Components

System Requirements

Item	Specification
Operating System	32-bit WindowsOS, 64-bit Windows, WindowsXP (SP2 or later), Windows Vista, Windows 7, Windows 8 or higher
CPU	Dual Core 2.5GHz or higher
Memory	2GB or higher
Hard Disk	165MB for Installation
LAN Card	Gigabit (Detector Only) Intel PRO 1000 Series (Gigabit LAN Card for network interface) Min. Requirements: 1Gbps, Jumbo Frames: 7K or higher
Monitor	1024 x 768 or higher

Caution(Attention)

- ☒ Do not touch signal input, signal output, or other connectors and the patient simultaneously.
- ☒ Ne touchez pas simultanément l'entrée du signal, la sortie du signal ou d'autres connecteurs et le patient.

Notice

- ☒ When installation fails, check and correct the error in the following section:
 - Hardware
 - Operating System
 - Software Versions
 - Setup Program
 - Manual

Type Classification by Model Names

Model Names	Scintillator Type	Remarks
BT-DA22W	CsI (Cesium Iodide)	It uses CsI as Scintillator element.
BT-DB22W	GOS (Gadolinium Oxysulfide)	It uses GOS as Scintillator element.

Detector(BSD3543W(Csl: BT-DA22W, Gdos: BT-DB22W))

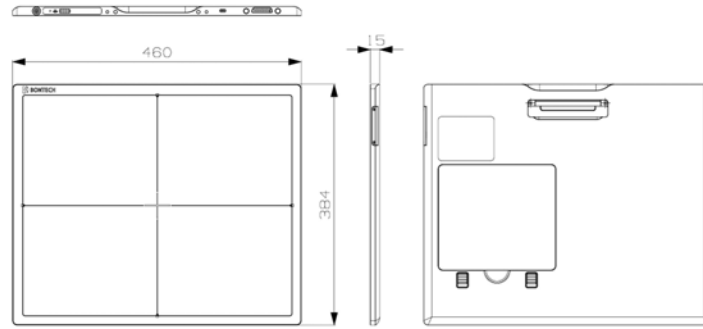

Dimensions: 460(Horizontal) X 384(Vertical) X 15(Height) (mm)

Weight: 2.92kg (Including battery)

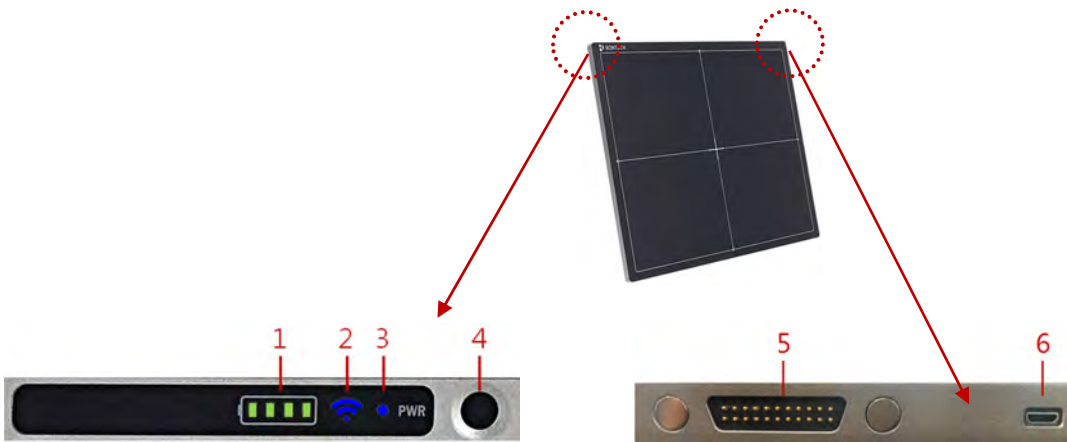

Detector indicator	Status	Remarks
1 Battery indicator	 4 LED Blinking : Low battery	8 step LED display.
2 Wi-Fi indicator	Blinking(0.5sec) : Detector Wi-Fi connection ready Blinking(2sec) : Detector ethernet connection ready Turn on : WiFi connection Turn off : Ethernet connection	Wi-Fi & Ethernet status LED.
3 Power indicator	Power on LED	-
4 Power button	OFF → Short press : PWR turn on ON → Short press : WiFi ↔ Ethernet ON → Long(3sec) press : PWR turn off	LED turns off for 3 seconds when switching mode start WiFi ↔ Ethernet.
5 Main connector	Main cable connector	Main cable connection.
6 Connector	Reserved	-

Caution(Attention)

- ☒ Charging is required if the four LEDs blink simultaneously.
- ☒ La charge est nécessaire si les quatre DEL clignotent simultanément.

※ Short press : Less than 3 seconds / Long press : More than 3 seconds.

Control Box (BT-CB02)

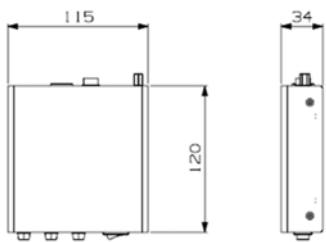

Dimensions: 115(Horizontal) X 120(Vertical) X 34(Height) (mm)

Weight: 285 g

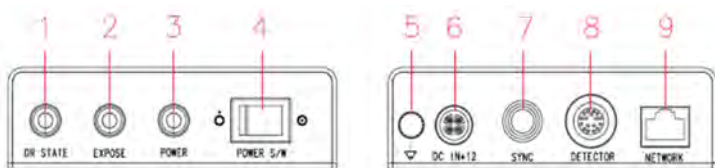

	Control box Configuration	Purpose	Remarks
1	DR STATE LED	Red: Error LED	Checking the detector connection.
2	EXPOSE LED	Yellow : Exposure LED	
3	POWER LED	Green : Power LED	
4	POWER S/W	Detector Power On/Off Switch	
5	Equipotential	Potential Equalization	
6	DC IN+12	DC 12V Power Connector	
7	SYNC	X-ray Sync Connector	
8	DETECTOR	Detector Main cable	Signal & Power Connector.
9	NETWORK	Gigabit Ethernet Connector	

Charger

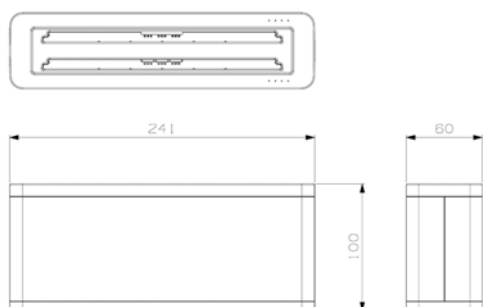

Dimensions: 241(Horizontal) X 100(Vertical) X 60(Height) (mm)

Weight: 445g

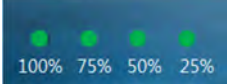

	Charger indicator	Status	Remarks
1	Battery indicator	 4 LED Blinking : Low battery	8 step LED display.

※ Charging is required if the four LEDs blink simultaneously.

Battery pack

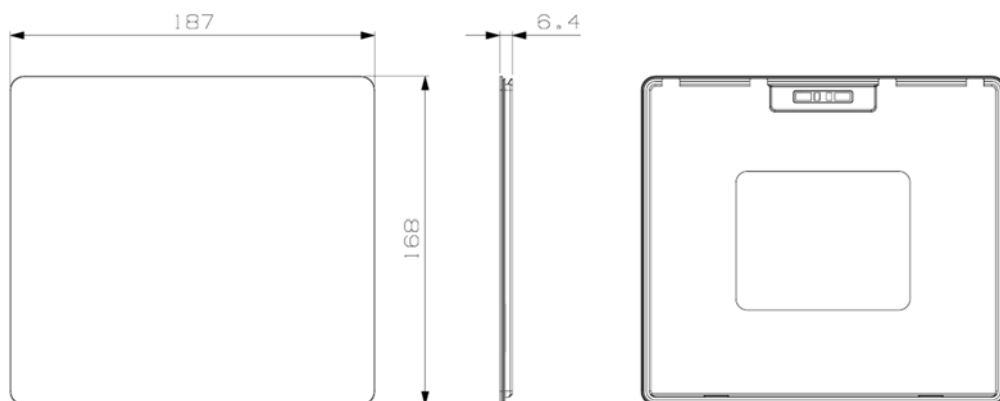

Dimensions: 187(Horizontal) X 168(Vertical) X 6.4(Height) (mm)

Weight: 265g

Other Accessories

Switching adaptor(BT-SA01): Size-145(W)x72(L)x42(H), Weight-560g

AC Power Supply Cord(BT-SC01): Length-1.5m, Weight-160g

Ethernet Cable (BT-EC01): Connecting between Control Box(BT-CB01) and PC LAN port.

CAT (Category) 7 cable is recommended. Length-10m (If you need longer one, contact Bontech.), Weight-380g

X-ray Enable Signal Cable(Sync Cable) (BT-TC01): It is necessary for Trigger connection.

Length-10m, Weight-415g

Installation

The detector is composed of sensitive electronic parts and components. Use ESD protection while installing the detector in its operation place. It is recommended to use the product in a clean place and to exercise caution to ensure that it is not affected by dust or liquids. When the detector is contaminated, it is recommended to use a dry and soft cloth to clean the detector housing, and be sure to respect to ESD safety conditions.

Detector connection

1) Wireless system

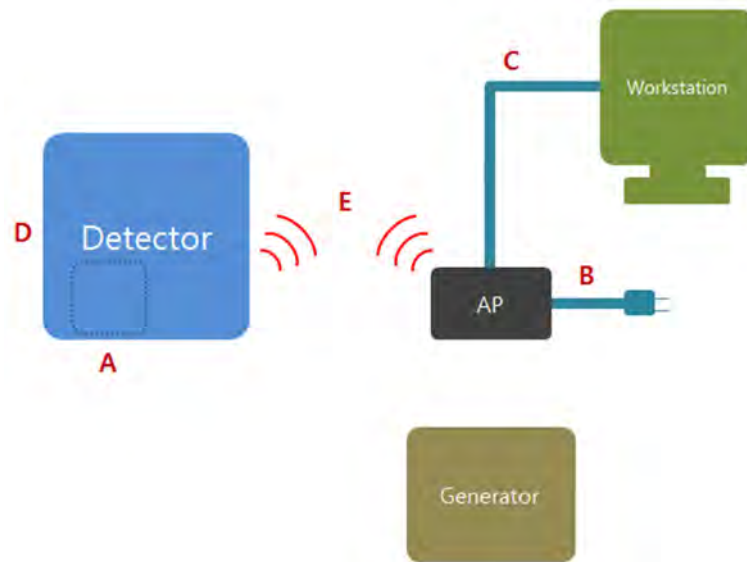

1) Wireless System Installation

- A. Attach the battery to the detector.
- B. Connect the AC power supply cord of the AP.
- C. Connect the AP Ethernet cable (BT-EC02) to the workstation.
- D. Power on the Detector.
- E. Check the WiFi LED of the detector and connect the AP and detector.



2) Wired system

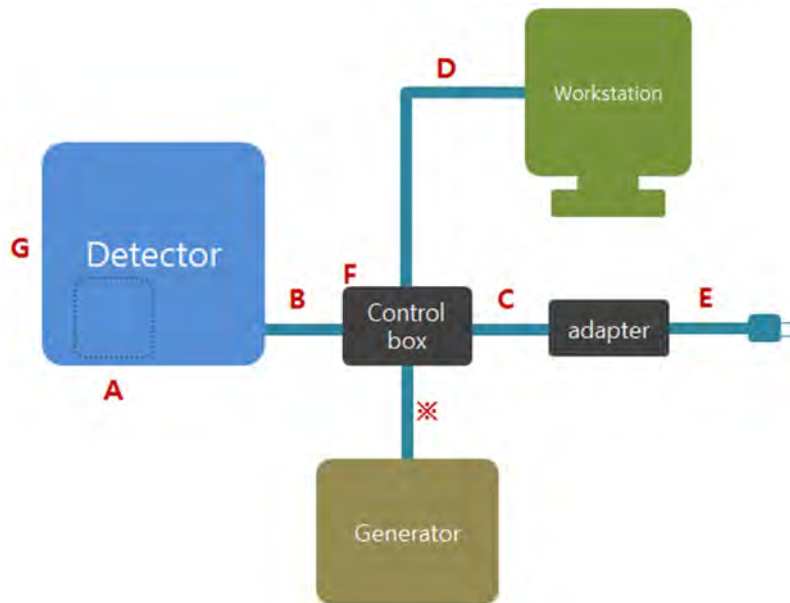

2) Wired System Installation

A. Attach the battery to the detector.

B. Connect DC main connector(BT-MC04) to the Control Box(BT-CB02).

C. Connect Switching adapter(MPU51-105) to the Control Box(BT-CB02).

D. Connect the control box Ethernet cable(BT-EC02) to the workstation.

E. Connect the AC Power Supply Cord(BT-SC01) to the Switching adapter(MPU51-105).

F. Turn on the Control Box(BT-CB02).

G. Power on the Detector.

※ When using a trigger cable, connect the sync cable(BT-TC03) in between the generator and the control box(BT-CB02).

Charger connection

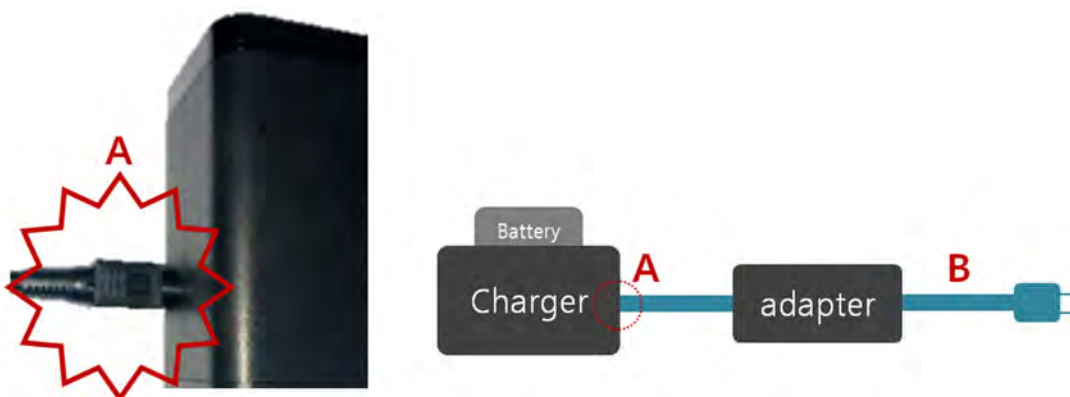

※ **Be careful of the connector direction!**

A. Connect Switching adapter(MPU51-105) to the Charger.

B. Connect the AC Power Supply Cord(BT-SC01) to the Switching adapter(MPU51-105).



Warning(Avertissement)

- ☒ To avoid risk of electric shock, this equipment must only be connected to a supply mains with protective earth.
- ☒ Afin d'éviter les risques de choc électrique, ces équipements ne doivent être raccordés qu'à une conduite d'alimentation avec une terre protectrice.
- ☒ Be aware of significant risks of reciprocal interference posed by me equipment during specific investigations or treatments.
- ☒ Soyez conscient des risques importants d'interférence réciproque que présente mon équipement au cours d'enquêtes ou de travaux particuliers.



Notice

- ☒ Turn on the workstation before turning on the Detector.
- ☒ Check each component's identification label before installation.
- ☒ Check if the cable connection is perfectly clicked in.
- ☒ Peripheral equipments that are connected to the Detector such as Workstation or Generator also must be suitable for EN 60601-1 or EN 60950-1.
- ☒ Power supply is specified as a part of me equipment or combination is specified as a me system.
- ☒ When installing the system, do not plug in the AC Adapter plug into a consent where it is difficult to unplug the AC Adapter plug.
- ☒ In order to disconnect the AC power, unplug the AC Adapter plug from the consent.
- ☒ This device should be only used with the system equipment and the workstation PC.
- ☒ Detector may have malfunction caused by following reasons:
 - when the power of the Control Box(BT-CB02) is off and when the power cables (BT-EC01, BT-TC01, and BT-SC01) which are parts of the detector and control box are disconnected. Make sure that the power is on for the Detector with all the cables properly connected in order to have a successful installation of the detector into the system. If problem still remains, refer to the detector manual.
 - Raw Image Viewer S/W which is provided with BSD3543W(BT-DA22W/BT-DB22W) can verify the connection to Generator. The raw images saved on PC is in image format that does not contain information of shooting environment and the patient. It is recommended for the user to select and use a console S/W which can perform image processing, DICOM, changing format, managing patient information, and connecting to a PACS system, and etc.
- ☒ The Detector is tested for the integration to a Generator and a viewing software as below.
 - Generator:
 - kV Range: 40~125kV, 1kV step (Optional 40~150kV)
 - mA Range: 10 to 500mA
 - Timer Range: 0.001 to 10 sec, 38 steps
 - Viewing Software:
 - S/W name: Raw Image Viewer (Refer to **System Requirement** from p.22 and **Description of Raw Image Viewer** from p.33.)
 - Data format: raw
- ☒ The battery pack charger is used in a separate space.

System Uninstallation

- C. Press the power switch on the Detector to turn it off.
- B. Power off the AP and disconnect the cord (BT-SC01).
- A. Disconnect Ethernet cable(BT-EC02) from Workstation.

X-ray Exposure Mode

Trigger Mode

Connect to X-ray Generator with the Trigger Cable.

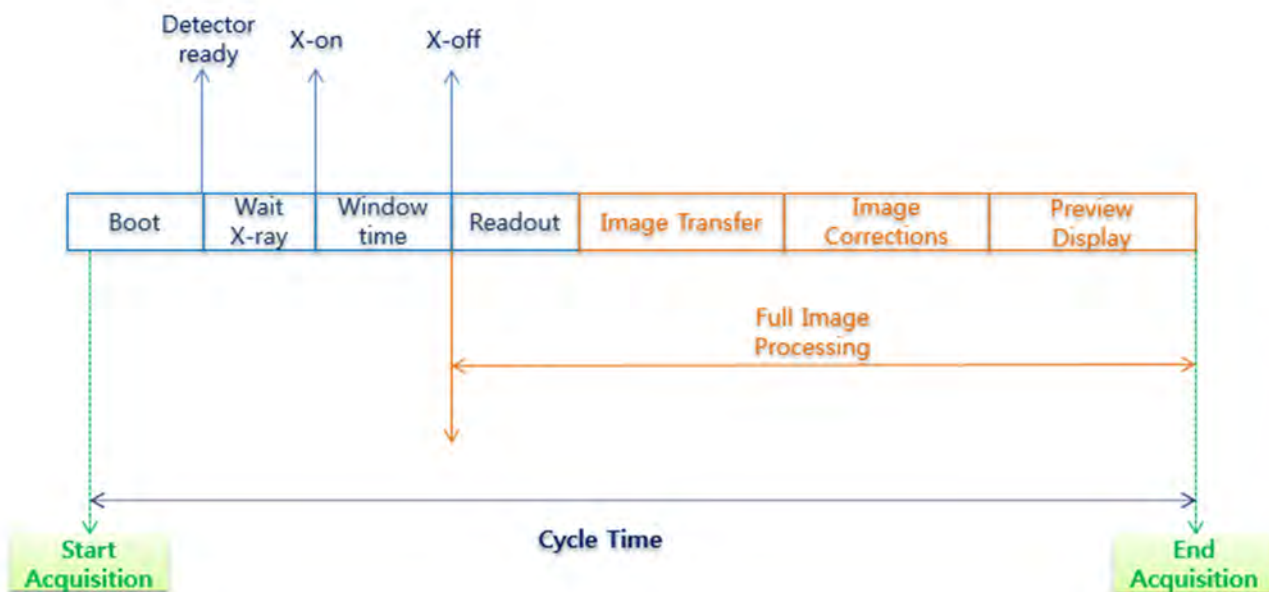

X-ray Generator Connection

Connect the X-ray enable cable between the X-ray enable connector of power supply with X-ray generator.

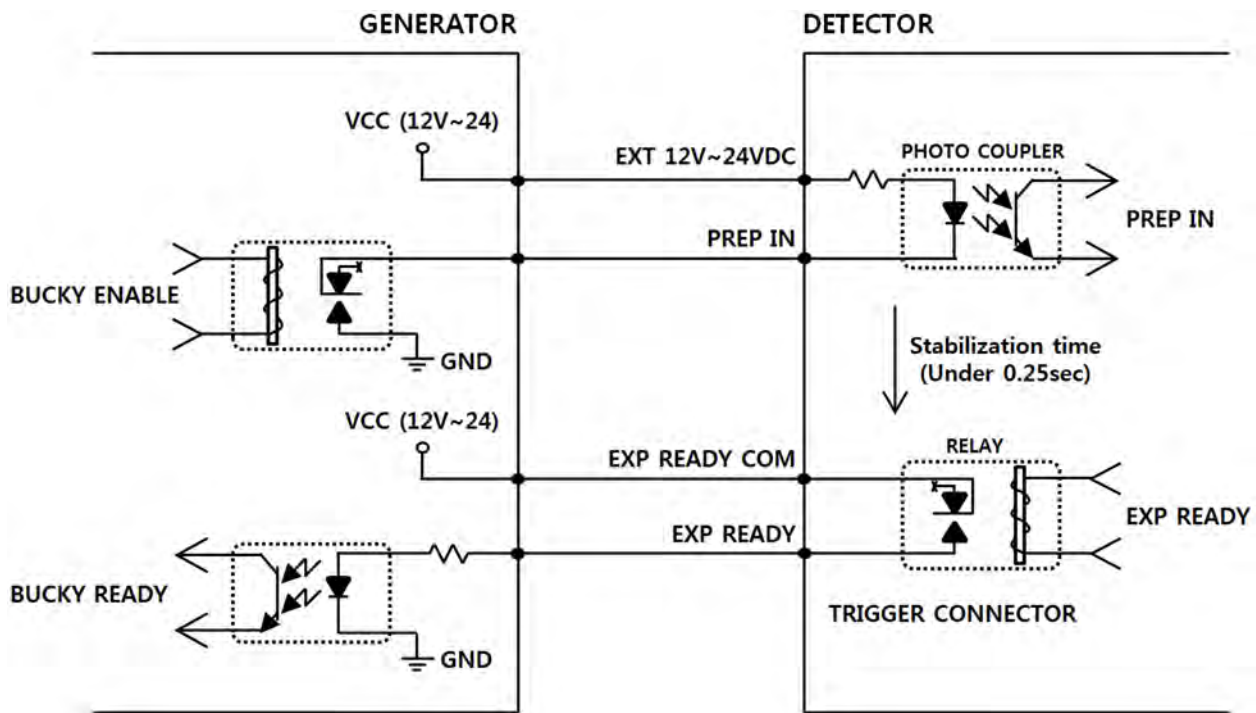

Connection Description

Signal	Label	Color	Input/Output
PREP IN	12V~24VDC	White	Input
	PREP IN	Black	Input
EXPOSURE READY	EXP READY	Red	Output
	EXP READY COM	Green	Output
EXT POWER	+ 5V	Blue	Output
	GND	Yellow	Output

! Notice

☒ 12~24V $\overline{\text{---}}$ should be supplied to detector.

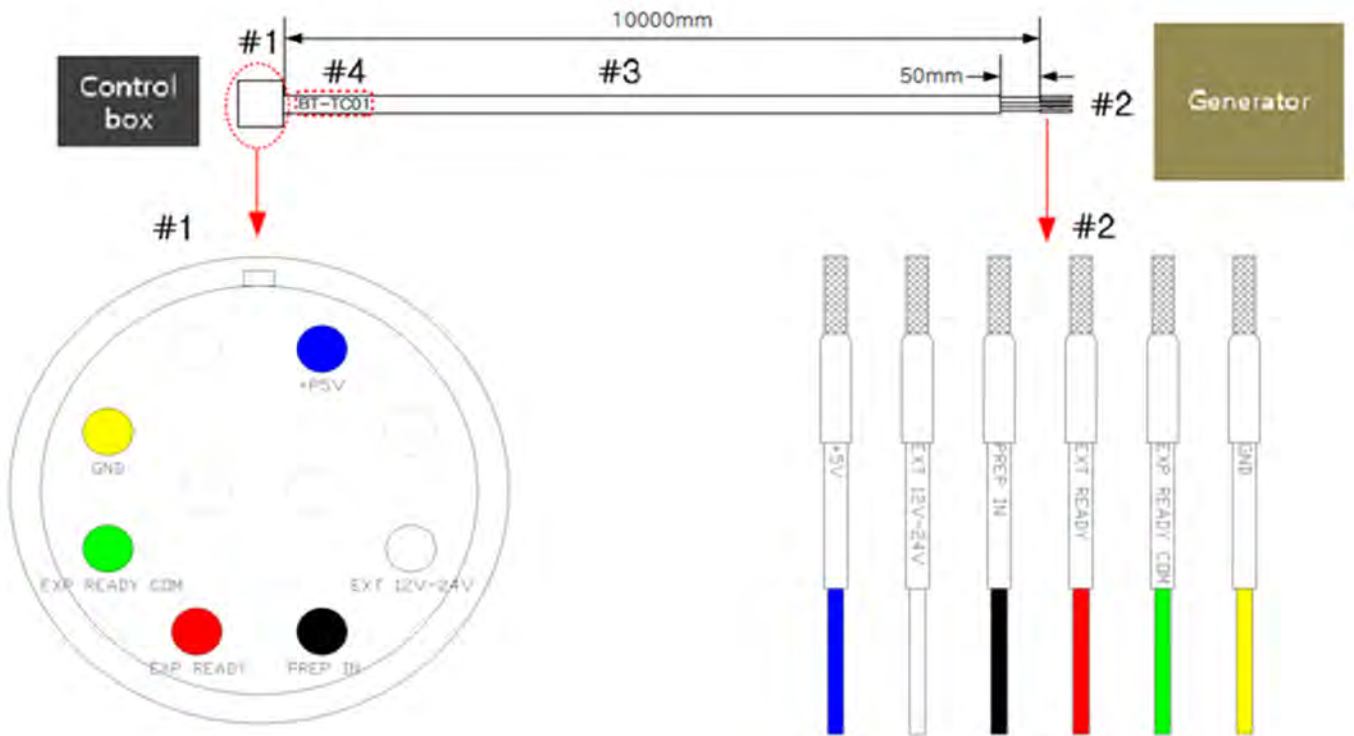

! Notice

- ☒ Please, refer to **Connection** Image's "D" part from p. 25.
- ☒ #1 connects to Control Box (BT-CB02).
- ☒ #2 connects to Generator. (Refer to the Generator's manual.)

Timing

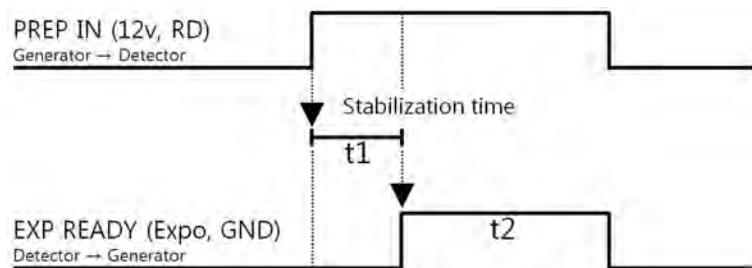

t1 / t2	Description
t1	Offset stabilization time (Max. 0.25 sec)
t2	Window time (Editing parameter: Exposure Time)

Auto Expose Detect Mode

You do not need to connect directly with the X-ray Generator.

! Notice

☒ Unexpected external shocks may cause malfunction.

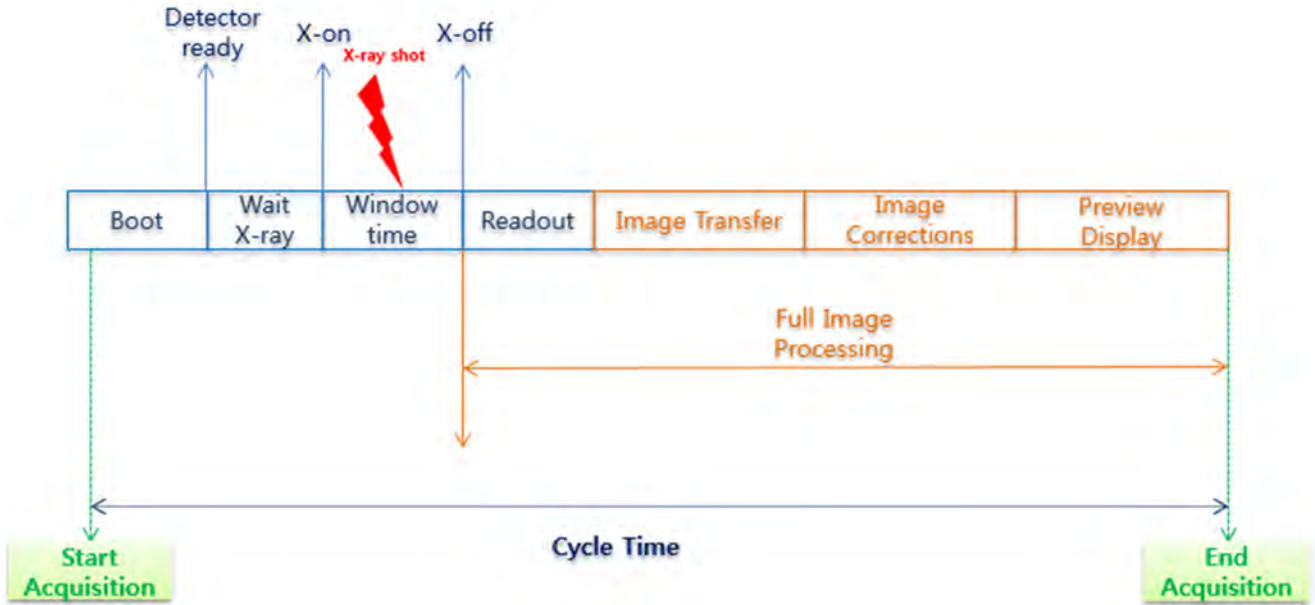

Network Setting

! Notice

- ☒ You must use a NIC which supports Gigabit Ethernet.

A. IP Settings

1. Set the PC IP to belong to the same Broadcast domain with the sensor.
Set the C class of the PC IP to 3 since the Sensor IP is 192.168.3.240.

! Notice

- ☒ You can set the Host PC IP as 192.168.3.XXX, and the XXX can be any number between 1 and 255.
- ☒ When you set the Host PC IP, avoid 192.168.3.240 since it is the Sensor IP given by the factory.
- ☒ If you cannot set the C class of the PC IP to 3, notify the customer service to change the Sensor IP.

2. Set the Subnet Mask to 255.255.255.0.

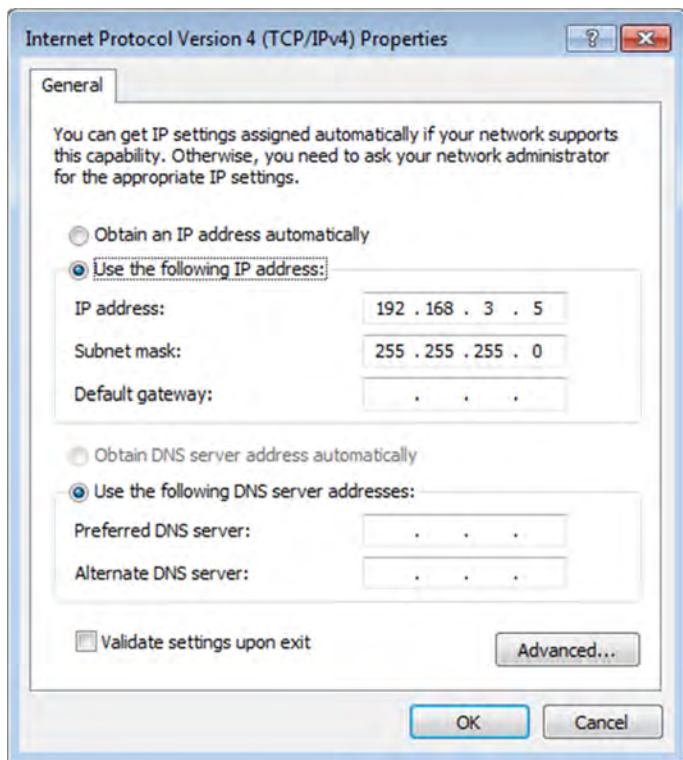

B.Router Setting

1. Change router to AP mode.
2. Set SSID to "bsdw#1"
3. Set password to "bontech1"
4. Set the Router IP's 192.168.3.xxx.
5. When the detector power on, it is connected to the router.

! Notice

- ☒ The setting method for each router may be different.
- ☒ The detector must be set to wireless mode.

PC Firewall Settings

Use after turning off the firewall settings.

! Notice

- ☒ Depending on the Firewall settings, the RawImageViewer cannot be operating. Please make sure if all firewall settings including individual firewall, corporate firewall, and Windows Firewall are turned Off.
- ☒ Depending on the Anti-virus S/W settings, the RawImageViewer cannot be operating. Please make sure if V3, Macafee, Norton, Microsoft Security Essentials, Windows Defender, or any other Anti-virus S/W is deactivated or closed.

Image Acquisition S/W

Exe File and Directory Settings



1. Copy the BSD folder from the provided CD and paste it into C:\W of the PC to install the program. It should be C:\W where you paste the BSD folder into.

! Notice

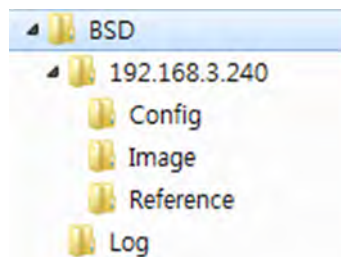
- ☒ The structure of the BSD folder pasted into C:\W is as follows:

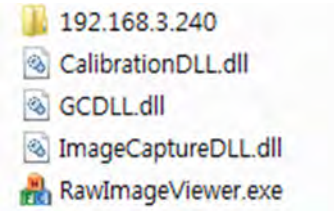
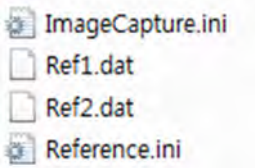

- ☒ The structure and functions of the folders are as follows:

Folder	Description
BSD	Program executive file (RawImageViewer.exe) and library file are located. 
config	Sensor configuration file (ImageCapture.ini, Ref2.dat, Ref2.dat, Reference.ini) 
image	Save the image file acquired by Sensor (Image_YYMMDD_HHMMSS.raw)
reference	Save data to calibrate the acquired image. 
log	Save the log in process of Calibration.

2. Run RawImageViewer.exe file.

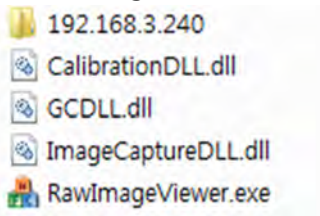

Name : RawImageViewer

Model: BT-IV01

RawImageViewer Configuration

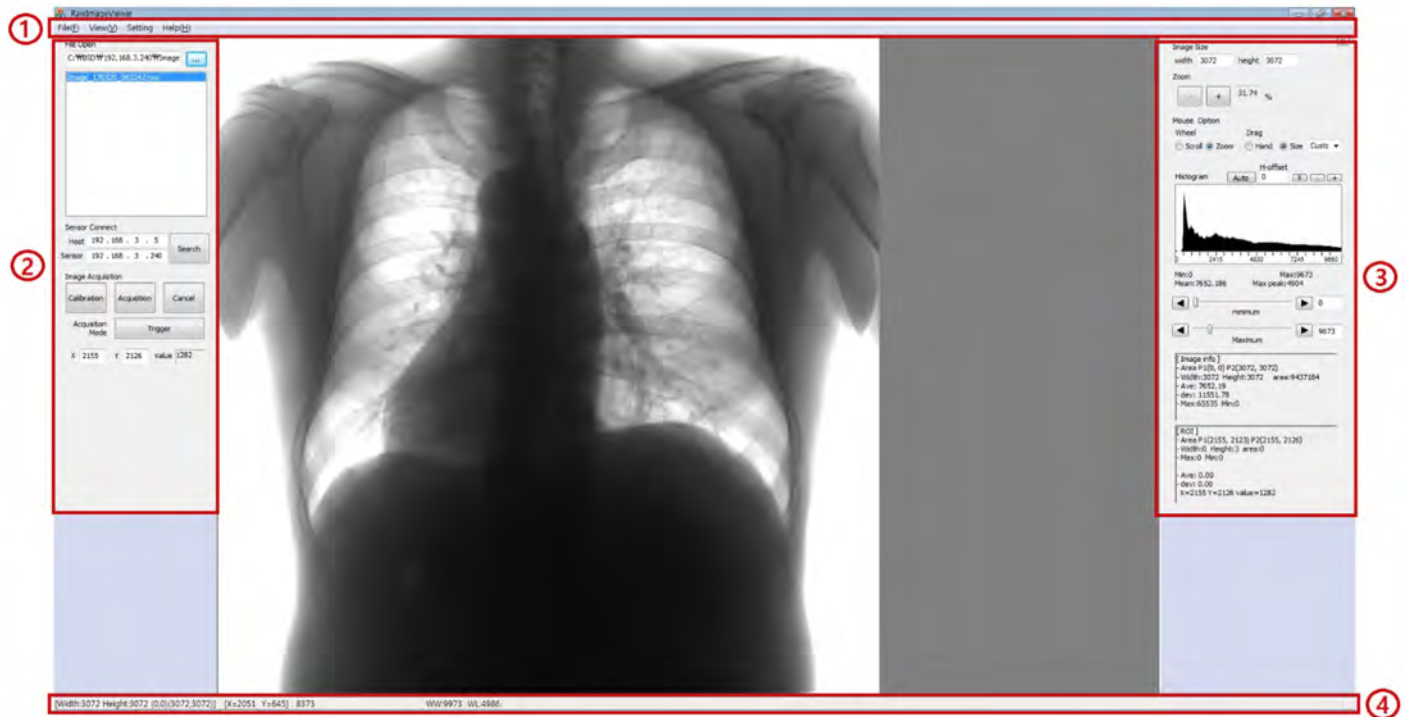

Number	Description
1	Menu Bar
2	Image Acquisition Section
3	Image Control Section
4	Status Bar

1. Menu Bar

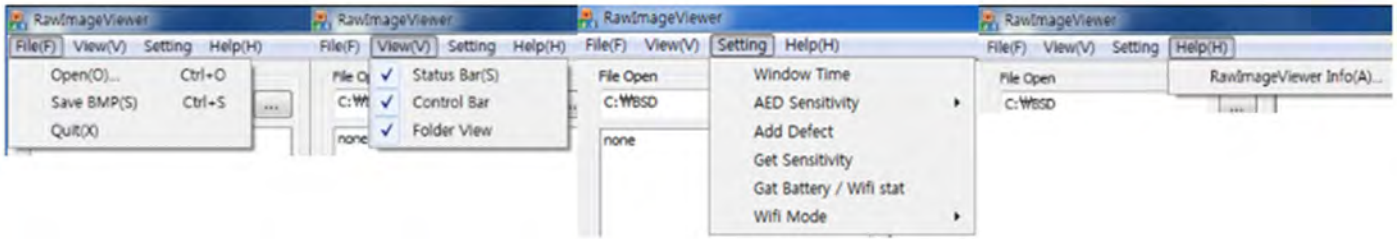

Menu	Sub Menu	Description
File	Open(O)	Select a file to open.
	Save BMP(S)	Save an open image in BMP format.
	Quit(X)	Exit program.
View	Status bar(S)	Enable/disable the Status bar at the bottom of the Viewer.
	Control bar	Enable/disable the Control bar on the right side of the Viewer.
	Folder view	Enable/disable the Folder view on the left side of the Viewer.
Setting	Window Time	Adjust Window Time (0.5sec ~ 1 sec).
	AED Sensitivity	Control AED Sensitivity (among 3 steps: Low, Mid, High)
	Add Defect	Manually add Defect information on Defect Map.
	Get Sensitivity	Check the sensitivity of the detector.
	Get Battery/ Wifi stat	Check battery level and Wifi strength.
	Wifi Mode	Set Detector Ethernet mode(wired) or wireless mode(wifi).
Help	RawImage Viewer Info(A)...	Information of the Viewer program version.

2. Image Acquisition Section

Sensor Connect

1. Check if Sensor Connect section's Host PC IP and Sensor IP information is correctly input. Sensor Connect section on the left side in the middle of the RawImageViewer screen, inside Folder view (Refer to p.36).
2. Click **Search**.

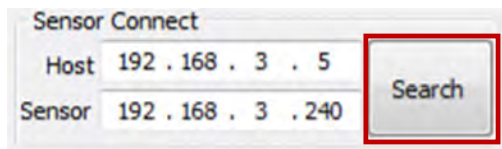

! Notice

☒ When connection is made successfully, "Connect success" pop-up appears: when there is no Detector found nor connection cannot be made, "Connect fail" pop-up appears.

☒ When you fail to connect, check the errors in the following section:

- Network settings: Jumbo Frame and Host IP settings
- Ethernet cable connection status
- Firewall is off.
- Reboot PC and detector.

Image Acquisition



Button	Descriptions
Calibration	Calibration tools pop up.
Acquisition	Acquire images from the detector.
Cancel	Cancel when Acquisition is ready.

3. Image Control Section

Image size & Mouse Option

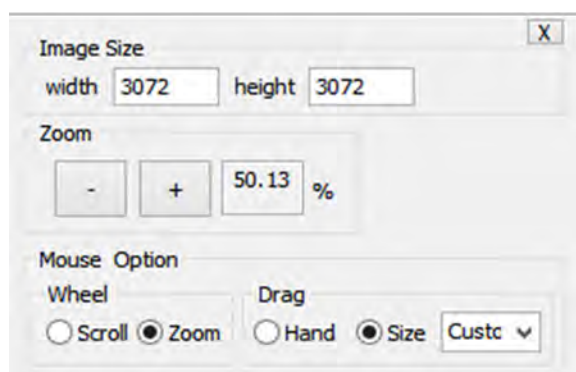

Item	Descriptions
Image size	Input size of the loading image.
Zoom	Zoom In / Zoom Out an image.
Wheel (Mouse Option)	
Scroll	Move vertically on the image with scrolling the mouse wheel up and down.
Zoom	Zoom In / Zoom Out the image with scrolling the mouse wheel.
Drag (Mouse Option)	
Hand	Drag the mouse to move the image position.
Size	<ul style="list-style-type: none">- (10~100 selected) Fixed ROI size- (Custom selected) Designate the ROI size by dragging the mouse.

Mouse Option- [Drag]

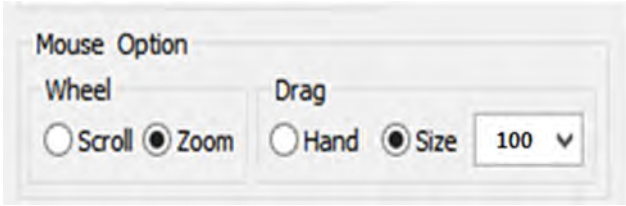

[10~100] : The fixed square becomes ROI area.

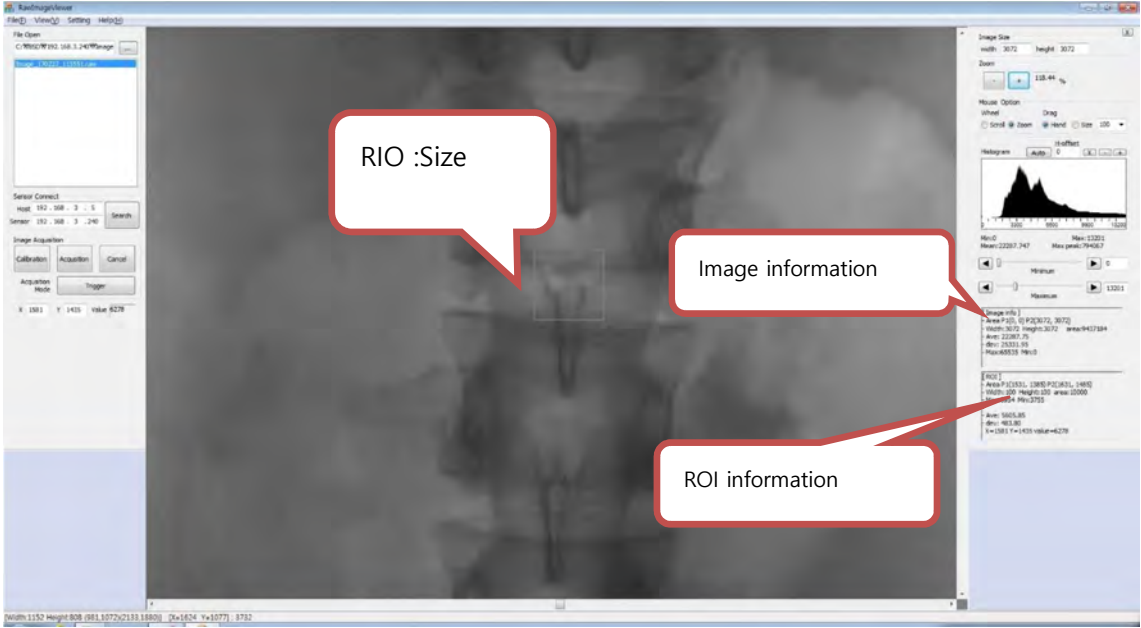

[Custom] :User can drag to designate the ROI area.

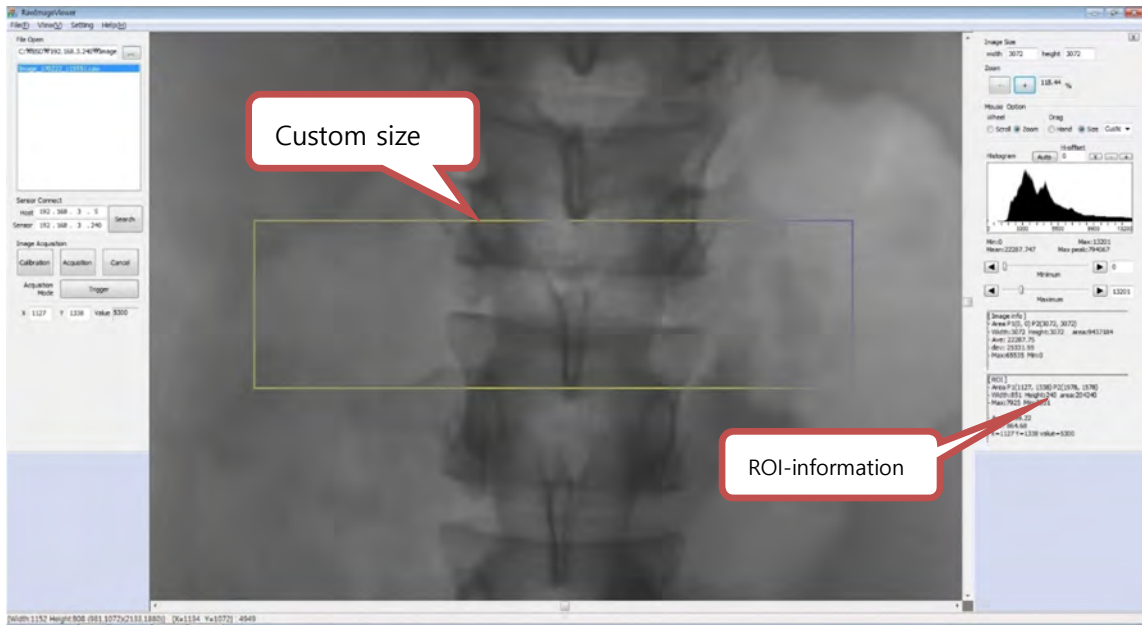

Histogram

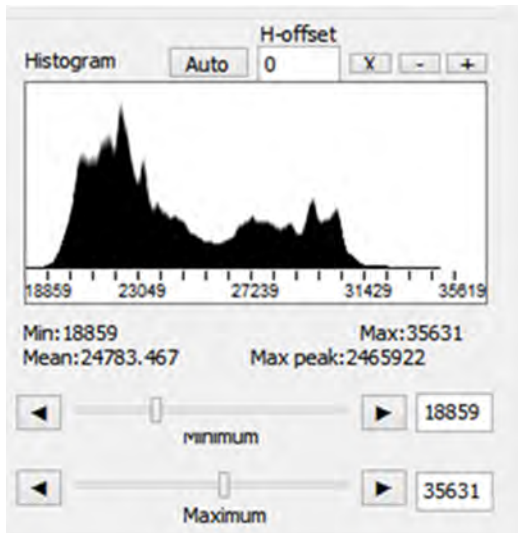

Item	Descriptions
Auto	<ul style="list-style-type: none"> - Contrast Auto-Adjustment Function - Select "Custom" among the Mouse options, and then designate any ROI area by dragging. - Click the Auto button. (Shortcut: F1) <p>The image automatically adjust its Contrast in order to show designated area clearly.</p>
H-offset	<ul style="list-style-type: none"> - Change the vertical scale of the histogram graph. - Also changeable with [+] [-] buttons. - [X] button can initialize.
Minimum, Maximum	<ul style="list-style-type: none"> - Change the Contrast value

4. Status Bar

Status Bar displays the image size, the coordinates of the current mouse position, and the level values.

Item	Descriptions
Width, Height	<ul style="list-style-type: none"> - Shows the size of the image currently displayed on the screen. - The values in parenthesis mean the starting coordinates (left, top) and the ending coordinates (right, bottom) of the displayed image.
[X, Y]	<ul style="list-style-type: none"> - Displays the coordinates and level of the current mouse location.
WW, WL	<ul style="list-style-type: none"> - Displays Window Width and Window Level. - You can change by dragging the mouse while pressing the right button.

7

Calibration

General Principle

The Purpose of Calibration

The center of the non-calibrated image is brighter than the edge due to hill effect of X-ray exposure. Generally, the intensity of X-ray flux at center region of exposed area is higher than surroundings due to the X-ray expose like cone shape. A calibration process is used to compensate for this effect. Generally, call this as 'Flat Field Correction' (Bright calibration).

Notation

Parameter	Description
Dark	Image acquired without X-ray exposure (Without an object)
Bright	Acquired image with X-ray exposure
Object	Bright image with object, will be calibrated
Gain	Gain of imaging system, offset subtracted image
Offset correction	Offset subtract (dynamic offset)

Gain correction

Compensate gain variance of pixel

! Notice

- ☒ X-ray detector should be used at stable state within driving temperature range.
- ☒ Acquire the X-ray images after power on and 30 minutes warming up is recommended in order to obtain high quality images.

Calibration Steps

Calibration steps are described as below.

Step	Descriptions
Preperation	Prepare for Calibration.
Step 1	Acquire Dark Frame.
Step 2	Acquire Bright Frame.
Step 3	Generate Defect map& Gain map.

[Preperation]

1. Click **Calibration** under **Image Acquisition**.

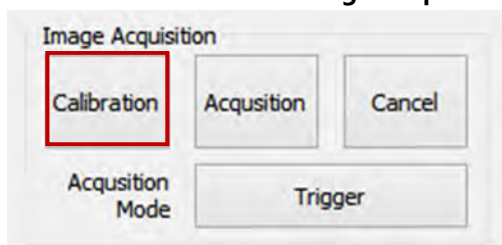

2. Adjust the Calibration Area by inputting **Margin**.

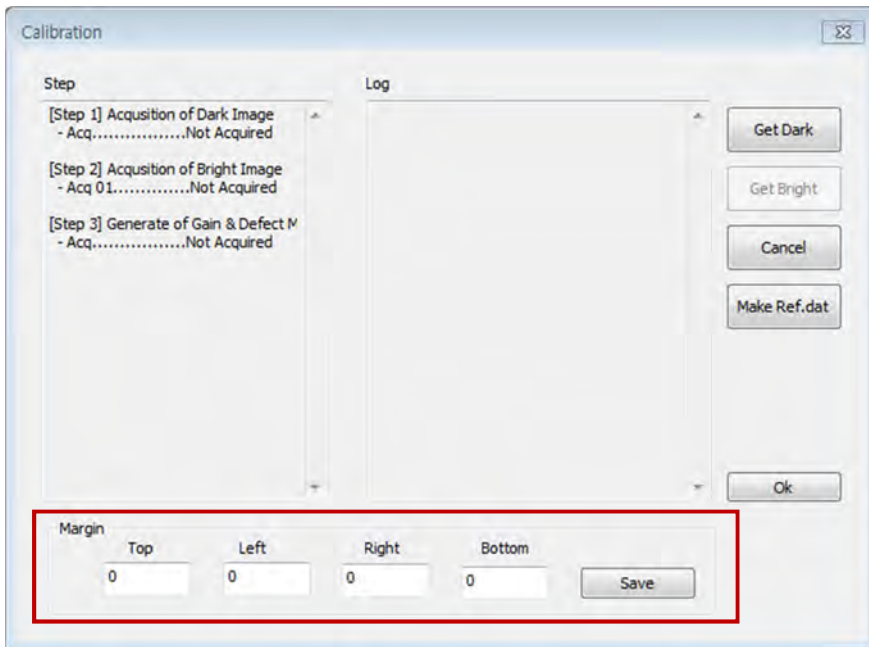

The Default value is 0, and if it is changed, click **Save** to save the new value.

! Notice

- ☒ If the X-ray Exposed Area is smaller than the detector, input **Margin** of the remaining edge before performing Calibration.
- ☒ You may skip this step if there is no need to adjust Margin.

[Step 1] Acquire Dark Frame

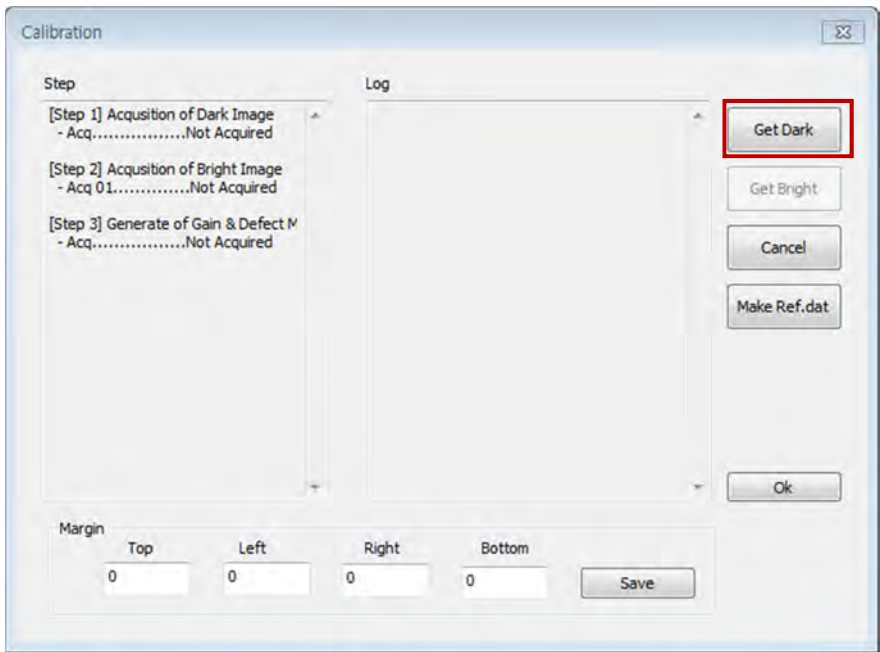

Click **Get Dark**, and acquire 3 Dark frames. The gap between each frame is 10 seconds.

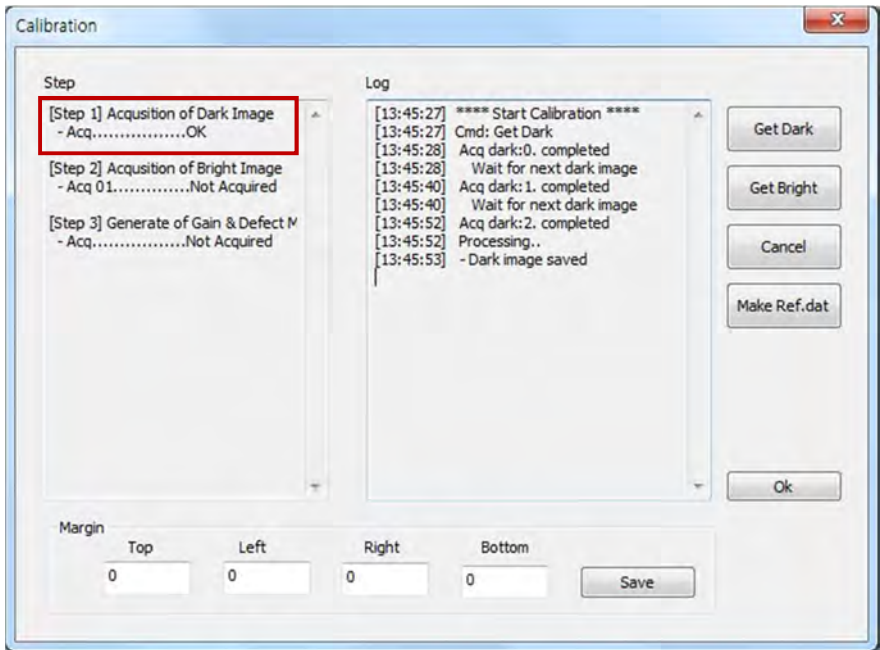

After acquiring all 3 Dark Frames, **[Step1] OK** sign appears in the **Step** window and **Dark image saved** message in the **Log** window.

! Notice

☒ The Dark Frame acquisition failure messages and what they mean

- **Not Ready for Image acquisition**

Detector is not ready for an image acquisition. After 10 seconds, it will automatically retry.

- **Dark image acquisition fail**

Failure in image acquisition. After 5 times of automatic retries fails, the Calibration process ends. Check Detector's connection status.

! Notice

☒ When you fail to acquire images, check the followings:

- Network Setting: Jumbo Frame & Host IP Setting
- Connection status with Ethernet cable
- Firewall turned off
- Reboot PC & Detector.

[Step 2] Acquire Bright Frame

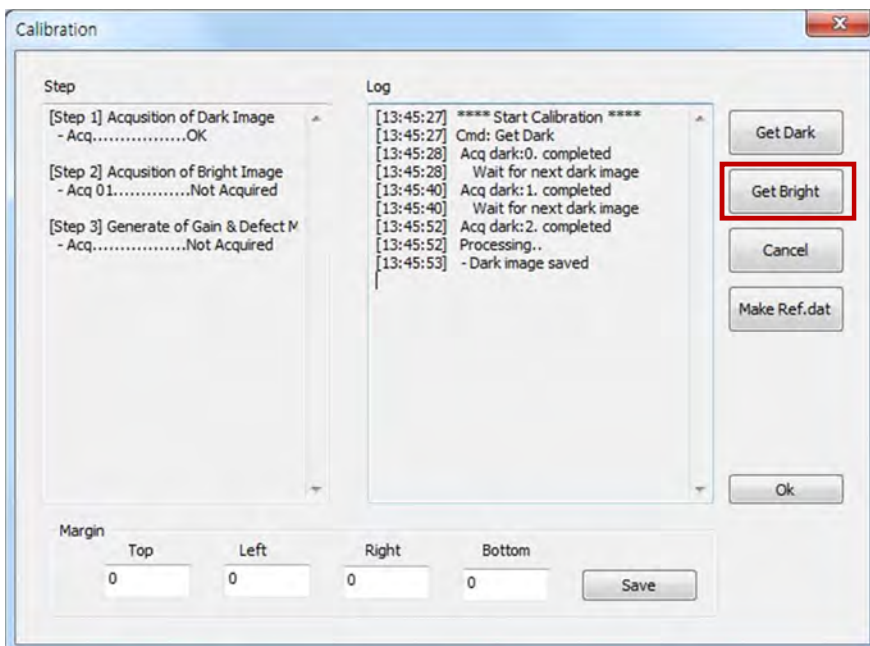

After completing Step 1, wait about 10 seconds, and then click **Get Bright**.

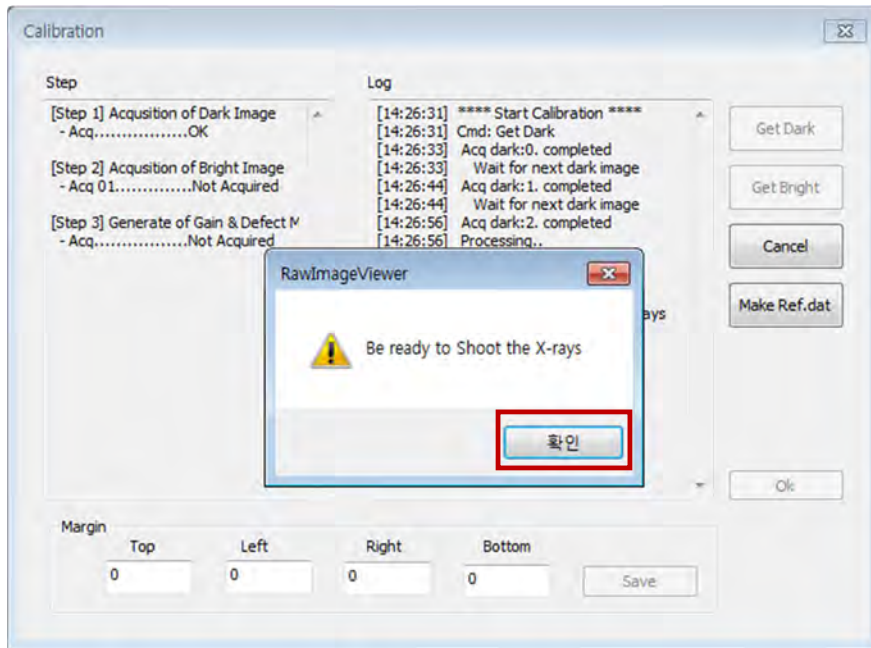

When this pop-up appears, get ready to expose the X-ray. When you are ready, click **OK**, and then expose the X-ray.

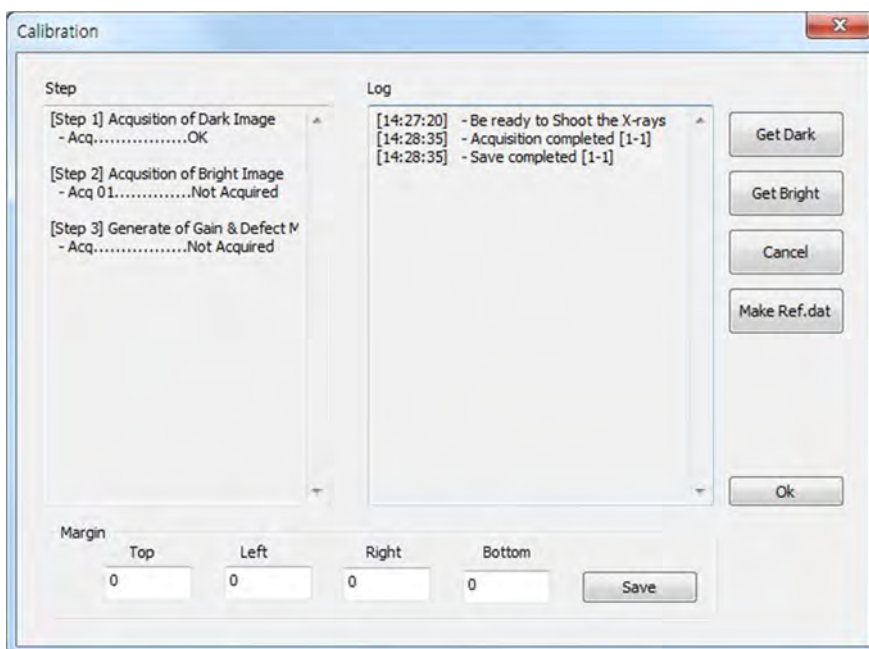

The X-ray image level should be in 5000LSB ~ 15000LSB, and if it does not meet the level, a pop-up

window will be appeared for reacquisition.

When acquisition is completed properly, **Acquisition completed [1-1] - Save completed [1-1]** message appears in the **Log** window, and after 10 seconds, acquisition for the Bright frame automatically repeats.

! Notice

☒ If acquired Bright Image is not a suitable level for Calibration, the following pop-up windows appear. Click **OK** and retry. If the level is below the standard, increase the X-ray dose, and if the level is above the standard, decrease the X-ray dose, and reexpose.

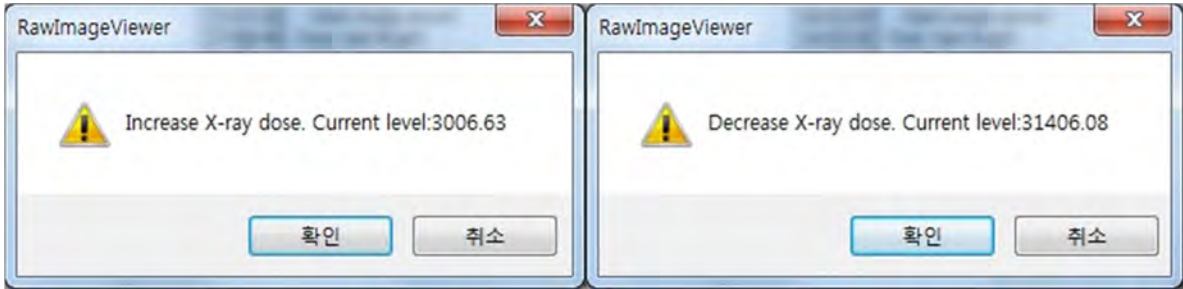

! Notice

☒ The Bright frame acquisition failure message and what they mean

- **Not Ready for Image acquisition**
The Detector is not ready for an image acquisition.
It automatically retries in about 10 seconds.
- **Image read fail**
Image acquisition has failed. A pop-up appears to check whether reacquisition will be proceeded or not.
If reacquisitions keep on failing, cancel and check the connection status with the Detector.

[Step 3] Defect map& Gain map

! Notice

☒ After acquiring all 3 Bright frames, it automatically starts to generate Defect map and Gain map.

- After generating Reference.raw file, Completed pop-up appears.
 1. Click OK on the pop-up.

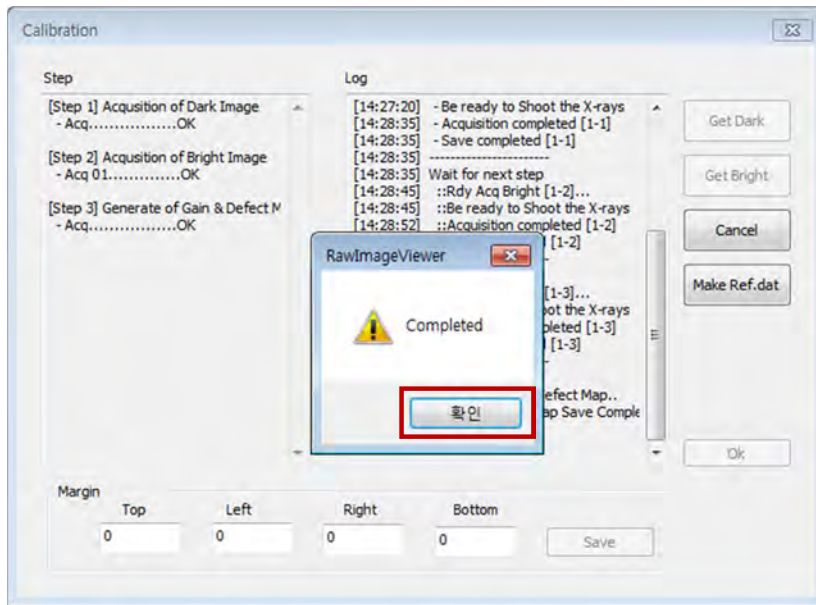

2. Click **OK**, and then close the Calibration window to complete the process.

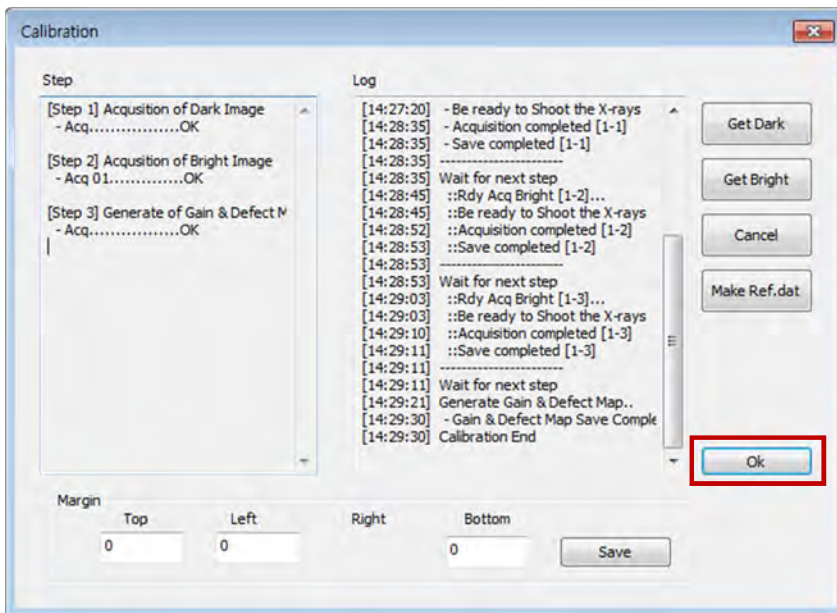

! Notice

☒ When in AED Mode, files appear as below:

- Bright frame(1 pc) : AED_Bright.raw
- Dark frame(1 pc) : AED_Dark.raw
- Defect map(1 pc) : AED_DefectMap.raw
- Gain map(1 pc) : AED_Reference00.raw

☒ When in Trigger Mode, files appear as below:

- Bright frame(1 pc) : Trigger_Bright.raw
- Dar frame(1 pc) : Trigger_Dark.raw
- Defect map(1 pc) : Trigger_DefectMap.raw

! Notice

☒ After completing Calibration properly, you can acquire calibrated images.

Acquisition

General Information

When acquiring the X-ray image, you can obtain calibrated image when the calibration is completed. If the calibration is not completed, you can obtain uncalibrated images.

During the image acquisition, detector and library communicate via Ethernet TCP.

Obtaining Images

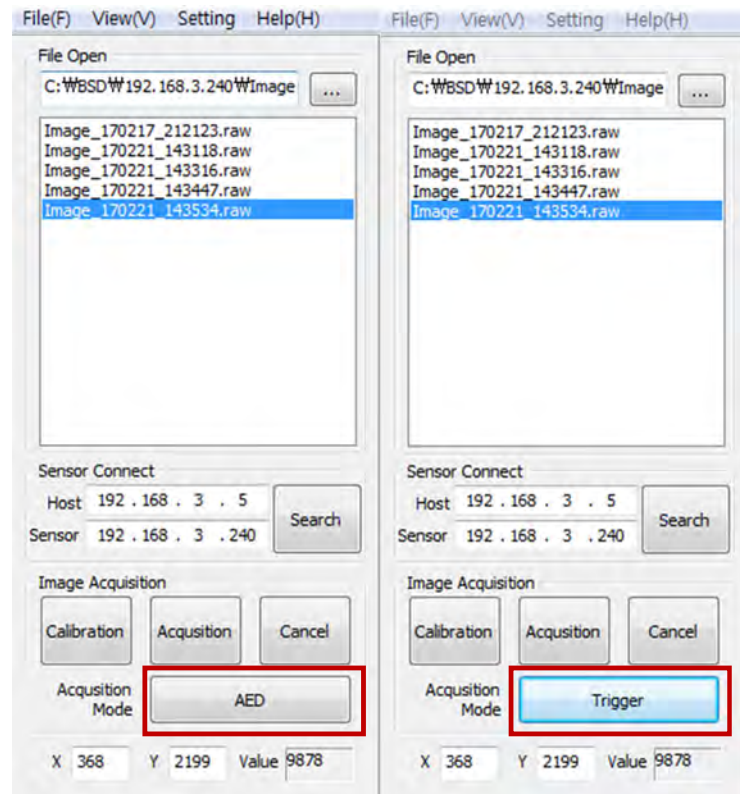

1. Select a mode among the selections of **Acquisition Mode**.

! Notice

- ☒ If the **Acquisition Mode** displays **AED** button, it means that the current mode is set to **AED** mode.
- ☒ To switch to **Trigger** mode, click **AED** button.

Mode	Descriptions
AED	AED(Auto Exposure Detection) automatically detects X-ray exposure signal without a direct connection between Detector and Generator.
Trigger	<ol style="list-style-type: none"> 1. It sends Ready Signal to Detector and Generator. 2. When Detector is ready, it sends EXPOSURE OUT signal to Generator. [READY IN (Generator→Detector), EXPOSURE OUT (Detector→Generator)] 3. When Generator receives EXPOSURE OUT signal, expose the X-ray.

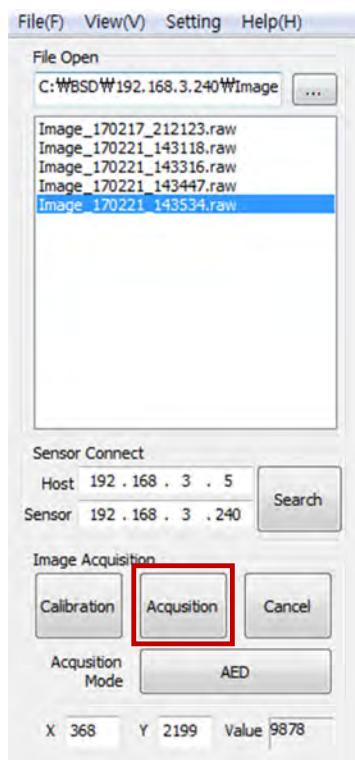

2. Click **Acquisition**.
3. Press Hand switch to expose X-ray.

The acquired images will be displayed onRawImageViewer.

! Notice

- ☒ If **Not ready for image acquisition** message pops up, wait 10 seconds and try again.
- ☒ When you fail to acquire images, check the errors in the following section:
 - Network settings: Jumbo Frame and Host IP settings
 - Ethernet cable connection status
 - Firewall is off.
 - Reboot PC and detector.
- ☒ After clicking **Acquisition**, if you want to cancel the process, click **Cancel**.

! Caution(Attention)

- ☒ Unexpected external shocks may cause malfunction when shooting in AED mode.
- ☒ Des chocs externes inattendus peuvent provoquer une défaillance.
- ☒ Do not apply external shocks nor move the object until the image acquisition completes after shooting.
- ☒ N'appliquez pas de chocs externes et ne déplacez pas l'objet tant que l'acquisition de l'image n'est pas terminée après le tournage.

Importing Images



Location and File Name of the acquired images

Path : C:\BSDW\192.168.3.240\Image

File name : Image_YYMMDD_HHMMSS.raw



Inspection and Maintenance

 Caution (Attention)	<p>The instrument must be repaired by a qualified engineer only. If it is not repaired properly, it may cause fire, electric shock, or accident.</p> <p>L'instrument ne doit être réparé que par un ingénieur qualifié. S'il n'est pas réparé correctement, il peut causer un incendie, un choc électrique ou un accident.</p>
 Warning (Avertissement)	<p>For safety reasons, be sure to inspect the instrument before using it. In addition, carry out a regular inspection at least once a year.</p> <p>Pour des raisons de sécurité, assurez-vous d'inspecter l'instrument avant de l'utiliser. De plus, effectuer une inspection régulière au moins une fois par an.</p>

Inspection

In order to ensure that the instrument is used safely and normally, please be sure to inspect the instrument before use. If any problem is found during the inspection, please take measures indicated in this chapter. If problem still cannot be corrected, please contact BONTECH representative or distributor. It is recommended that a record of the inspection be kept by making copies of the check lists in this section, or making a separate check list.

Inspection	Action
Daily	<ul style="list-style-type: none"> ☒ Acquire a Dark Image before Image Acquisition. ☒ Check if cables are not damaged. If damaged, contact BONTECH representative or distributor. ☒ Check if the cover or parts are not damaged and not loose. If damage or loose, contact BONTECH representative or distributor. ☒ Check the LED indicators, if LED indicators do not show on, check the power cable connection. If the problem remains, contact BONTECH representative or distributor.
Monthly	<ul style="list-style-type: none"> ☒ Check the performance of the device by performing exposures using a phantom or a resolution chart.
Yearly	<ul style="list-style-type: none"> ☒ Check the performance of the device by performing exposures using a phantom or a resolution chart.

Cleaning

The exterior of the array can be cleaned with common hospital decontamination solutions, including 20% chlorine bleach solution (1 part bleach to 4 part water). 70% alcohol solution, power down the system and disconnect from power source, moisten a cloth with the solution, and wipe the panel.

Notice

- ☒ The user must follow hospital cleaning and decontamination policies and procedure.
- ☒ Do not spray cleaning directly on to the panel. Instead, moisten a cloth with the solution and wipe the panel with the cloth.
- ☒ Do not immerse the panel in liquid.
- ☒ Do not autoclave the panel.

Contact Information

BONTECH Co., Ltd.	
Address	Digital Empire D-building #1201, #1202, #1203, 16, Deogyong-daero 1556 beon-gil, Yeongtong-gu, Suwon-si, Gyeonggi-do, KOREA
Phone	+82-31-303-5254
Fax	+82-31-303-5255
E-mail	Sales@bontech1.com
Website	http://www.bontech1.com

Service Information

Repair

If problem cannot be solved even after taking the measures indicated in the User Manual, contact BONTECH's representative or distributor for repair. Please refer to the name label, and inform us the model name and serial number with your problem described in detail.

Warranty

BONTECH Co., Ltd. warrants that this product will be free from defects in materials and workmanship for a period of twelve (12) months from the date of delivery. If any such product proves defective during this warranty period, BONTECH Co., Ltd. at its option, either will repair the defective product without charge for parts and labor, or will provide a replacement in exchange for the defective product. In order to obtain service under this warranty, Customer must notify BONTECH Co., Ltd. of the defect before the expiration of the warranty period and make suitable arrangements for the performance of service. Customer shall be responsible for packaging and shipping the defective product to the service center designated by BONTECH Co., Ltd. with shipping charges prepaid. BONTECH Co., Ltd. shall pay for the return of the product to customer if the shipment is to a location within the country in which the BONTECH Co., Ltd. designated service center is located. Customer shall be responsible for paying all shipping charges, duties, taxes, and any other charges for products returned to any other locations.

This warranty shall not apply to any defect, failure, or damage caused by improper or inadequate maintenance and care. BONTECH Co., Ltd. shall not be obligated to furnish service under this warranty to repair damage resulting from attempts by personnel other than BONTECH Co., Ltd. or its representatives to install, repair, or service this product, to repair damage resulting from improper use or connection to incompatible equipment or power source; or to service a product that has been modified or integrated with other products when the effect of such modification or integration increases the time or difficulty of servicing the product.

This warranty is given by BONTECH Co., Ltd. with respect to this product in lieu of any other warranties, expressed or implied. BONTECH Co., Ltd. and its vendor disclaim any implied warranties of merchantability or fitness for a particular purpose. BONTECH Co., Ltd. responsibility to repair or replace defective products is the sole remedy provided to the customer for breach of this warranty. BONTECH Co., Ltd. and its vendors will not be liable for any indirect, special, incidental, or consequential damages irrespective of whether BONTECH Co., Ltd. or the vendor has advance notice of the possibility of such damages. There are no warranties which extend beyond the description mentioned in this document.

Electrical Specification

The unit meets the Collateral Standards of Electromagnetic compatibility - Requirements and tests EN 60601-1:2007(IEC 60601-1-2) the limits and methods of measurement of electromagnetic disturbance characteristics of industrial, scientific and radio frequency equipment EN 55011 Group 1, Class A, Electrical Equipment is subject in regard to the electromagnetic compatibility(EMC) and its special precautionary measure

The unit must in reference to the mentioned EMC-hints in the accompanying documents be installed and operated. Portable and mobile RF - communicating system (such as cell phones) can have influence to Electrical Equipment.

Guidelines for the operator to use the e-Re Model device in electromagnetic environments.

electromagnetic emissions			
The e-Re Model device is intended for use in the electromagnetic environment specified below. The customer or the user of the e-Re Model device should assure that it is used in such an environment.			
Emissions test	Compliance	Electromagnetic environment	
RF emissions CISPR 11	Group 1	The e-Re Model device uses RF energy only for its internal function. Therefore, its RF missions are very low and are not likely to cause any interference in nearby electronic equipment.	
RF emissions CISPR 11	Class A	The e-Re Model device is suitable for use in all establishments, including domestic establishments and those directly connected to the public low-voltage power supply network that supplies buildings used for domestic purposes.	
Harmonic emissions IEC 61000-3-2	Class A		
Voltage fluctuations/ flicker emissions IEC 61000-3-3	Complies		
electromagnetic immunity			
The e-Re Model device is intended for use in the electromagnetic environment specified below. The customer or the user of the e-Re Model device should assure that it is used in such an environment.			
IMMUNITY test	IEC 60601 test level	Compliance level	Electromagnetic environment
Electrostatic discharge (ESD) IEC 61000-4-2	± 6 kV contact ± 8 kV air	± 6 kV contact ± 8 kV air	Floors should be wood, concrete or ceramic tile. If floors are covered with synthetic material, the relative humidity should be at least 30 %.
Electrical fast transient/burst IEC 61000-4-4	± 2 kV for power supply lines ± 1 kV for input/output lines	± 2 kV for power supply lines ± 1 kV for input/output lines	Mains power quality should be that of a typical commercial or hospital environment.

Surge IEC 61000-4-5	± 1 kV line(s) to line(s) ± 2 kV line(s) to earth	± 1 kV differential mode ± 2 kV common mode	Mains power quality should be that of a typical commercial or hospital environment.
Voltage dips, short interruptions and voltage variations on power supply input lines IEC 61000-4-11	<5 % U_T (>95 % dip in U_T) for 0,5 cycle 40 % U_T (60 % dip in U_T) for 5 cycles 70 % U_T (30 % dip in U_T) for 25 cycles <5 % U_T (>95 % dip in U_T) for 5 s	<5 % U_T (>95 % dip in U_T) for 0,5 cycle 40 % U_T (60 % dip in U_T) for 5 cycles 70 % U_T (30 % dip in U_T) for 25 cycles <5 % U_T (>95 % dip in U_T) for 5 s	Mains power quality should be that of a typical commercial or hospital environment. If the user of the e-Re Model device requires continued operation during power mains interruptions, it is recommended that the e-Re Model device be powered from an uninterruptible power supply or a battery.
Power frequency (50/60 Hz) magnetic field IEC 61000-4-8	3 A/m	0,3 A/m	If laser output distortion occurs, it may be necessary to position the e-Re Model device further from sources of power frequency magnetic fields or to install magnetic shielding. The power frequency magnetic field should be measured in the intended installation location to assure that it is sufficiently low.

NOTE 1 U_T is the a.c. mains voltage prior to application of the test level.

electromagnetic immunity

The e-Re Model device is intended for use in the electromagnetic environment specified below.
The customer or the user of the e-Re Model device should assure that it is used in such an environment.

IMMUNITY test	IEC 60601 test	Compliance	Electromagnetic environment
---------------	----------------	------------	-----------------------------

	level	level	
Conducted RF	3 Vrms	3 Vrms	Portable and mobile RF communications equipment should be used no closer to any part of the e-Re Model device, including cables, than the recommended separation distance calculated from the equation applicable to the frequency of the transmitter. Recommended separation distance $d = 1,2 \sqrt{P}$
IEC 61000-4-6	150 kHz to 80 MHz		$d = 1,2 \sqrt{P}$ 80 MHz to 800 MHz $d = 2,3 \sqrt{P}$ 800 MHz to 2,5 GHz
Radiated RF	3 V/m	3 V/m	where P is the maximum output power rating of the transmitter in watts (W) according to the transmitter manufacturer and d is the recommended separation distance in metres (m).
IEC 61000-4-3	80 MHz to 2,5 GHz		Field strengths from fixed RF transmitters, as determined by an electromagnetic site survey, ^a should be less than the compliance level in each frequency range. ^b Interference may occur in the vicinity of equipment marked with the following symbol: 

NOTE 1 At 80 MHz and 800 MHz, the higher frequency range applies.

NOTE 2 These guidelines may not apply in all situations. Electromagnetic propagation is affected by absorption and reflection from structures, objects and people.

^aField strengths from fixed transmitters, such as base stations for radio (cellular/cordless) telephones and land mobile radios, amateur radio, AM and FM radio broadcast and TV broadcast cannot be predicted theoretically with accuracy. To assess the electromagnetic environment due to fixed RF transmitters, an electromagnetic site survey should be considered. If the measured field strength in the location in which the e-Re Model device is used exceeds the applicable RF compliance level above, the e-Re Model device should be observed to verify normal operation. If abnormal performance is observed, additional measures may be necessary, such as re-orienting or relocating the e-Re Model device.

^bOver the frequency range 150 kHz to 80 MHz, field strengths should be less than 3 V/m.

Recommended separation distances between portable and mobile RF communications equipment and the e-Re Model device

The e-Re Model device is intended for use in an electromagnetic environment in which radiated RF disturbances are controlled. The customer or the user of the e-Re Model device can help prevent electromagnetic interference by maintaining a minimum distance between portable and mobile RF communications equipment (transmitters) and the e-Re Model device as recommended below, according to the maximum output power of the communications equipment.

Rated maximum output power of transmitter W	Separation distance according to frequency of transmitter m		
	150 kHz to 80 MHz <i>$d = 1,2 \sqrt{P}$</i>	80 MHz to 800 MHz <i>$d = 1,2 \sqrt{P}$</i>	800 MHz to 2,5 GHz <i>$d = 2,3 \sqrt{P}$</i>
0,01	0,12	0,12	0,23
0,1	0,38	0,38	0,73
1	1,2	1,2	2,3
10	3,8	3,8	7,3
100	12	12	23

For transmitters rated at a maximum output power not listed above, the recommended separation distance d in metres (m) can be estimated using the equation applicable to the frequency of the transmitter, where P is the maximum output power rating of the transmitter in watts (W) according to the transmitter manufacturer.

NOTE 1 At 80 MHz and 800 MHz, the separation distance for the higher frequency range applies.

NOTE 2 These guidelines may not apply in all situations. Electromagnetic propagation is affected by absorption and reflection from structures, objects and people.

Reference of X-ray Exposure Condition

*BMI = [Weight(kg)] / [Height(m)]²

- SMALL : BMI = under 18.4
- MIDDLE : BMI = 18.5 ~ 29.9
- LARGE : BMI = over 30.0

#Table of Exposure Condition below could be used as refecene only.

#Depending on the patient's body type and generator's specification, the expert can adjust the exposure condition appropriately.

			SMALL			MIDDLE			LARGE		
			kVp	mA	mAs	kVp	mA	mAs	kVp	mA	mAs
Head	Skull	AP	70	200	16	70	200	20	72	200	20
		Lateral	70	200	10	70	200	20	72	200	24
		Town's	74	200	10	74	200	25	80	200	28
	Mandible	PA	70	200	16	70	200	20	72	200	20
		Axial	70	200	16	70	200	20	72	200	20
		Lateral	70	200	16	70	200	20	72	200	20
	Town's	74	200	20	74	200	25	74	200	28	
Nasal	Lateral	48	100	3.2	48	100	4	55	100	4	
Zygomatic Arch Axial	70	200	16	70	200	20	72	200	20		
Facial	PNS	Waters	74	200	20	74	200	25	74	200	30
		Caldwell	74	200	20	74	200	25	74	200	30
		Lateral	70	200	16	70	200	20	75	200	20
	Mastoid	Law	74	200	20	74	200	25	74	200	30
		Stenvers	74	200	20	74	200	25	74	200	30
		Town's	74	200	20	74	200	25	74	200	30
	T-M Joint	Lateral	70	200	16	70	200	20	75	200	24
Town's		74	200	20	74	200	25	74	200	30	
Chest	Chest	AP	100	200	4	100	200	4	110	250	6.3
		PA	100	200	4	100	200	4	110	250	6.3
		Lateral	110	250	4	110	250	6.3	115	250	8

		Apico	110	250	4	110	250	6.3	115	250	8
	Upper Rib	AP	66	320	16	66	320	20.5	66	320	32
		Oblique	66	320	20	66	320	25	75	500	36
	Lower Rib	AP	66	320	16	66	320	20.5	75	500	30
		Oblique	66	320	20	66	320	25	75	500	36
Abdomen	Supine		75	450	40	75	450	45	72	200	25
	Erect		80	450	20	80	450	45	80	500	28
	KUB		75	450	36	75	450	40	75	500	63
	Pelvis	AP	75	200	16	75	200	20	75	200	40
		Lateral	75	250	25	80	250	25	80	250	30
	Hip	AP	75	200	20	75	200	25	80	200	25
		Lateral	75	250	25	80	250	25	80	250	30
Decubitus		66	320	16	66	320	20	72	200	25	
Upper Trunk	C-spine	AP	70	100	6.3	73	100	10	73	100	14
		Lateral	70	100	6.3	73	100	10	75	100	32
		Oblique	70	200	6.3	75	200	10	74	200	24
		Open Mouth	75	200	20	75	200	25	80	200	25
	T-spine	AP	75	200	20	75	200	25	74	200	30
		Lateral	80	200	30	80	200	36	85	200	40
		Oblique	74	200	20	74	200	25	85	200	30
		Swimmer	74	200	20	74	200	25	85	200	30
Lower Trunk	L-spine	AP	73	200	20	73	200	20	85	200	32
		Lateral	85	200	50	85	200	50	95	250	63
		Oblique	80	200	20	80	200	20	85	200	45
		Cone Down	73	200	20	73	200	20	80	200	45
	Sacrum	AP	73	200	20	73	200	20	80	200	40
		Lateral	80	200	16	80	200	20	85	200	45
	Coccyx	AP	73	200	20	73	200	20	80	200	40
Lateral		80	200	14	80	200	20	85	200	45	
Upper Extrimity	Hand	AP	45	100	3.2	45	100	3.2	45	100	4
	Wrist	AP	48	100	3.2	48	100	3.2	73	100	3.2
	Forearm	AP	50	100	3.2	50	100	3.2	73	100	3.2
	Elbow	AP	50	100	4	50	100	4	73	100	4
	Humerus	AP	50	100	4	50	100	4	50	100	6.3
	Shoulder	AP	55	100	5	55	100	5	60	100	6.3
	Clavicle	AP	55	100	5	55	100	5	55	100	5
	Scapula	AP	66	100	4	66	100	4	73	100	4

Lower Extrimity	Toe	AP	48	80	3.2	48	80	3.2	48	80	3.2	
	Foot	AP	48	100	3.2	48	100	3.2	48	100	3.2	
	Ankle	AP	52	100	4	52	100	4	52	100	4	
	Tibia	AP	48	80	3.2	48	80	3.2	48	80	4	
	Knee	AP	55	100	4	55	100	4	60	100	10	
	Merchant			52	100	3	52	100	3	52	100	3
	Femur	AP	66	100	6	66	100	6	66	100	6	
	Calcaneus	Axial	48	80	4	48	80	4	48	80	4	

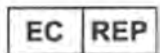

CMC Medical Devices & Drugs S.L.
C/Horacio Lengo N° 18, CP 29006, Málaga, Spain.

BONTECH



BONTECH Co., Ltd.

Digital Empire D-building, #1201, #1202, #1203, 16, Deogyong-daero 1556beon-gil, Yeongtong-gu,

Suwon-si, Gyeonggi-do, 16690 Rep. of Korea

Telephone: 82-31-303-5254

FAX: +82-31-303-5255

Website: <http://www.bontech1.com>

Some content may differ from the device depending on the region, software version, or detector model, and is subject to change without prior notice. Please, visit www.bontech1.com for more information.



BT-UM-004(E)

02/26/2020 Rev 1.3