

TEST REPORT

Report No.: 25010937HKG-004

Nacon (HK) Limited

Application For Original Grant of 47 CFR Part 15 Certification

Single New of RSS-247 Issue 3 Equipment Certification

Gaming headset with dongle

FCC ID: 2AVPR-600MAX

IC: 25872-600MAX

This report contains the data of Bluetooth 5.3 portion only

Prepared and Checked by:

Approved by:

Signed on File

Leung Chun Ning, Peter
Engineer

Wong Cheuk Ho, Herbert
Assistant Manager

Date: May 20, 2025

Intertek's standard Terms and Conditions can be obtained at our website <http://www.intertek.com/terms/>.

The test report only allows to be revised within the retention period unless further standard or the requirement was noticed.

This report is for the exclusive use of Intertek's Client and is provided pursuant to the agreement between Intertek and its Client. Intertek's responsibility and liability are limited to the terms and conditions of the agreement. Intertek assumes no liability to any party, other than to the Client in accordance with the agreement, for any loss, expense or damage occasioned by the use of this report. Only the Client is authorized to permit copying or distribution of this report and then only in its entirety. Any use of the Intertek name or one of its marks for the sale or advertisement of the tested material, product or service must first be approved in writing by Intertek. The observations and test results in this report are relevant only to the sample tested. This report by itself does not imply that the material, product, or service is or has ever been under an Intertek certification program.

© 2017 Intertek

TEST REPORT

GENERAL INFORMATION

Grantee:	Nacon (HK) Limited
Grantee Address:	17/F., 148 Electric Road, North Point, Hong Kong.
FCC Specification Standard:	FCC Part 15, October 1, 2023 Edition
FCC ID:	2AVPR-600MAX
FCC Model(s):	RIG600MAX
IC Specification Standard:	RSS-247 Issue 3, August 2023 RSS-Gen Issue 5 Amendment 2, February 2021
IC:	25872-600MAX
HVIN:	600MAX
PMN:	Gaming headset
Type of EUT:	Spread Spectrum Transmitter
Description of EUT:	Gaming headset with dongle
Sample Receipt Date:	April 14, 2025
Date of Test:	April 18, 2025 to April 24, 2025
Report Date:	May 20, 2025
Environmental Conditions:	Temperature: +10 to 40°C Humidity: 10 to 90%
Conclusion:	Test was conducted by client submitted sample. The submitted sample as received complied with the 47 CFR Part 15 / RSS-247 Issue 3 Certification.

This report contains the data of Bluetooth 5.3 portion only

TEST REPORT

TABLE OF CONTENTS

EXHIBIT 1	TEST RESULTS SUMMARY & STATEMENT OF COMPLIANCE	4
1.1	Summary of Test Results.....	4
1.2	Statement of Compliance	4
EXHIBIT 2	GENERAL DESCRIPTION	5
2.1	Product Description	5
2.2	Test Methodology	5
2.3	Test Facility.....	5
2.4	Related Submittal Grants.....	5
EXHIBIT 3	SYSTEM TEST CONFIGURATION	6
3.1	Justification	6
3.2	EUT Exercising Software.....	7
3.3	Supporting Equipment List and Description	8
3.4	Measurement Uncertainty.....	8
EXHIBIT 4	TEST RESULTS.....	9
4.1	Maximum Conducted (Peak) Output Power at Antenna Terminals.....	9
4.2	Maximum 20dB RF Bandwidth and Occupied Bandwidth.....	12
4.3	Minimum Number of Hopping Frequencies	14
4.4	Minimum Hopping Channel Carrier Frequency Separation	16
4.5	Average Channel Occupancy Time	18
4.6	Out of Band Conducted Emissions.....	20
4.7	Field Strength Calculation	23
4.8	Transmitter Radiated Emission in Restricted Bands and Spurious Emission	24
4.9	AC Power Line Conducted Emission	30
EXHIBIT 5	EQUIPMENT LIST	33

TEST REPORT

EXHIBIT 1 TEST RESULTS SUMMARY & STATEMENT OF COMPLIANCE

1.1 Summary of Test Results

Test Items	FCC Part 15 Section	RSS-210/ RSS-Gen [#]	Test Engineer	Results	Details See Section
Antenna Requirement	15.203	8.3 [#]	N/A	Pass	2.1
Max. Conducted Output Power	15.247(b)(1) & (4)	5.4(2)	David Du	Pass	4.1
Max. 20dB RF Bandwidth	N/A	5.1(1)	David Du	Pass	4.2
Min. No. of Hopping Frequencies	15.247(a)(1)(iii)	5.1(4)	David Du	Pass	4.3
Min. Hopping Channel Carrier Frequency Separation	15.247(a)(1)	5.1(2)	David Du	Pass	4.4
Average Time of Occupancy	15.247(a)(1)(iii)	5.1(4)	David Du	Pass	4.5
Out of Band Antenna Conducted Emission	15.247(d)	5.5	David Du	Pass	4.6
Radiated Emission in Restricted Bands and Spurious Emissions	15.247(d)	8.10 [#]	Leo Li	Pass	4.8
AC Power Line Conducted Emission	15.207 & 15.107	8.8 [#]	Linson Xie	Pass	4.9

Note: Pursuant to FCC Part 15 Section 15.215(c), the 20dB bandwidth of the emission was contained within the frequency band designated (mentioned as above) which the EUT operated. The effects, if any, from frequency sweeping, frequency hopping, other modulation techniques and frequency stability over expected variations in temperature and supply voltage were considered.

1.2 Statement of Compliance

The equipment under test is found to be complying with the following standards:

FCC Part 15, October 1, 2023 Edition
RSS-247 Issue 3, August 2023
RSS-Gen Issue 5 Amendment 2, February 2021

TEST REPORT

EXHIBIT 2 GENERAL DESCRIPTION

2.1 Product Description

The Equipment Under Test (EUT), is a 2.4GHz and Bluetooth 5.3 Transceiver for a Gaming headset. For the Bluetooth 5.3 mode, the sample supplied operated on 79 channels, normally at 2402 - 2480MHz. The channels are separated with 1MHz spacing. For the 2.4GHz mode, the sample supplied operated on 40 channels, normally at 2402 - 2480MHz. The channels are separated with 2MHz spacing. The EUT is powered by 3.8V Li-ion battery or notebook USB port (5VDC).

The antenna(s) used in the EUT is integral, and the test sample is a prototype.
Maximum Antenna Gain: 4.0dBi

The circuit description and frequency hopping algorithm are attached in the Appendix and saved with filename: descri.pdf.

2.2 Test Methodology

Both AC power line-conducted and radiated emission measurements were performed according to the procedures in ANSI C63.10 (2013). Preliminary radiated scans and all radiated measurements were performed in radiated emission test sites. All Radiated tests were performed at an antenna to EUT distance of 3 meters, unless stated otherwise in the "**Justification Section**" of this Application. Antenna port conducted measurements were performed according to ANSI C63.10 (2013) and KDB Publication No. 558074 D01 v05r02 (April 02, 2019). All other measurements were made in accordance with the procedures in 47 CFR Part 2 and RSS-Gen Issue 5 Amendment 2, February 2021.

2.3 Test Facility

The radiated emission test site and antenna port conducted measurement facility used to collect the radiated data and conductive data are at Shenzhen UnionTrust Quality and Technology Co., Ltd. at 16/F., Block A, Building 6, Baoneng Science and Technology Park, Qingxiang Road No.1, Longhua New District, Shenzhen, China 518109. This test facility and site measurement data have been fully placed on file with the FCC and Industry Canada No.: 21600, CABID "HKAP01", "CN0023"..

2.4 Related Submittal Grants

This is a single application for certification of a transceiver (Bluetooth 5.3 Portion).

TEST REPORT

EXHIBIT 3 SYSTEM TEST CONFIGURATION

3.1 Justification

For radiated emissions testing, the equipment under test (EUT) was setup to transmit / receive continuously to simplify the measurement methodology. Care was taken to ensure proper power supply voltages during testing. During testing, all cables (if any) were manipulated to produce worst case emissions.

The EUT is powered by 3.8V Li-ion battery or notebook USB port (5VDC).

For the measurements, the EUT was attached to a plastic stand if necessary and placed on the wooden turntable at 0.8m height from the ground plane for emission testing at or below 1GHz and 1.5m for emission measurements above 1GHz. If the EUT attached to peripherals, they were connected and operational (as typical as possible).

The signal was maximized through rotation and placement in the three orthogonal axes. The antenna height and polarization were varied during the search for maximum signal level. The antenna height was varied from 1 to 4 meters. Radiated emissions were taken at three meters unless the signal level was too low for measurement at that distance. If necessary, a pre-amplifier was used and/or the test was conducted at a closer distance.

For any intentional radiator powered by AC power line, measurements of the radiated signal level of the fundamental frequency component of the emission was performed with the supply voltage varied between 85% and 115% of the nominal rated supply voltage.

For transmitter radiated measurement, the spectrum analyzer resolution bandwidth was 100 kHz for frequencies below 1000 MHz. The resolution bandwidth was 3 MHz for frequencies above 1000 MHz.

Radiated emission measurement for transmitter were performed from the lowest radio frequency signal generated in the device which is greater than 9 kHz to the tenth harmonic of the highest fundamental frequency or to 40 GHz, whichever is lower.

Emission that are directly caused by digital circuits in the transmit path and transmitter portion were measured, and the limit are according to FCC Part 15 Section 15.209 / RSS-247 2.5. Digital circuitries used to control additional functions other than the operation of the transmitter are subject to FCC Part 15 Section 15.109 / RSS-247 Section 5.5 Limits.

TEST REPORT

3.1 Justification (Cont'd)

Detector function for radiated emissions was in peak mode. Average readings, when required, were taken by measuring the duty cycle of the equipment under test and subtracting the corresponding amount in dB from the measured peak readings. A detailed description for the calculation of the average factor can be found in section 4.8.3.

Determination of pulse desensitization was made according to *Hewlett Packard Application Note 150-2, Spectrum Analysis... Pulsed RF*. The effective period (Teff) was referred to Exhibit 4.8.3. With the resolution bandwidth 1MHz and spectrum analyzer IF bandwidth 3dB, the pulse desensitization factor was 0dB.

For AC power line-conducted emission test, the EUT along with its peripherals were placed on a 1.0m(W)x1.5m(L) and 0.8m in height wooden table and the EUT was adjusted to maintain a 0.4 meter space from a vertical reference plane. The EUT was connected to power mains through a line impedance stabilization network (LISN), which provided 50ohm coupling impedance for measuring instrument. The LISN housing, measuring instrument case, reference ground plane, and vertical ground plane were bounded together. The excess power cable between the EUT and the LISN was bundled.

All connecting cables of EUT and peripherals were manipulated to find the maximum emission.

All relevant operation modes have been tested, and the worst-case data is included in this report.

3.2 EUT Exercising Software

The EUT exercise program (AB1565/68 Lab Test Tool-2.11.2) used during radiated and conducted testing was designed to exercise the various system components in a manner similar to a typical use.

TEST REPORT

3.3 Supporting Equipment List and Description

Description	Remark
HUAWEI KLVF-16 Notebook	Provided by UnionTrust
DELL MS111 Mouse	Provided by UnionTrust
0.1m Antenna SMA Cable	Provided by Applicant
0.5m USB Type-C Charging Cable	Provided by Applicant

3.4 Measurement Uncertainty

Decision Rule for compliance: For FCC/IC standard, the measured value must be within the limits of applicable standard without accounting for the measurement uncertainty. For EN/IEC/HKTA/HKTC standard, conformity rules will be used as per standard directly excepted EN/IEC 61000-3-2, EN/IEC 61000-3-3, HKTA1004, HKCA1008, HKTA1019, HKTA1020, HKTA1041 and HKTA1044.

Uncertainty and Compliance - Unless the standard specifically states that measured values are to be extended by the measurement uncertainty in determining compliance, all compliance determinations are based on the actual measured value.

TEST REPORT

EXHIBIT 4 TEST RESULTS

4.1 Maximum Conducted (Peak) Output Power at Antenna Terminals

RF Conducted measurement Test Setup by a Spectrum Analyzer

The figure below shows the test setup, which is utilized to make these measurements.

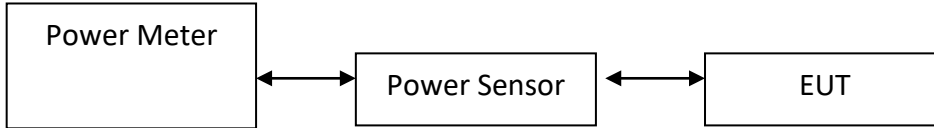

- The antenna power of the EUT was connected to the input of a power meter. Power was read directly and cable loss correction was added to the reading to obtain power at the EUT antenna terminals.
- The antenna port of the EUT was connected to the input of a spectrum analyzer. The analyzer was set for RBW>20dB bandwidth and power was read directly in dBm. External attenuation and cable loss were compensated for using the OFFSET function of the analyzer.

Bluetooth 5.3 Peak Antenna Gain = 4.0 dBi

Frequency (MHz)	Output in dBm	Output in mWatt
Low Channel: 2402	-1.22	0.76
Middle Channel: 2441	-1.68	0.68
High Channel: 2480	-1.89	0.65

Cable loss: 0.5dB External Attenuation: 0dB

Cable loss, external attenuation: included in OFFSET function
 added to SA raw reading

Bluetooth 5.3

Max. Conducted (Peak) Output Level = -1.22 dBm

Limits:

0.125W (21dBm) for antennas with gains of 6dBi or less.

The plots of Conducted (Peak) Output Power are saved as below.

TEST REPORT

PLOTS OF CONDUCTED (PEAK) OUTPUT POWER

Lowest Channel (2402MHz)

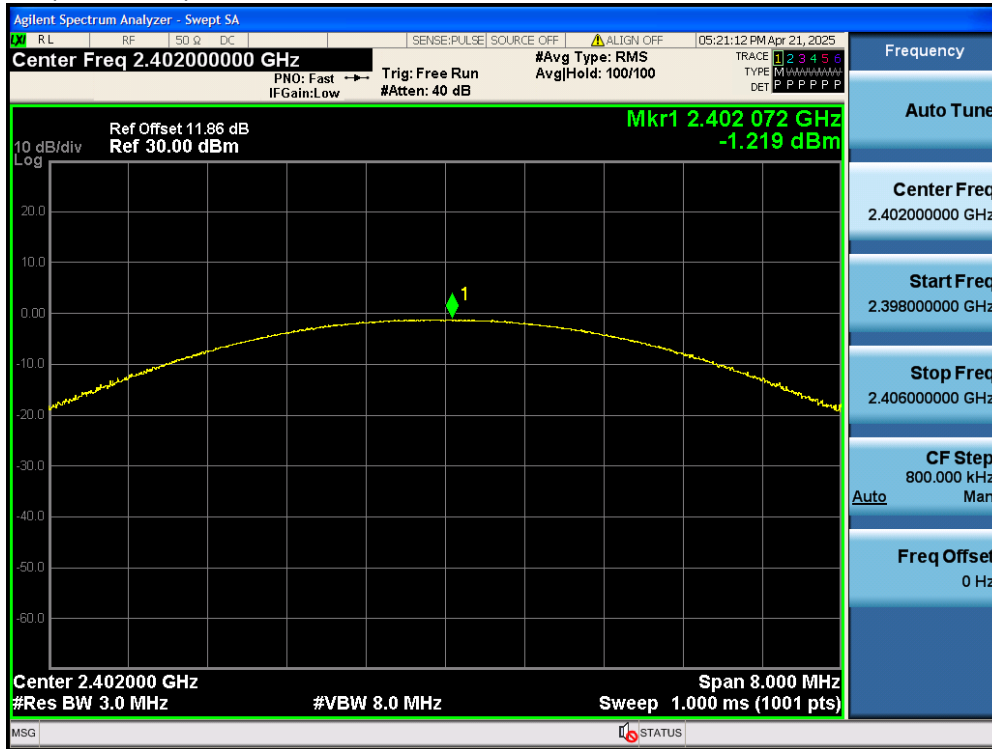

Middle Channel (2441MHz)

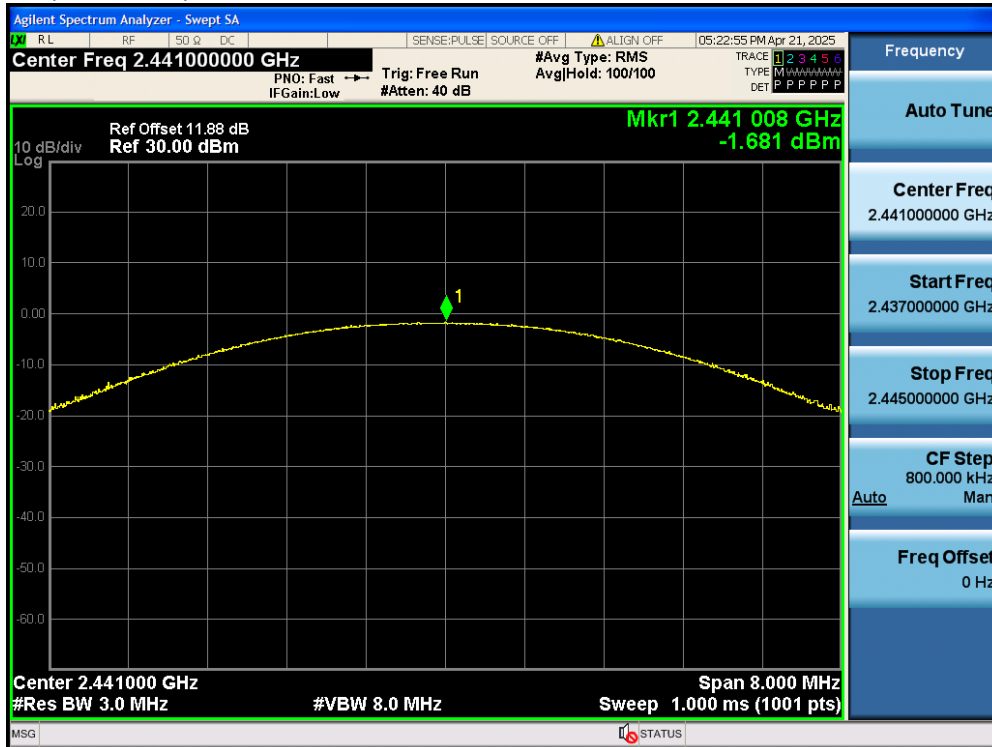

TEST REPORT

PLOTS OF CONDUCTED (PEAK) OUTPUT POWER

Highest Channel (2480MHz)

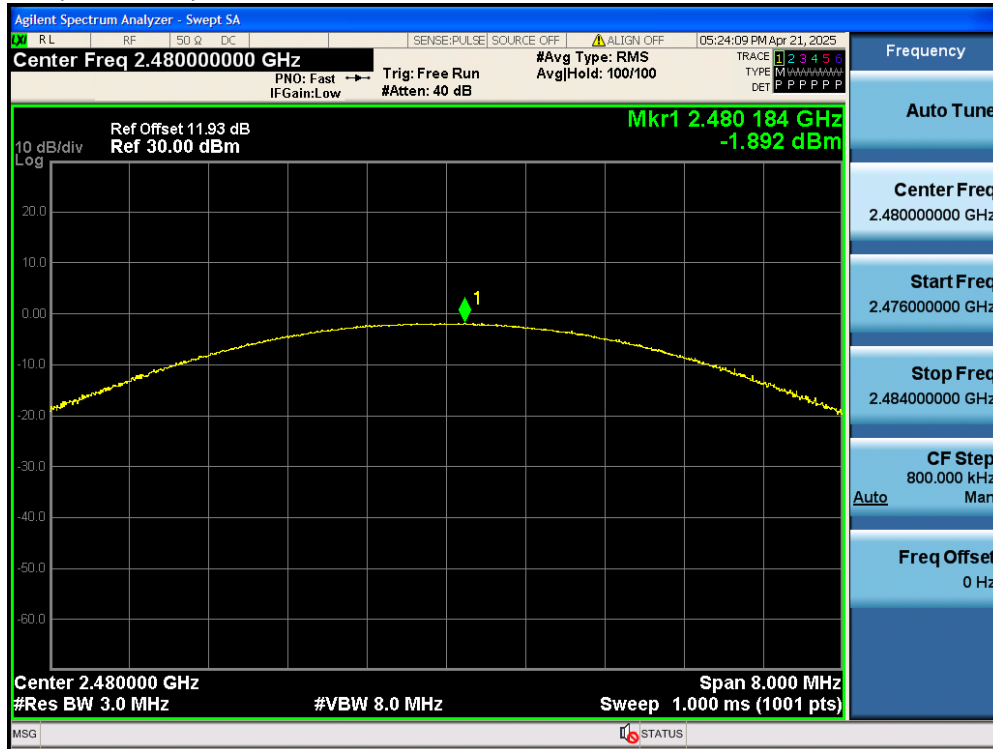

TEST REPORT

4.2 Maximum 20dB RF Bandwidth and Occupied Bandwidth

The figure below shows the test setup, which is utilized to make these measurements.

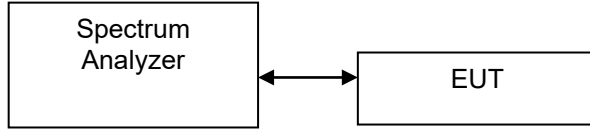

The antenna port of the EUT was connected to the input of a spectrum analyzer. Analyzer RES BW was chosen so that the display was a result of the hopping channel modulation. For each RF output channel investigated, the spectrum analyzer center frequency was set to the channel carrier. A PEAK output reading was taken, a DISPLAY line was drawn 20dB lower than PEAK level. The 20dB bandwidth was determined from where the channel output spectrum intersected the display line.

Bluetooth 5.3		
Frequency (MHz)	20dB Bandwidth (MHz)	Occupied Bandwidth (MHz)
Low Channel: 2402	0.9452	0.89747
Middle Channel: 2441	0.8600	0.86118
High Channel: 2480	0.9087	0.88635

Limits:

N/A for 2400-2483.5MHz

The plots of 20dB bandwidth and occupied bandwidth are saved as below.

TEST REPORT

PLOTS OF 20dB BANDWIDTH & OCCUPIED BANDWIDTH

Lowest Channel (2402MHz)

20dB BANDWIDTH

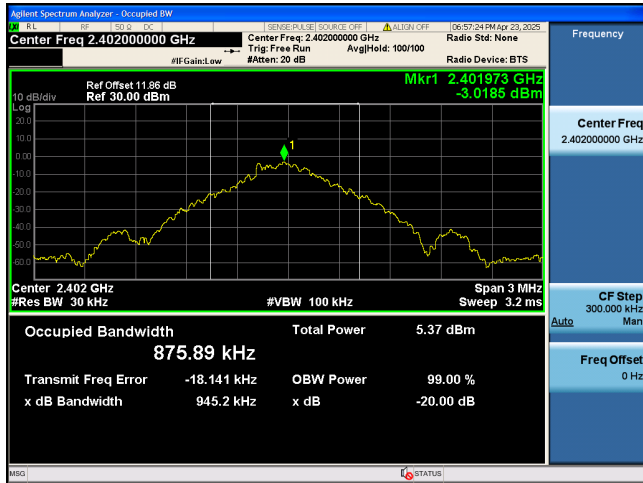

OCCUPIED BANDWIDTH

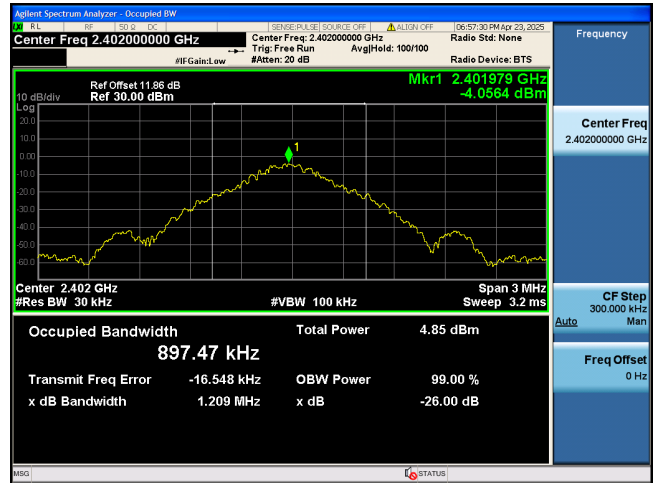

Middle Channel (2441MHz)

20dB BANDWIDTH

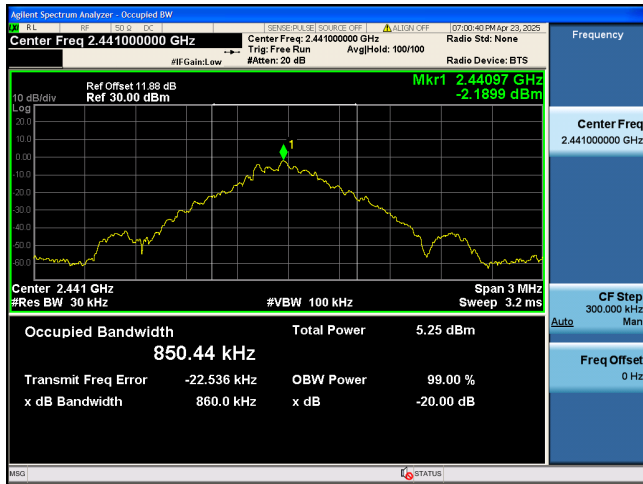

OCCUPIED BANDWIDTH

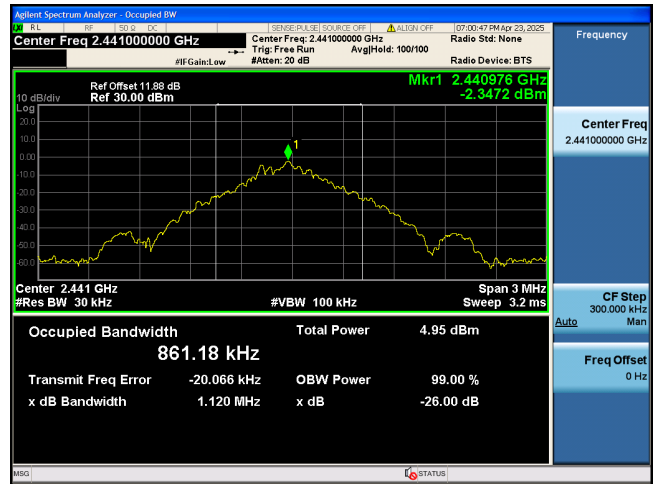

Highest Channel (2480MHz)

20dB BANDWIDTH

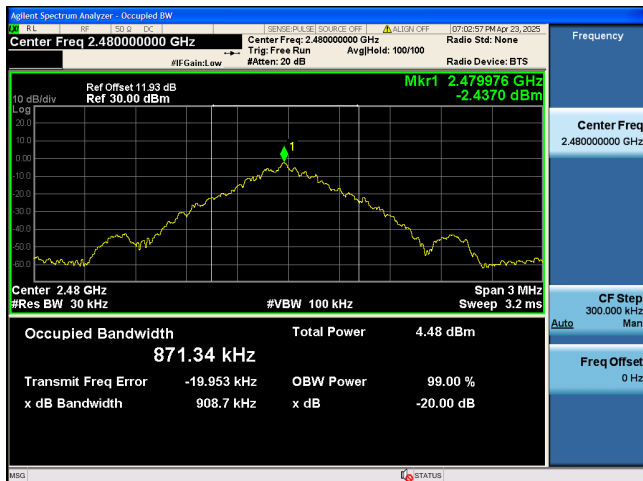

OCCUPIED BANDWIDTH

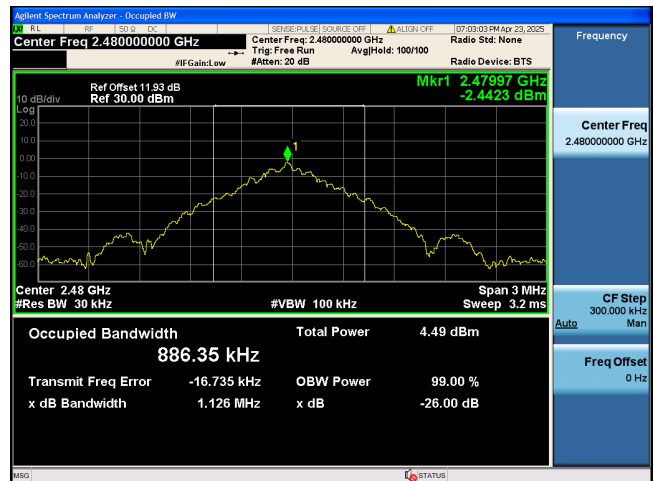

TEST REPORT

4.3 Minimum Number of Hopping Frequencies

The figure below shows the test setup, which is utilized to make these measurements.

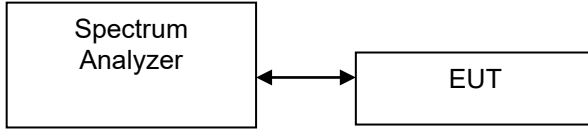

With the analyzer set to MAX HOLD readings were taken for 2-3 minutes in each band. The channel peaks so recorded were added together, and the total number compared to the minimum number of channels required in the regulation.

Bluetooth 5.3	
No. of Hopping Channels:	79

Minimum Requirements:

At least 15 hopping channels for 2400MHz-2483.5MHz

The plots of number of hopping frequencies are saved as below.

TEST REPORT

PLOTS OF NUMBER OF HOPPING FREQUENCIES

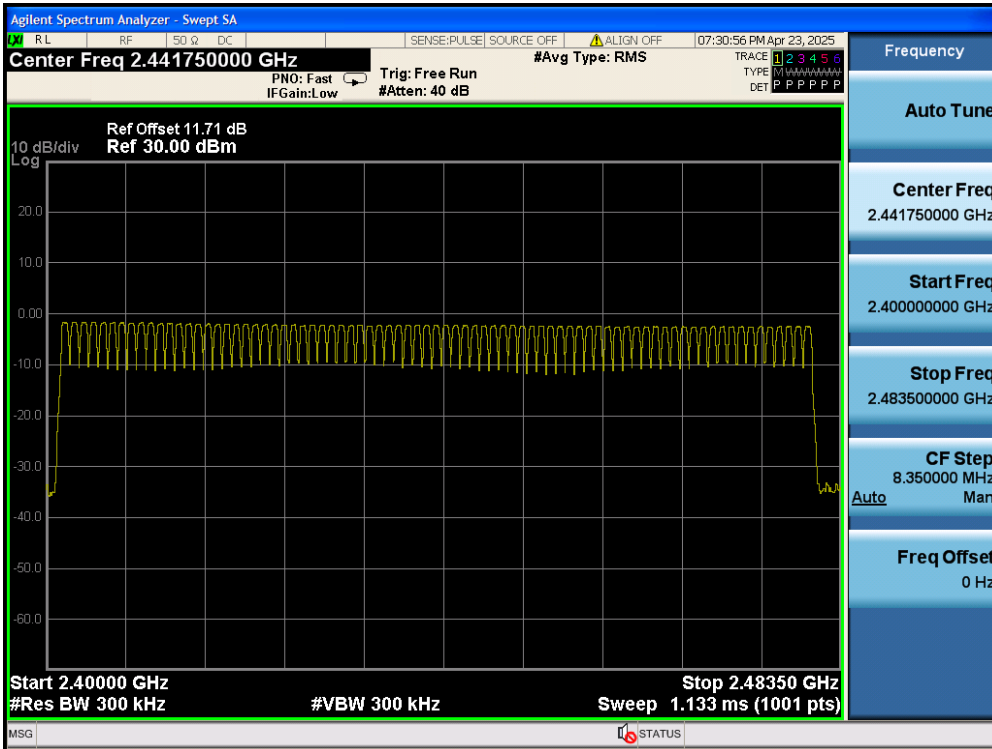

TEST REPORT

4.4 Minimum Hopping Channel Carrier Frequency Separation

The figure below shows the test setup, which is utilized to make these measurements.

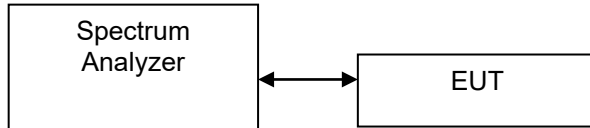

Using the DELTA MARKER function of the analyzer, the frequency separation between two adjacent channels was measured and met the requirement.

Bluetooth 5.3	
Channel Separation (Channel 39 and Channel 40)	1.106MHz

Limits:

The channel separation must be larger than:
2/3 of 20dB bandwidth of hopping channel: 0.6301MHz

The plot(s) of hopping channel carrier frequency separation is saved as below.

TEST REPORT

PLOTS OF HOPPING CHANNEL CARRIER FREQUENCY SEPARATION

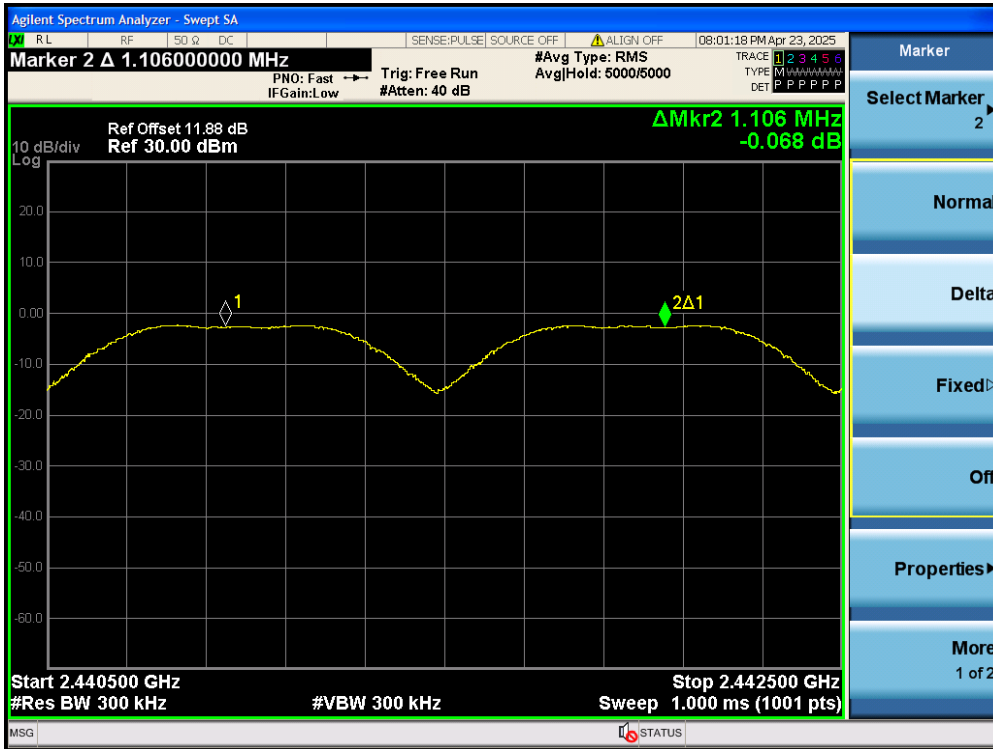

TEST REPORT

4.5 Average Channel Occupancy Time

The figure below shows the test setup, which is utilized to make these measurements.

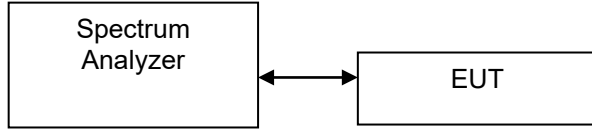

The spectrum analyzer center frequency was set to one of the known hopping channels. The SWEEP was set to 1ms, the SPAN was set to ZERO SPAN, and the TRIGGER was set to VIDEO. The time duration of the transmission so captured was measured with the MARKER DELTA function.

The SWEEP was then set to the time required by the regulation (20 seconds for 902-928 MHz devices, if the 20dB bandwidth is less than 250kHz, 10 seconds for 902-928 MHz if the 20dB bandwidth is or greater than 250kHz, “0.4 seconds x Number of hopping channels employed” seconds for 2400-2483.5 MHz, 30 seconds for 5725-5850 MHz). The analyzer was set to SINGLE SWEEP, the total ON time was added and compared against the limit (0.4 seconds).

Bluetooth 5.3 (Worst-Case)	
Average Occupancy Time (Traffic – in a clear RF environment) =	2.897ms x 107 = 0.310s

Limits:

Average 0.4 seconds maximum occupancy in:
2400MHz-2483.5MHz
(Traffic – in a clear RF environment)

The plots of average channel occupancy time are saved as below.

TEST REPORT

PLOTS OF AVERAGE CHANNEL OCCUPANCY TIME

Plot A

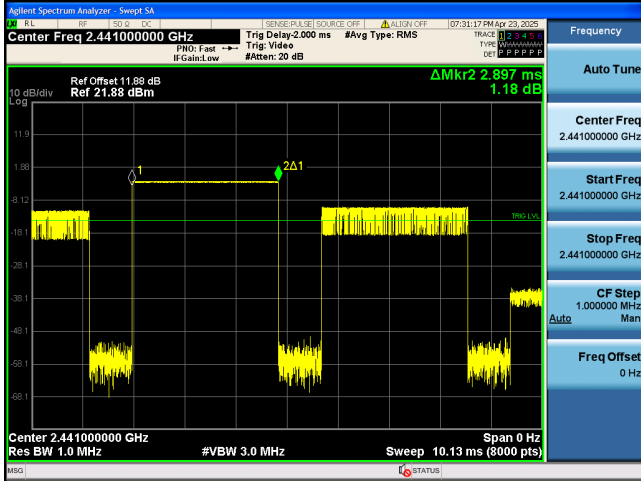

Plot B

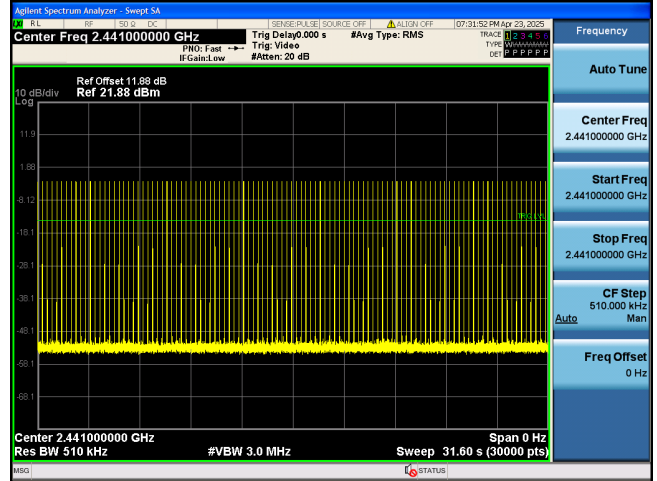

TEST REPORT

4.6 Out of Band Conducted Emissions

The figure below shows the test setup, which is utilized to make these measurements.

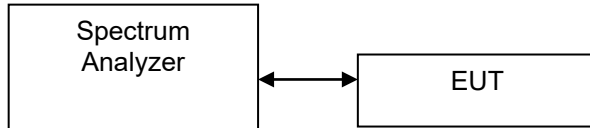

In any 100kHz bandwidth outside the EUT passband, the RF power produced by the modulation products of the spreading sequence, the information sequence, and the carrier frequency shall be at least 20dB below that of the maximum in-band 100 kHz emission.

The plot(s) of bandedge compliance is shown the worst-case which has been already considered between enable and disable the hopping function of the EUT.

Furthermore, delta measurement technique for measuring bandedge emissions was incorporated in the test of the edge at 2483.5MHz.

Limits:

All spurious emission and up to the tenth harmonic was measured and they were found to be at least 20 dB below the highest level of the desired power in the passband.

The plots of out of band conducted emissions are saved as below.

TEST REPORT

PLOTS OF OUT OF BAND CONDUCTED EMISSIONS

**Lowest Channel (2402MHz)
Bandedge (Frequency Dependent)**

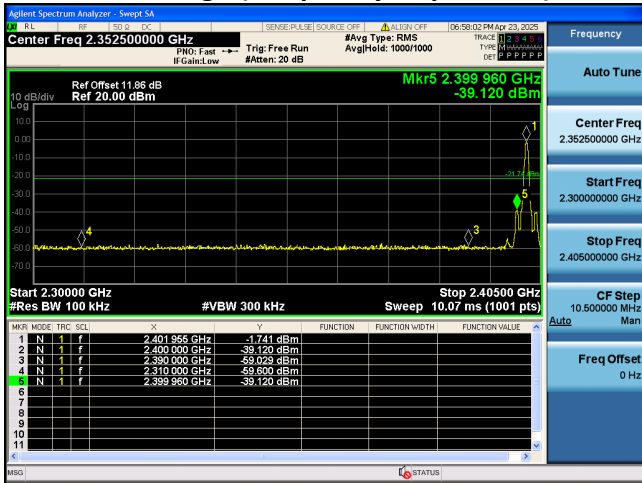

**Lowest Channel (2402MHz)
Bandedge (Frequency Independent)**

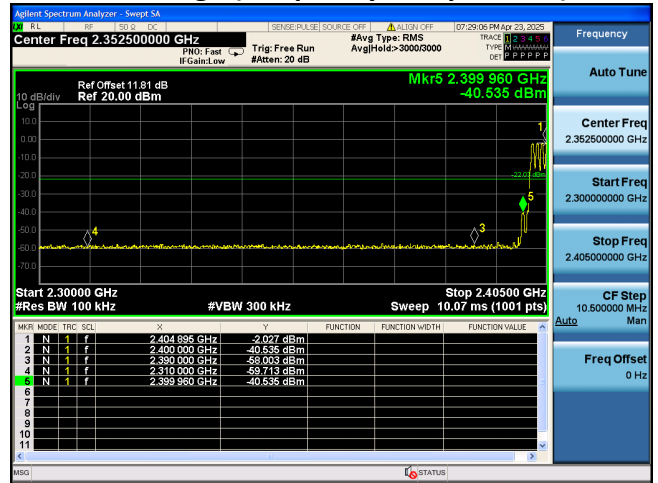

Lowest Channel (2402MHz), Plot A

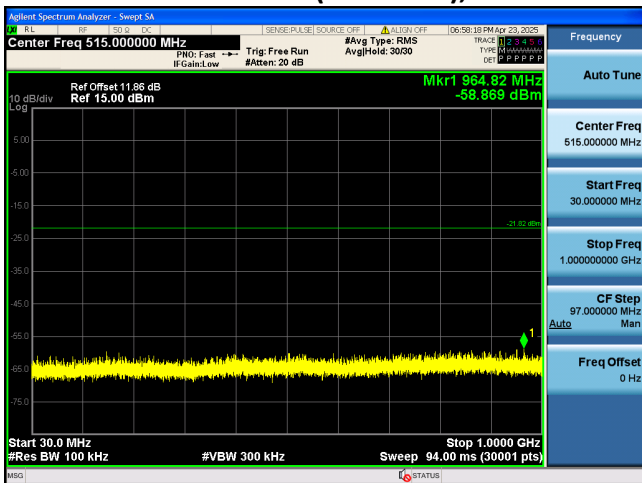

Lowest Channel (2402MHz), Plot B

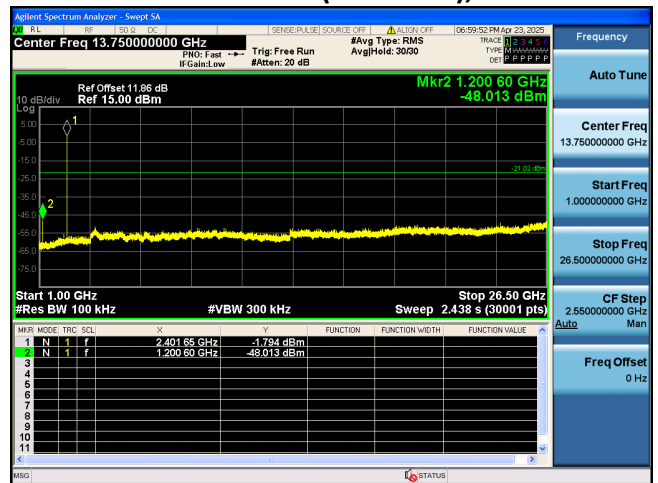

Middle Channel (2441MHz), Plot A

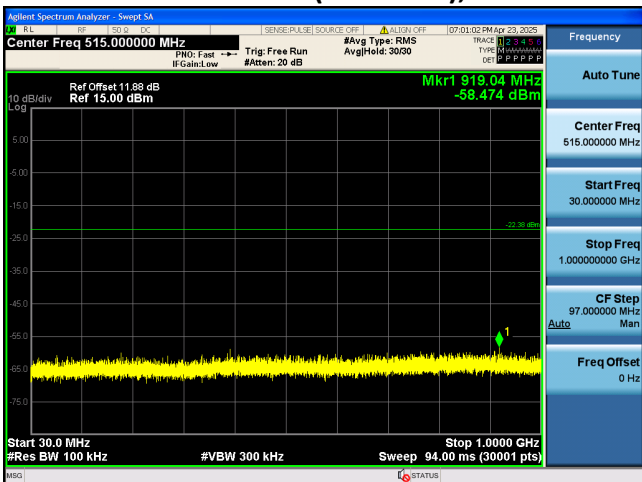

Middle Channel (2441MHz), Plot B

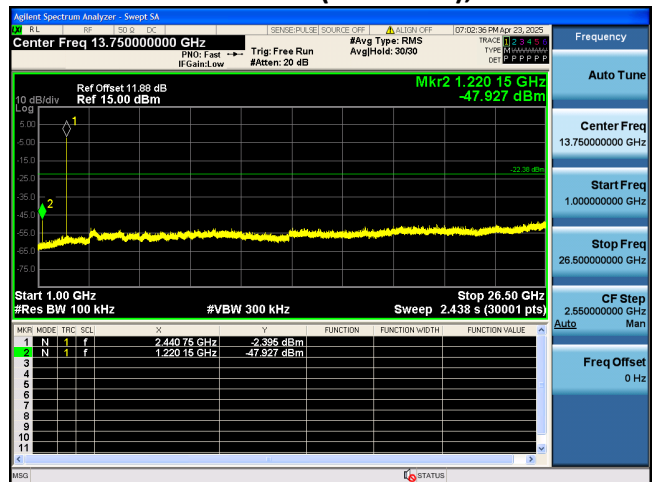

TEST REPORT

PLOTS OF OUT OF BAND CONDUCTED EMISSIONS

Highest Channel (2480MHz)
Bandedge (Frequency Dependent)

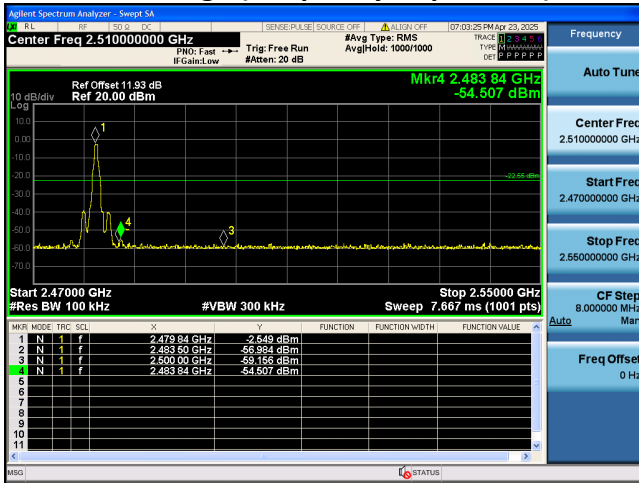

Highest Channel (2480MHz)
Bandedge (Frequency Independent)

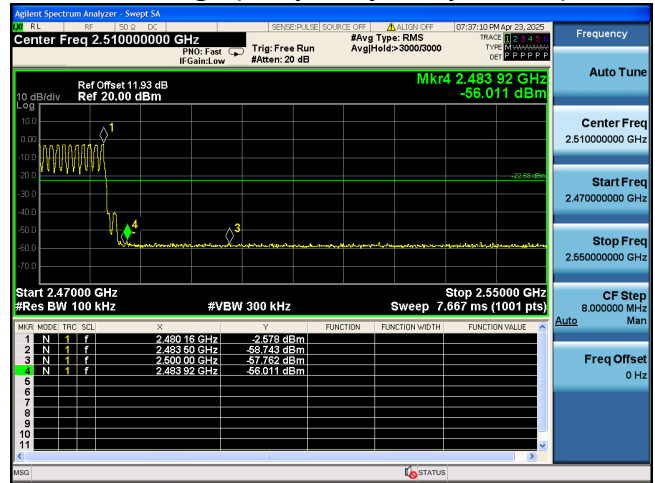

Highest Channel (2480MHz), Plot A

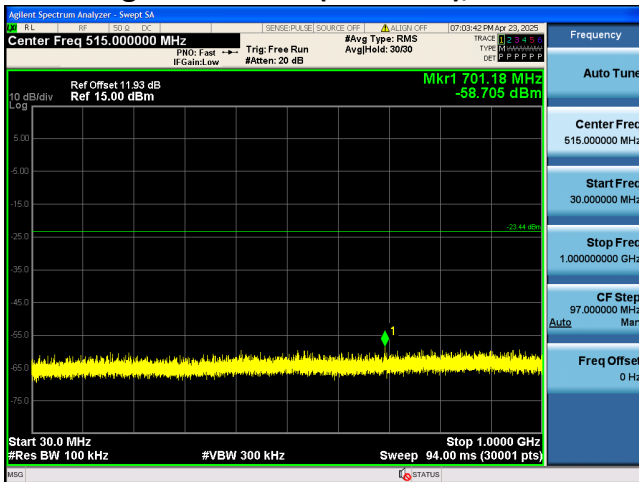

Highest Channel (2480MHz), Plot B

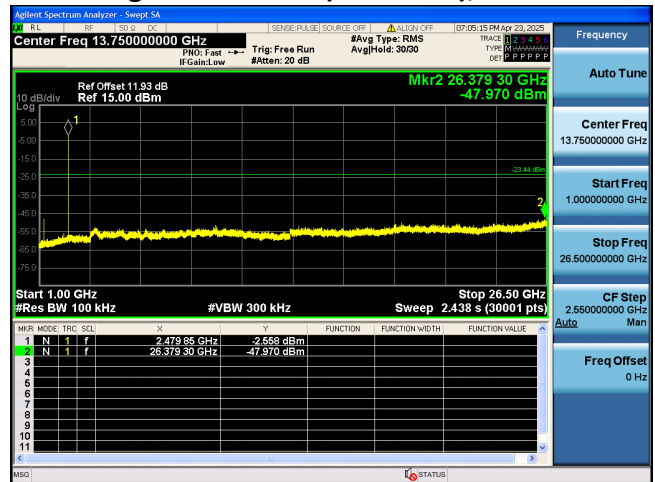

TEST REPORT

4.7 Field Strength Calculation

The field strength is calculated by adding the reading on the Spectrum Analyzer to the factors associated with preamplifiers (if any), antennas, cables, pulse desensitization and average factors (when specified limit is in average and measurements are made with peak detectors). A sample calculation is included below.

$$FS = RA + AF + CF - AG + PD + AV$$

where	FS	=	Field Strength in dB μ V/m
	RA	=	Receiver Amplitude (including preamplifier) in dB μ V
	CF	=	Cable Attenuation Factor in dB
	AF	=	Antenna Factor in dB
	AG	=	Amplifier Gain in dB
	PD	=	Pulse Desensitization in dB
	AV	=	Average Factor in -dB

In the radiated emission table which follows, the reading shown on the data table may reflect the preamplifier gain. An example of the calculations, where the reading does not reflect the preamplifier gain, follows:

$$FS = RA + AF + CF - AG + PD + AV$$

Example:

Assume a receiver reading of 62.0 dB μ V is obtained. The antenna factor of 7.4 dB and cable factor of 1.6 dB is added. The amplifier gain of 29.0 dB is subtracted. The pulse desensitization factor of the spectrum analyzer is 0.0 dB, and the resultant average factor is -10.0 dB. The net field strength for comparison to the appropriate emission limit is 32.0 dB μ V/m. This value in dB μ V/m is converted to its corresponding level in μ V/m.

RA	=	62.0 dB μ V
AF	=	7.4 dB
CF	=	1.6 dB
AG	=	29 dB
PD	=	0.0 dB
AV	=	-10 dB
FS	=	62.0 + 7.4 + 1.6 - 29.0 + 0.0 + (-10.0) = 32.0 dB μ V/m

$$\text{Level in } \mu\text{V/m} = \text{Common Antilogarithm} [(32.0 \text{ dB}\mu\text{V/m})/20] = 39.8 \mu\text{V/m}$$

TEST REPORT**4.8 Transmitter Radiated Emission and Spurious Emission**

Data is included of the worst-case configuration (the configuration which resulted in the highest emission levels). A sample calculation, configuration photographs and data tables of the emissions are included.

The data on the following pages list the significant emission frequencies, the limit and the margin of compliance.

4.8.1 Radiated Emission Configuration Photograph**Worst Case Radiated Emission****7323MHz**

The worst case radiated emission configuration photographs are attached in the Appendix and saved with filename: setup photos.pdf

4.8.2 Radiated Emission Data

The data in tables 1-4 list the significant emission frequencies, the limit and the margin of compliance.

Judgement –**Passed by 10.6 dB**

TEST REPORT

4.8.3 Radiated Emission Test Setup

The figure below shows the test setup, which is utilized to make these measurements.

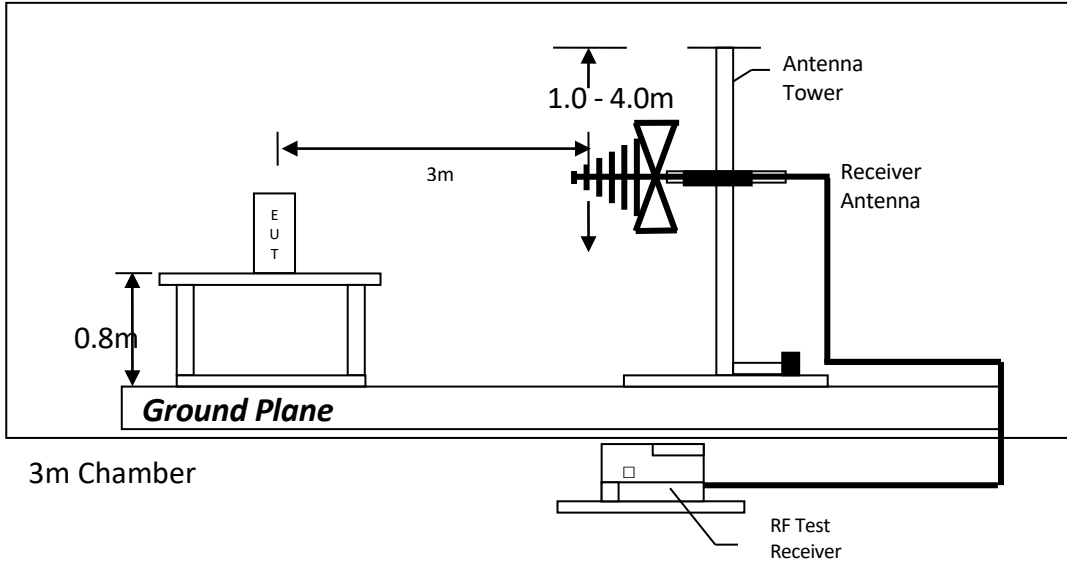

Test setup of radiated emissions up to 1GHz

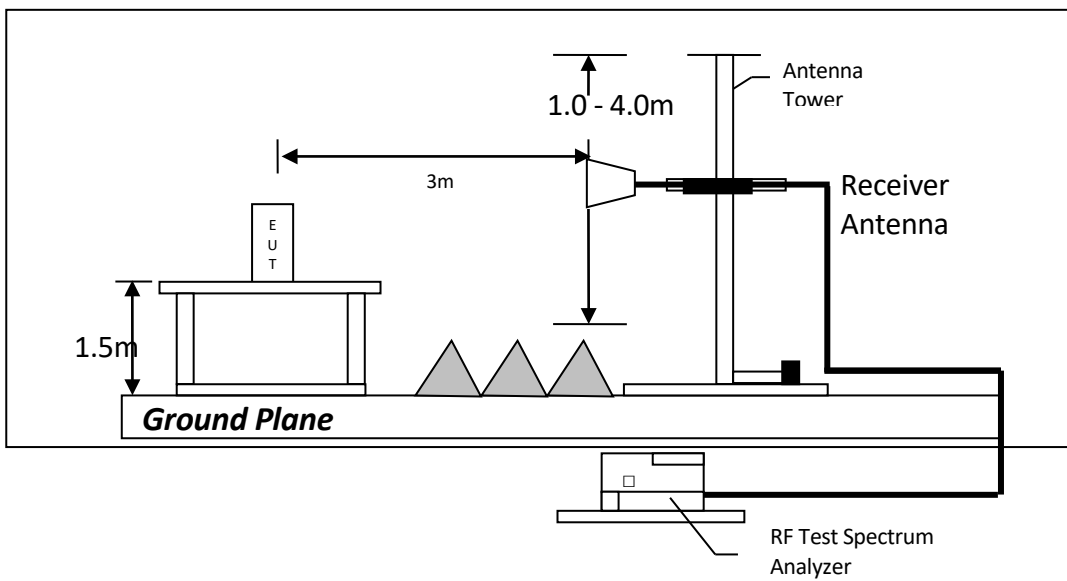

Test setup of radiated emissions above 1GHz

TEST REPORT

RADIATED EMISSION DATA

Table 1:								
No.	Frequency (MHz)	Reading (dBμV)	Correction factor (dB/m)	Result (dBμV/m)	Limit (dBμV/m)	Margin (dB)	Detector	Antenna Polaxis
DH5_2402 MHz								
1	4804	41.57	-2.08	39.49	54.00	-14.51	Average	Horizontal
2	4804	46.87	-2.08	44.79	74.00	-29.21	Peak	Horizontal
3	7206	41.46	1.30	42.76	54.00	-11.24	Average	Horizontal
4	7206	47.49	1.30	48.79	74.00	-25.21	Peak	Horizontal
5	4804	40.20	-2.08	38.12	54.00	-15.88	Average	Vertical
6	4804	46.87	-2.08	44.79	74.00	-29.21	Peak	Vertical
7	7206	41.88	1.30	43.18	54.00	-10.82	Average	Vertical
8	7206	46.39	1.30	47.69	74.00	-26.31	Peak	Vertical
DH5_2441 MHz								
1	4882	41.08	-2.05	39.03	54.00	-14.97	Average	Horizontal
2	4882	45.94	-2.05	43.89	74.00	-30.11	Peak	Horizontal
3	7323	42.08	1.31	43.39	54.00	-10.61	Average	Horizontal
4	7323	46.83	1.31	48.14	74.00	-25.86	Peak	Horizontal
5	4882	41.00	-2.05	38.95	54.00	-15.05	Average	Vertical
6	4882	46.45	-2.05	44.40	74.00	-29.60	Peak	Vertical
7	7323	40.12	1.31	41.43	54.00	-12.57	Average	Vertical
8	7323	46.29	1.31	47.60	74.00	-26.40	Peak	Vertical
DH5_2480 MHz								
1	4960	39.23	-2.02	37.21	54.00	-16.79	Average	Horizontal
2	4960	45.84	-2.02	43.82	74.00	-30.18	Peak	Horizontal
3	7440	41.42	1.32	42.74	54.00	-11.26	Average	Horizontal
4	7440	46.75	1.32	48.07	74.00	-25.93	Peak	Horizontal
5	4960	40.24	-2.02	38.22	54.00	-15.78	Average	Vertical
6	4960	44.87	-2.02	42.85	74.00	-31.15	Peak	Vertical
7	7440	40.98	1.32	42.30	54.00	-11.70	Average	Vertical
8	7440	45.21	1.32	46.53	74.00	-27.47	Peak	Vertical

- Notes:
1. Peak detector is used for the emission measurement.
 2. Average detector is used for the average data of emission measurement.
 3. All measurements were made at 3 meters.
 4. Negative value in the margin column shows emission below limit.
 5. Horn antenna is used for the emission over 1000MHz.
 6. Emissions within the restricted band meets the requirement of FCC Part 15 Section 15.205 / RSS-Gen Section 8.10.
 7. Correct Factor = Antenna Factor + Cable Loss - Amplifier Gain, the value was added to Original Receiver Reading by the software automatically.

TEST REPORT

RADIATED EMISSION DATA (BAND EDGE MEASUREMENTS)

Table 2, DH5_2402 MHz

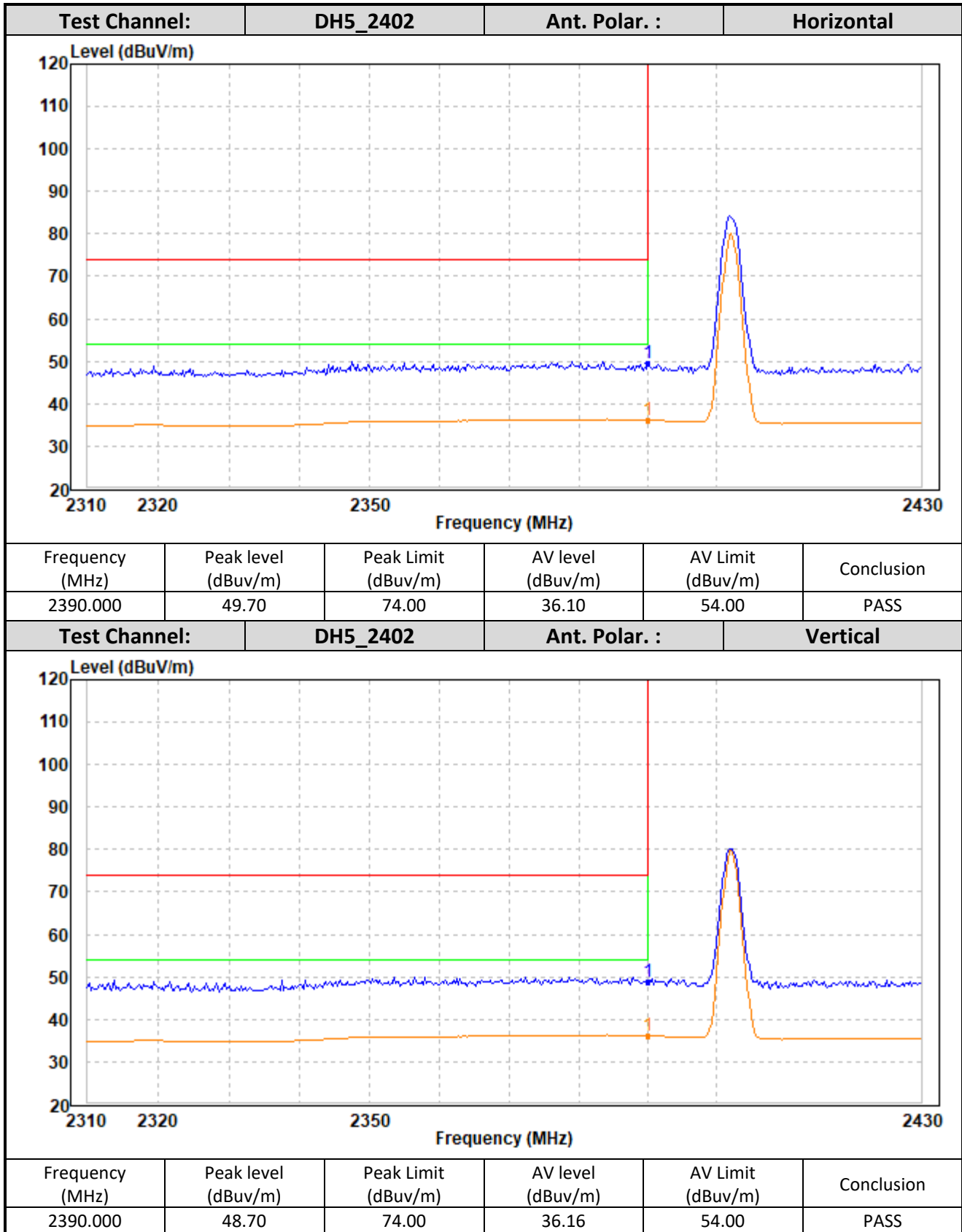

TEST REPORT

RADIATED EMISSION DATA (BAND EDGE MEASUREMENTS)

Table 3, DH5_2480 MHz

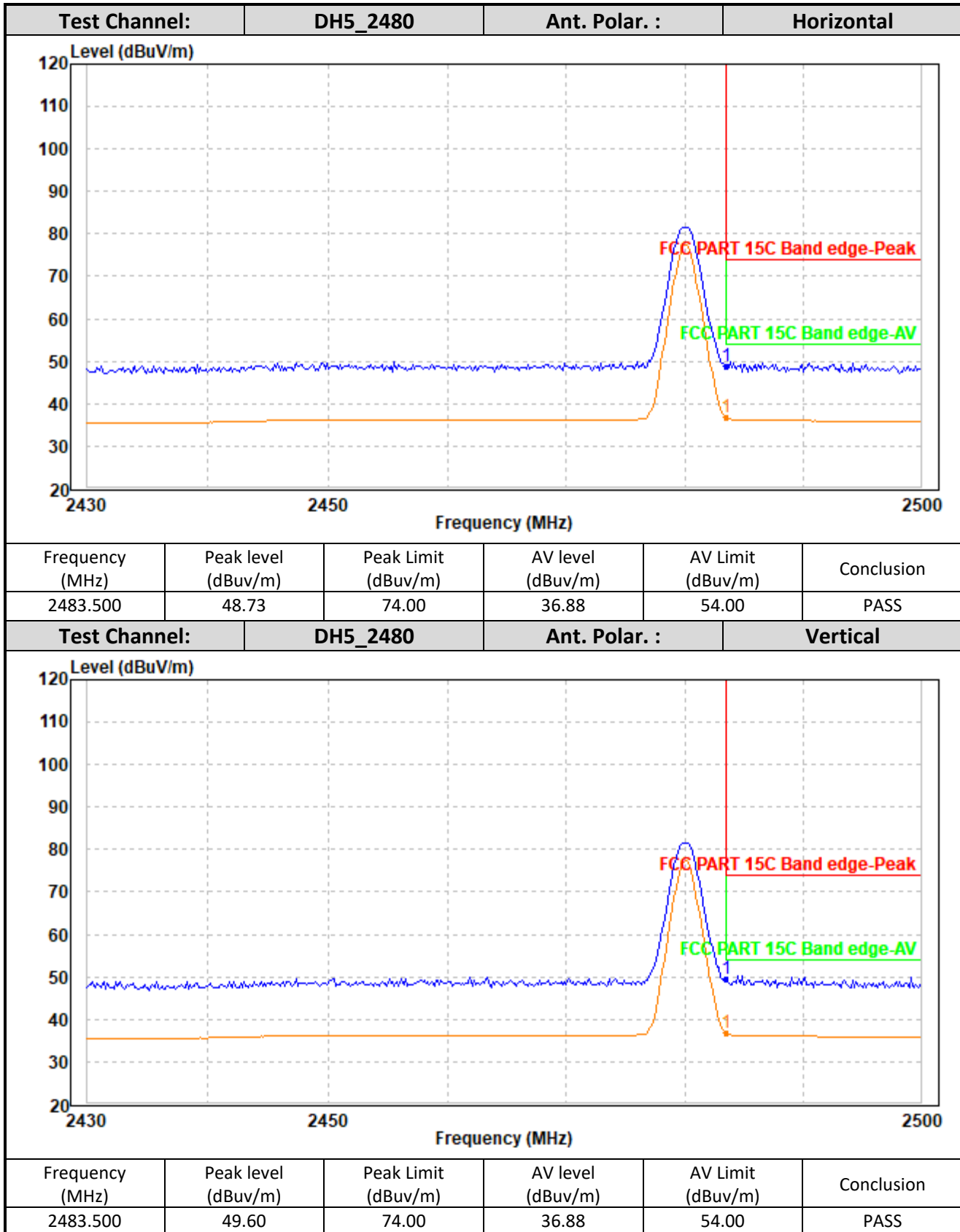

TEST REPORT

RADIATED EMISSION DATA

Mode: Bluetooth 5.3 Link

Table 4:							
Horizontal							
No.	Frequency (MHz)	Reading (dB μ V/m)	Correction factor (dB/m)	Result (dB μ V/m)	Limit (dB μ V/m)	Margin (dB)	Detector
1	51.176	36.56	-14.01	22.55	40.00	-17.45	QP
2	119.767	37.61	-15.29	22.32	43.50	-21.18	QP
3	208.658	39.42	-10.99	28.43	43.50	-15.07	QP
4	315.860	35.75	-8.41	27.34	46.00	-18.66	QP
5	398.296	35.34	-4.87	30.47	46.00	-15.53	QP
6	765.648	30.92	2.26	33.18	46.00	-12.82	QP
Vertical							
No.	Frequency (MHz)	Reading (dB μ V/m)	Correction factor (dB/m)	Result (dB μ V/m)	Limit (dB μ V/m)	Margin (dB)	Detector
1	30.212	28.88	-4.47	24.41	40.00	-15.59	QP
2	45.413	34.43	-12.39	22.04	40.00	-17.96	QP
3	204.305	34.09	-11.05	23.04	43.50	-20.46	QP
4	324.864	30.67	-7.92	22.75	46.00	-23.25	QP
5	415.449	35.46	-4.39	31.07	46.00	-14.93	QP
6	760.287	28.47	2.04	30.51	46.00	-15.49	QP

- Notes:
1. Quasi-Peak detector are used for the emission measurement.
 2. All measurements were made at 3 meters.
 3. Negative value in the margin column shows emission below limit.
 4. Emissions within the restricted band meets the requirement of FCC Part 15 Section 15.205 / RSS-Gen Section 8.10.
 5. Measurement Uncertainty is ± 5.3 dB at a level of confidence of 95%.

TEST REPORT

4.9 AC Power Line Conducted Emission

EUT connects to AC power line. Emission Data is listed in following pages.

4.9.1 AC Power Line Conducted Emission Configuration Photograph

Worst Case Line-Conducted Configuration

at 2.3864 MHz

The worst-case line conducted configuration photographs are attached in the Appendix and saved with filename: setup photos.pdf.

4.9.2 AC Power Line Conducted Emission Data

The plot(s) and data in the following pages list the significant emission frequencies, the limit and the margin of compliance.

Passed by 10.98 dB margin compare with CISPR Average limit.

4.9.3 Conducted Emission Test Setup

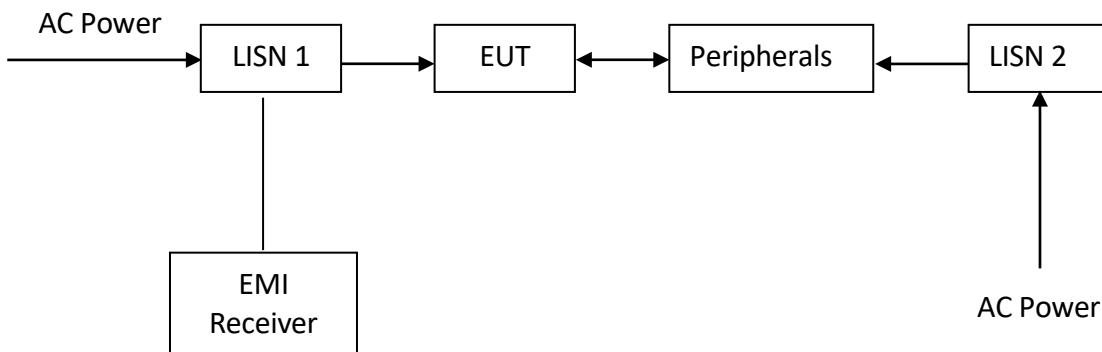

The EUT along with its peripherals were placed on a 1.0m(W)×1.5m(L) and 0.8m in height wooden table and the EUT was adjusted to maintain a 0.4 meter space from a vertical reference plane. The EUT was connected to power mains through a line impedance stabilization network (LISN), which provided 50 ohm coupling impedance for measuring instrument and the chassis ground was bounded to the horizontal ground plane of shielded room. The excess power cable between the EUT and the LISN was bundled.

All connecting cables of EUT and peripherals were moved to find the maximum emission.

TEST REPORT

AC POWER LINE CONDUCTED EMISSION

Worst Case: Bluetooth 5.3 Link (N)

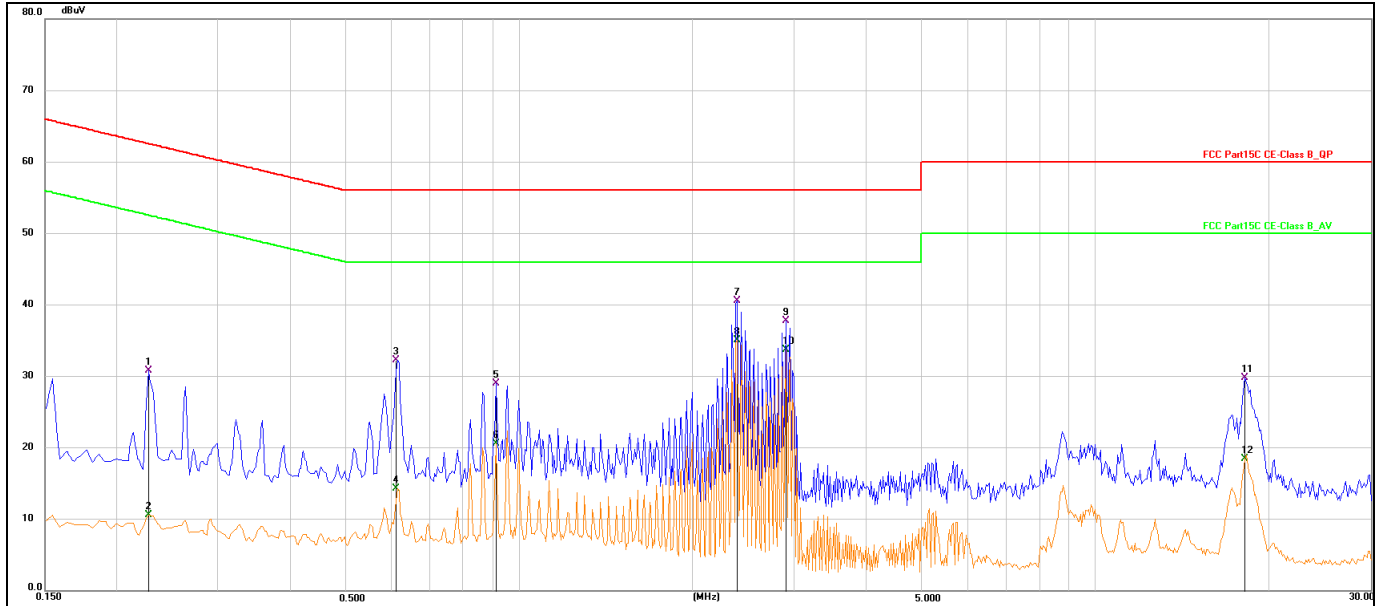

No.	Frequency (MHz)	Reading (dBuV)	Correct (dB)	Result (dBuV)	Limit (dBuV)	Margin (dB)	Remark
1	0.2265	21.01	9.78	30.79	62.58	-31.79	QP
2	0.2265	0.87	9.78	10.65	52.58	-41.93	AVG
3	0.6134	22.53	9.74	32.27	56.00	-23.73	QP
4	0.6134	4.52	9.74	14.26	46.00	-31.74	AVG
5	0.9104	19.25	9.75	29.00	56.00	-27.00	QP
6	0.9104	10.79	9.75	20.54	46.00	-25.46	AVG
7	2.3864	30.81	9.75	40.56	56.00	-15.44	QP
8	2.3864	25.27	9.75	35.02	46.00	-10.98	AVG
9	2.9040	28.06	9.75	37.81	56.00	-18.19	QP
10	2.9040	23.99	9.75	33.74	46.00	-12.26	AVG
11	18.2085	20.01	9.83	29.84	60.00	-30.16	QP
12	18.2085	8.61	9.83	18.44	50.00	-31.56	AVG

TEST REPORT

AC POWER LINE CONDUCTED EMISSION

Worst Case: Bluetooth 5.3 Link (L1)

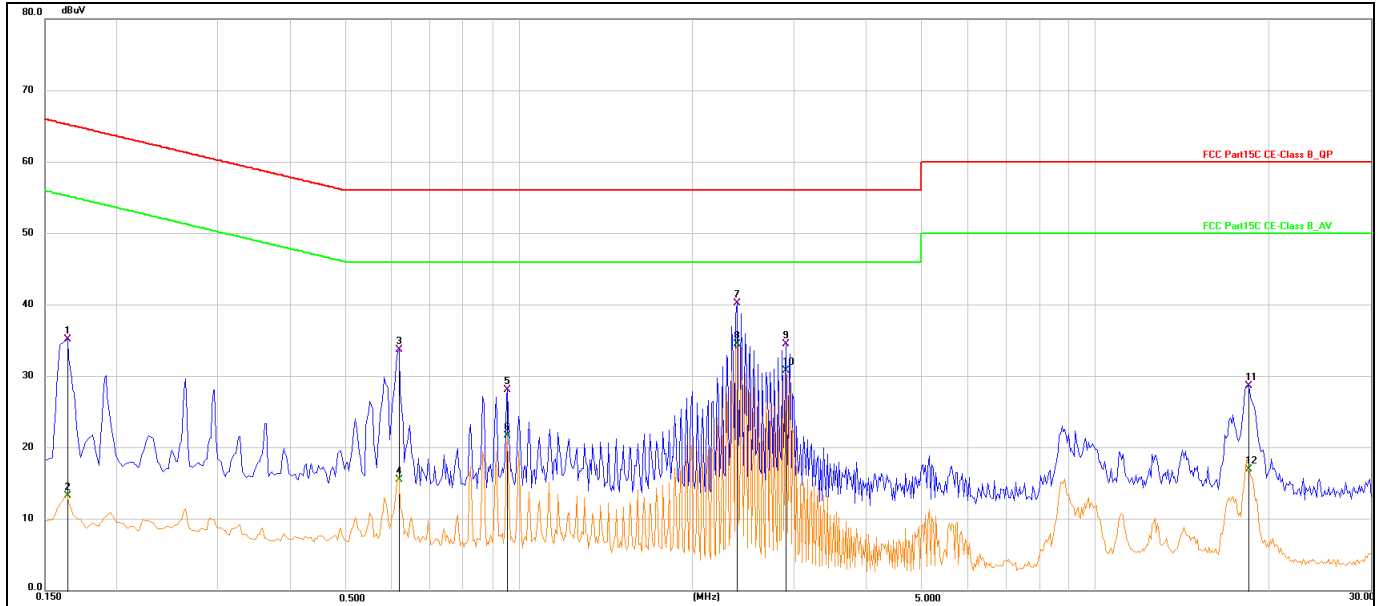

No.	Frequency (MHz)	Reading (dBuV)	Correct (dB)	Result (dBuV)	Limit (dBuV)	Margin (dB)	Remark
1	0.1635	25.34	9.81	35.15	65.28	-30.13	QP
2	0.1635	3.54	9.81	13.35	55.28	-41.93	AVG
3	0.6180	23.91	9.79	33.70	56.00	-22.30	QP
4	0.6180	5.70	9.79	15.49	46.00	-30.51	AVG
5	0.9555	18.45	9.71	28.16	56.00	-27.84	QP
6	0.9555	11.95	9.71	21.66	46.00	-24.34	AVG
7	2.3865	30.51	9.72	40.23	56.00	-15.77	QP
8	2.3865	24.81	9.72	34.53	46.00	-11.47	AVG
9	2.9040	24.78	9.73	34.51	56.00	-21.49	QP
10	2.9040	21.09	9.73	30.82	46.00	-15.18	AVG
11	18.4695	18.73	9.89	28.62	60.00	-31.38	QP
12	18.4695	7.09	9.89	16.98	50.00	-33.02	AVG

TEST REPORT

EXHIBIT 5 EQUIPMENT LIST

Radiated Emission Test Equipment List						
Used	Equipment	Manufacturer	Model No.	Serial Number	Cal. date	Cal. Due date
<input checked="" type="checkbox"/>	3m SAC	ETS-LINDGREN	3M	Euroshiedpn-CT001270-1317	11-Nov-2023	10-Nov-2026
<input checked="" type="checkbox"/>	Receiver	R&S	ESIB26	100114	25-Oct-2024	24-Oct-2025
<input checked="" type="checkbox"/>	EXA Spectrum Analyzer	KEYSIGHT	N9010A	MY51440197	28-Mar-2025	27-Mar-2026
<input checked="" type="checkbox"/>	Loop Antenna	ETS-LINDGREN	6502	00202525	28-Oct-2024	27-Oct-2025
<input checked="" type="checkbox"/>	Broadband Antenna	ETS-LINDGREN	3142E	00201566	29-Oct-2024	28-Oct-2025
<input checked="" type="checkbox"/>	6dB Attenuator	Talent	RA6A5-N-18	18103001	29-Oct-2024	28-Oct-2025
<input checked="" type="checkbox"/>	Preamplifier	HP	8447F	2805A02960	25-Oct-2024	24-Oct-2025
<input checked="" type="checkbox"/>	Double-Ridged Waveguide Horn Antenna (Pre-amplifier)	ETS-LINDGREN	3117-PA	00201541	29-Mar-2025	28-Mar-2026
<input checked="" type="checkbox"/>	Pre-amplifier	ETS-Lindgren	00118385	00201874	28-Mar-2025	27-Mar-2026
<input checked="" type="checkbox"/>	Double-Ridged Waveguide Horn Antenna (Pre-amplifier)	ETS-LINDGREN	3116C-PA	00202652	28-Oct-2024	27-Oct-2025
<input checked="" type="checkbox"/>	Pre-amplifier	ETS-Lindgren	00118384	00202652	28-Oct-2024	27-Oct-2025
<input checked="" type="checkbox"/>	Band Reject Filter (2400MHz~2500MHz)	Micro-Tronics	BRM50702	G590	21-Feb-2025	20-Feb-2026
<input checked="" type="checkbox"/>	Multi device Controller	ETS-LINDGREN	7006-001	00160105	N/A	N/A
<input checked="" type="checkbox"/>	Test Software	Audix	e3	Software Version: 9.160323		

Conducted Emission Test Equipment List						
Used	Equipment	Manufacturer	Model No.	Serial Number	Cal. date	Cal. Due date
<input checked="" type="checkbox"/>	Receiver	R&S	ESC13	1166.5950.03	25-Oct-2024	24-Oct-2025
<input checked="" type="checkbox"/>	Pulse Limiter	R&S	ESH3-Z2	0357.8810.54	25-Oct-2024	24-Oct-2025
<input checked="" type="checkbox"/>	LISN	R&S	EVN216	3560.6550.12	26-Sep-2024	25-Sep-2025
<input checked="" type="checkbox"/>	Test Software	EZ-EMC	EZ-CON	Software Version: EMC-CON 3A1.1		

RF Conducted Test Equipment List						
Used	Equipment	Manufacturer	Model No.	Serial Number	Cal. date	Cal. Due date
<input checked="" type="checkbox"/>	EXA Spectrum Analyzer	KEYSIGHT	N9020A	MY51286807	25-Oct-2024	24-Oct-2025
<input checked="" type="checkbox"/>	USB Wideband Power Sensor	KEYSIGHT	U2021XA	MY55430035	25-Oct-2024	24-Oct-2025
<input checked="" type="checkbox"/>	Test Software	Tonscend	JS1120-3 Test System	Software Version: V3.5.39(BT&WIFI)		

END OF TEST REPORT