

FCC RADIO TEST REPORT

FCC 47 CFR PART 15 SUBPART C

Test Standard	FCC Part 15.247
Brand name	 precision · technology · simplified
Product name	Harvey Surgical Assistant Navigation Unit
Model No.	405061
Test Result	Pass
Statements of Conformity	Determination of compliance is based on the results of the compliance measurement, not taking into account measurement instrumentation uncertainty.

The test Result was tested by Compliance Certification Services Inc. The test data, data evaluation, test procedures, and equipment configurations shown in this report were given in ANSI C63.10: 2013 and compliance standards.

The test results of this report relate only to the tested sample (EUT) identified in this report.

The test Report of full or partial shall not copy. Without written approval of Compliance Certification Services Inc. (Wugu Laboratory)

Approved by:



Kevin Tsai
Deputy Manager

Unless otherwise stated the results shown in this test report refer only to the sample(s) tested and such sample(s) are retained for 90 days only.
除非另有說明，此報告結果僅對測試之樣品負責，同時此樣品僅保留90天。本報告未經本公司書面許可，不可部分複製。

This document is issued by the Company subject to its General Conditions of Service printed overleaf, available on request or accessible at www.sgs.com/terms_and_conditions.htm and for electronic format documents, subject to Terms and Conditions for Electronic Documents at www.sgs.com/terms_e-document.htm. Attention is drawn to the limitation of liability, indemnification and jurisdiction issues defined therein. Any holder of this document is advised that information contained hereon reflects the Company's findings at the time of its intervention only and within the limits of Client's instructions, if any. The Company's sole responsibility is to its Client and this document does not exonerate parties to a transaction from exercising all their rights and obligations under the transaction documents. This document cannot be reproduced except in full, without prior written approval of the Company. Any unauthorized alteration, forgery or falsification of the content or appearance of this document is unlawful and offenders may be prosecuted to the fullest extent of the law.



Report No.: T191218D03-RP3

Page 2 / 84
Rev. 00

Revision History

Rev.	Issue Date	Revisions	Effect Page	Revised By
00	February 04, 2020	Initial Issue	ALL	May Lin

Table of contents

1.	GENERAL INFORMATION.....	4
1.1	EUT INFORMATION.....	4
1.2	EUT CHANNEL INFORMATION.....	5
1.3	ANTENNA INFORMATION.....	5
1.4	MEASUREMENT UNCERTAINTY	6
1.5	FACILITIES AND TEST LOCATION.....	7
1.6	INSTRUMENT CALIBRATION	8
1.7	SUPPORT AND EUT ACCESSORIES EQUIPMENT	9
1.8	TEST METHODOLOGY AND APPLIED STANDARDS.....	9
2.	TEST SUMMERY.....	10
3.	DESCRIPTION OF TEST MODES.....	11
3.1	THE WORST MODE OF OPERATING CONDITION	11
3.2	THE WORST MODE OF MEASUREMENT.....	12
3.3	EUT DUTY CYCLE	13
4.	TEST RESULT.....	14
4.1	AC POWER LINE CONDUCTED EMISSION.....	14
4.2	6DB BANDWIDTH AND OCCUPIED BANDWIDTH(99%).....	15
4.3	OUTPUT POWER MEASUREMENT	25
4.4	POWER SPECTRAL DENSITY	28
4.5	CONDUCTED BANDEDGE AND SPURIOUS EMISSION.....	34
4.6	RADIATION BANDEDGE AND SPURIOUS EMISSION.....	47
APPENDIX 1 - PHOTOGRAPHS OF EUT		



Report No.: T191218D03-RP3

1. GENERAL INFORMATION

1.1 EUT INFORMATION

Applicant	OrthAlign Inc. 120 Columbia, Suite 500 Aliso Viejo, CA 92656 USA											
Manufacturer	OrthAlign Inc. 120 Columbia, Suite 500 Aliso Viejo, CA 92656 USA											
Equipment	Harvey Surgical Assistant Navigation Unit											
Model Name	405061											
Model Discrepancy	N/A											
Trade Name	 OrthAlign <small>precision · technology · simplified</small>											
Received Date	December 18, 2019											
Date of Test	December 31, 2019 ~ January 13, 2020											
Output Power (W)	<table border="1"> <thead> <tr> <th>Mode</th> <th>Output Power (W)</th> </tr> </thead> <tbody> <tr> <td>IEEE 802.11b Mode</td> <td>0.0805</td> </tr> <tr> <td>IEEE 802.11g Mode</td> <td>0.2123</td> </tr> <tr> <td>IEEE 802.11n HT20 Mode</td> <td>0.2291</td> </tr> <tr> <td>IEEE 802.11n HT40 Mode</td> <td>0.2138</td> </tr> </tbody> </table>		Mode	Output Power (W)	IEEE 802.11b Mode	0.0805	IEEE 802.11g Mode	0.2123	IEEE 802.11n HT20 Mode	0.2291	IEEE 802.11n HT40 Mode	0.2138
Mode	Output Power (W)											
IEEE 802.11b Mode	0.0805											
IEEE 802.11g Mode	0.2123											
IEEE 802.11n HT20 Mode	0.2291											
IEEE 802.11n HT40 Mode	0.2138											
Power Supply	Power from Rechargeable Li-polymer Battery—alternate Brand name: Energizer Model name: Ultimate Lithium Rating: 4.5V/ 9000mAh											

Report No.: T191218D03-RP3

1.2 EUT CHANNEL INFORMATION

Frequency Range	802.11b/g/n HT20: 2412MHz ~ 2462MHz 802.11n HT40: 2422MHz ~ 2452MHz
Modulation Type	1. IEEE 802.11b Mode: DSSS(DBPSK/DQPSK/CCK) 2. IEEE 802.11g Mode: OFDM (BPSK/QPSK/16QAM/64QAM) 3. IEEE 802.11n HT20 Mode: OFDM (BPSK/QPSK/16QAM/64QAM) 4. IEEE 802.11n HT40 Mode: OFDM (BPSK/QPSK/16QAM/64QAM)
Number of channels	1. IEEE 802.11b Mode: 11 Channels 2. IEEE 802.11g Mode: 11 Channels 3. IEEE 802.11n HT20 Mode : 11 Channels 4. IEEE 802.11n HT40 Mode : 7 Channels

Remark:

Refer as ANSI C63.10: 2013 clause 5.6.1 Table 4 for test channels

Number of frequencies to be tested		
Frequency range in which device operates	Number of frequencies	Location in frequency range of operation
<input type="checkbox"/> 1 MHz or less	1	Middle
<input type="checkbox"/> 1 MHz to 10 MHz	2	1 near top and 1 near bottom
<input checked="" type="checkbox"/> More than 10 MHz	3	1 near top, 1 near middle, and 1 near bottom

1.3 ANTENNA INFORMATION

Antenna Type	<input checked="" type="checkbox"/> FPC <input type="checkbox"/> PCB <input type="checkbox"/> Dipole <input type="checkbox"/> Coils
Antenna Gain	Gain: 4dBi
Antenna connector	MHF4

1.4 MEASUREMENT UNCERTAINTY

PARAMETER	UNCERTAINTY
AC Powerline Conducted Emission	+/- 1.2575
Emission bandwidth, 20dB bandwidth	+/- 0.0014
RF output power, conducted	+/- 1.14
Power density, conducted	+/- 1.40
3M Semi Anechoic Chamber / 30M~200M	+/- 4.12
3M Semi Anechoic Chamber / 200M~1000M	+/- 4.68
3M Semi Anechoic Chamber / 1G~8G	+/- 5.18
3M Semi Anechoic Chamber / 8G~18G	+/- 5.47
3M Semi Anechoic Chamber / 18G~26G	+/- 3.81
3M Semi Anechoic Chamber / 26G~40G	+/- 3.87

Remark:

1. This uncertainty represents an expanded uncertainty expressed at approximately the 95% confidence level using a coverage factor of $k=2$
2. ISO/IEC 17025 requires that an estimate of the measurement uncertainties associated with the emissions test results be included in the report.



Report No.: T191218D03-RP3

Page 7 / 84

Rev. 00

1.5 FACILITIES AND TEST LOCATION

All measurement facilities used to collect the measurement data are located at

No.11, Wugong 6th Rd., Wugu Dist., New Taipei City 24891, Taiwan. (R.O.C.)

Test site	Test Engineer	Remark
AC Conduction Room	N/A	Not applicable, because EUT not connect to AC Main Source direct.
Radiation	Jerry Chang	-
RF Conducted	Dally Hong	-

Remark: *The sites are constructed in conformance with the requirements of ANSI C63.7, ANSI C63.4 and CISPR Publication 22.*

Report No.: T191218D03-RP3

1.6 INSTRUMENT CALIBRATION

RF Conducted Test Site					
Equipment	Manufacturer	Model	S/N	Cal Date	Cal Due
Coaxial Cable	Woken	WC12	CC001	06/28/2019	06/27/2020
Coaxial Cable	Woken	WC12	CC003	06/28/2019	06/27/2020
Power Meter	Anritsu	ML2495A	1149001	02/12/2019	02/11/2020
Power Seneor	Anritsu	MA2491A	030982	02/12/2019	02/11/2020
EXA Signal Analyzer	KEYSIGHT	N9010B	MY55460167	07/31/2019	07/30/2020
Software	N/A				
3M 966 Chamber Test Site					
Equipment	Manufacturer	Model	S/N	Cal Date	Cal Due
Band Reject Filters	MICRO TRONICS	BRM 50702	120	02/26/2019	02/25/2020
Bilog Antenna	Sunol Sciences	JB3	A030105	07/26/2019	07/25/2020
Coaxial Cable	HUBER SUHNER	SUCOFLEX 104PEA	20995	02/26/2019	02/25/2020
Coaxial Cable	EMCI	EMC105	190914+25111	09/20/2019	09/19/2020
Digital Thermo-Hygro Meter	WISEWIND	1206	D07	01/30/2019	01/29/2020
double Ridged Guide Horn Antenna	ETC	MCTD 1209	DRH13M02003	10/04/2019	10/03/2020
Loop Ant	COM-POWER	AL-130	121051	03/22/2019	03/21/2020
Pre-Amplifier	EMEC	EM330	060609	02/26/2019	02/25/2020
Pre-Amplifier	HP	8449B	3008A00965	02/26/2019	02/25/2020
PSA Series Spectrum Analyzer	Agilent	E4446A	MY46180323	05/29/2019	05/28/2020
Antenna Tower	CCS	CC-A-1F	N/A	N.C.R	N.C.R
Controller	CCS	CC-C-1F	N/A	N.C.R	N.C.R
Turn Table	CCS	CC-T-1F	N/A	N.C.R	N.C.R
Software	e3 6.11-20180413				
AC Conducted Emissions Test Site					
Equipment	Manufacturer	Model	S/N	Cal Date	Cal Due
N/A					

Remark: Each piece of equipment is scheduled for calibration once a year.



Report No.: T191218D03-RP3

Page 9 / 84

Rev. 00

1.7 SUPPORT AND EUT ACCESSORIES EQUIPMENT

EUT Accessories Equipment					
No.	Equipment	Brand	Model	Series No.	FCC ID
	N/A				

Support Equipment					
No.	Equipment	Brand	Model	Series No.	FCC ID
	N/A				

1.8 TEST METHODOLOGY AND APPLIED STANDARDS

The test methodology, setups and results comply with all requirements in accordance with ANSI C63.10:2013, FCC Part 2, FCC Part 15.247, KDB 558074 D01

2. TEST SUMMERY

FCC Standard Section	Report Section	Test Item	Result
15.203	1.3	Antenna Requirement	Pass
15.207(a)	4.1	AC Conducted Emission	N/A
15.247(a)(2)	4.2	6 dB Bandwidth	Pass
2.1049	4.2	Occupied Bandwidth (99%)	Pass
15.247(b)(3)	4.3	Output Power Measurement	Pass
15.247(e)	4.4	Power Spectral Density	Pass
15.247(d)	4.5	Conducted Band Edge	Pass
15.247(d)	4.5	Conducted Spurious Emission	Pass
15.247(d)	4.6	Radiation Band Edge	Pass
15.247(d)	4.6	Radiation Spurious Emission	Pass

Report No.: T191218D03-RP3

3. DESCRIPTION OF TEST MODES

3.1 THE WORST MODE OF OPERATING CONDITION

Operation mode	IEEE 802.11b Mode :1Mbps IEEE 802.11g Mode :6Mbps IEEE 802.11n HT20 Mode :MCS0 IEEE 802.11n HT40 Mode :MCS0
Test Channel Frequencies	IEEE 802.11b Mode : 1. Lowest Channel : 2412MHz 2. Middle Channel : 2437MHz 3. Highest Channel : 2462MHz IEEE 802.11g Mode : 1. Lowest Channel : 2412MHz 2. Middle Channel : 2437MHz 3. Highest Channel : 2462MHz IEEE 802.11n HT20 Mode : 1. Lowest Channel : 2412MHz 2. Middle Channel : 2437MHz 3. Highest Channel : 2462MHz IEEE 802.11n HT40 Mode : 1. Lowest Channel : 2422MHz 2. Middle Channel : 2437MHz 3. Highest Channel : 2452MHz
Operation Transmitter	IEEE 802.11b Mode :1T1R IEEE 802.11g Mode : 1T1R IEEE 802.11n HT20 Mode : 1T1R IEEE 802.11n HT40 Mode : 1T1R

Remark:

1. EUT pre-scanned data rate of output power for each mode, the worst data rate were recorded in this report.

3.2 THE WORST MODE OF MEASUREMENT

Radiated Emission Measurement Above 1G	
Test Condition	Band edge, Emission for Unwanted and Fundamental
Power supply Mode	Mode 1: EUT power by Adapter.
Worst Mode	<input checked="" type="checkbox"/> Mode 1 <input type="checkbox"/> Mode 2 <input type="checkbox"/> Mode 3 <input type="checkbox"/> Mode 4
Worst Position	<input type="checkbox"/> Placed in fixed position. <input checked="" type="checkbox"/> Placed in fixed position at X-Plane (E2-Plane) <input type="checkbox"/> Placed in fixed position at Y-Plane (E1-Plane) <input type="checkbox"/> Placed in fixed position at Z-Plane (H-Plane)

Radiated Emission Measurement Below 1G	
Test Condition	Radiated Emission Below 1G
Power supply Mode	Mode 1: EUT power by Adapter.
Worst Mode	<input checked="" type="checkbox"/> Mode 1 <input type="checkbox"/> Mode 2 <input type="checkbox"/> Mode 3 <input type="checkbox"/> Mode 4

Remark:

1. The worst mode was record in this test report.
2. EUT pre-scanned in three axis, X, Y, Z and two polarity, for radiated measurement. The worst case(X-Plane) were recorded in this report.

Report No.: T191218D03-RP3

3.3 EUT DUTY CYCLE

Duty Cycle				
Configuration	Duty Cycle (%)	T(ms)	1/T (kHz)	VBW Setting
802.11b	12.21	12.32	99.11%	0.04
802.11g	2.028	2.161	93.85%	0.28
802.11n HT20	1.888	2.004	94.21%	0.26
802.11n HT40	0.928	1.034	89.75%	0.47

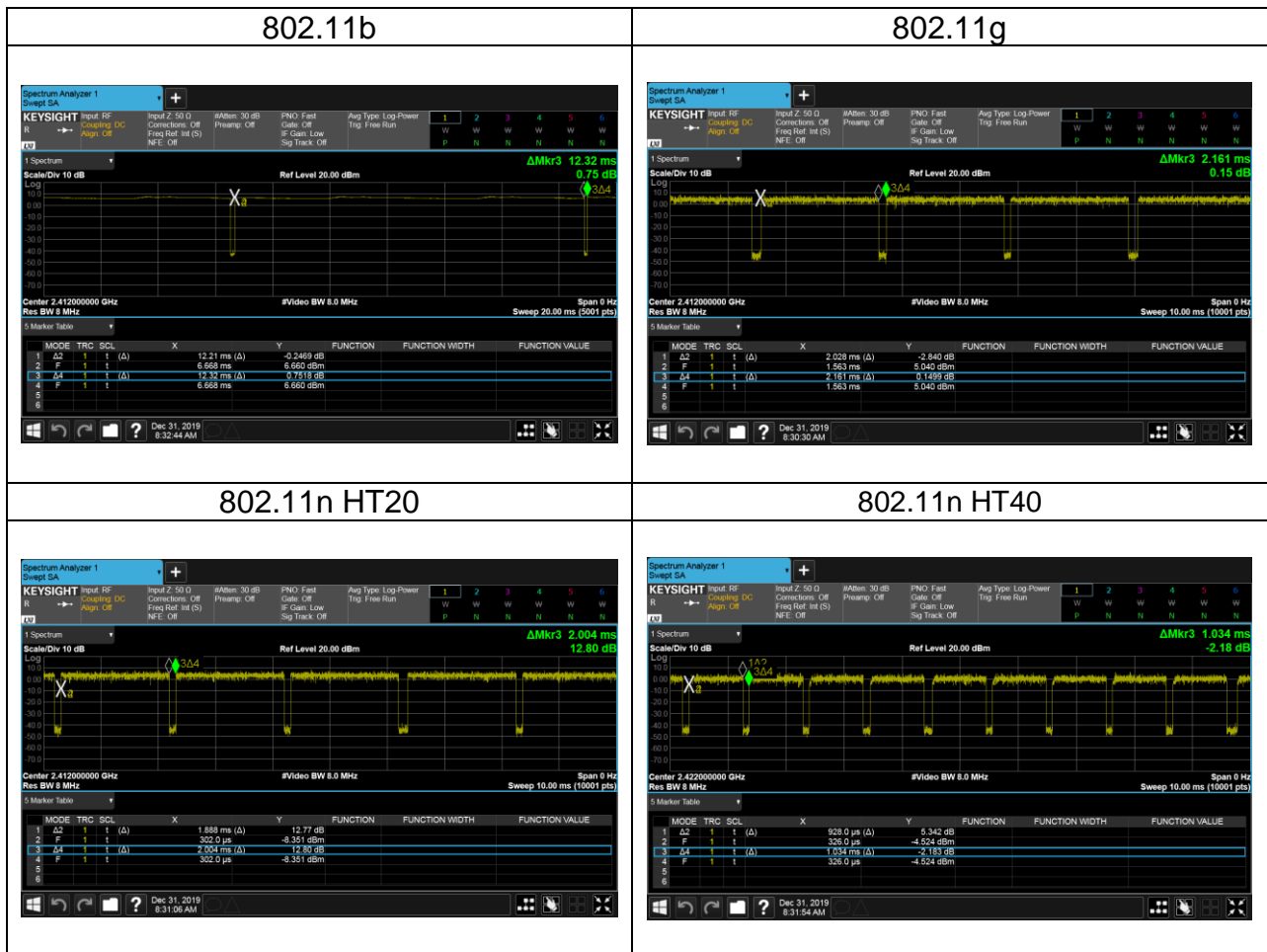

Report No.: T191218D03-RP3

4. TEST RESULT

4.1 AC POWER LINE CONDUCTED EMISSION

4.1.1 Test Limit

According to §15.207(a)(2)

Frequency Range (MHz)	Limits(dBµV)	
	Quasi-peak	Average
0.15 to 0.50	66 to 56*	56 to 46*
0.50 to 5	56	46
5 to 30	60	50

* Decreases with the logarithm of the frequency.

4.1.2 Test Procedure

Test method Refer as ANSI C63.10: 2013 clause 6.2,

1. The EUT was placed on a non-conducted table, which is 0.8m above horizontal ground plane and 0.4m above vertical ground plane.
2. EUT connected to the line impedance stabilization network (LISN)
3. Receiver set RBW of 9kHz and Detector Peak, and note as quasi-peak and average.
4. Maximum procedure was performed on the six highest emissions to ensure EUT compliance.
5. Recorded Line for Neutral and Line.

4.1.3 Test Setup

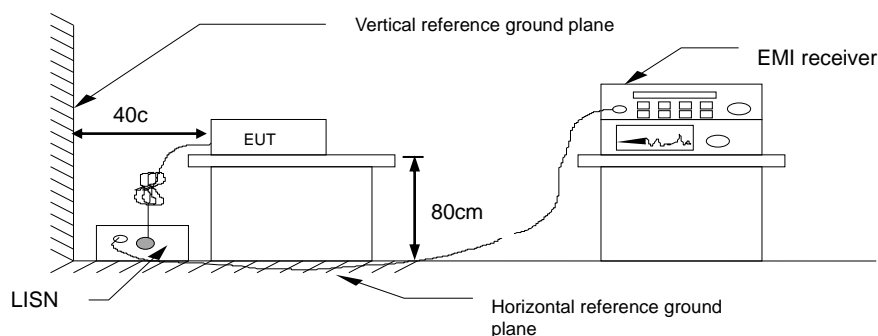

4.1.4 Test Result

Not applicable, because EUT not connect to AC Main Source direct.

Report No.: T191218D03-RP3

4.2 6dB BANDWIDTH AND OCCUPIED BANDWIDTH(99%)

4.2.1 Test Limit

According to §15.247(a)(2)

6 dB Bandwidth :

Limit	Shall be at least 500kHz
-------	--------------------------

Occupied Bandwidth(99%) : For reporting purposes only.

4.2.2 Test Procedure

Test method Refer as KDB 558074 D01 and ANSI C63.10: 2013 clause 6.9.2,

1. The EUT RF output connected to the spectrum analyzer by RF cable.
2. Setting maximum power transmit of EUT
3. SA set RBW =100KHz , VBW = 300KHz and Detector = Peak, to measurement 6dB Bandwidth
4. SA set RBW = 1% ~ 5% OBW, VBW = three times the RBW and Detector = Peak, to measurement 99% Bandwidth
5. Measure and record the result of 6 dB Bandwidth and 99% Bandwidth. in the test report.

4.2.3 Test Setup

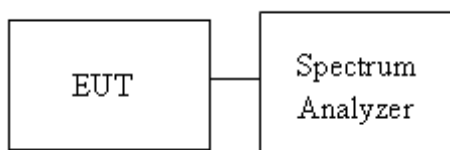

Report No.: T191218D03-RP3

4.2.4 Test Result

Test mode: IEEE 802.11b mode / 2412-2462 MHz				
Channel	Frequency (MHz)	OBW(99%) (MHz)	6dB BW (MHz)	6dB limit (kHz)
Low	2412	16.617	10.07	≥500
Mid	2437	16.374	10.07	
High	2462	16.140	10.06	

Test mode: IEEE 802.11g mode / 2412-2462 MHz				
Channel	Frequency (MHz)	OBW(99%) (MHz)	6dB BW (MHz)	6dB limit (kHz)
Low	2412	16.819	15.16	≥500
Mid	2437	16.753	15.16	
High	2462	16.689	15.17	

Test mode: IEEE 802.11n HT 20 mode / 2412-2462 MHz				
Channel	Frequency (MHz)	OBW(99%) (MHz)	6dB BW (MHz)	6dB limit (kHz)
Low	2412	17.690	15.17	≥500
Mid	2437	17.643	15.16	
High	2462	17.652	15.17	

Test mode: IEEE 802.11n HT 40 mode / 2422-2452 MHz				
Channel	Frequency (MHz)	OBW(99%) (MHz)	6dB BW (MHz)	6dB limit (kHz)
Low	2422	37.998	35.06	≥500
Mid	2437	37.800	35.07	
High	2452	36.985	35.08	

Report No.: T191218D03-RP3

Test Data (6dB BANDWIDTH)

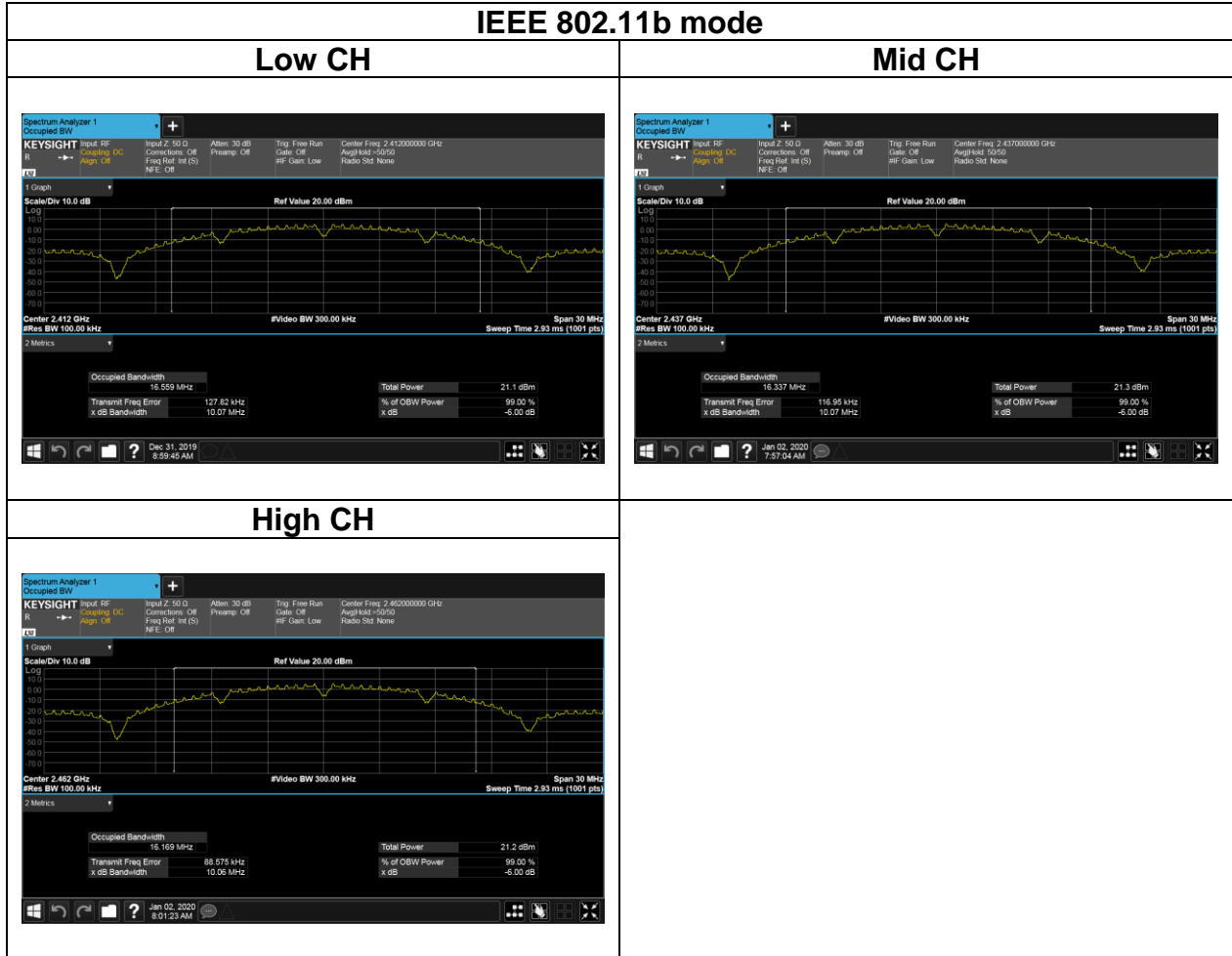

Report No.: T191218D03-RP3

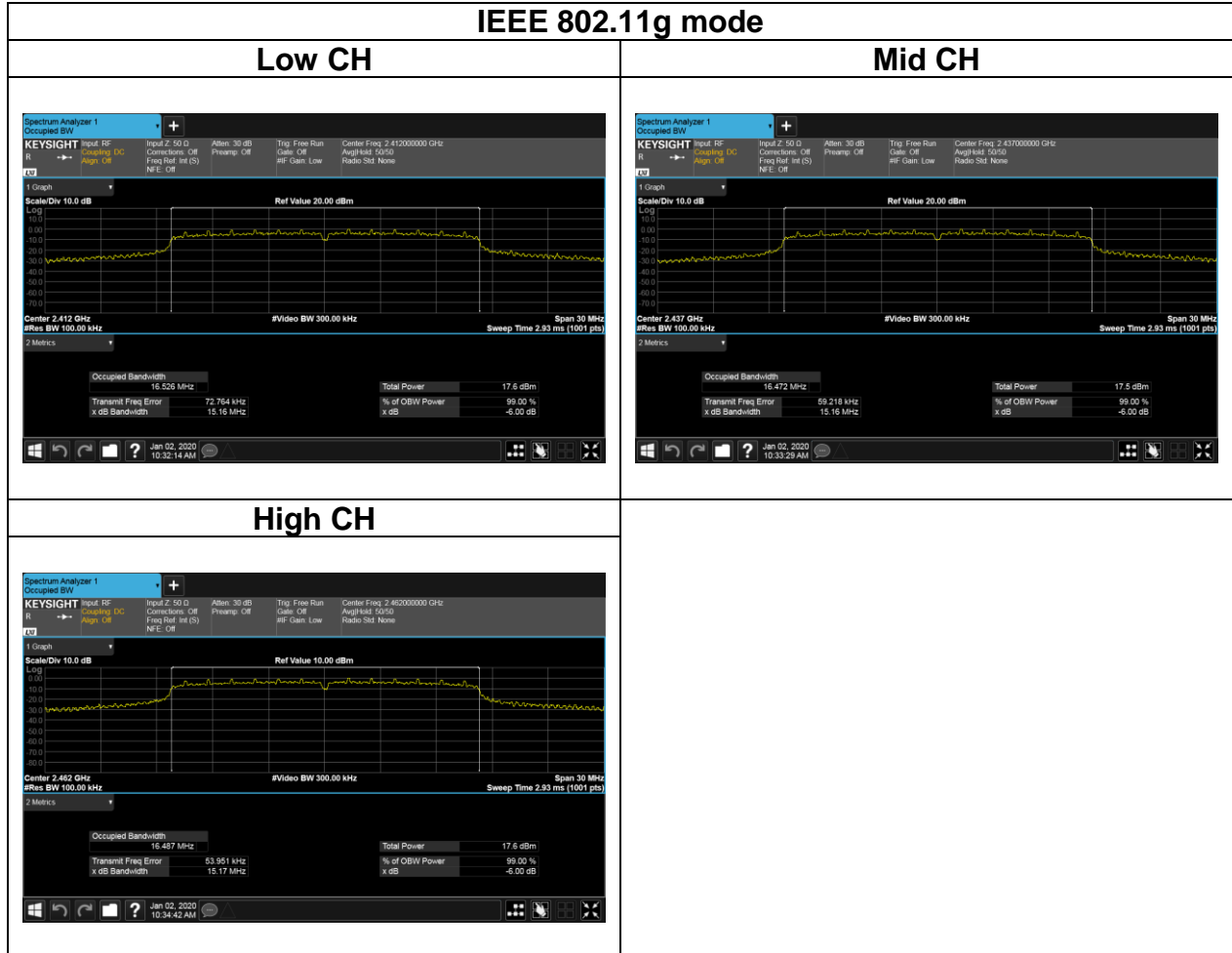

Report No.: T191218D03-RP3

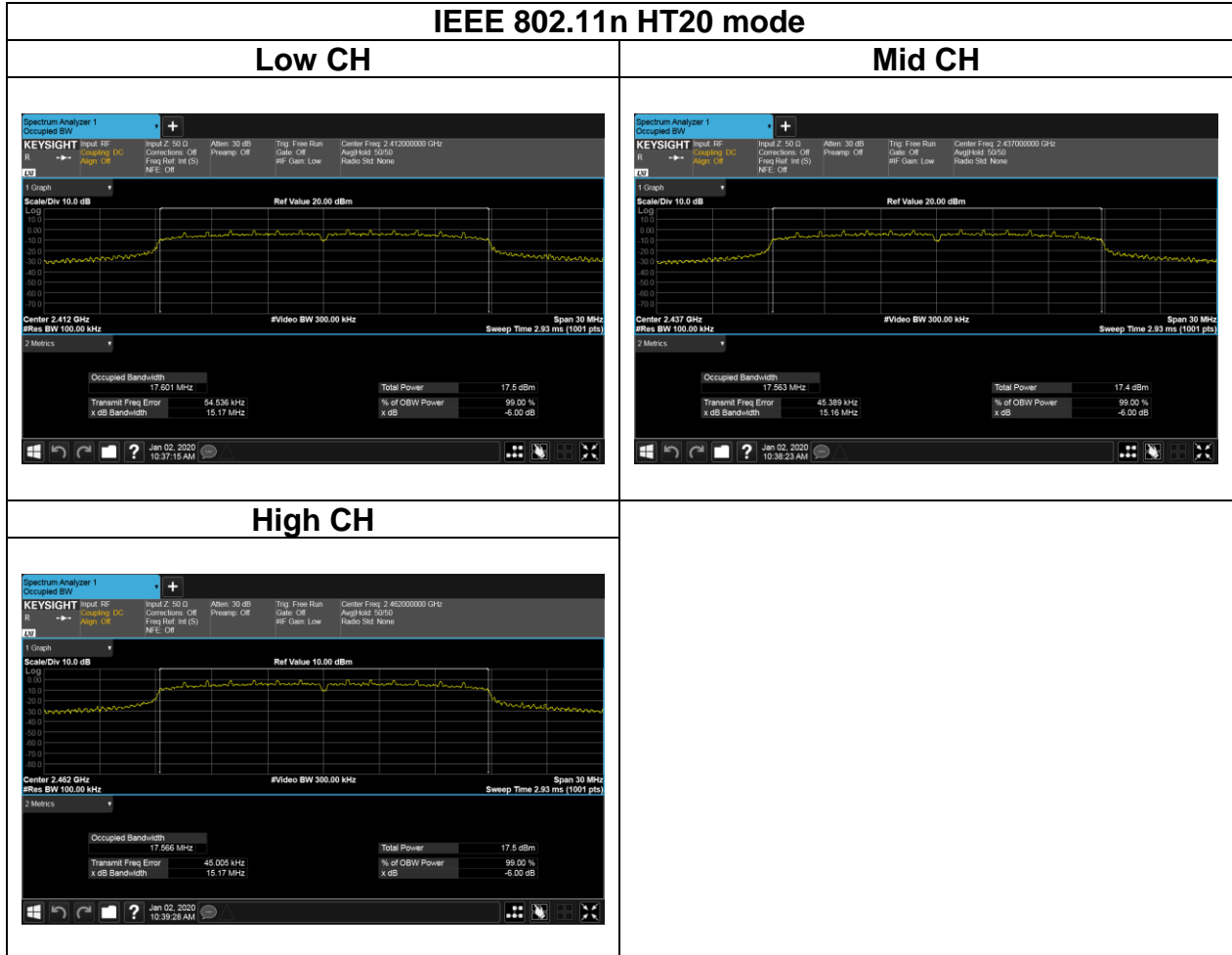

Report No.: T191218D03-RP3

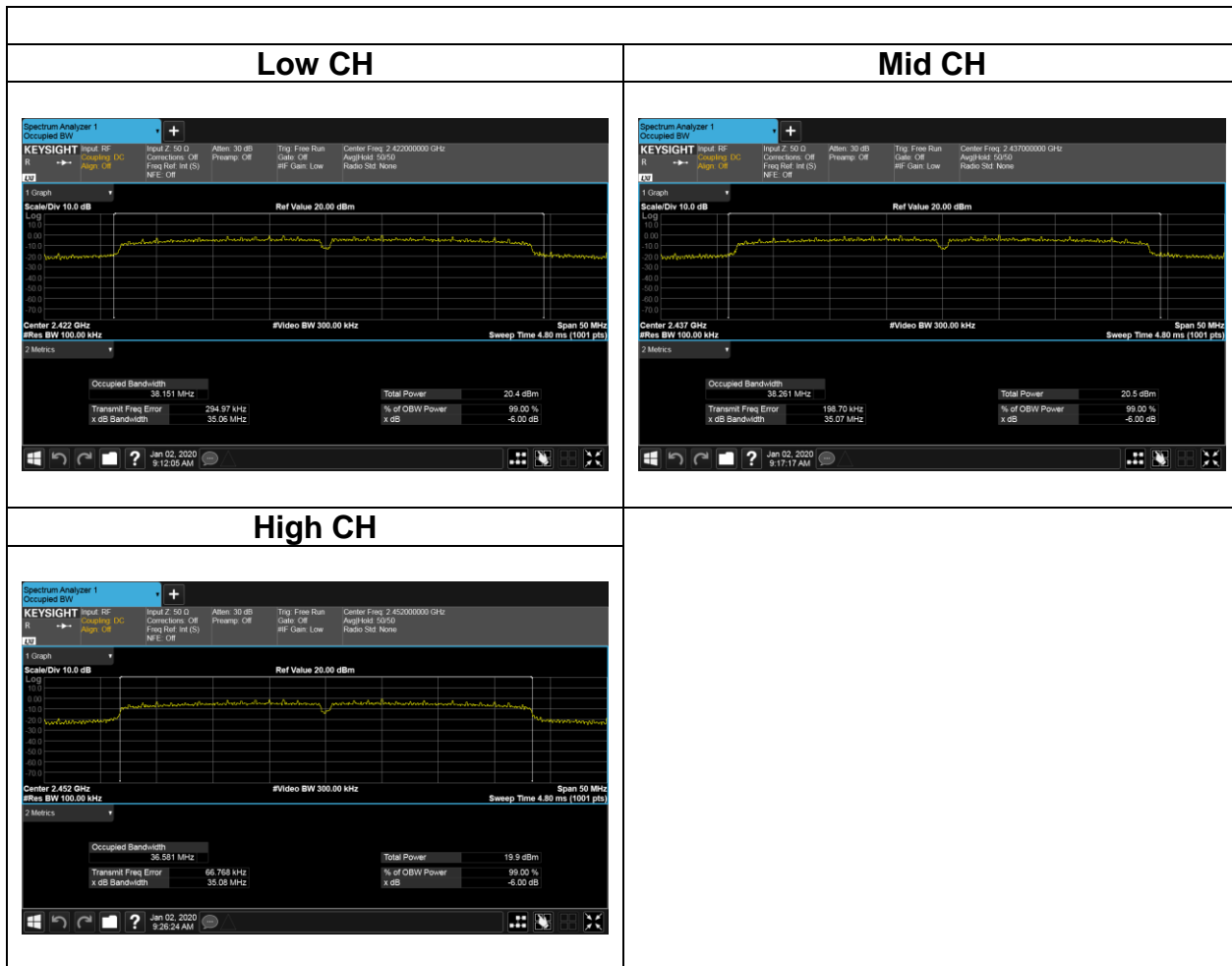

Report No.: T191218D03-RP3

Test Data (BANDWIDTH 99%)

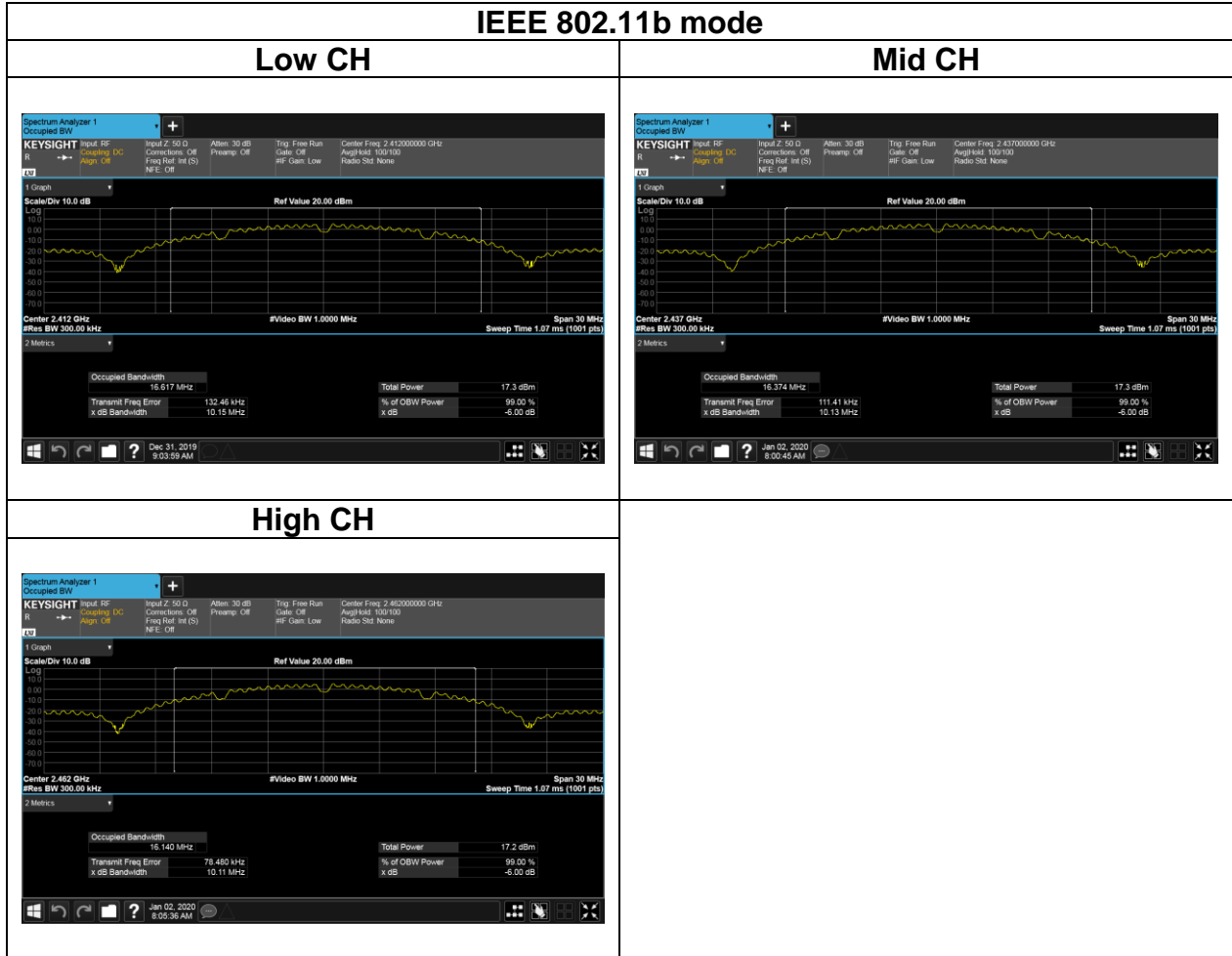

Report No.: T191218D03-RP3

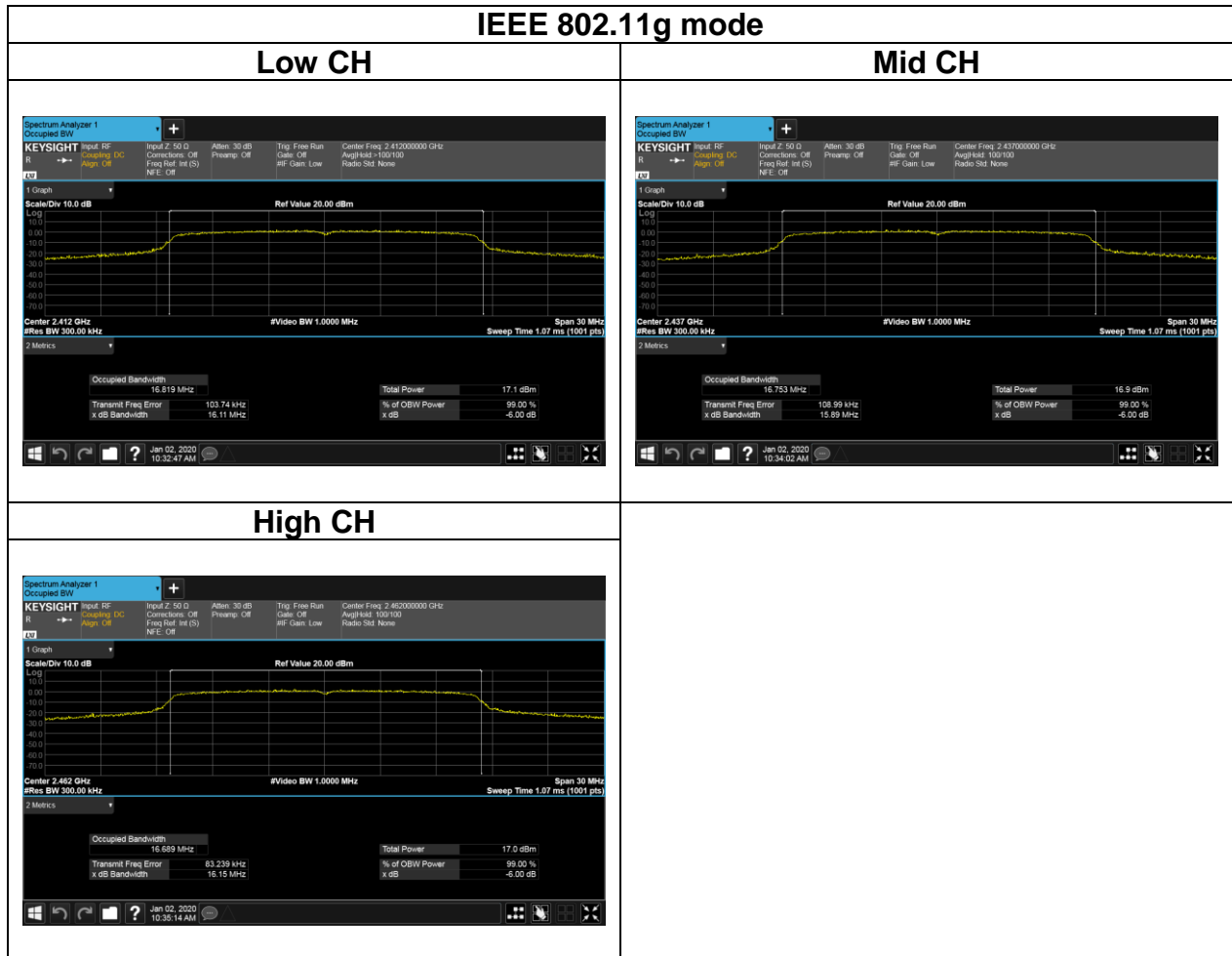

Report No.: T191218D03-RP3

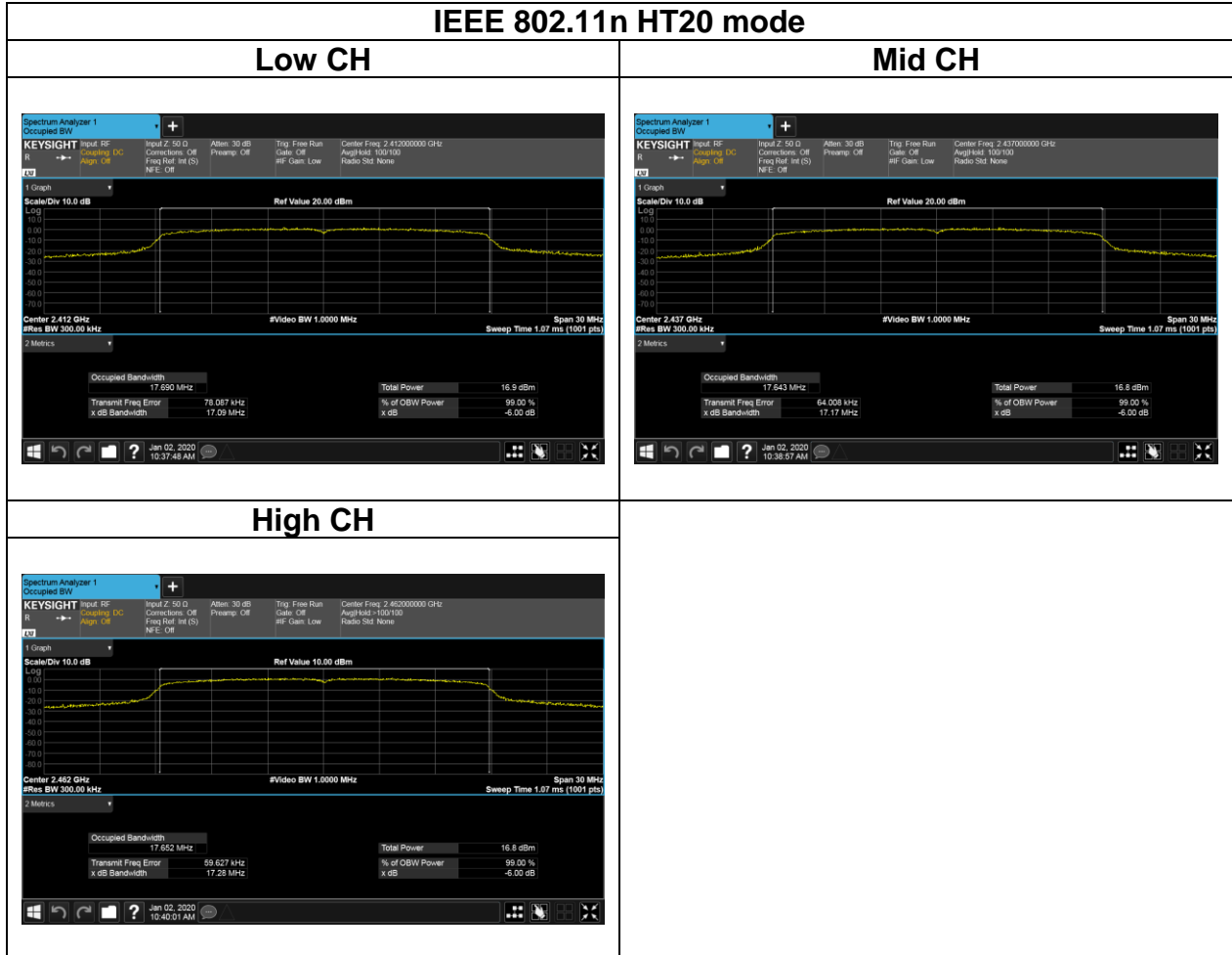

Report No.: T191218D03-RP3

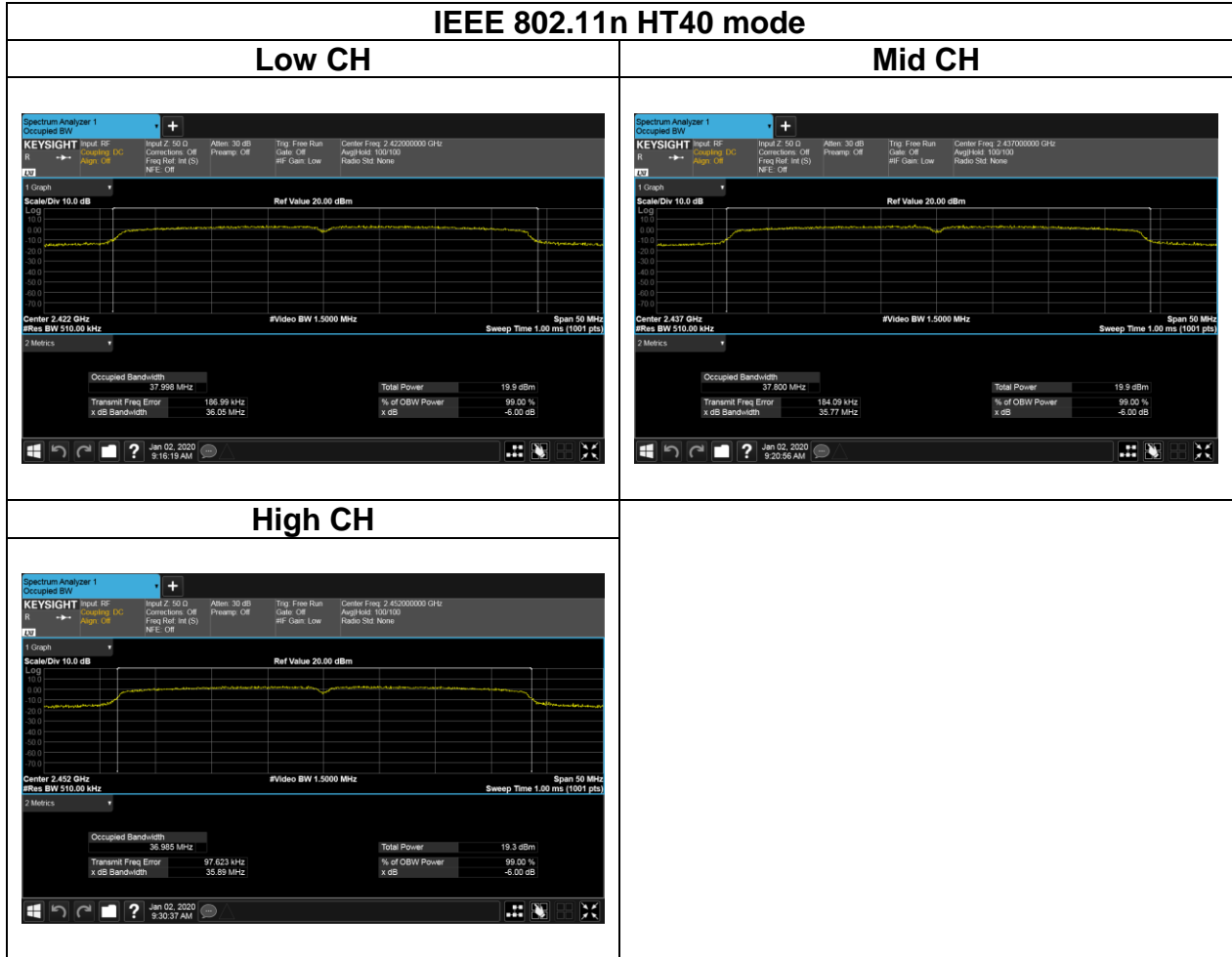

Report No.: T191218D03-RP3

4.3 OUTPUT POWER MEASUREMENT

4.3.1 Test Limit

According to §15.247(b)

Peak output power :

For systems using digital modulation in the 2400-2483.5 MHz, and 5725-5850 MHz bands: 1 Watt(30 dBm), base on the use of antennas with directional gain not exceed 6 dBi If transmitting antennas of directional gain greater than 6dBi are used the peak output power the conducted output power from the intentional radiator shall be reduced by the amount in dB that the directional gain of the antenna exceeds 6 dBi. In case of point-to-point operation, the limit has to be reduced by 1dB for every 3 dB that the directional gain of the antenna exceeds 6 dBi.

Limit	<input checked="" type="checkbox"/> Antenna not exceed 6 dBi : 30dBm <input type="checkbox"/> Antenna with DG greater than 6 dBi : [Limit = 30 – (DG – 6)] <input type="checkbox"/> Point-to-point operation :
-------	---

Average output power : For reporting purposes only.

4.3.2 Test Procedure

Test method Refer as KDB 558074 D01, Section 9.1.2.

1. The EUT RF output connected to the power meter by RF cable.
2. Setting maximum power transmit of EUT.
3. The path loss was compensated to the results for each measurement.
4. Measure and record the result of Peak output power and Average output power. in the test report.

4.3.3 Test Setup

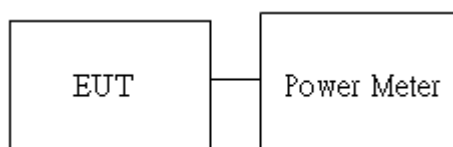

Report No.: T191218D03-RP3

4.3.4 Test Result

Peak output power :

Wifi 2.4G						
Config	CH	Freq. (MHz)	power set	PK Power (dBm)	PK Power (W)	Limit (dBm)
IEEE 802.11b Data rate: 1Mbps	Low	2412	17	18.35	0.0684	30
	Mid	2437	17	19.06	0.0805	
	High	2462	17	18.14	0.0652	
IEEE 802.11g Data rate: 6Mbps	Low	2412	20	23.13	0.2056	
	Mid	2437	21	23.27	0.2123	
	High	2462	17	21.08	0.1282	
IEEE 802.11n HT20 Data rate: MCS0	Low	2412	21	23.22	0.2099	
	Mid	2437	22	23.60	0.2291	
	High	2462	18	20.10	0.1023	
IEEE 802.11n HT40 Data rate: MCS0	Low	2422	19	21.86	0.1535	
	Mid	2437	21	23.30	0.2138	
	High	2452	15	19.44	0.0879	

Average output power :

Wifi 2.4G			
Config	CH	Freq. (MHz)	AV Power (dBm)
IEEE 802.11b Data rate: 1Mbps	Low	2412	15.82
	Mid	2437	16.57
	High	2462	15.63
IEEE 802.11g Data rate: 6Mbps	Low	2412	17.00
	Mid	2437	17.03
	High	2462	14.82
IEEE 802.11n HT20 Data rate: MCS0	Low	2412	16.98
	Mid	2437	17.67
	High	2462	13.89
IEEE 802.11n HT40 Data rate: MCS0	Low	2422	14.45
	Mid	2437	16.25
	High	2452	12.55

Report No.: T191218D03-RP3

4.4 POWER SPECTRAL DENSITY

4.4.1 Test Limit

According to §15.247(e)

For digitally modulated systems, the power spectral density conducted from the intentional radiator to the antenna shall not be greater than 8 dBm in any 3 kHz band during any time interval of continuous transmission.

Limit	<input checked="" type="checkbox"/> Antenna not exceed 6 dBi : 8dBm <input type="checkbox"/> Antenna with DG greater than 6 dBi : [Limit = 8 – (DG – 6)] <input type="checkbox"/> Point-to-point operation :
-------	---

4.4.2 Test Procedure

Test method Refer as KDB 558074 D01

1. The EUT RF output connected to the spectrum analyzer by RF cable.
2. Setting maximum power transmit of EUT
3. SA set RBW = 3kHz, VBW = 30kHz, Span = 1.5 times DTS Bandwidth (6 dB BW), Detector = Peak, Sweep Time = Auto and Trace = Max hold.
4. The path loss was compensated to the results for each measurement by SA.
5. Mark the maximum level.
6. Measure and record the result of power spectral density. in the test report.

4.4.3 Test Setup

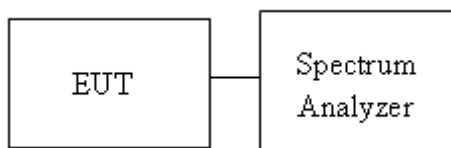

Report No.: T191218D03-RP3

4.4.4 Test Result

Test mode: IEEE 802.11b mode / 2412-2462 MHz			
Channel	Frequency (MHz)	PPSD (dBm)	Limit (dBm)
Low	2412	0.78	8
Mid	2437	0.85	
High	2462	1.67	

Test mode: IEEE 802.11g mode / 2412-2462 MHz			
Channel	Frequency (MHz)	PPSD (dBm)	Limit (dBm)
Low	2412	-2.57	8
Mid	2437	-4.95	
High	2462	-1.95	

Test mode: IEEE 802.11n HT 20 mode / 2412-2462 MHz			
Channel	Frequency (MHz)	PPSD (dBm)	Limit (dBm)
Low	2412	-2.42	8
Mid	2437	-2.89	
High	2462	-2.17	

Test mode: IEEE 802.11n HT 40 mode / 2422-2452 MHz			
Channel	Frequency (MHz)	PPSD (dBm)	Limit (dBm)
Low	2422	-5.62	8
Mid	2437	-5.77	
High	2452	-6.08	

Report No.: T191218D03-RP3

Test Data

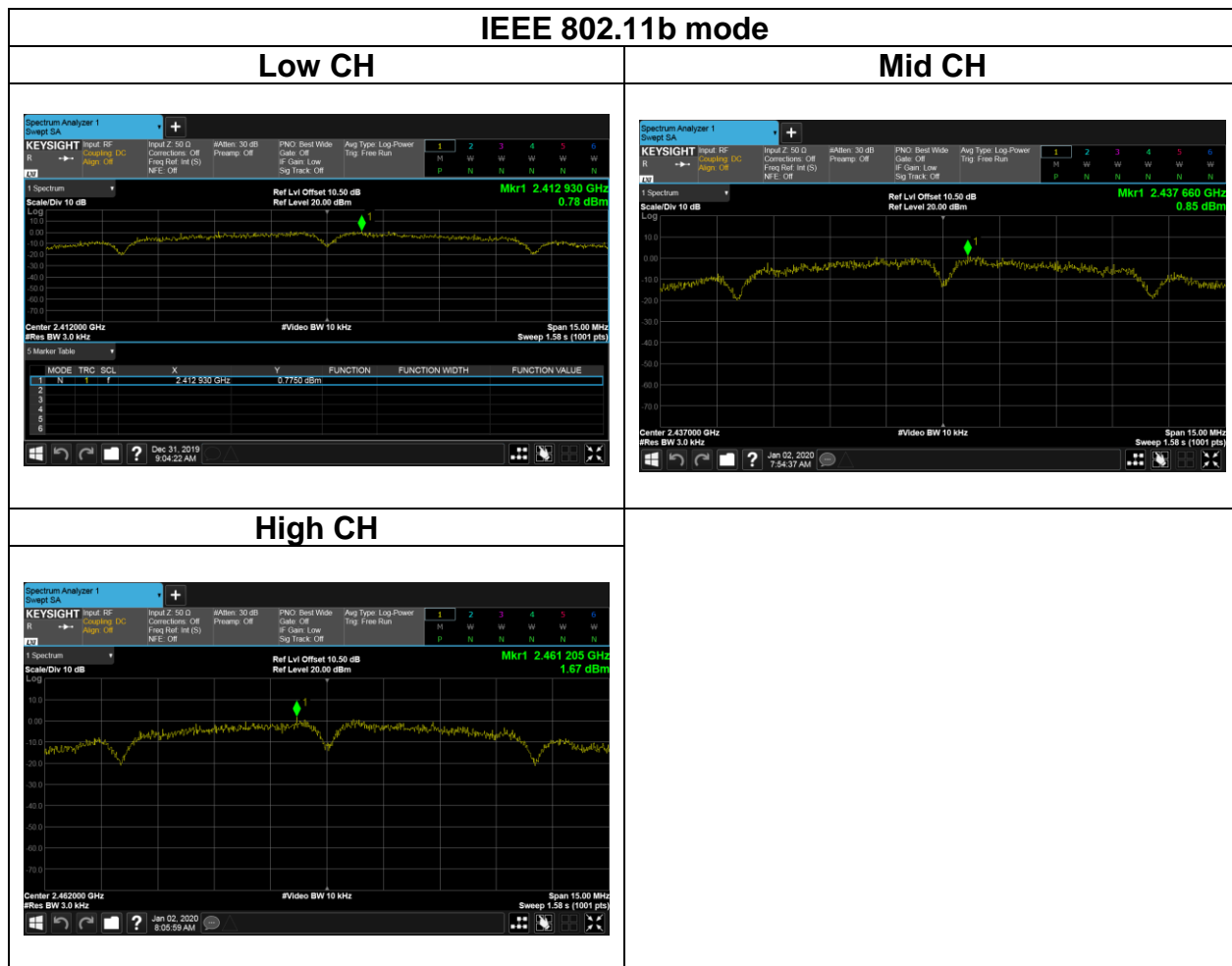

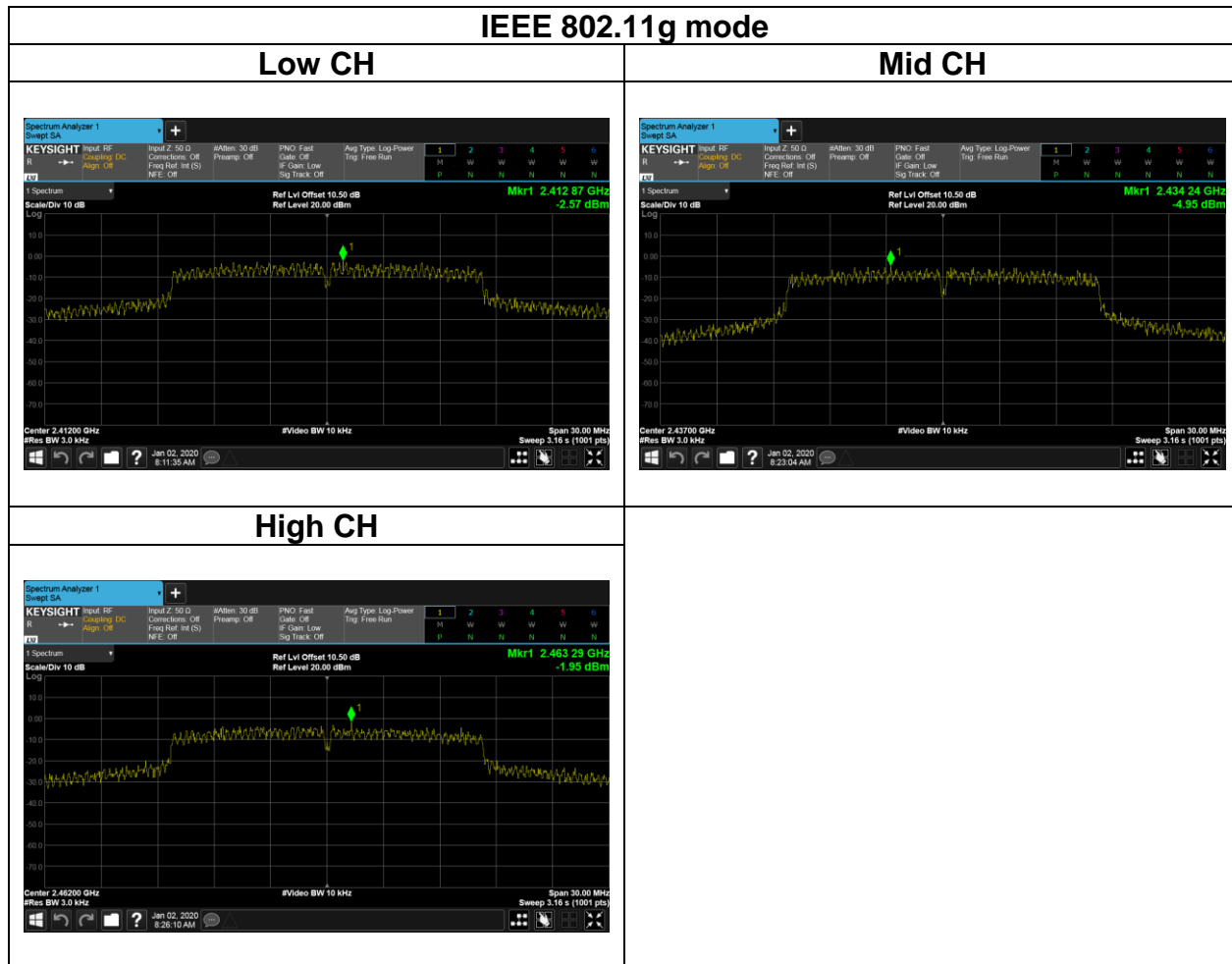

Report No.: T191218D03-RP3

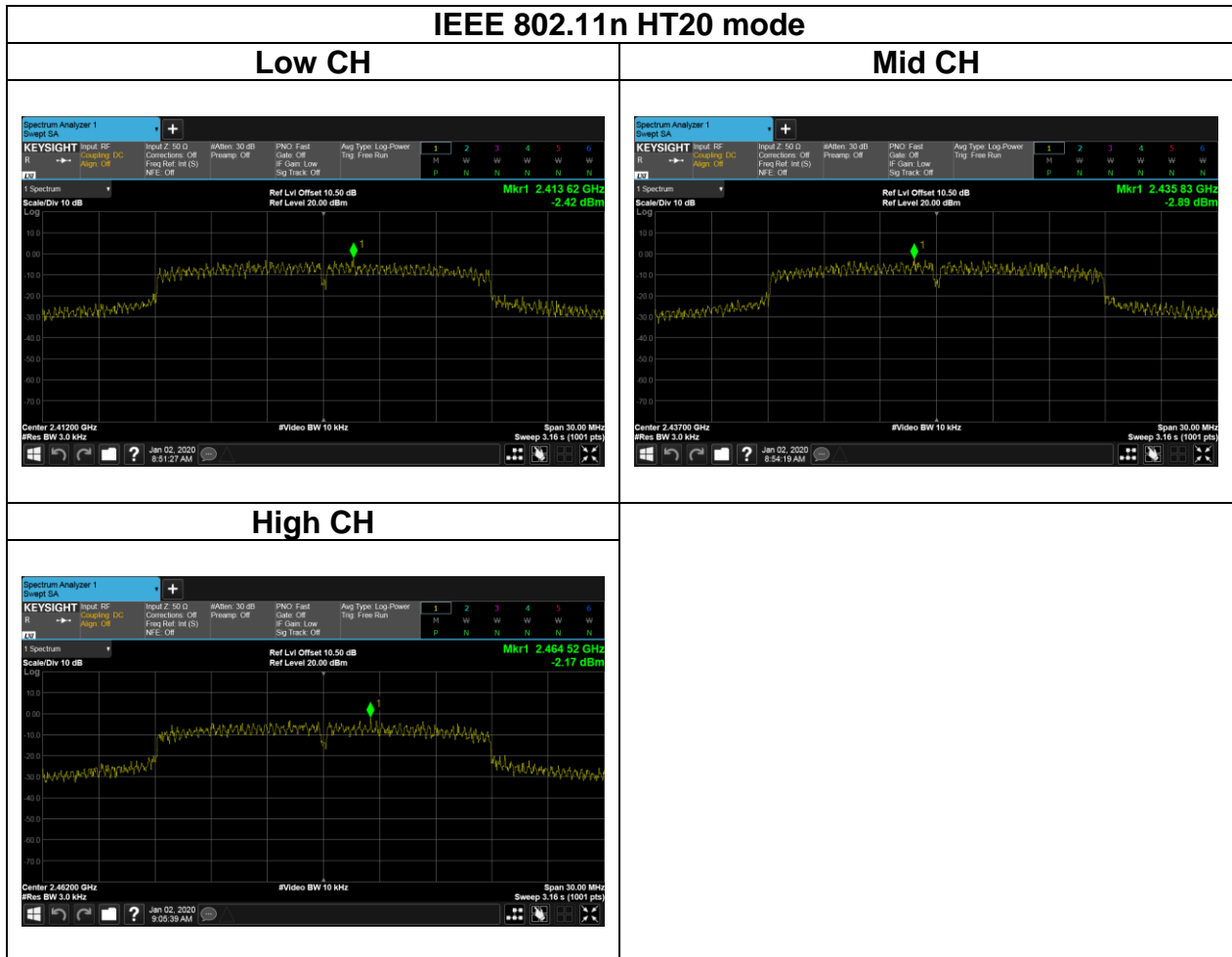

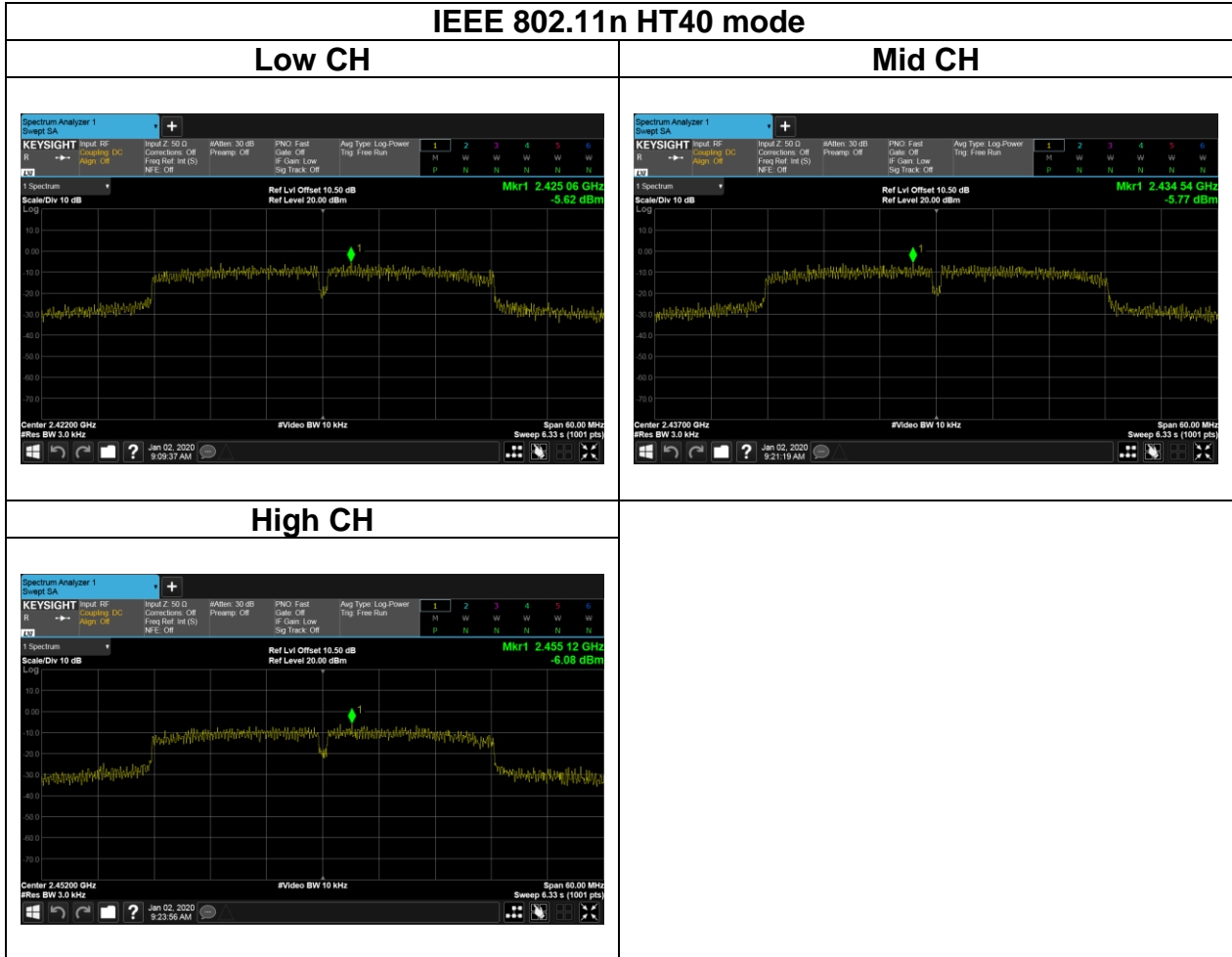

4.5 CONDUCTED BANDEDGE AND SPURIOUS EMISSION

4.5.1 Test Limit

According to §15.247(d)

In any 100 kHz bandwidth outside the authorized frequency band,

Non-restricted bands shall be attenuated at least 20 dB/30 dB relative to the maximum PSD level in 100 kHz by RF conducted or a radiated measurement which fall in the restricted bands, as defined in §15.205(a), must also comply with the radiated emission limits specified in §15.209(a).

4.5.2 Test Procedure

Test method Refer as KDB 558074 D01

1. EUT RF output port connected to the SA by RF cable, and the path loss was compensated to result.
2. SA setting, RBW=100kHz, VBW=300kHz, Detector=Peak, Trace mode = max hold, SWT = Auto.
3. In any 100 kHz bandwidth outside the authorized frequency band, shall be attenuated at least 20 dB relative to the maximum in-band peak PSD level in 100 kHz when conducted power procedure is used. If the transmitter complies with the conducted power limits based on the use of RMS averaging over a time interval, the attenuation required under this paragraph shall be 30 dB instead of 20 dB.

4.5.3 Test Setup

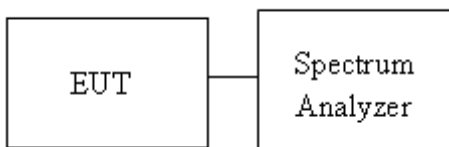

Report No.: T191218D03-RP3

4.5.4 Test Result

Test Data

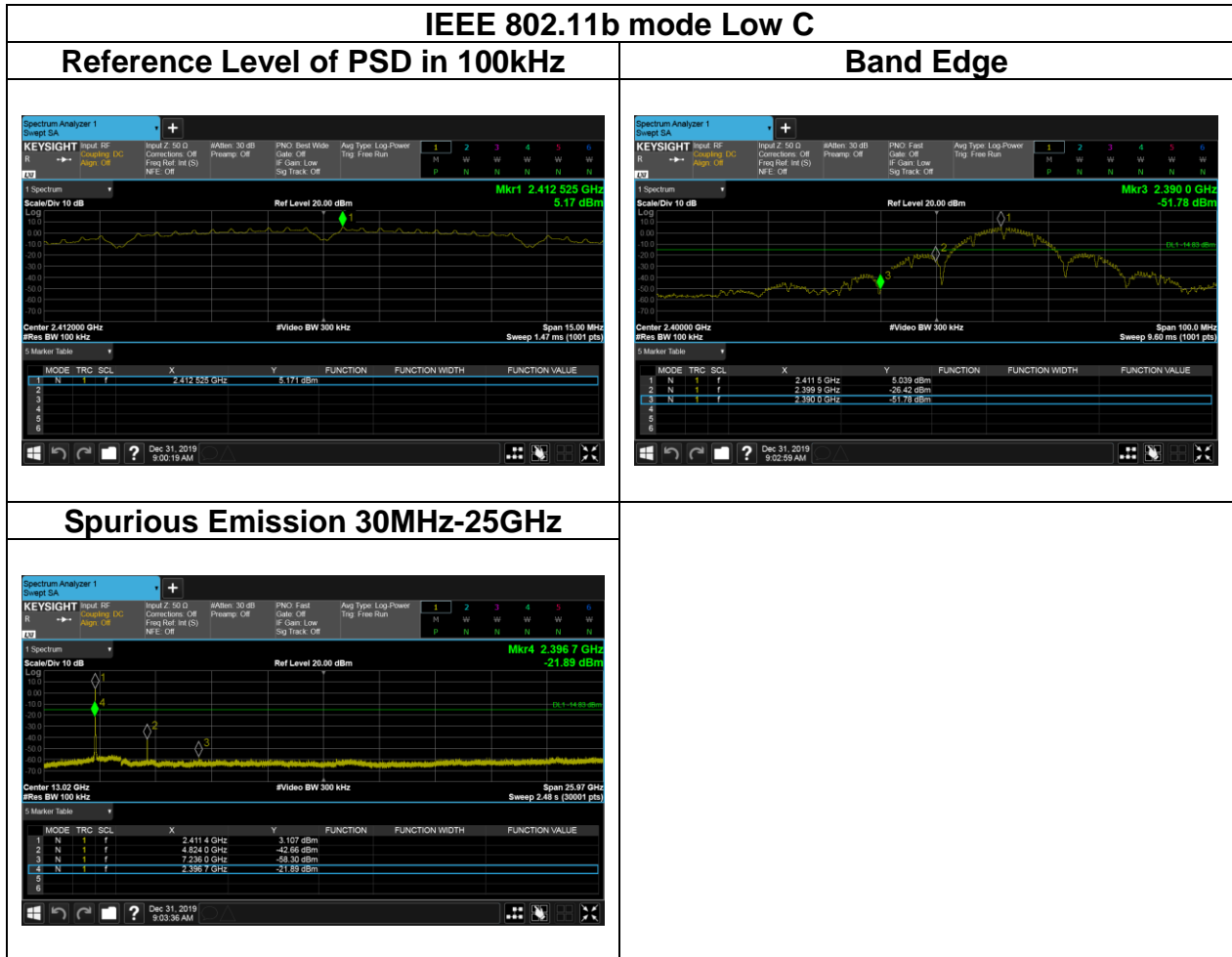

Report No.: T191218D03-RP3

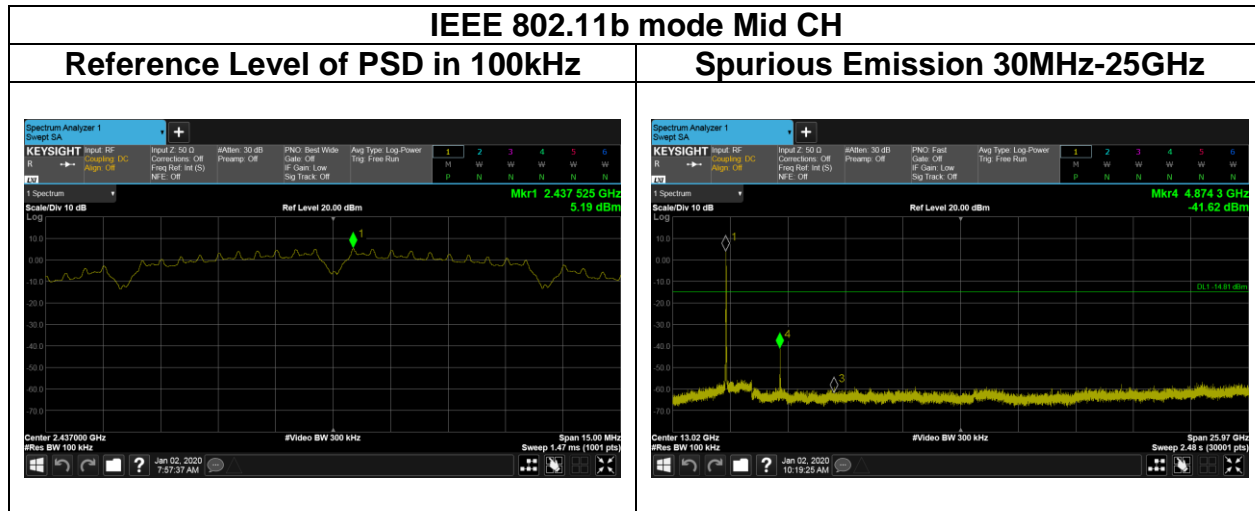

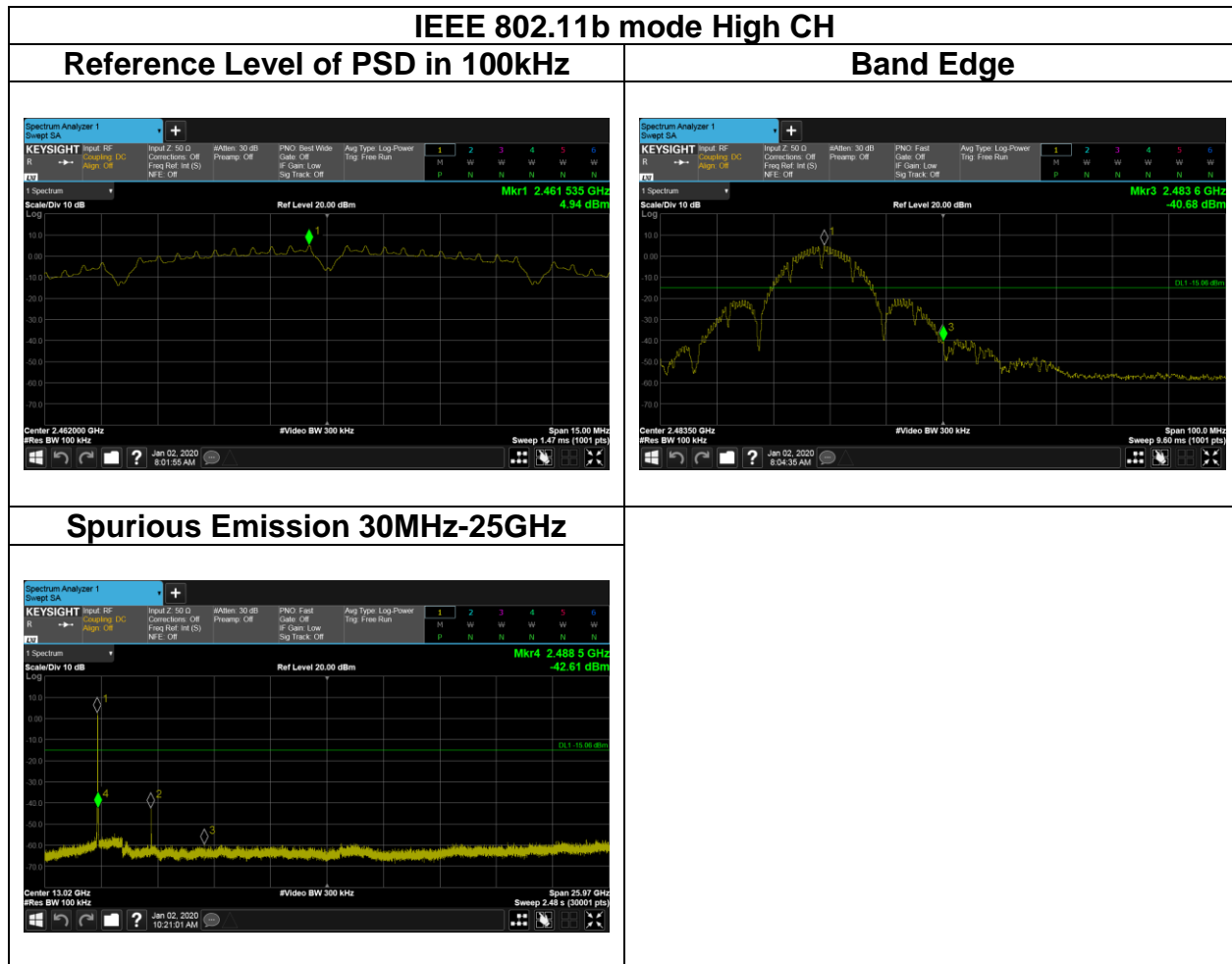

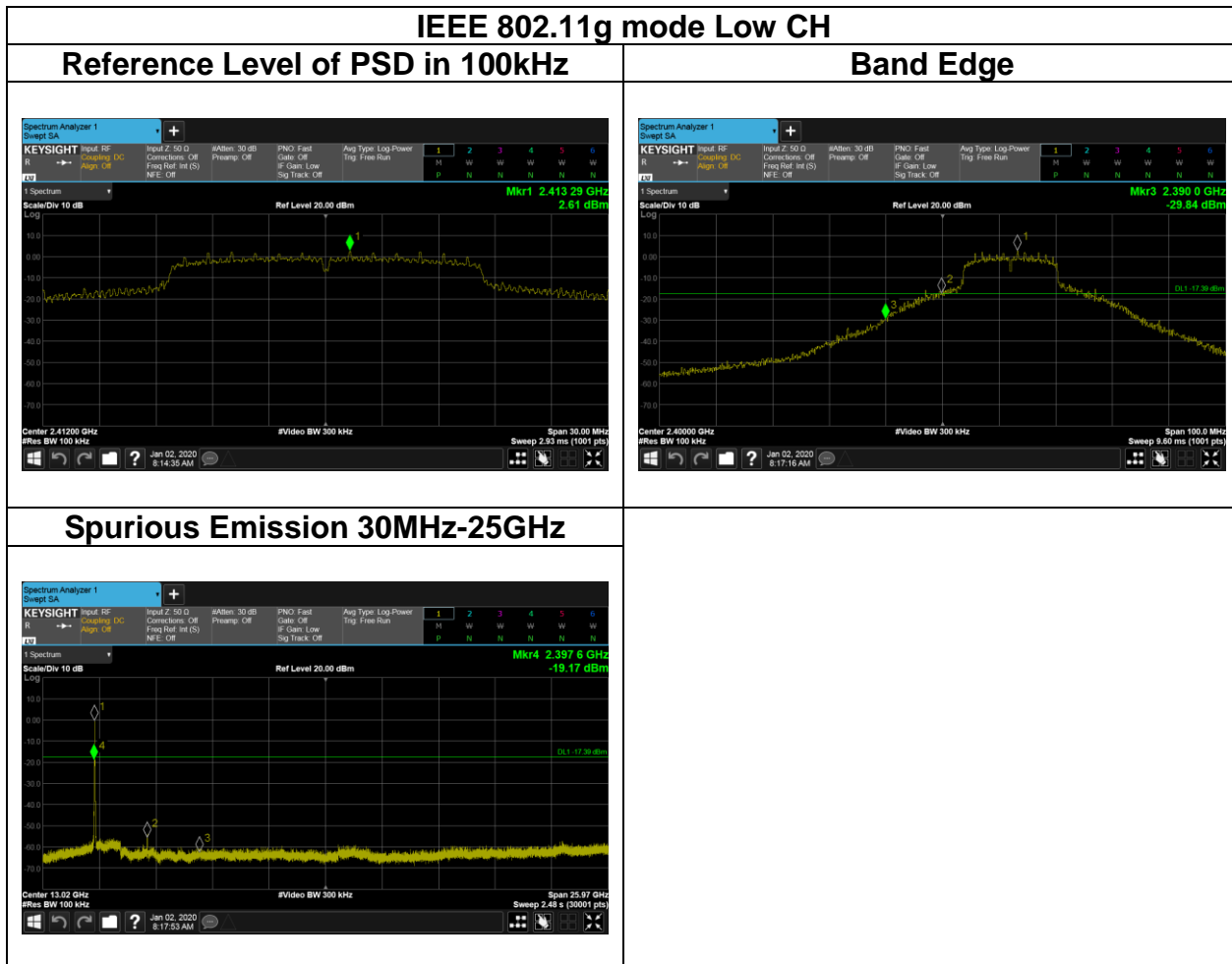

Report No.: T191218D03-RP3

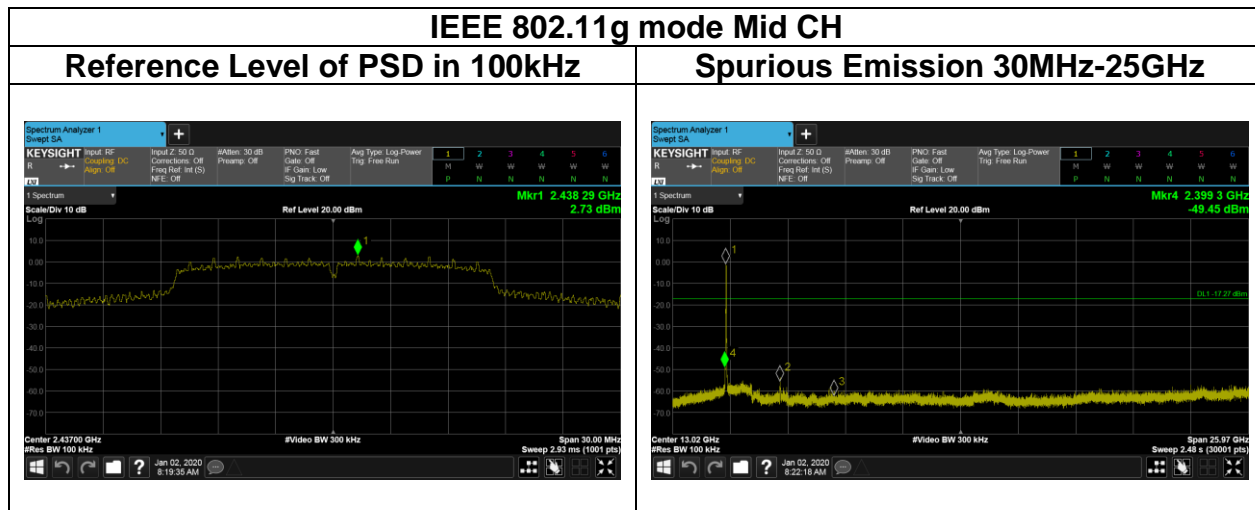

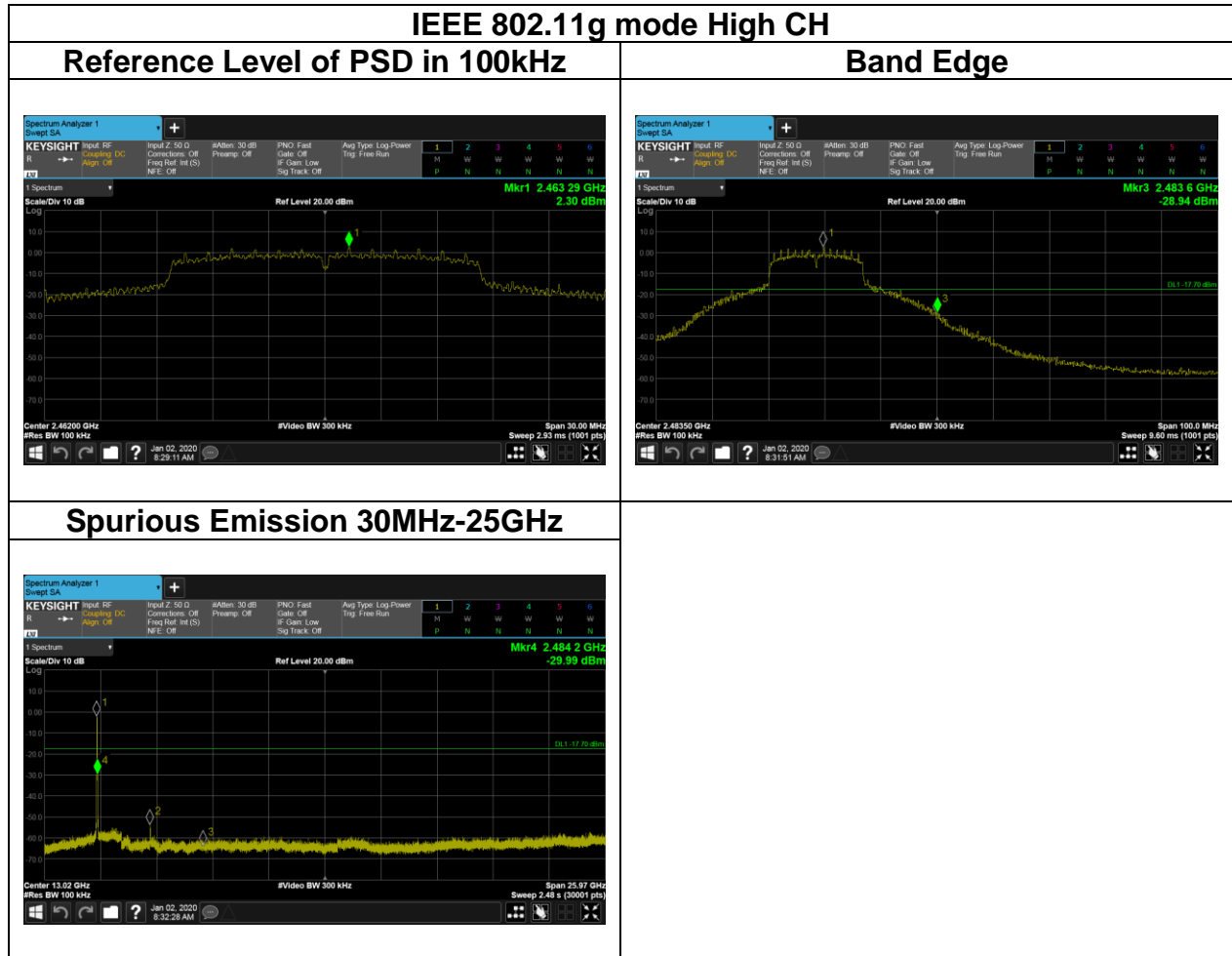

Report No.: T191218D03-RP3

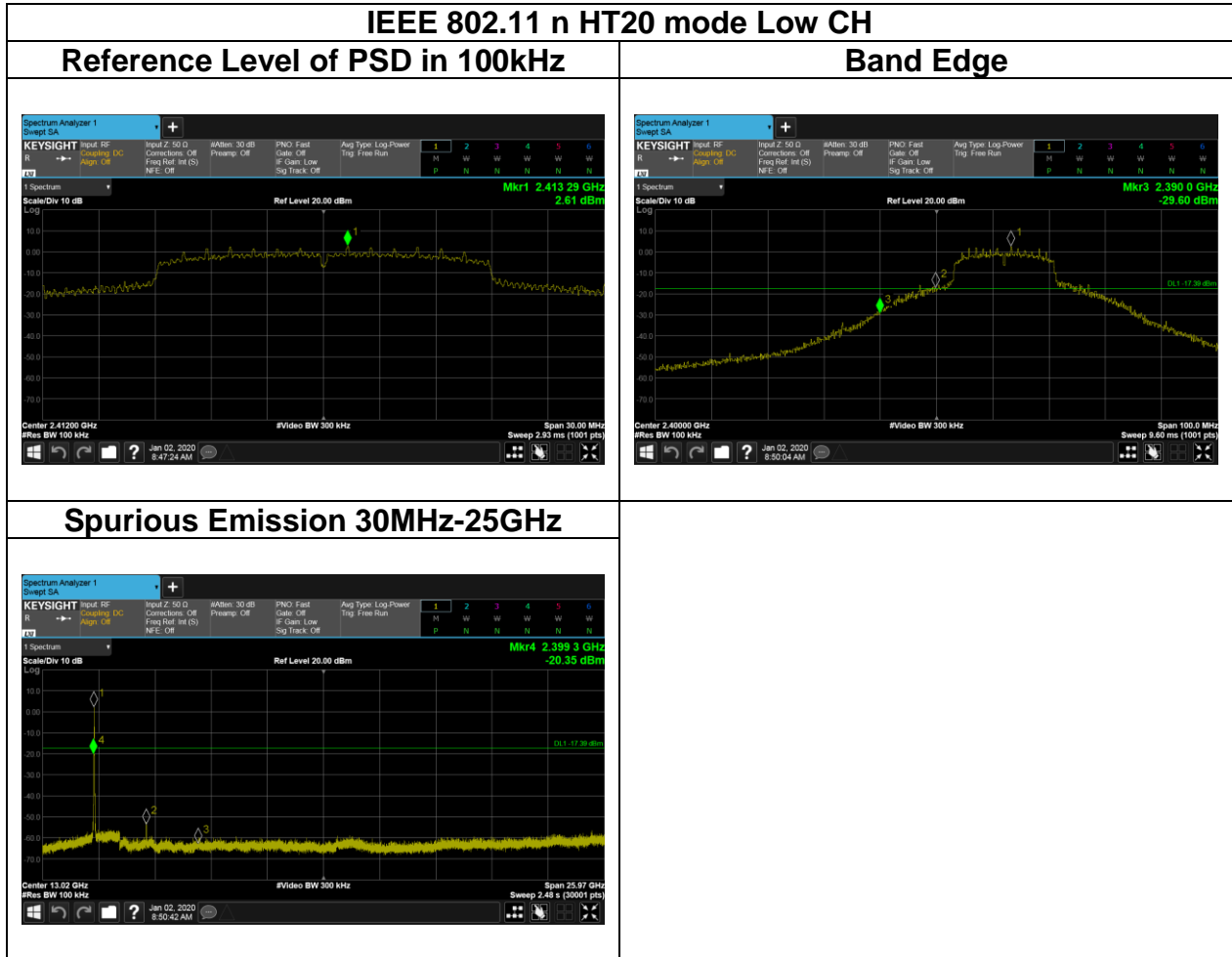

Report No.: T191218D03-RP3

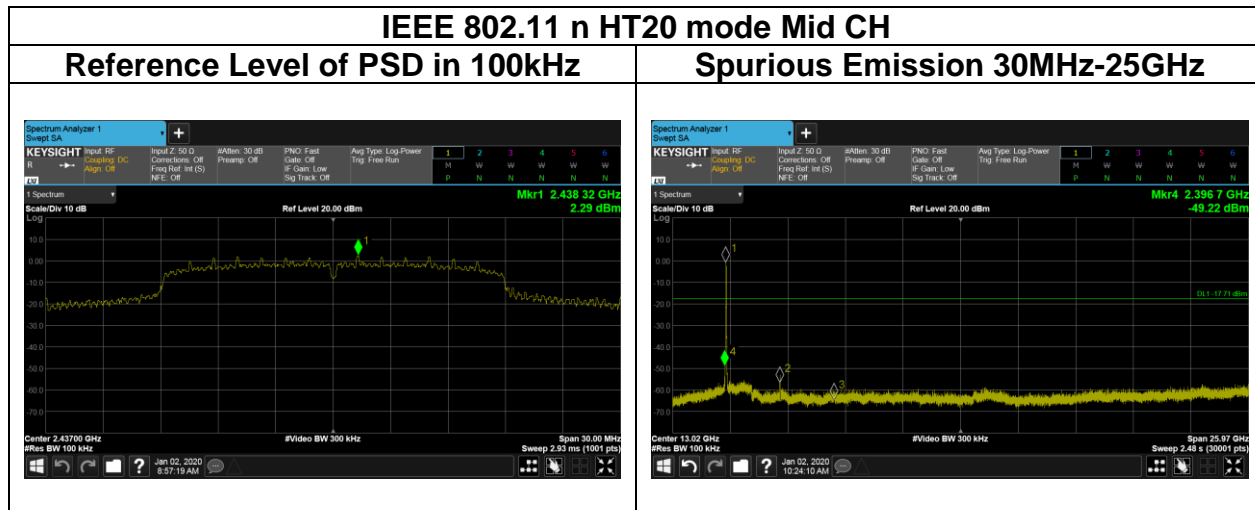

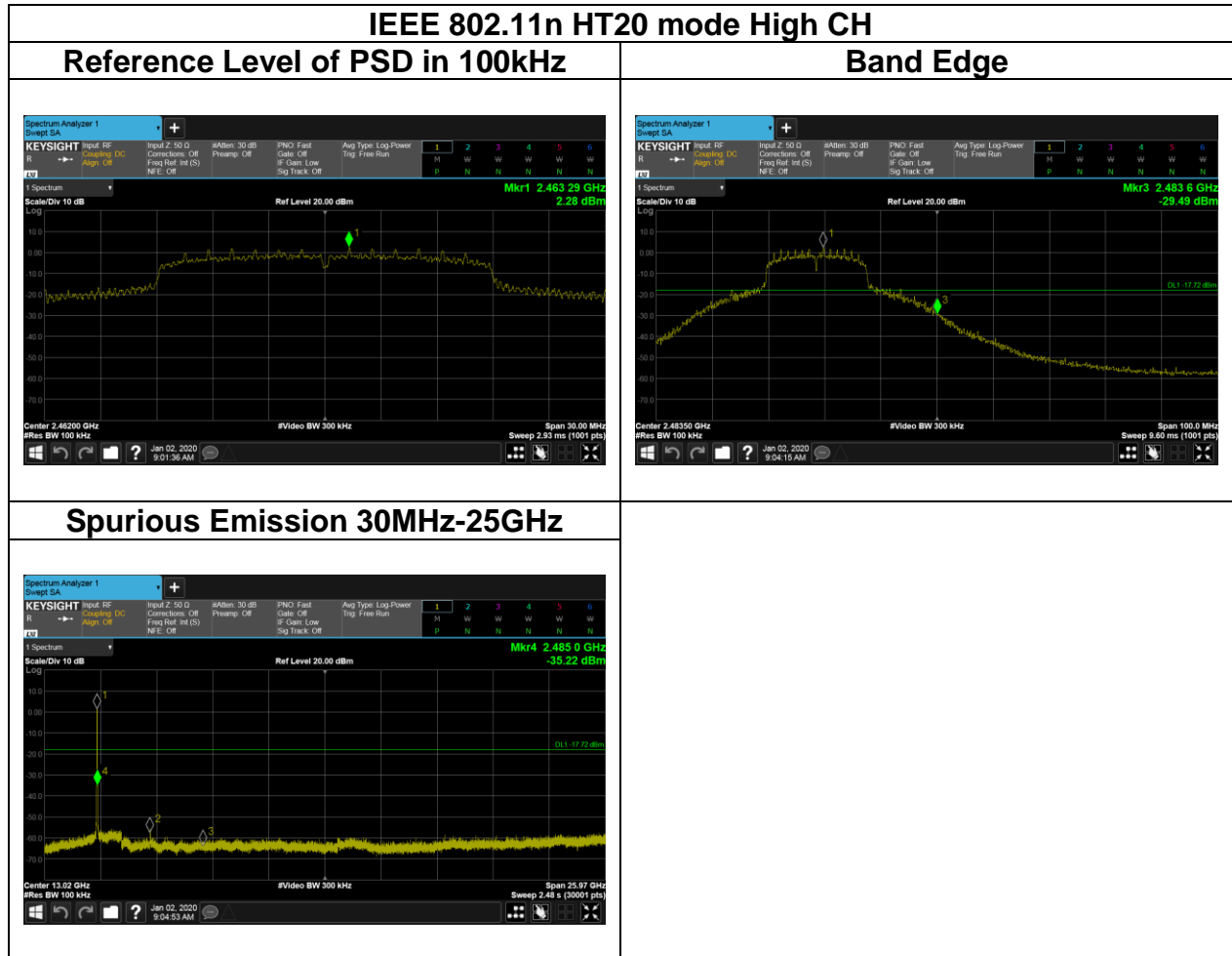

Report No.: T191218D03-RP3

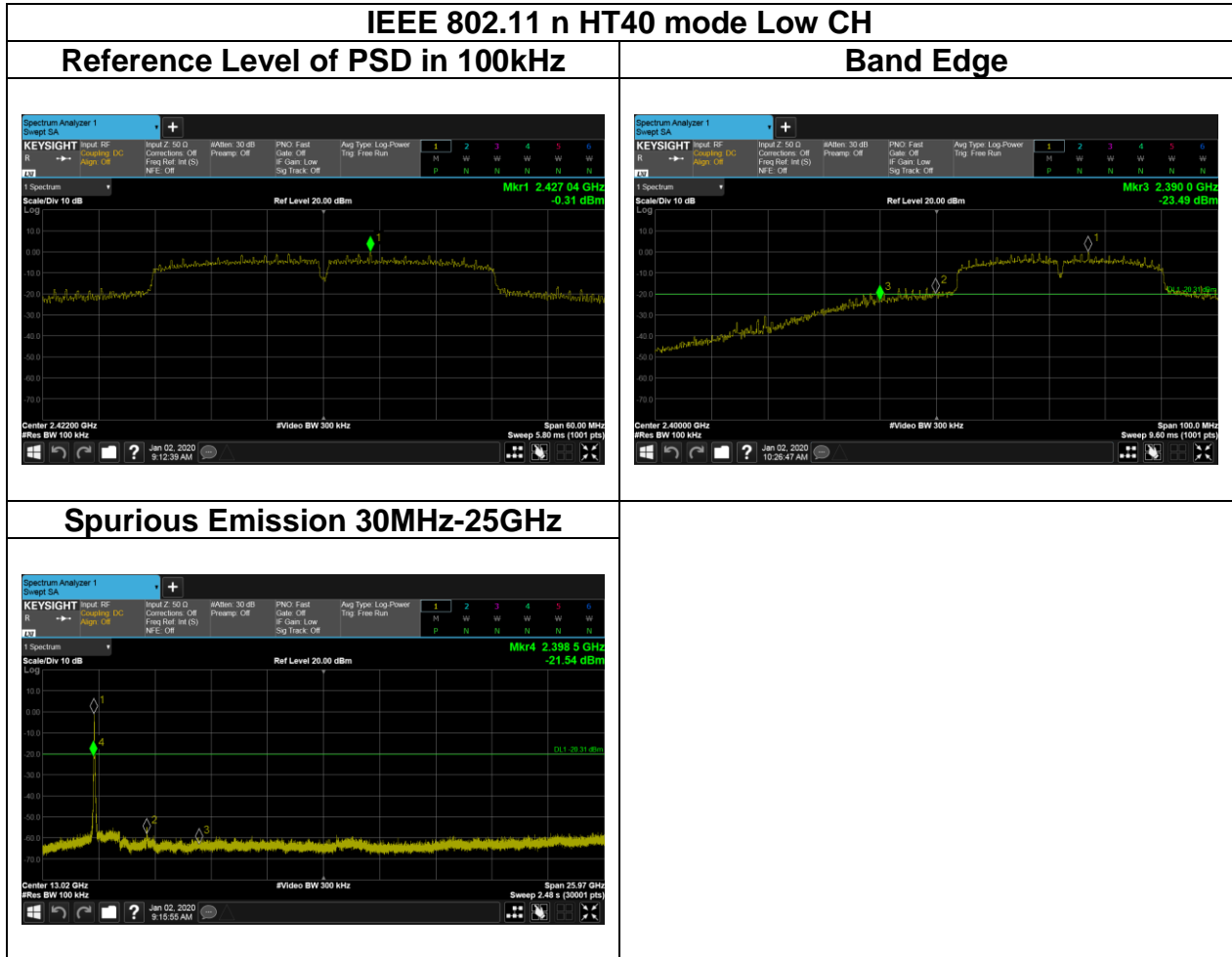

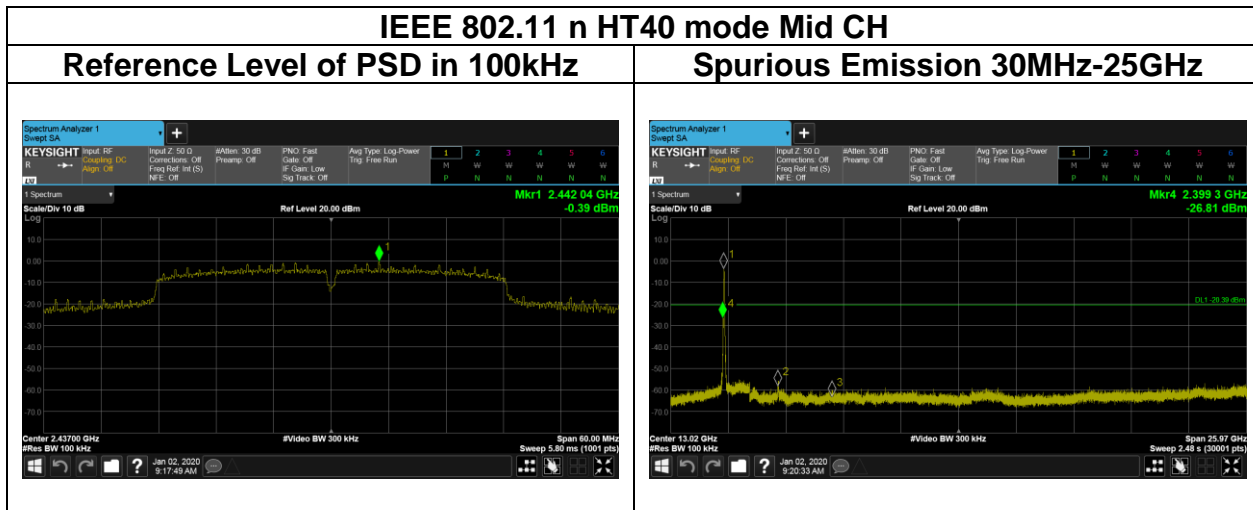

Report No.: T191218D03-RP3

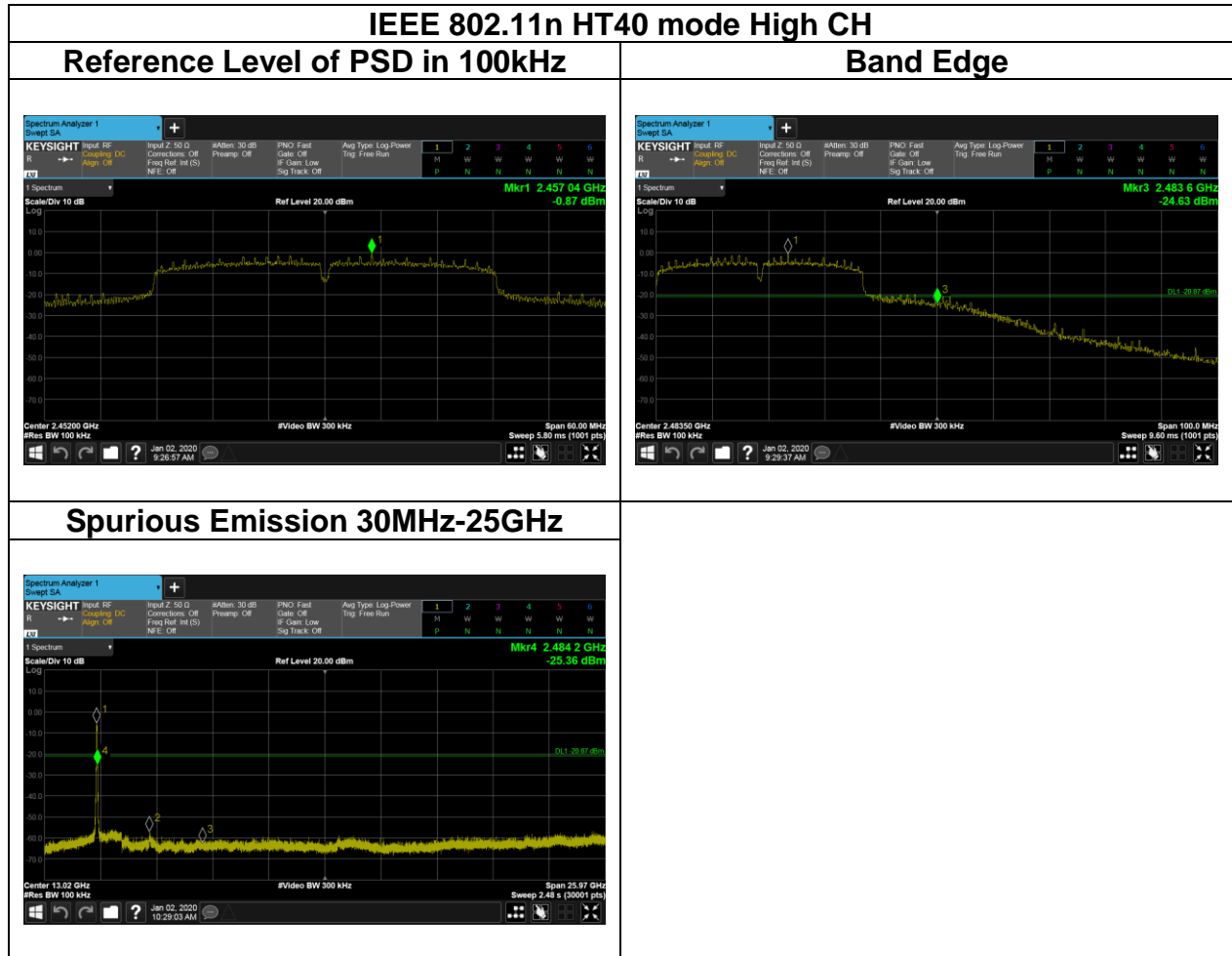

Report No.: T191218D03-RP3

4.6 RADIATION BANDEDGE AND SPURIOUS EMISSION

4.6.1 Test Limit

FCC according to §15.247(d), §15.209 and §15.205,

In any 100 kHz bandwidth outside the authorized frequency band, all harmonic and spurious must be least 20 dB below the highest emission level with the authorized frequency band. Radiation emission which fall in the restricted bands must also follow the FCC section 15.209 as below limit in table.

Below 30 MHz

Frequency	Field Strength (microvolts/m)	Magnetic H-Field (microamperes/m)	Measurement Distance (metres)
9-490 kHz	2,400/F (F in kHz)	2,400/F (F in kHz)	300
490-1,705 kHz	24,000/F (F in kHz)	24,000/F (F in kHz)	30
1.705-30 MHz	30	N/A	30

Above 30 MHz

Frequency	Field Strength (microvolts/m)	Measurement Distance (metres)
30-88	100	3
88-216	150	3
216-960	200	3
Above 960	500	3

Report No.: T191218D03-RP3

4.6.2 Test Procedure

Test method Refer as KDB 558074 D01

1. The EUT is placed on a turntable, Above 1 GHz is 1.5m and below 1 GHz is 0.8m above ground plane. The EUT Configured un accordance with ANSI C63.10: 2013, and the EUT set in a continuous mode.
2. The turntable shall be rotated for 360 degrees to determine the position of maximum emission level. And EUT is set 3m away from the receiving antenna, which is scanned from 1m to 4m above the ground plane to find out the highest emissions. Measurement are made polarized in both the vertical and the horizontal positions with antenna.
3. Span shall wide enough to full capture the emission measured. The SA from 30MHz to 26.5GHz set to the low, Mid and High channels with the EUT transmit.

Remark:

1. Although these tests were performed other than open area test site, adequate comparison measurements were confirmed against 30 m open are test site. Therefore sufficient tests were made to demonstrate that the alternative site produces results that correlate with the ones of tests made in an open field based on KDB 414788.
2. Note: No emission found between lowest internal used/generated frequency to 30MHz (9KHz~30MHz)

4. The SA setting following :

- (1) Below 1G : RBW = 100kHz, VBW \geq 3 RBW, Sweep = Auto, Detector = Peak, Trace = Max hold.
- (2) Above 1G :
 - (2.1) For Peak measurement : RBW = 1MHz, VBW \geq 3 RBW, Sweep = Auto, Detector = Peak, Trace = Max hold.
 - (2.2) For Average measurement : RBW = 1MHz, VBW
 - If Duty Cycle \geq 98%, VBW=10Hz.
 - If Duty Cycle < 98%, VBW=1/T.

Report No.: T191218D03-RP3

4.6.3 Test Setup

9kHz ~ 30MHz

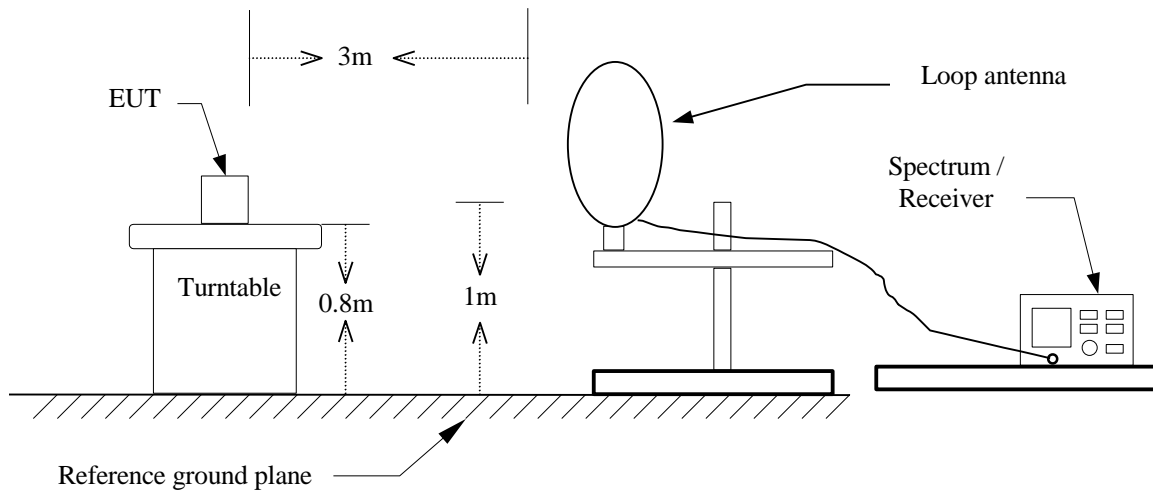

30MHz ~ 1GHz

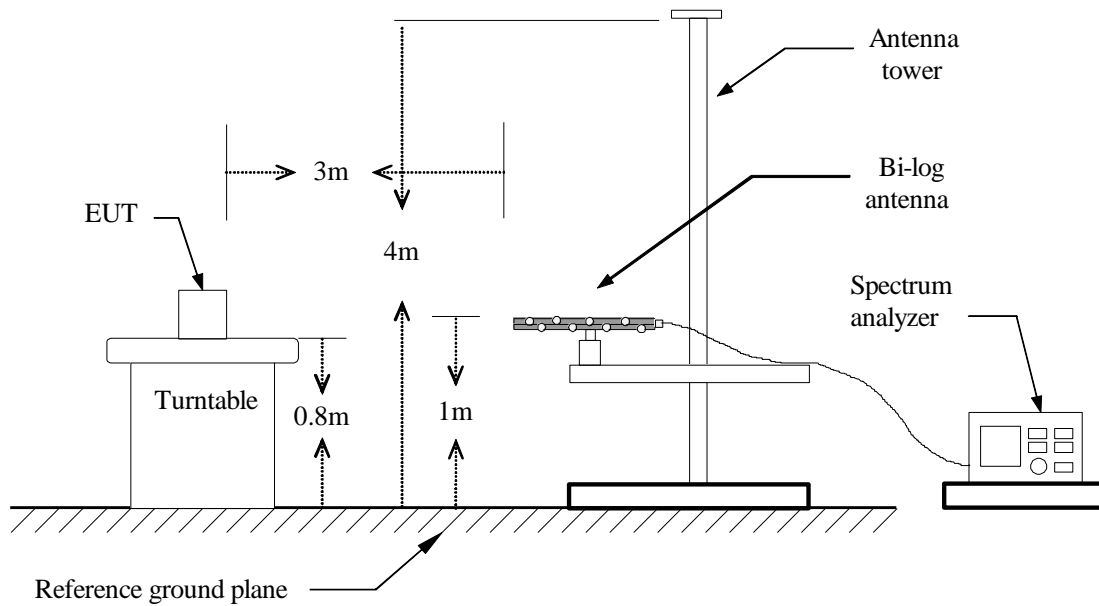

Report No.: T191218D03-RP3

Above 1 GHz

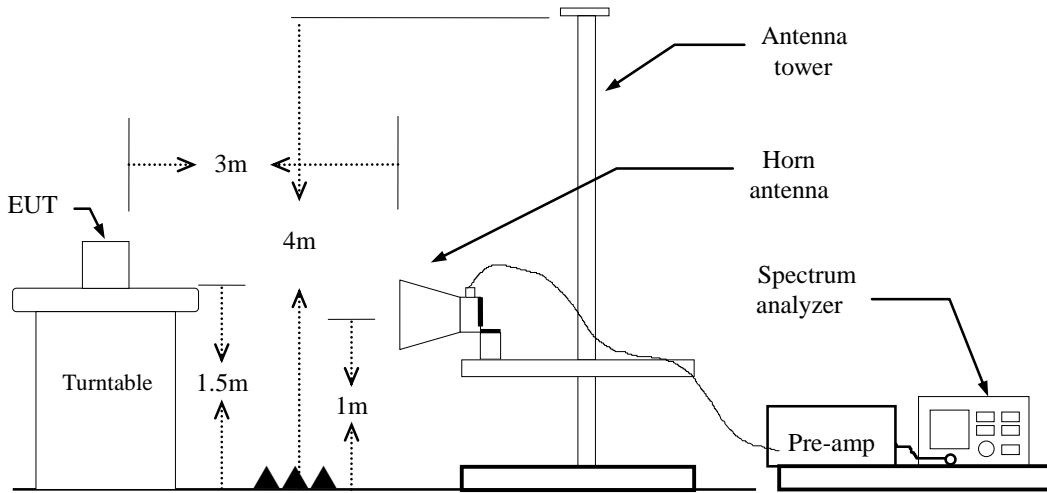

Report No.: T191218D03-RP3

4.6.4 Test Result

Band Edge Test Data

Test Mode	IEEE 802.11b Low CH	Temp/Hum	21.3(°C)/ 51%RH
Test Item	Band Edge	Test Date	January 13, 2020
Polarize	Vertical	Test Engineer	Jerry Chang
Detector	Peak		

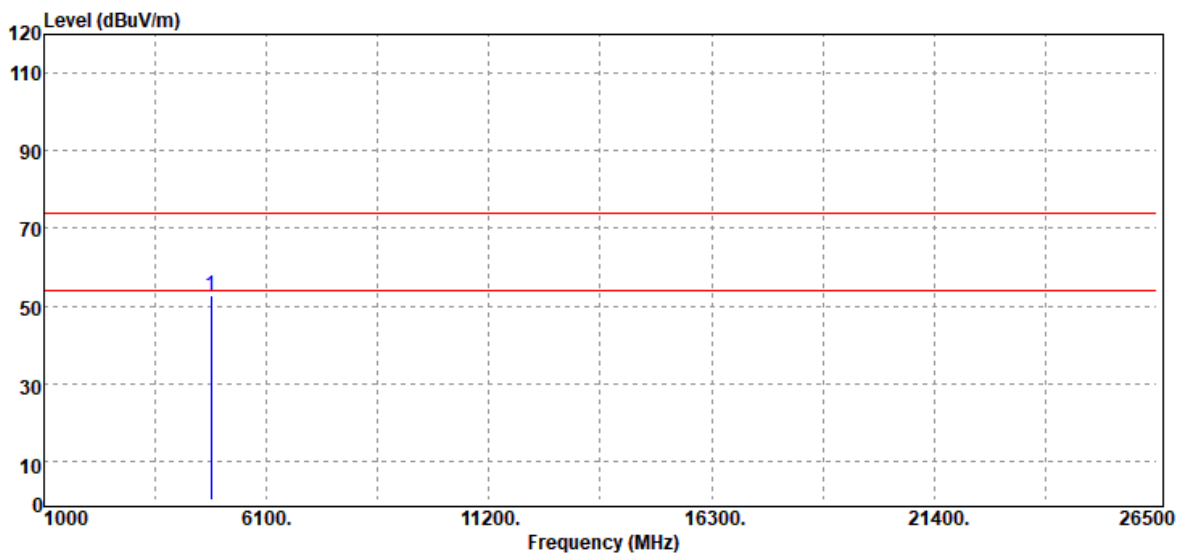

Frequency (MHz)	Reading (dBuV)	Correct Factor (dB/m)	Result (dBuV/m)	Limit (dBuV/m)	Margin (dB)	Remark
4824.00	49.14	3.58	52.72	74.00	-21.28	Peak
N/A						

Report No.: T191218D03-RP3

Test Mode	IEEE 802.11b Low CH	Temp/Hum	21.3(°C)/ 51%RH
Test Item	Band Edge	Test Date	January 13, 2020
Polarize	Horizontal	Test Engineer	Jerry Chang
Detector	Peak		

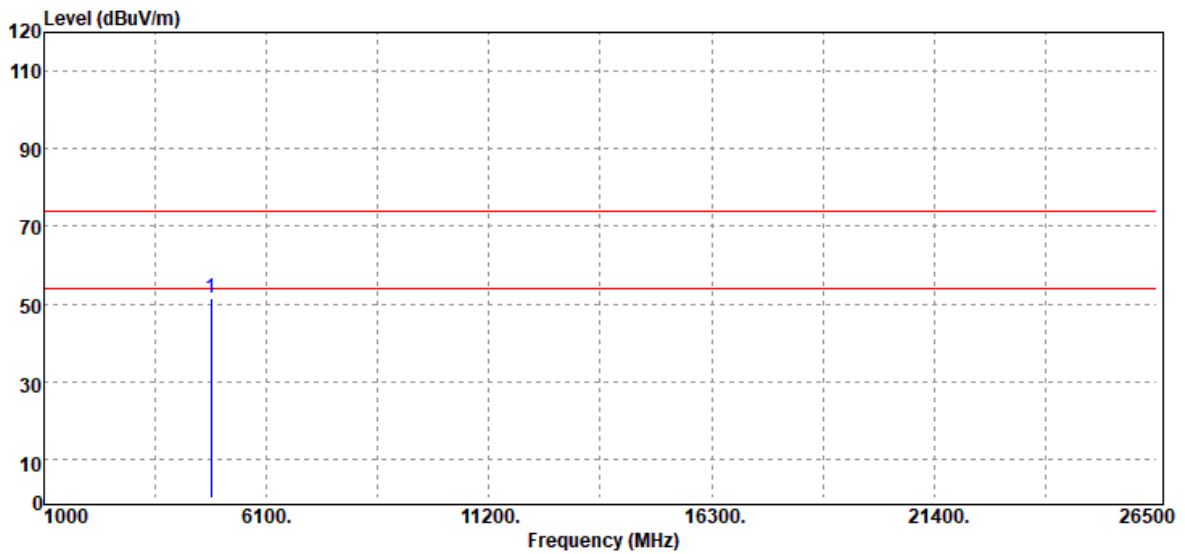

Frequency (MHz)	Reading (dBuV)	Correct Factor (dB/m)	Result (dBuV/m)	Limit (dBuV/m)	Margin (dB)	Remark
4824.00	47.75	3.58	51.33	74.00	-22.67	Peak
N/A						

Report No.: T191218D03-RP3

Test Mode	IEEE 802.11b High CH	Temp/Hum	21.3(°C)/ 51%RH
Test Item	Band Edge	Test Date	January 13, 2020
Polarize	Vertical	Test Engineer	Jerry Chang
Detector	Peak		

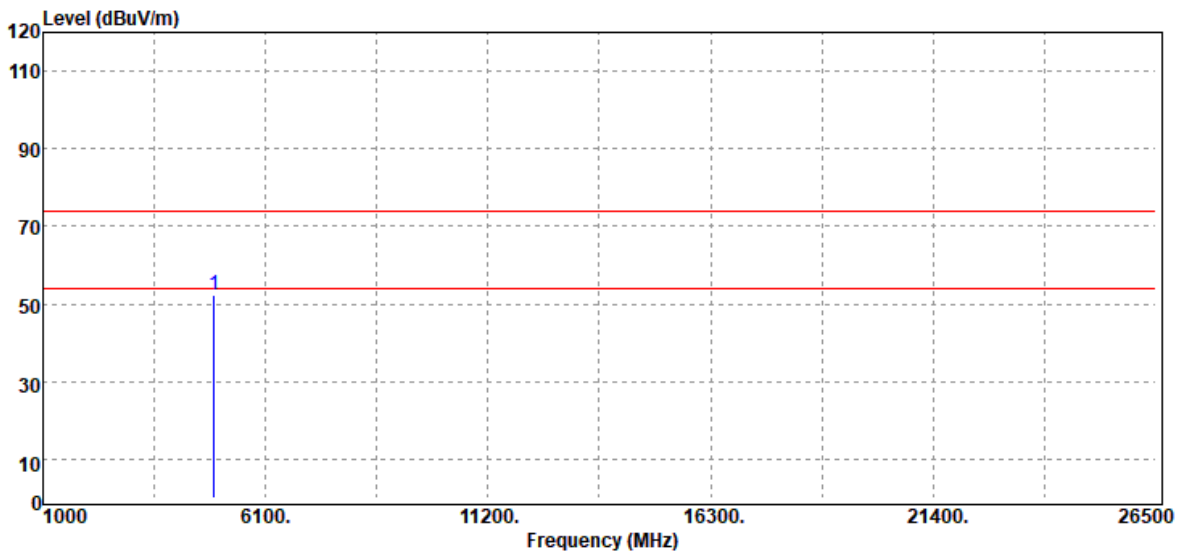

Frequency (MHz)	Reading (dBuV)	Correct Factor (dB/m)	Result (dBuV/m)	Limit (dBuV/m)	Margin (dB)	Remark
4924.00	48.31	4.18	52.49	74.00	-21.51	Peak
N/A						

Report No.: T191218D03-RP3

Test Mode	IEEE 802.11b High CH	Temp/Hum	21.3(°C)/ 51%RH
Test Item	Band Edge	Test Date	January 13, 2020
Polarize	Horizontal	Test Engineer	Jerry Chang
Detector	Peak		

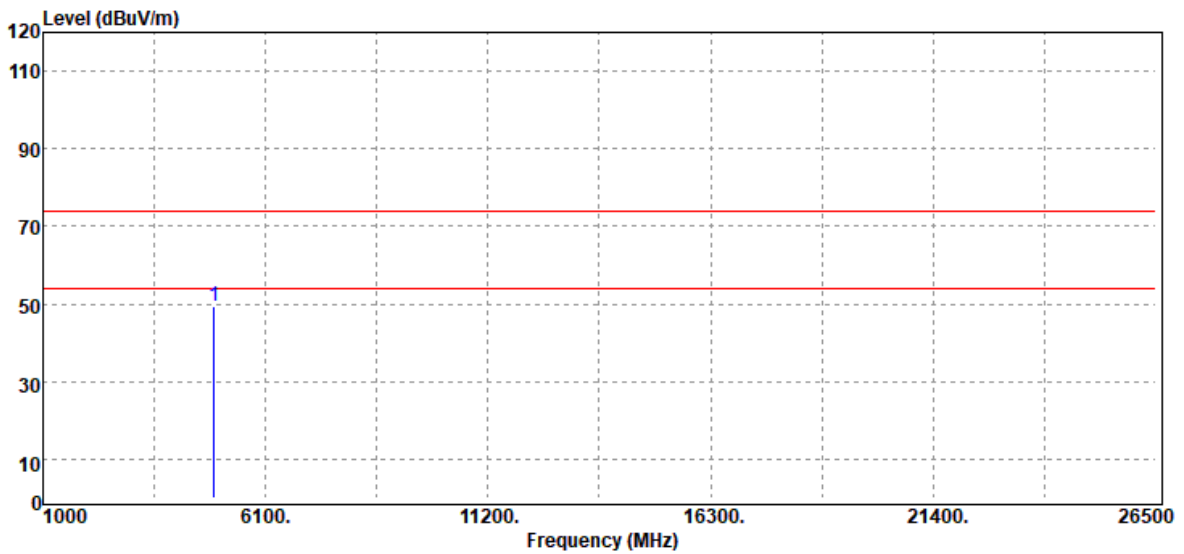

Frequency (MHz)	Reading (dBuV)	Correct Factor (dB/m)	Result (dBuV/m)	Limit (dBuV/m)	Margin (dB)	Remark
4924.00	45.15	4.18	49.33	74.00	-24.67	Peak
N/A						

Report No.: T191218D03-RP3

Test Mode	IEEE 802.11g Low CH	Temp/Hum	21.3(°C)/ 51%RH
Test Item	Band Edge	Test Date	January 13, 2020
Polarize	Vertical	Test Engineer	Jerry Chang
Detector	Peak		

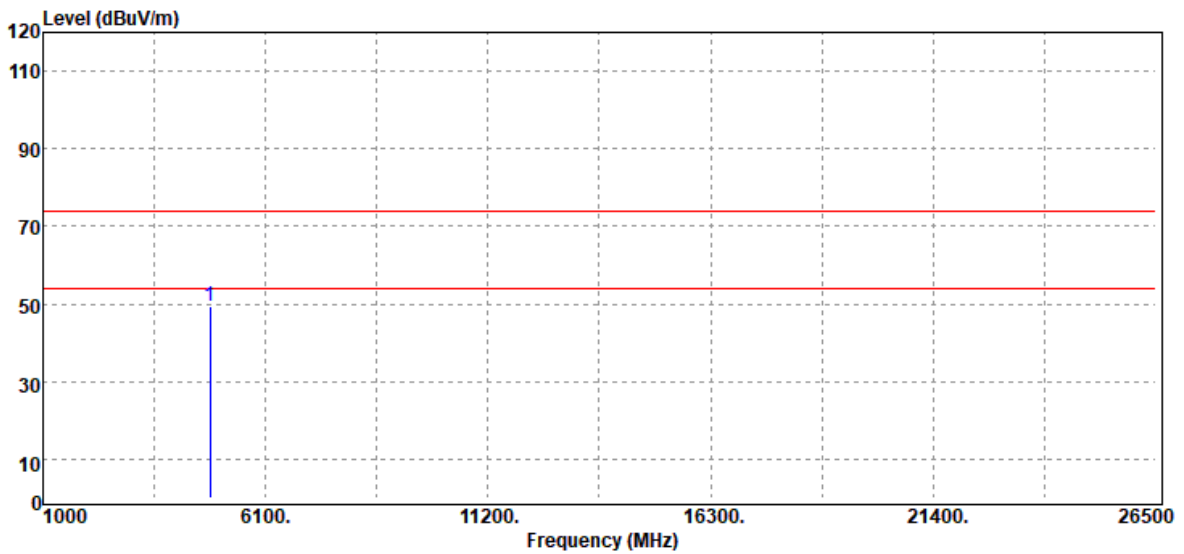

Frequency (MHz)	Reading (dBuV)	Correct Factor (dB/m)	Result (dBuV/m)	Limit (dBuV/m)	Margin (dB)	Remark
4824.00	45.86	3.58	49.44	74.00	-24.56	Peak
N/A						

Report No.: T191218D03-RP3

Test Mode	IEEE 802.11g Low CH	Temp/Hum	21.3(°C)/ 51%RH
Test Item	Band Edge	Test Date	January 13, 2020
Polarize	Horizontal	Test Engineer	Jerry Chang
Detector	Peak		

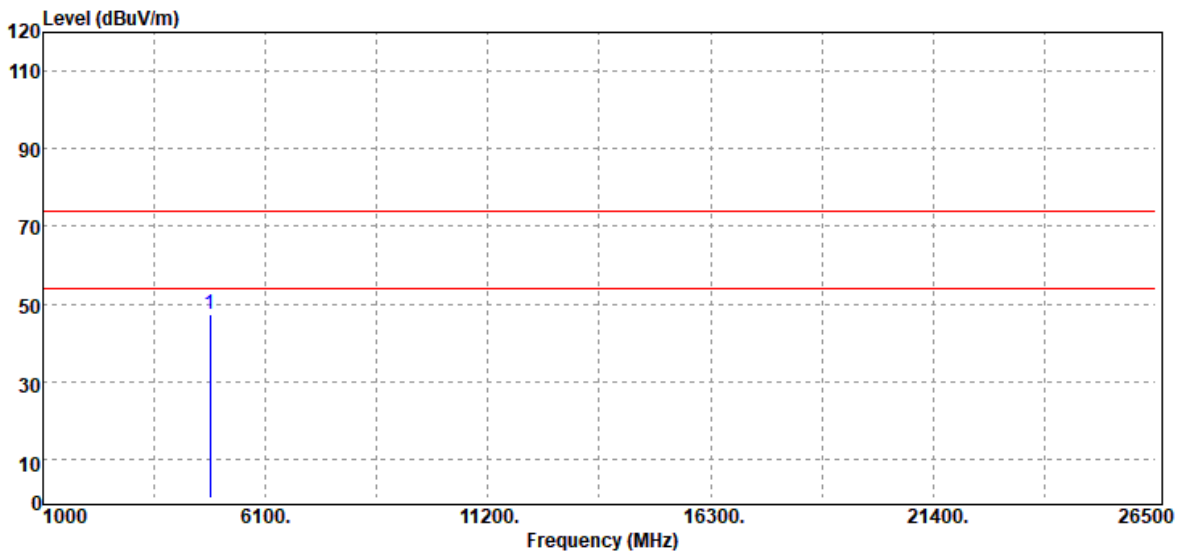

Frequency (MHz)	Reading (dBuV)	Correct Factor (dB/m)	Result (dBuV/m)	Limit (dBuV/m)	Margin (dB)	Remark
4824.00	43.81	3.58	47.39	74.00	-26.61	Peak
N/A						

Report No.: T191218D03-RP3

Test Mode	IEEE 802.11g High CH	Temp/Hum	21.3(°C)/ 51%RH
Test Item	Band Edge	Test Date	January 13, 2020
Polarize	Vertical	Test Engineer	Jerry Chang
Detector	Peak and Average		

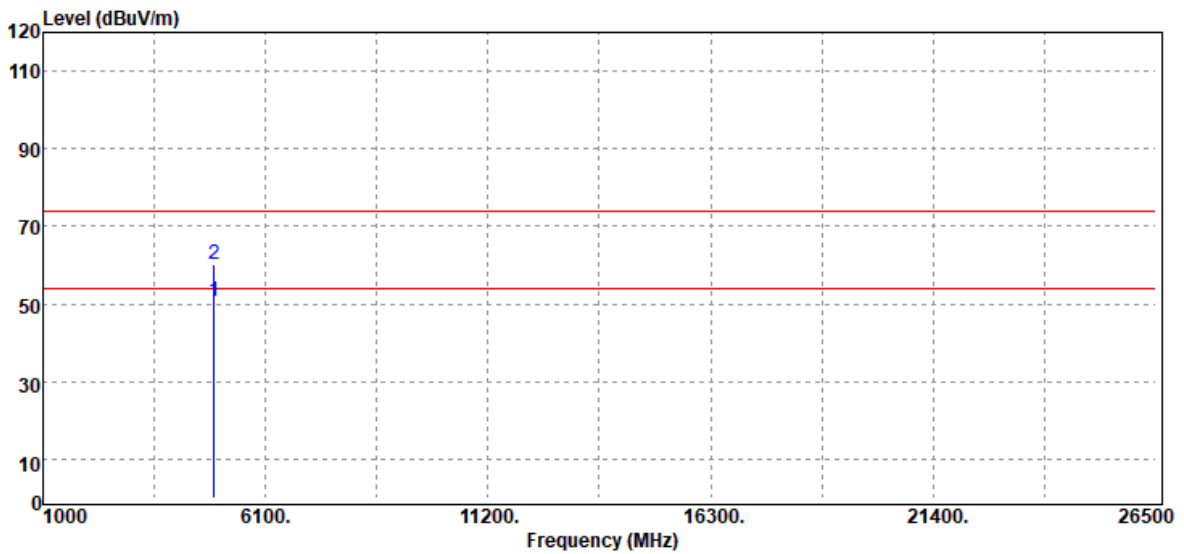

Frequency (MHz)	Reading (dBuV)	Correct Factor (dB/m)	Result (dBuV/m)	Limit (dBuV/m)	Margin (dB)	Remark
4924.00	46.58	4.18	50.76	54.00	-3.24	Average
4924.00	56.00	4.18	60.18	74.00	-13.82	Peak

Report No.: T191218D03-RP3

Test Mode	IEEE 802.11g High CH	Temp/Hum	21.3(°C)/ 51%RH
Test Item	Band Edge	Test Date	January 13, 2020
Polarize	Horizontal	Test Engineer	Jerry Chang
Detector	Peak and Average		

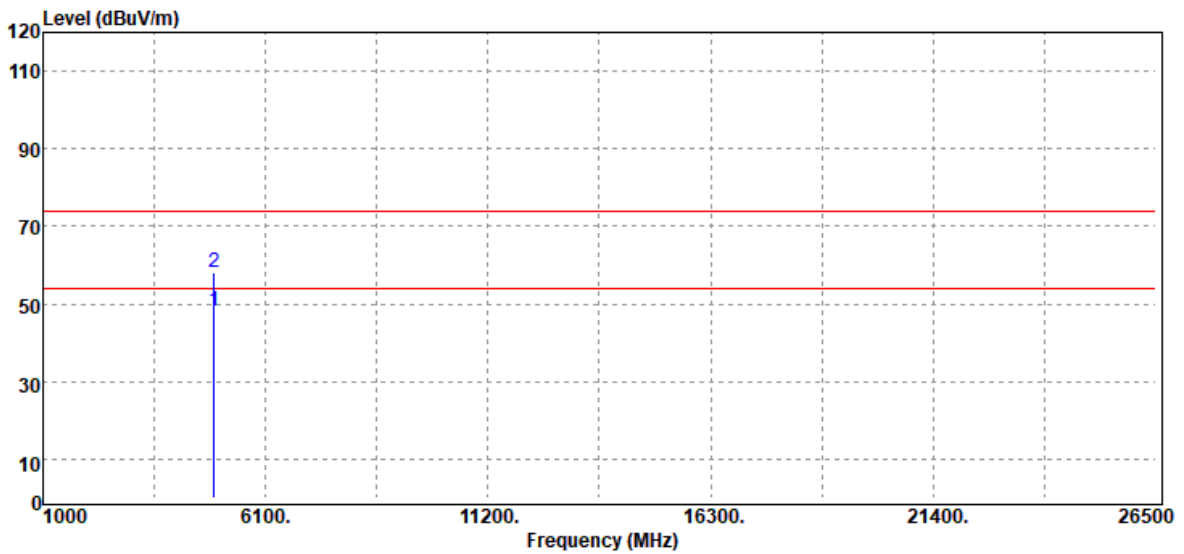

Frequency (MHz)	Reading (dBuV)	Correct Factor (dB/m)	Result (dBuV/m)	Limit (dBuV/m)	Margin (dB)	Remark
4924.00	44.03	4.18	48.21	54.00	-5.79	Average
4924.00	53.75	4.18	57.93	74.00	-16.07	Peak

Report No.: T191218D03-RP3

Test Mode	IEEE 802.11n HT20 Low CH	Temp/Hum	21.3(°C)/ 51%RH
Test Item	Band Edge	Test Date	January 13, 2020
Polarize	Vertical	Test Engineer	Jerry Chang
Detector	Peak		

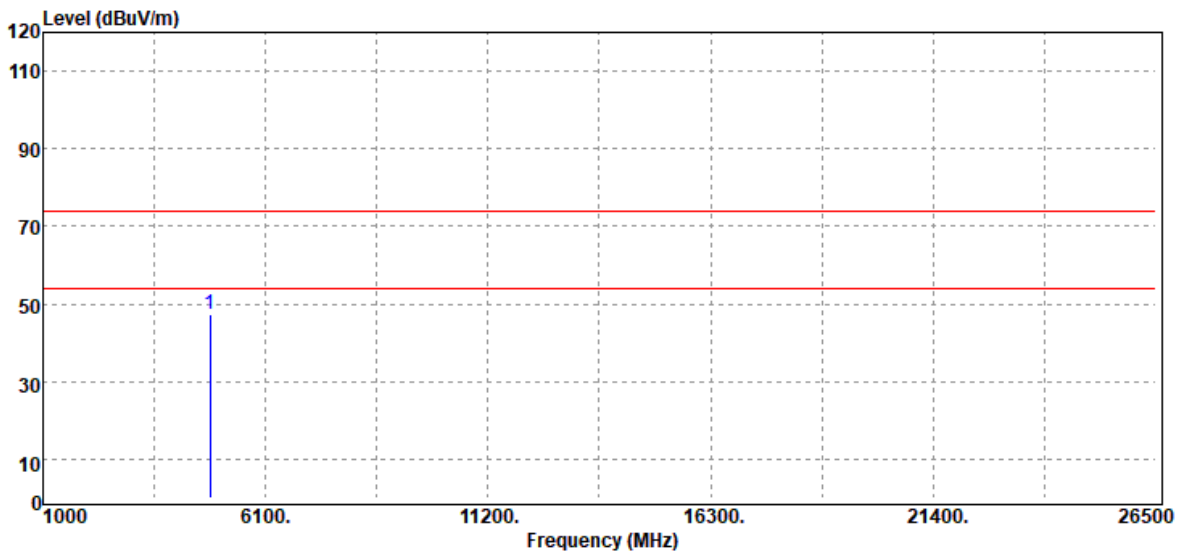

Frequency (MHz)	Reading (dBuV)	Correct Factor (dB/m)	Result (dBuV/m)	Limit (dBuV/m)	Margin (dB)	Remark
4824.00	43.90	3.58	47.48	74.00	-26.52	Peak
N/A						

Report No.: T191218D03-RP3

Test Mode	IEEE 802.11n HT20 Low CH	Temp/Hum	21.3(°C)/ 51%RH
Test Item	Band Edge	Test Date	January 13, 2020
Polarize	Horizontal	Test Engineer	Jerry Chang
Detector	Peak		

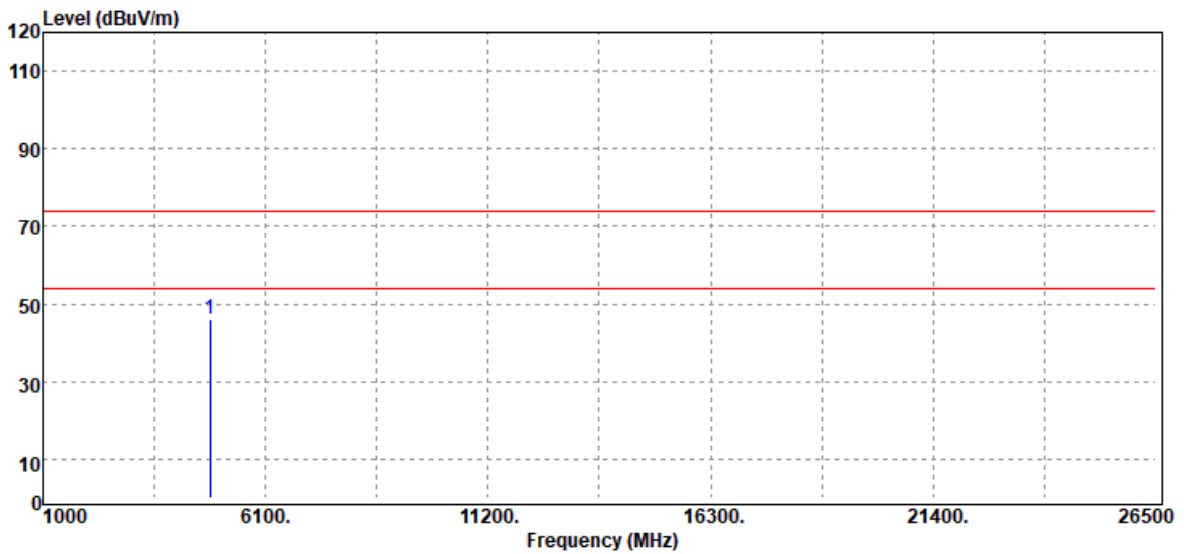

Frequency (MHz)	Reading (dBuV)	Correct Factor (dB/m)	Result (dBuV/m)	Limit (dBuV/m)	Margin (dB)	Remark
4824.00	42.65	3.58	46.23	74.00	-27.77	Peak
N/A						

Report No.: T191218D03-RP3

Test Mode	IEEE 802.11n HT20 High CH	Temp/Hum	21.3(°C)/ 51%RH
Test Item	Band Edge	Test Date	January 13, 2020
Polarize	Vertical	Test Engineer	Jerry Chang
Detector	Peak and Average		

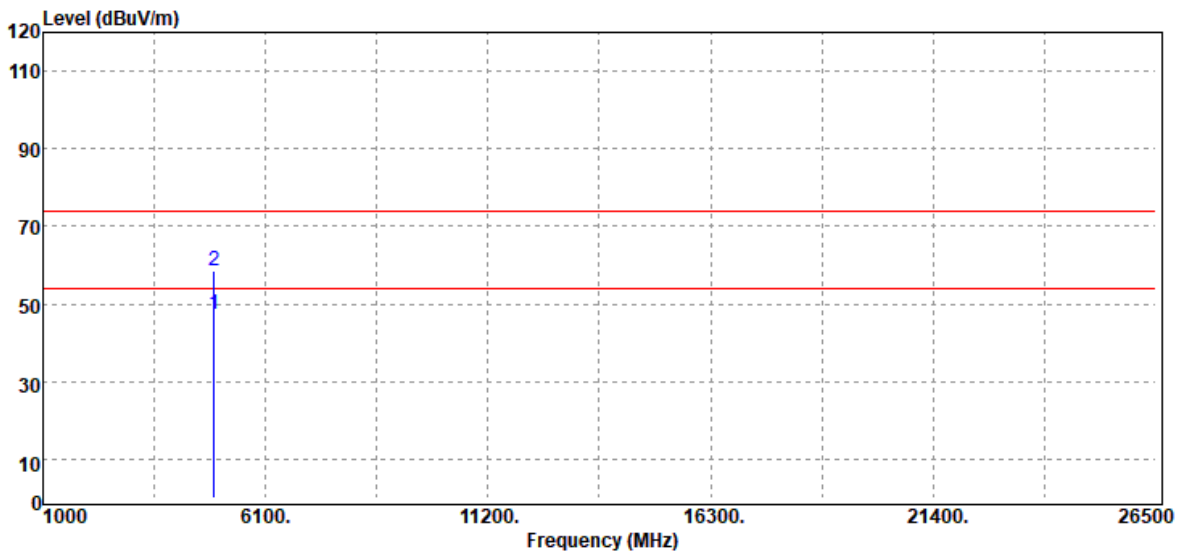

Frequency (MHz)	Reading (dBuV)	Correct Factor (dB/m)	Result (dBuV/m)	Limit (dBuV/m)	Margin (dB)	Remark
4924.00	43.18	4.18	47.36	54.00	-6.64	Average
4924.00	54.22	4.18	58.40	74.00	-15.60	Peak

Report No.: T191218D03-RP3

Test Mode	IEEE 802.11n HT20 High CH	Temp/Hum	21.3(°C)/ 51%RH
Test Item	Band Edge	Test Date	January 13, 2020
Polarize	Horizontal	Test Engineer	Jerry Chang
Detector	Peak and Average		

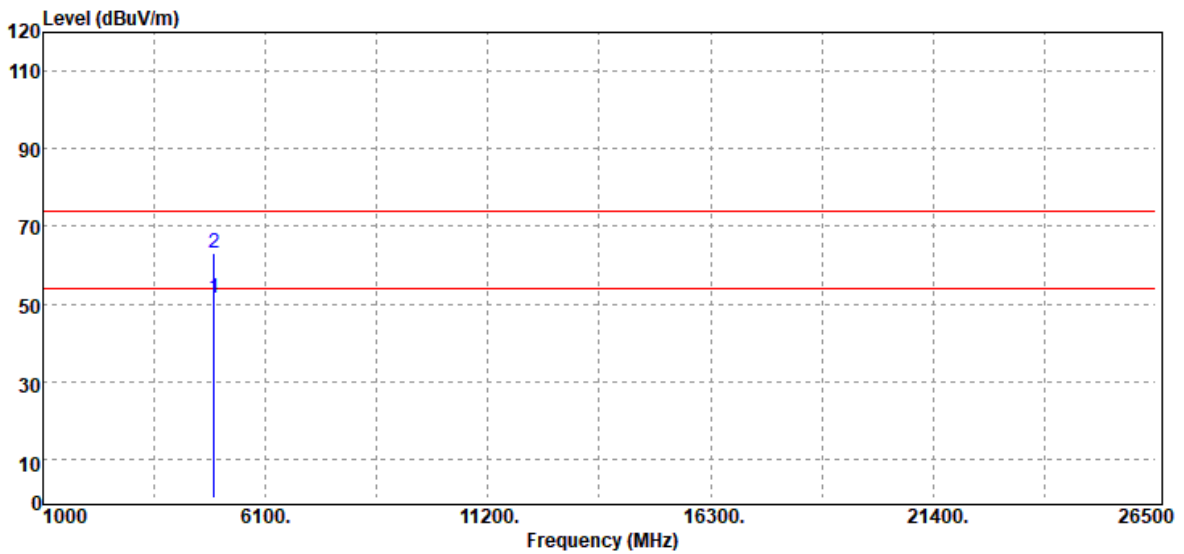

Frequency (MHz)	Reading (dBuV)	Correct Factor (dB/m)	Result (dBuV/m)	Limit (dBuV/m)	Margin (dB)	Remark
4924.00	47.18	4.18	51.36	54.00	-2.64	Average
4924.00	58.74	4.18	62.92	74.00	-11.08	Peak

Report No.: T191218D03-RP3

Test Mode	IEEE 802.11n HT40 Low CH	Temp/Hum	21.3(°C)/ 51%RH
Test Item	Band Edge	Test Date	January 13, 2020
Polarize	Vertical	Test Engineer	Jerry Chang
Detector	Peak		

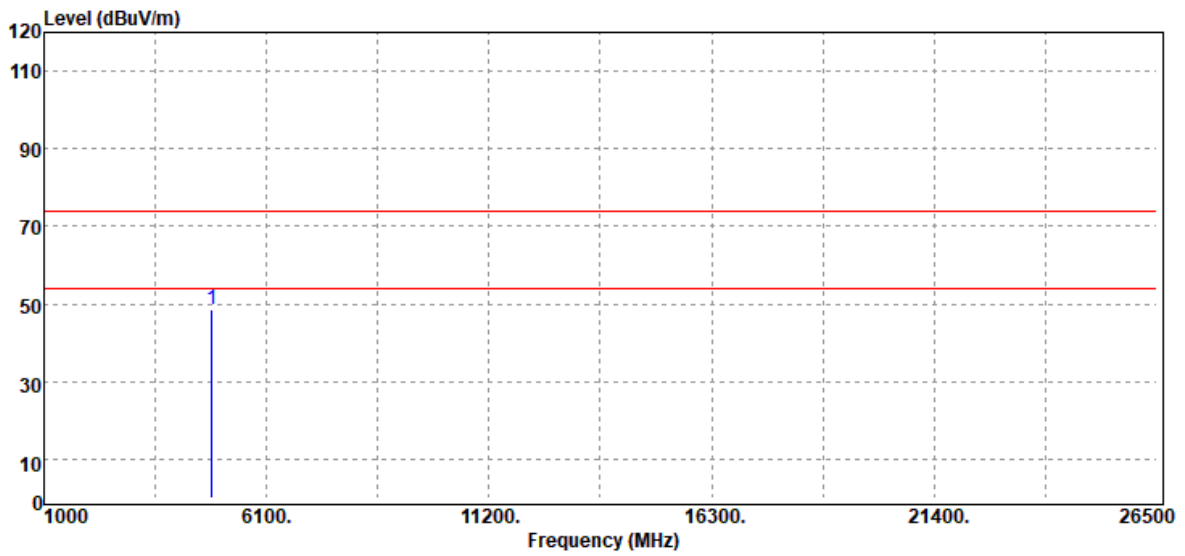

Frequency (MHz)	Reading (dBuV)	Correct Factor (dB/m)	Result (dBuV/m)	Limit (dBuV/m)	Margin (dB)	Remark
4844.00	45.18	3.61	48.79	74.00	-25.21	Peak
N/A						

Report No.: T191218D03-RP3

Test Mode	IEEE 802.11n HT40 Low CH	Temp/Hum	21.3(°C)/ 51%RH
Test Item	Band Edge	Test Date	January 13, 2020
Polarize	Horizontal	Test Engineer	Jerry Chang
Detector	Peak		

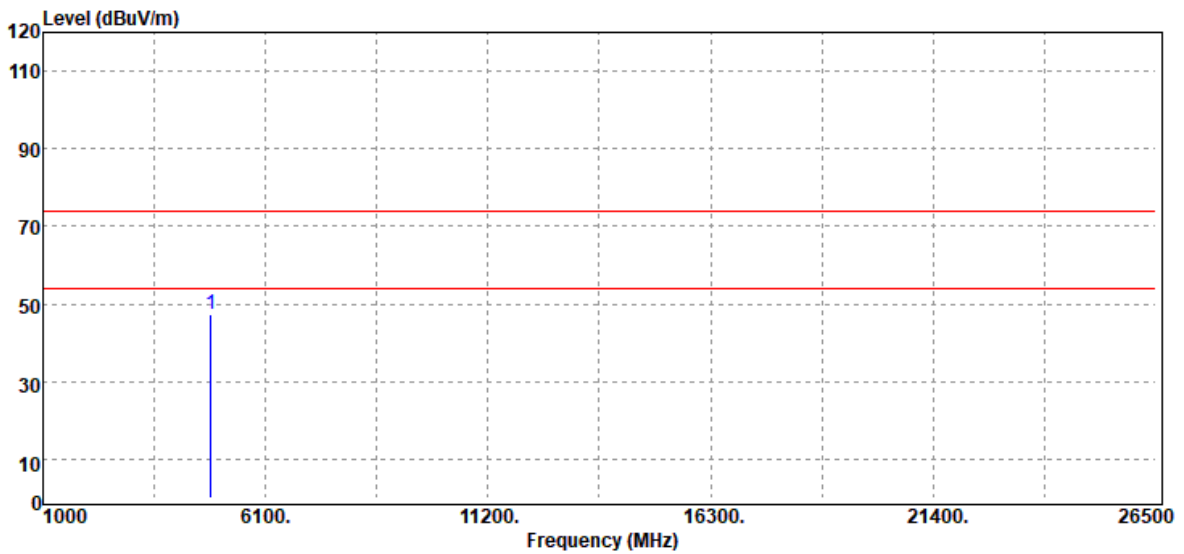

Frequency (MHz)	Reading (dBuV)	Correct Factor (dB/m)	Result (dBuV/m)	Limit (dBuV/m)	Margin (dB)	Remark
4844.00	43.59	3.61	47.20	74.00	-26.80	Peak
N/A						

Report No.: T191218D03-RP3

Test Mode	IEEE 802.11n HT40 High CH	Temp/Hum	21.3(°C)/ 51%RH
Test Item	Band Edge	Test Date	January 13, 2020
Polarize	Vertical	Test Engineer	Jerry Chang
Detector	Peak		

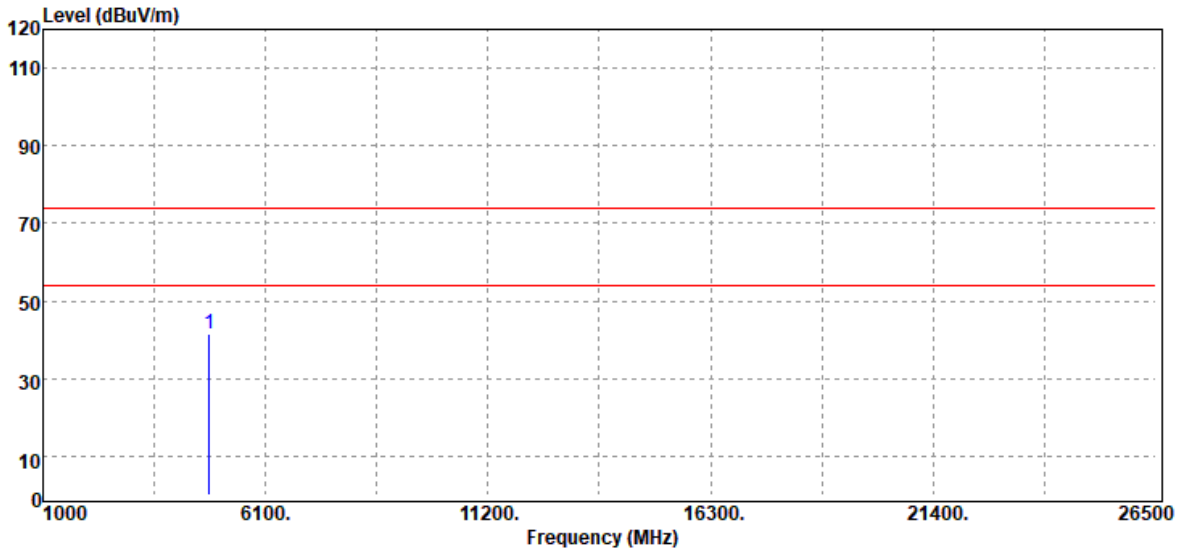

Frequency (MHz)	Reading (dBuV)	Correct Factor (dB/m)	Result (dBuV/m)	Limit (dBuV/m)	Margin (dB)	Remark
4804.00	38.16	3.56	41.72	74.00	-32.28	Peak
N/A						

Report No.: T191218D03-RP3

Test Mode	IEEE 802.11n HT40 High CH	Temp/Hum	21.3(°C)/ 51%RH
Test Item	Band Edge	Test Date	January 13, 2020
Polarize	Horizontal	Test Engineer	Jerry Chang
Detector	Peak		

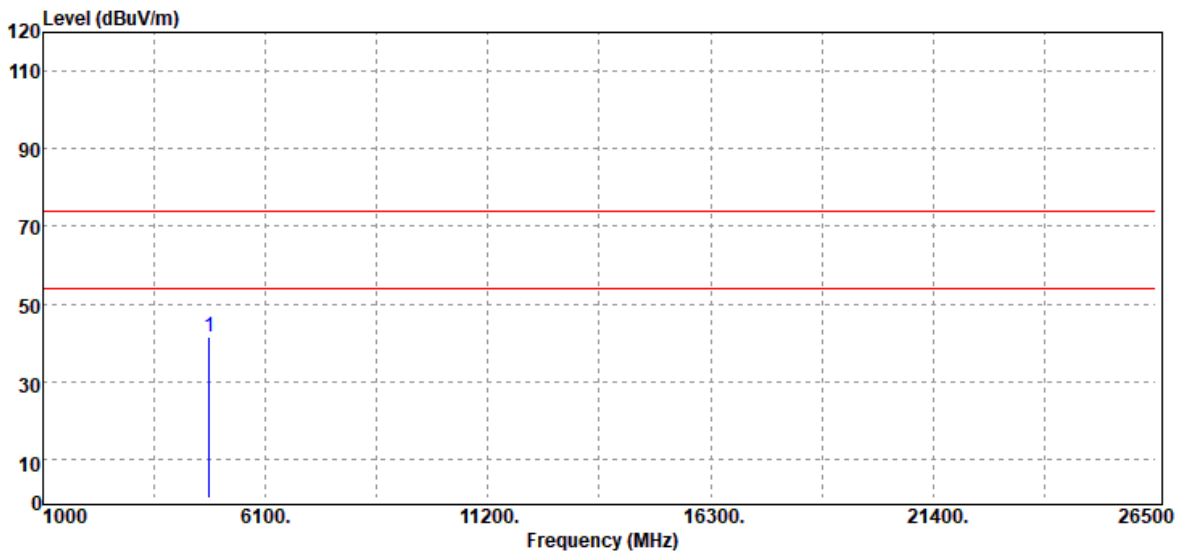

Frequency (MHz)	Reading (dBuV)	Correct Factor (dB/m)	Result (dBuV/m)	Limit (dBuV/m)	Margin (dB)	Remark
4804.00	37.93	3.56	41.49	74.00	-32.51	Peak
N/A						

Report No.: T191218D03-RP3

Below 1G Test Data

Test Mode	Mode 1	Temp/Hum	21.3(°C)/ 51%RH
Test Item	30MHz-1GHz	Test Date	January 13, 2020
Polarize	Vertical	Test Engineer	Jerry Chang
Detector	Peak		

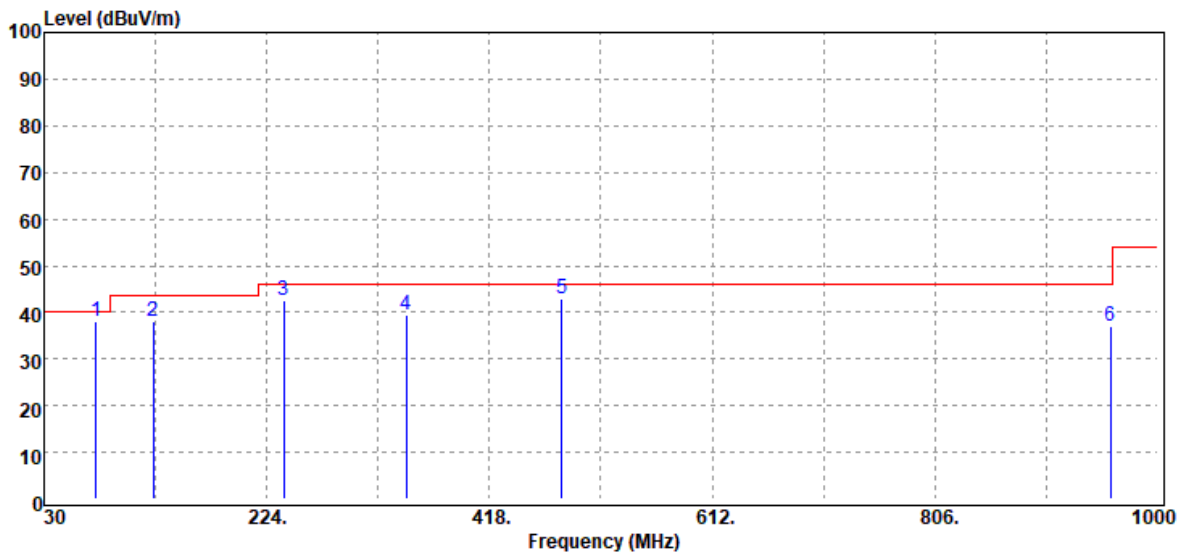

Frequency (MHz)	Reading (dBuV)	Correct Factor (dB/m)	Result (dBuV/m)	Limit (dBuV/m)	Margin (dB)	Remark
75.59	52.85	-14.79	38.06	40.00	-1.94	Peak
125.06	46.91	-8.80	38.11	43.50	-5.39	Peak
238.55	53.03	-10.38	42.65	46.00	-3.35	Peak
345.25	46.70	-7.12	39.58	46.00	-6.42	Peak
481.05	46.07	-3.05	43.02	46.00	-2.98	Peak
959.26	32.71	4.48	37.19	46.00	-8.81	Peak

Report No.: T191218D03-RP3

Test Mode	Mode 1	Temp/Hum	21.3(°C)/ 51%RH
Test Item	30MHz-1GHz	Test Date	January 13, 2020
Polarize	Horizontal	Test Engineer	Jerry Chang
Detector	Peak		

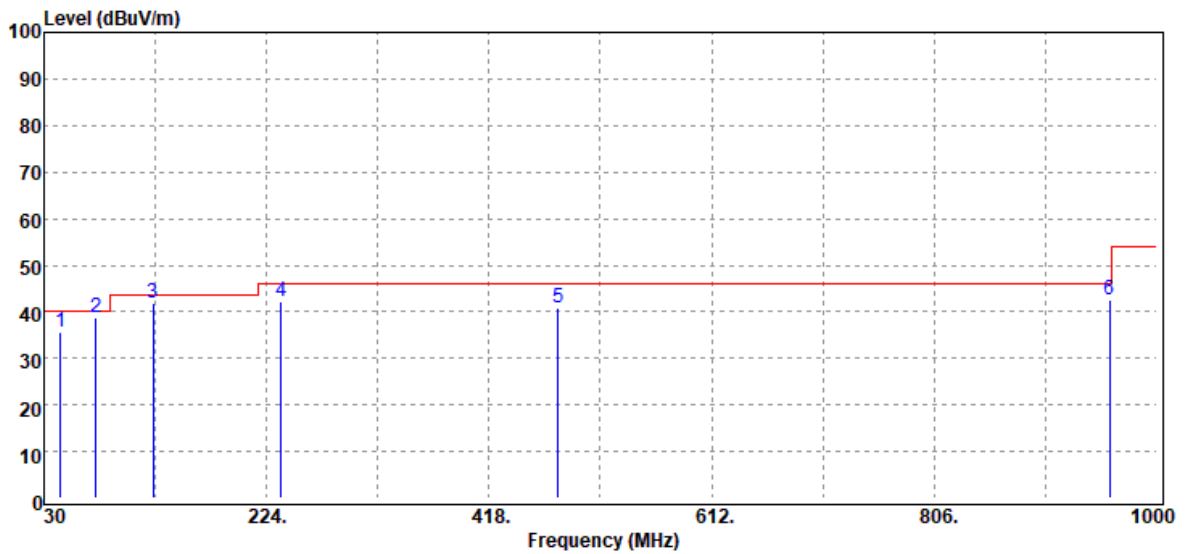

Frequency (MHz)	Reading (dBuV)	Correct Factor (dB/m)	Result (dBuV/m)	Limit (dBuV/m)	Margin (dB)	Remark
44.55	48.29	-12.72	35.57	40.00	-4.43	Peak
75.59	53.63	-14.79	38.84	40.00	-1.16	Peak
125.06	50.68	-8.80	41.88	43.50	-1.62	Peak
236.61	52.67	-10.51	42.16	46.00	-3.84	Peak
478.14	43.84	-2.97	40.87	46.00	-5.13	Peak
959.26	38.20	4.48	42.68	46.00	-3.32	Peak

Report No.: T191218D03-RP3

Above 1G Test Data

Test Mode	IEEE 802.11b Low CH	Temp/Hum	21.3(°C)/ 51%RH
Test Item	Harmonic	Test Date	January 13, 2020
Polarize	Vertical	Test Engineer	Jerry Chang
Detector	Peak and Average		

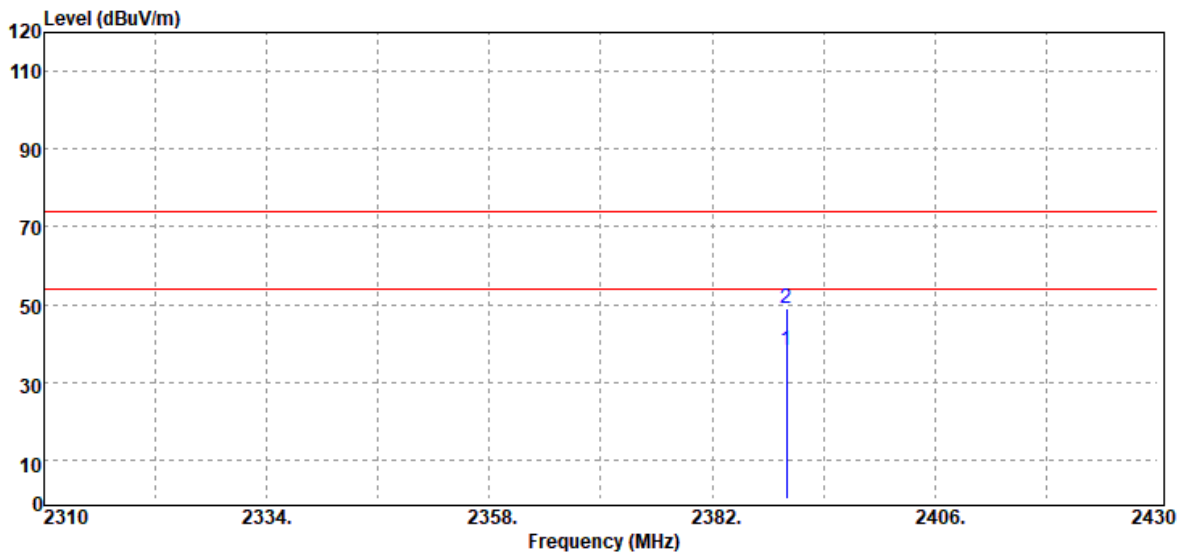

Frequency (MHz)	Reading (dBuV)	Correct Factor (dB/m)	Result (dBuV/m)	Limit (dBuV/m)	Margin (dB)	Remark
2390.00	40.98	-2.82	38.16	54.00	-15.84	Average
2390.00	51.68	-2.82	48.86	74.00	-25.14	Peak

Remark:

1. Measuring frequencies from 1 GHz to the 10th harmonic of highest fundamental frequency.

Report No.: T191218D03-RP3

Test Mode	IEEE 802.11b Low CH	Temp/Hum	21.3(°C)/ 51%RH
Test Item	Harmonic	Test Date	January 13, 2020
Polarize	Horizontal	Test Engineer	Jerry Chang
Detector	Peak and Average		

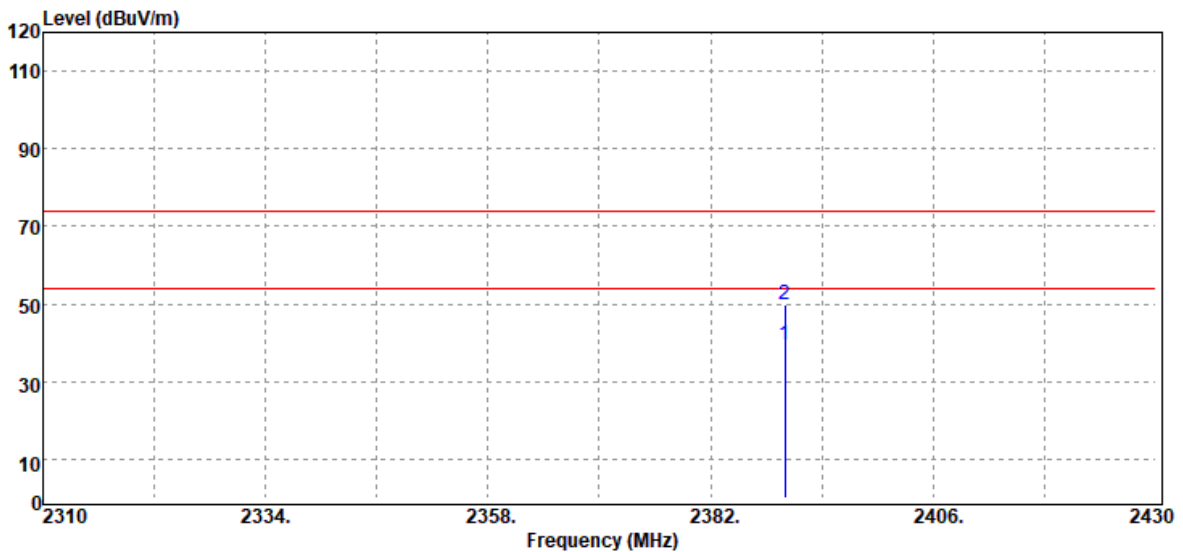

Frequency (MHz)	Reading (dBuV)	Correct Factor (dB/m)	Result (BuV/m)	Limit (dBuV/m)	Margin (dB)	Remark
2390.00	42.20	-2.82	39.38	54.00	-14.62	Average
2390.00	52.67	-2.82	49.85	74.00	-24.15	Peak

Remark:

1. Measuring frequencies from 1 GHz to the 10th harmonic of highest fundamental frequency.

Report No.: T191218D03-RP3

Test Mode	IEEE 802.11b High CH	Temp/Hum	21.3(°C)/ 51%RH
Test Item	Harmonic	Test Date	January 13, 2020
Polarize	Vertical	Test Engineer	Jerry Chang
Detector	Peak and Average		

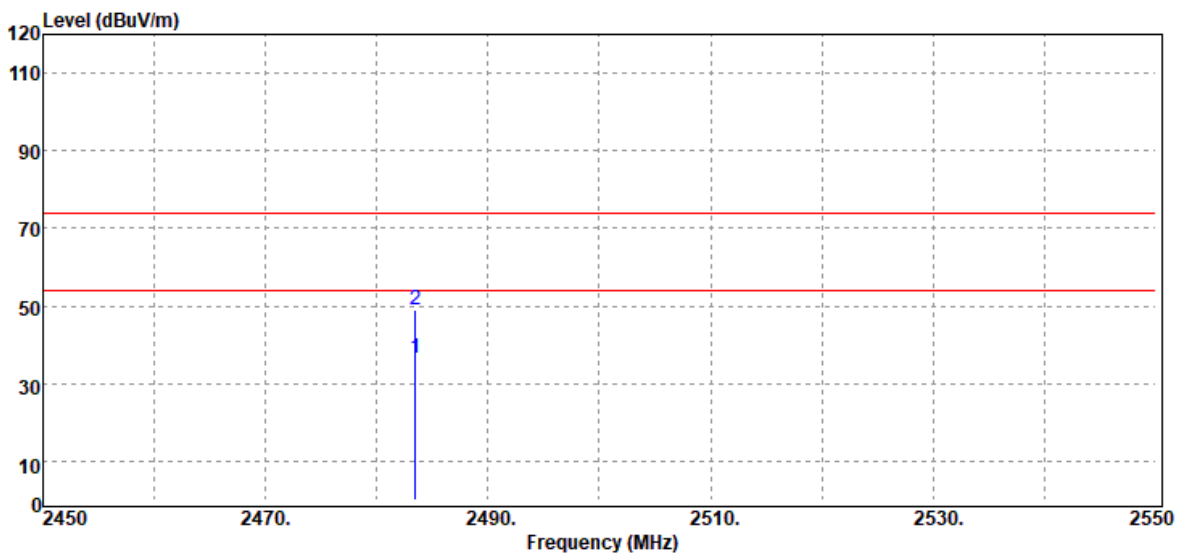

Frequency (MHz)	Reading (dBuV)	Correct Factor (dB/m)	Result (dBuV/m)	Limit (dBuV/m)	Margin (dB)	Remark
2483.50	38.73	-2.30	36.43	54.00	-17.57	Average
2483.50	51.17	-2.30	48.87	74.00	-25.13	Peak

Remark:

1. Measuring frequencies from 1 GHz to the 10th harmonic of highest fundamental frequency.

Report No.: T191218D03-RP3

Test Mode	IEEE 802.11b High CH	Temp/Hum	21.3(°C)/ 51%RH
Test Item	Harmonic	Test Date	January 13, 2020
Polarize	Horizontal	Test Engineer	Jerry Chang
Detector	Peak and Average		

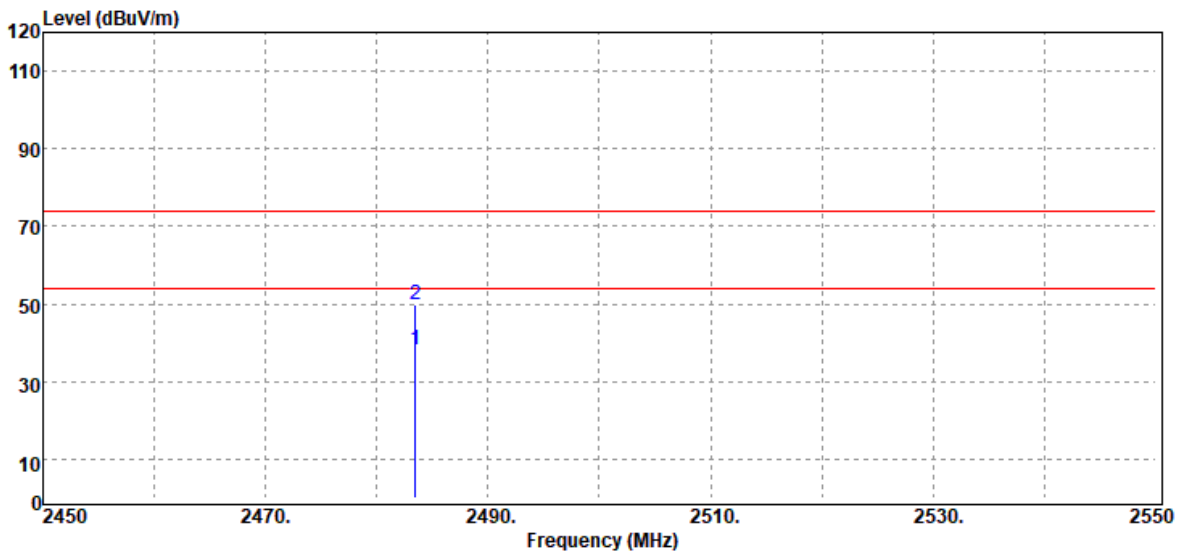

Frequency (MHz)	Reading (dBuV)	Correct Factor (dB/m)	Result (dBuV/m)	Limit (dBuV/m)	Margin (dB)	Remark
2483.50	40.39	-2.30	38.09	54.00	-15.91	Average
2483.50	51.97	-2.30	49.67	74.00	-24.33	Peak

Remark:

1. Measuring frequencies from 1 GHz to the 10th harmonic of highest fundamental frequency.

Report No.: T191218D03-RP3

Test Mode	IEEE 802.11g Low CH	Temp/Hum	21.3(°C)/ 51%RH
Test Item	Harmonic	Test Date	January 13, 2020
Polarize	Vertical	Test Engineer	Jerry Chang
Detector	Peak and Average		

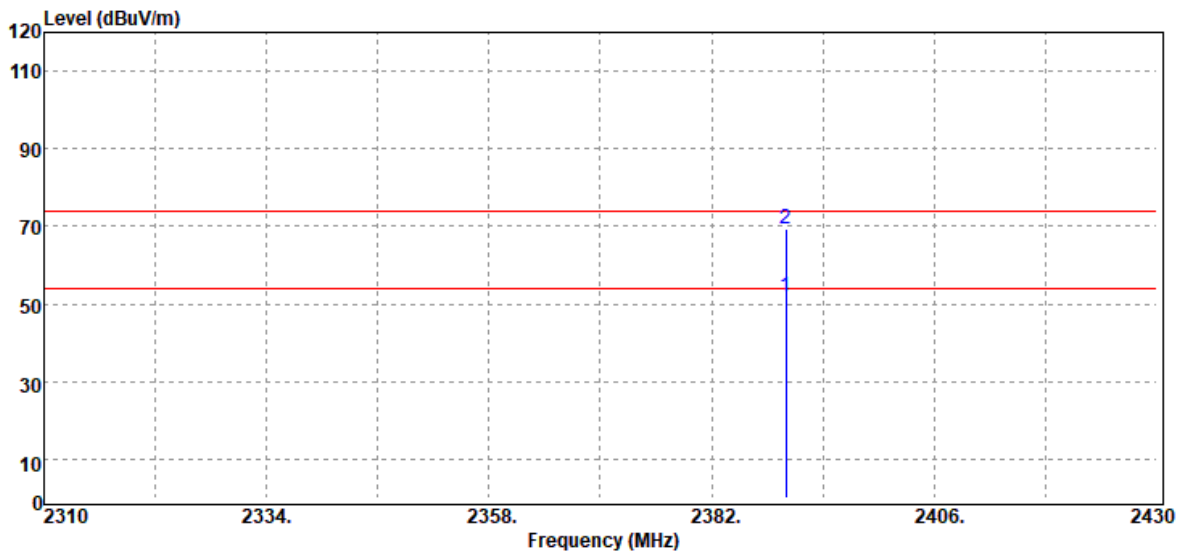

Frequency (MHz)	Reading (dBuV)	Correct Factor (dB/m)	Result (dBuV/m)	Limit (dBuV/m)	Margin (dB)	Remark
2390.00	54.81	-2.82	51.99	54.00	-2.01	Average
2390.00	72.17	-2.82	69.35	74.00	-4.65	Peak

Remark:

1. Measuring frequencies from 1 GHz to the 10th harmonic of highest fundamental frequency.

Report No.: T191218D03-RP3

Test Mode	IEEE 802.11g Low CH	Temp/Hum	21.3(°C)/ 51%RH
Test Item	Harmonic	Test Date	January 13, 2020
Polarize	Horizontal	Test Engineer	Jerry Chang
Detector	Peak and Average		

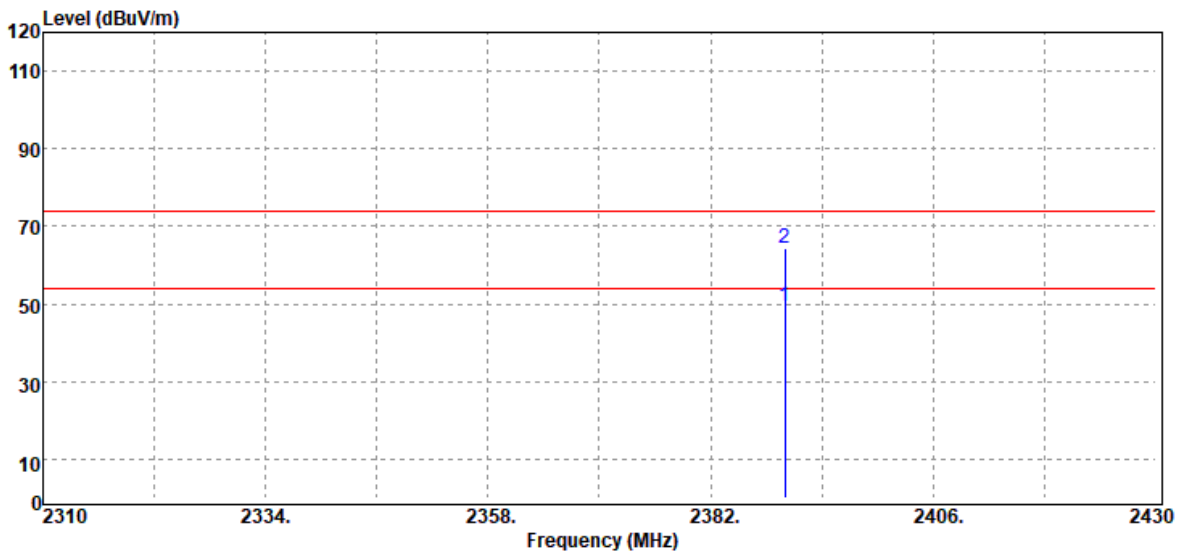

Frequency (MHz)	Reading (dBuV)	Correct Factor (dB/m)	Result (BuV/m)	Limit (dBuV/m)	Margin (dB)	Remark
2390.00	52.12	-2.82	49.30	54.00	-4.70	Average
2390.00	67.20	-2.82	64.38	74.00	-9.62	Peak

Remark:

1. Measuring frequencies from 1 GHz to the 10th harmonic of highest fundamental frequency.

Report No.: T191218D03-RP3

Test Mode	IEEE 802.11g High CH	Temp/Hum	21.3(°C)/ 51%RH
Test Item	Harmonic	Test Date	January 13, 2020
Polarize	Vertical	Test Engineer	Jerry Chang
Detector	Peak and Average		

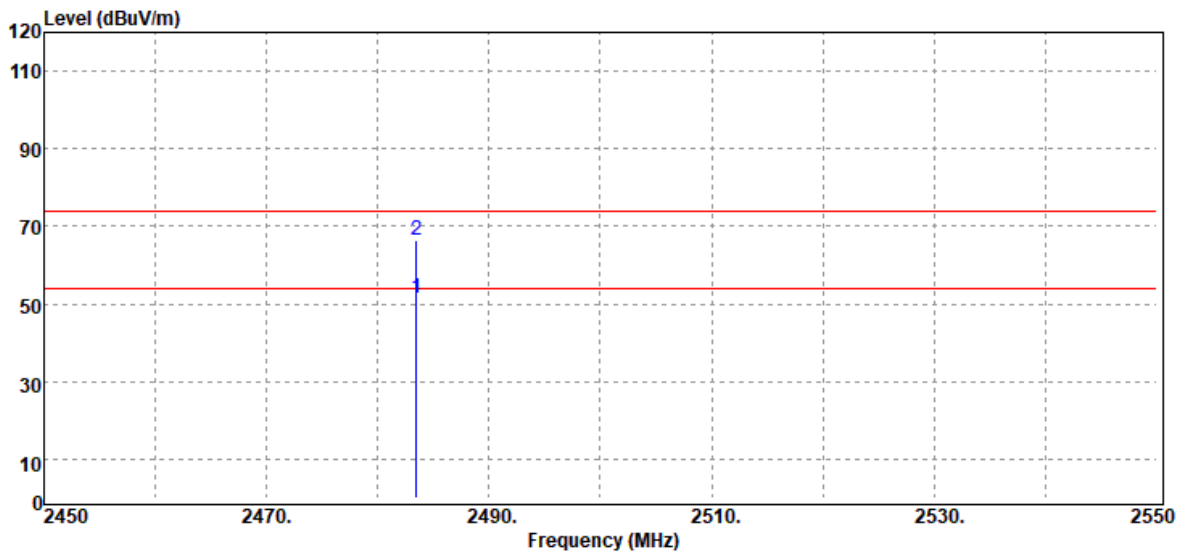

Frequency (MHz)	Reading (dBuV)	Correct Factor (dB/m)	Result (dBuV/m)	Limit (dBuV/m)	Margin (dB)	Remark
2483.50	53.69	-2.30	51.39	54.00	-2.61	Average
2483.50	68.89	-2.30	66.59	74.00	-7.41	Peak

Remark:

1. Measuring frequencies from 1 GHz to the 10th harmonic of highest fundamental frequency.

Report No.: T191218D03-RP3

Test Mode	IEEE 802.11g High CH	Temp/Hum	21.3(°C)/ 51%RH
Test Item	Harmonic	Test Date	January 13, 2020
Polarize	Horizontal	Test Engineer	Jerry Chang
Detector	Peak and Average		

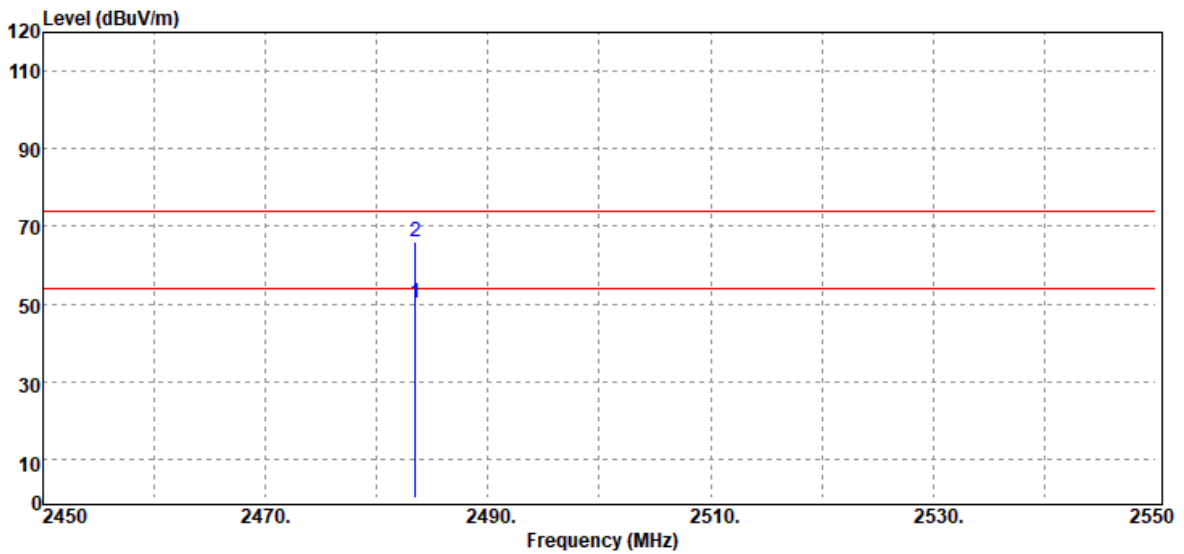

Frequency (MHz)	Reading (dBuV)	Correct Factor (dB/m)	Result (dBuV/m)	Limit (dBuV/m)	Margin (dB)	Remark
2483.50	52.37	-2.30	50.07	54.00	-3.93	Average
2483.50	68.34	-2.30	66.04	74.00	-7.96	Peak

Remark:

1. Measuring frequencies from 1 GHz to the 10th harmonic of highest fundamental frequency.

Report No.: T191218D03-RP3

Test Mode	IEEE 802.11n HT20 Low CH	Temp/Hum	21.3(°C)/ 51%RH
Test Item	Harmonic	Test Date	January 13, 2020
Polarize	Vertical	Test Engineer	Jerry Chang
Detector	Peak and Average		

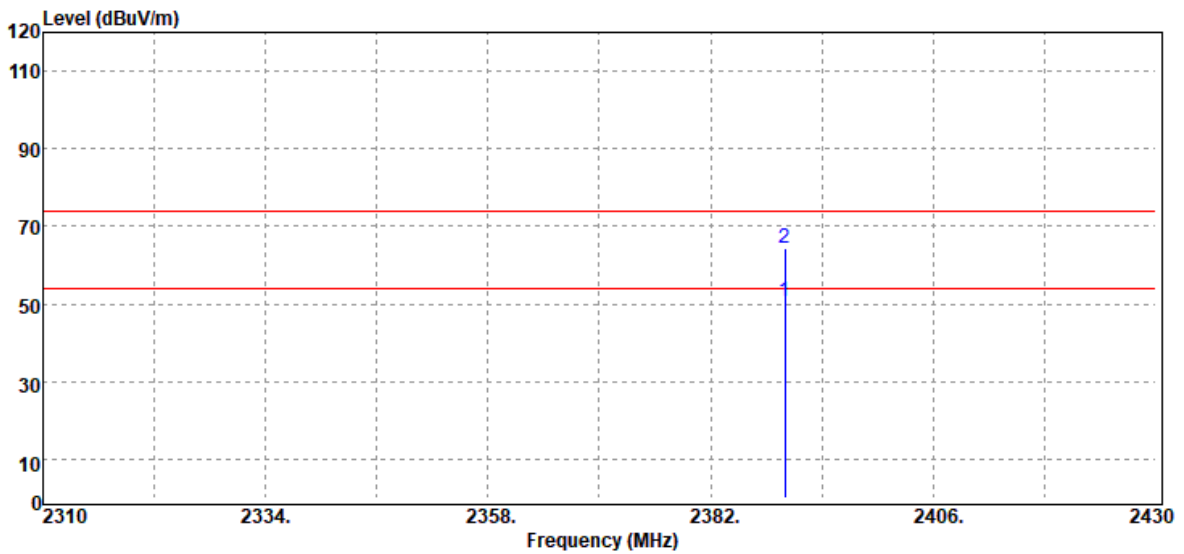

Frequency (MHz)	Reading (dBuV)	Correct Factor (dB/m)	Result (dBuV/m)	Limit (dBuV/m)	Margin (dB)	Remark
2390.00	53.61	-2.82	50.79	54.00	-3.21	Average
2390.00	67.37	-2.82	64.55	74.00	-9.45	Peak

Remark:

1. Measuring frequencies from 1 GHz to the 10th harmonic of highest fundamental frequency.

Report No.: T191218D03-RP3

Test Mode	IEEE 802.11n HT20 Low CH	Temp/Hum	21.3(°C)/ 51%RH
Test Item	Harmonic	Test Date	January 13, 2020
Polarize	Horizontal	Test Engineer	Jerry Chang
Detector	Peak and Average		

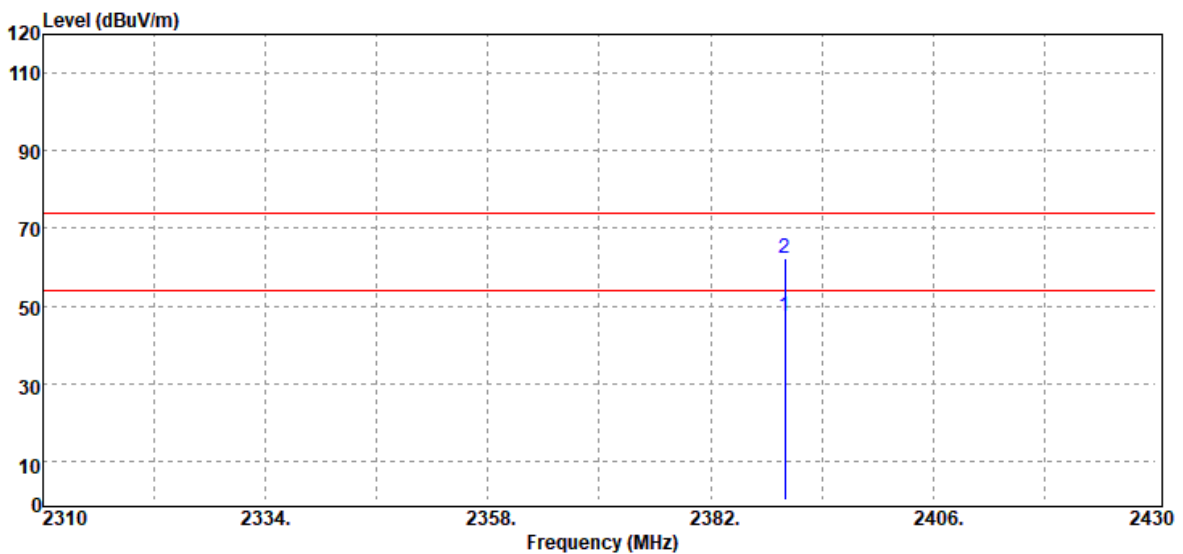

Frequency (MHz)	Reading (dBuV)	Correct Factor (dB/m)	Result (dBuV/m)	Limit (dBuV/m)	Margin (dB)	Remark
2390.00	49.95	-2.82	47.13	54.00	-6.87	Average
2390.00	65.23	-2.82	62.41	74.00	-11.59	Peak

Remark:

1. Measuring frequencies from 1 GHz to the 10th harmonic of highest fundamental frequency.

Report No.: T191218D03-RP3

Test Mode	IEEE 802.11n HT20 High CH	Temp/Hum	21.3(°C)/ 51%RH
Test Item	Harmonic	Test Date	January 13, 2020
Polarize	Vertical	Test Engineer	Jerry Chang
Detector	Peak and Average		

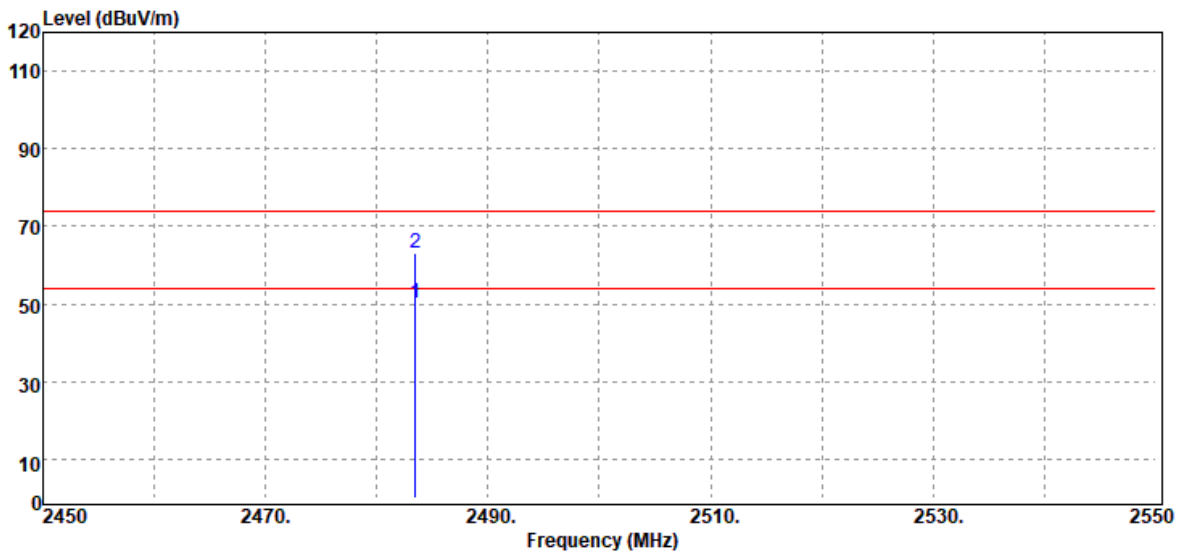

Frequency (MHz)	Reading (dBuV)	Correct Factor (dB/m)	Result (dBuV/m)	Limit (dBuV/m)	Margin (dB)	Remark
2483.50	52.54	-2.30	50.24	54.00	-3.76	Average
2483.50	65.26	-2.30	62.96	74.00	-11.04	Peak

Remark:

1. Measuring frequencies from 1 GHz to the 10th harmonic of highest fundamental frequency.

Report No.: T191218D03-RP3

Test Mode	IEEE 802.11n HT20 High CH	Temp/Hum	21.3(°C)/ 51%RH
Test Item	Harmonic	Test Date	January 13, 2020
Polarize	Horizontal	Test Engineer	Jerry Chang
Detector	Peak and Average		

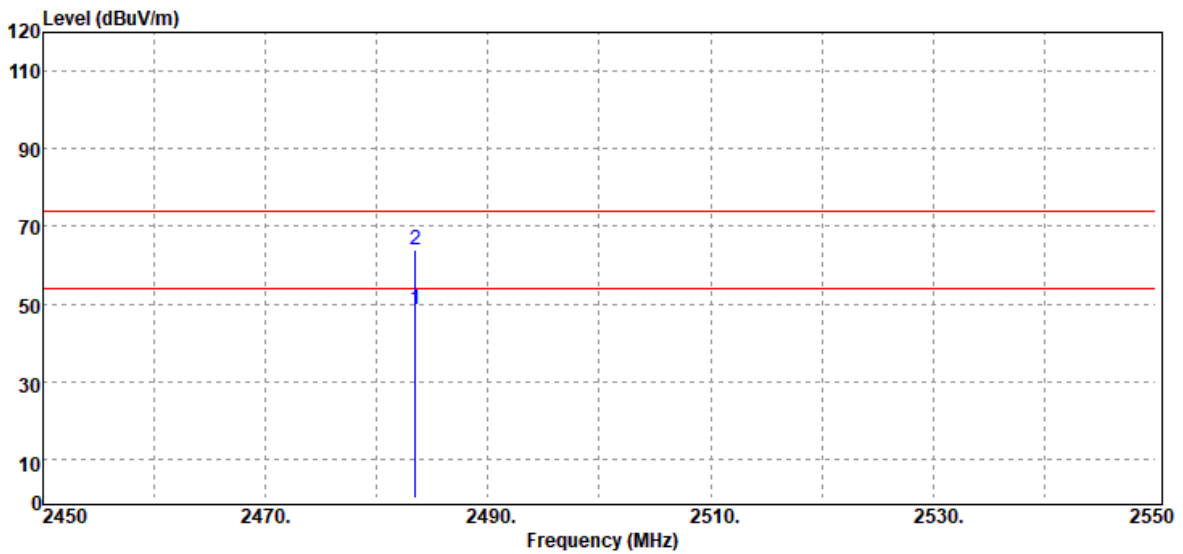

Frequency (MHz)	Reading (dBuV)	Correct Factor (dB/m)	Result (dBuV/m)	Limit (dBuV/m)	Margin (dB)	Remark
2483.50	51.00	-2.30	48.70	54.00	-5.30	Average
2483.50	66.06	-2.30	63.76	74.00	-10.24	Peak

Remark:

1. Measuring frequencies from 1 GHz to the 10th harmonic of highest fundamental frequency.

Report No.: T191218D03-RP3

Test Mode	IEEE 802.11n HT40 Low CH	Temp/Hum	21.3(°C)/ 51%RH
Test Item	Harmonic	Test Date	January 13, 2020
Polarize	Vertical	Test Engineer	Jerry Chang
Detector	Peak and Average		

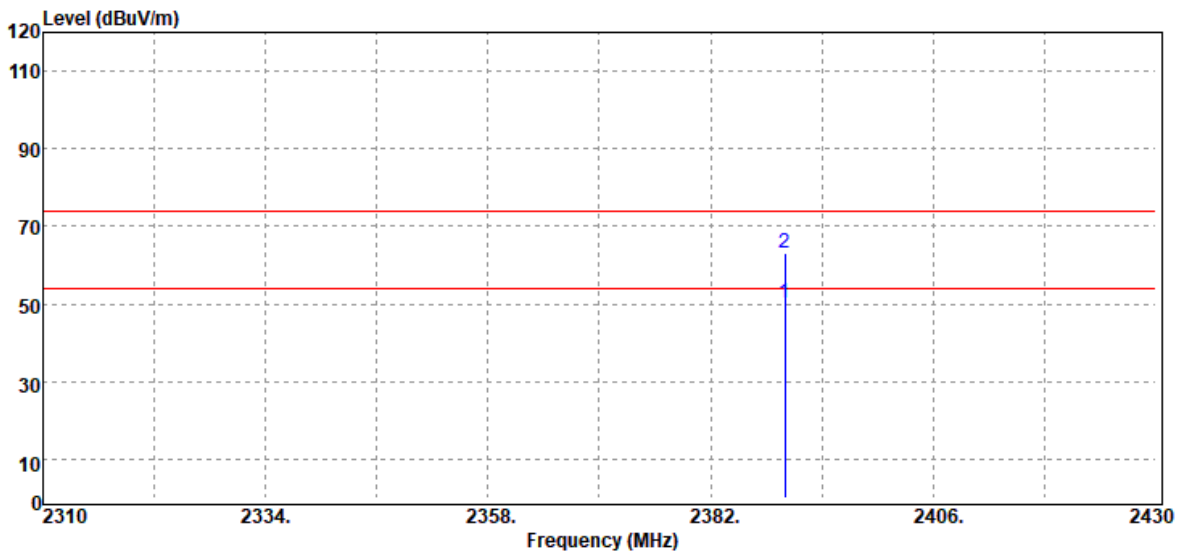

Frequency (MHz)	Reading (dBuV)	Correct Factor (dB/m)	Result (dBuV/m)	Limit (dBuV/m)	Margin (dB)	Remark
2390.00	53.17	-2.82	50.35	54.00	-3.65	Average
2390.00	65.86	-2.82	63.04	74.00	-10.96	Peak

Remark:

1. Measuring frequencies from 1 GHz to the 10th harmonic of highest fundamental frequency.

Report No.: T191218D03-RP3

Test Mode	IEEE 802.11n HT40 Low CH	Temp/Hum	21.3(°C)/ 51%RH
Test Item	Harmonic	Test Date	January 13, 2020
Polarize	Horizontal	Test Engineer	Jerry Chang
Detector	Peak and Average		

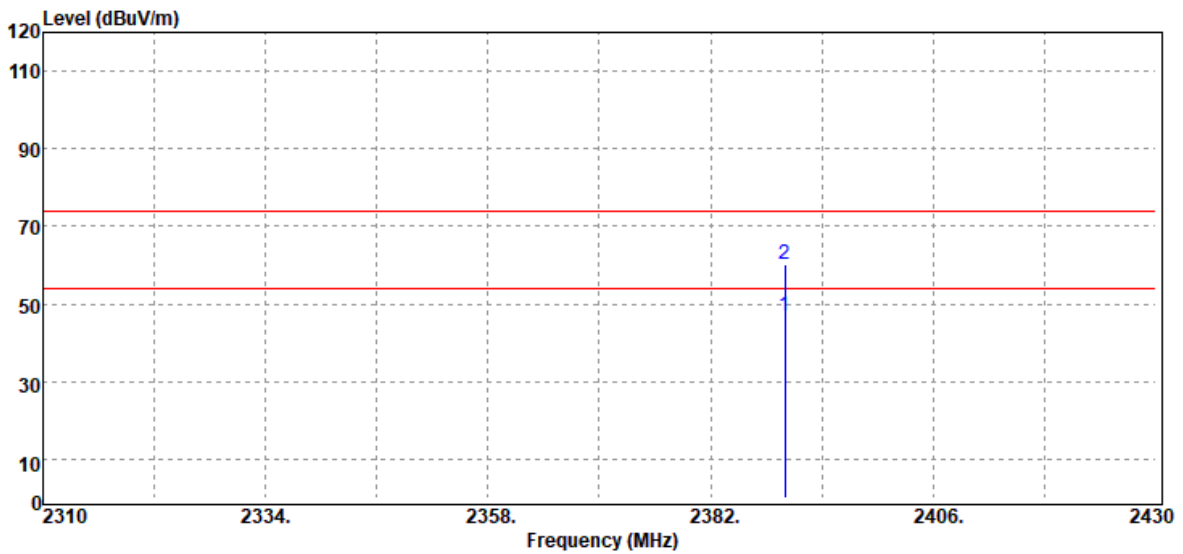

Frequency (MHz)	Reading (dBuV)	Correct Factor (dB/m)	Result (dBuV/m)	Limit (dBuV/m)	Margin (dB)	Remark
2390.00	49.68	-2.82	46.86	54.00	-7.14	Average
2390.00	63.16	-2.82	60.34	74.00	-13.66	Peak

Remark:

1. Measuring frequencies from 1 GHz to the 10th harmonic of highest fundamental frequency.

Report No.: T191218D03-RP3

Test Mode	IEEE 802.11n HT40 High CH	Temp/Hum	21.3(°C)/ 51%RH
Test Item	Harmonic	Test Date	January 13, 2020
Polarize	Vertical	Test Engineer	Jerry Chang
Detector	Peak and Average		

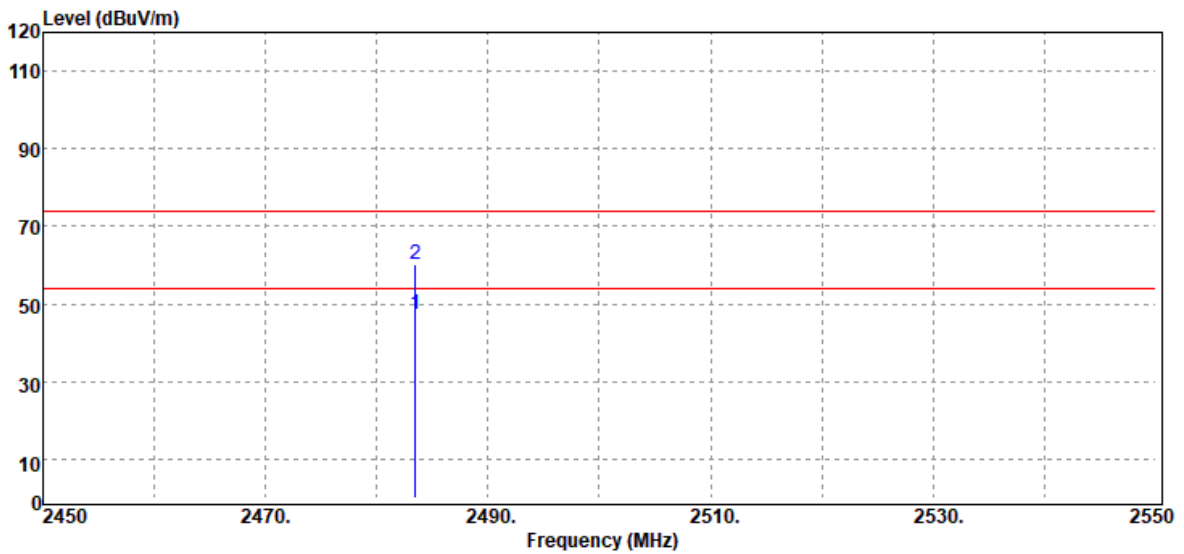

Frequency (MHz)	Reading (dBuV)	Correct Factor (dB/m)	Result (dBuV/m)	Limit (dBuV/m)	Margin (dB)	Remark
2483.50	49.79	-2.30	47.49	54.00	-6.51	Average
2483.50	62.39	-2.30	60.09	74.00	-13.91	Peak

Remark:

1. Measuring frequencies from 1 GHz to the 10th harmonic of highest fundamental frequency.

Report No.: T191218D03-RP3

Test Mode	IEEE 802.11n HT40 High CH	Temp/Hum	21.3(°C)/ 51%RH
Test Item	Harmonic	Test Date	January 13, 2020
Polarize	Horizontal	Test Engineer	Jerry Chang
Detector	Peak and Average		

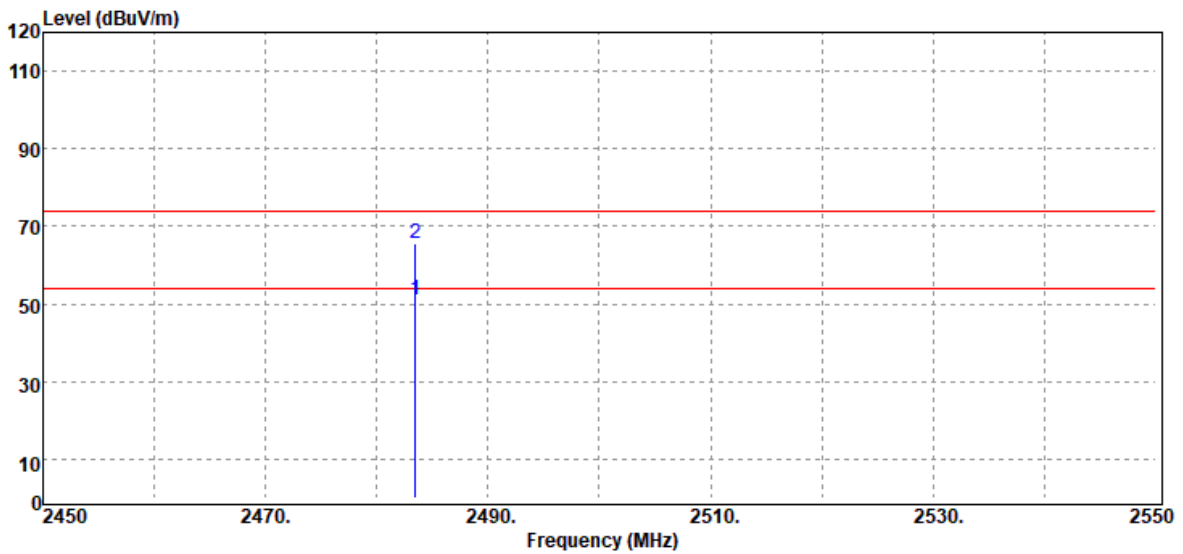

Frequency (MHz)	Reading (dBuV)	Correct Factor (dB/m)	Result (dBuV/m)	Limit (dBuV/m)	Margin (dB)	Remark
2483.50	53.55	-2.30	51.25	54.00	-2.75	Average
2483.50	67.73	-2.30	65.43	74.00	-8.57	Peak

Remark:

1. Measuring frequencies from 1 GHz to the 10th harmonic of highest fundamental frequency.

--End of Test Report--

APPENDIX-A Test Photo

Radiation (Below 1GHz)

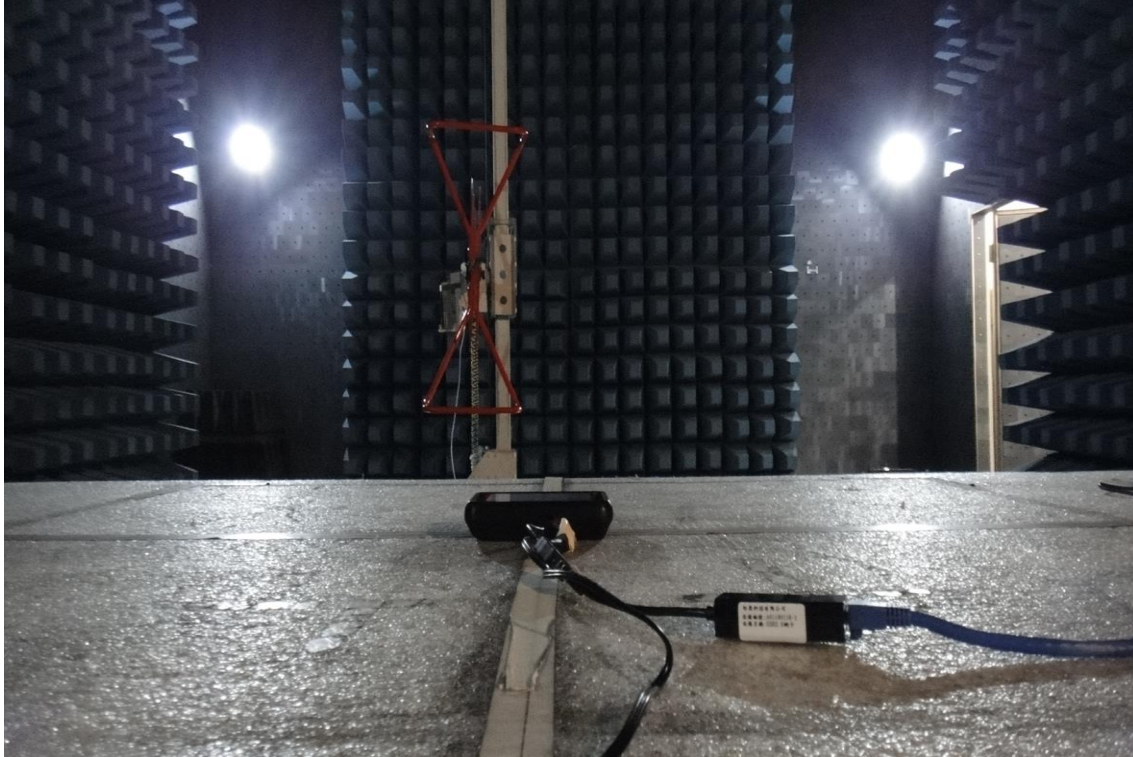

Radiation (Above 1GHz)

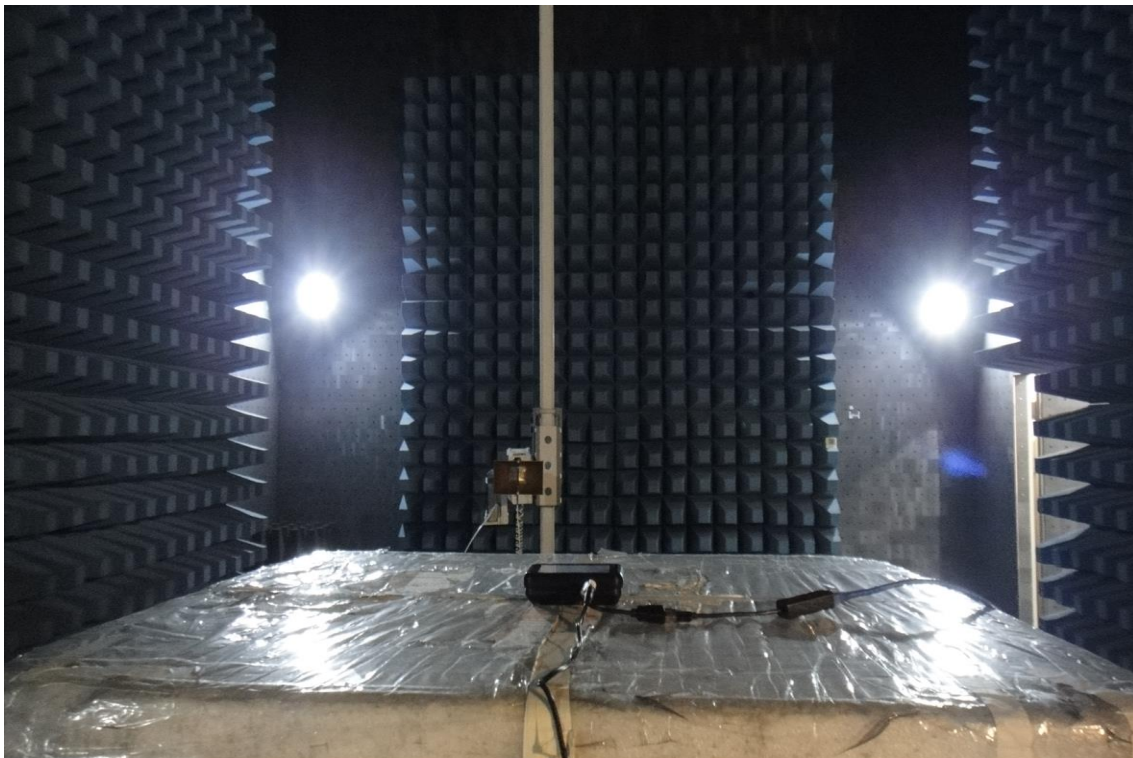

Conducted Emission Set Up Photo

