

ANTENNA SPECIFICATION

Customer Signature:

Date:

PRODUCTOR : HengXinDa

PRODUCT CODE: E053

CUSTOMER CODE:

WRITER: 曾庆雄

CALIBRATION: 曾庆雄

RATIFICATIN: 张强

DATE: 2024.12.17

深圳恒信达通信科技有限公司

SHENZHEN HENGXINDA COMMUNICATION TECH CO., LTD.

Wechat:hxd(Lawrence)/15813853812

306, 3rd Floor, Brilliant Complex Building, Dalang Sanhe Huaqiao New Village, Bao 'an District, Shenzhen, Guangdong Province

ANTENNA SPECIFICATION

Antena code	E053
Test mode	Matching map

BLUE TOOTH ANTENNA

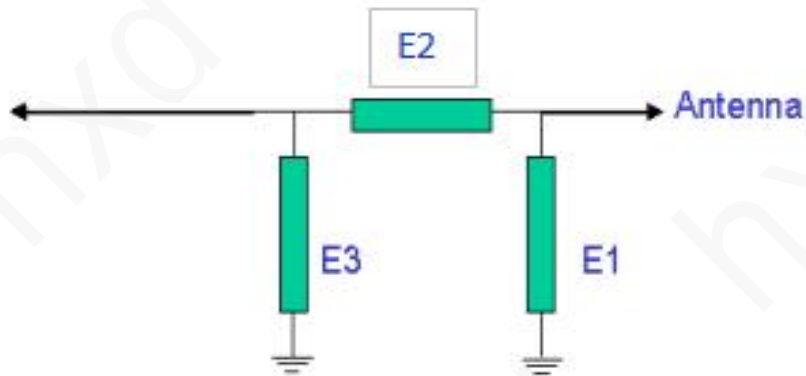

E1	NC	2PF
E2	OR	OR
E3	2PF	NC
	L	R

ANTENNA SPECIFICATION

Antena frequency range **2400~2500MHz**

Test mode **S11 RETURN-LOSS**

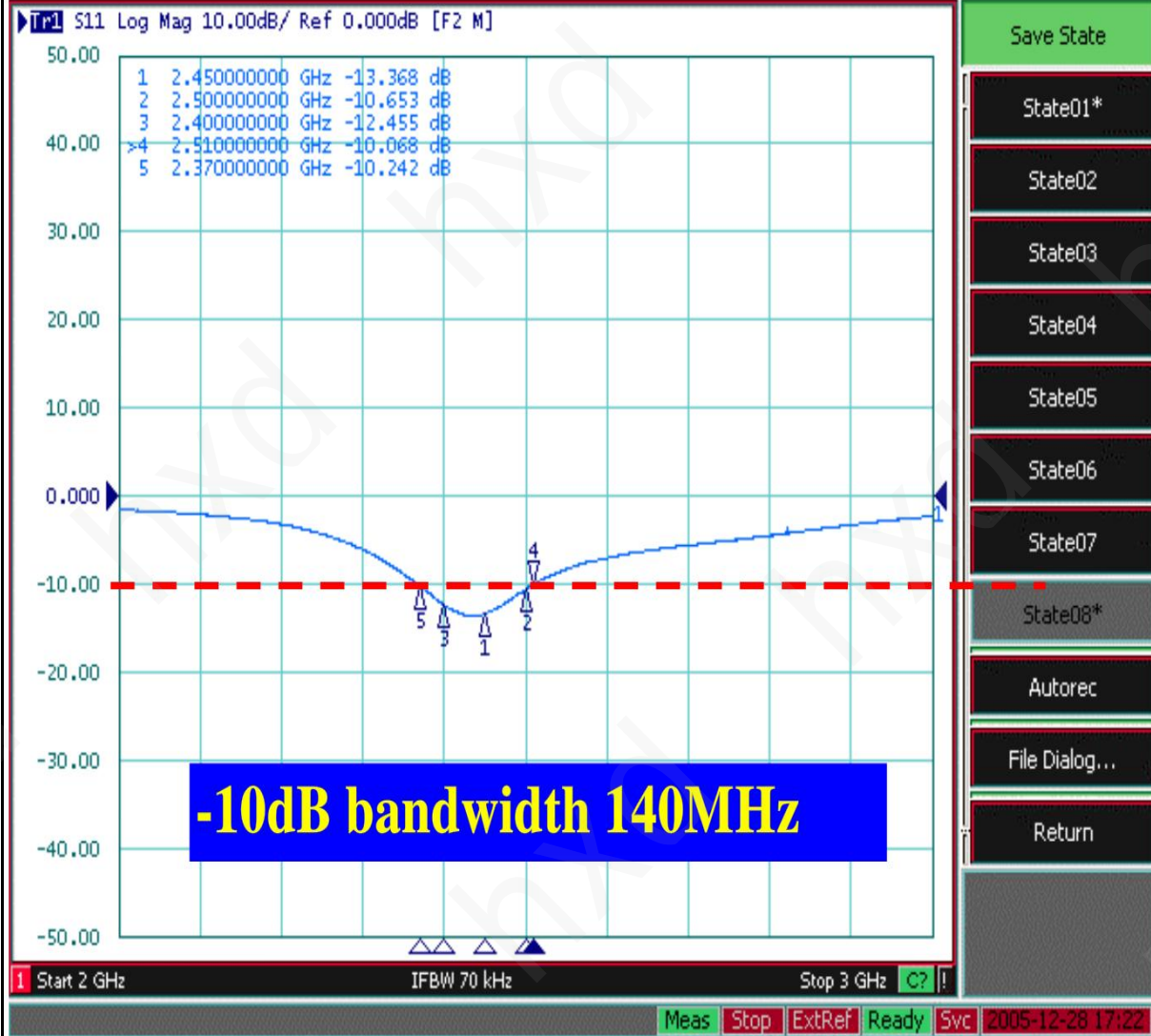

RETURN LOSS

ANTENNA SPECIFICATION

Frequency range **2400~2500MHz**

Test type **RADAR MAP**

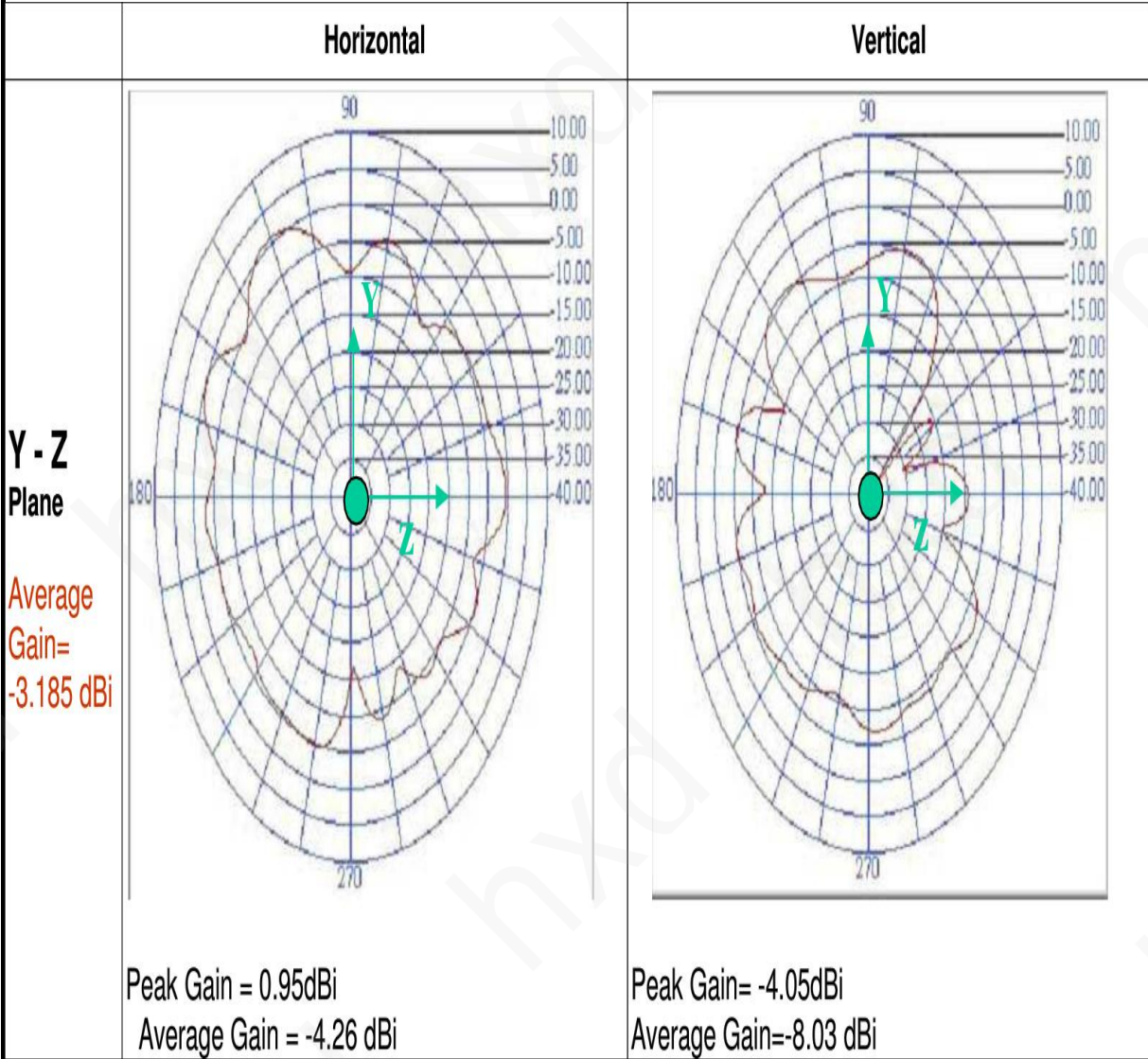

Y-Z PLANE

ANTENNA SPECIFICATION

Frequency range **2400~2500MHz**

Test type **RADAR MAP**

**X - Y
Plane**

Average
Gain=
-1.543 dBi

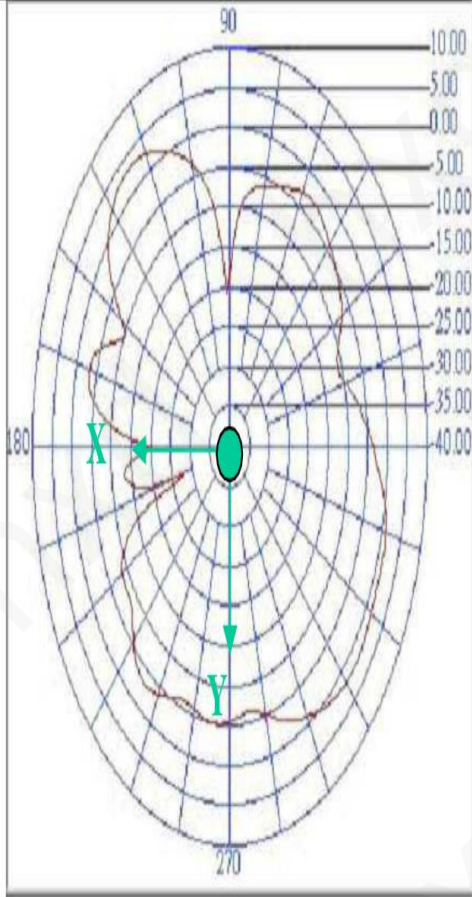

Peak Gain= 3.19 dBi
Average Gain= -2.65 dBi

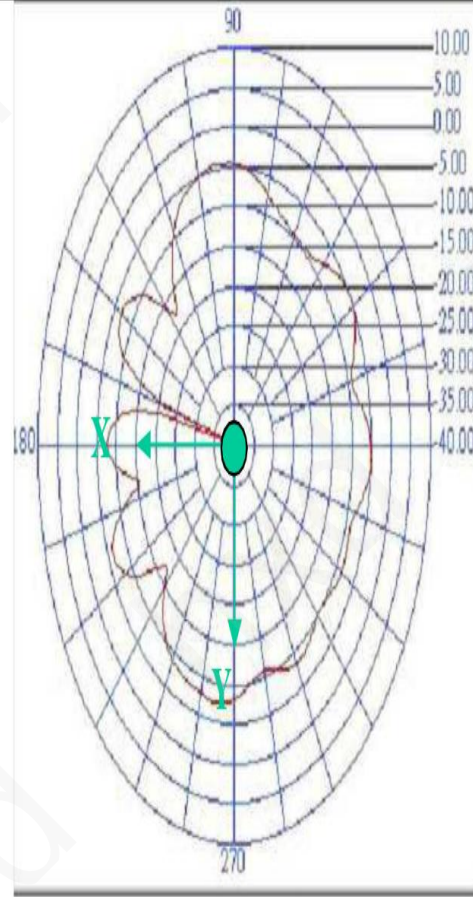

Peak Gain= -4.48 dBi
Average Gain= -8.02 dBi

X-Y PLANE

ANTENNA SPECIFICATION

Frequency range | 2400~2500MHz

Test type | RADAR MAP

**X - Z
Plane**

Average
Gain=
-0.99 dBi

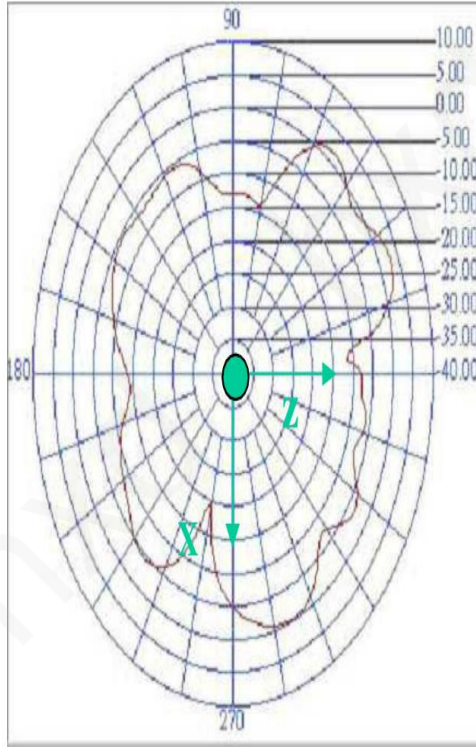

Peak Gain= 3.05 dBi
Average Gain= -4.10dBi

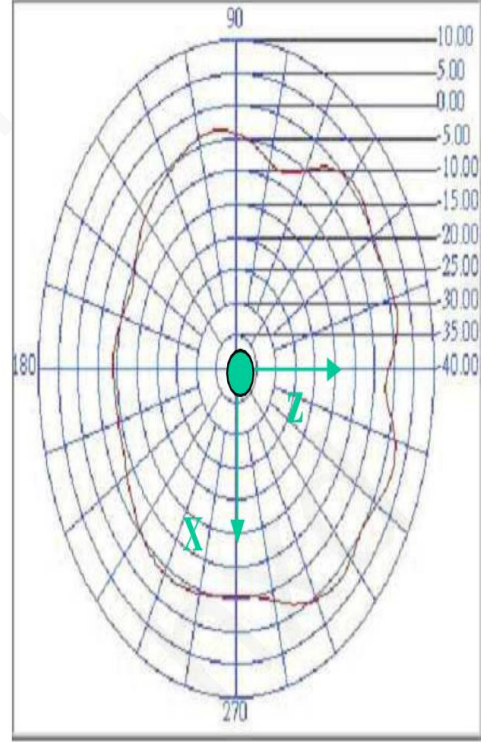

Peak Gain= 2.49 dBi
Average Gain= -2.47 dBi

X-Z PLANE

ANTENNA SPECIFICATION

Frequency range	2400~2500MHz
Type of material	

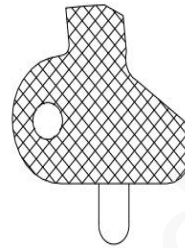
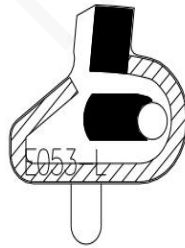

注:

- 1: 表面沉黄金 2μ
- 1: 布铜区域
- 2: 基材区域
- 2: 附胶区域

型号: E053-L 表面过黑油, 丝印亮白色字码

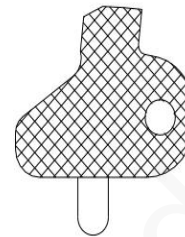
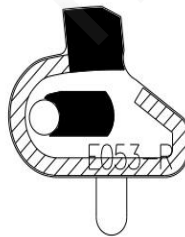

注:

- 1: 表面沉黄金 2μ
- 1: 布铜区域
- 2: 基材区域
- 2: 附胶区域

型号: E053-R 表面过黑油, 丝印亮白色字码