



Test Report No.: W7L-P24050005RF04



# VARIANT FCC TEST REPORT (PART 22)

Applicant:	Shenzhen Zolon Technology Co., Ltd.
Address:	401, Building 3, Shenzhen Software Park, Maling Community, Yuehai Sub-district, Nanshan District, Shenzhen, China

Manufacturer or Supplier:	Shenzhen Zolon Technology Co., Ltd.
Address:	401, Building 3, Shenzhen Software Park, Maling Community, Yuehai Sub-district, Nanshan District, Shenzhen, China
Product:	Pay Tablet
Brand Name:	ZOLON
Model Name:	M8
FCC ID:	2AV5BM8
Date of tests:	Sep. 19, 2021 ~ Oct. 30, 2021

The tests have been carried out according to the requirements of the following standard:

- FCC PART 22, Subpart H       FCC Part 2
- ANSI/TIA/EIA-603-D       ANSI C63.26-2015
- ANSI/TIA/EIA-603-E

CONCLUSION: The submitted sample was found to COMPLY with the test requirement

Prepared by Simon Wang Engineer / Mobile Department	Approved by Luke Lu Manager / Mobile Department
Date: May. 29, 2024	Date: May. 29, 2024

This report is governed by, and incorporates by reference, the Conditions of Testing as posted at the date of issuance of this report at <http://www.bureauveritas.com/home/about-us/our-business/cps/about-us/terms-conditions/> and is intended for your exclusive use. Any copying or replication of this report to or for any other person or entity, or use of our name or trademark, is permitted only with our prior written permission. This report sets forth our findings solely with respect to the test samples identified herein. The results set forth in this report are not indicative or representative of the quality or characteristics of the lot from which a test sample was taken or any similar or identical product unless specifically and expressly noted. Our report includes all of the tests requested by you and the results thereof based upon the information that you provided to us. Measurement uncertainty is only provided upon request for accredited tests. Statements of conformity are based on simple acceptance criteria without taking measurement uncertainty into account, unless otherwise requested in writing. You have 60 days from date of issuance of this report to notify us of any material error or omission caused by our negligence or if you require measurement uncertainty; provided, however, that such notice shall be in writing and shall specifically address the issue you wish to raise. A failure to raise such issue within the prescribed time shall constitute your unqualified acceptance of the completeness of this report, the tests conducted and the correctness of the report contents.



# TABLE OF CONTENTS

**RELEASE CONTROL RECORD .....4**

**1 SUMMARY OF TEST RESULTS.....5**

\* REFER TO KDB 971168 D01 POWER MEAS LICENSE DIGITAL SYSTEMS V03R01.....5

1.1 MEASUREMENT UNCERTAINTY .....5

1.2 TEST SITE AND INSTRUMENTS .....6

**2 GENERAL INFORMATION .....7**

2.1 GENERAL DESCRIPTION OF EUT .....7

2.2 CONFIGURATION OF SYSTEM UNDER TEST .....9

2.3 DESCRIPTION OF SUPPORT UNITS .....10

2.4 TEST ITEM AND TEST CONFIGURATION.....10

2.5 EUT OPERATING CONDITIONS.....13

2.6 GENERAL DESCRIPTION OF APPLIED STANDARDS .....14

**3 TEST TYPES AND RESULTS.....15**

3.1 OUTPUT POWER MEASUREMENT .....15

3.1.1 LIMITS OF OUTPUT POWER MEASUREMENT .....15

3.1.2 TEST PROCEDURES .....15

3.1.3 TEST SETUP .....16

3.1.4 TEST RESULTS .....16

3.2 FREQUENCY STABILITY MEASUREMENT .....21

3.2.1 LIMITS OF FREQUENCY STABILITY MEASUREMENT .....21

3.2.2 TEST PROCEDURE .....21

3.2.3 TEST SETUP .....21

3.2.4 TEST RESULTS .....22

3.3 OCCUPIED BANDWIDTH MEASUREMENT .....23

3.3.1 TEST PROCEDURES .....23

3.3.2 TEST SETUP .....23

3.3.3 TEST RESULTS .....24

3.4 BAND EDGE MEASUREMENT .....25

3.4.1 LIMITS OF BAND EDGE MEASUREMENT .....25

3.4.2 TEST SETUP .....25

3.4.3 TEST PROCEDURES .....26

3.4.4 TEST RESULTS .....27

3.5 CONDUCTED SPURIOUS EMISSIONS.....28

3.5.1 LIMITS OF CONDUCTED SPURIOUS EMISSIONS MEASUREMENT .....28

3.5.2 TEST PROCEDURE .....28

3.5.3 TEST SETUP .....28

3.5.4 TEST RESULTS .....29

3.6 RADIATED EMISSION MEASUREMENT .....30

3.6.1 LIMITS OF RADIATED EMISSION MEASUREMENT .....30

3.6.2 TEST PROCEDURES .....30



**BUREAU  
VERITAS**

**Test Report No.: W7L-P24050005RF04**

3.6.3	DEVIATION FROM TEST STANDARD .....	30
3.6.4	TEST SETUP .....	31
3.6.5	TEST RESULTS .....	32
3.7	PEAK TO AVERAGE RATIO .....	52
3.7.1	LIMITS OF PEAK TO AVERAGE RATIO MEASUREMENT .....	52
3.7.2	TEST SETUP .....	52
3.7.3	TEST PROCEDURES .....	52
3.7.4	TEST RESULTS .....	53
<b>4</b>	<b>PHOTOGRAPHS OF THE TEST CONFIGURATION .....</b>	<b>54</b>
<b>5</b>	<b>INFORMATION ON THE TESTING LABORATORIES .....</b>	<b>55</b>
<b>6</b>	<b>APPENDIX A 1 – MODIFICATIONS RECORDERS FOR ENGINEERING CHANGES TO THE EUT BY THE LAB .....</b>	<b>56</b>



**BUREAU**  
**VERITAS**

Test Report No.: W7L-P24050005RF04

## RELEASE CONTROL RECORD

ISSUE NO.	REASON FOR CHANGE	DATE ISSUED
W7L-P21090022RF04	Original release	Nov. 01, 2021
W7L-P24050005RF04	Based on the original report changing the applicant information and manufacturer information, brand name, FCC ID.	May. 29, 2024

## 1 SUMMARY OF TEST RESULTS

The EUT has been tested according to the following specifications:

APPLIED STANDARD: FCC Part 22 & Part 2		
STANDARD SECTION	TEST TYPE	RESULT
2.1046 22.913 (a)	Effective Radiated Power	Compliance
2.1055 22.355	Frequency Stability	Compliance
2.1049 22.917 (b)	Occupied Bandwidth	Compliance
22.913 (d)	Peak to average ratio*	Compliance
22.917	Band Edge Measurements	Compliance
2.1051 22.917	Conducted Spurious Emissions	Compliance
2.1053 22.917	Radiated Spurious Emissions	Compliance

\* Refer to KDB 971168 D01 Power Meas License Digital Systems v03r01.

### 1.1 MEASUREMENT UNCERTAINTY

Where relevant, the following measurement uncertainty levels have been estimated for tests performed on the EUT as specified in CISPR 16-4-2:

MEASUREMENT	UNCERTAINTY
Maximum Peak Output Power	±2.06dB
Frequency Stability	± 76.97Hz
Radiated emissions (30MHz~1GMHz)	±4.98dB
Radiated emissions (1GMHz ~6GMHz)	±4.70dB
Radiated emissions (6GMHz ~18GMHz)	±4.60dB
Radiated emissions (18GMHz ~40GMHz)	±4.12dB
Conducted emissions	±4.01dB
Occupied Channel Bandwidth	±43.58KHz
Band Edge Measurements	±4.70dB
Peak to average ratio	±0.76dB

This uncertainty represents an expanded uncertainty expressed at approximately the 95% confidence level using a coverage factor of k=2.



## 1.2 TEST SITE AND INSTRUMENTS

Equipment	Manufacturer	Model No.	Serial No.	Last Cal.	Next Cal.
MXE EMI Receiver	KEYSIGHT	N9038A-544	MY54450026	Apr. 22,21	Apr. 21,22
EXA Signal Analyzer	KEYSIGHT	N9010A-544	MY54510355	Jun. 03,21	Jun. 02,22
Bilog Antenna	ETS-LINDGREN	3143B	00161965	Mar. 05,21	Mar. 04,22
Horn Antenna	ETS-LINDGREN	3117	00168728	Apr. 02,21	Apr. 01,22
Horn Antenna (18GHz-40GHz)	N/A	QWH-SL-18-40-K-SG/QMS-00361	15433	Aug. 25, 21	Aug. 24, 22
Radio Communication Analyzer	ANRITSU	MT8820C	6201465426	Feb. 25,21	Feb. 24,22
Signal Pre-Amplifier	EMSI	EMC 9135	980249	Jun. 02,21	Jun. 01,22
Signal Pre-Amplifier	EMSI	EMC 012645B	980257	Jun. 03,21	Jun. 02,22
Signal Pre-Amplifier	EMSI	EMC 184045B	980259	Apr. 22,21	Apr. 21,22
3m Semi-anechoic Chamber	ETS-LINDGREN	9m*6m*6m	Euroshieldpn-CT0001143-1216	May. 19,20	May. 18,23
Test Software	E3	V 9.160323	N/A	N/A	N/A
Test Software	ADT	ADT_Radiated_V 7.6.15.9.2	N/A	N/A	N/A
10dB Attenuator	JFW/USA	50HF-010-SMA	1505	Jun. 03,21	Jun. 02,22
Power Meter	Anritsu	ML2495A	1506002	Apr. 07,21	Apr. 06,22
Power Sensor	Anritsu	MA2411B	1339352	May. 07,21	May. 06,22
Temperature Chamber	ESPEC	SH-242	93000855	Jun. 02,21	Jun. 01,22
MXG Analog Microwave Signal Generator	KEYSIGHT	N5183A	MY50143024	Mar. 05,21	Mar. 04,22
Power Divider	MCLI/USA	PS2-15	24880	N/A	N/A

- NOTE:**
1. The calibration interval of the above test instruments is 12 months or 36 months and the calibrations are traceable to CEPREI/CHINA, GRGT/CHINA and NIM/CHINA.
  2. The test was performed in 3m Semi-anechoic Chamber and RF Oven Room.
  3. The horn antenna is used only for the measurement of emission frequency above 1GHz if tested.
  4. The FCC Site Registration No. is 525120; The Designation No. is CN1171.



## 2 GENERAL INFORMATION

### 2.1 GENERAL DESCRIPTION OF EUT

<b>PRODUCT</b>	Pay Tablet	
<b>BRAND NAME</b>	ZOLON	
<b>MODEL NAME</b>	M8	
<b>NOMINAL VOLTAGE</b>	5Vdc /9Vdc /12Vdc (adapter) 3.85Vdc (Rechargeable Li-ion, battery)	
<b>MODULATION TYPE</b>	<b>WCDMA</b>	BPSK,QPSK
	<b>LTE</b>	QPSK, 16QAM
<b>FREQUENCY RANGE</b>	<b>WCDMA</b>	826.4MHz ~ 846.6MHz
	<b>LTE Band 5 (Channel Bandwidth: 1.4MHz)</b>	824.7MHz ~ 848.3MHz
	<b>LTE Band 5 (Channel Bandwidth: 3MHz)</b>	825.5MHz ~ 847.5MHz
	<b>LTE Band 5 (Channel Bandwidth: 5MHz)</b>	826.5MHz ~ 846.5MHz
	<b>LTE Band 5 (Channel Bandwidth: 10MHz)</b>	829MHz ~ 844MHz
<b>MAX. ERP POWER</b>	<b>WCDMA</b>	103.28mW
	<b>LTE Band 5 (Channel Bandwidth: 1.4MHz)</b>	101.16mW
	<b>LTE Band 5 (Channel Bandwidth: 3MHz)</b>	100.93mW
	<b>LTE Band 5 (Channel Bandwidth: 5MHz)</b>	101.39mW
	<b>LTE Band 5 (Channel Bandwidth: 10MHz)</b>	101.86mW
<b>EMISSION DESIGNATOR GOGN</b>	<b>WCDMA</b>	4M21F9W
	<b>LTE Band 5 (Channel Bandwidth: 1.4MHz)</b>	QPSK: 1M11G7D
		16QAM: 1M11W7D
	<b>LTE Band 5 (Channel Bandwidth: 3MHz)</b>	QPSK: 2M73G7D
		16QAM: 2M73W7D
	<b>LTE Band 5 (Channel Bandwidth: 5MHz)</b>	QPSK: 4M54G7D
16QAM: 4M55W7D		
<b>LTE Band 5 (Channel Bandwidth: 10MHz)</b>	QPSK: 9M08G7D	
	16QAM: 9M09W7D	
<b>ANTENNA TYPE</b>	Fixed Internal Antenna with 0.5dBi gain for WCDMA5/LTE band 5	
<b>HW VERSION</b>	M8-XXX-XXX-XXXX	



<b>SW VERSION</b>	V0.0.0.1
<b>I/O PORTS</b>	Refer to user's manual
<b>CABLE SUPPLIED</b>	USB cable: unshielded without ferrite, 1 meter
<b>EXTREME TEMPERATURE</b>	-10-45 °C
<b>EXTREME VOLTAGE</b>	3.7V- 4.25V

**NOTE:**

1. For a more detailed features description, please refer to the manufacturer's specifications or the user's manual.
2. For the test results, the EUT had been tested with all conditions. But only the worst case was shown in test report.

**List of Accessory:**

<b>ACCESSORIES</b>	<b>BRAND</b>	<b>MODEL</b>	<b>SPECIFICATION</b>
Battery	IES	ICS021NA	Capacity : 3.85vdc 6300mAh
AC Adapter	/	GLH-PD18W-U	I/P:100-240Vac, 0.5A O/P: 5Vdc, 3A/9Vdc, 2A/12Vdc, 1.5A
USB Cable	/	HJ-20010506CC444	Shielded, 1meter





## 2.2 CONFIGURATION OF SYSTEM UNDER TEST FOR RADIATION EMISSION

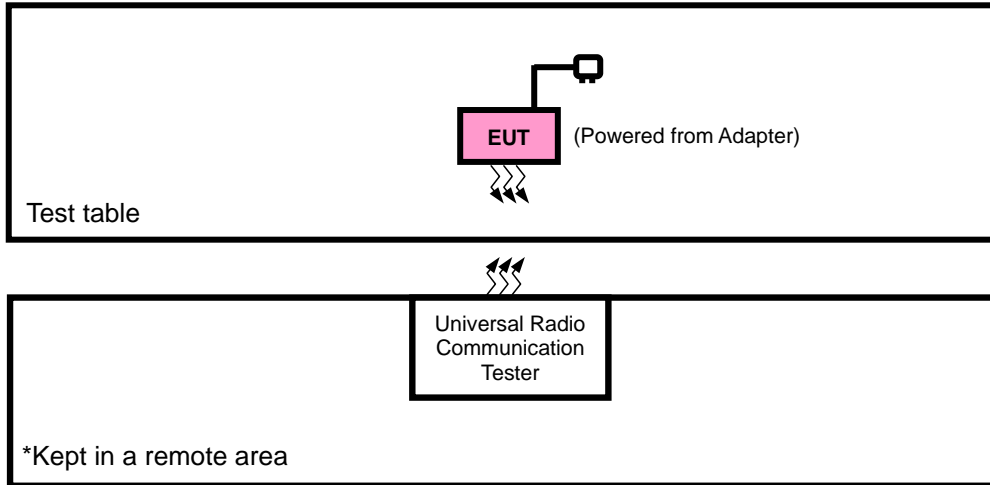



### 2.3 DESCRIPTION OF SUPPORT UNITS

The EUT has been tested as an independent unit together with other necessary accessories or support units. The following support units or accessories were used to form a representative test configuration during the tests.

NO.	PRODUCT	BRAND	MODEL NO.	SERIAL NO.	FCC ID
1	DC source	Kikusui/JP	PMX18-5A	0000001	N/A

NO.	SIGNAL CABLE DESCRIPTION OF THE ABOVE SUPPORT UNITS
1	DC Line: Unshielded, Detachable 1.0m

### 2.4 TEST ITEM AND TEST CONFIGURATION

Pre-Scan has been conducted to determine the worst-case mode from all possible combinations between available modulations, data rates, XYZ axis and antenna ports. The worst case in ERP and radiated emission was found when positioned on X-plane for GSM /EDGE /LTE. Following channel(s) was (were) selected for the final test as listed below:

EUT CONFIGURE MODE	DESCRIPTION
A	EUT + DC Source with WCDMA or LTE link



**BUREAU  
VERITAS**

**Test Report No.: W7L-P24050005RF04**

**WCDMA MODE**

EUT CONFIGURE MODE	TEST ITEM	AVAILABLE CHANNEL	TESTED CHANNEL	MODE
B	ERP	4132 to 4233	4132, 4182, 4233	WCDMA
B	FREQUENCY STABILITY	4132 to 4233	4132, 4233	WCDMA
B	OCCUPIED BANDWIDTH	4132 to 4233	4132, 4182, 4233	WCDMA
B	BAND EDGE	4132 to 4233	4132, 4182, 4233	WCDMA
B	CONDCUDED EMISSION	4132 to 4233	4132, 4233	WCDMA
A	RADIATED EMISSION	4132 to 4233	4132, 4182, 4233	WCDMA
B	PEAK TO AVERAGE RATIO	4132 to 4233	4132, 4182, 4233	WCDMA



**BUREAU  
VERITAS**

**Test Report No.: W7L-P24050005RF04**

**LTE BAND 5 MODE**

TEST ITEM	Available Channel	Tested Channel	Channel bandwidth	modulation	mode
ERP	20407 to 20643	20407, 20525, 20643	1.4MHz	QPSK,16QAM	1 RB / 0 RB Offset
	20415 to 20635	20415, 20525, 20635	3MHz	QPSK,16QAM	1 RB / 0 RB Offset
	20425 to 20625	20425, 20525, 20625	5MHz	QPSK,16QAM	1 RB / 0 RB Offset
	20450 to 20600	20450, 20525, 20600	10MHz	QPSK,16QAM	1 RB / 0 RB Offset
FREQUENCY STABILITY	20407 to 20643	20407, 20643	1.4MHz	QPSK	1 RB / 0 RB Offset
	20415 to 20635	20415, 20635	3MHz	QPSK	1 RB / 0 RB Offset
	20425 to 20625	20425, 20625	5MHz	QPSK	1 RB / 0 RB Offset
	20450 to 20600	20450, 20600	10MHz	QPSK	1 RB / 0 RB Offset
OCCUPIED BANDWIDTH	20407 to 20643	20407, 20525, 20643	1.4MHz	QPSK,16QAM	6 RB / 0 RB Offset
	20415 to 20635	20415, 20525, 20635	3MHz	QPSK,16QAM	15 RB / 0 RB Offset
	20425 to 20625	20425, 20525, 20625	5MHz	QPSK,16QAM	25 RB / 0 RB Offset
	20450 to 20600	20450, 20525, 20600	10MHz	QPSK,16QAM	50 RB / 0 RB Offset
BAND EDGE	20407 to 20643	20407	1.4 MHz	QPSK,16QAM	1 RB / 0 RB Offset
					6 RB / 0 RB Offset
	20407 to 20643	20643	1.4 MHz	QPSK,16QAM	1 RB / 5 RB Offset
					6 RB / 0 RB Offset
	20415 to 20635	20415	3 MHz	QPSK,16QAM	1 RB / 0 RB Offset
					15 RB / 0 RB Offset
	20415 to 20635	20635	3 MHz	QPSK,16QAM	1 RB / 14 RB Offset
					15 RB / 0 RB Offset
	20425 to 20625	20425	5MHz	QPSK,16QAM	1 RB / 0 RB Offset
					25 RB / 0 RB Offset
	20425 to 20625	20625	5MHz	QPSK,16QAM	1 RB / 24 RB Offset
					25 RB / 0 RB Offset
20450 to 20600	20450	10MHz	QPSK,16QAM	1 RB / 0 RB Offset	
				50 RB / 0 RB Offset	
20450 to 20600	20600	10MHz	QPSK,16QAM	1 RB / 49 RB Offset	
				50 RB / 0 RB Offset	



CONDCUDED EMISSION	20407 to 20643	20407, 20525, 20643	1.4MHz	QPSK	1 RB / 0 RB Offset
	20415 to 20635	20415, 20525, 20635	3MHz	QPSK	1 RB / 0 RB Offset
	20425 to 20625	20425, 20525, 20625	5MHz	QPSK	1 RB / 0 RB Offset
	20450 to 20600	20450, 20525, 20600	10MHz	QPSK	1 RB / 0 RB Offset
RADIATED EMISSION	20407 to 20643	20525	1.4MHz	QPSK	1 RB / 0 RB Offset
	20415 to 20635	20525	3MHz	QPSK	1 RB / 0 RB Offset
	20425 to 20625	20525	5MHz	QPSK	1 RB / 0 RB Offset
	20450 to 20600	20450, 20525, 20600	10MHz	QPSK	1 RB / 0 RB Offset
PEAK TO AVERAGE RATIO	20407 to 20643	20407, 20525, 20643	1.4MHz	QPSK,16QAM	1 RB / 0 RB Offset
	20415 to 20635	20415, 20525, 20635	3MHz	QPSK,16QAM	1 RB / 0 RB Offset
	20425 to 20625	20425, 20525, 20625	5MHz	QPSK,16QAM	1 RB / 0 RB Offset
	20450 to 20600	20450, 20525, 20600	10MHz	QPSK,16QAM	1 RB / 0 RB Offset

**Note:** This device was tested under all bandwidths, RB configurations and modulations. The worst case was found in QPSK modulation.

**TEST CONDITION:**

TEST ITEM	ENVIRONMENTAL CONDITIONS	INPUT POWER	TESTED BY
ERP	23deg. C, 70%RH	DC 3.85V	Jace Hu
FREQUENCY STABILITY	23deg. C, 70%RH	DC 3.85V	James Fu
OCCUPIED BANDWIDTH	23deg. C, 70%RH	DC 3.85V	James Fu
BAND EDGE	23deg. C, 70%RH	DC 3.85V	James Fu
CONDCUDED EMISSION	23deg. C, 70%RH	DC 3.85V	James Fu
RADIATED EMISSION	23deg. C, 70%RH	DC 3.85V	Jace Hu
PEAK TO AVERAGE RATIO	23deg. C, 70%RH	DC 3.85V	James Fu

**2.5 EUT OPERATING CONDITIONS**

The EUT makes a call to the communication simulator. The communication simulator station system controlled a EUT to export maximum output power under transmission mode and specific channel frequency



Test Report No.: W7L-P24050005RF04

## 2.6 GENERAL DESCRIPTION OF APPLIED STANDARDS

The EUT is a RF product. According to the specifications of the manufacturer, it must comply with the requirements of the following standards:

**FCC 47 CFR Part 2**

**FCC 47 CFR Part 22**

**KDB 971168 D01 Power Meas License Digital Systems v03r01**

**ANSI/TIA/EIA-603-D**

**ANSI/TIA/EIA-603-E**

**ANSI C63.26-2015**

**NOTE:** All test items have been performed and recorded as per the above standards.



### 3 TEST TYPES AND RESULTS

#### 3.1 OUTPUT POWER MEASUREMENT

##### 3.1.1 LIMITS OF OUTPUT POWER MEASUREMENT

Mobile / Portable station are limited to 7 watts e.r.p.

##### 3.1.2 TEST PROCEDURES

###### **EIRP / ERP MEASUREMENT:**

Per KDB 971168 D01 Power Meas License Digital Systems v03r01 or subclause 5.2.5.5 of ANSI C63.26-2015, the relevant equation for determining the ERP or EIRP from the conducted RF output power measured using the guidance provided above is:

$$\text{ERP or EIRP} = P_{\text{Meas}} + G_{\text{T}} - L_{\text{C}}$$

Where:

ERP or EIRP = effective radiated power or equivalent isotropically radiated power, respectively

(expressed in the same units as  $P_{\text{Meas}}$ , typically dBW or dBm);

$P_{\text{Meas}}$  = measured transmitter output power or PSD, in dBm or dBW;

$G_{\text{T}}$  = gain of the transmitting antenna, in dBd (ERP) or dBi (EIRP);

$L_{\text{C}}$  = signal attenuation in the connecting cable between the transmitter and antenna, in dB.

###### **CONDUCTED POWER MEASUREMENT:**

The EUT was set up for the maximum power with WCDMA link data modulation and link up with simulator. Set the EUT to transmit under low, middle and high channel and record the power level shown on simulator.



### 3.1.3 TEST SETUP

EIRP / ERP Measurement:

CONDUCTED POWER MEASUREMENT:

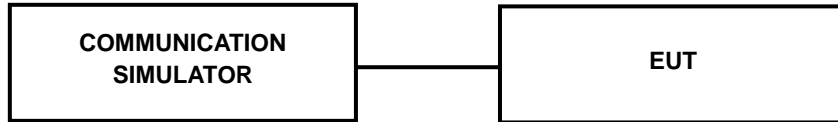

### 3.1.4 TEST RESULTS

#### CONDUCTED OUTPUT POWER (dBm)

Band	WCDMA V			Max. Tune-up Power
	4132	4182	4233	
Channel	826.4	836.4	846.6	
Frequency	826.4	836.4	846.6	
RMC 12.2K	21.67	21.70	<b>21.79</b>	22.5
HSDPA Subtest-1	20.60	20.61	20.66	21.5
HSDPA Subtest-2	20..58	20.59	20.62	21.5
HSDPA Subtest-3	20.09	20.02	20.13	21.0
HSDPA Subtest-4	20.12	20.13	20.16	21.0
HSUPA Subtest-1	20.69	20.68	20.70	21.5
HSUPA Subtest-2	18.66	18.67	18.73	19.5
HSUPA Subtest-3	19.71	19.75	19.77	20.5
HSUPA Subtest-4	18.68	18.66	18.71	19.5
HSUPA Subtest-5	20.64	20.67	20.68	21.5





**BUREAU  
VERITAS**

**Test Report No.: W7L-P24050005RF04**

**LTE Band 5**

Band/BW	Modulation	RB Size	RB Offset	Low CH 20407	Mid CH 20525	High CH 20643	MPR
				Frequency 824.7 MHz	Frequency 836.5 MHz	Frequency 848.3 MHz	
5/ 1.4	QPSK	1	0	21.53	21.56	21.54	0
		1	2	21.70	21.62	21.69	0
		1	5	21.62	21.55	21.61	0
		3	0	21.63	21.61	21.64	0
		3	1	21.63	21.70	21.57	0
		3	3	21.60	21.57	21.60	0
	16QAM	6	0	20.64	20.64	20.62	1
		1	0	20.81	20.82	20.84	1
		1	2	20.92	20.93	20.93	1
		1	5	20.85	20.77	20.87	1
		3	0	20.65	20.67	20.62	1
		3	1	20.64	20.76	20.65	1
		3	3	20.58	20.60	20.64	1
		6	0	19.64	19.68	19.64	2

Band/BW	Modulation	RB Size	RB Offset	Low CH 20415	Mid CH 20525	High CH 20635	MPR
				Frequency 825.5 MHz	Frequency 836.5 MHz	Frequency 847.5 MHz	
5/ 3	QPSK	1	0	21.55	21.58	21.53	0
		1	7	21.66	21.63	21.69	0
		1	14	21.58	21.55	21.61	0
		8	0	20.62	20.64	20.64	1
		8	3	20.56	20.70	20.59	1
		8	7	20.57	20.64	20.64	1
		15	0	20.61	20.65	20.56	1
	16QAM	1	0	20.78	20.88	20.87	1
		1	7	20.89	20.96	20.91	1
		1	14	20.88	20.77	20.87	1
		8	0	19.61	19.68	19.62	2
		8	3	19.69	19.71	19.68	2
		8	7	19.60	19.58	19.60	2
		15	0	19.64	19.62	19.67	2



Band/BW	Modulation	RB Size	RB Offset	Low CH 20425	Mid CH 20525	High CH 20625	MPR
				Frequency 826.5 MHz	Frequency 836.5 MHz	Frequency 846.5 MHz	
5/ 5	QPSK	1	0	21.56	21.53	21.54	0
		1	12	21.71	21.60	21.69	0
		1	24	21.59	21.54	21.65	0
		12	0	20.65	20.64	20.61	1
		12	6	20.56	20.71	20.60	1
		12	13	20.61	20.60	20.65	1
		25	0	20.59	20.68	20.59	1
	16QAM	1	0	20.79	20.84	20.87	1
		1	12	20.86	20.99	20.90	1
		1	24	20.88	20.77	20.86	1
		12	0	19.61	19.66	19.59	2
		12	6	19.66	19.75	19.64	2
		12	13	19.55	19.60	19.63	2
		25	0	19.64	19.63	19.64	2

Band/BW	Modulation	RB Size	RB Offset	Low CH 20450	Mid CH 20525	High CH 20600	MPR
				Frequency 829 MHz	Frequency 836.5 MHz	Frequency 844 MHz	
5/ 10	QPSK	1	0	21.61	21.60	21.59	0
		1	24	21.73	21.68	21.71	0
		1	49	21.64	21.62	21.66	0
		25	0	20.69	20.68	20.66	1
		25	12	20.72	20.64	20.65	1
		25	25	20.65	20.65	20.66	1
		50	0	20.70	20.60	20.64	1
	16QAM	1	0	20.86	20.89	20.89	1
		1	24	20.94	21.01	20.95	1
		1	49	20.90	20.85	20.88	1
		25	0	19.69	19.72	19.67	2
		25	12	19.72	19.77	19.70	2
		25	25	19.62	19.65	19.65	2
		50	0	19.70	19.70	19.69	2



ERP POWER (dBm)

WCDMA

Channel	Frequency (MHz)	Conducted Power (dBm)	G <sub>T</sub> -L <sub>C</sub> (dB)	ERP (dBm)	ERP (mW)	Limit (W)
4132	826.4	21.67	0.5	20.02	100.46	7
4182	836.4	21.7	0.5	20.05	101.16	7
4233	846.6	21.79	0.5	20.14	103.28	7

REMARKS: ERP Output Power (dBm) = EIRP (dBm) -2.15(dB).

LTE BAND 5

CHANNEL BANDWIDTH: 1.4MHz QPSK

Channel	Frequency (MHz)	Conducted Power (dBm)	G <sub>T</sub> -L <sub>C</sub> (dB)	ERP (dBm)	ERP (mW)	Limit (W)
20407	824.7	21.7	0.5	20.05	101.16	7
20525	836.5	21.7	0.5	20.05	101.16	7
20643	848.3	21.69	0.5	20.04	100.93	7

CHANNEL BANDWIDTH: 1.4MHz 16QAM

Channel	Frequency (MHz)	Conducted Power (dBm)	G <sub>T</sub> -L <sub>C</sub> (dB)	ERP (dBm)	ERP (mW)	Limit (W)
20407	824.7	20.92	0.5	19.27	84.53	7
20525	836.5	20.93	0.5	19.28	84.72	7
20643	848.3	20.93	0.5	19.28	84.72	7

CHANNEL BANDWIDTH: 3MHz QPSK

Channel	Frequency (MHz)	Conducted Power (dBm)	G <sub>T</sub> -L <sub>C</sub> (dB)	ERP (dBm)	ERP (mW)	Limit (W)
20415	825.5	21.66	0.5	20.01	100.23	7
20525	836.5	21.63	0.5	19.98	99.54	7
20635	847.5	21.69	0.5	20.04	100.93	7

CHANNEL BANDWIDTH: 3MHz 16QAM

Channel	Frequency (MHz)	Conducted Power (dBm)	G <sub>T</sub> -L <sub>C</sub> (dB)	ERP (dBm)	ERP (mW)	Limit (W)
20415	825.5	20.89	0.5	19.24	83.95	7
20525	836.5	20.96	0.5	19.31	85.31	7
20635	847.5	20.91	0.5	19.26	84.33	7



**CHANNEL BANDWIDTH: 5MHz QPSK**

Channel	Frequency (MHz)	Conducted Power (dBm)	G <sub>T</sub> -L <sub>C</sub> (dB)	ERP (dBm)	ERP (mW)	Limit (W)
20425	826.5	21.71	0.5	20.06	101.39	7
20525	836.5	21.6	0.5	19.95	98.86	7
20625	846.5	21.69	0.5	20.04	100.93	7

**CHANNEL BANDWIDTH: 5MHz 16QAM**

Channel	Frequency (MHz)	Conducted Power (dBm)	G <sub>T</sub> -L <sub>C</sub> (dB)	ERP (dBm)	ERP (mW)	Limit (W)
20425	826.5	20.88	0.5	19.23	83.75	7
20525	836.5	20.99	0.5	19.34	85.9	7
20625	846.5	20.9	0.5	19.25	84.14	7

**CHANNEL BANDWIDTH: 10MHz QPSK**

Channel	Frequency (MHz)	Conducted Power (dBm)	G <sub>T</sub> -L <sub>C</sub> (dB)	ERP (dBm)	ERP (mW)	Limit (W)
20450	829.0	21.73	0.5	20.08	101.86	7
20525	836.5	21.68	0.5	20.03	100.69	7
20600	844.0	21.71	0.5	20.06	101.39	7

**CHANNEL BANDWIDTH: 10MHz 16QAM**

Channel	Frequency (MHz)	Conducted Power (dBm)	G <sub>T</sub> -L <sub>C</sub> (dB)	ERP (dBm)	ERP (mW)	Limit (W)
20450	829.0	20.94	0.5	19.29	84.92	7
20525	836.5	21.01	0.5	19.36	86.3	7
20600	844.0	20.95	0.5	19.30	85.11	7

**REMARKS:** ERP Output Power (dBm) = EIRP (dBm) -2.15(dB).

### 3.2 FREQUENCY STABILITY MEASUREMENT

#### 3.2.1 LIMITS OF FREQUENCY STABILITY MEASUREMENT

1.5 ppm is for base and fixed station. 2.5 ppm is for mobile station.

#### 3.2.2 TEST PROCEDURE

- a. Device is placed at the oven room. The oven room could control the temperatures and humidity. Power warm up is at least 15 min and power applied should perform before recording frequency error.
- b. EUT is connected the external power supply to control the DC input power. The test voltage range is from minimum to maximum working voltage. Each step shall be record the frequency error rate.
- c. The temperature range step is 10 degrees in this test items. All temperature levels shall be hold the  $\pm 0.5^{\circ}\text{C}$  during the measurement testing. The each temperature step shall be at least 0.5 hours, consider the EUT could be test under the stability condition.

**NOTE:** The frequency error was recorded frequency error from the communication simulator.

#### 3.2.3 TEST SETUP

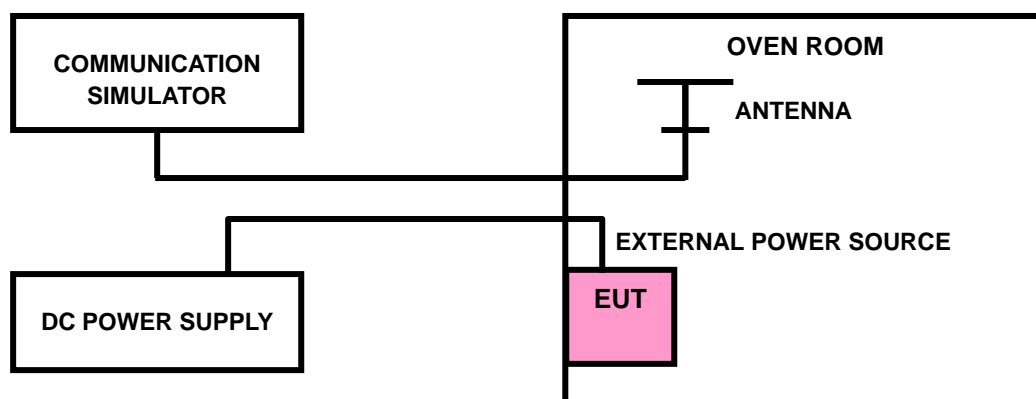



**BUREAU  
VERITAS**

**Test Report No.: W7L-P24050005RF04**

### 3.2.4 TEST RESULTS

#### WCDMA Band V

Please Refer to Appendix A 1 Of this test report.

#### LTE Band 5

Please Refer to Appendix A 1 Of this test report.

### 3.3 OCCUPIED BANDWIDTH MEASUREMENT

#### 3.3.1 TEST PROCEDURES

The EUT makes a call to the communication simulator. All measurements were done at low, middle and high operational frequency range. The communication simulator station system controlled a EUT to export maximum output power under transmission mode and specific channel frequency. Use OBW measurement function of Spectrum analyzer to measure 99 % occupied bandwidth.

#### 3.3.2 TEST SETUP

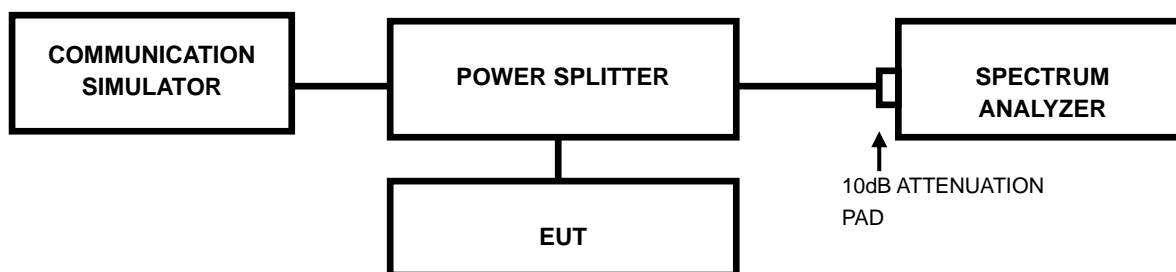



**BUREAU  
VERITAS**

**Test Report No.: W7L-P24050005RF04**

### 3.3.3 TEST RESULTS

#### **WCDMA Band V**

Please Refer to Appendix A 1 Of this test report.

#### **LTE BAND 5**

Please Refer to Appendix A 1 Of this test report.



### 3.4 BAND EDGE MEASUREMENT

#### 3.4.1 LIMITS OF BAND EDGE MEASUREMENT

Power of any emission outside of the authorized operating frequency ranges must be attenuated below the transmitting power (P) by a factor of at least  $43 + 10 \log(P)$  dB. In the 1 MHz bands immediately outside and adjacent to the frequency block a resolution bandwidth of at least one percent of the emission bandwidth of the fundamental emission of the transmitter may be employed.

#### 3.4.2 TEST SETUP

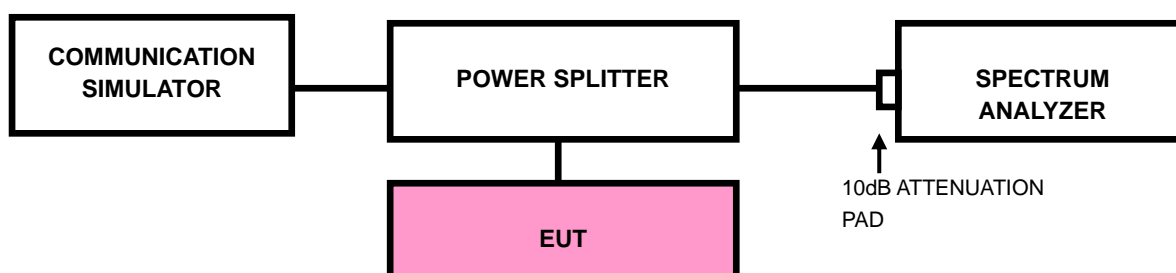



### 3.4.3 TEST PROCEDURES

- a. All measurements were done at low and high operational frequency range.
- b. The center frequency of spectrum is the band edge frequency and span is 10MHz. RBW of the spectrum is 100kHz and VBW of the spectrum is 300kHz (WCDMA).
- c. The center frequency of spectrum is the band edge frequency and span is 1~5 MHz. RBW of the spectrum is 20kHz and VBW of the spectrum is 100 kHz. (LTE bandwidth 1.4MHz).
- d. The center frequency of spectrum is the band edge frequency and span is 1~5 MHz. RBW of the spectrum is 30kHz and VBW of the spectrum is 100kHz. (LTE bandwidth 3MHz)
- e. The center frequency of spectrum is the band edge frequency and span is 1~5 MHz. RBW of the spectrum is 50kHz and VBW of the spectrum is 200kHz. (LTE bandwidth 5MHz)
- f. The center frequency of spectrum is the band edge frequency and span is 1~5 MHz. RBW of the spectrum is 100kHz and VBW of the spectrum is 300kHz. (LTE bandwidth 10MHz)
- g. Record the max trace plot into the test report.



**BUREAU  
VERITAS**

**Test Report No.: W7L-P24050005RF04**

### 3.4.4 TEST RESULTS

#### **WCDMA Band V**

Please Refer to Appendix A 1 Of this test report.

#### **LTE BAND 5**

Please Refer to Appendix A 1. Of this test report.

### 3.5 CONDUCTED SPURIOUS EMISSIONS

#### 3.5.1 LIMITS OF CONDUCTED SPURIOUS EMISSIONS MEASUREMENT

The power of any emission outside of the authorized operating frequency ranges must be attenuated below the transmitting power (P) by a factor of at least  $43 + 10 \log(P)$  dB. The emission limit equal to  $-13\text{dBm}$ .

#### 3.5.2 TEST PROCEDURE

- a. The EUT makes a phone call to the communication simulator. All measurements were done at low, middle and high operational frequency range.
- b. Measuring frequency range is from 9 kHz to 9GHz. 10dB attenuation pad is connected with spectrum. RBW=1MHz and VBW=3MHz is used for conducted emission measurement.

#### 3.5.3 TEST SETUP

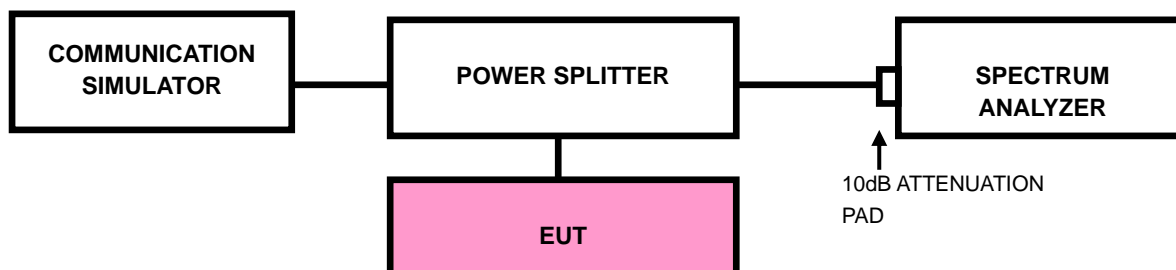



**BUREAU  
VERITAS**

**Test Report No.: W7L-P24050005RF04**

### 3.5.4 TEST RESULTS

#### **WCDMA Band V**

Please Refer to Appendix A 1 Of this test report.

#### **LTE BAND 5**

Please Refer to Appendix A 1. Of this test report.



### 3.6 RADIATED EMISSION MEASUREMENT

#### 3.6.1 LIMITS OF RADIATED EMISSION MEASUREMENT

The power of any emission outside of the authorized operating frequency ranges must be attenuated below the transmitting power (P) by a factor of at least  $43 + 10 \log(P)$  dB. The emission limit equal to  $-13\text{dBm}$ .

#### 3.6.2 TEST PROCEDURES

- a. Substitution method is used for E.I.R.P measurement. In the semi-anechoic chamber, EUT placed on the 0.8m height of Turn Table, rotated the table around 360 degrees to search the maximum radiation power and receiver antenna shall be rotated vertical and horizontal polarization and moved height from 1m to 4m to find the maximum polar radiated power. The “Read Value” is the spectrum reading the maximum power value.
- b. The substitution horn antenna is substituted for EUT at the same position and signals generator export the CW signal to the substitution antenna via a TX cable. Rotated the Turn Table and moved receiving antenna to find the maximum radiation power. Adjust output power level of S.G to get a Value of spectrum reading equal to “Read Value” of step a. Record the power level of S.G
- c.  $\text{EIRP} = \text{Output power level of S.G} - \text{TX cable loss} + \text{Antenna gain of substitution horn}$ .
- d. E.R.P power can be calculated form E.I.R.P power by subtracting the gain of dipole,  $\text{E.R.P power} = \text{E.I.P.R power} - 2.15\text{dBi}$ .

**NOTE:** The resolution bandwidth and video bandwidth of test receiver/spectrum analyzer is 1MHz/3MHz.

#### 3.6.3 DEVIATION FROM TEST STANDARD

No deviation



### 3.6.4 TEST SETUP

#### < Frequency Range 30MHz~1GHz >

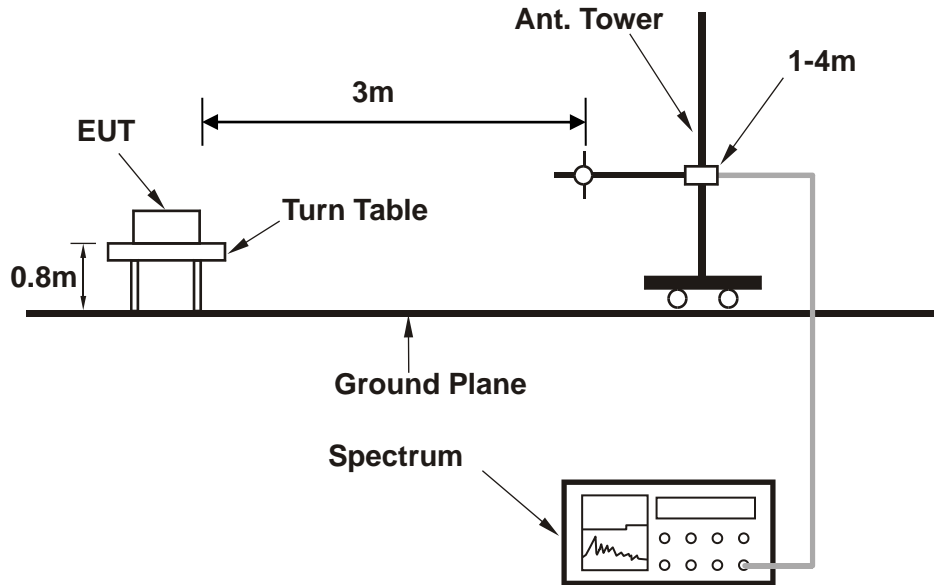

#### <Frequency Range above 1GHz>

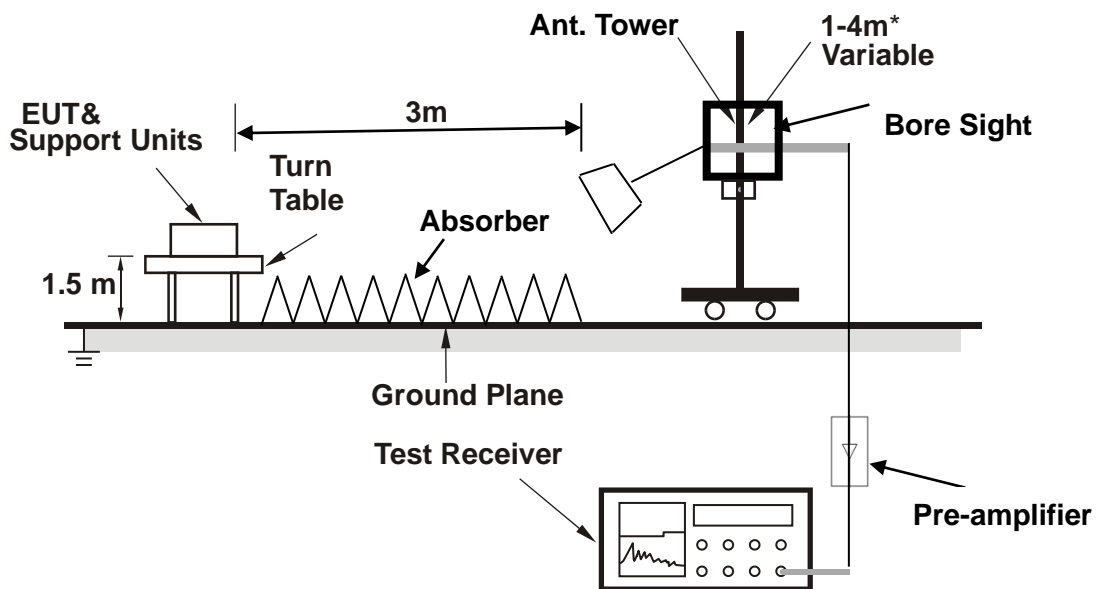

**Note:** Above 1G is a directional antenna

Depends on the EUT height and the antenna 3dB beamwidth both, refer to section 7.3 of CISPR 16-2-3.

For the actual test configuration, please refer to the attached file (Test Setup Photo).



**BUREAU  
VERITAS**

Test Report No.: W7L-P24050005RF04

### 3.6.5 TEST RESULTS

#### BELOW 1GHz WORST-CASE DATA

30 MHz – 1GHz data:

LTE BAND 5

CHANNEL BANDWIDTH: 10MHz / QPSK

<b>MODE</b>	TX channel 20525	<b>FREQUENCY RANGE</b>	Below 1000MHz
<b>ENVIRONMENTAL CONDITIONS</b>	23deg. C, 70%RH	<b>INPUT POWER</b>	AC 120V/60Hz
<b>TESTED BY</b>	Jace Hu		
<b>ANTENNA POLARITY &amp; TEST DISTANCE: HORIZONTAL AT 3 M</b>			

	Freq	Level	Read Level	Limit Line	Over Limit	Factor	Remark	Pol/Phase
	MHz	dBm/m	dBm	dBm/m	dB	dB/m		
1	PP	72.680	-22.60	-30.35	-13.00	-9.60	7.75 Peak	Horizontal
2		153.190	-32.59	-42.60	-13.00	-19.59	10.01 Peak	Horizontal
3		206.540	-37.63	-48.92	-13.00	-24.63	11.29 Peak	Horizontal
4		305.480	-43.82	-57.98	-13.00	-30.82	14.16 Peak	Horizontal
5		428.670	-42.03	-59.45	-13.00	-29.03	17.42 Peak	Horizontal
6		587.750	-39.32	-59.77	-13.00	-26.32	20.45 Peak	Horizontal

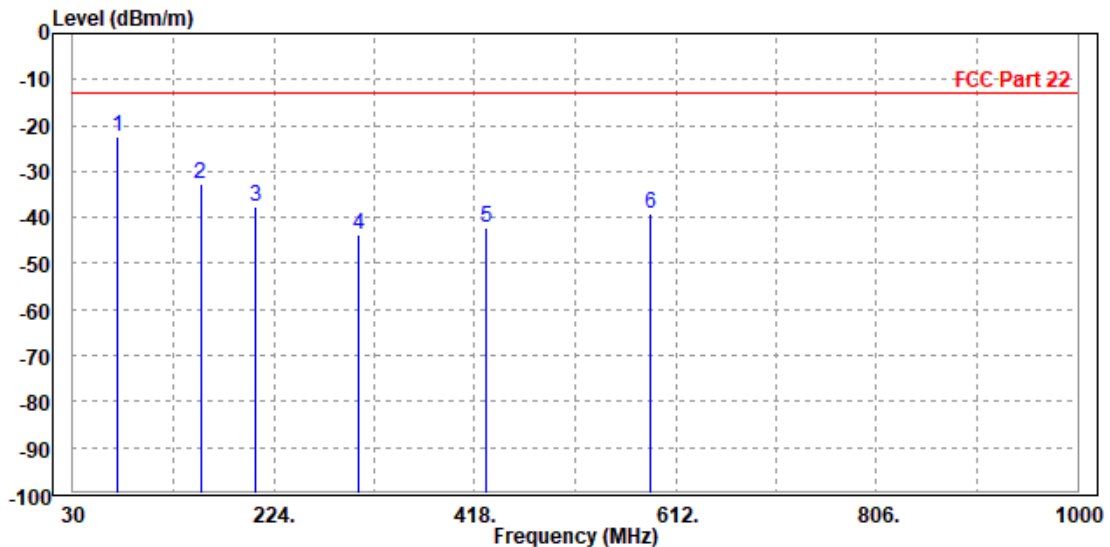





**BUREAU  
VERITAS**

**Test Report No.: W7L-P24050005RF04**

<b>MODE</b>	TX channel 20525	<b>FREQUENCY RANGE</b>	Below 1000MHz
<b>ENVIRONMENTAL CONDITIONS</b>	23deg. C, 70%RH	<b>INPUT POWER</b>	AC 120V/60Hz
<b>TESTED BY</b>	Jace Hu		
<b>ANTENNA POLARITY &amp; TEST DISTANCE: VERTICAL AT 3 M</b>			

	Freq	Level	Read Level	Limit Line	Over Limit	Factor	Remark	Pol/Phase
	MHz	dBm/m	dBm	dBm/m	dB	dB/m		
1	33.880	-25.51	-44.00	-13.00	-12.51	18.49	Peak	Vertical
2 PP	71.710	-23.07	-31.04	-13.00	-10.07	7.97	Peak	Vertical
3	153.190	-33.00	-43.48	-13.00	-20.00	10.48	Peak	Vertical
4	247.280	-43.44	-57.11	-13.00	-30.44	13.67	Peak	Vertical
5	344.280	-43.76	-59.73	-13.00	-30.76	15.97	Peak	Vertical
6	407.330	-41.60	-58.94	-13.00	-28.60	17.34	Peak	Vertical

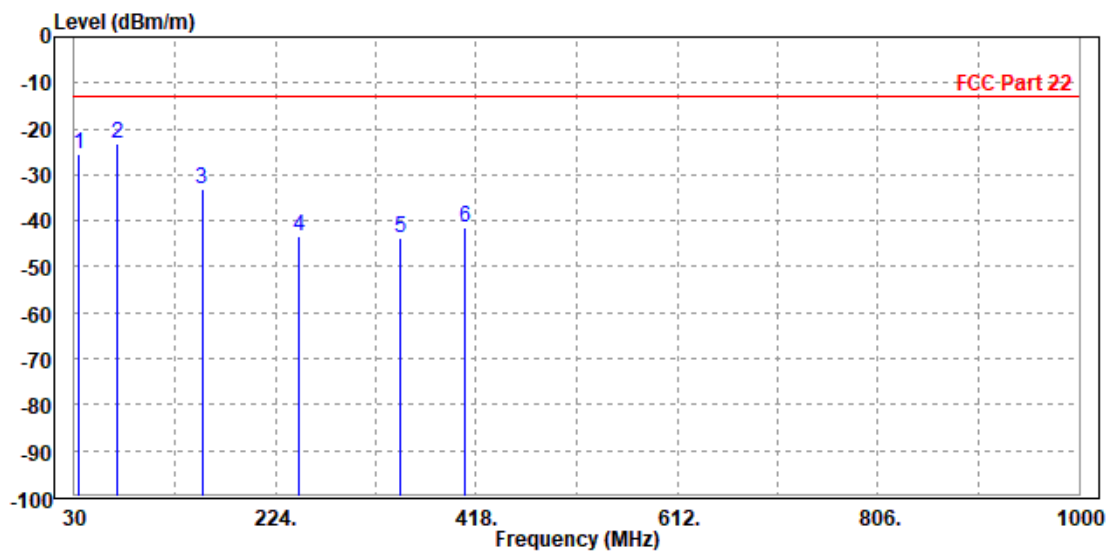



**BUREAU  
VERITAS**

**Test Report No.: W7L-P24050005RF04**

**ABOVE 1GHz DATA**

**Note:** For higher frequency, the emission is too low to be detected.

**WCDMA Band V:**

**CH 4132:**

<b>MODE</b>	TX channel 4132	<b>FREQUENCY RANGE</b>	Above 1000MHz
<b>ENVIRONMENTAL CONDITIONS</b>	23deg. C, 70%RH	<b>INPUT POWER</b>	AC 120V/60Hz
<b>TESTED BY</b>	Jace Hu		
<b>ANTENNA POLARITY &amp; TEST DISTANCE: HORIZONTAL AT 3 M</b>			

	Freq	Level	Read Level	Limit Line	Over Limit	Factor	Remark	Pol/Phase
	MHz	dBm/m	dBm	dBm/m	dB	dB/m		
1	1648.000	-48.19	-51.44	-13.00	-35.19	3.25	Peak	Horizontal
2 PP	2476.000	-35.57	-43.60	-13.00	-22.57	8.03	Peak	Horizontal

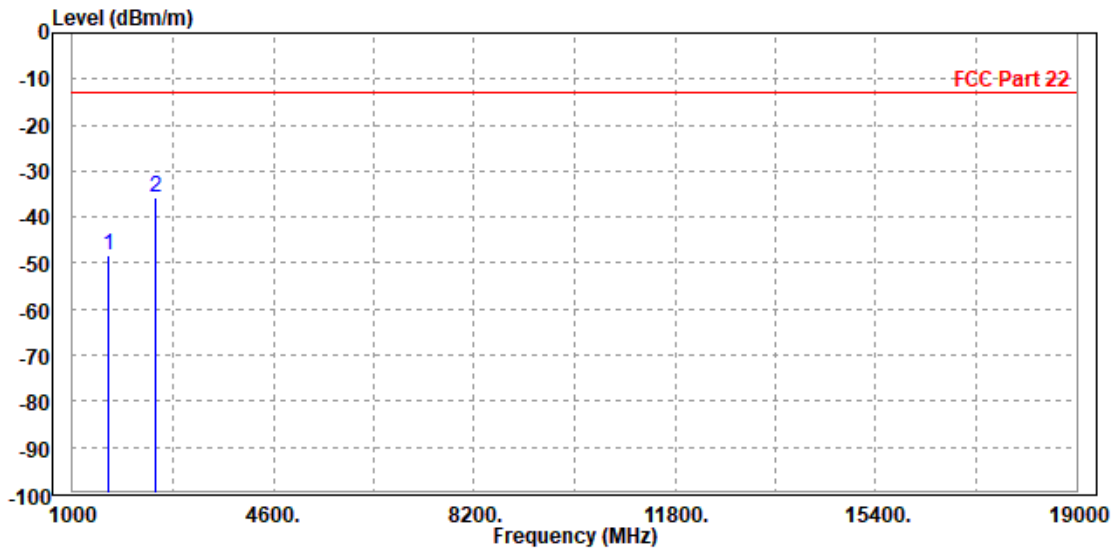



**BUREAU  
VERITAS**

**Test Report No.: W7L-P24050005RF04**

<b>MODE</b>	TX channel 4132	<b>FREQUENCY RANGE</b>	Above 1000MHz
<b>ENVIRONMENTAL CONDITIONS</b>	23deg. C, 70%RH	<b>INPUT POWER</b>	AC 120V/60Hz
<b>TESTED BY</b>	Jace Hu		
<b>ANTENNA POLARITY &amp; TEST DISTANCE: VERTICAL AT 3 M</b>			

	Freq	Level	Read Level	Limit	Over Limit	Factor	Remark	Pol/Phase
	MHz	dBm/m	dBm	dBm/m	dB	dB/m		
1	1648.000	-51.03	-54.41	-13.00	-38.03	3.38	Peak	Vertical
2 PP	2476.000	-36.78	-43.82	-13.00	-23.78	7.04	Peak	Vertical

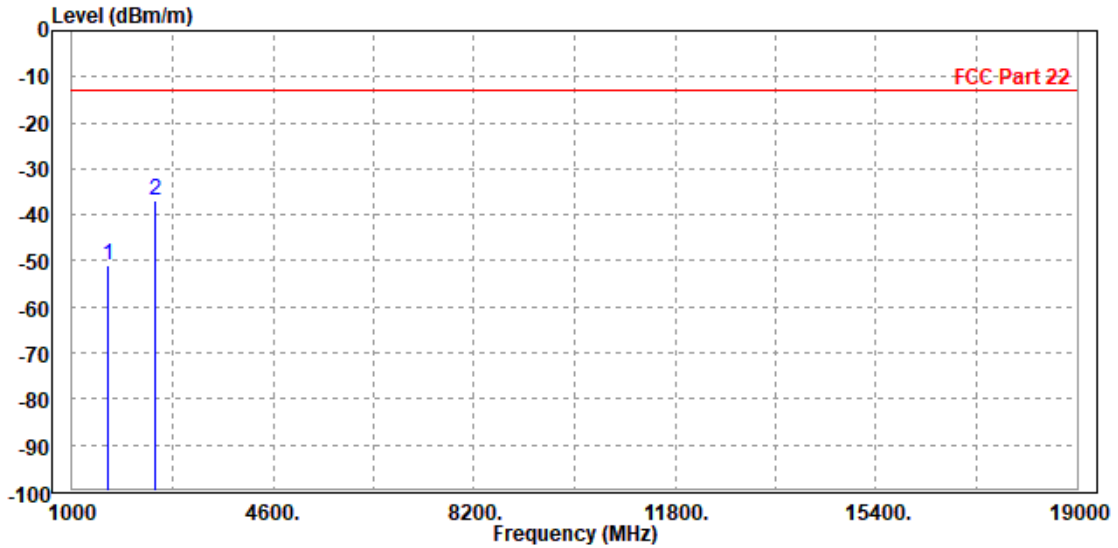



Test Report No.: W7L-P24050005RF04

CH 4182:

<b>MODE</b>	TX channel 4182	<b>FREQUENCY RANGE</b>	Above 1000MHz
<b>ENVIRONMENTAL CONDITIONS</b>	23deg. C, 70%RH	<b>INPUT POWER</b>	AC 120V/60Hz
<b>TESTED BY</b>	Jace Hu		
<b>ANTENNA POLARITY &amp; TEST DISTANCE: HORIZONTAL AT 3 M</b>			

	Freq	Level	Read Level	Limit Line	Over Limit	Factor	Remark	Pol/Phase
	MHz	dBm/m	dBm	dBm/m	dB	dB/m		
1	1666.000	-51.07	-54.54	-13.00	-38.07	3.47	Peak	Horizontal
2 PP	2512.000	-34.65	-42.71	-13.00	-21.65	8.06	Peak	Horizontal

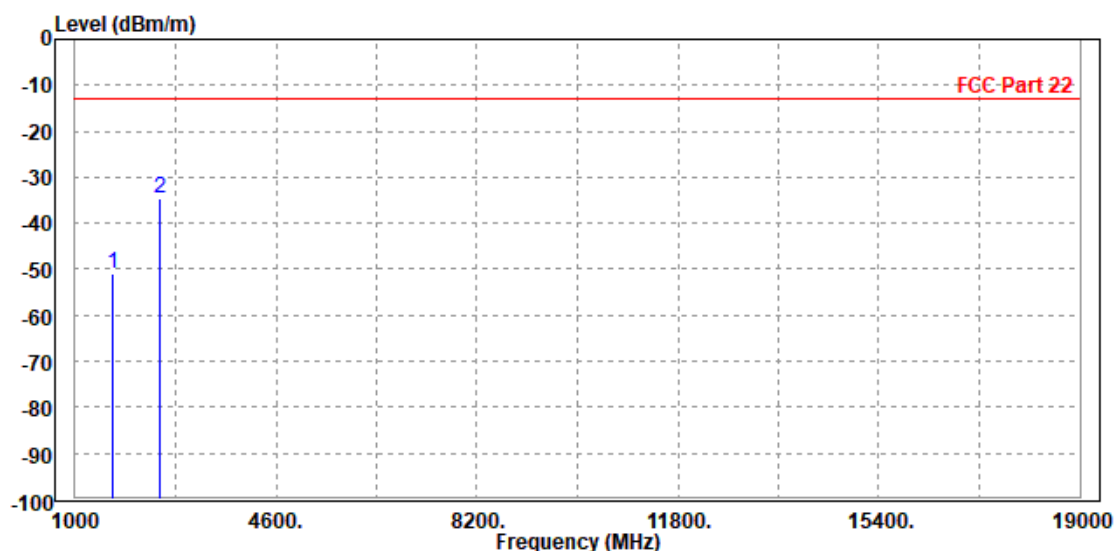



**BUREAU  
VERITAS**

**Test Report No.: W7L-P24050005RF04**

<b>MODE</b>	TX channel 4182	<b>FREQUENCY RANGE</b>	Above 1000MHz
<b>ENVIRONMENTAL CONDITIONS</b>	23deg. C, 70%RH	<b>INPUT POWER</b>	AC 120V/60Hz
<b>TESTED BY</b>	Jace Hu		
<b>ANTENNA POLARITY &amp; TEST DISTANCE: VERTICAL AT 3 M</b>			

	Freq	Level	Read Level	Limit Line	Over Limit	Factor	Remark	Pol/Phase
	MHz	dBm/m	dBm	dBm/m	dB	dB/m		
1	1672.800	-50.74	-54.35	-13.00	-37.74	3.61	Peak	Vertical
2 PP	2512.000	-33.97	-41.08	-13.00	-20.97	7.11	Peak	Vertical

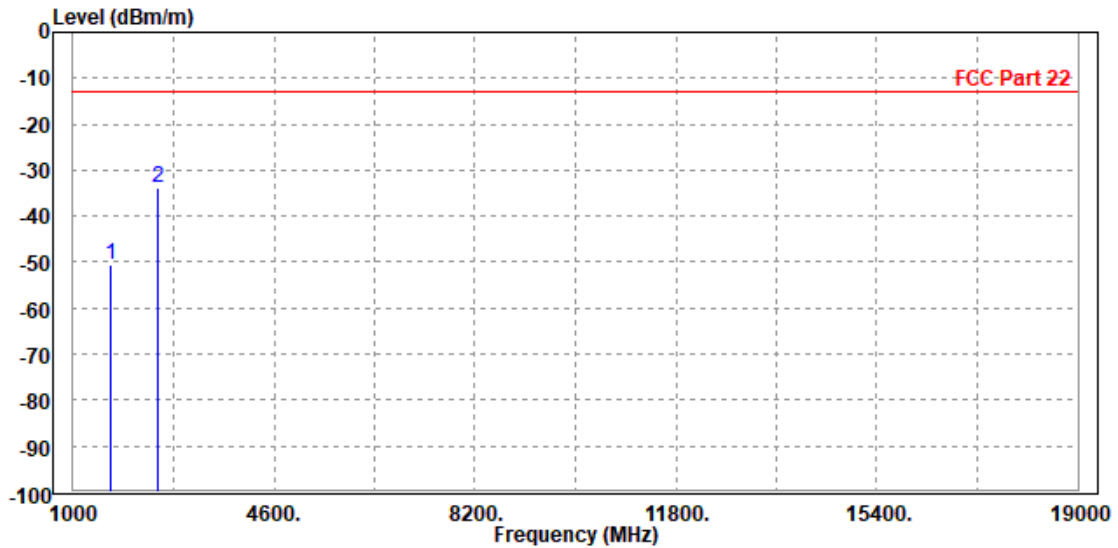



CH 4233:

<b>MODE</b>	TX channel 4233	<b>FREQUENCY RANGE</b>	Above 1000MHz
<b>ENVIRONMENTAL CONDITIONS</b>	23deg. C, 70%RH	<b>INPUT POWER</b>	AC 120V/60Hz
<b>TESTED BY</b>	Jace Hu		
<b>ANTENNA POLARITY &amp; TEST DISTANCE: HORIZONTAL AT 3 M</b>			

	Freq	Level	Read Level	Limit Line	Over Limit	Factor	Remark	Pol/Phase
	MHz	dBm/m	dBm	dBm/m	dB	dB/m		
1	1693.200	-40.34	-44.14	-13.00	-27.34	3.80	Peak	Horizontal
2 PP	2548.000	-35.02	-43.13	-13.00	-22.02	8.11	Peak	Horizontal

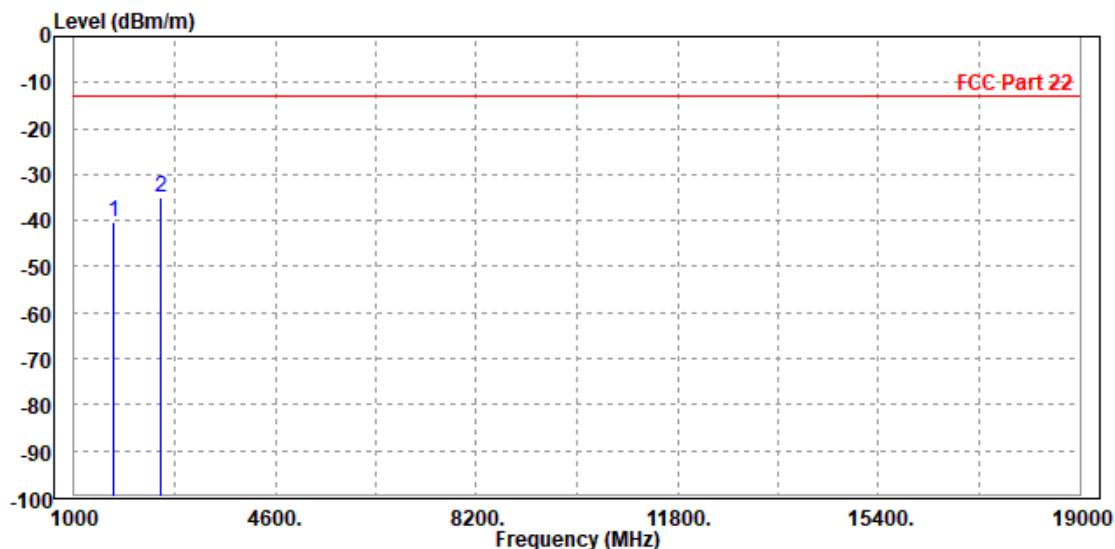



**BUREAU  
VERITAS**

Test Report No.: W7L-P24050005RF04

<b>MODE</b>	TX channel 4233	<b>FREQUENCY RANGE</b>	Above 1000MHz
<b>ENVIRONMENTAL CONDITIONS</b>	23deg. C, 70%RH	<b>INPUT POWER</b>	AC 120V/60Hz
<b>TESTED BY</b>	Jace Hu		
<b>ANTENNA POLARITY &amp; TEST DISTANCE: VERTICAL AT 3 M</b>			

	Freq	Level	Read Level	Limit Line	Over Limit	Factor	Remark	Pol/Phase
	MHz	dBm/m	dBm	dBm/m	dB	dB/m		
1	1702.000	-49.21	-53.08	-13.00	-36.21	3.87	Peak	Vertical
2 PP	2548.000	-34.76	-41.98	-13.00	-21.76	7.22	Peak	Vertical

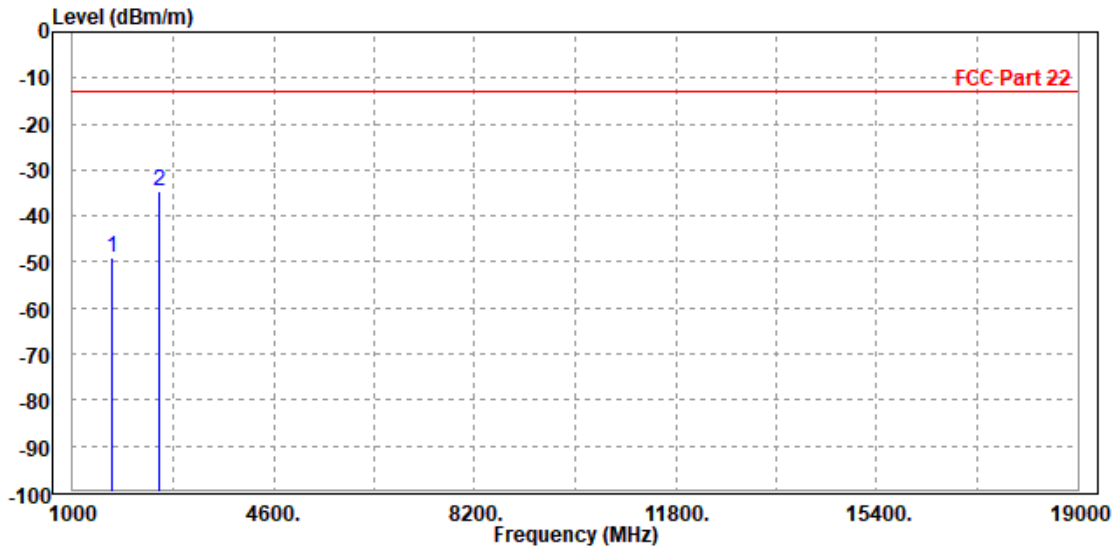



**BUREAU  
VERITAS**

**Test Report No.: W7L-P24050005RF04**

**LTE Band 5**

**CHANNEL BANDWIDTH: 1.4MHz / QPSK**

<b>MODE</b>	TX channel 20525	<b>FREQUENCY RANGE</b>	Above 1000MHz
<b>ENVIRONMENTAL CONDITIONS</b>	23deg. C, 70%RH	<b>INPUT POWER</b>	AC 120V/60Hz
<b>TESTED BY</b>	Jace Hu		
<b>ANTENNA POLARITY &amp; TEST DISTANCE: HORIZONTAL AT 3 M</b>			

	Freq	Level	Read Level	Limit Line	Over Limit	Factor	Remark	Pol/Phase
	MHz	dBm/m	dBm	dBm/m	dB	dB/m		
1	1666.000	-48.40	-51.87	-13.00	-35.40	3.47	Peak	Horizontal
2 PP	2509.500	-33.39	-41.45	-13.00	-20.39	8.06	Peak	Horizontal

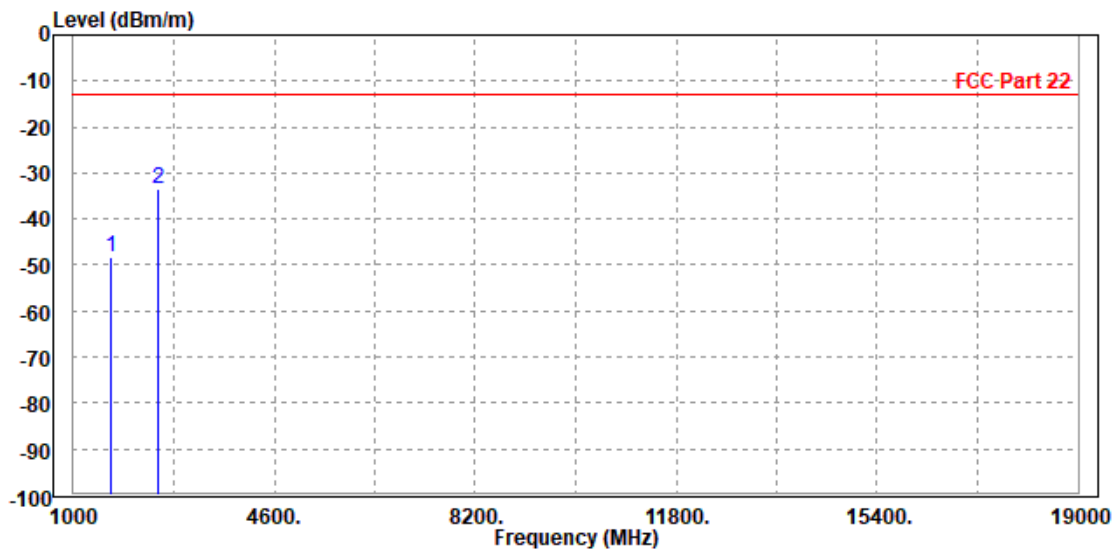





**BUREAU  
VERITAS**

**Test Report No.: W7L-P24050005RF04**

<b>MODE</b>	TX channel 20525	<b>FREQUENCY RANGE</b>	Above 1000MHz
<b>ENVIRONMENTAL CONDITIONS</b>	23deg. C, 70%RH	<b>INPUT POWER</b>	AC 120V/60Hz
<b>TESTED BY</b>	Jace Hu		
<b>ANTENNA POLARITY &amp; TEST DISTANCE: VERTICAL AT 3 M</b>			

	Freq	Level	Read Level	Limit Line	Over Limit	Factor	Remark	Pol/Phase
	MHz	dBm/m	dBm	dBm/m	dB	dB/m		
1	1666.000	-47.38	-50.92	-13.00	-34.38	3.54	Peak	Vertical
2 PP	2509.500	-34.14	-41.24	-13.00	-21.14	7.10	Peak	Vertical

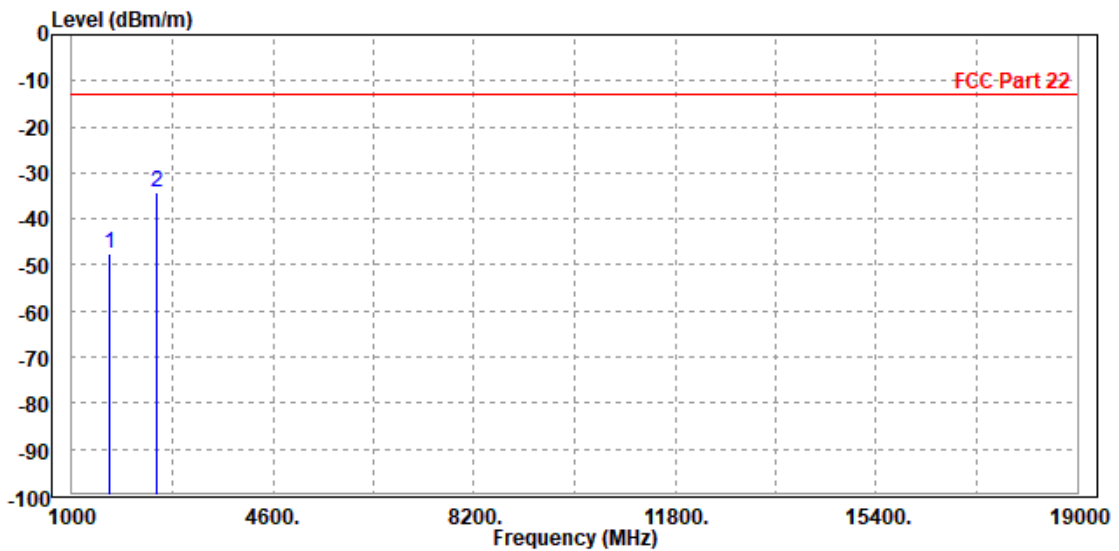



Test Report No.: W7L-P24050005RF04

CHANNEL BANDWIDTH: 3MHz / QPSK

MODE	TX channel 20525	FREQUENCY RANGE	Above 1000MHz
ENVIRONMENTAL CONDITIONS	23deg. C, 70%RH	INPUT POWER	AC 120V/60Hz
TESTED BY	Jace Hu		
<b>ANTENNA POLARITY &amp; TEST DISTANCE: HORIZONTAL AT 3 M</b>			

	Freq	Level	Read Level	Limit Line	Over Limit	Factor	Remark	Pol/Phase
	MHz	dBm/m	dBm	dBm/m	dB	dB/m		
1	1666.000	-49.55	-53.02	-13.00	-36.55	3.47	Peak	Horizontal
2 PP	2509.500	-32.38	-40.44	-13.00	-19.38	8.06	Peak	Horizontal

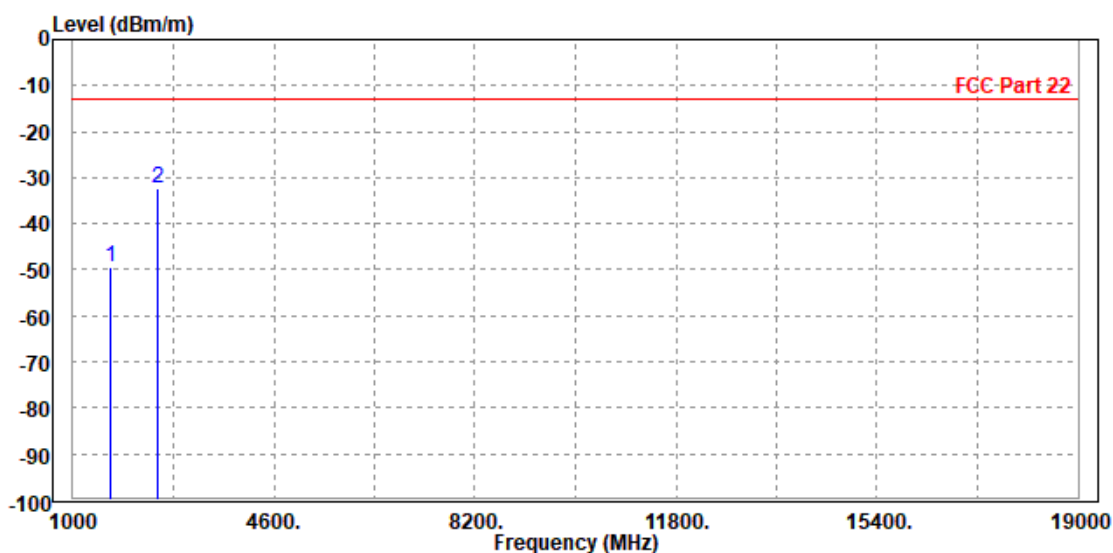



**BUREAU  
VERITAS**

Test Report No.: W7L-P24050005RF04

<b>MODE</b>	TX channel 20525	<b>FREQUENCY RANGE</b>	Above 1000MHz
<b>ENVIRONMENTAL CONDITIONS</b>	23deg. C, 70%RH	<b>INPUT POWER</b>	AC 120V/60Hz
<b>TESTED BY</b>	Jace Hu		
<b>ANTENNA POLARITY &amp; TEST DISTANCE: VERTICAL AT 3 M</b>			

	Freq	Level	Read Level	Limit Line	Over Limit	Factor	Remark	Pol/Phase
	MHz	dBm/m	dBm	dBm/m	dB	dB/m		
1	1666.000	-49.38	-52.92	-13.00	-36.38	3.54	Peak	Vertical
2 PP	2509.500	-33.85	-40.95	-13.00	-20.85	7.10	Peak	Vertical

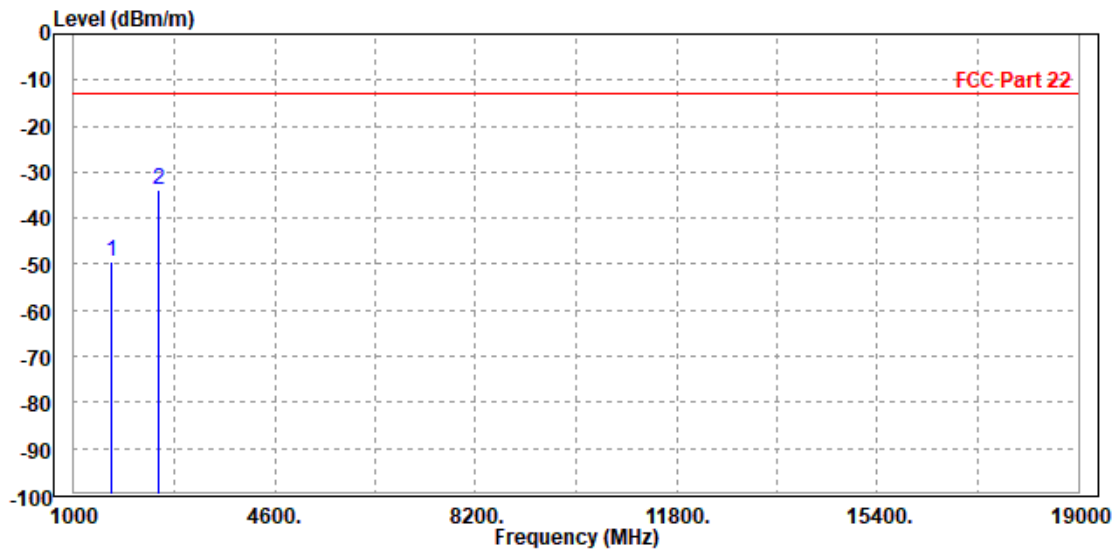



BUREAU VERITAS

Test Report No.: W7L-P24050005RF04

CHANNEL BANDWIDTH: 5MHz / QPSK

MODE	TX channel 20525	FREQUENCY RANGE	Above 1000MHz
ENVIRONMENTAL CONDITIONS	23deg. C, 70%RH	INPUT POWER	AC 120V/60Hz
TESTED BY	Jace Hu		
<b>ANTENNA POLARITY &amp; TEST DISTANCE: HORIZONTAL AT 3 M</b>			

	Freq	Level	Read Level	Limit Line	Over Limit	Factor	Remark	Pol/Phase
	MHz	dBm/m	dBm	dBm/m	dB	dB/m		
1	1666.000	-50.56	-54.03	-13.00	-37.56	3.47	Peak	Horizontal
2 PP	2509.500	-33.76	-41.82	-13.00	-20.76	8.06	Peak	Horizontal

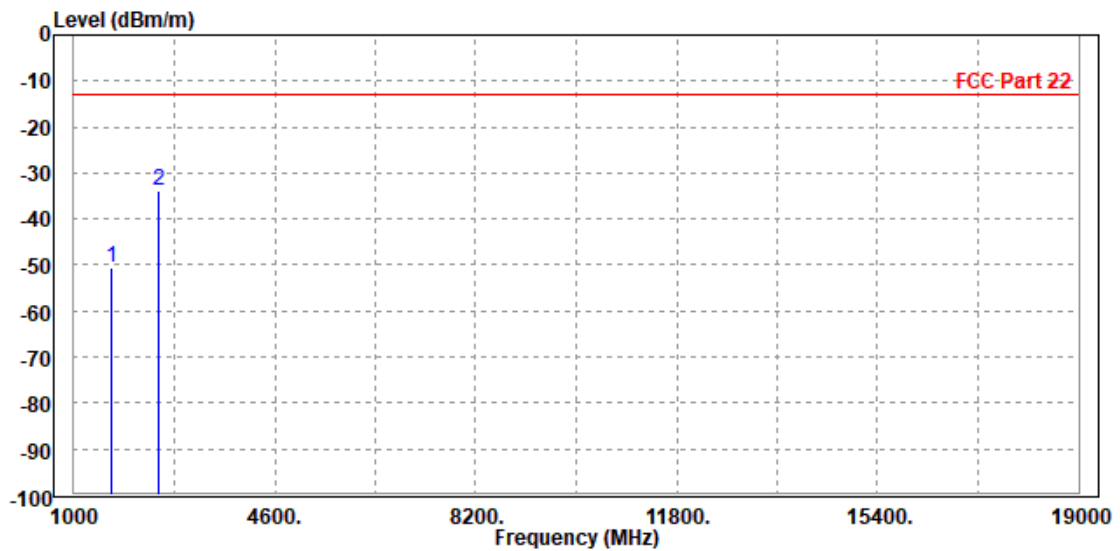



**BUREAU  
VERITAS**

**Test Report No.: W7L-P24050005RF04**

<b>MODE</b>	TX channel 20525	<b>FREQUENCY RANGE</b>	Above 1000MHz
<b>ENVIRONMENTAL CONDITIONS</b>	23deg. C, 70%RH	<b>INPUT POWER</b>	AC 120V/60Hz
<b>TESTED BY</b>	Jace Hu		
<b>ANTENNA POLARITY &amp; TEST DISTANCE: VERTICAL AT 3 M</b>			

	Freq	Level	Read Level	Limit Line	Over Limit	Factor	Remark	Pol/Phase
	MHz	dBm/m	dBm	dBm/m	dB	dB/m		
1	1666.000	-50.19	-53.73	-13.00	-37.19	3.54	Peak	Vertical
2 PP	2509.500	-33.63	-40.73	-13.00	-20.63	7.10	Peak	Vertical

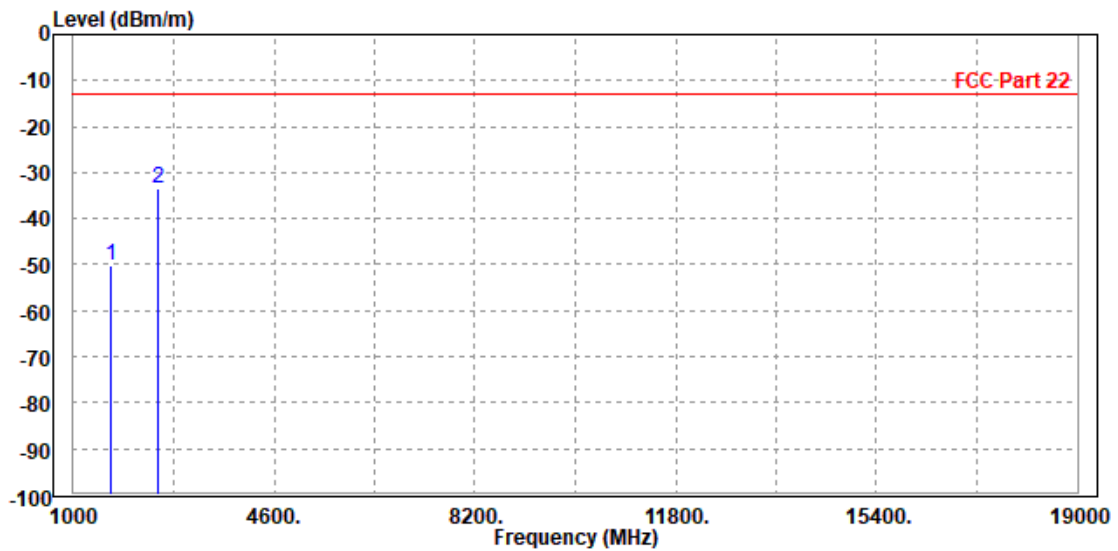



**BUREAU  
VERITAS**

**Test Report No.: W7L-P24050005RF04**

**CHANNEL BANDWIDTH: 10MHz / QPSK  
CH 20450**

<b>MODE</b>	TX channel 20450	<b>FREQUENCY RANGE</b>	Above 1000MHz
<b>ENVIRONMENTAL CONDITIONS</b>	23deg. C, 70%RH	<b>INPUT POWER</b>	AC 120V/60Hz
<b>TESTED BY</b>	Jace Hu		
<b>ANTENNA POLARITY &amp; TEST DISTANCE: HORIZONTAL AT 3 M</b>			

	Freq	Level	Read Level	Limit Line	Over Limit	Factor	Remark	Pol/Phase
	MHz	dBm/m	dBm	dBm/m	dB	dB/m		
1	1666.000	-49.35	-52.82	-13.00	-36.35	3.47	Peak	Horizontal
2 PP	2487.000	-46.06	-54.10	-13.00	-33.06	8.04	Peak	Horizontal

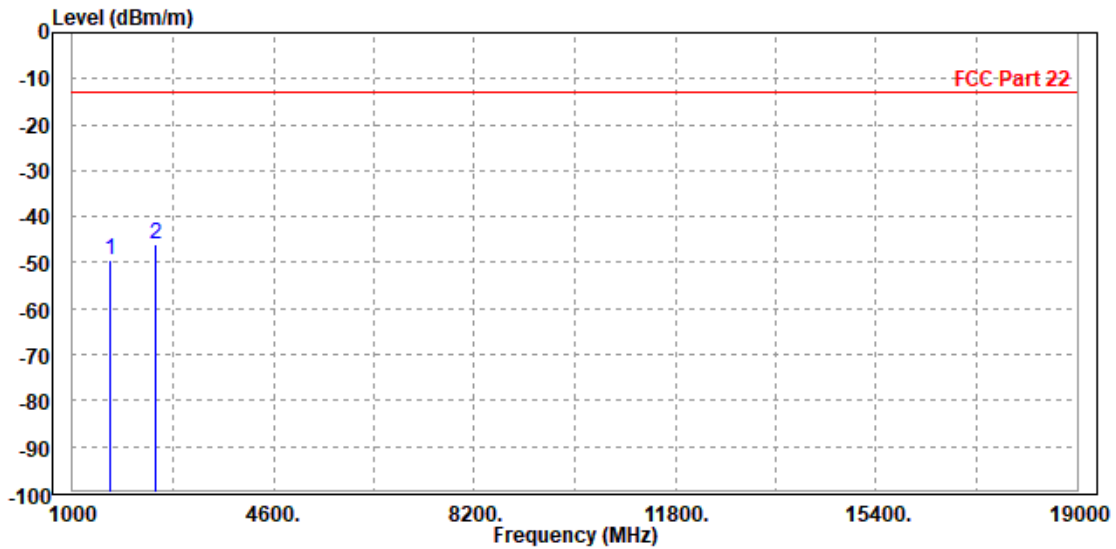



**BUREAU  
VERITAS**

**Test Report No.: W7L-P24050005RF04**

<b>MODE</b>	TX channel 20450	<b>FREQUENCY RANGE</b>	Above 1000MHz
<b>ENVIRONMENTAL CONDITIONS</b>	23deg. C, 70%RH	<b>INPUT POWER</b>	AC 120V/60Hz
<b>TESTED BY</b>	Jace Hu		
<b>ANTENNA POLARITY &amp; TEST DISTANCE: VERTICAL AT 3 M</b>			

	Freq	Level	Read Level	Limit Line	Over Limit	Factor	Remark	Pol/Phase
	MHz	dBm/m	dBm	dBm/m	dB	dB/m		
1	1666.000	-50.35	-53.89	-13.00	-37.35	3.54	Peak	Vertical
2 PP	2487.000	-47.66	-54.71	-13.00	-34.66	7.05	Peak	Vertical

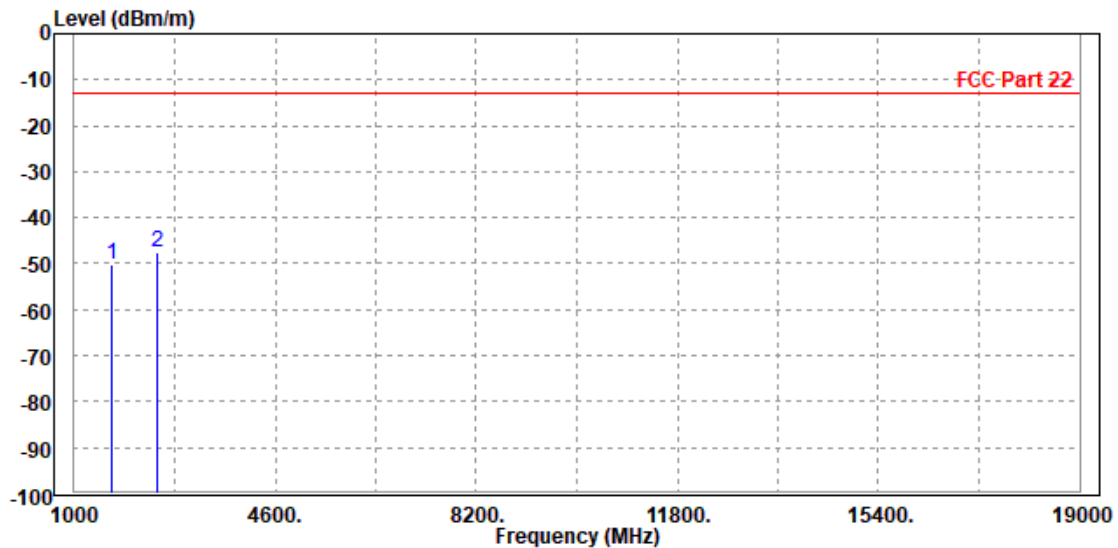



**BUREAU  
VERITAS**

Test Report No.: W7L-P24050005RF04

**CH 20525**

<b>MODE</b>	TX channel 20525	<b>FREQUENCY RANGE</b>	Above 1000MHz
<b>ENVIRONMENTAL CONDITIONS</b>	23deg. C, 70%RH	<b>INPUT POWER</b>	AC 120V/60Hz
<b>TESTED BY</b>	Jace Hu		
<b>ANTENNA POLARITY &amp; TEST DISTANCE: HORIZONTAL AT 3 M</b>			

	Freq	Level	Read Level	Limit Line	Over Limit	Factor	Remark	Pol/Phase
	MHz	dBm/m	dBm	dBm/m	dB	dB/m		
1	1666.000	-52.68	-56.15	-13.00	-39.68	3.47	Peak	Horizontal
2 PP	2509.500	-31.79	-39.85	-13.00	-18.79	8.06	Peak	Horizontal

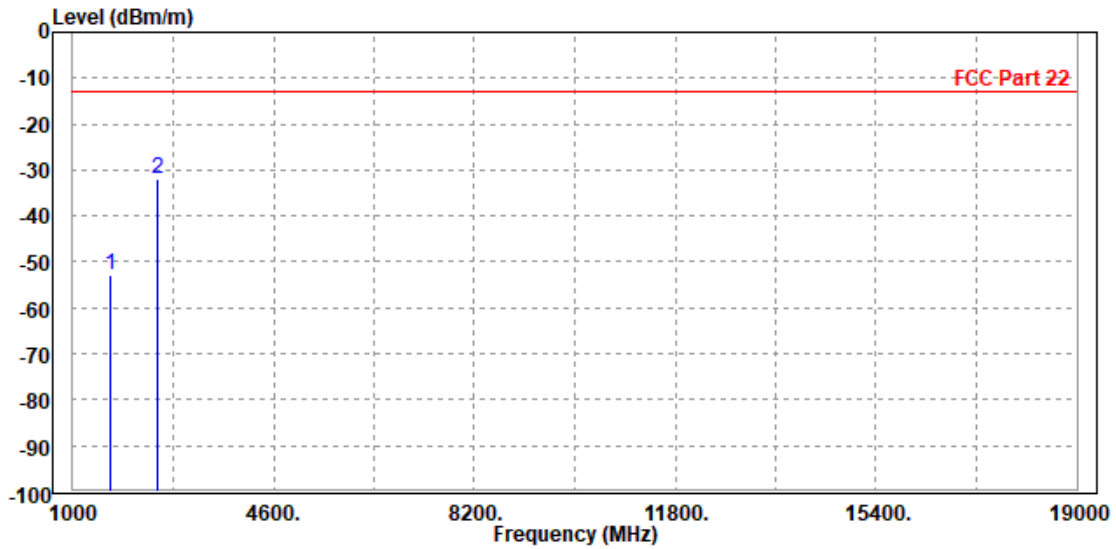





**BUREAU  
VERITAS**

**Test Report No.: W7L-P24050005RF04**

<b>MODE</b>	TX channel 20525	<b>FREQUENCY RANGE</b>	Above 1000MHz
<b>ENVIRONMENTAL CONDITIONS</b>	23deg. C, 70%RH	<b>INPUT POWER</b>	AC 120V/60Hz
<b>TESTED BY</b>	Jace Hu		
<b>ANTENNA POLARITY &amp; TEST DISTANCE: VERTICAL AT 3 M</b>			

	Freq	Level	Read Level	Limit Line	Over Limit	Factor	Remark	Pol/Phase
	MHz	dBm/m	dBm	dBm/m	dB	dB/m		
1	1666.000	-51.32	-54.86	-13.00	-38.32	3.54	Peak	Vertical
2 PP	2509.500	-33.26	-40.36	-13.00	-20.26	7.10	Peak	Vertical

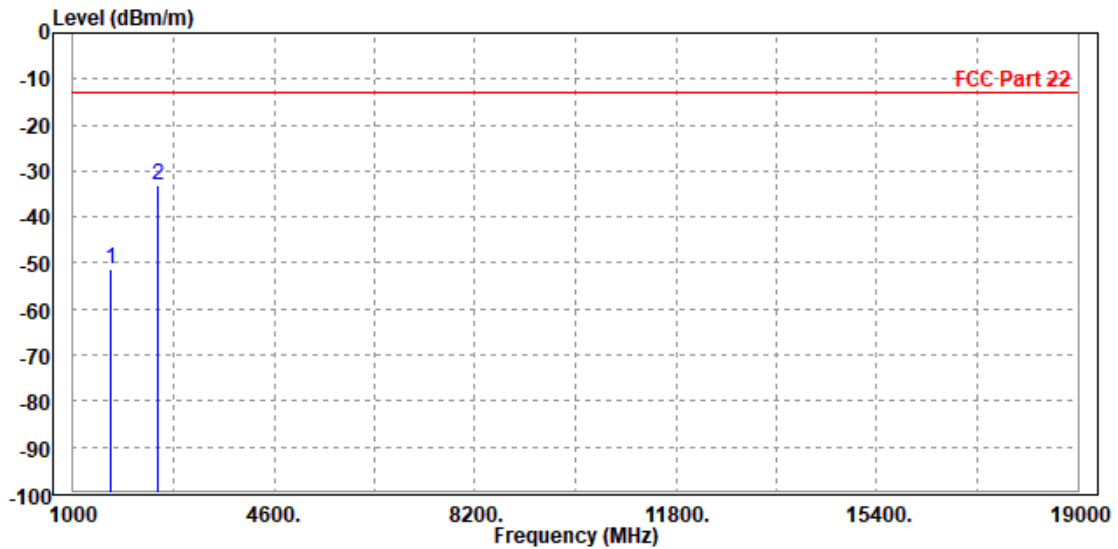



**BUREAU  
VERITAS**

**Test Report No.: W7L-P24050005RF04**

**CH 20600**

<b>MODE</b>	TX channel 20600	<b>FREQUENCY RANGE</b>	Above 1000MHz
<b>ENVIRONMENTAL CONDITIONS</b>	23deg. C, 70%RH	<b>INPUT POWER</b>	AC 120V/60Hz
<b>TESTED BY</b>	Jace Hu		
<b>ANTENNA POLARITY &amp; TEST DISTANCE: HORIZONTAL AT 3 M</b>			

	Freq	Level	Read Level	Limit Line	Over Limit	Factor	Remark	Pol/Phase
	MHz	dBm/m	dBm	dBm/m	dB	dB/m		
1	1684.000	-48.91	-52.60	-13.00	-35.91	3.69	Peak	Horizontal
2 PP	2532.000	-34.44	-42.53	-13.00	-21.44	8.09	Peak	Horizontal

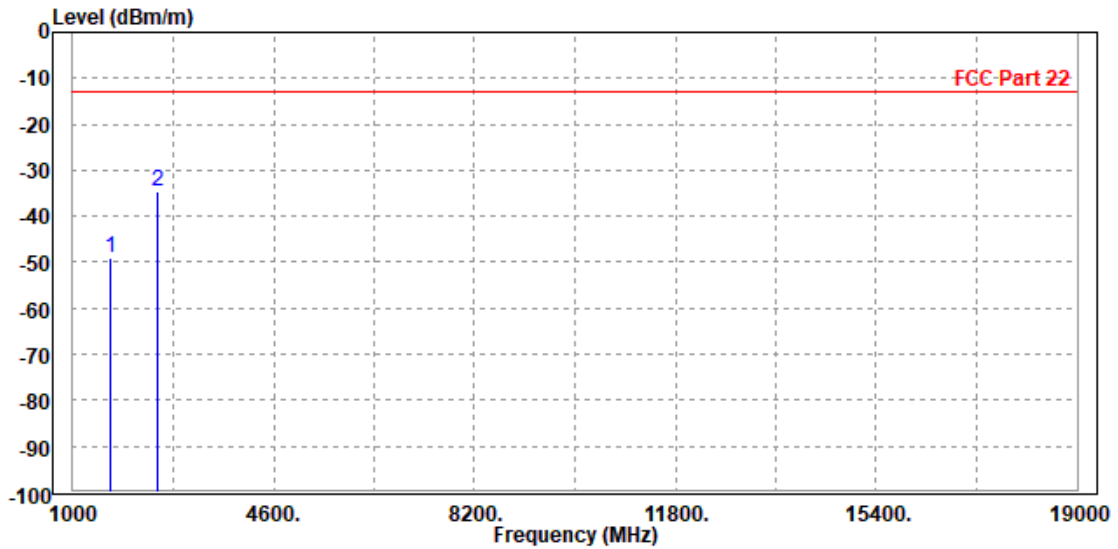



**BUREAU  
VERITAS**

**Test Report No.: W7L-P24050005RF04**

<b>MODE</b>	TX channel 20600	<b>FREQUENCY RANGE</b>	Above 1000MHz
<b>ENVIRONMENTAL CONDITIONS</b>	23deg. C, 70%RH	<b>INPUT POWER</b>	AC 120V/60Hz
<b>TESTED BY</b>	Jace Hu		
<b>ANTENNA POLARITY &amp; TEST DISTANCE: VERTICAL AT 3 M</b>			

	Freq	Level	Read Level	Limit Line	Over Limit	Factor	Remark	Pol/Phase
	MHz	dBm/m	dBm	dBm/m	dB	dB/m		
1	1684.000	-50.06	-53.77	-13.00	-37.06	3.71	Peak	Vertical
2	PP 2532.000	-35.24	-42.41	-13.00	-22.24	7.17	Peak	Vertical

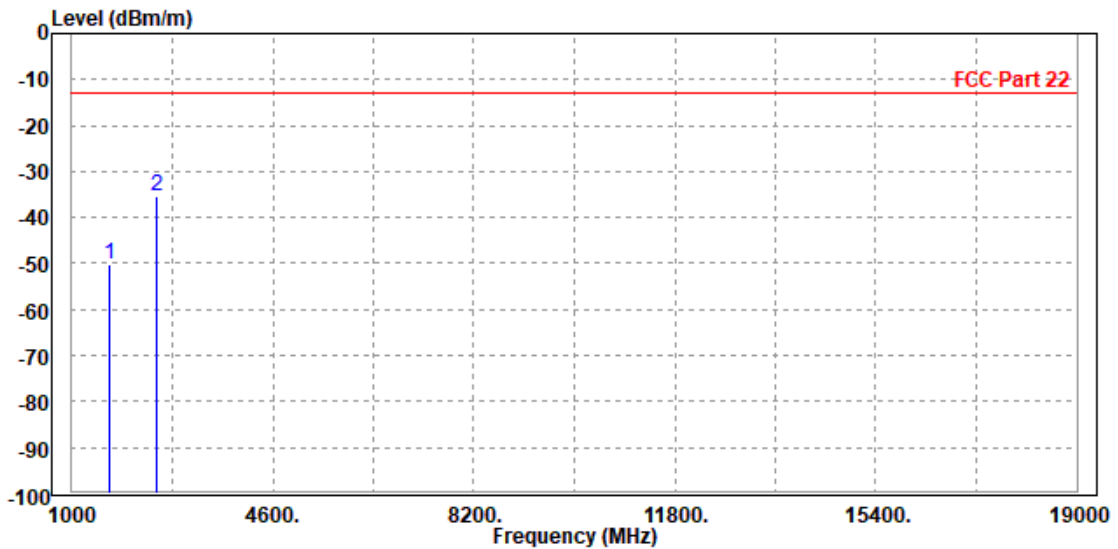

### 3.7 PEAK TO AVERAGE RATIO

#### 3.7.1 LIMITS OF PEAK TO AVERAGE RATIO MEASUREMENT

In measuring transmissions in this band using an average power technique, the peak to-average ratio (PAR) of the transmission may not exceed 13 dB

#### 3.7.2 TEST SETUP

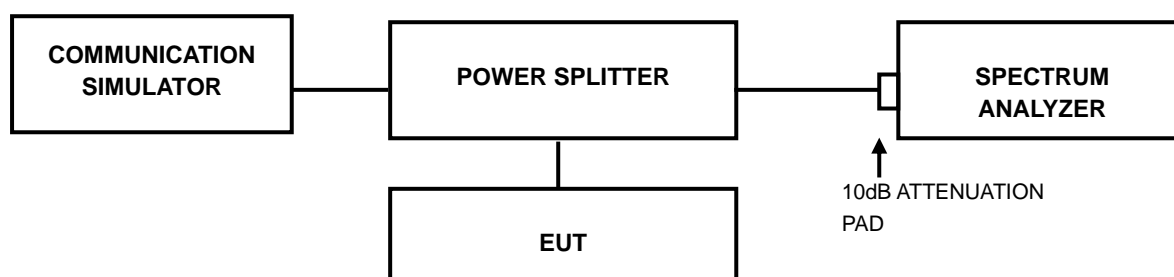

#### 3.7.3 TEST PROCEDURES

1. Set resolution/measurement bandwidth  $\geq$  signal's occupied bandwidth;
2. Set the number of counts to a value that stabilizes the measured CCDF curve;
3. Record the maximum PAPR level associated with a probability of 0.1%.



**BUREAU  
VERITAS**

**Test Report No.: W7L-P24050005RF04**

### 3.7.4 TEST RESULTS

#### **WCDMA Band V**

Please Refer to Appendix A 1 Of this test report.

#### **LTE BAND 5**

Please Refer to Appendix A 1. of this test report.



Test Report No.: W7L-P24050005RF04

## 4 PHOTOGRAPHS OF THE TEST CONFIGURATION

Please refer to the attached file (Test Setup Photo).



Test Report No.: W7L-P24050005RF04

## 5 INFORMATION ON THE TESTING LABORATORIES

We, BV 7LAYERS COMMUNICATIONS TECHNOLOGY (SHENZHEN) CO. LTD., were founded in 2015 to provide our best service in EMC, Radio, Telecom and Safety consultation. Our laboratories are accredited and approved according to ISO/IEC 17025.

If you have any comments, please feel free to contact us at the following:

**Shenzhen EMC/RF Lab:**

Tel: +86-755-88696566

Fax: +86-755-88696577

**Email:** [customerservice.sw@cn.bureauveritas.com](mailto:customerservice.sw@cn.bureauveritas.com)

**Web Site:** [www.adt.com.tw](http://www.adt.com.tw)

The address and road map of all our labs can be found in our web site also.



**BUREAU  
VERITAS**

Test Report No.: W7L-P24050005RF04

## **6 APPENDIX A 1 – MODIFICATIONS RECORDERS FOR ENGINEERING CHANGES TO THE EUT BY THE LAB**

No any modifications are made to the EUT by the lab during the test.

NOTE: APPENDIX A 1 is another word.

**---END---**