



E-Class Saloon

Operator's Manual

Mercedes-Benz



Front passenger airbag warning



▲ WARNING Risk of injury or death due to an enabled co-driver airbag

If the co-driver airbag is enabled, a child on the co-driver seat may be struck by the co-driver airbag during an accident.

▶ NEVER use a rearward-facing child restraint system on a seat with an ENABLED FRONT AIRBAG. DEATH or SERIOUS INJURY to the CHILD can occur.

Observe the chapter "Children in the vehicle".

Welcome to the world of Mercedes-Benz

Before your first drive, please read this Owner's Manual carefully and familiarise yourself with your vehicle. For your own safety and a longer service life of the vehicle, follow the instructions and warning notices in this Owner's Manual. Disregarding them may lead to damage to the vehicle or injury to people.

The standard equipment and product description of your vehicle may vary and depends on the following factors:

- Model
- Order
- National version
- Availability

Your vehicle may therefore differ from that shown in the descriptions and illustrations in individual cases.

The illustrations in this Owner's Manual show a left-hand drive vehicle. On right-hand drive vehicles, the layout of vehicle parts and controls differs accordingly.

Mercedes-Benz is constantly developing its vehicles further.

Mercedes-Benz therefore reserves the right to introduce changes in the following areas:

- Design
- Equipment
- Technical features

The following documents are components of the vehicle:

- Digital Owner's Manual
- Printed Owner's Manual
- Service Booklet
- Supplementary manuals relating to specific equipment
- Supplementary documents

Keep these documents in the vehicle at all times. Ensure that all documents are in the vehicle or passed on in the event of sale or rental.

Symbols	5	Mercedes me App	25	Notes on pets in the vehicle	75
Quick start and Tips	6	Operating safety	26	Opening and closing	76
At a glance	8	Notes on assembling the number plate on the front licence plate holder	28	Key	76
Cockpit (central display)	8	Declarations of conformity and notes on driving in different countries	28	Digital Vehicle Key	80
Cockpit (MBUX Hyperscreen)	10	Diagnostics connection	32	Doors	85
Indicator and warning lamps (standard)	12	Qualified specialist workshop	33	Boot	93
Indicator and warning lamps (with driver camera)	14	Vehicle registration	33	Side windows	99
Overhead control panel	16	Correct use of the vehicle	33	Sliding sunroof	102
Door operating unit and seat adjustment	18	Information on the REACH regulation	34	Roller sunblinds	106
Emergencies and breakdowns	20	Notes for persons with electronic medical aids	34	Anti-theft protection	107
Digital Owner's Manual	22	Implied warranty	34	Seats and stowing	111
Calling up the Digital Owner's Manual	22	QR code for rescue card	35	Notes on the correct driver's seat position ..	111
General notes	23	Data storage	35	Notes on grab handles	111
Protection of the environment	23	Copyright	38	Seats	112
Take-back of end-of-life vehicles	23	Occupant safety	39	Steering wheel	123
Mercedes-Benz GenuineParts	24	Restraint system	39	Easy entry and exit feature	126
Touch-sensitive controls	25	Seat belts	41	Memory function	127
		Airbags	45	Stowage areas	129
		PRE-SAFE® system	51	Cup holders	140
		Automatic measures after an accident	53	Sockets	143
		Safely transporting children in the vehicle	53	Wireless charging of the mobile phone and connection with the exterior aerial	143

Fitting and removing floor mats	146	Vehicle towing instructions	302	System settings	354
Light and sight	147	Driver's display	304	AMG TRACK PACE	363
Exterior lighting	147	Notes on the driver's display	304	Fit & Healthy	368
Interior lighting	159	Notes on the 3D driver display	304	Navigation and traffic	374
Windscreen wipers and windscreen washer system	162	Operating the driver's display	305	Telephone	412
Mirrors	164	Driver display menus	306	In-Car Apps	445
Climate control	168	Head-up display	312	Online and Internet functions	445
Overview of climate control systems	168	Vehicles with a 48 V on-board electrical system	314	Media	453
Operating the climate control system	169	Overview of status displays on the driver's display	314	Radio	460
Driving and parking	181	MBUX voice assistant	316	Sound	464
Driving	181	Notes on operating safety	316	Camera app	466
DYNAMIC SELECT button	194	Operation	316	Maintenance and care	468
Automatic transmission	196	Using MBUX voice assistant effectively	318	ASSYST PLUS service interval display	468
Function of 4MATIC	203	Essential voice commands	319	Maintenance Management	469
Refuelling	203	MBUX multimedia system	323	Telediagnosics	469
Parking	209	Overview and operation	323	Engine compartment	470
Driving and driving safety systems	215	MBUX Interior Assistant	345	Cleaning and care	477
Trailer hitch	294	Driver camera	352	Breakdown assistance	485
Bicycle rack function	300			Emergency	485
				Flat tyre	487
				Battery (vehicle)	492
				Tow-starting or towing away	498

Electrical fuses 505

Wheels and tyres 509

Notes on noise or unusual handling characteristics 509

Notes on regularly inspecting wheels and tyres 509

Notes on snow chains 509

Activating or deactivating snow chain mode 510

Tyre pressure 510

Wheel change 515

Emergency spare wheel 524

Technical data 526

Notes on technical data 526

On-board electronics 526

Regulatory radio information 528

Vehicle identification plate, VIN and engine number overview 630

Operating fluids 632

Vehicle data 640

Trailer hitch 641

Display messages and warning/indicator

lamps 644

Display messages 644

Warning and indicator lamps 729

Index 749

In this Owner's Manual, you will find the following symbols:

⚠ WARNING Danger due to not observing the warning notices

Warning notices draw your attention to hazards that may endanger your health or life, or the health or life of others.

▶ Observe the warning notices.

🌿 ENVIRONMENTAL NOTE Environmental damage due to failure to observe environmental notes

Environmental notes include information on environmentally responsible behaviour or environmentally responsible disposal.

▶ Observe environmental notes.

! NOTE Damage to property due to failure to observe notes on material damage

Notes on material damage inform you of risks which may lead to your vehicle being damaged.

▶ Observe notes on material damage.

i These symbols indicate useful instructions or further information that could be helpful to you.

▶ Instruction

(→ page) Further information on a topic

Display Display in the central display







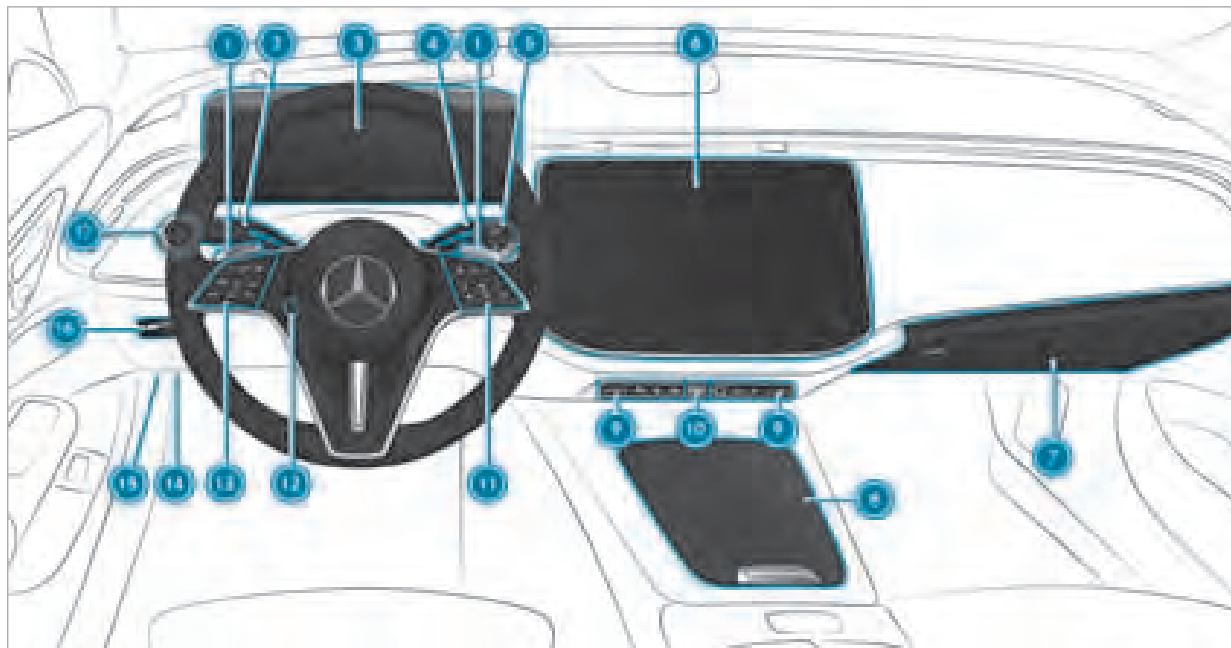





↪ Highest menu level, which is to be selected in the multimedia system

➤➤ Relevant submenus, which are to be selected in the multimedia system

* Indicates a cause







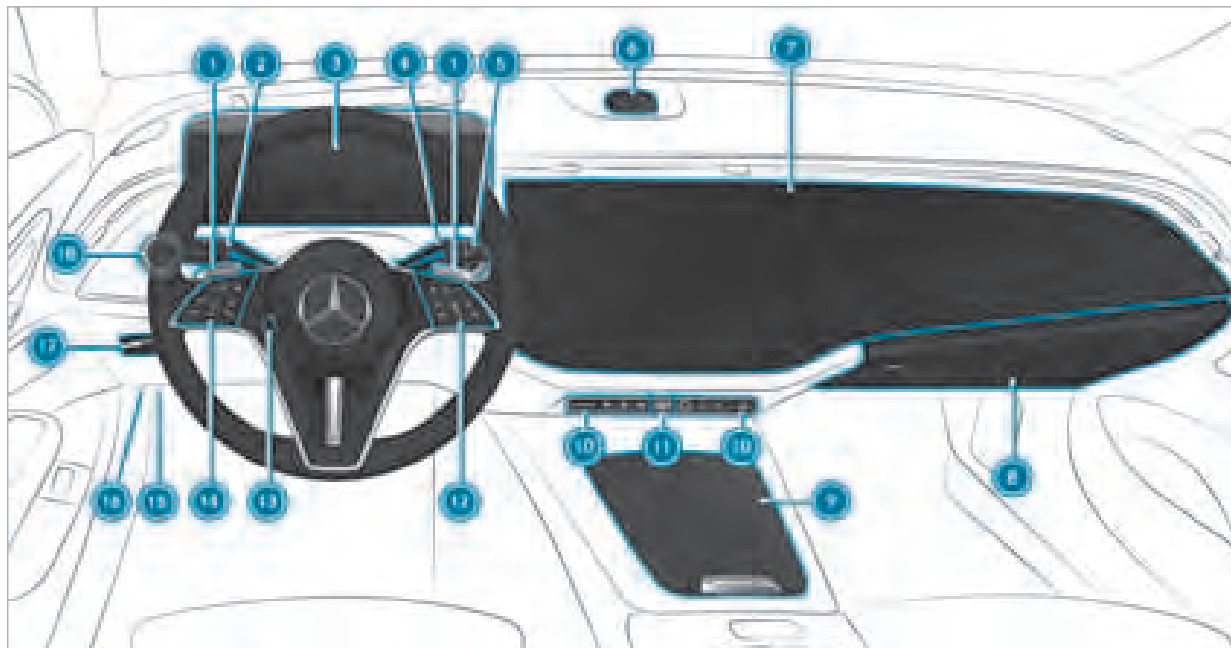







Left-hand-drive vehicles

①	Steering wheel gearshift paddles	→	201		Switches the MBUX multimedia system on/off	→	323	
②	Combination switch	→	149		Switches sound on/off	→	342	
③	Driver's display	→	305		Adjusts the volume			
④	DIRECT SELECT lever	→	196	⑩		Hazard warning light system	→	150
⑤	 Start/stop button	→	182	⑪	Control panel for the MBUX multimedia system	→	332	
	 ECO start/stop function	→	192	⑫	Adjusts the steering wheel	→	124	
⑥	Central display	→	323	⑬	Control panel:			
⑦	Glove compartment	→	131		Driver's display	→	305	
⑧	Stowage compartment	→	131		Cruise control or variable limiter	→	225	
⑨	Switch panel for:					Active Distance Assist DISTRONIC	→	231
	 DYNAMIC SELECT button	→	195	⑭	Diagnostics connection	→	32	
	 Active Parking Assist	→	277	⑮	Opening the bonnet	→	471	
	 Switches the stationary heater on/off	→	177	⑯	 Electric parking brake	→	211	
	 Quick vehicle access			⑰	Light switch	→	147	
	 Fingerprint sensor	→	334					







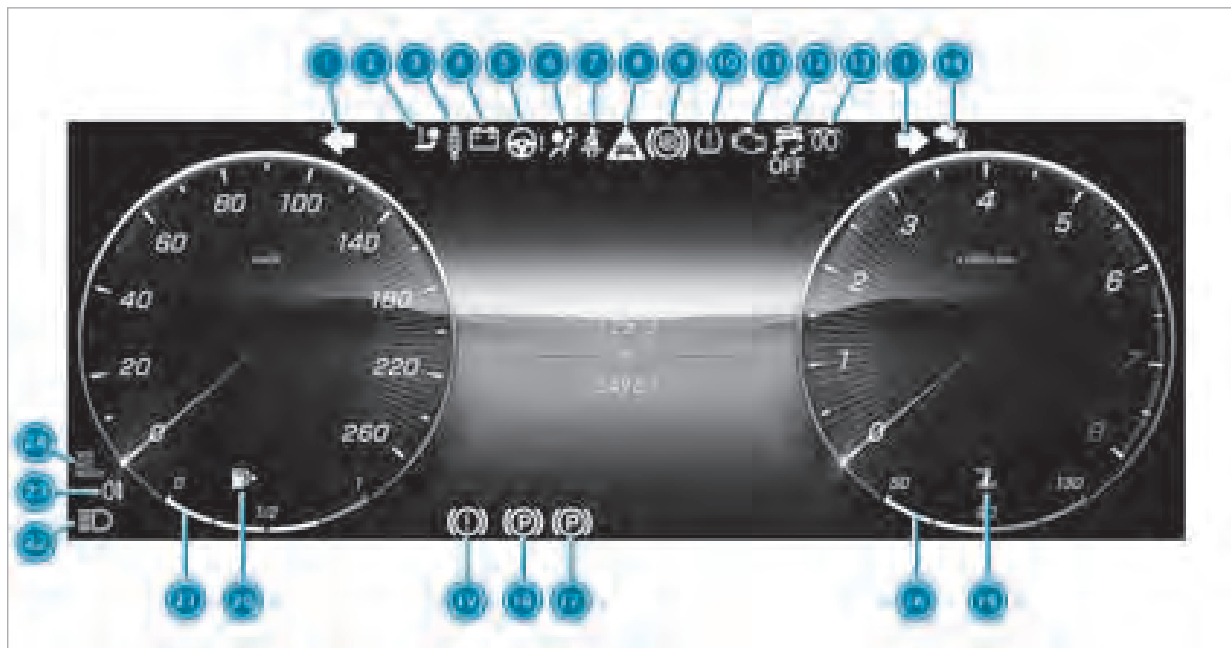

























Left-hand-drive vehicles

①	Steering wheel gearshift paddles	→	201	 Quick vehicle access		
②	Combination switch	→	149	 Fingerprint sensor	→	334
③	Driver's display	→	305	 Switches the MBUX multimedia system on/off	→	323
④	DIRECT SELECT lever	→	196	 Switches sound on/off	→	342
⑤	 Start/stop button	→	182	 Adjusts the volume		
	 ECO start/stop function	→	192	⑪  Hazard warning light system	→	150
⑥	Selfie and video camera			⑫ Control panel for the MBUX multimedia system	→	332
⑦	MBUX hyperscreen with:			⑬ Adjusts the steering wheel	→	124
	Central display			⑭ Control panel:		
	Front passenger display			Driver's display	→	305
⑧	Glove compartment	→	131	Cruise control or variable limiter	→	225
⑨	Stowage compartment	→	131	 Active Distance Assist DISTRONIC	→	231
⑩	Switch panel for:			⑮ Diagnostics connection	→	32
	 DYNAMIC SELECT button	→	195	⑯ Opens the bonnet	→	471
	 Active Parking Assist	→	277	⑰  Electric parking brake	→	211
	 Switches the stationary heater on/off	→	177	⑱ Light switch	→	147







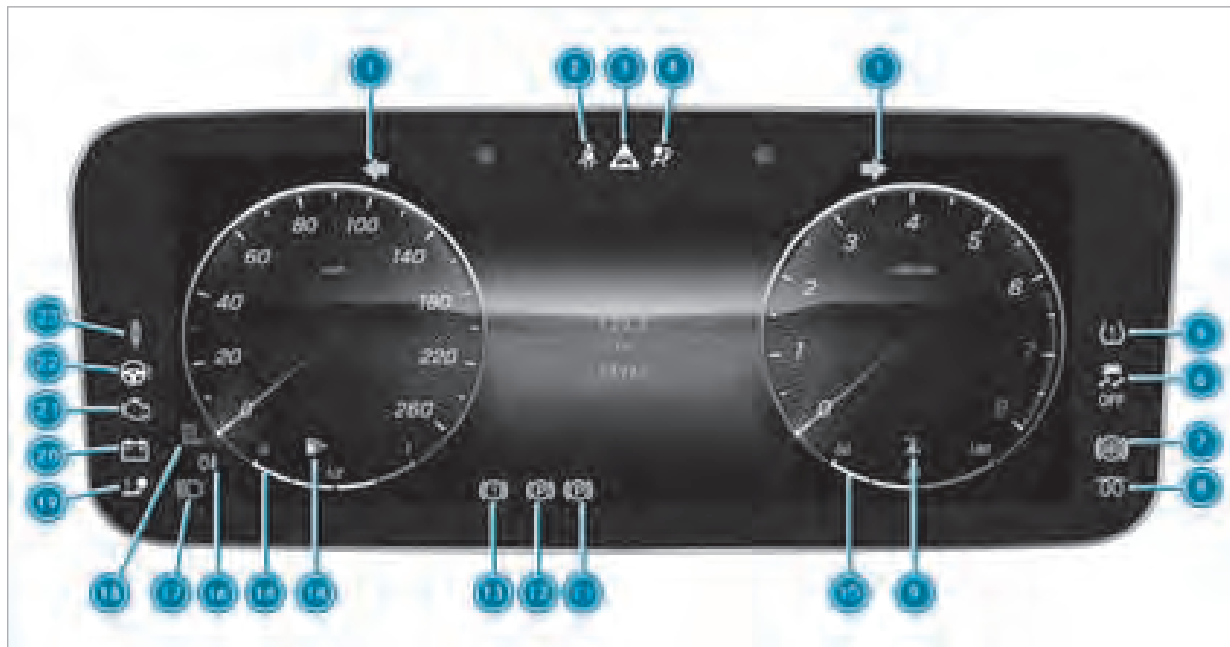























Driver's display







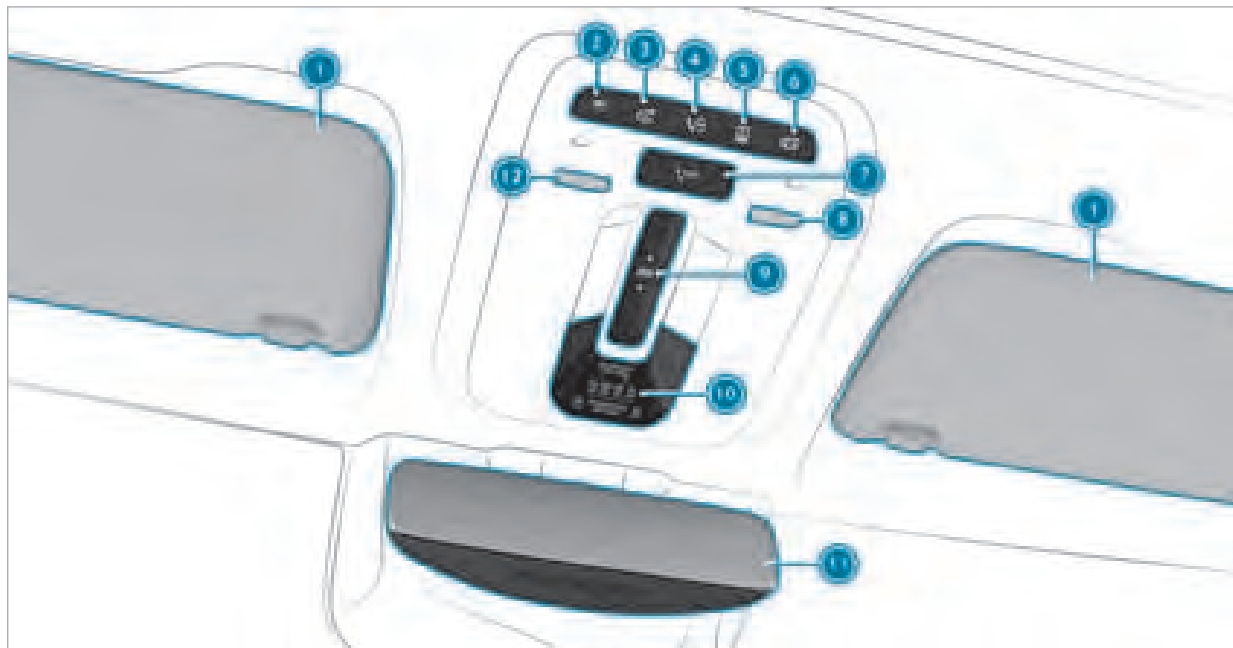

1		Turn signal lights	→	149			
2		Trailer hitch	→	733			
3		Suspension (red)	→	741			
		Suspension (yellow)	→	741			
4		Electrical fault	→	735			
5		Power steering (red)	→	733			
		Power steering (yellow)	→	733			
		Rear-axle steering (red)	→	733			
		Rear-axle steering (yellow)	→	733			
6		Restraint system	→	731			
7		Seat belt	→	731			
8		Distance warning	→	741			
9		ABS	→	741			
10		Tyre pressure monitoring system	→	747			
11		Engine diagnostics	→	735			
12		ESP® OFF	→	741			
		ESP®	→	741			
13		Diesel engine: preglow					
14		Petrol engine: reduced power	→	196			
15		Coolant temperature	→	735			
16		Coolant temperature display	→	308			
17		Electric parking brake (yellow)	→	739			
18		Electric parking brake (red)	→	739			
19		Brakes (red)	→	739			
		Brakes (yellow)	→	739			
20		Reserve fuel with fuel filler flap location indicator	→	735			
21		Fuel level	→	308			
22		High beam	→	149			
		Low beam	→	147			
		Parking lights	→	147			
23		Rear fog light	→	148			
24		Mercedes-Benz emergency call system	→	746			











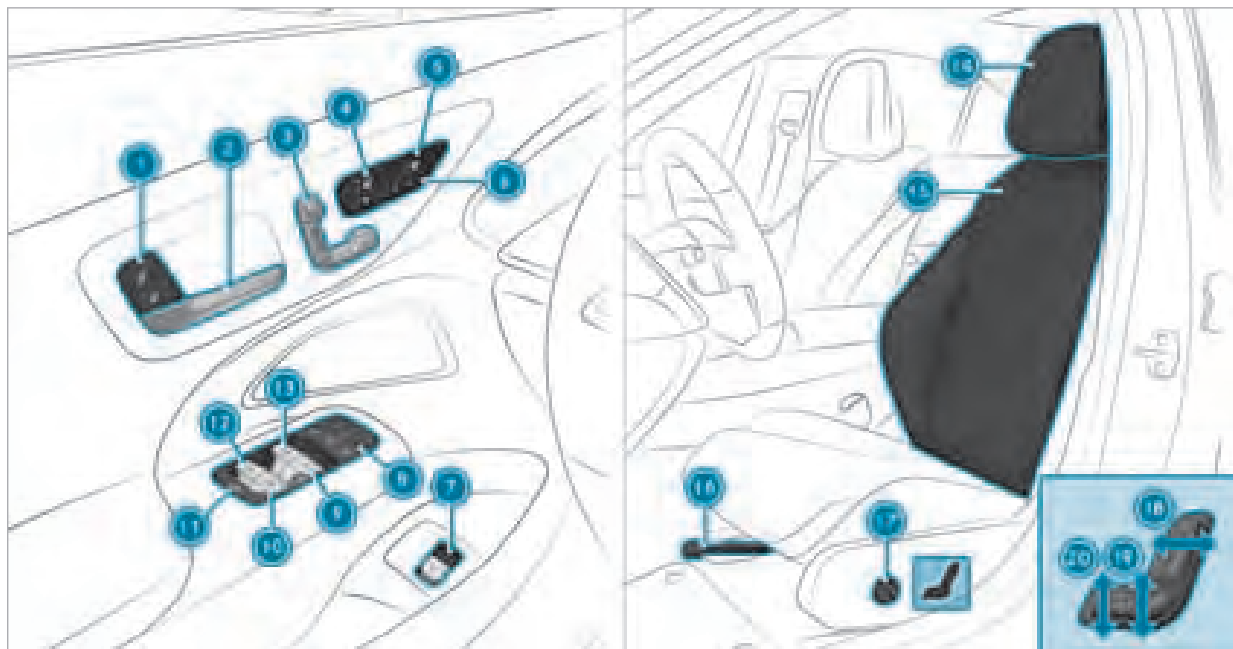



Driver's display with driver camera

1		Turn signal lights	→	149	15	Fuel level	→	308	
2		Seat belt	→	731	16		Rear fog light	→	148
3		Distance warning	→	741	17		High beam	→	149
4		Restraint system	→	731			Low beam	→	147
5		Tyre pressure monitoring system	→	747			Parking lights	→	147
6		ESP® OFF	→	741	18		Mercedes-Benz emergency call system	→	746
		ESP®	→	741	19		Trailer hitch	→	733
7		ABS	→	741	20		Electrical fault	→	735
8		Diesel engine: preglow			21		Engine diagnostics	→	735
9		Coolant temperature	→	735	22		Power steering (red)	→	733
10		Coolant temperature display	→	308			Power steering (yellow)	→	733
11		Electric parking brake (yellow)	→	739			Rear-axle steering (red)	→	733
12		Electric parking brake (red)	→	739			Rear-axle steering (yellow)	→	733
13		Brakes (red)	→	739	23		Suspension (red)	→	741
		Brakes (yellow)	→	739			Suspension (yellow)	→	741
14		Reserve fuel with fuel filler flap location indicator	→	735					





①	Sun visors		
②	 Switches the front interior lighting on/off	→	159
③	 Switches the rear interior lighting on/off	→	159
④	 me button	→	429
⑤	 Opens/closes the panorama sliding sun-roof rear roller sunblind	→	102
⑥	 Switches automatic interior lighting control on/off	→	159
⑦	 SOS button	→	429
⑧	Switches the right-hand reading lamp on/off	→	159
⑨	 Opens/closes the panorama sliding sun-roof	→	102
	 Opens/closes the panorama sliding sun-roof front roller sunblind	→	102
⑩	Indicator lamps:		
	PASSENGER AIR BAG	→	49
	REAR SEAT AIR BAG		
⑪	Inside rear-view mirror	→	165
⑫	Switches the left-hand reading lamp on/off	→	159

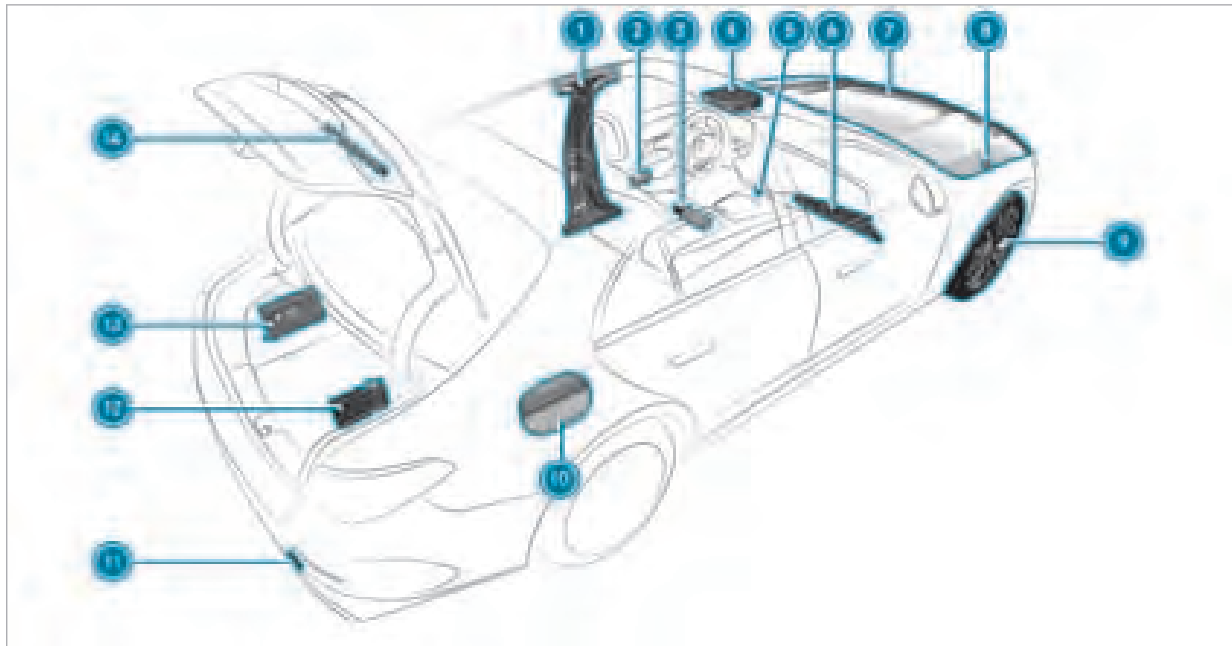

①	 	Locks/unlocks the vehicle	→	86	⑫		Opens/closes the rear left side window	→	99
②		Opens the door	→	86	⑬		Opens/closes the left side window	→	99
③		Adjusts the seats electrically	→	114	⑭		Adjusting the head restraints	→	117
④		Switching the seat heating on/off	→	121	⑮		Seat adjustment using the multimedia system	→	120
⑤		Switching the seat ventilation on/off	→	123	⑯		Adjusts the seat fore-and-aft position	→	112
⑥		Operating the memory function	→	128	⑰		Adjusting the 4-way lumbar support	→	117
⑦		Opens/closes the tailgate	→	93	⑱		Adjusting the seat backrest inclination	→	112
⑧		Operating the outside mirrors	→	164	⑲		Adjusting the seat height	→	112
⑨		Opens/closes the right side window	→	99	⑳		Adjusts the seat cushion inclination	→	112
⑩		Opens/closes the rear right side window	→	99					
⑪		Child safety lock for the rear side windows	→	73					



① B-pillar with: QR code for accessing the rescue card	→	35	⑧ Tow-starting or towing away	→	499
② Safety vests	→	485	⑨ Flat tyre	→	487
③ Fire extinguisher	→	487	⑩ Fuel filler flap with: information label on fuel type	→	203
④  me button	→	429	information label on tyre pressure	→	511
 SOS button	→	429	QR code for accessing the rescue card	→	35
⑤  Hazard warning lights	→	150	⑪ Tow-starting or towing away	→	499
⑥ Stowage compartment for customer literature			⑫ TIREFIT kit	→	488
⑦ To check and top up operating fluids	→	632	⑬ First-aid kit (soft sided)	→	486
Starting assistance	→	496	⑭ Warning triangle	→	486

Calling up the Digital Owner's Manual

Multimedia system:

- ➔  ➔ Settings ➔ Info
- ➔ Owner's Manual
- ➔ Open Digital Owner's Manual

The Digital Owner's Manual describes the functions and operation of the vehicle and the multimedia system.

- ▶ Select one of the following menu items in the Digital Owner's Manual:
 - **Quick start:** find the first steps towards adjusting your seat (driver's side).
 - **Tips:** find information that prepares you for certain everyday situations with your vehicle.
 - **Animations:** watch animations of the vehicle functions.
 - **Messages:** receive additional information about the messages in the driver's display.
 - **Language:** select the language for the Digital Owner's Manual.

You can search for keywords using the search field **Search**, in order to find quick answers to questions about the operation of the vehicle.



- ① Menu
- ② Search
- ③ Back
- ④ Contents section

Some sections in the Digital Owner's Manual, such as warning notes, can be expanded and collapsed.

Additional methods of calling up the Digital Owner's Manual:

Driver's display: call up brief information as display messages in the driver's display

MBUX Voice Assistant: call up via the voice control system

For safety reasons, the Digital Owner's Manual is deactivated while driving.

Protection of the environment

 **ENVIRONMENTAL NOTE** Environmental damage due to operating conditions and personal driving style

The pollutant emission of the vehicle is directly related to the way you operate the vehicle.

Operate your vehicle in an environmentally responsible manner to help protect the environment. Please observe the following recommendations on operating conditions and personal driving style.

Operating conditions:

- ▶ Make sure that the tyre pressure is correct.
- ▶ Do not carry any unnecessary weight (e.g. roof luggage racks once you no longer need them).
- ▶ Adhere to the service intervals. A regularly serviced vehicle will contribute to environmental protection.

- ▶ Always have maintenance work carried out at a qualified specialist workshop.

Personal driving style:

- ▶ Do not depress the accelerator pedal when starting the engine.
- ▶ Do not warm up the vehicle while stationary.
- ▶ Drive carefully and maintain a suitable distance from the vehicle in front.
- ▶ Avoid frequent, sudden acceleration and braking.
- ▶ Change gear in good time and use each gear only up to $\frac{2}{3}$ of its maximum engine speed.
- ▶ Switch off the vehicle in stationary traffic, e.g. by using the ECO start/stop function.
- ▶ Drive in a fuel-efficient manner. Observe the ECO display for an economical driving style.

Take-back of end-of-life vehicles

EU countries only:

Mercedes-Benz will take back your end-of-life vehicle for environment-friendly disposal in accordance with the European Union (EU) End-Of-Life Vehicles Directive.

A network of vehicle take-back points and dismantlers has been established for you to return your vehicle. You can leave it at any of these points free of charge. This makes an important contribution to closing the recycling circle and conserving resources.

For further information about the recycling and disposal of end-of-life vehicles, and the take-back conditions, please visit the national Mercedes-Benz website for your country.

Mercedes-Benz GenuineParts



ENVIRONMENTAL NOTE Environmental damage caused by not using recycled reconditioned components

Mercedes-Benz AG offers recycled reconditioned components and parts with the same quality as new parts. The same entitlement from the implied warranty is valid as for new parts.

- ▶ Recycled reconditioned components and parts from Mercedes-Benz AG.



NOTE Impairment of the operating efficiency of the restraint systems from installing accessory parts or from repairs or welding

Airbags and seat belt tensioners, as well as control units and sensors for the restraint systems, may be installed in the following areas of your vehicle:

- doors

- door pillars
- Sill
- Seats
- Cockpit
- Driver's display
- Centre console
- lateral roof frame

▶ Do not install accessory parts such as audio systems in these areas.

▶ Do not carry out repairs or welding.

▶ Have accessories retrofitted at a qualified specialist workshop.

You could jeopardise the operating safety of your vehicle if you use parts, tyres and wheels as well as accessories relevant to safety that have not been approved by Mercedes-Benz. Safety-critical systems (e.g. the brake system) may malfunction. Use only Mercedes-Benz GenuineParts or parts of equal quality. Use only tyres, wheels and accessory parts that have been specifically approved for your vehicle model.

Mercedes-Benz tests original parts and conversion parts and accessory parts that have been specifically approved for your vehicle model for their reliability, safety and suitability. Despite ongoing market research, Mercedes-Benz is unable to assess other parts. Mercedes-Benz therefore accepts no responsibility for the use of such parts in Mercedes-Benz vehicles, even if they have been officially approved or independently approved by a testing centre.

Certain parts are officially approved for installation or modification only if they comply with legal requirements. All Mercedes-Benz GenuineParts meet the approval requirements. The use of non-approved parts may invalidate the vehicle's general operating permit.

This is the case in the following situations:

- The vehicle type is different from that for which the vehicle's general operating permit was granted.
- Other road users could be endangered.
- The exhaust gas or noise level gets worse.

Always specify the vehicle identification number (VIN) (→ page 630) when ordering Mercedes-Benz GenuineParts.

Touch-sensitive controls

In addition to conventional switches and buttons, your vehicle is equipped with touch-sensitive controls.

These are located in the following areas of your vehicle:

- Roof and door control panel
- Climate control
- Steering wheel
- MBUX multimedia system

The controls have touch-sensitive user interface surfaces. The surfaces are controlled by pressing or swiping to adjust settings or to trigger functions, for example.

In the area of the touchscreen, you also receive haptic feedback in the form of a pulse or a vibration, or the surface structure changes on the

touch-sensitive user interface surface, for example.

You receive haptic feedback in the following situations, for example:

- When pressing a button on the user interface surface
- When scrolling in a list or table
- When reaching a new area on the user interface surface, e.g. a pop-up window

When handling touch-sensitive user interface surfaces, observe the following points to avoid problems operating:

- Do not affix stickers or similar objects on the surfaces
- Keep the surfaces protected from moisture and wet conditions.
- Keep the surfaces free of dust and dirt (→ page 482).

Some touch-sensitive control elements have a symbol and integrated indicator lamps. When operating, make sure to press on the symbol of the control element.

Mercedes me App

Notes about the on-demand feature

You can also activate various functions (on-demand feature) subsequently via Mercedes me after purchasing your vehicle.

Information is available at any Mercedes-Benz Service Centre.

Activating on-demand feature using Mercedes me

Requirements:

- The vehicle has a wireless connection.
- The vehicle is linked to the Mercedes me user account.

Ordering and activating on-demand feature

- ▶ Add the desired on-demand feature for the vehicle to the shopping basket in the Mercedes me Store.
- ▶ Complete the order.
The on-demand feature is activated when operating the vehicle.

Speeding up activation

- ▶ Switch the vehicle off and lock it.
- ▶ Unlock the vehicle after about two minutes and switch on the vehicle. The on-demand feature has been activated. For some features, a notification also appears in the vehicle's multimedia system.

If the activation was not successful, repeat the process.

Operating safety

⚠ WARNING Risk of accident due to malfunctions or system failures

If you do not have the prescribed service/maintenance work or any required repairs carried out, this could result in malfunctions or system failures.

- ▶ Always have the prescribed service- and maintenance work or any required repairs carried out in a qualified workshop.

⚠ WARNING Risk of accident or injury due to improper modifications to electronic components

Modifications to electronic components, their software or wiring can impair their functionality and/or the functionality of other networked components or safety-relevant systems.

This can endanger the vehicle's operating safety.

- ▶ You must not tamper with wiring, electronic components, or their software.
- ▶ Always have work on electrical and electronic devices carried out at a qualified specialist workshop.

If you modify the on-board electronics, the general operating permit is rendered invalid.

Observe the "On-board electronics" section in "Technical data".

⚠ WARNING Risk of fire due to flammable material coming into contact with hot parts of the exhaust system

If combustible materials, e.g. leaves, grass or twigs, come into contact with hot parts of the exhaust system, they may ignite.

- ▶ When driving off-road or on unpaved surfaces, check the underside of the vehicle at regular intervals.
- ▶ In particular, remove any trapped parts of plants or other flammable material.
- ▶ If damage should occur, immediately inform a qualified specialist workshop.

! **NOTE** Damage to the vehicle due to driving too fast and due to impacts to the vehicle underbody or suspension components

In the following situations, in particular, there is a risk of damage to the vehicle:

- the vehicle becomes grounded, e.g. on a high kerb or an unpaved road
- the vehicle is driven too fast over an obstacle, e.g. a kerb, speed bump or pothole
- a heavy object strikes the underbody or suspension components

In situations such as these, damage to the body, underbody, suspension components, wheels or tyres may not be visible. Components damaged in this way can unexpectedly fail or, in the case of an accident, may no longer absorb the resulting force as intended.

If the underbody panelling is damaged, flammable materials such as leaves, grass or twigs can collect between the underbody and the underbody panelling. These materials may

ignite if they come into contact with hot parts of the exhaust system.

▶ Have the vehicle checked and repaired immediately at a qualified specialist workshop.

or

▶ If driving safety is impaired while continuing your journey, pull over and stop the vehicle immediately, while paying attention to road and traffic conditions, and contact a qualified specialist workshop.

Vehicles with a 48 V on-board electrical system

⚠ DANGER Risk of fatal injury by touching damaged high-voltage components

Vehicles with a 48 V on-board electrical system contain individual high-voltage components. These high-voltage components are under high voltage.

If you modify component parts of these high-voltage components or touch damaged component parts, you may be electrocuted.

High voltage components may be damaged in an accident, although the damage may not be visible.

- ▶ Never perform modifications to component parts of high-voltage components.
- ▶ Never touch damaged component parts of high-voltage components.
- ▶ Never touch component parts of high-voltage components after an accident.

Vehicles with a 48 V on-board electrical system contain high-voltage components. These components are marked with a high-voltage label:

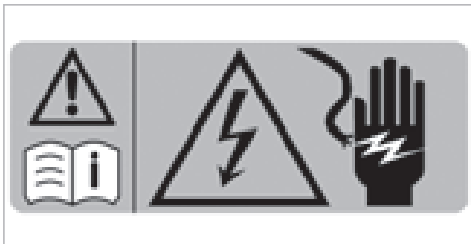

All work on high voltage components must be carried out at a qualified specialist workshop.

Notes on assembling the number plate on the front licence plate holder

! **NOTE** Malfunctions and system failures due to incorrect assembly of the licence plate on the front licence plate holder

If the licence plate is incorrectly assembled on the front licence plate holder, sensors, cameras or driving and safety systems may malfunction or fail.

Observe the following points when assembling the licence plate on the front licence plate holder:

- ▶ Assemble the licence plate directly on the licence plate holder without advertising media or other holders.
- ▶ Assemble the licence plate so that it does not protrude above or to the side of the licence plate adapter.

Declarations of conformity and notes on driving in different countries

Electromagnetic compatibility

The electromagnetic compatibility of the vehicle components has been checked and certified according to the currently valid version of Regulation UN-R 10.

National information for components subject to radio regulations

Only for EU and EFTA countries and countries that recognise the EU manufacturer's declaration of conformity:



The following information applies to all wireless components of the vehicle and of the information systems and communication devices integrated in the vehicle:

The manufacturers of the wireless components ensure that all wireless components installed in the vehicle comply with Directive 2014/53/EU. The full texts of the EU declarations of conformity are available at the following web address:

https://moba.i.mercedes-benz.com/markets/ece-row/baix/cars/certificates-of-conformity/en_GB/index.html



You can obtain further information from a Mercedes-Benz service centre.

For Israel only:

It is prohibited to make any change to a vehicle-installed radio component that could affect the wireless specifications of the device, including software changes, replacement of the original antenna, or adding the option to connect the device to an external antenna, without first obtain-

ing approval from the Communications Ministry, because of concern about wireless interference.

For the United Kingdom only:



The following information applies to all wireless components of the vehicle and of the information systems and communication devices integrated in the vehicle:

The manufacturers of the radio components declare that all radio equipment installed in the vehicle is in compliance with the relevant statutory requirements. The full texts of the declarations of conformity are available at the following web address:

https://moba.i.mercedes-benz.com/markets/ece-row/baix/cars/certificates-of-conformity/en_GB/index.html



For Brazil only:



Note on two-way radio systems in the vehicle:

These systems are not protected against harmful interference and must not cause interference in properly approved systems.

For Jamaica only:

All wireless vehicle components have received type approval from the SMA.

For Nigeria only:

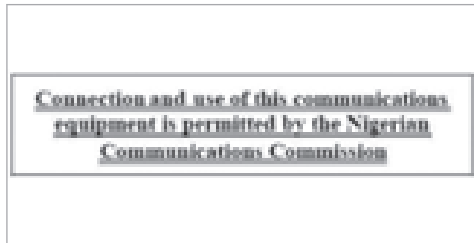

Connection and use of the radio communications equipment in this vehicle is permitted by the Nigerian Communications Commission

For Russia only:



The manufacturers of the wireless components installed in the vehicle hereby declare that all wireless components installed in the vehicle comply with the technical regulations for two-way radios. You can obtain further information from a Mercedes-Benz service centre.

For Ukraine only:



The manufacturers of the wireless components installed in the vehicle hereby declare that the wireless components installed in the vehicle comply with the technical regulations for two-way radios. You can obtain further information from a Mercedes-Benz service centre.

Jack

Copy and translation of the original declaration of conformity:

EC declaration of conformity

1.

The undersigned, representing
Manufacturer:

BRANO a.s.

747 41 Hradec nad Moravicí, Opavská 1000,
The Czech Republic

ID No.: 64-387-5933

VAT No.: CZ64-387-5933

herewith declares under our sole responsibility
that the product:

2. a)

Name:

Jack

Type, Number:

A) A 164 580 02 18, A 166 580 01 18

B) A 240 580 00 18

C) A 639 580 02 18

D) A 639 580 03 18

E) A 910 580 00 00

F) A 247 580 00 00, A 293 580 00 00

G) A 247 580 01 00, A 293 580 01 00

H) A 247 580 02 00, A 293 580 02 00

Year of manufacture: 2022

Complies with all relevant provisions

Directive No. 2006/42/EC

b)

Description and purpose of use:

Car jack is intended solely for lifting of the concrete car, in accordance with the instruction label on the car jack.

3.

References of harmonized and other standards or specifications

ISO 4063, EN ISO 14341-A, AS 2693, DBL 8230.10, DBL 7382.20, DBL 7392.10, DBL 8451.15, MBN 10435,

Technical documentation of the product is stored at the premise of the manufacturer. The person responsible for assembling the technical documentation of the product: Head of the Technical Department Brano a.s.

4.

Hradec nad Moravicí

Place

5.

14.03.2022

Date

Dipl. Engineer Michal Koberský

[Signature]

Director SBU-CJ

TIREFIT kit

Copy and translation of the original declaration of conformity:

EC declaration of conformity

In accordance with EC Directive 2006/42/EC

We hereby declare that the product

Product designation: Daimler electric air pump

Model designation: 0872, DT/UW 200077 - IBK-LK2P

MB part no.: A 000 583 9204

complies with the following relevant regulations:

2014/30/EU

Applied harmonised standards, in particular:

DIN EN 55014-1: 2017

DIN EN 55014-2: 2015

Manufacturer: Dunlop Tech GmbH

Address: Offenbacher Landstrasse. 8, 63456 Hanau

Authorised representative: IMS dept.

Date: March 2020

Signature: IMS-AE, IMS-AE-L

Diagnostics connection

The diagnostics connection is a technical interface in the vehicle. It is used, for example, during repair and maintenance work or for reading out vehicle data in a specialist workshop. Diagnostic devices should therefore only be connected in a qualified specialist workshop.

⚠ WARNING Risk of accident due to connecting devices to the diagnostics connection

If you connect devices to the diagnostics connection of the vehicle, the function of vehicle systems and operating safety may be impaired.

- ▶ For safety reasons, we recommend that you only use and connect products approved by a Mercedes-Benz service centre.

⚠ WARNING Risk of accident due to objects in the driver's footwell

Objects in the driver's footwell may impede pedal travel or block a depressed pedal.

This jeopardises the operating and road safety of the vehicle.

- ▶ Stow all objects in the vehicle securely so that they cannot get into the driver's footwell.
- ▶ Always fit the floor mats securely and as prescribed in order to ensure that there is always sufficient room for the pedals.
- ▶ Do not use loose floor mats and do not place floor mats on top of one another.

! NOTE Battery discharging from using devices connected to the diagnostics connection

Using devices at the diagnostics connection drains the battery.

- ▶ Check the charge level of the battery.

- ▶ If the charge level is low, charge the battery, e.g. by driving a considerable distance.

Please also note the information about the 12 V battery and short-distance trips in the "Driving and Parking" chapter (→ page 187).

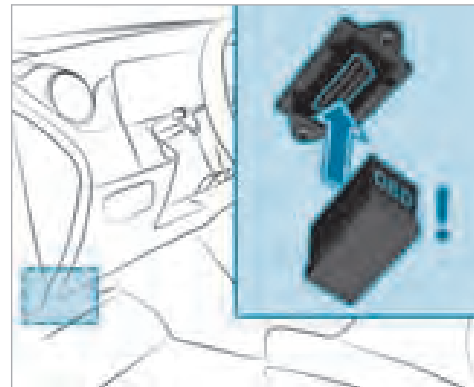

Connecting and using another device with the diagnostics connection can have the following effects:

- Malfunctions in the vehicle system
- Permanent damage to vehicle components

Please refer to the warranty terms and conditions for this matter.

Moreover, connecting equipment to the diagnostics connection can lead to emissions monitoring information being reset, for example. This may lead to the vehicle failing to meet the requirements of the next emissions inspection during the main inspection.

Qualified specialist workshop

A qualified specialist workshop has the necessary special skills, tools and qualifications to correctly carry out any necessary work on your vehicle. This particularly applies to safety-relevant work.

Always have the following work carried out on your vehicle at a qualified specialist workshop:

- Safety-relevant work

- Service and maintenance work
- Repair work
- Modifications as well as installations and conversions
- Work on electronic components
- **Vehicles with 48 V on-board electrical system:** work on the high-voltage component of the 48 V on-board electrical system

Mercedes-Benz recommends a Mercedes-Benz service centre.

Vehicle registration

Mercedes-Benz may ask its service centres to carry out technical inspections on certain vehicles. The quality or safety of the vehicle is improved as a result of the inspection.

Mercedes-Benz can only inform you about vehicle checks if Mercedes-Benz has your registration data.

It is possible that your vehicle has not yet been registered in your name in the following cases:

- if your vehicle was not purchased at an authorised specialist dealer.
- if your vehicle has not yet been examined at a Mercedes-Benz service centre.

It is advisable to register your vehicle with a Mercedes-Benz service centre.

Inform Mercedes-Benz as soon as possible about any change in address or vehicle ownership. You can do this at a Mercedes-Benz service centre, for example.

Correct use of the vehicle

If you remove any warning stickers, you or others could fail to recognise certain dangers. Leave warning stickers in position.

Observe the following information in particular when driving your vehicle:

- the safety notes in this Owner's Manual, vehicle-specific supplements and further supplementary documents

- technical data for the vehicle
- traffic rules and -regulations
- laws and safety standards pertaining to motor vehicles

Information on the REACH regulation

EU and EFTA countries only:

the REACH regulation (Regulation (EC) No. 1907/2006, Article 33) stipulates a duty to supply information about substances of very high concern (SVHCs).

Mercedes-Benz AG acts to the best of its knowledge to prevent these SVHCs from being used and to enable customers to safely handle these substances. There are SVHCs known to Mercedes-Benz AG, according to supplier information and internal product information, found in individual components of this vehicle in quantities of over 0.1 percent by weight.

Further information can be obtained at the following addresses:

- <https://reach.daimler.com/de/home/>

- <https://reach.daimler.com/en/home/>

Notes for persons with electronic medical aids

Mercedes-Benz AG cannot, despite carefully developing vehicle systems, completely rule out the interaction of vehicle systems with electronic medical aids such as cardiac pacemakers.

In addition, there are components installed in the vehicle that, regardless of the operating status of the vehicle, can generate magnetic fields on a par with permanent magnets. These fields can be found, for example, in the area around the multimedia and sound system or also in the area of the seats, depending on the vehicle equipment.

For this reason, the following can occur in isolated cases, depending on the aids used:

- Medical aids malfunctioning
- Adverse health effects

Observe the notes and warnings of the manufacturer of the medical aids; if in doubt, contact the device manufacturer and/or your doctor. If there is continuing uncertainty concerning the possibility of medical aids malfunctioning, Mercedes-

Benz AG recommends using only few electrical vehicle systems and/or maintaining a distance from the components.

Only have repairs and maintenance work in the area of the following components carried out at a qualified specialist workshop:

- vehicle components carrying live voltage
- transmission aerials
- multimedia system and sound system

If you have any queries or suggestions, consult a qualified specialist workshop.

Implied warranty

! **NOTE** Damage to the vehicle arising from violation of these operating instructions.

Damage to the vehicle can arise from violation of these operating instructions.

This damage is not covered either by the Mercedes-Benz implied warranty or by the New- or Used-Vehicle Warranty.

▶ Follow the instructions in these operating instructions on proper operation of your vehicle as well as on possible vehicle damage.

QR code for rescue card

QR codes are attached in the fuel filler flap and on the opposite side on the B-pillar. In the event of an accident, rescue services can use the QR code to quickly find the appropriate rescue card for your vehicle. The current rescue card contains the most important information about your vehicle (e.g. the routing of the electric lines) in compact form.

Further information can be obtained at <https://www.mercedes-benz.de/qr-code>

Data storage

Data processing in the vehicle

Electronic control units

Electronic control units are fitted in your vehicle. Control units process data which, for example,

they receive from vehicle sensors, generate themselves or exchange between themselves. Some control units are required for the safe operation of your vehicle, some assist you when driving, such as driver assistance systems, while others enable convenience or infotainment functions.

The following provides you with general information regarding data processing in the vehicle. Additional information regarding exactly which data in your vehicle are collected, saved and transmitted to third parties, and for what purpose, can be found in the information directly related to the functional characteristics in question in their respective operating instructions. This information is also available online and, depending on the vehicle equipment, digitally.

Personal data

Every vehicle is identified by a unique vehicle identification number. Depending on the country, this vehicle identification number can be used by, for example, governmental authorities to determine the identity of the owner. There are other possibilities to use data collected from the vehicle to identify the owner or driver, such as the licence plate number.

Therefore, data generated or processed by control units may be attributable to a person or, under certain conditions, become attributable to a person. Depending on which vehicle data are available, it may be possible to make inferences about, for example, your driving behaviour, your location, your route or your use patterns.

Legal requirements regarding the disclosure of data

If legally required to do so, manufacturers are, in individual cases, legally obliged to provide governmental entities, upon request and to the extent required, data stored by the manufacturer. For example, this may be the case during the investigation of a criminal offence.

Governmental entities are themselves, in individual cases and within the applicable legal framework, authorised to read out data from the vehicle. In the case of an accident, information that can help with an investigation can, therefore, be taken from the airbag control unit, for example.

Operational data in the vehicle

This is data regarding the operation of the vehicle, which have been processed by control units.

This includes the following data, foreexample:

- vehicle status information such as the speed, longitudinal acceleration, lateral acceleration, number of wheel revolutions or the fastened seat belts display
- ambient conditions, such as temperature, rain sensor or distance sensor

Generally, the use of these data is temporary; they will not be stored beyond the period of operation and will only be processed within the vehicle itself. Control units often contain data memories for vehicle keys, foreexample. Their use permits the temporary or permanent documentation of technical information about the vehicle's operating state, component loads, maintenance requirements and technical events or faults.

Depending on the vehicle equipment, the following data are stored:

- operating status of system components, such as fill levels, tyre pressure or battery status
- malfunctions or faults in important system components, such as lights or brakes

- system reactions in special driving situations, such as airbag deployment or the intervention of stability control systems
- information on events leading to vehicle damage

In certain cases, it may be required to store data that would have otherwise been used only temporarily. This may be the case if the vehicle has detected a malfunction, foreexample.

If you use services, such as repair services and maintenance work, stored operational data as well as the vehicle identification number can be read out and used. They can be read out by service network employees, such as workshops and manufacturers or third parties, such as breakdown services. The same is true in the case of warranty claims and quality assurance measures.

In general, the readout is performed via the legally prescribed port for the diagnostics connection in the vehicle. The operational data that are read out document technical states of the vehicle or of individual components and assist in the diagnosis of malfunctions, compliance with warranty obligations and quality improvement. To that end, these

data, in particular information about component loads, technical events, malfunctions and other faults may be transmitted along with the vehicle identification number to the manufacturer. Furthermore, the manufacturer is subject to product liability. For this reason the manufacturer also uses operational data from the vehicle, foreexample, for recalls. These data can also be used to examine the customer's warranty and guarantee claims.

Fault memories in the vehicle can be reset by a service outlet or at your request as part of repair or maintenance work.

Convenience and infotainment functions

You can store convenience settings and individual settings in the vehicle and change or reset them at any time.

Depending on the vehicle equipment, this includes the following settings, foreexample:

- seat and steering wheel positions
- suspension and climate control settings
- individual settings, such as interior lighting

Depending on the selected equipment, you can import data into vehicle infotainment functions yourself.

Depending on the vehicle equipment, this includes the following data, foreexample:

- multimedia data, such as music, films or photos for playback in an integrated multimedia system
- address book data for use in connection with an integrated hands-free system or an integrated navigation system
- entered navigation destinations
- data about the use of Internet services

These data for convenience and infotainment functions may be saved locally in the vehicle or they may be located on a device which you have connected to the vehicle, such as a smartphone, USB flash drive or MP3 player. If you have entered these data yourself, you can delete them at any time.

This data is transmitted from the vehicle to third parties only at your request. This applies, in par-

ticular, when you use online services in accordance with the settings that you have selected.

Smartphone integration (e.g. Android Auto or Apple CarPlay®)

If your vehicle is accordingly equipped, you can connect your smartphone or another mobile end device to the vehicle. You can then control them by means of the control elements integrated in the vehicle. Images and audio from the smartphone can be output via the multimedia system. Certain information is simultaneously transferred to your smartphone. Depending on the type and integration, this includes position data, day/night mode and other general vehicle statuses. For more information please consult the Owner's Manual of the vehicle/infotainment system.

This integration allows the use of selected smartphone apps, such as navigation or music player apps. There is no further interaction between the smartphone and the vehicle; in particular, vehicle data is not directly accessible. The type of additional data processing is determined by the provider of the app being used. Which settings you can make, if any, depends on the specific app and the operating system of your smartphone.

Online services

Wireless network connection

If your vehicle has a wireless network connection, it enables data to be exchanged between your vehicle and additional systems. The wireless network connection is made possible by the vehicle's own transmitter and receiver or by a mobile end device that you have brought into the vehicle, foreexample, a smartphone. Online functions can be used via the wireless network connection. This includes online services and applications/apps provided to you by the manufacturer or by other providers.

Manufacturer's services

Regarding the manufacturer's online services, the individual functions are described by the manufacturer in a suitable place, foreexample, in the Owner's Manual or on the manufacturer's website, where the relevant data protection information is also given. Personal data may be used for the provision of online services. Data are exchanged via a secure connection, such as the manufacturer's designated IT systems. Any personal data which are collected, processed and

used, other than for the provision of services, is done so exclusively on the basis of legal permission. This is the case, for example, for a legally prescribed emergency call system, a contractual agreement or when consent has been given.

You can have services and functions, some of which are subject to a fee, activated or deactivated. This excludes legally prescribed functions and services, such as an emergency call system.

Third party services

If you use online services from other providers (third parties), these services are the responsibility of the provider in question and subject to that provider's data protection conditions and terms of use. As a general rule, the manufacturer has no influence on the content exchanged.

For this reason, when services are provided by third parties, please ask the service provider in question for information about the type, extent and purpose of the collection and use of personal data.

Data protection rights

Depending on your country or the equipment and range of functions of your vehicle as well as the services you use and the services on offer, you are entitled to different data protection rights. Further information on data protection and your data protection rights can either be found on the manufacturer's website or you will receive this information as part of the various services and service offers. There you will also find the contact information for the manufacturer and its data protection officers.

At a workshop, for example, with the support of a specialist and possibly for a fee, you can have data read out which is stored only locally in the vehicle.

Copyright

Information on licences for free and open-source software used in your vehicle can be found on the data carrier in your vehicle document wallet and with updates on the following website:

<https://www.mercedes-benz.com/opensource>

Restraint system

Protection provided by the restraint system

The restraint system includes the following components:

- Seat belt system
- Airbags
- Child restraint system
- Child seat anchors

The restraint system can help prevent the vehicle occupants from coming into contact with parts of the vehicle interior in the event of an accident. In the event of an accident, the restraint system can also reduce the forces to which the vehicle occupants are subjected.

A seat belt can only provide the best level of protection if it is worn correctly. Depending on the detected accident situation, seat belt tensioners and/or airbags supplement the protection offered by a correctly worn seat belt. Seat belt tensioners and/or airbags are not deployed in every accident.

In order for the restraint system to provide the intended level of protection, each vehicle occupant must observe the following information:

- Fasten seat belts correctly.
- Sit in an almost upright seat position with their back against the seat backrest.
- Sit with their feet resting on the floor, if possible.
- Always secure persons under 1.50 m tall in an additional restraint system suitable for Mercedes-Benz vehicles.

However, no system available today can completely eliminate injuries and fatalities in every accident situation. In particular, the seat belt and airbag generally do not protect against objects penetrating the vehicle from the outside. It is also not possible to completely rule out the risk of injury caused by the airbag deploying.

Limitations of the protection provided by the restraint system

⚠ WARNING Risk of injury or death due to modifications to the restraint system

Vehicle occupants may no longer be protected as intended if alterations are made to the restraint system.

- ▶ Never alter the parts of the restraint system.
- ▶ Never tamper with the wiring or any electronic component parts or their software.

If it is necessary to modify the vehicle to accommodate a person with disabilities, contact a qualified specialist workshop.



Mercedes-Benz recommends that you use driving aids which have been approved for your vehicle by Mercedes-Benz.

Restraint system functionality

When the vehicle is switched on, a self-test is performed, during which the  restraint system warning lamp lights up. It goes out no later than a few seconds after the vehicle is started. The components of the restraint system are then functional.

Malfunctioning restraint system

A malfunction has occurred in the restraint system if:

- the  restraint system warning lamp does not light up when the vehicle is switched on
- the  restraint system warning lamp lights up continuously or repeatedly during a journey

⚠ WARNING Risk of injury due to malfunctions in the restraint system

Components in the restraint system may be activated unintentionally or not deploy as intended in an accident.

▶ Have the restraint system checked and repaired immediately at a qualified specialist workshop.

Function of the restraint system in an accident

How the restraint system works depends on the severity of the impact detected and the apparent type of accident:

- Frontal impact
- Rear impact
- Side impact
- Rollover

The activation thresholds for the components of the restraint system are determined based on the evaluation of the sensor values measured at various points in the vehicle. This process is pre-emptive in nature. The triggering/deployment of the components of the restraint system must take place in good time at the start of the collision.

Factors which can only be seen and measured after a collision has occurred cannot play a deci-

sive role in airbag deployment. Nor do they provide an indication of airbag deployment.

The vehicle may be deformed significantly without an airbag being deployed. This is the case if only parts which are relatively easily deformed are affected and the rate of vehicle deceleration is not high. Conversely, an airbag may be deployed even though the vehicle suffers only minor deformation. If very rigid vehicle parts such as longitudinal members are hit, this may result in sufficiently high levels of vehicle deceleration.

Depending on the detected deployment situation, the components of the restraint system can be activated or deployed independently of each other:

- Seat belt tensioner: frontal impact, rear impact, side impact, rollover
- Driver's airbag, front passenger airbag: frontal impact
- Knee airbag: frontal impact
- Side airbag: side impact
- Centre airbag: side impact

- Window airbag: side impact, rollover, frontal impact
- PRE-SAFE® Impulse Side: side impact

Only when the PASSENGER AIR BAG OFF indicator lamp is off can the front passenger airbag deploy in the event of an accident. If the front passenger seat is occupied, make sure, both before and during the journey, that the status of the front passenger airbag is correct (→ page 49).

⚠ WARNING Risk of burns from hot airbag components

The airbag parts are hot after an airbag has been deployed.

- ▶ Do not touch the airbag parts.
- ▶ Have a deployed airbag replaced at a qualified specialist workshop as soon as possible.

Mercedes-Benz recommends that you have the vehicle towed to a qualified specialist workshop after an accident. Take this into account, particu-

larly if a seat belt tensioner is triggered or an airbag deployed.

If the seat belt tensioners are triggered or an airbag is deployed, you will hear a bang, and a small amount of powder may also be released:

- The bang will not generally affect your hearing.
- In general, the powder released is not hazardous to health but may cause short-term breathing difficulties to persons suffering from asthma or other pulmonary conditions.

Provided it is safe to do so, leave the vehicle immediately or open the window in order to prevent breathing difficulties.

Seat belts

Protection provided by the seat belt

Always fasten your seat belt correctly before starting a journey. A seat belt can only provide the best level of protection if it is worn correctly.

⚠ WARNING Risk of injury or death due to incorrectly fastened seat belt

If the seat belt is not worn correctly, it cannot perform its intended protective function.

In addition, an incorrectly fastened seat belt can also cause injuries, for example, in the event of an accident or when braking or changing direction suddenly.

- ▶ Always ensure that all vehicle occupants have their seat belts fastened correctly and are sitting properly.

Always observe the instructions about the correct driver's seat position and adjusting the seat (→ page 111).

In order for the correctly worn seat belt to provide the intended level of protection, each vehicle occupant must observe the following information:

- The seat belt must not be twisted and must fit tightly and snugly across the body.
- The seat belt must be routed across the centre of the shoulder and as low down across the hips as possible.

- The shoulder section of the seat belt should not touch your neck nor be routed under your arm or behind your back.
- Avoid wearing bulky clothing, e.g. a winter coat.
- Push the lap belt down as far as possible across your hips and pull tight with the shoulder section of the belt. Never route the lap belt across your abdomen.

Pregnant women must also take particular care with this.

- Never route the seat belt across sharp, pointed, abrasive or fragile objects.
- Only one person should use each seat belt at any one time.
- Never secure objects with a seat belt if the seat belt is also being used by one of the vehicle's occupants.

Also ensure that no objects, e.g. a cushion, are ever placed between a person and the seat.

If children are travelling in the vehicle, be sure to observe the instructions and safety notes on "Children in the vehicle" (→ page 54).

Always observe the instructions for loading the vehicle when securing objects, luggage or loads (→ page 129).

Limitations of the protection provided by the seat belt

⚠ WARNING Risk of injury or death due to incorrect seat position

The seat belt will not offer the intended level of protection if you have not moved the seat backrest to an almost vertical position.

In particular, you may slip under the seatbelt and injure yourself.

- ▶ Adjust the seat properly before beginning your journey.
- ▶ Always ensure that the seat backrest is in an almost vertical position and that the shoulder section of your seat belt is

▶ routed across the centre of your shoulder.

⚠ WARNING Risk of injury or death when additional restraint systems are not used for persons with a smaller stature

Persons under 1.50 m tall cannot wear the seat belt correctly without a suitable additional restraint system.

- ▶ Always secure persons under 1.50 m tall in a suitable restraint system.

⚠ WARNING Risk of injury or death due to damaged or modified seat belts

Seat belts cannot provide protection in the following situations:

- the seat belt is damaged, has been modified, is extremely dirty, bleached or dyed
- the seat belt buckle is damaged or extremely dirty

- modifications have been made to the seat belt tensioner, seat belt anchorage or seat belt retractor

Seat belts may sustain non-visible damage in an accident, e.g. due to glass splinters.

Modified or damaged seat belts could tear or fail in the event of an accident, for example.

Modified seat belt tensioners could accidentally trigger or fail to function as intended.

- ▶ Never modify the seat belt system, for example the seat belt, seat belt buckle, seat belt tensioner, seat belt anchorage and seat belt retractor.
- ▶ Make sure that the seat belts are undamaged, not worn and clean.
- ▶ Always have the seat belts checked immediately after an accident at a qualified specialist workshop.

Mercedes-Benz recommends that you use seat belts which have been approved for your vehicle by Mercedes-Benz.

⚠ WARNING Risk of injury or death from deployed pyrotechnic seat belt tensioners

Pyrotechnic seat belt tensioners that have been deployed are no longer operational and are unable to perform their intended protective function.

- ▶ Therefore, have deployed pyrotechnic seat belt tensioners immediately replaced at a qualified specialist workshop.

Mercedes-Benz recommends that you have the vehicle towed to a qualified specialist workshop after an accident.

! NOTE Damage caused by trapping the seat belt

If an unused seat belt is not fully retracted, it may become trapped in the door or in the seat mechanism.

- ▶ Always ensure that an unused seat belt is fully retracted.

Fastening and adjusting seat belts

If the seat belt is pulled quickly or sharply, the seat belt retractor locks. The seat belt strap cannot be pulled out any further.

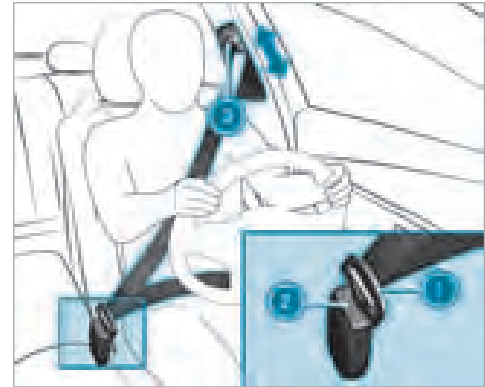

- ▶ Always engage seat belt tongue ① of the seat belt into seat belt buckle ② of the corresponding seat.

▶ **To adjust the seat belt height:** press button  on the seat belt outlet and slide the seat belt outlet to the desired position.

▶ **To engage the seat belt outlet:** release button  and ensure that the seat belt outlet engages.

 A seat belt can only provide the best level of protection if it is worn correctly. Observe the notes on fastening the seat belt (→ page 41).

 **NOTE** Deployment of components of the restraint system when the front passenger seat is unoccupied and a seat belt is buckled

When the front passenger seat is unoccupied and the seat belt tongue of the seat belt is engaged in the seat belt buckle, components of the restraint system may deploy unnecessarily on the front passenger side, e.g. the seat belt tensioner.

▶ Only buckle the seat belts as intended.

 Observe the notes on stowage areas (→ page 129).

Information on fitting a child restraint system and on children travelling in the vehicle can be found in the "Children in the vehicle" section (→ page 58).

Seat belt adjustment function

Vehicles with PRE-SAFE®: after a front seat belt has been fastened, the automatic seat belt adjustment may apply a certain tightening force. Do not hold the seat belt tightly while it is adjusting.

You can activate and deactivate the seat belt adjustment function using the multimedia system (→ page 44).

Activating/deactivating seat belt adjustment via the multimedia system

Multimedia system:

   **Settings**  **Vehicle**

 **Occupant protection**

 Activate or deactivate **Belt adjustment**.

Releasing seat belts

▶ Press the release button in the seat belt buckle and guide the seat belt back with the seat belt tongue.

Seat belt warning function for the driver and front passenger

The  seat belt warning lamp in the driver's display is a reminder that all vehicle occupants must wear their seat belts correctly.

In addition, a warning tone may sound.

As soon as the driver and front passenger fasten their seat belts, the seat belt warning goes out.

Function of the rear seat belt status display

The rear seat belt status display is only available for certain countries.

The rear seat belt status display in the driver's display is a reminder that all vehicle occupants must wear their seat belts correctly.

In addition, a warning tone may sound.

If a person unfastens a seat belt in the rear passenger compartment while the vehicle is in motion, the rear seat belt status display appears again.

Display in the driver's display



Depending on the vehicle equipment, you can determine the status of the rear seat belt by the colour of the seat symbol in the driver's display as follows:

- **Vehicles with seat occupancy recognition in the rear passenger compartment (seat belt warning)**

When the vehicle is switched on, if one of the rear seats is occupied and the seat belt tongue of the rear seat belt is not engaged in the seat belt buckle of the corresponding seat, the status display for the rear seat belt is displayed.

- Grey: the rear seat is unoccupied.
- Green: the seat belt tongue of a rear seat belt is engaged in the seat belt buckle of the displayed seat.
- Red: the seat belt of the person in the rear seat is not fastened.

The seat belt warning goes out as soon as the seat belt of the person in the rear seat is fastened.

- **Vehicles without seat occupancy recognition in the rear passenger compartment**

Every time the vehicle is switched on, the rear seat belt status display informs you for a certain amount of time which rear seat belt is not fastened.

- Grey: the rear seat belt is not fastened.

- Green: the seat belt tongue of a rear seat belt is engaged in the seat belt buckle of the displayed seat.
- Red: the person in the rear seat has unfastened their seatbelt.

Airbags

Overview of airbags

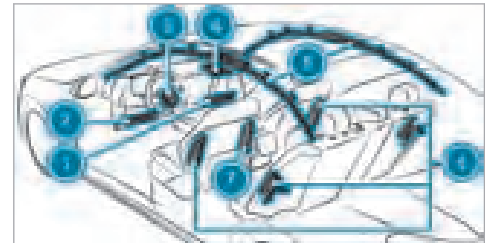

- ① Front passenger knee airbag¹
- ② Driver's knee airbag
- ③ Driver's airbag
- ④ Front passenger airbag

- ⑤ Window airbag
- ⑥ Side airbag
- ⑦ Centre airbag¹⁾

¹⁾ Only for certain countries.

The installation location of an airbag is identified by the AIRBAG symbol. An additional arrow symbol ► indicates the installation location for certain airbags.

When enabled, an airbag can provide additional protection for the respective vehicle occupant.

Potential protection provided by each airbag:

- Knee airbag: thigh, knee and lower leg
- Driver's airbag, front passenger airbag: head and ribcage
- Window airbag: head
- Side airbag: ribcage, also pelvis for front seat occupants
- Centre airbag: head and ribcage

Information on child restraint systems on the front passenger seat

⚠ WARNING Risk of injury or death due to an enabled co-driver airbag

If the co-driver airbag is enabled, a child on the co-driver seat may be struck by the co-driver airbag during an accident.

► NEVER use a rearward-facing child restraint system on a seat with an ENABLED FRONT AIRBAG. DEATH or SERIOUS INJURY to the CHILD can occur.

When fitting a child restraint system to the front passenger seat, observe the vehicle-specific information (→ page 71). Also, always observe the notes on rearward-facing or forward-facing child restraint systems on the front passenger seat (→ page 70).

Information on the automatic front passenger airbag shutoff

Only when the PASSENGER AIR BAG OFF indicator lamp is off can the front passenger airbag deploy in the event of an accident. If the front

passenger seat is occupied, make sure, both before and during the journey, that the status of the front passenger airbag is correct (→ page 49).

! NOTE Deployment of components of the restraint system when the front passenger seat is unoccupied

In an accident, the components of the restraint system may deploy unnecessarily on the front passenger side if:

- There are heavy objects on the front passenger seat.
- The seat belt tongue is engaged in the seat belt buckle of the front passenger seat and the front passenger seat is unoccupied.

- Stow objects in a suitable place.
- Only one person should use each seat belt at any one time.

Depending on the detected accident situation, the window airbag on the front passenger side may deploy. The airbag is deployed regardless of whether the front passenger seat is occupied.

Information on the centre airbag

When triggered, the centre airbag deploys between the front seats. Do not stow any objects in the deployment area of the centre airbag.

Protection provided by the airbags

Depending on the accident situation, an airbag may supplement the protection offered by a correctly fastened seat belt.

⚠ WARNING Risk of injury or death due to an incorrect seat position

If you deviate from the correct seat position, the airbag cannot perform its intended protective function.

Each vehicle occupant must make sure of the following:

- Fasten seat belts correctly. Pregnant women must take particular care to ensure that the lap belt never lies across the abdomen.

- Adopt the correct seat position and keep as far away as possible from the airbags.
- Observe the following information.
 - ▶ Always make sure that there are no objects between the airbag and vehicle occupant.

To avoid the risks resulting from the deployment of an airbag, each vehicle occupant must observe the following information in particular:

- Before starting your journey, adjust your seat correctly; the driver's seat and front passenger seat should be moved as far back as possible.

When doing so, always observe the information on the correct driver's seat position (→ page 111).

- Only hold the steering wheel by the steering wheel rim. This allows the airbag to be fully deployed.
- Always lean against the seat backrest when the vehicle is in motion. Do not lean forwards or against the door or side window. You may

otherwise be in the deployment area of the airbags.

- The occupants must always keep their feet on the floor. Do not put your feet on the cockpit, for example. Your feet may otherwise be in the deployment area of the airbag.
- If children are travelling in the vehicle, observe the additional notes (→ page 54).
- Always stow and secure objects correctly.

Objects in the vehicle interior may prevent an airbag from functioning correctly. Each vehicle occupant must always make sure of the following in particular:

- There are no people, animals or objects between the vehicle occupants and an airbag.
- There are no objects between the seat, door and door pillar (B-pillar).
- There are no hard objects, e.g. coat hangers, hanging on the grab handles or coat hooks.
- There are no accessories, such as mobile navigation devices, mobile phones or cup holders, within the deployment area of an airbag, e.g.

on the cockpit, on the door, on the side window or on the side trim.

In addition, no connecting cables, tensioning straps or retaining straps must be routed or attached to the vehicle within the deployment area of an airbag. Always comply with the accessory manufacturer's installation instructions and, in particular, the notes on suitable places for installation.

- There are no heavy, sharp-edged or fragile objects in the pockets of your clothing. Store such objects in a suitable place.

Limitations of the protection provided by airbags

⚠ WARNING Risk of injury due to modifications to the cover of an airbag

If you modify the cover of an airbag or affix objects such as stickers to it, the airbag can no longer function as intended.

- ▶ Never modify the cover of an airbag.
- ▶ Do not attach any objects to the cover.

The installation location of an airbag is identified by the AIRBAG symbol (→ page 45).

Objects in the deployment area of an airbag may prevent the airbag from functioning correctly.

⚠ WARNING Risk of injury from objects in the deployment area of an airbag

Objects in the deployment area of an airbag can hinder or prevent the correct deployment of the airbag.

The airbag may then deploy in an uncontrolled manner and may even cause additional injuries to the vehicle occupants by deploying. This may be the case in particular if the airbag is integrated into the seat.

- ▶ Always stow and secure objects correctly.
- ▶ Before commencing your journey, make sure that no objects are stowed in the deployment area of an airbag.

Observe the notes on loading the vehicle (→ page 129). When triggered, the centre airbag deploys between the front seats (→ page 45).

⚠ WARNING Risk of injury or death due to the use of unsuitable seat covers

If you use unsuitable seat covers, the airbags cannot protect vehicle occupants as they are designed to do.

In addition, the function of the automatic co-driver airbag shutoff could be restricted.

- ▶ You should only use seat covers that have been approved for the corresponding seats by Mercedes-Benz.

⚠ WARNING Risk of injury due to malfunctioning sensors in the door

The function of the airbags can be impaired due to modifications or incorrect work performed on the doors or door trim, or if the doors are damaged.

- ▶ Never modify the doors or parts of the doors.
- ▶ Always have work on the doors or door trim carried out at a qualified specialist workshop.

⚠ WARNING Risk of injury due to deployed airbag

A deployed airbag no longer offers any protection.

- ▶ Have the vehicle towed to a qualified specialist workshop in order to have the deployed airbag replaced.

Have deployed airbags replaced immediately.

Status of the front passenger front airbag

Function of the PASSENGER AIR BAG indicator lamps



Vehicles without automatic front passenger airbag shutoff have a special sticker affixed to the side of the cockpit on the front passenger side (→ page 69).

Self-test of the automatic front passenger airbag shutoff

When the vehicle is switched on, both the PASSENGER AIR BAG ON and OFF indicator lamps simultaneously light up during the self-test.

The status of the front passenger airbag is displayed after the self-test via the PASSENGER AIR BAG indicator lamps:

- **ON is lit:** the front passenger airbag may deploy during an accident.
The indicator lamp goes out after 60 seconds.
- **ON and OFF are not lit:** the front passenger airbag may deploy during an accident.
- **OFF is lit:** the front passenger airbag is disabled. It will then not be deployed in the event of an accident.

When the PASSENGER AIR BAG ON indicator lamp is off, only the PASSENGER AIR BAG OFF indicator lamp displays the status of the front passenger airbag. The PASSENGER AIR BAG OFF indicator light may be lit continuously or off.

If the PASSENGER AIR BAG OFF indicator lamp and the  restraint system warning lamp light

up simultaneously, the front passenger seat may not be used. Also in this case, do not fit a child restraint system to the front passenger seat. Have the automatic front passenger airbag shutoff checked and repaired immediately at a qualified specialist workshop.

Status display

If the front passenger seat is occupied, ensure, both before and during the journey, that the status of the front passenger airbag is correct for the current situation.

After fitting a rearward-facing child restraint system to the front passenger seat: PASSENGER AIR BAG OFF must be lit continuously.

⚠ WARNING Risk of injury or death when using a rearward-facing child restraint system while the front passenger airbag is enabled

If you secure a child in a rearward-facing child restraint system on the front passenger seat and the PASSENGER AIR BAG OFF indicator lamp is off, the front passenger airbag can deploy in the event of an accident.

The child could be struck by the airbag.

- ▶ Always ensure that the front passenger airbag is disabled. The PASSENGER AIR BAG OFF indicator lamp must be lit.
- ▶ NEVER use a rearward-facing child restraint system on a seat with an ENABLED FRONT AIRBAG. This can result in the DEATH of or SERIOUS INJURY to the CHILD.

When fitting a child restraint system to the front passenger seat, observe the vehicle-specific information (→ page 70).

Depending on the child restraint system and the stature of the child, the PASSENGER AIR BAG OFF indicator lamp may be off. In this case, do not fit the rearward-facing child restraint system to the front passenger seat.

Instead, fit the rearward-facing child restraint system to a suitable rear seat.

After fitting a forward-facing child restraint system to the front passenger seat: depending on the child restraint system and the stature of the child, PASSENGER AIR BAG OFF may be lit continuously

or be off. Always observe the following information.

⚠ WARNING Risk of injury or death due to incorrect positioning of the child restraint system

If you secure a child in a forward-facing child restraint system on the co-driver seat and you position the co-driver seat too close to the dashboard, in the event of an accident, the child could:

- come into contact with the vehicle's interior if the PASSENGER AIR BAG OFF indicator lamp is lit, for example
- be struck by the airbag if the PASSENGER AIR BAG OFF indicator lamp is off

▶ Always move the co-driver seat as far back as possible. In doing so, always make sure that the shoulder belt strap is correctly routed from the seat belt outlet of the vehicle to the shoulder belt guide on the child restraint system. The shoulder belt strap must be routed forwards and downwards from the seat belt outlet.

If necessary, adjust the seat belt outlet and the co-driver seat accordingly.

- ▶ Always comply with the child restraint system manufacturer's installation instructions.

When fitting a child restraint system to the front passenger seat, observe the vehicle-specific information (→ page 70).

If a person is sitting on the front passenger seat: PASSENGER AIR BAG OFF may be lit continuously or be off, depending on the person's stature.

A person on the front passenger seat must always observe the following information:

- If the front passenger seat is occupied by an adult or a person with a stature corresponding to that of an adult, the PASSENGER AIR BAG OFF indicator lamp must be off. This indicates that the front passenger airbag is enabled.

If the PASSENGER AIR BAG OFF indicator lamp is lit continuously, an adult or person with a build corresponding to that of an adult must not use the front passenger seat.

Instead, they should use a rear seat.

- If the front passenger seat is occupied by a person of smaller stature (e.g. a teenager or small adult), the PASSENGER AIR BAG OFF indicator lamp is either lit continuously or remains off, depending on the classification.
 - If the PASSENGER AIR BAG OFF indicator lamp is off: move the front passenger seat as far back as possible, or the person of smaller stature should use a rear seat.
 - If the PASSENGER AIR BAG OFF indicator lamp is lit continuously: the person of smaller stature should not use the front passenger seat.

⚠ WARNING Risk of injury or death when the PASSENGER AIR BAG OFF indicator lamp is lit

If the PASSENGER AIR BAG OFF indicator lamp remains lit after the self-test, the front passenger airbag is disabled.

If the front passenger seat is occupied, always ensure that:

- The classification of the person in the front passenger seat is correct and the front passenger airbag is enabled or disabled in accordance with the person in the front passenger seat.
- The person is seated properly with a correctly fastened seat belt.
- The front passenger seat has been moved as far back as possible.

PRE-SAFE® system

Function of PRE-SAFE® (anticipatory occupant protection)

PRE-SAFE® is able to detect certain critical driving situations and implement pre-emptive measures to protect the vehicle occupants.

PRE-SAFE® can implement the following measures independently of each other:

- Tightening the seat belts on the driver's seat and front passenger seat.
- Closing the side windows.
- **Vehicles with sliding sunroof:** closing the sliding sunroof.
- **Vehicles with memory function:** moving the front passenger seat to a more favourable seat position.
- **Vehicles with multicontour seat:** increasing the air pressure in the seat side bolsters of the seat backrest.
- PRE-SAFE® Sound: provided that the multimedia system is switched on, generating a brief noise signal to stimulate the innate protective mechanism of a person's hearing.

! **NOTE** Damage caused by objects in the footwell or behind the seat

The automatic adjustment of the seat position may result in damage to the seat and/or the object.

▶ Stow objects in a suitable place.

Reversing the PRE-SAFE® system measures

If an accident did not occur, the pre-emptive measures that were taken are reversed.

You will need to perform certain settings yourself.

- ▶ If the seat belt pre-tensioning is not reduced, move the seat backrest back slightly. The locking mechanism releases.

Function of PRE-SAFE® PLUS (anticipatory occupant protection plus)

PRE-SAFE® PLUS can detect certain impacts, particularly an imminent rear impact, and take pre-emptive measures to protect the vehicle occupants. These measures cannot necessarily prevent an imminent impact.

PRE-SAFE® PLUS can implement the following measures independently of each other:

- Tightening the seat belts on the driver's seat and front passenger seat.

- Activating the rear hazard warning lights at a higher flashing frequency.
- Increasing brake pressure when the vehicle is stationary. This brake application is cancelled automatically when the vehicle pulls away.

If an accident did not occur, the pre-emptive measures that were taken are reversed.

System limits

The system will not initiate any action in the following situations:

- when reversing
or
- when the vehicle is towing a trailer and there is a risk of a rear impact

The system will not initiate any braking application in the following situations:

- whilst driving
or
- when entering or exiting a parking space while using Active Parking Assist

You can watch an animation on this topic via the following link:

[Function of PRE-SAFE® Impulse Side](#)

If an imminent side impact is detected, PRE-SAFE® Impulse Side can pre-emptively move the front seat vehicle occupant's upper body towards the centre of the vehicle. It does this by rapidly inflating an air cushion in the outer seat side bolster of the seat backrest on the side on which the impact is anticipated. This increases the distance between the door and the vehicle occupant.

If PRE-SAFE® Impulse Side has been deployed or is faulty, the [PRE-SAFE impulse side inoperative](#) See [Owner's Manual](#) display message appears.

Automatic measures after an accident

Depending on the type and severity of the accident, and depending on the vehicle's equipment, the following measures can be implemented, for example:

- automatic braking (post-collision brake)

- activating the hazard warning lights
- triggering an automatic emergency call (→ page 440)
- switching off the engine

To start the vehicle again, switch the vehicle off and on once more (→ page 182). Depending on the type and severity of the accident, you may no longer be able to start the vehicle.

- switching off the fuel supply
- unlocking the vehicle doors
- lowering the side windows
- displaying the emergency guide in the central display
- switching on the interior lighting

Function of the post-collision brake

Depending on the accident situation, the post-collision brake can minimise the severity of a further collision or even avoid it.

If an accident is detected, the post-collision brake can implement automatic braking. When the vehicle has come to a standstill, the electric parking brake is automatically applied.

The driver can cancel automatic braking by taking the following actions:

- braking more strongly than automatic braking
- fully depressing the accelerator pedal with force

Safely transporting children in the vehicle

[Always observe when children are travelling in the vehicle](#)

- ① Also strictly observe the safety notes for the specific situation. In this way you can recognise potential risks and avoid dangers if children are travelling in the vehicle (→ page 54).

Be diligent

Bear in mind that negligence when securing a child in the child restraint system may have serious consequences. Always be diligent in securing a child carefully before every journey.

Never allow babies and children to travel sitting on the lap of another vehicle occupant.

To improve protection for children younger than 12 years old or under 1.50 m in height, Mercedes-Benz recommends you observe the following information:

- Always secure the child in a child restraint system suitable for this Mercedes-Benz vehicle.
- The child restraint system must be appropriate to the age, weight and size of the child.
- The vehicle seat must be suitable for fitting a child restraint system (→ page 58).

Accident statistics show that children secured on the rear seats are generally safer than children secured on the front seats. For this reason, Mercedes-Benz strongly advises that you fit a child restraint system to a rear seat.

The generic term child restraint system

The generic term child restraint system is used in this Owner's Manual. A child restraint system is, for example:

- a baby car seat
- a rearward-facing child seat
- a forward-facing child seat

- a child booster seat with a backrest and seat belt guide
Mercedes-Benz recommends using a child booster seat with a backrest.

The child restraint system must be appropriate to the age, weight and size of the child.

Observe laws and legal requirements

Always observe the legal requirements when using a child restraint system in the vehicle.

Make sure that the child restraint system is approved in accordance with the valid test specifications and guidelines. Further information can be obtained at a qualified specialist workshop. Mercedes-Benz recommends that you use a Mercedes-Benz Service Centre for this purpose.

Only use approved child restraint systems

Only child restraint systems that meet the following UNECE standards are permitted for use in the vehicle:

- UN-R44
- UN-R129 (i-Size child restraint systems)

Information on child restraint system approval categories and details on the approval label on the child restraint system (→ page 59).

Detecting risks, avoiding danger

Securing systems for child restraint systems in the vehicle

Only use the following securing systems for child restraint systems:

- the ISOFIX or i-Size securing rings
- the vehicle's seat belt system
- the Top Tether anchorages

Fitting an ISOFIX or an i-Size child restraint system is preferred.

Simply attaching to the securing rings on the vehicle can reduce the risk of fitting the child restraint system incorrectly.

When securing a child with the integrated seat belt of the ISOFIX or i-Size child restraint system, always comply with the permissible gross weight for the child and child restraint system (→ page 62).

Advantage of a rearward-facing child restraint system

It is preferable to transport a baby or a small child in a suitable rearward-facing child restraint system. In this case, the child sits in the opposite direction to the direction of travel and faces backwards.

Babies and small children have comparatively weak neck muscles in relation to the size and weight of their head. The risk of injury to the cervical spine during an accident can be reduced in a rearward-facing child restraint system.

Always secure a child restraint system correctly

⚠ WARNING Risk of injury or death due to incorrect installation of the child restraint system

The child can then not be protected or restrained as intended.

- ▶ Be sure to comply with the manufacturer's installation instructions for the child restraint system and its correct use.

- ▶ Make sure that the entire base of the child restraint system always rests on the sitting surface of the seat.
- ▶ Never place objects (e.g. cushions) under or behind the child restraint system.
- ▶ Use child restraint systems only with the original cover designed for them.
- ▶ Always replace damaged covers with genuine covers.

⚠ WARNING Risk of injury or death due to unsecured child restraint systems in the vehicle

If the child restraint system is incorrectly fitted or not secured, it can become detached.

The child cannot then be protected or restrained as intended.

The unused child restraint system can become detached and strike vehicle occupants.

- ▶ Always comply with the manufacturer's installation instructions for the child restraint system and its correct use.
- ▶ Always fit child restraint systems correctly, even if they are transported unused in the vehicle.

- Always observe the child restraint system manufacturer's installation and operating instructions as well as the vehicle-specific information:
 - Fitting the ISOFIX or i-Size child restraint system to the rear seat (→ page 62).
 - Securing the child restraint system with the seat belt on the rear seat (→ page 68).
 - Securing the child restraint system with the seat belt on the front passenger seat (→ page 71). Observe the specific instructions for the rearward-facing and forward-facing child restraint systems (→ page 70).
- If the front passenger seat is occupied, ensure, both before and during the jour-

ney, that the status of the front passenger airbag is correct for the current situation (→ page 49).

- Observe the warning labels in the vehicle interior and on the child restraint system.
- Also secure Top Tether if present.

Do not modify the child restraint system

⚠ WARNING Risk of injury due to modifications to the child restraint system

The child restraint system can no longer function properly. This poses an increased risk of injury.

- ▶ Never modify a child restraint system.
- ▶ Only affix accessories which have been specially approved for this child restraint system by the child restraint system's manufacturer.

Mercedes-Benz recommends Mercedes-Benz care products for cleaning child restraint systems recommended by Mercedes-Benz.

Only use child restraint systems which are in proper working condition

⚠ WARNING Risk of injury or death caused by the use of damaged child restraint systems

Child restraint systems or their retaining systems that have been subjected to stress in an accident may not be able to perform their intended protective function.

It may be the case that the child cannot be properly restrained.

- ▶ Always immediately replace child restraint systems that have been damaged or involved in an accident.
- ▶ Have the securing systems for the child restraint systems checked at a qualified specialist workshop before installing a child restraint system again.

Avoid direct sunlight

⚠ WARNING Risk of burns when the child seat is exposed to direct sunlight

If the child restraint system is exposed to direct sunlight or heat, parts could heat up.

Children could suffer burns from these parts, particularly on metallic parts of the child restraint system.

- ▶ Always make sure that the child restraint system is not exposed to direct sunlight.
- ▶ Protect the child restraint system with a blanket, for example.
- ▶ If the child restraint system has been exposed to direct sunlight, allow it to cool before securing a child into it.
- ▶ Never leave children unattended in the vehicle.

Observe when stopping or parking

⚠ WARNING Accident- and risk of injury with unsupervised children in the vehicle

If you leave children unattended in the vehicle, they can in particular

- Open doors and thereby endanger other persons or road users.
- get out of the car and are hit by traffic.
- Operate vehicle equipment and become trapped, foreexample.

In addition, the children could also set the vehicle in motion, for example by:

- releasing the parking brake.
- change the gearbox setting.
- start the vehicle.

- ▶ Never leave children unattended in the vehicle.
- ▶ When leaving the vehicle, always take the SmartKey with you and lock the vehicle.
- ▶ Keep the key out of reach of children.

⚠ WARNING Risk of fatal injury due to exposure to extreme heat or cold in the vehicle

If persons, particularly children, are subjected to prolonged exposure to intense heat or cold, there is a risk of severe injury or even death.

- ▶ Never leave persons, particularly children, unattended in the vehicle.

Overview of recommended child restraint systems

- ⓘ Further information on the correct child restraint system can be obtained at a qualified specialist workshop. Mercedes-Benz recommends that you use a Mercedes-Benz Service Centre for this purpose.

Securing with ISOFIX

Weight category 0+ (up to 13 kg and up to approximately 15 months)

Type ¹	BABY SAFE plus
Size category	E
Approval	E1 04 301 146

Type ¹	BABY SAFE plus
Order number ²	B6 6 86 8224
1 Manufacturer: Britax Römer.	2 With colour code 9H95.

Weight category I (9 to 18 kg and from approximately 9 months to 4 years)

Type ¹	DUO plus
Size category	B1
Approval	E1 04 301 133
Order number ²	A 000 970 43 02
1 Manufacturer: Britax Römer.	2 With colour code 9H95.

Securing with the vehicle seat belt

Weight category 0 (up to 10 kg and approximately 6 months) and weight category 0+ (up to 13 kg and approximately 15 months)

Type ¹	BABY SAFE plus II
Approval	E1 04 301 146
Order number ²	A 000 970 38 02
1 Manufacturer: Britax Römer.	2 With colour code 9H95.

Weight category I (9 to 18 kg and from approximately 9 months to 4 years)

Type ¹	DUO plus
Approval	E1 04 301 133
Order number ²	A 000 970 43 02
1 Manufacturer: Britax Römer.	2 With colour code 9H95.

Weight category II/III (15 to 36 kg and from approximately 3 to 12 years)

Type ¹	KIDFIX XP
Approval	E1 04 301 304
Order number ²	A 000 970 49 02
1 Manufacturer: Britax Römer.	2 With colour code 9H95.

Weight category II/III (15 to 36 kg and from approximately 3 to 12 years)

Type ¹	AMG KIDFIX XP
Approval	E1 04 301 304
Order number ²	A 000 970 33 02
1 Manufacturer: Britax Römer.	2 With colour code 9H95.

Overview of suitable seats in the vehicle for fitting a child restraint system

Left/right rear seat

Preferred securing system:

 ISOFIX child seat anchor (→ page 60)
or

 i-Size child seat anchor (→ page 62)

 Also secure Top Tether if present (→ page 64).

Alternative securing system:

 Vehicle seat belt (→ page 66)

Front passenger seat

Securing system:

 Vehicle seat belt (→ page 66)

Be sure to observe:

- If the front passenger seat is occupied, ensure, both before and during the journey, that the status of the front passenger airbag is correct for the current situation (→ page 49).

- Notes on the automatic front passenger airbag shutdown .

Centre rear seat

Securing system:

 Vehicle seat belt (→ page 66)

Approval categories for child restraint systems

Only use approved child restraint systems

Only child restraint systems that meet the following UNECE standards are permitted for use in the vehicle:

- UN-R44
- UN-R129 (i-Size child restraint systems)

Identification on the child restraint system

Information about the approval category, weight category and approval number, forexample, is on the approval label on the child restraint system.

There may be further information such as the ISO-FIX size categories, depending on the approval category of the child restraint system.

Approval categories in accordance with UN-R44

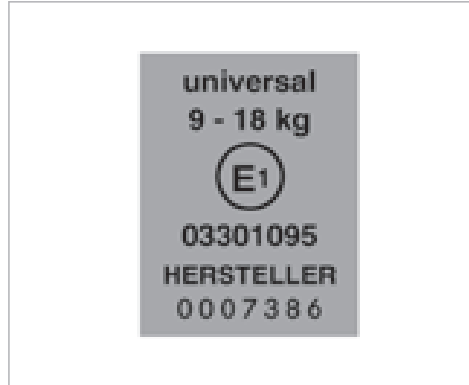

Example of an approval label

- **Universal:** child restraint systems in the "Universal" category are approved for installation in vehicles. They can be used, in accordance with overviews of the suitability of seats for securing child restraint systems, on seats labelled U, UF or IUF.

The identification IUF refers to ISOFIX child restraint systems in the "Universal" category.

These child restraint systems must also be secured using Top Tether or support points.

- **Semi-Universal:** child restraint systems in the "Semi-Universal" category may only be used if the vehicle and vehicle seat are listed in the child restraint system manufacturer's vehicle model list.
- **Vehicle-specific:** child restraint systems in the "vehicle-specific" category may only be used if the vehicle and vehicle seat are listed in the child restraint system manufacturer's vehicle model list.

Approval categories in accordance with UN-R129

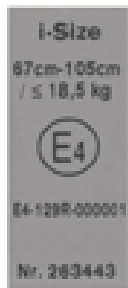

Example of an approval label

- **i-Size:** child restraint systems in the "i-Size" category are approved for installation in vehicles with i-Size mounting brackets. They can be used, in accordance with overviews of the suitability of seats for securing child restraint systems, on seats labelled i-U.

The identification i-U refers to i-Size child restraint systems in the "Universal" category.

These child restraint systems must also be secured using Top Tether or support points.

Observe the suitability of vehicle seats

Depending on the approval category, there are forward-facing and rearward-facing child restraint systems. Their use can be restricted for certain vehicle seats:

- Suitability of seats for attaching ISOFIX child restraint systems (→ page 60)
- Suitability of seats for securing i-Size child restraint systems (→ page 62).
- Suitability of seats for attaching belt-secured child restraint systems (→ page 66)

Fitting an ISOFIX or i-Size child restraint system on the left and right rear seats

Overview of suitability of the seats for attaching ISOFIX child restraint systems

ISOFIX is a standardised securing system for specially designed child restraint systems.

-  The symbol indicates seats suitable for attaching an ISOFIX child restraint system in accordance with UN R44 (→ page 59). Attach only child restraint systems that are approved in accordance with UN R44 as per the following ISOFIX tables.

Carry cot

Size class – Equipment	Left/right rear seat
F – ISO/L1	X
G – ISO/L2	X
X Not suitable for an ISOFIX child restraint system in this weight group and/or size class.	

Weight group 0 (up to 10 kg and up to approx. 6 months)

Size class – Equipment	Left/right rear seat
E – ISO/R1	IL
IL Suitable for ISOFIX child restraint systems according to the table in "Overview of the recommended child restraint systems", or if the vehicle and the seat are listed on the child restraint system manufacturer's vehicle model list.	

Weight group 0+ (up to 13 kg and up to approx. 15 months)

Size class – Equipment	Left/right rear seat
E – ISO/R1	IL
D – ISO/R2, ISO/R2X	IL

Size class – Equipment

C – ISO/R3

IL Suitable for ISOFIX child restraint systems according to the table in "Overview of the recommended child restraint systems", or if the vehicle and the seat are listed on the child restraint system manufacturer's vehicle model list.

(1) When using a child restraint system of size class (ISO/R3), move the front seat into the highest position. Make sure that the seat backrest of the front seat does not rest against the child restraint system.

Left/right rear seat

IL (1)

Weight group 1 (9–18 kg and approx. 9 months to 4 years)

Size class – Equipment	Left/right rear seat
D – ISO/R2, ISO/R2X	IL
C – ISO/R3	IL (1)
B – ISO/F2	IUF
B1 – ISO/F2X	IUF

Size class – Equipment	Left/right rear seat
A – ISO/F3	IUF
IL Suitable for ISOFIX child restraint systems according to the table in "Overview of the recommended child restraint systems", or if the vehicle and the seat are listed on the child restraint system manufacturer's vehicle model list.	
IUF Suitable for forward-facing ISOFIX child restraint systems of the "Universal" category in this weight group.	
(1) When using a child restraint system of size class (ISO/R3), move the front seat into the highest position. Make sure that the seat backrest of the front seat does not rest against the child restraint system.	

Overview of suitability of the seats for attaching i-Size child restraint systems

i-Size is a standardised securing system for specially designed child restraint systems.



The symbol indicates seats suitable for attaching an i-Size child restraint system in accordance with UN R129 (→ page 59).

Child restraint systems that are permitted in accordance with UN R44 as per the ISO-FIX tables (→ page 60) or UN R129 as per the following i-Size tables may be attached.

i-Size child restraint systems (ISO/R2, ISO/F2X, ISO/B2, ISO/B3)

Front passenger seat	Left/right rear seat
X	i-U
X Not suitable for an i-Size child restraint system in the "Universal" category.	i-U Suitable for forward-facing and rearward-facing i-Size child restraint systems in the "Universal" category.

Fitting the ISOFIX or i-Size child restraint system on the left and right rear seats

⚠ WARNING Risk of accident if the rear bench seat, rear seat and seat backrest are not engaged

The rear bench seat, rear seat and seat backrest may fold forwards, even while the vehicle is in motion.

- As a result, the vehicle occupant will be pressed into the seat belt with increased force. The seat belt will not be able to protect as intended and could cause additional injury.
- Objects or loads in the boot or load compartment cannot be restrained by the seat backrest.

▶ Make sure that the rear bench seat, the rear seat and the seat backrest are engaged before every trip.

If the rear seat backrest is not engaged and locked in place, the red lock verification indicator will be visible.

⚠ WARNING Risk of injury or death if the permissible gross mass of the child and child restraint system together is exceeded.

Too much load may be placed on the ISOFIX or i-Size child restraint systems and the child may not be restrained correctly in the event of an accident, for example.



▶ If the child is secured in an ISOFIX or i-Size child restraint system with integrated seat belts, the total mass of the child and child restraint system must not exceed 33 kg.

Always comply with the information about the mass of the child:

- in the manufacturer's installation and operating instructions for the child restraint system used
- on a label on the child restraint system, if present

Regularly check that the permissible gross mass of the child and child restraint system is still complied with.

When fitting a child restraint system, observe the following:

- ✓ Always observe the correct use of the seats and consider their suitability for attaching a child restraint system.
 -  ISOFIX child seat anchor (→ page 60) or
 -  i-Size child seat anchor (→ page 62)
- ✓ Always comply with the manufacturer's installation and operating instructions for the child restraint system used.
- ✓ Make sure that the child's feet do not touch the front seat. If necessary, move the front seat slightly forwards.
-  When fitting an ISOFIX child restraint system, also observe the following:
 - ✓ **When using a baby car seat in weight group 0/0+ and a rearward-facing child restraint system in weight group 1 on a rear seat:**

adjust the front seat so that the seat does not touch the child restraint system.

- ✓ **When using a forward-facing child restraint system in weight group 1:** remove the head restraint from the respective seat, if possible. In addition, the backrest of the child restraint system must lie as flat as possible against the backrest of the vehicle seat.

After the child restraint system has been removed, replace the head restraint immediately and adjust all head restraints correctly.

- ✓ If the head restraint of the child seat cannot be fully extended when it is installed in the vehicle, this will result in restrictions on the maximum size setting for child restraint systems in weight group 2 or 3.

Contact with the roof when the head restraint is fully extended and locked in place will not result in any restrictions on use.

- ✓ The child restraint system must not be put under strain between the roof and the seat cushion and/or be fitted facing in the wrong direction. Where possible, adjust the seat cushion inclination accordingly.

- ✓ The child restraint system must not be put under strain by the head restraint. Adjust the head restraints as appropriate.

 When fitting an i-Size child restraint system, also observe the following:

- ✓ **When using a rearward-facing child restraint system:** adjust the front seat so that it does not touch the child restraint system.

- ✓ **When using a forward-facing child restraint system:** remove the head restraint from the respective seat, if possible. In addition, the backrest of the child restraint system must lie as flat as possible against the backrest of the vehicle seat.

After the child restraint system has been removed, replace the head restraint immediately and adjust all head restraints correctly.



- ① ISOFIX mounting bracket
- ② i-Size mounting bracket

Before every journey, make sure that the ISOFIX child restraint system or the i-Size child restraint system is engaged correctly in both mounting brackets in the vehicle.

! **NOTE** Damage to the seat belt for the centre seat during installation of the child restraint system

▶ Make sure that the seat belt is not trapped.

- ▶ Fold the respective covers rearward.
- ▶ Attach the ISOFIX or i-Size child restraint system to both mounting brackets in the vehicle.

Fastening a Top Tether

! **WARNING** Risk of injury or death if the rear seat backrests are not locked after Top Tether belts are fitted

The rear seat backrests may fold forwards when you are driving.

As a result, child restraint systems will no longer be able to perform their intended protective function. This may also cause additional injuries.

- ▶ Always lock rear seat backrests after fitting Top Tether belts.
- ▶ Observe the lock verification indicator.

If the rear seat backrest is not engaged and locked in place, the red lock verification indicator will be visible.

 If the child restraint system is equipped with a Top Tether belt:

The risk of injury may be reduced by Top Tether. The Top Tether belt enables an additional connection between the child restraint system attached with ISOFIX or i-Size and the vehicle.

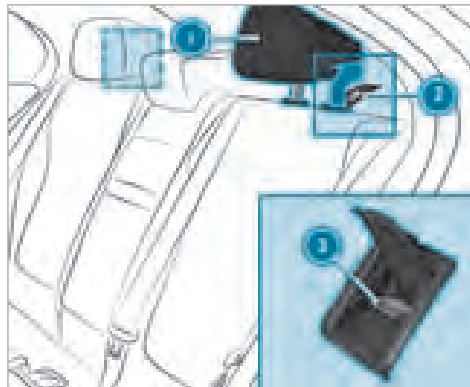

- ▶ If necessary, slide head restraint ① upwards (→ page 118).
- ▶ Fold up cover ② of Top Tether anchorage ③.
- ▶ Fit the ISOFIX or i-Size child restraint system with Top Tether. In doing so, comply with the child restraint system manufacturer's installation instructions.

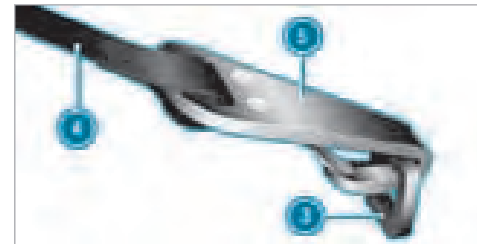

- ▶ Guide Top Tether belt ④ under head restraint ① between the two head restraint bars.
- ▶ Hook Top Tether hook ⑤ of Top Tether belt ④ into Top Tether anchorage ③ without twisting.
- ▶ Tension Top Tether belt ④. In doing so, comply with the child restraint system manufacturer's installation instructions.
- ▶ Fold down cover ② of Top Tether anchorage ③.
- ▶ If necessary, slide head restraint ① downwards (→ page 118). Make sure that you do not interfere with the correct routing of Top Tether belt ④.

Securing the child restraint system with the seat belt

■ Notes on the suitability of seats for attaching belt-secured child restraint systems

Suitability of seats for attaching belt-secured child restraint systems

Rear seats

Weight category 0: to 10 kg	
Left/right rear seat	U, L
Centre rear seat ¹	U, L
Weight category 0+: to 13 kg	
Left/right rear seat	U, L
Centre rear seat ¹	U, L
Weight category I: 9 to 18 kg	
Left/right rear seat	U, L

Centre rear seat ¹	U, L
Weight category II: 15 to 25 kg	
Left/right rear seat	U, L
Centre rear seat ¹	U, L
Weight category III: 22 to 36 kg	
Left/right rear seat	U, L
Centre rear seat ¹	U, L
UN-R129 child restraint systems	
Left/right rear seat	U, L, B2, B3
Centre rear seat ¹	U, L, B2, B3
1 Child restraint systems with a supporting bracket are not suitable for this seat.	

U Suitable for child restraint systems of the "Universal" category in this weight category.	
L Suitable for semi-universal child restraint systems according to the table in "Recommended child restraint systems", or if the vehicle and the seat are listed in the child restraint system manufacturer's vehicle model list.	
B2, B3 Suitable for the installation of child restraint systems complying with ISO/B2 and ISO/B3 child seat cushion test equipment.	

Notes on child restraint systems on the front passenger seat

- If it is absolutely necessary for you to fit a child restraint system to the front passenger seat, be sure to observe the information on

child restraint systems on the front passenger seat (→ page 71).

- Observe the specific instructions for the rearward-facing and forward-facing child restraint systems. If the front passenger seat is occupied, ensure, both before and during the journey, that the status of the front passenger air-bag is correct for the current situation (→ page 49).

Front passenger seat

Weight category 0: to 10 kg	
Front passenger air-bag enabled ¹	X
Front passenger air-bag disabled ^{1, 2}	U, L
Weight category 0+: to 13 kg	
Front passenger air-bag enabled ¹	X

Front passenger air-bag disabled ^{1, 2}	U, L
Weight category I: 9 to 18 kg	
Front passenger air-bag enabled ¹	UF, L
Front passenger air-bag disabled ^{1, 2}	U, L
Weight category II: 15 to 25 kg	
Front passenger air-bag enabled ¹	UF, L
Front passenger air-bag disabled ^{1, 2}	U, L
Weight category III: 22 to 36 kg	
Front passenger air-bag enabled ¹	UF, L

Front passenger air-bag disabled ^{1, 2}	U, L
UN-R129 child restraint systems	
Front passenger air-bag enabled ¹	UF, L, B2, B3
Front passenger air-bag disabled ^{1, 2}	U, L, B2, B3
1 Adjust the seat cushion inclination so that the front edge of the seat cushion is in the highest position and the rear edge of the seat cushion is in the lowest position.	
2 The vehicle is equipped with automatic front passenger air-bag shutoff. The PASSENGER AIR BAG OFF indicator lamp must be lit.	

X Not suitable for children in this weight category.	
U Suitable for child restraint systems of the "Universal" category in this weight category.	
L Suitable for semi-universal child restraint systems according to the table in "Recommended child restraint systems", or if the vehicle and the seat are listed in the child restraint system manufacturer's vehicle model list.	

UF Suitable for forward-facing child restraint systems of the "Universal" category in this weight category.	
B2, B3 Suitable for the installation of child restraint systems complying with ISO/B2 and ISO/B3 child seat cushion test equipment.	

■ Securing the child restraint system with the seat belt on the rear seat

⚠ WARNING Risk of accident if the rear bench seat, rear seat and seat backrest are not engaged

The rear bench seat, rear seat and seat backrest may fold forwards, even while the vehicle is in motion.

- As a result, the vehicle occupant will be pressed into the seat belt with increased

force. The seat belt will not be able to protect as intended and could cause additional injury.

- Objects or loads in the boot or load compartment cannot be restrained by the seat backrest.

▶ Make sure that the rear bench seat, the rear seat and the seat backrest are engaged before every trip.

If the rear seat backrest is not engaged and locked in place, the red lock verification indicator will be visible.

When fitting a belt-secured child restraint system, observe the following:

- ☑ Always comply with the manufacturer's installation and operating instructions for the child restraint system used.
- ☑ For a child restraint system in the "Universal" or "Semi-Universal" category, make sure that the system has been approved for the vehicle seat.

Observe the notes under "Suitability of seats for attaching belt-secured child restraint systems" (→ page 66).

- ✓ **When using a weight category 0/0+ baby car seat and a weight category I rearward-facing child restraint system on a rear seat:** adjust the front seat so that the seat does not touch the child restraint system.
- ✓ **When using a weight category I forward-facing child restraint system:** remove the head restraint from the respective seat, if possible.
After the child restraint system has been removed, replace the head restraint immediately and adjust all head restraints correctly.
- ✓ The backrest of the forward-facing child restraint system must, as far as possible, be resting on the seat backrest of the rear seat.
- ✓ If the head restraint of the child seat cannot be fully extended when it is installed in the vehicle, this will result in restrictions on the maximum size setting for child restraint systems in weight category II or III.

Contact with the roof when the head restraint is fully extended and locked in place will not result in any restrictions on use.

- ✓ The child restraint system must not be put under strain between the roof and the seat cushion and/or be fitted facing in the wrong direction. Where possible, adjust the seat cushion inclination accordingly.
 - ✓ The child restraint system must not be put under strain by the head restraint. Adjust the head restraints as appropriate.
 - ✓ Make sure that the child's feet do not touch the front seat. If necessary, move the front seat slightly forwards.
- ▶ Install the child restraint system.
The entire base of the child restraint system must always rest on the seat surface of the rear seat.
- ▶ Always make sure that the shoulder belt strap is correctly routed from the seat belt outlet of the vehicle to the shoulder belt guide on the child restraint system.
The shoulder belt strap must be routed forward from the seat belt outlet.

Notes on vehicles without automatic front passenger airbag shutoff



Sticker visible when the front passenger door is open

Vehicles without automatic front passenger airbag shutoff have a special sticker affixed to the side of the cockpit on the front passenger side.

Make sure you observe the following information:

- Never fit a rearward-facing child restraint system to the front passenger seat
- Always fit a rearward-facing child restraint system to a suitable rear seat
 - Observe the overview on suitability of seats for attaching belt-secured child restraint systems (→ page 66).
 - Secure the child restraint system with the seat belt on the rear seat (→ page 68).
- Notes on rearward-facing and forward-facing child restraint systems on the front passenger seat (→ page 70)

Notes on rearward-facing and forward-facing child restraint systems on the front passenger seat

⚠ WARNING Risk of injury or death when using a rearward-facing child restraint system while the front passenger airbag is enabled

If you secure a child in a rearward-facing child restraint system on the front passenger seat and the PASSENGER AIR BAG OFF indicator lamp is off, the front passenger airbag can deploy in the event of an accident.

The child could be struck by the airbag.

- ▶ Always ensure that the front passenger airbag is disabled. The PASSENGER AIR BAG OFF indicator lamp must be lit.
- ▶ NEVER use a rearward-facing child restraint system on a seat with an ENABLED FRONT AIRBAG. This can result in the DEATH of or SERIOUS INJURY to the CHILD.

Observe the specific instructions for the rearward-facing and forward-facing child restraint systems (→ page 71).

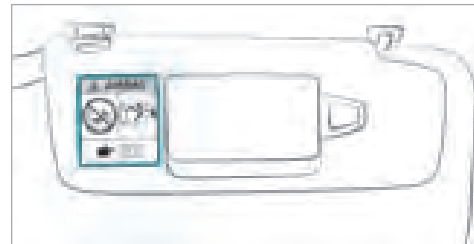

Warning notice on the front passenger sun visor

Always observe the status of the front passenger airbag on the PASSENGER AIR BAG OFF indicator lamp:

- If it is absolutely necessary to fit a child restraint system to the front passenger seat, always observe the information on automatic front passenger airbag shutoff .
- When using a rearward-facing child restraint system on the front passenger seat, the front

passenger airbag must always be disabled. This is only the case if the PASSENGER AIR BAG OFF indicator lamp is lit continuously (→ page 49).

- If the PASSENGER AIR BAG OFF indicator lamp is off, the front passenger airbag is enabled. The front passenger airbag may be deployed during an accident.

■ Securing the child restraint system with the seat belt on the front passenger seat

When fitting a belt-secured child restraint system on the front passenger seat, always observe the following:

- ✓ Observe the notes on rearward-facing and forward-facing child restraint systems on the front passenger seat (→ page 70).
- ✓ Observe the child restraint system manufacturer's installation and operating instructions.
- ✓ For a child restraint system in the "Universal" or "Semi-Universal" category, make sure that the system has been approved for the vehicle seat.

Observe the notes under "Suitability of seats for attaching belt-secured child restraint systems" (→ page 66).

- ✓ When using a forward-facing child restraint system in weight category I: remove the head restraint from the respective seat, if possible. After the child restraint system has been removed, replace the head restraint immediately and adjust all head restraints correctly.
- ✓ The backrest of the forward-facing child restraint system must, as far as possible, be resting on the seat backrest of the front passenger seat.
- ✓ If the head restraint of the child seat cannot be fully extended when it is installed in the vehicle; this will result in restrictions on the maximum size setting for child restraint systems in weight category II or III. Contact with the roof when the head restraint is fully extended and locked in place will not result in any restrictions on use.
- ✓ The child restraint system must not be put under strain between the roof and the seat

cushion and/or be fitted facing in the wrong direction.

- ✓ The child restraint system must not be put under strain by the head restraint. Adjust the head restraints as appropriate.
- ✓ Never place objects (e.g. cushions) under or behind the child restraint system.

⚠ WARNING Risk of injury or death caused by objects between the seat surface and the child restraint system

Objects between the seat surface and the child restraint system could affect the function of the automatic co-driver airbag shutoff.

- ▶ Do not place any objects between the seat surface and the child restraint system.
- ▶ Always make sure that the child restraint system is installed correctly.

- ▶ Set the front passenger seat as far back as possible and move the seat into the highest position if possible.

- ▶ Fully retract the seat cushion length adjustment.
- ▶ Adjust the seat cushion inclination so that the front edge of the seat cushion is in the highest position and the rear edge of the seat cushion is in the lowest position.
- ▶ Set the seat backrest to the most vertical position possible.
- ▶ Install the child restraint system. The entire base of the child restraint system must always rest on the sitting surface of the front passenger seat.
- ▶ Always make sure that the shoulder belt strap is correctly routed from the seat belt outlet of the vehicle to the shoulder belt guide on the child restraint system. The shoulder belt strap must be routed forwards and downwards from the seat belt outlet.
- ▶ If necessary, adjust the seat belt outlet and the front passenger seat accordingly.

Child safety locks

■ Activating or deactivating the child safety lock for the rear doors

⚠ WARNING Accident- and risk of injury with unsupervised children in the vehicle

If you leave children unattended in the vehicle, they can in particular

- Open doors and thereby endanger other persons or road users.
- get out of the car and are hit by traffic.
- Operate vehicle equipment and become trapped, for example.

In addition, the children could also set the vehicle in motion, for example by:

- releasing the parking brake.
- change the gearbox setting.
- start the vehicle.

▶ Never leave children unattended in the vehicle.

- ▶ When leaving the vehicle, always take the SmartKey with you and lock the vehicle.
- ▶ Keep the key out of reach of children.

⚠ WARNING Risk of fatal injury due to exposure to extreme heat or cold in the vehicle

If persons, particularly children, are subjected to prolonged exposure to intense heat or cold, there is a risk of severe injury or even death.

- ▶ Never leave persons, particularly children, unattended in the vehicle.

⚠ WARNING Risk of accident and injury due to children left unattended in the vehicle

If children are travelling in the vehicle, they could, in particular:

- open doors, thereby endangering other persons or road users.
- get out and be struck by oncoming traffic.
- operate vehicle equipment and become trapped, for example.

- ▶ Always activate the installed child safety locks if children are travelling in the vehicle.
- ▶ Never leave children unattended in the vehicle.
- ▶ When leaving the vehicle, always take the key with you and lock the vehicle.

Vehicles for the United Kingdom: observe the important safety notes in the "Notes on the additional door lock" section.

There are child safety locks for the rear doors and the rear side windows.

The child safety lock on the rear doors secures each door separately. The doors can no longer be opened from the inside.

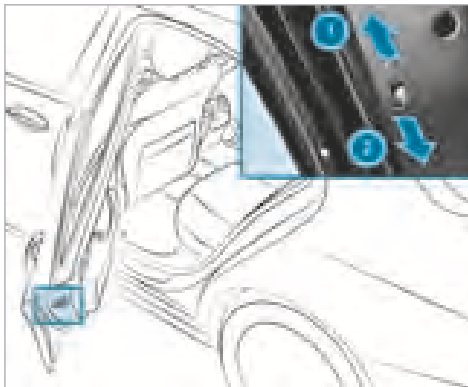

- ▶ Press the lever in direction ① (activate) or ② (deactivate).
- ▶ Make sure that the child safety locks are working properly.

■ Activating and deactivating the child safety lock for the rear side windows

⚠ WARNING Accident- and risk of injury with unsupervised children in the vehicle

If you leave children unattended in the vehicle, they can in particular

- Open doors and thereby endanger other persons or road users.
- get out of the car and are hit by traffic.
- Operate vehicle equipment and become trapped, foreexample.

In addition, the children could also set the vehicle in motion, for exampleby:

- releasing the parking brake.
- change the gearbox setting.
- start the vehicle.

- ▶ Never leave children unattended in the vehicle.
- ▶ When leaving the vehicle, always take the SmartKey with you and lock the vehicle.

- ▶ Keep the key out of reach of children.

⚠ WARNING Risk of fatal injury due to exposure to extreme heat or cold in the vehicle

If persons, particularly children, are subjected to prolonged exposure to intense heat or cold, there is a risk of severe injury or even death.

- ▶ Never leave persons, particularly children, unattended in the vehicle.

⚠ WARNING Risk of accident and injury due to children left unattended in the vehicle

If children are travelling in the vehicle, they could, in particular:

- open doors, thereby endangering other persons or road users.
- get out and be struck by oncoming traffic.
- operate vehicle equipment and become trapped, for example.

- ▶ Always activate the installed child safety locks if children are travelling in the vehicle.
- ▶ Never leave children unattended in the vehicle.
- ▶ When leaving the vehicle, always take the key with you and lock the vehicle.

Vehicles for the United Kingdom: observe the important safety notes in the "Notes on the additional door lock" section.

There are child safety locks for the rear doors and the rear side windows.

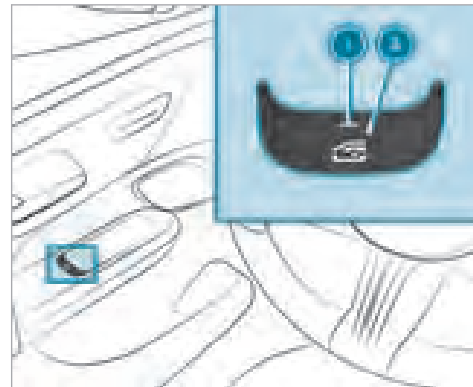

- ▶ **To activate/deactivate:** press button ②.

The rear side window can be opened or closed in the following cases:

- indicator lamp ① is lit: via the switch on the driver's door
- indicator lamp ① is off: via the switch on the corresponding rear door or driver's door

Occupant presence reminder

Function of the occupant presence reminder

The occupant presence reminder can help to remind you about a child who may have been forgotten in the rear compartment of the vehicle. It activates and deactivates automatically when the rear door is open for an extended period of time and a child, which the system presumes to be present, could enter or exit the vehicle.

When the vehicle is switched off, the **Do not leave persons or animals in the vehicle** message appears on the driver's display if the system was already automatically activated.

You can permanently deactivate the function in the multimedia system (→ page 75). When the system is deactivated, the  indicator lamp in the driver's display lights up.

Activating or deactivating the occupant presence reminder in the multimedia system

Multimedia system:

→  **▶▶ Settings ▶▶ Vehicle**
▶▶ Occupant protection

▶ Activate or deactivate the function.

Notes on pets in the vehicle

⚠ WARNING Risk of accident and injury due to animals left unsecured or unattended in the vehicle

If you leave animals in the vehicle unattended or unsecured, they could press buttons or switches, for instance.

An animal may:

- activate vehicle equipment and become trapped, for example
- switch systems on or off and endanger other road users

Unsecured animals may be thrown about the vehicle in the event of an accident, or sudden steering and braking manoeuvres, and injure vehicle occupants.

- ▶ Never leave animals unattended in the vehicle.
- ▶ Always correctly secure animals while driving, e.g. using a suitable animal carrier.

Key

Overview of key functions

⚠ WARNING Accident- and risk of injury with unsupervised children in the vehicle

If you leave children unattended in the vehicle, they can in particular

- Open doors and thereby endanger other persons or road users.
- get out of the car and are hit by traffic.
- Operate vehicle equipment and become trapped, foreexample.

In addition, the children could also set the vehicle in motion, for example:

- releasing the parking brake.
- change the gearbox setting.
- start the vehicle.

▶ Never leave children unattended in the vehicle.

- ▶ When leaving the vehicle, always take the SmartKey with you and lock the vehicle.
- ▶ Keep the key out of reach of children.

This also applies to the Digital Vehicle Key.

⚠ NOTE Damage to the key caused by magnetic fields



- ▶ Keep the key away from strong magnetic fields.



Vehicle key

- ① Indicator lamp
- ② To lock

- ③ Unlocks (with embossed surface)
- ④ Opens/closes the boot lid

ⓘ If indicator lamp ① does not light up after pressing the  or  button, the battery is weak or possibly discharged. Replace the battery as soon as possible.

Replace the key battery (→ page 78).

The key locks and unlocks the following components:

- Doors
- Fuel filler flap
- Boot lid

If the vehicle is not opened within approximately 40 seconds after unlocking, it locks again. Anti-theft protection is primed again.

Do not keep the key together with electronic devices or metal objects. This can affect the key's functionality.

Activating/deactivating the acoustic locking verification signal

Multimedia system:

→  → Settings → Vehicle
→ Open/close

▶ Activate or deactivate the **Acoustic lock**.



Please observe:

The selected setting for the acoustic locking verification signal must comply with the relevant national road and traffic regulations. In some countries, including Germany, using the acoustic locking verification signal is forbidden by traffic laws (in accordance with §16 Para. 1 and §30 Para. 1 of the German national road traffic regulations). The driver of the vehicle must comply with these regulations. In countries where the use of this function is forbidden, this function is not activated in the vehicle and must not be activated.

Changing the unlocking settings

Possible unlocking functions of the key:

- Central unlocking

- Unlocking the driver's door and fuel filler flap
- ▶ **To switch between settings:** press the  and  buttons simultaneously for approximately six seconds until the indicator lamp flashes twice.

Options if the unlocking function for the driver's door and fuel filler flap has been selected:

- **To unlock the vehicle centrally:** press the  button twice.
- **Vehicles with KEYLESS-GO:** if you touch the inner surface of the door handle on the driver's door, only the driver's door and the fuel filler flap are unlocked.



Deactivating the function of the key

If you deactivate the key function, the KEYLESS-GO functions are also deactivated. Access or drive authorization by KEYLESS-GO is then no longer possible with that particular key. Activate the function of the key so that all its functions will again be available. You can also deactivate the function of the key to reduce the energy con-

sumption of the key if you do not use the vehicle or a key for an extended period of time.

If you do not use the vehicle or a key for an extended period of time, you can also deactivate the function of the key to reduce the energy consumption of the key.

▶ Press and hold the key  button.

▶ With the key button  pressed, immediately press key button  twice in quick succession.
The indicator light of the key lights up once briefly and once for a long time.

 You have the following options to reactivate the key:

- Press any key on the key.
- Start the vehicle with the key in the centre console storage compartment (→ page 185).

Removing/inserting the emergency key

Removing the emergency key

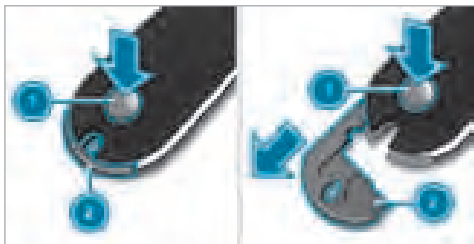

- ▶ Press release button ①. Emergency key ② is pushed out slightly.
- ▶ Fully remove emergency key ②.

Inserting the emergency key



- ▶ Insert emergency key ② at marking ③ until it engages.
- ① You can use emergency key ② to attach the key to a key ring.

Replacing the key battery

⚠ DANGER Risk of fatal injuries due to swallowing batteries

Batteries contain toxic and corrosive substances. If batteries are swallowed or otherwise

enter the body, severe internal burns can occur within two hours.

There is a risk of fatal injury.

- ▶ Keep batteries out of the reach of children.
- ▶ If the battery compartment cover and/or lid do not close securely, stop using the key and keep it away from children.
- ▶ If batteries are swallowed or otherwise enter the body, seek immediate medical attention.



ENVIRONMENTAL NOTE Environmental damage due to improper disposal of batteries



Batteries contain pollutants. It is illegal to dispose of them with the household rubbish.



Dispose of batteries in an environmentally responsible manner. Take discharged batteries to a qualified specialist workshop or to a collection point for used batteries.

Requirements:

- You require a CR 2032 3 V cell battery.

Mercedes-Benz recommends that you have the battery replaced at a qualified specialist workshop.

- Remove the emergency key (→ page 78).



- Press emergency key ② into the opening in the key in the direction of the arrow until cover ① opens. When doing so, do not hold cover ① closed.

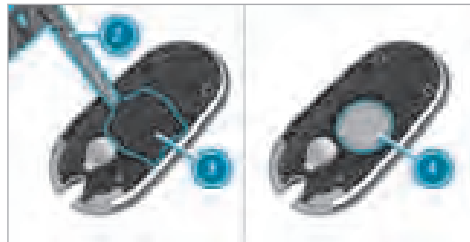

- Insert emergency key ② into the opening and lift up covering ③ and remove it.
- Repeatedly tap the key against your palm until battery ④ falls out of the key.
- Insert the new battery with the positive pole facing upwards. Use a lint-free cloth to do so.
- Make sure that the surface of the battery is free of lint, grease and other impurities.
- Insert the front tabs of covering ③ into the housing and then press on both sides to close it.
- Make sure that covering ③ is completely closed.
- Insert the front tabs of cover ① into the housing and then press until it is completely closed.
- Insert the emergency key again (→ page 78).

Problems with the key, troubleshooting

You can no longer lock or unlock the vehicle

Possible causes:

- The key battery is weak or discharged.
- ▶ Check the battery using the indicator lamp (→ page 76).
- ▶ Replace the key battery, if necessary (→ page 78).
- ▶ Use the replacement key.
- ▶ Use the emergency key to lock or unlock (→ page 90).
- ▶ Have key checked at a qualified specialist workshop.

There is interference from a powerful radio signal source

Possible causes if the function of the key is impaired:

- high voltage power lines
- mobile phones
- electronic devices (notebooks, tablets)

- shielding due to metal objects or induction loops for electrical gate systems or automatic barriers

▶ Make sure that there is sufficient distance between the key and the potential source of interference.

You have lost a key

- ▶ Have the key deactivated at a qualified specialist workshop.
- ▶ If necessary, have the mechanical lock replaced as well.

Digital Vehicle Key

Function of the Digital Vehicle Key

If you have activated a suitable terminal device, e.g. a smartphone, as a digital vehicle key, you can use it like a conventional vehicle key.

Information on setting up a user account and activating the "Digital Vehicle Key" service <https://www.mercedes.me>.

The Digital Vehicle Key can then be used for the following functions:

- Locking/unlocking the vehicle with KEYLESS-GO (→ page 87)
- Locking and unlocking the vehicle with the NFC function (→ page 84)
- HANDS-FREE ACCESS function (→ page 96)
- Convenience closing (closing the vehicle from outside) (→ page 101)
- Anti-theft protection (→ page 107)
- Starting the vehicle (→ page 182) or parking (→ page 209)
- Starting the vehicle with the digital vehicle key in the storage compartment (emergency mode) (→ page 183)

Set up and manage the digital vehicle key:

- Registering the digital vehicle key (→ page 81)
- Manage digital vehicle key (→ page 82)
- Remove digital vehicle key (→ page 83)

- Unlocking and locking the vehicle with the digital vehicle key (→ page 84)
- Changing the Unlocking Settings for the Digital Vehicle Key (→ page 85)
- Fixing Problems with the Digital Vehicle Key (→ page 85)

Setting up the digital vehicle key

Requirements

- Create a Mercedes me user account at: <https://www.mercedes.me>.
- The Mercedes me app is installed on the end device (optional).
- You have received an e-mail from Mercedes me connect.
If you have selected the "Digital Vehicle Key" equipment, you will receive an e-mail with information on how to set up the digital vehicle key.
- Bluetooth® is switched on at the end device and at the vehicle.
- The terminal is sufficiently charged.

You have the following options for setting up a terminal as a digital vehicle key:

- via Mercedes me app
- by e-mail
- via MBUX multimedia system

Set up via the Mercedes me app

- ▶ Start the Mercedes me app.
- ▶ Select the "Digital vehicle key" menu.
- ▶ Follow the steps in the Mercedes me app.

When the message "Add key and pair with vehicle" appears:

- ▶ Place the terminal in the tray (→ page 183).
- ▶ Follow the action steps on the terminal.
Your Digital Vehicle Key is now stored in the Wallet-App of your end device.

Set up by e-mail

- ▶ Open the e-mail from Mercedes me connect.
- ▶ Follow the displayed action steps as described in the email.
Your Digital Vehicle Key is now stored in the Wallet-App of your end device.

or

- ▶ Open the link in the e-mail with the end device that you want to use as a digital vehicle key.
- ▶ Follow the action steps on the terminal.
When the message "Add key and pair with vehicle" appears:
- ▶ Place the terminal in the tray (→ page 183).
- ▶ Follow the action steps on the terminal.
Your Digital Vehicle Key is now stored in the Wallet-App of your end device.

or

- ▶ Set up the terminal on the vehicle.
- ▶ Place the terminal in the tray (→ page 183). Mercedes-Benz Digital Vehicle Key" is displayed on the terminal device.
- ▶ Press "Enter code".
The display for entering the code appears.
- ▶ Enter the 8-digit code displayed in the e-mail.
When the message "Add key and pair with vehicle" appears:
- ▶ Follow the action steps on the terminal.
Your Digital Vehicle Key is now stored in the Wallet-App of your end device.

Set up via MBUX multimedia system

- ▶ Select the menus in the multimedia system **Settings, Vehicle, Open/close**.
- ▶ Select **Digital Vehicle Key** menu.
- ▶ Follow the action steps in the multimedia system.
Your Digital Vehicle Key is now stored in the **Wallet-App of your end device**.
- ① You can now use the digital vehicle key like the conventional vehicle key (→ page 84).
- ① Set up and manage the digital vehicle key:
 - Function (→ page 80)
 - Managing (→ page 82)
 - Remove (→ page 83)
 - Changing the Unlocking Settings for the Digital Vehicle Key (→ page 85)

Manage digital vehicle key

Requirements

- A suitable end device is activated as a Digital Vehicle Key.

- **Bluetooth® is switched on at the end device (with the activated digital vehicle key) and at the vehicle.**
- **The terminal is sufficiently charged.**

You have the following options for managing a digital vehicle key:

- Switch express mode (comfort mode) off or on
- Set up other devices of family members or friends as digital vehicle keys.
- Setting up permissions for the digital vehicle keys

Switch express mode off or on

- ▶ **Open the Wallet-App on the end device.**
- ▶ Switch express mode off or on
- ① Express mode is switched on by default. This setting allows you to make the best possible use of the Digital Vehicle Key.
If the express mode is switched off and the battery of the end device is empty, you can no longer unlock the vehicle via the NFC function.

Only switch off the express mode if you do not want to use the digital vehicle key function.

Setting up other terminals as digital vehicle keys

- ▶ **Open the Wallet-App on the end device.**
- ▶ Select the menu "Invite people to use your Mercedes-Benz key".
- ▶ Follow the action steps on the terminal.

Setting up permissions for the digital vehicle keys

You can assign the following authorisations to the Digital Vehicle Keys:

- Vehicle access and driving authorisation
- Vehicle access authorisation
- ▶ **Open the Wallet-App on the end device.**
- ▶ Select the menu "Invite people to use your Mercedes-Benz key".
- ▶ Select the "Configure car key access" menu.
- ▶ Follow the action steps on the terminal.
- ① Further information on the digital vehicle key:
 - Function (→ page 80)

- Setting up (→ page 81)
- Remove (→ page 83)
- Changing the Unlocking Settings for the Digital Vehicle Key (→ page 85)

Remove digital vehicle key

Requirements

- A suitable end device is activated as a Digital Vehicle Key.
- **Bluetooth® is switched on at the end device (with the activated digital vehicle key) and at the vehicle.**
- **The terminal is sufficiently charged.**

You have the following options for removing a digital vehicle key:

- via the Wallet-App
- via iCloud
- via Mercedes me user account
- via MBUX multimedia system

i You can remove individual users or remove your own digital vehicle key from the terminal.

Remove via Wallet-App

- ▶ **Open the Wallet-App on the end device.**
- ▶ Select the user whose Digital Vehicle Key is to be removed.
- ▶ Follow the action steps on the terminal.
The selected Digital Vehicle Key is removed and can no longer be used.

Remove via iCloud

- ▶ Log in to iCloud.
- ▶ Follow the action steps.
The selected Digital Vehicle Key is removed and can no longer be used.

Remove via Mercedes me user account

The following options are available:

- Remove the linked vehicle
- object to the terms of use and consents
- Delete the user account
- ▶ Log in to the Mercedes me user account.
- ▶ Select one of the above options.
The selected Digital Vehicle Key is removed and can no longer be used.

Remove via MBUX multimedia system

The following options are available:

- Disconnect all digital vehicle keys
- Change the Digital Vehicle Key of the main owner
- Disconnect the owner's Digital Vehicle Key
- Remove a digital vehicle key
- ▶ Select the menus in the multimedia system **Settings, Vehicle, Open/close.**
- ▶ Select **Digital Vehicle Key** menu.
- ▶ Select one of the above options.
- ▶ Follow the action steps in the multimedia system.
The selected Digital Vehicle Key is removed and can no longer be used.
- i** Further information on the digital vehicle key:
 - Function (→ page 80)
 - Setting up (→ page 81)
 - Managing (→ page 82)
 - Changing the Unlocking Settings for the Digital Vehicle Key (→ page 85)

Unlocking and locking the vehicle with the digital vehicle key

Requirements

- The "Digital Vehicle Key" function is activated via Mercedes me: <https://www.mercedes.me>.
 - A suitable end device is activated as a Digital Vehicle Key.
 - Bluetooth® is switched on at the end device and at the vehicle.
 - The terminal is sufficiently charged.
- ❗ If the connection via Bluetooth® is faulty or the battery of the digital vehicle key is empty, you can also lock, unlock or start the vehicle via the NFC function. (→ page 183).

The Digital Vehicle Key can be used for the following functions:

- Locking and unlocking the vehicle with the NFC function
- Locking/unlocking the vehicle with KEYLESS-GO (→ page 87)
- HANDS-FREE ACCESS function (→ page 96)

- Convenience closing (closing the vehicle from outside) (→ page 101)
 - Anti-theft protection (→ page 107)
 - Starting the vehicle (→ page 182) or parking (→ page 209)
 - Starting the vehicle with the digital vehicle key in the storage compartment (emergency mode) (→ page 183)
- ❗ Mercedes-Benz recommends that you carry the emergency key in case of function restrictions (→ page 78).

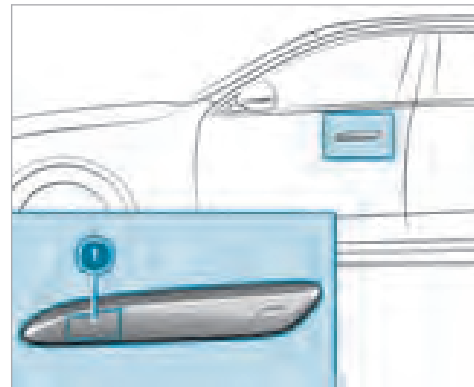

▶ **Lock and unlock the vehicle with the NFC function:** Hold the digital vehicle key against ❶ the door handle in the area of the NFC antenna.

Changing the Unlocking Settings for the Digital Vehicle Key

Multimedia system:

- Settings ▶▶ Vehicle
 ▶▶ Open/close

Set selective or global unlocking

- ▶ **Switch on driver's door** unlocking only. Selective unlocking is activated. If this function is deactivated, the owner key unlocks the entire vehicle.

Fixing Problems with the Digital Vehicle Key

You can no longer lock and unlock the vehicle with the Digital Vehicle Key.

Possible causes:

- Bluetooth® is switched off on the Digital Vehicle Key or on the vehicle.
 - The battery of the Digital Vehicle Key is low or empty.
- ▶ Switch on Bluetooth® on the digital vehicle key or on the vehicle.

- ▶ Check the charge level of the Digital Vehicle Key battery.
- ▶ If necessary, charge the battery of the Digital Vehicle Key.
- ▶ Use the NFC function of the digital vehicle key to lock or unlock the vehicle. (→ page 84).
- ▶ Use the vehicle key.
- ▶ Use the emergency key to lock or unlock (→ page 90).
- ▶ Have the vehicle and the Digital Vehicle Key checked at a qualified specialist workshop.

There is interference from a powerful radio signal source

Possible causes of Digital Vehicle Key impairment:

- high voltage power lines
- mobile phones
- electronic devices (notebooks, tablets)
- shielding due to metal objects or induction loops for electrical gate systems or automatic barriers

- ▶ Ensure sufficient distance between the Digital Vehicle Key and a potential source of interference.

You have lost a Digital Vehicle Key.

- ▶ **Remove the Digital Vehicle Key (→ page 83).**

Doors

Notes on the additional door lock

The additional door lock is only available for vehicles for the United Kingdom.

- ⚠ **WARNING** Risk of injury to persons inside the vehicle when the additional door lock is activated

If the additional door lock is activated, the doors can no longer be opened from the inside.

- ▶ **Never leave persons, in particular children, unattended in the vehicle.**
- ▶ If there are persons in the vehicle, do not activate the additional door lock.

The additional door lock is automatically activated in the following situations:

- The vehicle is locked using the key.
- The vehicle is locked using KEYLESS-GO.

If the vehicle has been locked via Mercedes me connect, the additional door lock is not activated (→ page 433).

If the additional door lock is activated, the doors cannot be opened from the inside.

- ① After locking you can issue a signal with the horn.

You can prevent the additional door lock from being activated by deactivating interior protection before locking the vehicle (→ page 110).

Unlocking/opening the doors from the inside

- ▶ **United Kingdom only:** observe the notes on the additional door lock (→ page 85).

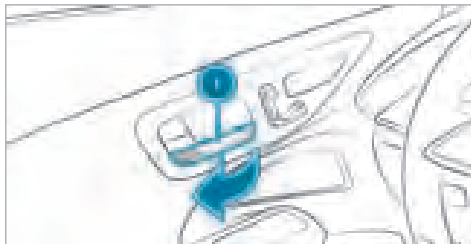

- ▶ Pull the door ① handle.

Centrally locking and unlocking the vehicle from the inside

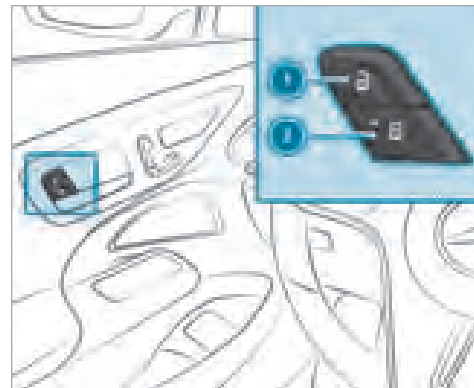

- ▶ **To unlock:** press ① button.
- ▶ **To lock:** press button ②. The red indicator lamp on button ② lights up once the vehicle is locked.

This does not lock or unlock the fuel filler flap.

The vehicle is not unlocked:

- if you have locked the vehicle using the key
- if you have locked the vehicle using KEYLESS-GO

Recessed door handles extend or retract

The door handles extend automatically:

- when you unlock the vehicle with the key
- when you touch the outer sensor surface of the door handle (when the vehicle is unlocked)

The door handles retract automatically:

- when you lock the vehicle with the key
- when pulling away
- after waiting for a time

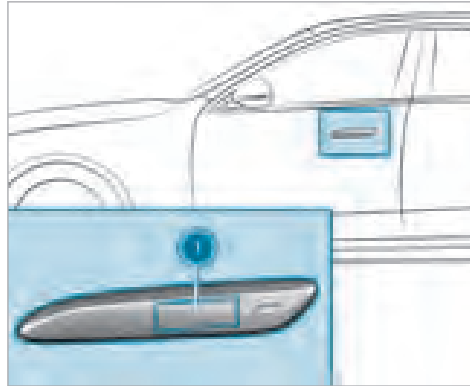

- ▶ **Extend the door handle:** Touch the outer ① sensor surface.

Locking/unlocking the vehicle with KEYLESS-GO

Requirements

- The key is outside the vehicle.
- The distance between the key and the vehicle does not exceed 1 m.

- The driver's door and the door on which the door handle is used are closed.

- ① **Vehicles with Digital Vehicle Key:** You can use the Digital Vehicle Key like the conventional vehicle key.

The door handles extend automatically:

- when a vehicle key is detected (the vehicle is then not yet unlocked)
- when you unlock the vehicle with the key
- when you touch the outer sensor surface of the door handle to unlock it

The door handles retract automatically:

- when you lock the vehicle with the key
- when you touch the recessed sensor surface of the door handle to lock it
- after comfort locking (→ page 101)
- when pulling away
- after waiting for a time

! **NOTE** Damage to the vehicle caused by unintentionally opening the boot lid or a door

- when using an automatic car wash
- when using a high pressure cleaner

▶ Deactivate the function of the key in these situations.

or

▶ Make sure that the key is at a minimum distance of 3 m (high-pressure cleaner) or 6 m (automatic car wash) away from the vehicle.

or

▶ Make sure the key is at least 3 m (pressure washer) or 6 m (car wash) away from the vehicle.

Observe the notes:

- on washing the vehicle in a car wash (→ page 477)
- on using a high pressure cleaner (→ page 478)

Vehicles with digital vehicle key:

! **NOTE** Vehicle damage due to unintentional opening of the boot lid or a door

- when using an automatic car wash
- when using a high pressure cleaner

▶ In these situations, switch off the Digital Vehicle Key.

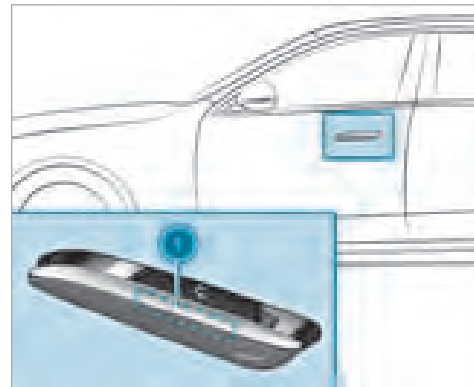

▶ **Unlocking the vehicle:** With the door handle extended, touch the inside surface **1** of the door handle.

If the door handle is not extended, e. g. after a waiting period:

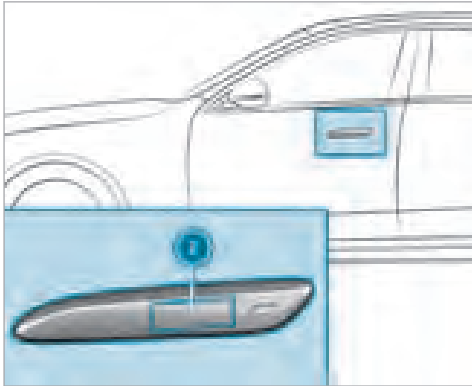

- ▶ Touch the sensor surface ② to unlock.

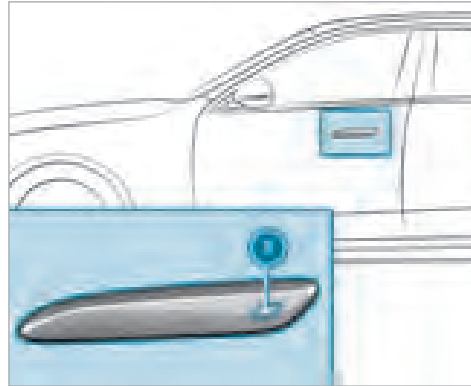

- ▶ **To lock the vehicle:** touch recessed sensor surface ③.
- ▶ **Convenience closing:** touch recessed sensor surface ③ for an extended period.
- ① Further information on convenience closing (→ page 101).

You can watch an animation on this topic via the following link:

Problems with KEYLESS-GO, troubleshooting

You can no longer lock or unlock the vehicle using KEYLESS-GO

Possible causes:

- The function of the key has been deactivated.
 - The key battery is weak or discharged.
- ▶ Activate the function of the key (→ page 77).
 - ▶ Check the battery using the indicator lamp (→ page 76).
 - ▶ Replace the key battery, if necessary (→ page 78).
 - ▶ Use the replacement key.
 - ▶ Use the emergency key to lock or unlock (→ page 90).
 - ▶ Have the vehicle and key checked at a qualified specialist workshop.

There is interference from a powerful radio signal source

Possible causes if the function of KEYLESS-GO is impaired:

- high voltage power lines

- mobile phones
- electronic devices (notebooks, tablets)
- shielding due to metal objects or induction loops for electrical gate systems or automatic barriers

▶ Make sure that there is sufficient distance between the key and the potential source of interference.

Activating or deactivating the automatic locking feature

Multimedia system:

→  ▶▶ Settings ▶▶ Vehicle
▶▶ Open/close

ⓘ The vehicle is locked automatically when the vehicle is switched on and the wheels are turning faster than walking pace.

▶ Activate or deactivate **Automatic locking**.

In the following situations, there is a danger of being locked out when the function is activated:

- The vehicle is being towed or pushed.

- If the vehicle is being tested on a roller dynamometer.

Power closing function

⚠ WARNING Risk of becoming trapped when the doors close automatically

Body parts or objects can become trapped, causing injuries.

- ▶ Ensure that no body parts or objects are in the closing area.
- ▶ Automatic closing of the doors can be cancelled by pulling the outer or inner door handle.

If you push the door into the lock to the first detent position, the power closing function will automatically pull the door into the lock.

ⓘ If the vehicle is locked from the outside, or while pulling away, an automatic closing of the doors can be triggered.

Locking/unlocking the vehicle with the emergency key

Unlocking a left-hand vehicle door with the emergency key element

- ⓘ If you unlock and open the driver's door with the emergency key, this triggers the burglar alarm system.
- ⓘ If you unlock the driver's door with the emergency key, the boot lid will not be unlocked.

Vehicles without KEYLESS-GO

▶ Remove the emergency key (→ page 78).

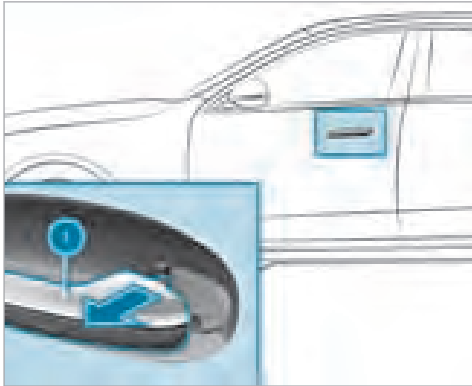

- ▶ Pull ① and hold the door handle.

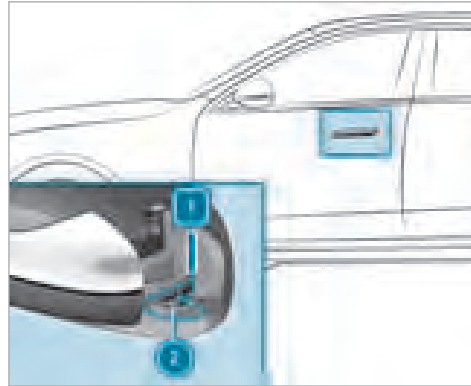

- ▶ Insert emergency key ② into the lock cylinder as shown.
- ▶ Turn the emergency key ② anti-clockwise to position 1.
- ▶ Turn the emergency key ② back to its starting position.
- ▶ Remove emergency key ② and release door handle ①.

Vehicles with KEYLESS-GO

- ▶ Remove the emergency key (→ page 78).

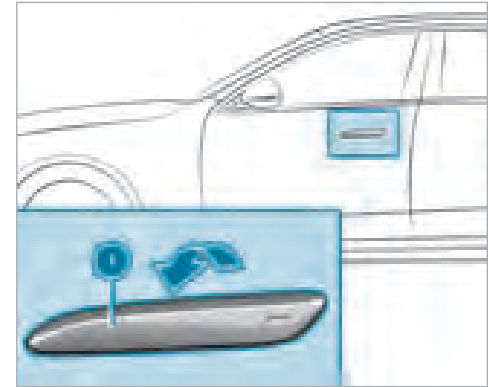

If the door handle is retracted:

- ▶ Insert a flat, non-metallic object behind door handle ① from above and pry it slightly outward.

- ▶ Reach behind door handle ❶ from below, pull it outward to the pressure point and hold it there.

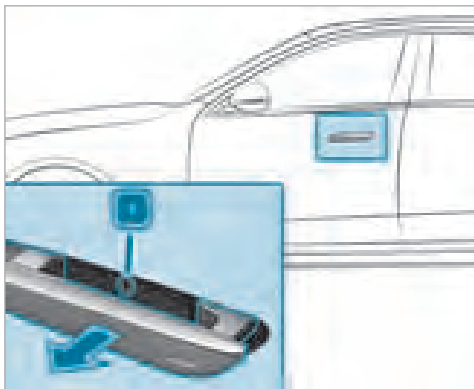

If the door handle is extended:

- ▶ Pull door handle ❶ outward to the pressure point and hold it there.
- ▶ Insert the emergency key into the lock cylinder.

- ▶ Turn the emergency key anti-clockwise to position ❶.
- ▶ Forcefully pull door handle ❶ outward past the pressure point.
- ▶ Turn the emergency key back to its starting position.
- ▶ Remove the emergency key and release the door handle.

You can watch an animation on this topic via the following link:

Locking the doors

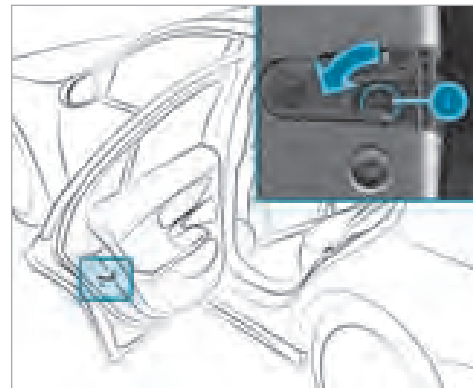

- ▶ Insert a suitable object, e.g. the emergency key, into opening ❶ on the door lock.
- ▶ **To lock the left-hand side of the vehicle:** turn the emergency key clockwise as far as it will go.

- ▶ **To lock the right-hand side of the vehicle:** turn the emergency key anti-clockwise as far as it will go.

If the locked door is then closed, it can no longer be opened from the outside.

Boot

Opening the boot lid

⚠ DANGER Risk of exhaust gas poisoning

Combustion engines emit poisonous exhaust gases such as carbon monoxide. Exhaust gases can enter the vehicle interior if the boot lid is open when the engine is running, especially if the vehicle is in motion.

- ▶ Always switch off the engine before opening the boot lid.
- ▶ Never drive with the boot lid open.

! **NOTE** Damage to the boot lid by obstacles above the vehicle

The boot lid swings upwards when it is opened.

- ▶ Therefore, make sure that there is sufficient clearance above the boot lid.

- ▶ **Pull the boot lid handle.**

- ▶ **Vehicles with HANDS-FREE ACCESS:** make a kicking movement with your foot below the bumper (→ page 96).

Vehicles with boot lid convenience closing

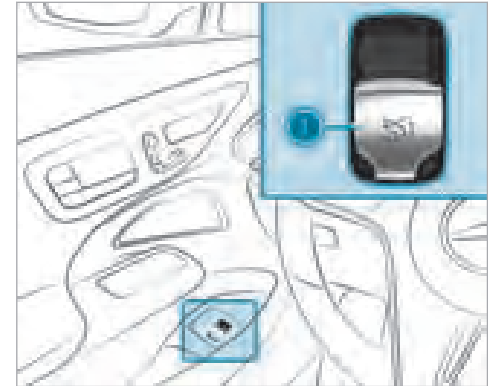

- ▶ Pull remote operating switch ① until the boot lid opens.

or

- ▶ Press and hold the  button on the key.
- ▶ If the boot lid is stopped in an intermediate position, pull it upwards. Release it as soon as it begins to open.

- ▶ With the boot lid opening limiter activated, manually pull the stopped boot lid upwards.

If an obstacle obstructs the boot lid during the automatic opening process, blockage detection will stop the boot lid. The automatic blockage detection function is only an aid and is not a substitute for your attentiveness.

Closing the boot lid

⚠ WARNING Risk of injury from unsecured items in the vehicle

If objects, luggage or loads are not secured or not secured sufficiently, they could slip, tip over or be thrown around and thereby hit vehicle occupants.

There is a risk of injury, particularly in the event of sudden braking or a sudden change in direction.

- ▶ Always stow objects in such a way that they cannot be thrown around.

- ▶ Before the journey, secure objects, luggage or loads against slipping or tipping over.

Observe the notes on loading the vehicle.

Notes on closing the boot lid: your vehicle is equipped with automatic key recognition. If a key belonging to the vehicle is detected in the vehicle, the boot lid will not be locked and will pop open again.

Note that the boot lid will not be locked if the following situation occurs:

- You have locked the vehicle and close the boot lid while a key belonging to the vehicle is inside the vehicle.
- and
- A second key belonging to the vehicle is not detected outside the vehicle.

Automatic key recognition is only an aid and is not a substitute for your attentiveness.

- ▶ Before locking, ensure that at least one key belonging to the vehicle is outside the vehicle.

- ▶ **To close the boot lid:** pull the boot lid downwards using the handle recess and push it closed.

- ⓘ **Vehicles with boot lid convenience closing:** if you lightly push the boot lid closed, the power closing function will automatically pull the boot lid into the lock.

Vehicles with boot lid convenience closing

⚠ WARNING Risk of becoming trapped during automatic closing of the boot lid

Parts of the body could become trapped. There may be people in the closing area.

- ▶ Make sure that nobody is in the vicinity of the closing area.
- ▶ Use one of the following options to stop the closing process:
 - Press the  button on the key.
 - Press or pull the remote operating switch on the driver's door.
 - Press the closing or locking button on the boot lid.

- Pull the boot lid handle.

Vehicles with HANDS-FREE ACCESS: it is also possible to stop the closing process by making a kicking movement below the rear bumper.

- ▶ Pull the boot lid handle. Release it as soon as it begins to close.
- ▶ If the boot lid is stopped in an intermediate position, push it downwards. The boot lid will continue to close.

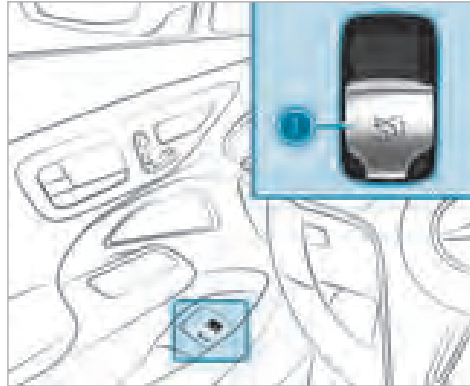

- ▶ Push remote operating switch ① until the boot lid is fully closed.

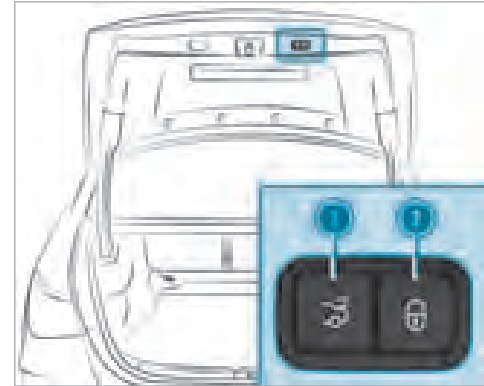

- ▶ Press closing button ① on the boot lid.

Vehicles with KEYLESS-GO

- ▶ Press locking button ② on the boot lid. If a key is detected outside the vehicle, the boot lid will close and the vehicle will be locked.

i **Vehicles with Digital Vehicle Key:** this also applies to the Digital Vehicle Key if the function is activated and the Digital Vehicle Key is connected to the vehicle.

▶ With the boot lid completely open, press and hold the  button on the key. The key must be in the vicinity of the vehicle.

Vehicles with HANDS-FREE ACCESS

▶ With the boot lid completely open, make a kicking movement with your foot below the bumper (→ page 96).

Boot lid automatic reversing function

The boot lid is equipped with automatic blockage detection with a reversing function. If an obstacle obstructs the boot lid during the automatic closing process, it will automatically open again. The automatic reversing function is only an aid and is not a substitute for your attentiveness.

▶ During the closing process, make sure that no body parts are in the closing area.

⚠ WARNING Risk of becoming trapped despite reversing function

The reversing function will not react:

- to soft, light and thin objects, e.g. fingers
- **towards the end of the closing procedure**

In these situations in particular, the reversing function cannot prevent someone being trapped.

▶ **Ensure that no body parts are in the closing area.**

▶ If someone is trapped, use one of the following options:

- Press the  button on the key.
- Press the remote operating switch on the driver's door.
- Press the closing or locking button on the boot lid.
- Pull the boot lid handle.

HANDS-FREE ACCESS function



With HANDS-FREE ACCESS you can open, close or interrupt boot lid movement by performing a kicking movement under the rear bumper.

The kicking movement triggers the opening or closing process alternately.

Observe the notes when opening (→ page 93) and closing (→ page 94) the boot lid.

i A warning tone sounds while the boot lid is opening or closing.

⚠ WARNING Risk of burns caused by a hot exhaust system

The vehicle exhaust system can become very hot. If you use HANDS-FREE ACCESS, you could burn yourself by touching the exhaust system.

- ▶ Always ensure that you only make a kicking movement within the detection range of the sensors.

! NOTE Damage to the vehicle caused by unintentionally opening the boot lid or a door

- when using an automatic car wash
- when using a high pressure cleaner

- ▶ Deactivate the function of the key in these situations.

or

- ▶ Make sure that the key is at a minimum distance of 3 m (high-pressure cleaner) or 6 m (automatic car wash) away from the vehicle.

Vehicles with digital vehicle key:

! NOTE Vehicle damage due to unintentional opening of the boot lid or a door

- when using an automatic car wash
- when using a high pressure cleaner

- ▶ In these situations, switch off the Digital Vehicle Key.

or

- ▶ Make sure the key is at least 3 m (pressure washer) or 6 m (car wash) away from the vehicle.

When making the kicking movement, make sure that you are standing firmly on the ground. You could otherwise lose your balance, e.g. on ice.

Observe the following notes:

- The key is behind the vehicle.
- **Vehicles with digital vehicle key:** The Digital Vehicle Key is behind the vehicle.
- Stand at least 30 cm away from the vehicle while performing the kicking movement.

- Do not come into contact with the bumper while making the kicking movement.
- Do not carry out the kicking movement too slowly.
- The kicking movement must be towards the vehicle and back again.

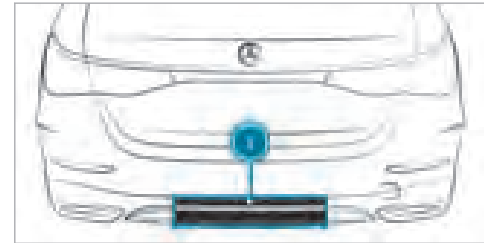

1 Detection range of the sensors

If several consecutive kicking movements are not successful, wait ten seconds.

System limits

The system may be impaired or may not function in the following cases:

- The sensors are dirty, e.g. due to road salt or snow.
- The kicking movement is made using a prosthetic leg.

The boot lid could be opened or closed unintentionally, in the following situations:

- A person's arms or legs are moving in the sensor detection range, e.g. when polishing the vehicle or picking up objects.
- Objects are moved or placed behind the vehicle, e.g. the hose of a fuel dispenser, a charging cable or luggage
- Clamping straps, tarpaulins or other coverings are pulled over the bumper.
- A protective mat with a length reaching over the boot sill down into the detection range of the sensors is used.
- The protective mat is not secured correctly.

- Work is being done on the trailer hitch, trailers or rear bicycle racks.

Deactivate the function of the key (→ page 77) or do not carry the key about your person in such situations.

You can watch an animation on this topic via the following link:

Switching separate boot locking on and off

Multimedia system:

→  » Settings » Vehicle
» Locking function

Switching separate boot locking on

- ▶ Select **Block boot**.
- ▶ Create a PIN.
- ▶ Confirm the PIN with **OK**.
- ▶ Enter the PIN again and confirm it.
The boot will remain locked if you unlock the vehicle centrally.

- ⓘ If an accident has been detected, the boot will unlock even if separate locking is switched on.

Switching separate boot locking off

- ▶ Select **Block boot**.
- ▶ Enter the PIN.
If the PIN is correct, separate boot locking will be switched off and the PIN deleted.

Activating/deactivating the boot lid opening limiter

Multimedia system:

→  » Settings » Vehicle
» Other functions

- ▶ Activate or deactivate **Opening height limiter**.

This function prevents the boot lid from hitting a low garage ceiling, for example.

Side windows

Opening and closing the side windows

- ⚠ WARNING** Risk of becoming trapped when opening a side window

When you open a side window, parts of the body could be drawn in or become trapped between the side window and window frame.

- ▶ When opening, make sure that nobody is touching the side window.
- ▶ If someone is trapped, release the button immediately or pull it in order to close the side window again.

- ⚠ WARNING** Risk of becoming trapped when closing a side window

When closing a side window, body parts could be trapped in the closing area in the process.

- ▶ When closing, make sure that no body parts are in the closing area.

- ▶ If someone is trapped, release the button immediately or press the button in order to reopen the side window.

- ⚠ WARNING** Risk of becoming trapped when children operate the side windows

Children could become trapped if they operate the side windows, particularly when unattended.

- ▶ Activate the child safety lock for the rear side windows.
- ▶ When leaving the vehicle, always take the key with you and lock the vehicle.
- ▶ Never leave children unattended in the vehicle.



Requirements

- The power supply or the vehicle has been switched on.



- ① Closing
- ② Opening

The buttons on the driver's door take precedence.

- ▶ **To start automatic operation:** press the  button beyond the point of resistance or pull and release it.
- ▶ **To interrupt automatic operation:** press or pull the  button again.

When the vehicle is switched off, you can continue to operate the side windows.

The function is also available until the doors are closed again.

Automatic reversing function of the side windows

If an obstacle impedes a side window during the closing process, the side window will open again automatically. The automatic reversing function is only an aid and is not a substitute for your attentiveness.

- ▶ During the closing process, make sure that no body parts are in the closing area.

⚠ WARNING Risk of becoming trapped despite there being reversing protection on the side window

The reversing function does not react:

- to soft, light and thin objects, e.g. fingers.
- during resetting.

The reversing function cannot prevent someone from becoming trapped in these situations.

- ▶ During the closing process, make sure that no body parts are in the closing area.
- ▶ If someone becomes trapped, press the  button to open the side window again.

Automatic function of the side windows

In the following cases, the side windows will be closed automatically when the vehicle is switched off:

- if it starts to rain
Rain is detected by a rain sensor on the windscreen.
- in extreme temperatures
- after a certain time (depending on the on-board electrical system voltage)
- if there is a malfunction in the power supply

The side windows will be closed as far as the ventilation position.

Vehicles with a panorama sliding sunroof: the side windows will be closed completely if the sliding sunroof is open.

If the side windows are obstructed during automatic closing, the side window concerned will open again slightly. After another automatic closing process, the automatic function may be deactivated. The automatic function will be active again the next time the vehicle is started.

Convenience opening (ventilating the vehicle before starting a journey)

⚠ WARNING Risk of entrapment when opening a side window

When opening a side window, parts of the body could be drawn in or become trapped between the side window and window frame.

- ▶ When opening, make sure that nobody is touching the side window.
- ▶ Release the button immediately if somebody becomes trapped.

Requirements

- The key is in the immediate vicinity of the vehicle.

▶ Press and hold the  button on the key.

The following functions are performed:

- The vehicle is unlocked.
- The side windows are opened.
- The panoramic sliding roof is opened.
- The seat ventilation of the driver's seat is switched on.

ⓘ If the roller sunblind of the panoramic sliding sunroof is closed, the roller sunblind is opened first.

▶ **To interrupt convenience opening:** release  the button.

▶ **To continue convenience opening:** press and hold the  button again.

Convenience closing (closing the vehicle from outside)

⚠ WARNING Risk of entrapment due to not paying attention during convenience closing

When the convenience closing feature is operating, parts of the body could become trapped in the closing area of the side window and the sliding sunroof.

▶ When the convenience closing feature is operating, monitor the entire closing process and make sure that no body parts are in the closing area.

Requirements

- The key is in the immediate vicinity of the vehicle.

▶ Press and hold the  button on the key.

The following functions are performed:

- The vehicle is locked.
- The side windows are closed.
- The panoramic sliding roof is closed.

▶ **To interrupt convenience closing:** release the  button.

▶ **To continue convenience closing:** press and hold the  button again.

ⓘ Convenience closing also functions with KEY-LESS-GO (→ page 87).

Resolving problems with the side windows

⚠ WARNING Risk of becoming trapped or fatally injured if reversing protection is not activated

If you close a side window again immediately after it has been blocked, the side window will close with increased or maximum force. The reversing function is then not active and body parts may become trapped.

▶ Make sure that no parts of the body are in the closing area.

▶ To stop the closing process, release the button or press the button again to reopen the side window.

A side window cannot be closed and you cannot see the cause.

- ▶ Check to see whether any objects are in the window guide.
- ▶ Adjust the side windows.

Adjusting the side windows

If a side window is obstructed during closing and reopens again immediately:

- ▶ Immediately after this, pull and hold the corresponding button again until the side window has closed and hold the button for at least one more second (re-adjustment).
The side window will be closed without the automatic reversing function.

If the side window is obstructed again and reopens again immediately:

- ▶ Immediately after this, pull and hold the corresponding button again until the side window has closed and hold the button for at least one more second (follow-up adjustment).
The side window will be closed without the automatic reversing function.

The side windows cannot be opened or closed using the convenience opening feature.

Possible causes:

- The key battery is weak or discharged.
- ▶ Check the battery using the indicator lamp (→ page 76).
- ▶ Replace the key battery, if necessary (→ page 78).

Sliding sunroof

Opening and closing the sliding sunroof

- ❗ The term "sliding sunroof" refers to the panorama sliding sunroof.

⚠ WARNING Risk of becoming trapped when the sliding sunroof is being opened and closed

Body parts may become trapped in the range of movement.

- ▶ During the opening and closing process, make sure that no body parts are in the sweep of the sliding sunroof.
- ▶ If someone is trapped, release the control panel immediately.

or

- ▶ Touch the control panel during automatic operation.
The opening/closing process will be stopped.

⚠ WARNING Risk of entrapment if the sliding sunroof is operated by children

Children operating the sliding sunroof could get caught in the moving parts, particularly if unattended.

- ▶ Never leave children unattended in the vehicle.
- ▶ When leaving the vehicle, always take the key with you and lock the vehicle.

⚠ WARNING Risk of becoming trapped when the roller sunblind is being opened and closed

Body parts may become trapped between the roller sunblind and frame or sliding roof.

- ▶ During the opening or closing process, make sure that no body parts are in the roller sunblind's range of movement.
- ▶ If someone is trapped, release the control panel immediately.

or

- ▶ Touch the control panel during automatic operation.
The opening/closing process will be stopped.

! NOTE Malfunction due to snow and ice

Snow and ice may cause the sliding sunroof to malfunction.

- ▶ Open the sliding sunroof only if it is free of snow and ice.

! NOTE Damage caused by protruding objects

Objects that protrude from the sliding sunroof may damage the seals.

- ▶ Do not allow anything to protrude from the sliding sunroof.

! NOTE Damage to panorama sliding sunroof caused by roof luggage rack

If the panorama sliding sunroof is opened when a roof luggage rack is fitted, the panorama sliding sunroof may be damaged by the roof luggage rack.

- ▶ Do not open the panorama sliding sunroof if a roof luggage rack is fitted.

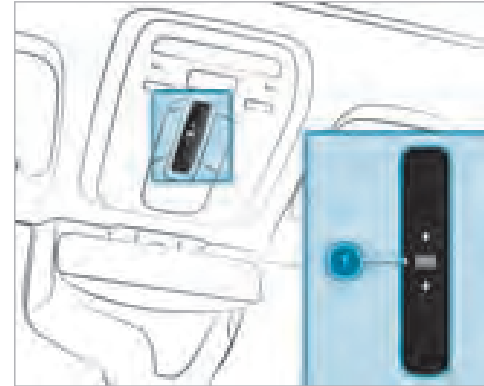

The sliding sunroof and the roller sunblind are operated using control panel ①.

The panorama sliding sunroof can be operated only when the roller sunblind is open.

- ▶ **To open:** swipe backwards across control panel ① and hold.
- ▶ **To close:** swipe forwards across control panel ① and hold.

- ▶ **To raise or lower:** press control panel ① briefly.
- ▶ **To start automatic operation:** swipe forwards or backwards across control panel ①.
- ▶ **To cancel automatic operation:** press control panel ① again.
The opening/closing process will be stopped.

Automatic reversing function of the sliding sunroof

If an obstacle obstructs the sliding sunroof during the closing process, the sliding sunroof will open again automatically. The automatic reversing function is only an aid and is not a substitute for your attentiveness.

- ▶ During the closing process, make sure that no body parts are in the closing area.

⚠ WARNING Risk of becoming trapped despite reversing function

The reversing function will not react:

- to soft, light and thin objects, e.g. fingers.
- towards the end of the closing procedure.

- during resetting.
- ▶ During the closing process, make sure that no body parts are in the closing area.
 - ▶ If someone is trapped, release the control panel immediately.
- or
- ▶ Touch the control panel during automatic closing.
The closing process will be stopped.

Automatic reversing function of the roller sunblind

If an obstacle obstructs the roller sunblind during the closing process, the roller sunblind will open again automatically. The automatic reversing function is only an aid and is not a substitute for your attentiveness.

- ▶ When closing the roller sunblind, make sure that no body parts are in the range of movement.

⚠ WARNING Risk of becoming trapped despite reversing function

In particular, the reversing function does not react to soft, light and thin objects, e.g. fingers.

- ▶ When closing the roller sunblind, make sure that no body parts are in the range of movement.
 - ▶ If someone is trapped, release the control panel immediately.
- or
- ▶ Touch the control panel during automatic closing.
The closing process will be stopped.

Automatic functions of the sliding sunroof

- ① The term "sliding sunroof" refers to the panorama sliding sunroof.

The sliding sunroof will be closed automatically when the vehicle has been switched off in the following situations:

- if it starts to rain

Rain is detected by a rain sensor on the windscreen.

- in extreme temperatures
- after a certain time (depending on the on-board electrical system voltage)
- if there is a malfunction in the power supply

The sliding sunroof will rise at the rear in order to continue ventilating the vehicle interior.

If the sliding sunroof is obstructed during an automatic closing procedure, the roof will be opened again slightly. The automatic function for the sliding sunroof and the side windows will then be deactivated.

Rain closing function when driving

Vehicles with a panorama sliding sunroof: if it starts to rain, the raised sliding sunroof will automatically be lowered while the vehicle is in motion.

Automatic lowering function

Vehicles with a panorama sliding sunroof: if the sliding sunroof is raised at the rear, it will automatically be lowered slightly at higher speeds. At low speeds, it will be raised again automatically.

⚠ WARNING Risk of becoming trapped by automatic lowering of the sliding sunroof

At higher speeds, the raised sliding sunroof will automatically be lowered slightly at the rear.

- ▶ Make sure that nobody reaches into the sliding sunroof's range of movement while the vehicle is in motion.
- ▶ If someone becomes trapped, touch the control panel.

Rectifying problems with the sliding sunroof

⚠ WARNING Risk of becoming trapped or fatal injuries when the sliding sunroof is closed again

If you close the sliding sunroof again immediately after it has been blocked or reset, the sliding sunroof will close with increased or maximum force.

There is a risk of becoming trapped or even of fatal injuries!

- ▶ Make sure that no parts of the body are in the closing area.
- ▶ If someone is trapped, release the control panel immediately.

or

- ▶ Touch the control panel during automatic closing.
The closing process will be stopped.

The sliding sunroof cannot be closed and you cannot see the cause.

- ⓘ The term "sliding sunroof" refers to the panorama sliding sunroof.

If the sliding sunroof is obstructed during closing and reopens again slightly:

- ▶ Immediately after automatic reversing, swipe forwards across the control panel (→ page 102) and hold until the sliding sunroof is closed.
The sliding sunroof will be closed with increased force.

If the sliding sunroof is obstructed again and opens again slightly:

- ▶ Repeat the previous step.
The sliding sunroof will be closed again with increased force.

The sliding sunroof or the roller sunblind is not operating smoothly.

- ▶ Reset the sliding sunroof and the roller sunblind.

Resetting the sliding sunroof and the roller sunblind

- ▶ Swipe forwards across the control panel (→ page 102) and hold repeatedly until the sliding sunroof is completely closed.
- ▶ Press and hold the control panel for another second.
- ▶ Press and hold the control panel until the front roller sunblind is completely closed.
- ▶ Press and hold the control panel for another second.
- ▶ Use automatic operation to fully open and then close the sliding sunroof.

Roller sunblinds

Extending the rear side window roller sunblinds

! **NOTE** Damage to the inertia reel due to it snapping back

If suddenly snapped back, the inertia reel may be damaged.

- ▶ Always move the roller sun blind by hand.
- ▶ Do not drive with the roller sun blind hooked in and rear side windows opened at the same time.

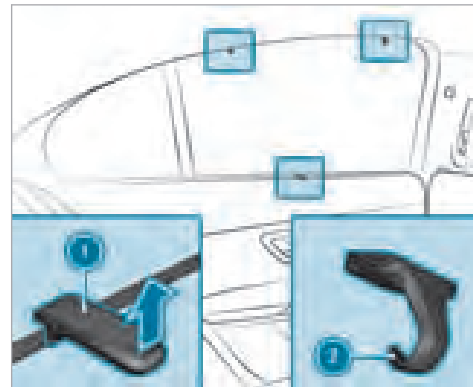

- ▶ Pull the roller sunblind out by tab ① and hook it onto brackets ② at the top of the window.

Extending or retracting the rear-window roller sunblind

⚠ WARNING Risk of becoming trapped when extending or retracting the roller sunblind

Body parts may become trapped in the roller sunblind's range of movement.

- ▶ Ensure there are no body parts in the range of movement.
- ▶ If someone becomes trapped, briefly press the button again. The opening or closing process will briefly be stopped. The roller sunblind will then return to its starting position.

! NOTE Damage caused by objects

Objects can cause the roller sunblind to malfunction.

- ▶ Do not place any objects on the rear shelf.
- ▶ Ensure that the roller sunblind can move freely.

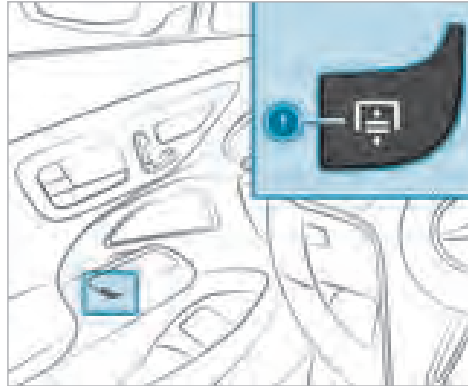

▶ **To extend or retract:** press button ①.

Anti-theft protection

Function of the immobiliser

The immobiliser prevents your vehicle from being started without the correct key.

This also applies to the Digital Vehicle Key.

The immobiliser is automatically activated when the vehicle is switched off, and deactivated when the vehicle is switched on.

ATA (Anti-Theft Alarm system)

Function of the ATA system

If the ATA system is primed, a visual and audible alarm is triggered in the following situations:

- when a door is opened
- when the boot lid is opened
- when the bonnet is opened
- when interior protection is triggered (→ page 109)
- when tow-away protection is triggered (→ page 108)

i Vehicles with Digital Vehicle Key: The EDW works with the Digital Vehicle Key in the same way as with the conventional vehicle key.

The ATA system is primed automatically after approximately ten seconds in the following situations:

- after locking the vehicle with the key
- after locking the vehicle using KEYLESS-GO
- After locking with the NFC function (**vehicles with digital vehicle key:**)

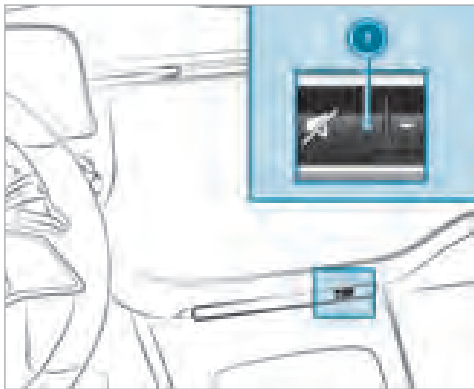

Indicator lamp ① flashes when the ATA system is primed.

The ATA system is deactivated automatically in the following situations:

- after unlocking the vehicle with the key
- after unlocking the vehicle using KEYLESS-GO
- after unlocking with the NFC function (**vehicles with digital vehicle key**)
- after pressing the start/stop button with the key in the stowage compartment (→ page 185)

Deactivating the ATA

▶ Press the ,  or  button on the key.

or

▶ Press the start/stop button with the key in the stowage compartment (→ page 185)

▶ **Vehicles with digital vehicle key:** Press the start/stop button with the digital vehicle key in the storage compartment (→ page 183).

Deactivating the alarm using KEYLESS-GO

▶ With the key outside the vehicle, touch the inner surface of the door handle.
This also applies to the Digital Vehicle Key.

Function of tow-away protection

An audible and visual alarm is triggered if an alteration to your vehicle's angle of inclination is detected while tow-away protection is primed.



Tow-away protection is automatically primed after approximately 60 seconds:

- after locking the vehicle with the key
- after locking the vehicle using KEYLESS-GO
This also applies to the Digital Vehicle Key.
- After locking with the NFC function (**vehicles with digital vehicle key:**)

Tow-away protection is only primed when the following components are closed:

- Doors
- Boot lid

Tow-away protection is automatically deactivated:

- after pressing the  or  button on the key
- after pressing the start/stop button with the key in the stowage compartment (→ page 185)
- after pressing the start-stop button with the digital vehicle key in the storage compartment **(Vehicles with digital vehicle key)** (→ page 183)
- after unlocking the vehicle using KEYLESS-GO
This also applies to the Digital Vehicle Key.
- after unlocking with the NFC function **(vehicles with digital vehicle key)**
- when using HANDS-FREE ACCESS

Information on collision detection on a parked vehicle (→ page 214).

Priming/deactivating tow-away protection

Multimedia system:

  **» Settings » Vehicle**
» Opening/closing » Vehicle protection

 Prime or deactivate **Tow-away protection**.

Tow-away protection is primed again in the following cases:

- The vehicle is unlocked again.
- A door is opened.
- The vehicle is locked again.

Function of interior protection

When interior protection is primed, a visual and audible alarm is triggered if movement is detected in the vehicle interior.

Interior protection is primed automatically after approximately ten seconds:

- after locking the vehicle with the key
- after locking the vehicle using KEYLESS-GO



This also applies to the Digital Vehicle Key.

- **After locking with the NFC function (vehicles with digital vehicle key):**

Interior protection is only primed when the following components are closed:

- Doors
- Boot lid

Interior protection is automatically deactivated:

- after pressing the  or  button on the key
- after pressing the start/stop button with the key in the stowage compartment (→ page 185)
- after pressing the start-stop button with the digital vehicle key in the storage compartment **(Vehicles with digital vehicle key)** (→ page 183)
- after unlocking the vehicle using KEYLESS-GO
This also applies to the Digital Vehicle Key.
- **after unlocking with the NFC function (vehicles with digital vehicle key)**
- when using HANDS-FREE ACCESS

The following situations can lead to a false alarm:

- when there are moving objects such as mascots in the vehicle interior
- if a side window is open
- if the panoramic sunroof is open

Priming/deactivating interior protection

Multimedia system:

  **»» Settings** **»» Vehicle**

»» Opening/closing **»» Vehicle protection**

 Prime or deactivate **Interior motion sensor**.

Interior protection is primed again in the following cases:

- The vehicle is unlocked again.
- A door is opened.
- The vehicle is locked again.

Notes on the correct driver's seat position

⚠ WARNING Risk of accident due to adjusting the vehicle settings while the vehicle is in motion

You could lose control of the vehicle in the following situations in particular:

- if you adjust the driver's seat, the head restraint, the steering wheel or the mirror while the vehicle is in motion
- if you fasten your seat belt while the vehicle is in motion

▶ Before starting the vehicle: in particular, adjust the driver's seat, head restraint, steering wheel and mirror, and fasten your seat belt.



Ensure the following when adjusting steering wheel ①, seat belt ② and driver's seat ③:

- You are sitting as far away from the driver's airbag as possible, taking the following points into consideration:
- You are sitting in an upright position
- Your thighs are slightly supported by the seat cushion

- Your legs are not fully extended and you can depress the pedals properly
- The back of your head is supported at eye level by the centre of the head restraint
- You can hold the steering wheel with your arms slightly bent
- You can move your legs freely
- You can see all the displays on the driver's display clearly
- You have a good overview of the traffic conditions
- Observe the notes on correctly fastening the seat belt (→ page 41).

Notes on grab handles

⚠ WARNING Risk of injury due to excessive load on the grab handles

If you apply your full body weight to the grab handle or pull it abruptly, the grab handle may be damaged or come loose from its anchorage. This may result in injuries.

- ▶ Use the grab handles only to stabilise the seating position or to assist in getting in and out of the seat.

Seats

Adjusting the front seat manually and electrically (with Seat Comfort Package)

- ⚠ WARNING** Risk of becoming trapped if the seats are adjusted by children

Children could become trapped if they adjust the seats, particularly when unattended.

- ▶ When leaving the vehicle, always take the key with you and lock the vehicle.
- ▶ Never leave children unattended in the vehicle.

You can adjust the seats when the vehicle is switched off.

- ⚠ WARNING** Risk of becoming trapped during seat adjustment

When you adjust a seat, you or other vehicle occupants could become trapped, e.g. on the seat guide rail.

- ▶ Make sure when adjusting a seat that no one has any body parts in the sweep of the seat.

This also applies to the Digital Vehicle Key.

Observe the safety notes on "Airbags" and "Children in the vehicle".

- ⚠ WARNING** Risk of accident due to the driver's seat not being engaged

The driver's seat may move unexpectedly while driving.

This could cause you to lose control of the vehicle.

- ▶ Always make sure that the driver's seat is engaged before starting the vehicle.

- ⚠ WARNING** Risk of accident due to adjusting the vehicle settings while the vehicle is in motion

You could lose control of the vehicle in the following situations in particular:

- if you adjust the driver's seat, the head restraint, the steering wheel or the mirror while the vehicle is in motion
- if you fasten your seat belt while the vehicle is in motion

- ▶ Before starting the vehicle: in particular, adjust the driver's seat, head restraint, steering wheel and mirror, and fasten your seat belt.

- ⚠ WARNING** Risk of becoming trapped if the seat height is adjusted carelessly

If you adjust the seat height carelessly, you or other vehicle occupants could be trapped and thereby injured.

Children in particular could accidentally press the electrical seat adjustment buttons and become trapped.

- ▶ While moving the seats, make sure that hands or other body parts do not get under the lever assembly of the seat adjustment system.

⚠ WARNING Risk of injury due to head restraints not being fitted or being adjusted incorrectly

If head restraints have not been installed or have not been adjusted correctly, there is an increased risk of injury in the head and neck area, e.g. in the event of an accident or when braking.

- ▶ Always drive with the head restraints fitted.
- ▶ Before driving off, make sure for every vehicle occupant that the centre of the head restraint supports the back of the head at about eye level.

Adjust the head restraint fore-and-aft position so that it is as close as possible to the back of your head.

⚠ WARNING Risk of injury or death due to incorrect seat position

The seat belt will not offer the intended level of protection if you have not moved the seat backrest to an almost vertical position.

In particular, you may slip under the seatbelt and injure yourself.

- ▶ Adjust the seat properly before beginning your journey.
- ▶ Always ensure that the seat backrest is in an almost vertical position and that the shoulder section of your seat belt is routed across the centre of your shoulder.

⚠ WARNING Risk of potentially fatal injuries due to objects trapped under the front passenger seat

Objects trapped under the front passenger seat may interfere with the function of the automatic front passenger airbag shutoff or damage the system.

- ▶ Do not stow any objects under the front passenger seat.
- ▶ When the front passenger seat is occupied, ensure that no objects have become trapped beneath the front passenger seat.

! NOTE Damage to the seats when adjusting

The seats may be damaged by objects when adjusting the seats.

- ▶ When adjusting the seats, make sure that there are no objects in the footwell, under or behind the seats.

! **NOTE** Damage to the roof lining during adjustment

The roof lining may be damaged when you adjust the front seats.

▶ Adjust the head restraints first before adjusting each seat height.

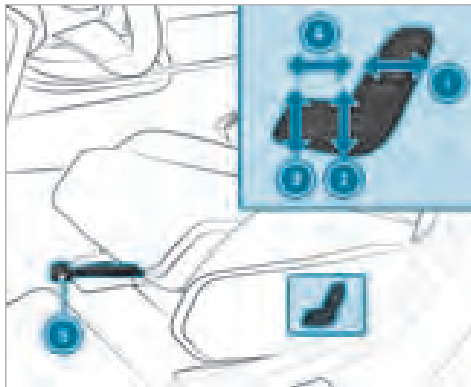

- ① Seat backrest inclination
- ② Seat height
- ③ Seat cushion inclination
- ④ Seat cushion length
- ⑤ Seat fore-and-aft position

▶ **To adjust the seat fore-and-aft position:** lift lever ⑤ and slide the seat into the desired position.

▶ Make sure that the seat is engaged.

Adjusting the front seat fully electrically

! **WARNING** Risk of becoming trapped if the seats are adjusted by children

Children could become trapped if they adjust the seats, particularly when unattended.

- ▶ When leaving the vehicle, always take the key with you and lock the vehicle.
- ▶ Never leave children unattended in the vehicle.

This also applies to the Digital Vehicle Key.

You can adjust the seats when the vehicle is switched off.

! **WARNING** Risk of becoming trapped during seat adjustment

When you adjust a seat, you or other vehicle occupants could become trapped, e.g. on the seat guide rail.

- ▶ Make sure when adjusting a seat that no one has any body parts in the sweep of the seat.

Observe the safety notes on "Airbags" and "Children in the vehicle".

⚠ WARNING Risk of accident due to adjusting the vehicle settings while the vehicle is in motion

You could lose control of the vehicle in the following situations in particular:

- if you adjust the driver's seat, the head restraint, the steering wheel or the mirror while the vehicle is in motion
 - if you fasten your seat belt while the vehicle is in motion
- ▶ Before starting the vehicle: in particular, adjust the driver's seat, head restraint, steering wheel and mirror, and fasten your seat belt.

⚠ WARNING Risk of becoming trapped if the seat height is adjusted carelessly

If you adjust the seat height carelessly, you or other vehicle occupants could be trapped and thereby injured.

Children in particular could accidentally press the electrical seat adjustment buttons and become trapped.

- ▶ While moving the seats, make sure that hands or other body parts do not get under the lever assembly of the seat adjustment system.

⚠ WARNING Risk of injury due to head restraints not being fitted or being adjusted incorrectly

If head restraints have not been installed or have not been adjusted correctly, there is an increased risk of injury in the head and neck area, e.g. in the event of an accident or when braking.

- ▶ Always drive with the head restraints fitted.
- ▶ Before driving off, make sure for every vehicle occupant that the centre of the head restraint supports the back of the head at about eye level.

Adjust the head restraint fore-and-aft position so that it is as close as possible to the back of your head.

⚠ WARNING Risk of injury or death due to incorrect seat position

The seat belt will not offer the intended level of protection if you have not moved the seat backrest to an almost vertical position.

In particular, you may slip under the seatbelt and injure yourself.

- ▶ Adjust the seat properly before beginning your journey.
- ▶ Always ensure that the seat backrest is in an almost vertical position and that the shoulder section of your seat belt is

routed across the centre of your shoulder.

⚠ WARNING Risk of potentially fatal injuries due to objects trapped under the front passenger seat

Objects trapped under the front passenger seat may interfere with the function of the automatic front passenger airbag shutoff or damage the system.

- ▶ Do not stow any objects under the front passenger seat.
- ▶ When the front passenger seat is occupied, ensure that no objects have become trapped beneath the front passenger seat.

! NOTE Damage to the seats when adjusting

The seats may be damaged by objects when adjusting the seats.

- ▶ When adjusting the seats, make sure that there are no objects in the footwell, under or behind the seats.

The switches for adjusting the seats do not move. You will therefore receive no direct feedback on the switch while pressing the switch. Feedback is provided only by the movement of the seat.

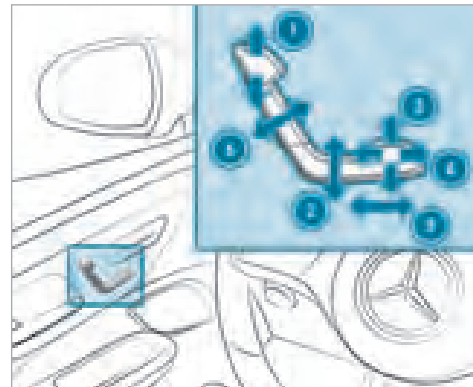

- ① Head restraint height
- ② Seat height
- ③ Seat cushion inclination
- ④ Seat cushion length
- ⑤ Seat fore-and-aft position
- ⑥ Seat backrest inclination

▶ Save the settings with the memory function (→ page 128).

- ⓘ The head restraint height will be adjusted automatically when you adjust the seat height or the seat fore-and-aft position.

Adjusting the 4-way lumbar support

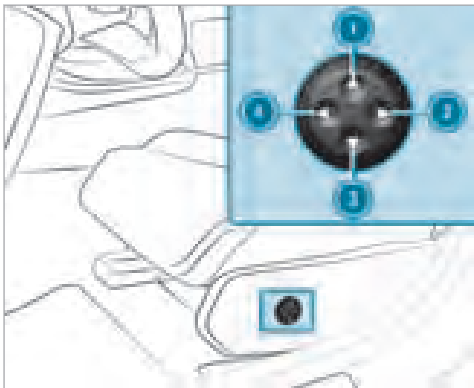

- ① Higher
② Softer

- ③ Lower
④ Firmer

- ▶ Use buttons ① to ④ to adjust the contour of the backrest.

Head restraints

Adjusting the head restraints on the front seats

- ⚠ **WARNING** Risk of accident due to adjusting the vehicle settings while the vehicle is in motion

You could lose control of the vehicle in the following situations in particular:

- if you adjust the driver's seat, the head restraint, the steering wheel or the mirror while the vehicle is in motion
 - if you fasten your seat belt while the vehicle is in motion
- ▶ Before starting the vehicle: in particular, adjust the driver's seat, head restraint,

steering wheel and mirror, and fasten your seat belt.

- ⚠ **WARNING** Risk of injury due to incorrectly adjusted head restraints

If head restraints have not been adjusted correctly, there is an increased risk of injury in the head and neck area, e.g. in the event of an accident or sudden braking.

- ▶ Before driving off, make sure for every vehicle occupant that the centre of the head restraint supports the back of the head at about eye level.

Adjust the head restraint fore-and-aft position so that it is as close as possible to the back of your head.

Seats with manual and electric seat adjustment

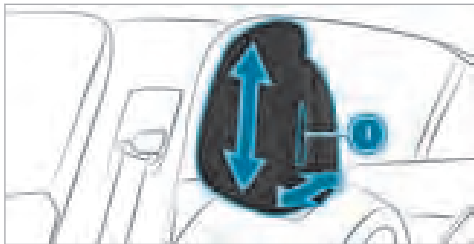

- ▶ Take hold of the head restraint on both sides and press release knob ①.
- ▶ **To move forwards or backwards:** pull the head restraint forwards or push it backwards.
- ▶ **To move upwards or downwards:** push the head restraint upwards or downwards.
- ▶ Let go of release knob ①.

Seats with electric seat adjustment

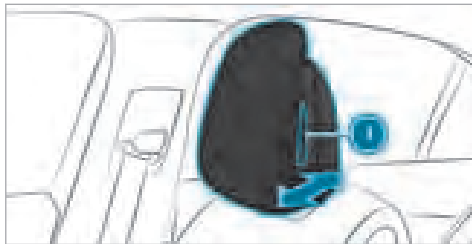

- ▶ Take hold of the head restraint on both sides and press release knob ①.
- ▶ **To move forwards or backwards:** pull the head restraint forwards or push it backwards.
- ▶ Let go of release knob ①.
- ▶ **To move upwards or downwards:** adjust the head restraint using the buttons on the door operating unit (→ page 114).

Adjusting the head restraints of the rear seats manually

⚠ WARNING Risk of injury due to head restraints not being fitted or being adjusted incorrectly

If head restraints have not been installed or have not been adjusted correctly, there is an increased risk of injury in the head and neck area, e.g. in the event of an accident or when braking.

- ▶ Always drive with the head restraints fitted.
- ▶ Before driving off, make sure for every vehicle occupant that the centre of the head restraint supports the back of the head at about eye level.

Adjust the head restraint fore-and-aft position so that it is as close as possible to the back of your head.

- ① Move all head restraints up at least to the first detent. If a head restraint is in the lowest, non-locked position, the respective seat must not be used.

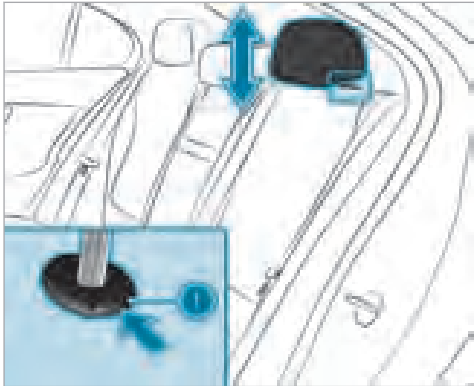

- ▶ **To raise:** push release knob ① in the direction of the arrow and pull the head restraint up until it engages.

- ▶ **To lower:** press release knob ① in the direction of the arrow and push the head restraint down until it engages.

■ Fitting/removing the rear seat head restraints

⚠ WARNING Risk of injury due to head restraints not being fitted or being adjusted incorrectly

If head restraints have not been installed or have not been adjusted correctly, there is an increased risk of injury in the head and neck area, e.g. in the event of an accident or when braking.

- ▶ Always drive with the head restraints fitted.
- ▶ Before driving off, make sure for every vehicle occupant that the centre of the head restraint supports the back of the head at about eye level.

Adjust the head restraint fore-and-aft position so that it is as close as possible to the back of your head.

Removing

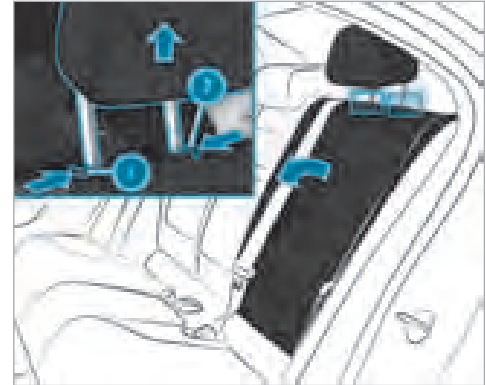

- ▶ Release the rear seat backrest and fold it forwards slightly (→ page 133).
- ▶ Press release knob ② and pull the head restraint upwards as far as it will go. Release knob ① will extend.

- ▶ Push both release knobs ① and ② at the same time in the direction of the arrow and pull out the head restraint.
- ▶ Fold the rear seat backrest back until it engages.

Fitting

- ▶ Release the rear seat backrest and fold it forwards slightly (→ page 133).
- ▶ Insert the head restraint such that the notches on the bar are on the left when viewed in the direction of travel.
- ▶ Push the head restraint down until it engages.
- ▶ Fold the rear seat backrest back until it engages.

Configuring the seat settings

Multimedia system:

 ▶▶ Comfort ▶▶ Seat

Adjusting the air cushions

- ▶ In the corresponding menu, adjust the air cushions for **Lumbar** or **Side bolsters**.

Setting the seat heating balance

- ▶ Select **Heating settings**.
- ▶ Select **Seat heating balance**.
- ▶ Adjust the heat distribution for the desired seat.

Setting automatic seat adjustment

⚠ WARNING Risk of becoming trapped during adjustment of the driver's seat after calling up a driver profile

Selecting a user profile may trigger an adjustment of the driver's seat to the position saved under the user profile. You or other vehicle occupants could be injured in the process.

- ▶ Make sure that when the position of driver's seat is being adjusted using the multimedia system, no people or body parts are in the seat's range of movement.

If there is a risk of someone becoming trapped, immediately stop the adjustment process by:

- ▶ a) Pressing the warning message on the central display.
- or
- ▶ b) Pressing a position button of the memory function or a seat adjustment switch in the driver's door.
The adjustment process is stopped.

Multimedia system:

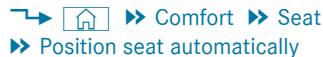
 ▶▶ Comfort ▶▶ Seat
▶▶ Position seat automatically

Manually adjusting driver's seat and steering wheel position to body size

The vehicle calculates a suitable driver's seat and steering wheel position on the basis of the driver's body size and sets this directly.

- ▶ **To set the unit of measurement:** select **cm** or **ft/in**.
- ▶ Set the size using the scale.
- ▶ Select **Start positioning**.
The driver's seat and steering wheel position is adjusted to the body size that has been set.

- ① You can also configure these settings via the Mercedes me user account for your user profile. By synchronising the profiles in the vehicle and the Mercedes me connect profiles, you can carry over these settings for your vehicle. Further information about synchronising user profiles (→ page 339).
- ① If the driver's seat and steering wheel position calculated by the vehicle is not practical or comfortable, it can be manually adapted at any time via the control buttons. The outside mirrors are not set via this function. Instead, they have to be set manually via the operating switches.

Overview of relaxation programmes

- ① Depending on the vehicle equipment, different massage programmes are available:
 - **Classic Massage** Calming back relaxation programme.
 - **Relaxing Massage** Relaxing back massage with increasing wave motions and then soothing movements.

- **Wave Massage** Regenerating relaxation programme via soothing waves across the back and in the seat cushion.
- **Deep Wave Massage:** Wave-like movements in the cushion can promote blood flow and metabolic processes in the legs.
- **Hot Stone Massage:** Massage combined with heat. A back massage is started. In addition, warm pressure points become noticeable, starting in the pelvic area.
- **Activating Massage:** This massage is designed to aid your health and attention on long journeys. The activating stimulation including deliberately chosen pauses to keep you attentive and awake in monotonous driving conditions.

Selecting a relaxation programme for the front seats

Multimedia system:

→  » Comfort » Massage

- ▶ Select a massage programme (→ page 121).

- ▶ Start the programme for the desired seat .

- ▶ **To set the relaxation intensity:** switch **High intensity** on or off .

- ① The availability of this function is dependent on the vehicle's equipment.

Resetting seat settings

Multimedia system:

→  » Comfort » Seat

- ▶ Select **Reset**.

- ▶ Select  for the desired seat.

Switching the seat heating on/off

⚠ WARNING Risk of burns due to repeatedly switching on the seat heating

Repeatedly switching on the seat heating can cause the seat cushion and seat backrest padding to become very hot.

In particular, the health of persons with limited temperature sensitivity or a limited ability to react to high temperatures may be affected or they may even suffer burn-like injuries.

- ▶ Do not repeatedly switch on the seat heating.

To protect against overheating, the seat heating may be temporarily deactivated after it has been switched on repeatedly.

! **NOTE** Damage to the seats caused by objects or documents when the seat heater is switched on

When the seat heater is switched on, overheating may occur due to objects or documents placed on the seats e.g. seat cushions or child seats. This could cause damage to the seat surface.

- ▶ Make sure that no objects or documents are on the seats when the seat heater is switched on.

Requirements

- The power supply is switched on.



- ▶ Press button ① for the respective seat repeatedly until the desired heating level is reached. Depending on the heating level, up to three indicator lamps will light up. If all indicator lamps are off, the seat heating is switched off.

- ① The seat heating will automatically switch down from the three heating levels after 8, 10 and 20 minutes until the seat heating switches off.
- ① If you switch the power supply off and on again within 20 minutes, the previous setting of the seat heating for the driver's seat will remain active.
- ① You can set the heat distribution of the heated sections among the seat cushions and seat backrests of the front seats in the multimedia system (→ page 120).

Setting the panel heating

Multimedia system:

- ➔ ➔ **Comfort** ➔ **Seat** ➔ **Heating settings** ➔ **Panel heating**

The armrests can be heated when the seat heating is switched on.

- ▶ Switch the function for the desired seats on or off.

Switching the seat ventilation on/off

Requirements:

- The power supply is switched on.

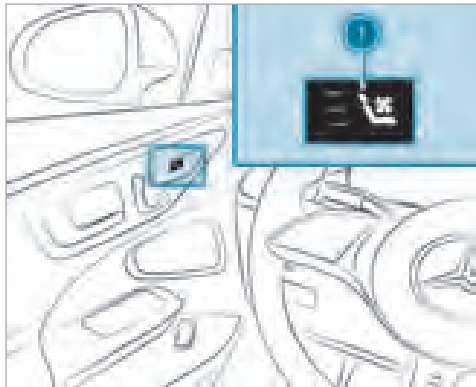

- ▶ Press button ① for the respective seat repeatedly until the desired blower setting is reached. Depending on the blower setting, up to three indicator lamps will light up. If all indicator

lamps are off, the seat ventilation is switched off.

- ① If you switch the power supply off and on again within 20 minutes, the previous seat ventilation setting for the driver's seat will remain active.

Steering wheel

Adjusting the steering wheel manually

- ⚠ **WARNING** Risk of accident due to adjusting the vehicle settings while the vehicle is in motion

You could lose control of the vehicle in the following situations in particular:

- if you adjust the driver's seat, the head restraint, the steering wheel or the mirror while the vehicle is in motion
- if you fasten your seat belt while the vehicle is in motion
- ▶ Before starting the vehicle: in particular, adjust the driver's seat, head restraint,

steering wheel and mirror, and fasten your seat belt.

- ⚠ **WARNING** Risk of entrapment for children when adjusting the steering wheel

Children could injure themselves if they adjust the steering wheel.

- ▶ Never leave children unattended in the vehicle.
- ▶ When leaving the vehicle, always take the key with you and lock the vehicle.

This also applies to the Digital Vehicle Key.

Unlocking

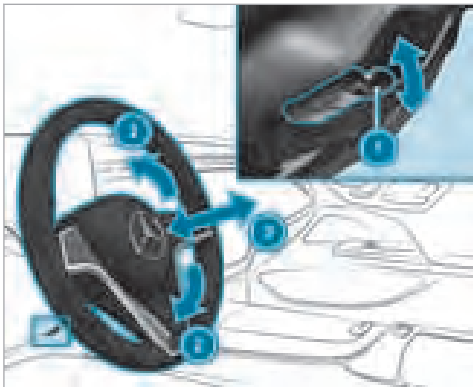

- ▶ Fold release lever ① down as far as it will go.
- ▶ Adjust height ② and distance ③ to the steering wheel.

Locking

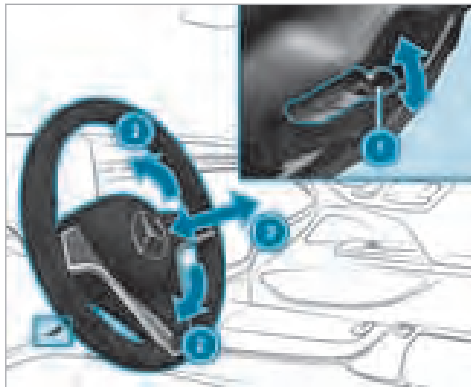

- ▶ Fold release lever ① up as far as it will go.
- ▶ Check and make sure that the steering column is locked by moving the steering wheel.

Adjusting the steering wheel electrically

⚠ WARNING Risk of accident due to adjusting the vehicle settings while the vehicle is in motion

You could lose control of the vehicle in the following situations in particular:

- if you adjust the driver's seat, the head restraint, the steering wheel or the mirror while the vehicle is in motion
- if you fasten your seat belt while the vehicle is in motion

▶ Before starting the vehicle: in particular, adjust the driver's seat, head restraint, steering wheel and mirror, and fasten your seat belt.

⚠ WARNING Risk of entrapment for children when adjusting the steering wheel

Children could injure themselves if they adjust the steering wheel.

- ▶ Never leave children unattended in the vehicle.
- ▶ When leaving the vehicle, always take the key with you and lock the vehicle.

This also applies to the Digital Vehicle Key. The steering wheel can be adjusted when the power supply is disconnected.

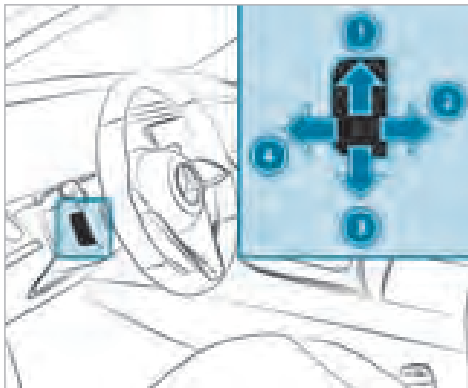

- ① To move up
- ② To move back
- ③ To move down
- ④ To move forward

- ▶ Save the settings with the memory function (→ page 128).

Linking the steering wheel heater to the seat heating

Requirements

- The power supply or the vehicle has been switched on.

Multimedia system:

- >> Comfort >> Seat >> Heating settings

- ▶ Tap on **Additional steering wheel heater**. The steering wheel heater will be linked to the seat heating.

When the function has been activated, the steering wheel heater will automatically be activated and deactivated when you switch the seat heating on and off.

Easy entry and exit feature

Using the easy entry and exit feature

⚠ WARNING Risk of accident when pulling away during the adjustment process of the easy entry and exit feature

You could lose control of the vehicle.

▶ Always wait until the adjustment process is complete before driving off.

This also applies to the Digital Vehicle Key.

Vehicles with memory function: you can stop the adjustment process by pressing one of the memory function position switches.

⚠ WARNING Risk of becoming trapped if children activate the easy entry and exit feature

Children could become trapped if they activate the easy entry and exit feature, particularly when unattended.

▶ Never leave children unattended in the vehicle.

▶ When leaving the vehicle, always take the key with you and lock the vehicle.

This also applies to the Digital Vehicle Key. In order to use the easy entry and exit feature, the automatic seat adjustment function must have been switched on (→ page 120).

When the easy entry and exit feature is active, the steering wheel and driver's seat will move as follows:

- The steering wheel will move upwards.
- The driver's seat will move forward or backward to a seat position suitable for getting out of the vehicle.

This will occur in the following situations:

- You switch off the vehicle when the driver's door is open.
- You open the driver's door when the vehicle is switched off.

i The steering wheel will then move upwards only if it is not already as high as it will go. The driver's seat will then move backwards

only if it is not already at the rear of the seat adjustment range.

The steering wheel and the driver's seat will move back to the last driving position in the following cases:

- You switch the power supply or the vehicle on when the driver's door is closed.
- You close the driver's door when the vehicle is switched on.

The last drive position will be saved when:

- You switch off the vehicle.
- **Vehicles with memory function:** you call up the seat settings via the memory function.

Vehicles with memory function: press one of the memory function position switches to stop the adjustment process.

Setting the easy entry and exit feature

Requirements

- The automatic seat adjustment has been activated (→ page 120).

Multimedia system:

➔  ➔ Settings ➔ Vehicle
➔ Easy entry and exit feature

▶ Select **Steering wheel and seat, Steering wheel only** or **Off**.

ⓘ If you are using an individual user profile, this information is used for the easy entry and exit feature. This will cause the driver's seat and steering wheel to move into the correct position automatically (→ page 336).

Memory function

Function of the memory function

⚠ WARNING Risk of an accident if the memory function is used while driving

If you use the memory function on the driver's side while driving, you could lose control of the vehicle as a result of the adjustments being made.

▶ Only use the memory function on the driver's side when the vehicle is stationary.

⚠ WARNING Risk of entrapment when adjusting the seat with the memory function

When the memory function adjusts the seat, you and other vehicle occupants – particularly children – could become trapped.

- ▶ During the adjusting process of the memory function, ensure that no body parts are in the area of movement of the seat or the steering wheel.
- ▶ If someone becomes trapped, press a preset position button or seat adjustment switch immediately. The adjustment process is stopped.

⚠ WARNING Danger of entrapment when memory function is activated by children

When children activate the memory function, they can get trapped, especially if they are unsupervised.

- ▶ Never leave children unattended in the vehicle.
- ▶ When leaving the vehicle, always take the key with you and lock the vehicle.

This also applies to the Digital Vehicle Key.

You can use the memory function when the vehicle is switched off.

Seat adjustments for up to three people can be stored and called up using the memory function.

You can save the following settings for the front seat:

- Seat, backrest, head restraint position and contour of the seat backrest in the lumbar region
- Seat heating: distribution of the heated sections of the seat cushion and seat backrest

- Driver's side: steering wheel position and position of the outside mirrors on the driver's and front passenger sides
- Head-up display

Operating the memory function

⚠ WARNING Risk of an accident if the memory function is used while driving

If you use the memory function on the driver's side while driving, you could lose control of the vehicle as a result of the adjustments being made.

- ▶ Only use the memory function on the driver's side when the vehicle is stationary.

⚠ WARNING Danger of entrapment when memory function is activated by children

When children activate the memory function, they can get trapped, especially if they are unsupervised.

- ▶ Never leave children unattended in the vehicle.
- ▶ When leaving the vehicle, always take the key with you and lock the vehicle.

This also applies to the Digital Vehicle Key. You can use the memory function when the vehicle is switched off.

Storing

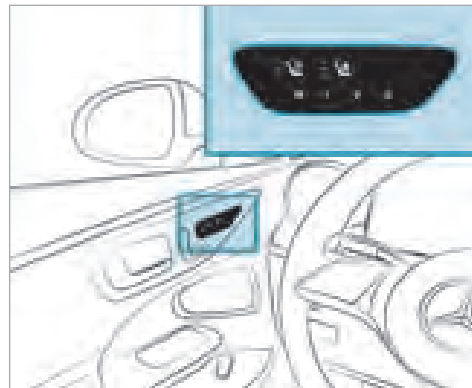

- ▶ Set the seat, the steering wheel, the head-up display and the outside mirror to the desired position.
- ▶ Press the **M** button and then release it.

- ▶ Press one of the preset position buttons **1**, **2** or **3** within three seconds. An acoustic signal sounds. The settings are stored.

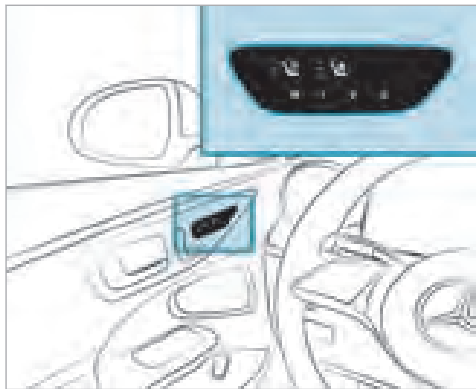

- ▶ **To call up:** press the preset position button **1**, **2** or **3**. The seat is moved to the stored position. After releasing the button, the front seat, outside mirror, head-up display and steering column

continue to move into the stored position automatically.

Stowage areas

Notes on loading the vehicle

⚠ DANGER Risk of exhaust gas poisoning

Combustion engines emit poisonous exhaust gases such as carbon monoxide. Exhaust gases can enter the vehicle interior if the boot lid is open when the engine is running, especially if the vehicle is in motion.

- ▶ Always switch off the engine before opening the boot lid.
- ▶ Never drive with the boot lid open.

Objects in the deployment area of an airbag may prevent the airbag from functioning correctly. Observe the notes on protection provided by the airbag (→ page 47).

⚠ WARNING Risk of injury from unsecured items in the vehicle

If objects, luggage or loads are not secured or not secured sufficiently, they could slip, tip over or be thrown around and thereby hit vehicle occupants.

There is a risk of injury, particularly in the event of sudden braking or a sudden change in direction.

- ▶ Always stow objects in such a way that they cannot be thrown around.
- ▶ Before the journey, secure objects, luggage or loads against slipping or tipping over.

⚠ WARNING Risk of injury due to objects being stowed incorrectly

If objects in the vehicle interior are stowed incorrectly, they can slide or be thrown around and hit vehicle occupants. In addition, cup holders, open stowage spaces and mobile phone brackets cannot always retain all objects they contain.

There is a risk of injury, particularly in the event of sudden braking or a sudden change in direction.

- ▶ Always stow objects in such a way that they cannot be thrown around in such situations.
- ▶ Always make sure that objects do not protrude from stowage spaces, luggage nets or stowage nets.
- ▶ Close the lockable stowage spaces before starting a journey.
- ▶ Always stow and secure heavy, hard, pointed, sharp-edged, fragile or bulky objects in the boot.

⚠ WARNING Risk of accident from objects in the driver's footwell and front-passenger footwell

Objects in the driver's footwell and front-passenger footwell may impede pedal travel or block a depressed pedal.

This jeopardises the operating and road safety of the vehicle.

- ▶ Stow all objects in the vehicle securely so that they cannot get into the driver's footwell or front-passenger footwell.
- ▶ Always fit the floor mats securely and as prescribed in order to ensure that there is always sufficient clearance for the pedals.
- ▶ Do not use loose floor mats and do not lay multiple floor mats on top of one another.

Vehicles with automatic front-passenger airbag shutoff:

Objects trapped under the front-passenger seat may interfere with the operation of the automatic front-passenger airbag shutoff or damage the system. Please observe the notes on the operation of the automatic front-passenger airbag shutoff .

⚠ WARNING Risk of burns from the tailpipe and tailpipe trims

The exhaust tailpipe and tailpipe trims can become very hot. If you come into contact

with these parts of the vehicle, you could burn yourself.

- ▶ Always be particularly careful around the tailpipe and the tailpipe trims and supervise children especially closely in this area.
- ▶ Allow vehicle parts to cool down before touching them.

i Leather is a natural product. It exhibits natural surface properties such as, e. g. differences in structure, marks caused by growth and injury or subtle colour differences. These surface properties are characteristics of leather and not material faults. Leather is also subject to a natural ageing process during which the surface properties change.

The handling characteristics of your vehicle are dependent on the distribution of the load within the vehicle. You should bear the following in mind when loading the vehicle:

- Do not exceed the permissible total mass or the permissible axle loads of the vehicle (including load and occupants).

information can be found on the vehicle identification plate (→ page 630).

- The load must not protrude above the upper edge of the seat backrests.
- Always place the load behind unoccupied seats if possible.
- Secure the load using the lashing eyelets and distribute the load evenly.

Notes on driving with a roof load

- Distribute the roof load and the load inside the vehicle evenly, placing heavy objects at the bottom. Also comply with the notes on loading the vehicle (→ page 129).
- Drive attentively, avoiding abrupt starts, braking and steering as well as rapid cornering.
- When transporting roof loads and when the vehicle is fully loaded or fully occupied, select one of the driving modes **E** or **C**. These are designed to focus on stability (→ page 194).

Stowage spaces in the vehicle interior

Overview of the front stowage compartments

⚠ WARNING Risk of injury due to objects being stowed incorrectly

If objects in the vehicle interior are stowed incorrectly, they can slide or be thrown around and hit vehicle occupants. In addition, cup holders, open stowage spaces and mobile phone brackets cannot always retain all objects they contain.

There is a risk of injury, particularly in the event of sudden braking or a sudden change in direction.

- ▶ Always stow objects in such a way that they cannot be thrown around in such situations.
- ▶ Always make sure that objects do not protrude from stowage spaces, luggage nets or stowage nets.
- ▶ Close the lockable stowage spaces before starting a journey.

- ▶ Always stow and secure heavy, hard, pointed, sharp-edged, fragile or bulky objects in the boot.

Observe the notes on loading the vehicle.

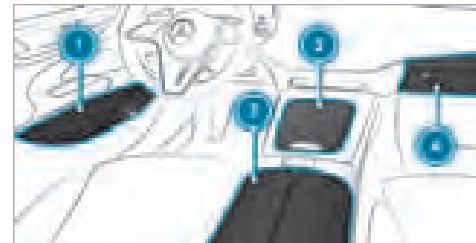

- ① Stowage spaces in the doors
- ② Stowage and telephone compartment beneath the armrest with USB ports
- ③ Stowage compartment in the front centre console with cup holders, USB ports and charging module for wireless charging of mobile phones
- ④ Glove compartment

- ① The compartment under armrest ② and the stowage compartment in centre console ③ are connected via a channel so that cables can be routed through them. This allows, for example, USB cables for connecting devices to be stowed in both compartments.
- ① The rubber mat in the stowage compartment in front centre console ③ can be removed for cleaning with clean, lukewarm water. Please comply with the notes on caring for the interior (→ page 482).

Opening and closing the stowage compartment in the front centre console

⚠ WARNING Risk of injury due to objects being stowed incorrectly

If objects in the vehicle interior are stowed incorrectly, they can slide or be thrown around and hit vehicle occupants. In addition, cup holders, open stowage spaces and mobile phone brackets cannot always retain all objects they contain.

There is a risk of injury, particularly in the event of sudden braking or a sudden change in direction.

- ▶ Always stow objects in such a way that they cannot be thrown around in such situations.
- ▶ Always make sure that objects do not protrude from stowage spaces, luggage nets or stowage nets.
- ▶ Close the lockable stowage spaces before starting a journey.
- ▶ Always stow and secure heavy, hard, pointed, sharp-edged, fragile or bulky objects in the boot.

Observe the notes on loading the vehicle.



- ▶ **To open:** slide the cover of the stowage compartment in the front centre console all the way forwards in the direction of the arrow using handle ①.
- ▶ **To close:** briefly push handle ① of the open cover of the stowage compartment in the front centre console forwards. The cover will automatically close the stowage compartment in the front centre console.

Locking/unlocking the glove compartment

⚠ WARNING Risk of injury due to objects being stowed incorrectly

If objects in the vehicle interior are stowed incorrectly, they can slide or be thrown around and hit vehicle occupants. In addition, cup holders, open stowage spaces and mobile phone brackets cannot always retain all objects they contain.

There is a risk of injury, particularly in the event of sudden braking or a sudden change in direction.

- ▶ Always stow objects in such a way that they cannot be thrown around in such situations.
- ▶ Always make sure that objects do not protrude from stowage spaces, luggage nets or stowage nets.
- ▶ Close the lockable stowage spaces before starting a journey.

- ▶ Always stow and secure heavy, hard, pointed, sharp-edged, fragile or bulky objects in the boot.

Observe the notes on loading the vehicle.

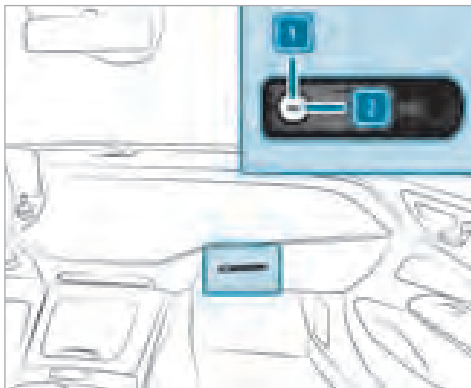

- ▶ Turn the emergency key a quarter turn clockwise **2** (to lock) or anti-clockwise **1** (to unlock).

Through-loading feature in the rear bench seat (EASY-PACK Quickfold)

Folding the rear seat backrests forward

⚠ WARNING Risk of becoming trapped when adjusting the seats

When you adjust a seat, you may trap yourself or a vehicle occupant.

- ▶ When adjusting a seat, make sure that no one has any body parts in the sweep of the seat.

⚠ WARNING Risk of an accident because the seat backrest is not engaged

The seat backrest may fold forwards.

There is a risk of the following, in particular:

- The vehicle occupant may be pressed against the seat belt. The seat belt cannot protect as intended and could cause additional injury.

- A child restraint system is no longer properly supported or properly positioned and may no longer fulfil its function as intended.
- The seat backrest cannot restrain objects or goods in the boot or load compartment.

Always ensure that the seat backrest is engaged, especially:

- After the seat has been adjusted.
- After the load compartment enlargement has been folded forwards

Make sure that the red marking of the lock verification indicator is no longer visible. Otherwise, the seat backrest is not locked.

Always ensure that all vehicle occupants have their seat belts fastened correctly and are sitting properly. Particular attention must be paid to children.

Requirements:

- The rear seat backrest head restraints are fully inserted.

- The rear armrest has been folded up.

Folding the rear outer seat backrests forward

You can fold the centre and right seat backrests forwards separately.

The left seat backrest can be folded forwards only together with the centre seat backrest.

If you no longer require the folded-down rear seat backrest as a load area, fold the backrest back into place.

- ▶ Ensure that the centre seat backrest is in an upright position and locked to the left seat backrest (→ page 137).

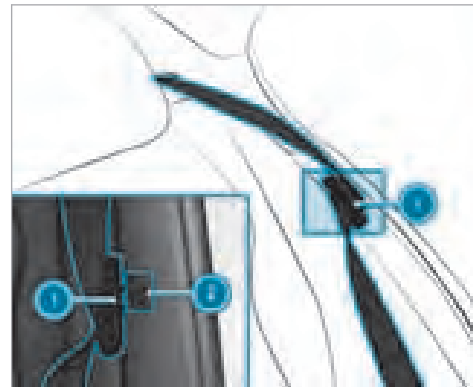

- ▶ Press the seat belt tongue of seat belt ① into marked position ②.
- ▶ Move the driver's or front passenger seat forwards, if necessary.

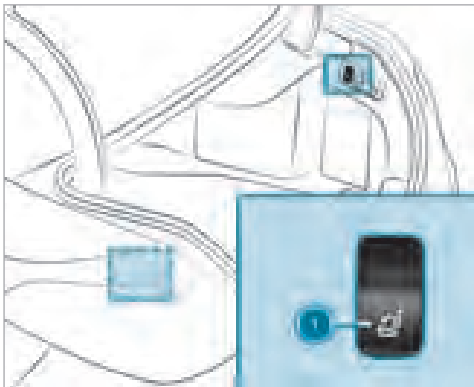

- ▶ **To fold the left seat backrest forward:** briefly press left button ①. The left seat backrest folds forward together with the centre seat backrest.
If the left seat backrest is not locked with the centre seat backrest, this will be shown on the central display.

- ▶ **To fold the right seat backrest forward:** briefly press right button ①. The right seat backrest will fold forwards.
- ① If you wish to fold only one of the outer seat backrests forwards, fold the right seat backrest forwards.

Folding the centre rear seat backrest forwards separately

If you no longer require the folded-down seat backrest as a load area, fold the backrest back into place.

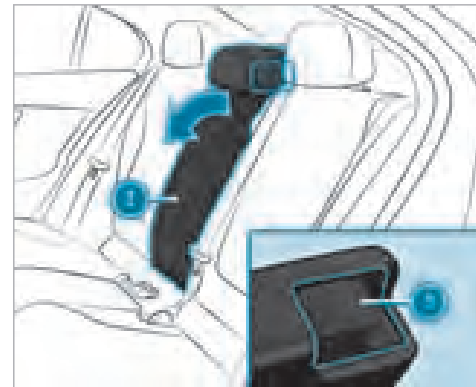

- ▶ Press release catch ③.
- ▶ Fold seat backrest ② forwards.

Folding back the rear seat backrest

⚠ WARNING Risk of becoming trapped when adjusting the seats

When you adjust a seat, you may trap yourself or a vehicle occupant.

- ▶ When adjusting a seat, make sure that no one has any body parts in the sweep of the seat.

⚠ WARNING Risk of an accident because the seat backrest is not engaged

The seat backrest may fold forwards.

There is a risk of the following, in particular:

- The vehicle occupant may be pressed against the seat belt. The seat belt cannot protect as intended and could cause additional injury.
- A child restraint system is no longer properly supported or properly positioned and may no longer fulfil its function as intended.
- The seat backrest cannot restrain objects or goods in the boot or load compartment.

Always ensure that the seat backrest is engaged, especially:

- After the seat has been adjusted.

- After the load compartment enlargement has been folded forwards

Make sure that the red marking of the lock verification indicator is no longer visible. Otherwise, the seat backrest is not locked.

Always ensure that all vehicle occupants have their seat belts fastened correctly and are sitting properly. Particular attention must be paid to children.

⚠ NOTE Damage caused by trapping the seat belt when folding back the seat backrest

The seat belt could become trapped and thus be damaged when the seat backrest is folded back.

- ▶ Make sure that the seat belt is not trapped when folding back the seat backrest.



- ▶ Move the driver's or front passenger seat forwards, if necessary.
- ▶ Swivel seat backrest ① back until it engages. If the seat backrest is not engaged and locked in place, red lock verification indicator ② will be visible.

Locking and releasing the release catch of the centre rear seat backrest

⚠ WARNING Risk of becoming trapped when adjusting the seats

When you adjust a seat, you may trap yourself or a vehicle occupant.

- ▶ When adjusting a seat, make sure that no one has any body parts in the sweep of the seat.

⚠ WARNING Risk of an accident because the seat backrest is not engaged

The seat backrest may fold forwards.

There is a risk of the following, in particular:

- The vehicle occupant may be pressed against the seat belt. The seat belt cannot protect as intended and could cause additional injury.
- A child restraint system is no longer properly supported or properly positioned and

may no longer fulfil its function as intended.

- The seat backrest cannot restrain objects or goods in the boot or load compartment.

Always ensure that the seat backrest is engaged, especially:

- After the seat has been adjusted.
- After the load compartment enlargement has been folded forwards

If the seat backrests are not engaged and locked in place, the red lock verification indicators will be visible.

Always ensure that all vehicle occupants have their seat belts fastened correctly and are sitting properly. Particular attention must be paid to children.

You can lock the centre seat backrest release catch if you want to secure the boot against unauthorised access. The centre seat backrest can then be folded forwards only together with the left seat backrest.

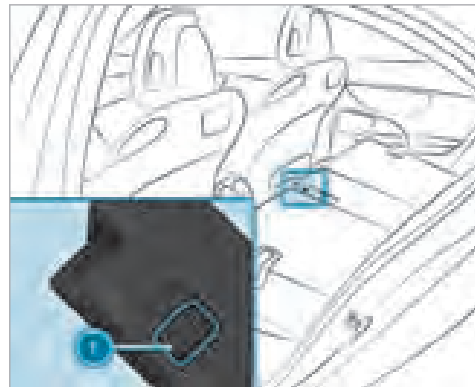

- ▶ **To lock or unlock:** slide catch ① upwards or downwards.

Overview of the tie-down eyes

Observe the notes on loading the vehicle (→ page 129).

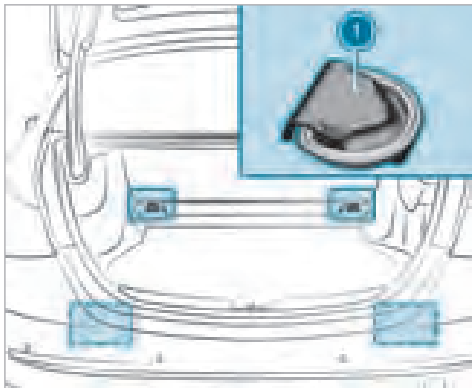

① Tie-down eyes

Objects or items of luggage may be flung around and hit vehicle occupants.

- ▶ Only hang light objects on the bag hooks.
- ▶ Never hang hard, sharp-edged or fragile objects on the bag hooks.

Observe the notes on loading the vehicle (→ page 129).

Subject the bag hooks to a maximum load of 3 kg and do not attach any goods to them.

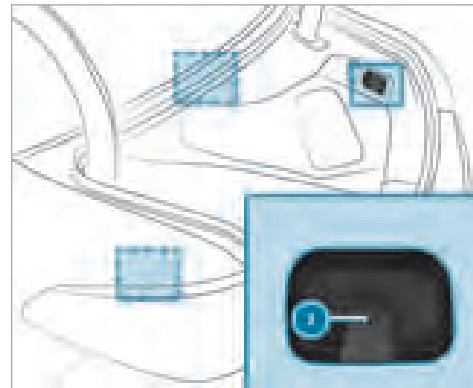

① Bag hooks

Overview of bag hooks

⚠ WARNING Risk of injury when using bag hooks with heavy objects

The bag hooks cannot restrain heavy objects or items of luggage.

Attaching a roof luggage rack

⚠ WARNING Risk of accident due to exceeding the maximum roof load

The vehicle centre of gravity and the usual driving characteristics as well as the steering and braking characteristics alter.

If you exceed the maximum roof load, the driving characteristics, as well as steering and braking, will be greatly impaired.

- ▶ Never exceed the maximum roof load and adjust your driving style.

You will find information on the maximum roof load in the "Technical data" section in the printed Owner's Manual.

! NOTE Damage to the vehicle due to not observing the maximum permitted headroom clearance

If the vehicle height is greater than the maximum permitted headroom clearance, the roof and other parts of the vehicle may be damaged.

- ▶ Observe the signposted headroom clearance.
- ▶ If the vehicle height is greater than the permitted headroom clearance, do not enter.
- ▶ Observe the changed vehicle height with add-on roof equipment.

! NOTE Damage to the panorama sliding sunroof due to non-approved roof luggage racks

The panorama sliding sunroof may be damaged by the roof luggage rack if you attempt to open it when using a roof luggage rack not tested and approved for Mercedes-Benz.

- ▶ When a roof luggage rack is fitted, open the panorama sliding sunroof only if this has been tested and approved for Mercedes-Benz.

The panorama sliding sunroof may be raised to allow ventilation of the vehicle interior.

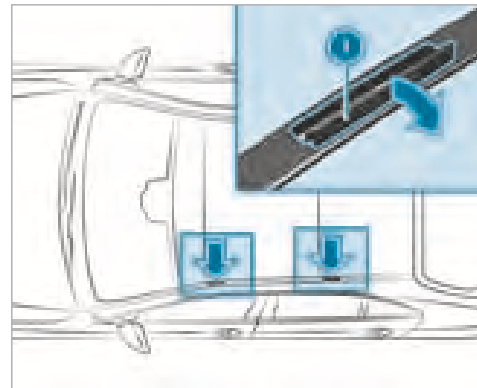

! NOTE Damage to the covers

The covers may be damaged and scratched when being opened.

- ▶ Do not use metallic or hard objects.

- ▶ Carefully fold covers ① upwards in the direction of the arrow.

- ▶ Secure the roof luggage rack to the fastening points beneath covers ①.
- ▶ Comply with the installation instructions of the roof luggage rack manufacturer.
- ▶ Secure the load on the roof luggage rack.

Cup holders

Fitting or removing the cup holder in the centre console

⚠ WARNING - Risk of accident or injury when using the cup holder while the vehicle is in motion

The cup holder cannot hold a container secure while the vehicle is in motion.

If you use a cup holder while the vehicle is in motion, the container may be flung around and liquids could be spilled. The vehicle occupants may come into contact with the liquid and if it is hot, they could be scalded. You could be distracted from traffic conditions and you may lose control of the vehicle.

- ▶ Only use the cup holder when the vehicle is stationary.
- ▶ Only use the cup holder for containers of the right size.
- ▶ Always close the container, particularly if the liquid is hot.

⚠ WARNING Risk of injury due to objects being stowed incorrectly

If objects in the vehicle interior are stowed incorrectly, they can slide or be thrown around and hit vehicle occupants. In addition, cup holders, open stowage spaces and mobile phone brackets cannot always retain all objects they contain.

There is a risk of injury, particularly in the event of sudden braking or a sudden change in direction.

- ▶ Always stow objects in such a way that they cannot be thrown around in such situations.

- ▶ Always make sure that objects do not protrude from stowage spaces, luggage nets or stowage nets.
- ▶ Close the lockable stowage spaces before starting a journey.
- ▶ Always stow and secure heavy, hard, pointed, sharp-edged, fragile or bulky objects in the boot.

The cup holder can be removed for cleaning. Observe the notes on loading the vehicle (→ page 129).

Inserting a cup holder

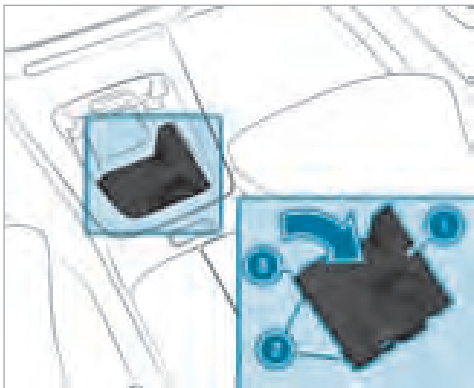

- ▶ Starting with corner ③, insert the cup holder and rotate it into place in the recess in the trim using both tabs ②.
- ▶ Rotate the cup holder into the compartment and push housing ① down until it engages.

Removing the cup holder

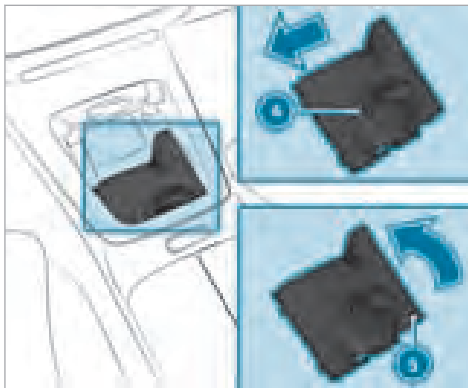

- ▶ Push the side wall of rear beverage compartment ④ to the left until the cup holder releases.
- ▶ Using corner ⑤, swing out the cup holder to the front left.
- ▶ Reinsert the cup holder after cleaning.

Removing/fitting mats

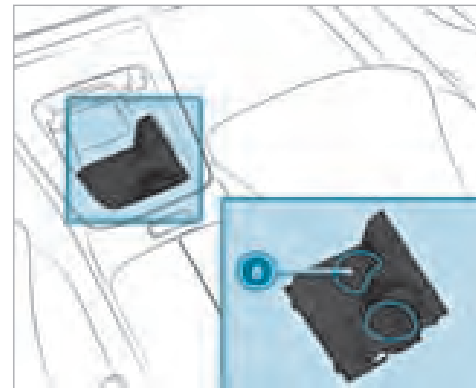

- Insert mats ⑥ in the cup holder beverage compartments can be removed for cleaning.
- ▶ **To remove:** use a suitable tool to push the insert mats out of their mounting from the rear of the removed cup holder.
 - ▶ **To install:** press mats into the cup holder housing until they engage.

Using the cup holder

- ⓘ Check whether the beverage container is held firmly by the cup holder. Some beverage containers will not be secured adequately in the cup holder due to their shape or size.

The side wall of the front beverage compartment can be retracted and extended manually.



- ▶ Gently push a beverage container into the bottom ② of the beverage compartment. The side panel will automatically extend to the left to secure the beverage container.

Alternatively, you can extend the side wall of the beverage compartment by pressing lightly on grooved surface ①.

Retracting the side wall

When the front beverage compartment is not in use, the side panel can be retracted manually. The cup holder's holding function will then no longer be available.



- ▶ Push the side panel back in the direction of the arrow until it engages in correct position ③.

Sockets

Using the 12 V socket in the front passenger footwell

Requirements

- Only connect devices up to a maximum of 180 W (15 A).

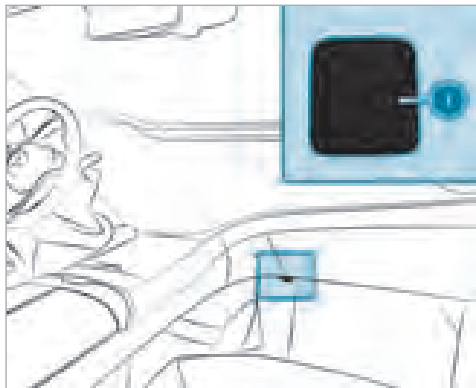

12 V socket in the front passenger footwell

- ▶ Fold up the cap on socket ①.
- ▶ Insert the plug of the device.
- ▶ Make sure that no cables are running through or secured in the airbag deployment area when using the socket. Also observe the notes on airbag protection (→ page 47).

Using USB ports

Depending on its equipment, the vehicle has the following USB ports:

- two USB ports in the stowage compartment in the front centre console
- one or two USB ports in the stowage compartment under the front armrest
- two USB ports in the rear centre console

You can charge a USB device, such as a mobile phone, at the USB ports using a suitable charging cable. Depending on the vehicle equipment, the devices can be charged with up to 20 V (5 A) when the vehicle is switched on.

Wireless charging of the mobile phone and connection with the exterior aerial

Notes on wirelessly charging a mobile phone

⚠ WARNING Risk of injury due to objects being stowed incorrectly

If objects in the vehicle interior are stowed incorrectly, they can slide or be thrown around and hit vehicle occupants. In addition, cup holders, open stowage spaces and mobile phone receptacles cannot always retain all objects within.

There is a risk of injury, particularly in the event of sudden braking or a sudden change in direction.

- ▶ Always stow objects so that they cannot be thrown around in such situations.
- ▶ Always make sure that objects do not protrude from stowage spaces, luggage nets or stowage nets.
- ▶ Close the lockable stowage spaces before starting a journey.

- ▶ Always stow and secure heavy, hard, pointed, sharp-edged, fragile or bulky objects in the boot/load compartment.

Observe the notes on loading the vehicle.

⚠ WARNING Risk of fire from placing objects in the mobile phone stowage compartment

Placing other objects in the mobile phone stowage compartment could constitute a fire hazard.

- ▶ Apart from a mobile phone, do not place any other objects in the mobile phone stowage compartment, especially those made of metal.

! NOTE Damage to objects caused by placing them in the mobile phone stowage compartment

If objects are placed in the mobile phone stowage compartment, these may be damaged by electromagnetic fields.

- ▶ Do not place credit cards, storage media, ski passes or other objects sensitive to electromagnetic fields in the mobile phone stowage compartment.

! NOTE Damage to the mobile phone stowage compartment caused by liquids

If liquids enter the mobile phone stowage compartment, the compartment may be damaged.

- ▶ Ensure that no liquids enter the mobile phone stowage compartment.

Always observe the notes for persons with electronic medical aids (→ page 34).

- Depending on the vehicle equipment, the mobile phone is connected to the vehicle's exterior aerial via the charging module.
- The charging function and wireless connection of the mobile phone to the vehicle's exterior aerial are only available if the vehicle is switched on.

- Small mobile phones may not be able to be charged in every position of the mobile phone stowage compartment.
- Large mobile phones which do not rest flat in the mobile phone stowage compartment may not be able to be charged or connected with the vehicle's exterior aerial.
- The mobile phone may heat up during the charging process. This may also depend on the applications (apps) currently open in the background.
- To ensure more efficient charging and connection with the vehicle's exterior aerial, remove the protective cover from the mobile phone. Protective covers which are necessary for wireless charging are an exception.

Wirelessly charging a mobile phone in the front

⚠ WARNING Risk of injury due to objects being stowed incorrectly

If objects in the vehicle interior are stowed incorrectly, they can slide or be thrown around

and hit vehicle occupants. In addition, cup holders, open stowage spaces and mobile phone brackets cannot always retain all objects they contain.

There is a risk of injury, particularly in the event of sudden braking or a sudden change in direction.

- ▶ Always stow objects in such a way that they cannot be thrown around in such situations.
- ▶ Always make sure that objects do not protrude from stowage spaces, luggage nets or stowage nets.
- ▶ Close the lockable stowage spaces before starting a journey.
- ▶ Always stow and secure heavy, hard, pointed, sharp-edged, fragile or bulky objects in the boot.

Observe the notes on loading the vehicle.

Requirements:

- The mobile phone is suitable for wireless charging.

A list of compatible mobile phones can be found at: <https://www.mercedes-benz-mobile.com/>

It is possible to wirelessly charge a mobile phone in the front stowage compartment of the vehicle's centre console.

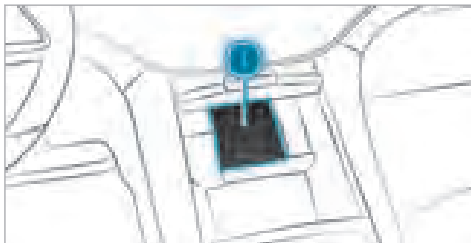

Wirelessly charging a mobile phone in the front stowage compartment

- ▶ Place the mobile phone as close to the centre of mat ① as possible with the display facing upwards.

When the charging symbol is shown in the multi-media system, the mobile phone is being charged.

In addition, malfunctions during the mobile phone's charging process are shown in the multi-media system display.

- ① The mat can be removed for cleaning, e.g. using clean, lukewarm water.

Radio equipment approval numbers for Brazil

This device operates on a secondary basis, that is to say it has no protection against harmful interference, not even from the same type of stations, and must not cause interference with systems operating on a primary basis.

This product is permitted in accordance with the procedure defined in Directive 242/2000 by the Brazilian telecommunications agency ANATEL and meets the applicable technical requirements.

Further information is available on the ANATEL website. www.anatel.gov.br

- ▶ Further information on the declaration of conformity for vehicle components which receive and/or transmit radio waves.

Fitting and removing floor mats

⚠ WARNING Risk of accident due to objects in the driver's footwell

Objects in the driver's footwell may impede pedal travel or block a depressed pedal.

This jeopardises the operating and road safety of the vehicle.

- ▶ Stow all objects in the vehicle securely so that they cannot get into the driver's footwell.
- ▶ Always fit the floor mats securely and as prescribed in order to ensure that there is always sufficient room for the pedals.
- ▶ Do not use loose floor mats and do not place floor mats on top of one another.

Fitting floor mats

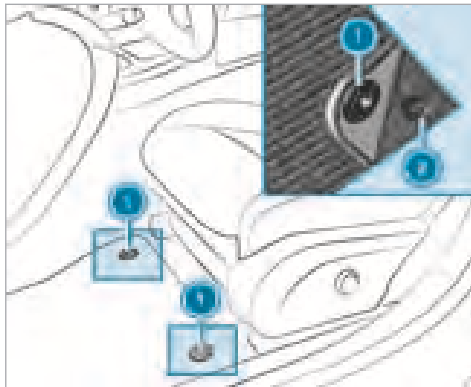

- ▶ Slide the corresponding seat backwards and lay the floor mat in the footwell such that it fits.
- ▶ Press studs ① onto holders ②.
- ▶ Adjust the corresponding seat.

Removing floor mats

- ▶ Slide the corresponding seat backwards and pull the floor mat off holders ②.
- ▶ Adjust the corresponding seat.

Exterior lighting

Notes on adjusting the lights when driving abroad

As a convenience function, the headlamps automatically adjust when you cross the border into countries where traffic drives on the other side of the road. If necessary, the headlamps can also be adjusted manually in the **Low beam** menu (→ page 158).

The automatic light adjustment function is available:

- If Automatic is activated in the **Low beam** menu
- If the navigation and the navigation position are available

In the following cases, check the headlamp setting and change it manually if necessary:

- If the **Low beam setting (left/right-side traffic) Manual adjustment only** display message is displayed.
- If the **Check low beam setting (left/right-side traffic)** display message is displayed.

Following manual adjustment:

- Oncoming traffic will not be dazzled.
- The edge of the road will not be illuminated as far or as high.
- The "motorway mode" and "enhanced fog light" functions will not be available.

Information about lighting systems and your responsibility

The various lighting systems of the vehicle are only aids. The driver of the vehicle is responsible for correct vehicle illumination in accordance with the prevailing light and visibility conditions, legal requirements and traffic situation.

Light switch

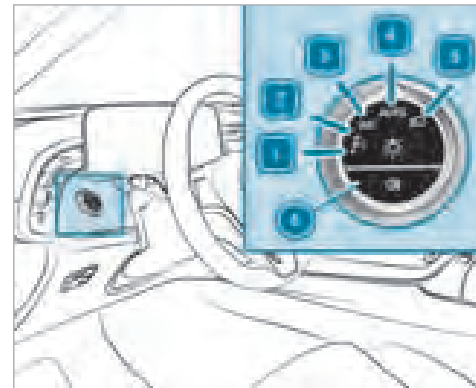

Operating the light switch



- 1 Left-hand parking lights
- 2 Right-hand parking lights
- 3 Standing lights and licence plate lighting
- 4 Automatic driving lights (preferred light switch position)

5  Low beam/high beam

6  Switches the rear fog light on/off.

When low beam is activated, the  indicator lamp for the standing lights will be deactivated and replaced by the  low-beam indicator lamp.

▶ Always park your vehicle safely using sufficient lighting, in accordance with the relevant legal stipulations.

! **NOTE** Battery discharging by operating the standing lights

Do not have the standing lights switched on over a period of several hours.

For vehicles that are wider than 2 m or longer than 6 m, single-sided parking lighting is not permitted in some countries. In this case, the standing lights are also switched on in the parking lights position.

If the battery is insufficiently charged, the standing lights or parking lights will be switched off automatically to facilitate the next engine start.

The exterior lighting (except standing and parking lights) will switch off automatically when the driver's door is opened.

- Observe the notes on locator lighting (→ page 159).

Switching on accident scene lighting

- ▶ Switch off the vehicle.
- ▶ Switch on the hazard warning lights (→ page 150).
- ▶ Turn the light switch from the **AUTO** position to the  position. The low beam will be switched on despite the vehicle being switched off.

The accident scene lighting will be switched off if:

- you switch off the hazard warning lights.
- you turn the light switch back to **AUTO**.
- the battery is insufficiently charged.

Automatic driving lights function

When the vehicle is switched on, the standing lights, low beam and daytime running lights will be switched on automatically depending on the light conditions.

! **WARNING** Risk of accident when the dipped beam is switched off in poor visibility



When the light switch is set to **AUTO**, the dipped beam may not be switched on automatically if there is fog, snow or other causes of poor visibility such as spray.

▶ In such cases, turn the light switch to .

The automatic driving lights are only an aid. You are responsible for the vehicle lighting.

Switching the rear fog light on/off

Requirements:

- The light switch is in the  or **AUTO** position.
- ▶ Press button .

Please observe the country-specific laws on the use of rear fog lamps.

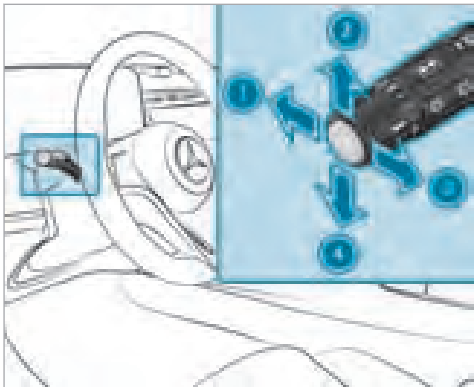

Operating the combination switch for the lights



- ① High beam
- ② Turn signal light, right
- ③ Headlamp flashing
- ④ Turn signal light, left

▶ Use the combination switch to select the desired function.

Switching on high beam

- ▶ Turn the light switch to the  or **AUTO** position.
- ▶ Push the combination switch in the direction of arrow ①.
When high beam is activated, the indicator lamp for low beam  will be deactivated and replaced by the indicator lamp for high beam .

Switching off high beam

- ▶ Push the combination switch in the direction of arrow ① or pull it in the direction of arrow ③.

Headlamp flashing

- ▶ Pull the combination switch in the direction of arrow ③.

Turn signal light

- ▶ **To indicate briefly:** push the combination switch briefly to the point of resistance in the direction of arrow ② or ④.
The corresponding turn signal light will flash three times.

- ▶ **To indicate permanently:** push the combination switch beyond the point of resistance in the direction of arrow ② or ④.

Vehicles with Active Lane Change Assist:

- A turn signal indicator activated by the driver may continue to operate for the duration of the lane change.
- If the driver indicated directly beforehand but a lane change was not immediately possible, the turn signal indicator may activate automatically.

Activating/deactivating the hazard warning lights

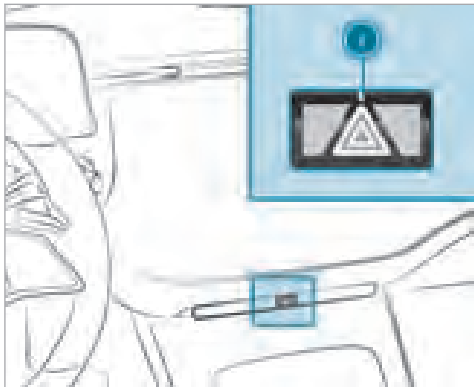

▶ Press button ①.

The hazard warning lights will switch on automatically if:

- the airbag has been deployed.
- the vehicle is braked heavily from a speed of more than 70 km/h to a standstill.

When you pull away again, the hazard warning light system will switch off automatically at approximately 10 km/h. You can also switch off the hazard warning light system using the warning lamp button.

DIGITAL LIGHT adaptive functions

Intelligent Light System function

You can watch an animation on this topic via the following link:

With this system, the headlamps adapt to the driving and weather situation. It also provides extended functions for improved illumination of the road.

The system comprises the following functions:

- Active headlamps (→ page 150)
- Cornering light (→ page 151)
- Motorway mode (→ page 151)
- Enhanced fog light function (→ page 151)
- Bad weather light (→ page 152)
- City lighting (→ page 152)
- Topographical compensation (→ page 152)

The system is active only when it is dark.

Active headlamps function

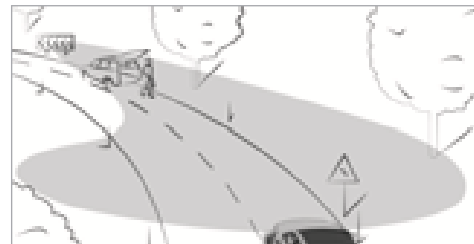

- The headlamps follow the steering movements.
- Relevant areas are better illuminated during a journey.

The functions are active when the low beam is switched on.

Depending on the vehicle's equipment, the course of the lane in which you are driving will also be evaluated and the active headlamps function will adjust the light in advance.

■ Cornering light function

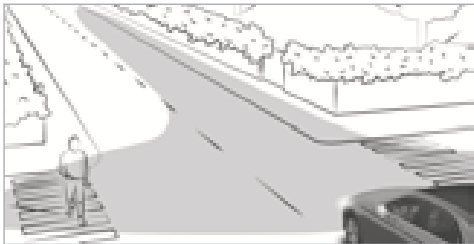

The cornering light improves the illumination of the carriageway over a wide angle in the turning direction, enabling better visibility on tight bends, for example. The cornering light will be activated only when low beam is switched on.

The function will be active in the following cases:

- At speeds below 40 km/h when the turn signal light is switched on or the steering wheel is turned
- At speeds between 40 km/h and 70 km/h and when the steering wheel is turned

Roundabout and junction function: the cornering light will be activated on both sides based on an evaluation of the vehicle's current navigation position. It will remain active until after the vehicle has left the roundabout or junction.

■ Motorway mode function

Motorway mode increases the range and brightness of the cone of light, enabling better visibility.

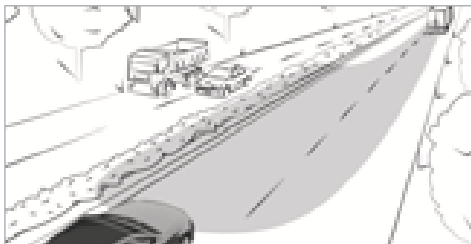

The function will be active if a motorway journey is detected by means of:

- the vehicle's speed
- the multifunction camera
- the navigation system

The function is not active in the following cases:

- at speeds below 80 km/h

■ Enhanced fog light function

The enhanced fog light function reduces self-dazzling and improves the illumination of the edge of the carriageway.

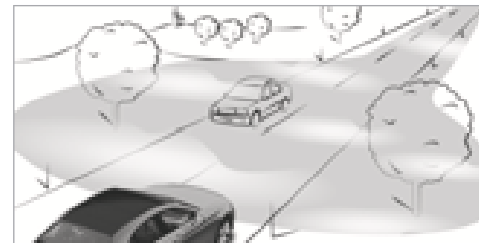

The function is automatically activated under the following conditions:

- At speeds below 70 km/h and when the rear fog light is switched on.

The function is automatically deactivated under the following conditions:

- When speeds greater than 100 km/h are reached.
- When the rear fog light is switched off.

■ Function of the bad weather light

The bad weather light reduces reflections in rainy conditions by dimming individual areas of the headlamps. The driver and other road users are dazzled less as a result.

■ The city lighting function

City lighting improves the illumination of roadsides in urban areas using a broad distribution of light.

The function will be active in the following cases:

- At low speeds
- In illuminated parts of urban areas

■ Function of the topographical compensation

Based on available map data, the lighting system responds pre-emptively to different road heights. This means that the headlamp range remains virtually constant when you are driving on uphill or downhill gradients.

- ① Only vehicles with a multimedia system with navigation have this function.

■ Assistance functions of DIGITAL LIGHT

DIGITAL LIGHT visually expands on the driver assistance systems by projecting the assistant displays in front of the vehicle while it is in motion. DIGITAL LIGHT can therefore help the driver in critical situations.

- ① The availability of the functions is dependent on the country.
- ① The assistance functions of DIGITAL LIGHT may be an on-demand feature (→ page 25).

The system will be active in the following cases:

- The light switch is in the **AUTO** position.
- High beam is switched on.

- ① Depending on the country in which you are currently driving, certain functions may be disabled due to different legal requirements, even if they are enabled in the multimedia system. When you cross a border, the vehicle will automatically adapt to the applicable requirements.

Spotlight

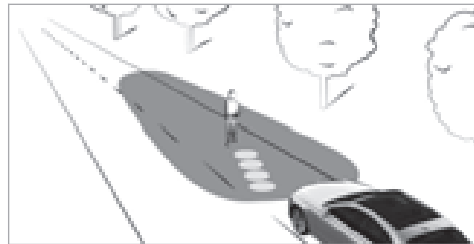

The spotlight function runs in the background and flashes the headlamps in four short bursts at persons detected within the lane markings. You will also be made aware of the position of the person by a projected symbol.

The function will be active in the following circumstances:

- You are driving outside illuminated areas.
- The system detects a lane marking.

Warnings

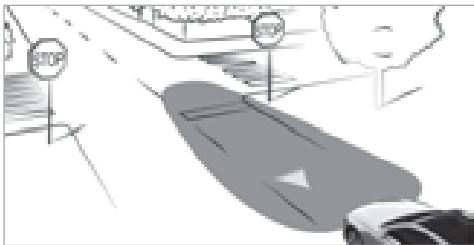

If Traffic Sign Assist detects a corresponding situation, a triangle will be projected onto the road in the following cases at speeds of at least 30 km/h:

- You are driving in the opposite direction to the permissible direction of travel, e.g. on a motorway slip road.
- You are driving towards a stop sign without reducing your speed.
- You are driving towards a red traffic light without reducing your speed.

Observe the system limitations of Traffic Sign Assist (→ page 250).

Notes

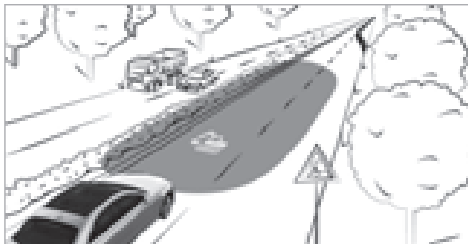

If Traffic Sign Assist detects a roadworks zone, the system will provide support as follows:

- A corresponding symbol will be projected onto the road when you enter a roadworks zone.
- When you drive through a roadworks zone, guide lines that roughly match the width of the vehicle will be projected onto the road. The guide lines will be switched off temporarily on tight bends.

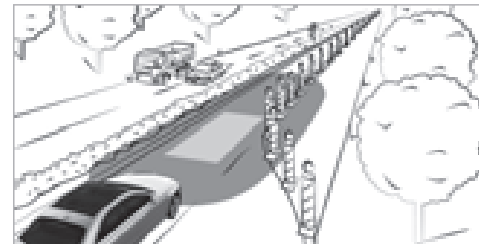

Observe the system limitations of Traffic Sign Assist (→ page 250).

Collision warning

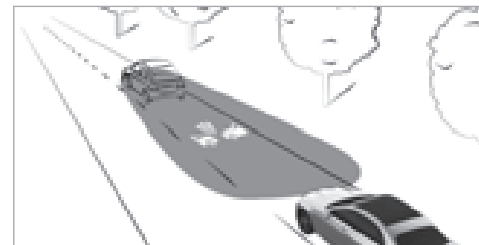

If you fall below the safe distance at speeds of at least 30 km/h, a collision warning symbol will be projected onto the road.

Observe the system limitations of Active Brake Assist (→ page 243).

Lane change warning

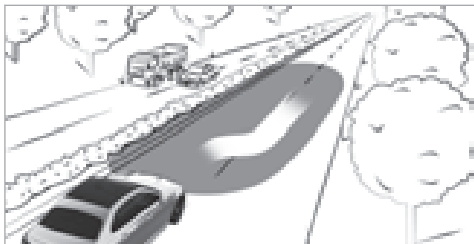

During assisted lane changes at speeds of at least 30 km/h, the course of the lane change as displayed will be brighter. This enables you to identify possible dangers in the new lane at an early stage.

Observe the system limitations of Active Lane Change Assist (→ page 241).

Lane keeping and blind spot warning

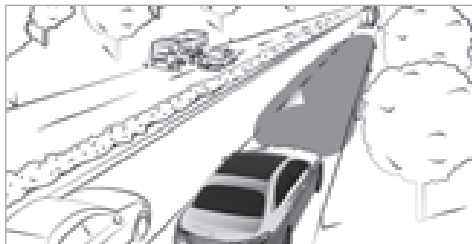

At speeds of at least 30 km/h, a triangle that indicates a lane correction and its direction will be projected onto the road in the following cases:

- You leave the lane unintentionally.
Observe the system limitations of Active Lane Keeping Assist (→ page 258).
- You switch on the turn signal light while an object or obstacle is in your blind spot.
Observe the system limitations of Active Blind Spot Assist (→ page 255).

Switching the Intelligent Light System on/off

Requirements

- The vehicle is switched on.

Multimedia system:

→  **Settings** **» Lights**
» DIGITAL LIGHT

- ▶ Activate or deactivate **Dynamic low beam**.

Activating or deactivating enhanced assistance functions

- ⓘ The availability of the functions is dependent on the country.
- ⓘ This function is an on-demand feature (→ page 25).
- ▶ Select **Supporting projections**.
- ▶ Activate or deactivate the desired projections.
- ▶ Switch **Projection for greeting/farewell** on or off.
If the locator lighting or the exterior switch-off delay time is activated, a high-resolution greeting or farewell scene will be played back for a short period of time when the vehicle is

opened or switched off. You can choose between the **Digital Rain** and **Star Wave** sequences.

- ❶ More information on locator lighting (→ page 159)
More information on the exterior switch-off delay time (→ page 159)

Adaptive Highbeam Assist

Adaptive Highbeam Assist function

⚠ WARNING Risk of accident despite Adaptive Highbeam Assist

Adaptive Highbeam Assist does not react to:

- road users without lights, e.g. pedestrians
- road users with poor lighting, e.g. cyclists
- road users whose lighting is obstructed, e.g. by a barrier

On very rare occasions, Adaptive Highbeam Assist may fail to recognise other road users with their own lighting, or may recognise them too late.

In these, or in similar situations, the automatic high beam will not be deactivated or will be activated despite the presence of other road users.

- ▶ Always observe the road and traffic conditions carefully and switch off the high beam in good time.

Adaptive Highbeam Assist cannot take into account road, weather or traffic conditions.

Detection may be restricted in the following cases:

- In poor visibility, e.g. fog, heavy rain or snow
- if there is dirt on the sensors or the sensors are obscured

Adaptive Highbeam Assist is only an aid. You are responsible for adjusting the vehicle's lighting to the prevailing light, visibility and traffic conditions.

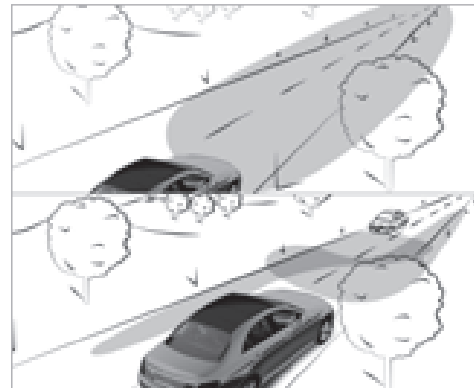

Adaptive Highbeam Assist automatically switches between the following types of light:

- Low beam
- High beam

At speeds greater than 30 km/h:

- If no other road users are detected, high beam will switch on automatically.

The high beam will switch off automatically in the following cases:

- At speeds below 25 km/h
- If other road users are detected
- If street lighting is sufficient

 The system's optical sensor is located behind the windscreen near the overhead control panel.

Switching Adaptive Highbeam Assist on/off

 **WARNING** Risk of accident despite Adaptive Highbeam Assist

Adaptive Highbeam Assist does not react to:

- road users without lights, e.g. pedestrians
- road users with poor lighting, e.g. cyclists
- road users whose lighting is obstructed, e.g. by a barrier

On very rare occasions, Adaptive Highbeam Assist may fail to recognise other road users with their own lighting, or may recognise them too late.

In these, or in similar situations, the automatic high beam will not be deactivated or will be activated despite the presence of other road users.

- ▶ Always observe the road and traffic conditions carefully and switch off the high beam in good time.

Switching on

- ▶ Turn the light switch to the **AUTO** position.
- ▶ Switch on high beam using the combination switch.
If Adaptive Highbeam Assist is activated, the  indicator lamp will light up on the driver's display.

Switching off

- ▶ Switch off high beam using the combination switch.

Adaptive Highbeam Assist Plus

Adaptive Highbeam Assist Plus function

 **WARNING** Risk of accident despite Adaptive Highbeam Assist Plus

Adaptive Highbeam Assist Plus does not react to:

- road users without lights, e.g. pedestrians
- road users with poor lighting, e.g. cyclists
- road users whose lighting is obstructed, e.g. by a barrier

On very rare occasions, Adaptive Highbeam Assist Plus may fail to recognise other road users with their own lighting, or may recognise them too late.

In these, or in similar situations, the automatic high beam will not be deactivated or will be activated despite the presence of other road users.

- ▶ Always observe the road and traffic conditions carefully and switch off the high beam in good time.

Adaptive Highbeam Assist Plus cannot take into account road, weather or traffic conditions.

Detection may be restricted in the following cases:

- In poor visibility, e.g. fog, heavy rain or snow
- if there is dirt on the sensors or the sensors are obscured

Adaptive Highbeam Assist Plus is only an aid. You are responsible for adjusting the vehicle's lighting to the prevailing light, visibility and traffic conditions.

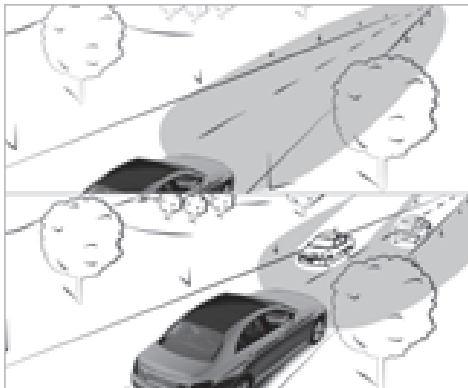

Adaptive Highbeam Assist Plus automatically switches between the following types of light:

- Low beam
- Partial high beam
- High beam
- ULTRA RANGE Highbeam

ULTRA RANGE Highbeam increases the brightness of the cone of light to the legally permitted maximum.

Partial high beam does not include other road users in the high beam area. It does not dazzle them but enables full high-beam illumination for the driver apart from the excluded vehicles. Highly reflective signs are also illuminated with reduced brightness.

At speeds below 25 km/h or when there is sufficient street lighting:

- Partial high beam and high beam will be switched off automatically.

At speeds greater than 30 km/h:

- If no other road users are detected, high beam will switch on automatically.
- If other road users are detected, partial high beam will switch on automatically.

at speeds below 40 km/h:

- The ULTRA RANGE Highbeam will switch off automatically.

At speeds above 50 km/h:

- If no other road users are detected, the road is straight and it is not raining heavily, the ULTRA RANGE Highbeam will be switched on automatically.
- If other road users are detected, the ULTRA RANGE Highbeam will automatically switch off and the partial high beam will switch on.
- If highly reflective signs are detected, ULTRA RANGE Highbeam will be switched off automatically.

 The system's optical sensor is located behind the windscreen near the overhead control panel.

Switching Adaptive Highbeam Assist Plus on/off

 **WARNING** Risk of accident despite Adaptive Highbeam Assist Plus

Adaptive Highbeam Assist Plus does not react to:



- road users without lights, e.g. pedestrians
- road users with poor lighting, e.g. cyclists
- road users whose lighting is obstructed, e.g. by a barrier

On very rare occasions, Adaptive Highbeam Assist Plus may fail to recognise other road users with their own lighting, or may recognise them too late.

In these, or in similar situations, the automatic high beam will not be deactivated or will be activated despite the presence of other road users.

- ▶ Always observe the road and traffic conditions carefully and switch off the high beam in good time.

Switching on





- ▶ Turn the light switch to the  position.
- ▶ Switch on high beam using the combination switch.
If Adaptive Highbeam Assist Plus is activated, the  indicator lamp will light up on the driver's display. When partial high beam or high beam is active, the corresponding blue indicator lamp will also light up.

Switching off

- ▶ Switch off high beam using the combination switch.

Setting low beam

Multimedia system:

- ▶   **Settings**  **Lights**
- ▶  **DIGITAL LIGHT**  **Low beam**
- ▶ Select **Right-side traffic**, **Left-side traffic** or **Automatic**.

Setting the exterior lighting switch-off delay time

Multimedia system:

- ➔  ➔ Settings ➔ Lights
- ➔ Interior/exterior lighting
- ➔ Exterior lighting delayed switch off

- ▶ Set the switch-off delay time.
When the vehicle's engine is switched off, the exterior lighting will be activated for the set time.

Activating/deactivating the locator lighting

Multimedia system:

- ➔  ➔ Settings ➔ Lights
- ➔ Interior/exterior lighting



- ▶ Activate or deactivate **Locator lighting**.

When the function is activated, the exterior lighting will light up for 40 seconds after the vehicle is unlocked or the driver's door is opened when the vehicle is parked and not locked. When you start the vehicle, the locator lighting will be deactivated and the automatic driving lights activated.

Interior lighting

Adjusting the interior lighting





- ①  Switches the front interior lighting on/off.
- ②  Switches the rear interior lighting on/off.
- ③  Switches automatic interior lighting control on/off.

- ▶ **To switch reading lamps on/off:** hold your hand under the respective reading lamp ④ or ⑤.

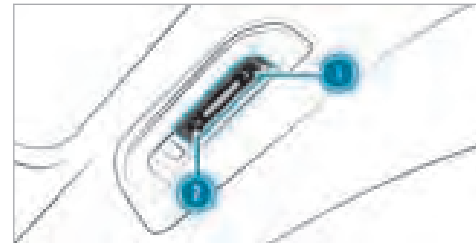
Operating unit inside the grab handle (rear)



- ①  Reading lamp on the respective side of the vehicle
- ②  Rear interior lighting

- ▶ **To switch reading lamps on:** press button ①. The reading lamp, the interior lighting in the grab handle and the dome lamp on the respective side of the vehicle will light up.
- ▶ **To switch reading lamps off:** press button ① once or twice. When you press it once, the interior lighting in the grab handle and the dome lamp on the respective side of the vehicle will go out.

When you press it twice, the reading lamp on the respective side of the vehicle will go out.

▶ **To switch the rear interior lighting on/off:** press button ②.

The reading lamps, the interior lighting in the grab handle and the dome lamps on both sides of the vehicle will light up or go out.

Adjusting the ambient lighting

Multimedia system:

➔  ▶▶ **Comfort** ▶▶ **Ambient light**

Setting the colour

- ▶ Select **Colour**.
- ▶ Select **Monochrome** or **Multi-colour**.
- ▶ Set the desired colour or colour scheme.

Sound2Light

- In combination with the selected light colour, the Sound2Light function visually accentuates the sound content.

Adjusting the brightness

- ▶ Select **Brightness**.

▶ Adjust the brightness.

ⓘ Depending on the ambient light conditions, the ambient lighting will automatically switch between day and night modes.

Activating the brightness for zones

▶ Select **Brightness**.

▶ Switch off **Link zones**.

The **Direct**, **Indirect** and **Accents** zones can be set separately.

ⓘ The **Light strip** zone can also be set in vehicles with active ambient lighting.

Activating effects

⚠ WARNING Risk of accident despite ambient lighting and active ambient lighting effects switched on.

The warning assistance effects are fully active only if the respective driving or driving safety systems are switched on in the Driving Assistance menu.

- ▶ Ensure that the respective driving or driving safety systems are switched on.

ⓘ Observe the notes on driving systems and your responsibility; you may otherwise fail to recognise dangers (→ page 215).

▶ Select **Effects**.

▶ Activate the desired effect.

ⓘ Depending on the vehicle equipment, different effects are available.

Night shut-off

- The lines of light on the head-up display can be dimmed while you are driving. This only takes place at night.

Operating feedback effects

- **Climate:** If changes are made to the temperature setting in the vehicle, the colour of the ambient lighting will change briefly.
- **Voice assistant:** For vehicles with active ambient lighting, the voice assistant is visually animated.
- **Greeting:** When you get into the vehicle, a special colour animation will play.

Warning assistance effects

- **Warning when exiting:** If an object is detected in the blind spot while you are getting out of the vehicle, the ambient lighting in the affected door will flash red.

Further information on the exit warning (→ page 255).

- **Active Lane Keeping Assist:** If there is a warning from Active Lane Keeping Assist, the active ambient lighting will flash red.

Further information on Active Lane Keeping Assist (→ page 258).

- **Active Brake Assist:** If there is an Active Brake Assist warning, the active ambient lighting in the centre of the cockpit will flash bright red.

Further information on the Active Brake Assist (→ page 243).

- **Active Blind Spot Assist:** In vehicles with active ambient lighting, the ambient lighting on the affected side will flash red if there is a warning from Active Blind Spot Assist.

Further information on Active Blind Spot Assist (→ page 255).

- **Parking Assist PARKTRONIC:** The information from the parking sensors during parking manoeuvres is displayed in colour.

Further information on Parking Assist **PARKTRONIC:** (→ page 271)

Multi-colour animation

- The chosen colour combination will change at predefined intervals.

- ① In vehicles with active ambient lighting, an animation will be played.
- ① The desired operating feedback and warning assistance can be activated or deactivated via the  symbol. Depending on the equipment, different operating feedback and warning assistance effects are available.
- ① If the brightness is set to a low level, warning animations will be displayed at a higher basic brightness.

You can watch an animation on this topic via the following link:

Switching the interior lighting switch-off delay time on/off

Multimedia system:

- ➔  ➔ Settings ➔ Lights
- ➔ Interior/exterior lighting
- ➔ Interior lighting delayed switch off

- ▶ Activate or deactivate **Interior lighting delayed switch off**.

If this function is active, the interior lighting will be switched on for a short time after the end of the journey.

Windscreen wipers and windscreen washer system

Switching the windscreen wipers on/off

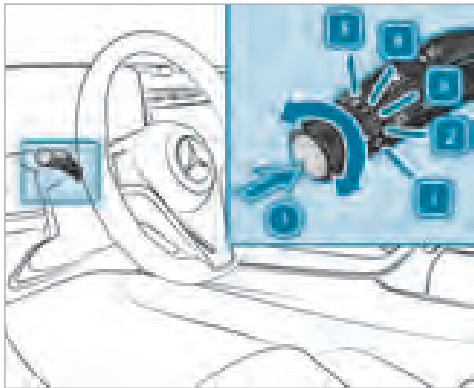

- 1** **0** Windscreen wipers off
- 2** **•••** Automatic wiping, normal
- 3** **••••** Automatic wiping, frequent

- 4** **—** Continuous wiping, slow
- 5** **≡** Continuous wiping, fast

- ▶ Turn the combination switch to the corresponding position **1** - **5**.
- ▶ **Single wipe/washing:** push the button on the combination switch in the direction of arrow **1**.
 - Single wipe
 - Wipes with washer fluid
- i** Observe the notes on washing the vehicle in a car wash (→ page 477).

Replacing the windscreen wiper blades

⚠ WARNING Risk of becoming trapped if the windscreen wipers are switched on while wiper blades are being replaced

If the windscreen wipers begin to move while you are changing the wiper blades, you can be trapped by the wiper arm.

▶ Always switch off the windscreen wipers and vehicle before changing the wiper blades.

Moving the wiper arms into the replacement position

- ▶ Switch the vehicle on and then off again immediately.
- ▶ Within around 15 seconds, press and hold the button on the combination switch for approximately three seconds (→ page 162). The wiper arms will move into the replacement position.

Removing the wiper blades

- ▶ Fold the wiper arms away from the windscreen.

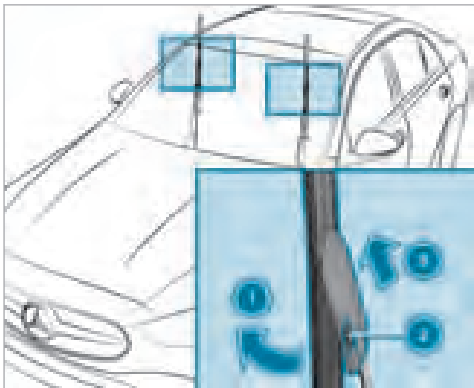

- ▶ Hold the wiper arm with one hand. With the other hand, turn the wiper blade away from the wiper arm in the direction of arrow ① as far as it will go.
- ▶ Press release button ②.
- ▶ Remove the wiper blade from the wiper arm in the direction of arrow ③.

Fitting the wiper blades

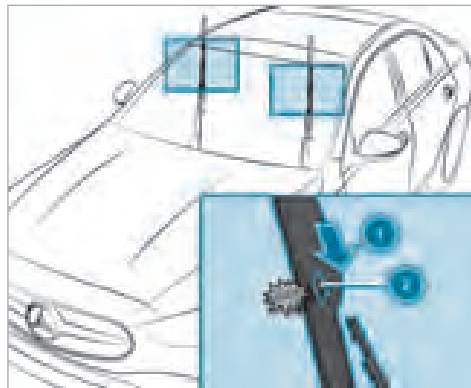

- ▶ Push the new wiper blade into the wiper arm in the direction of arrow ① until release knob ② engages.
- ▶ Make sure that the wiper blade is seated correctly.
- ▶ Fold the wiper arms back onto the windscreen.

- ▶ Switch on the vehicle.
- ▶ Press the  button on the combination switch. The wiper arms will return to their original positions.
- ▶ Switch off the vehicle.
- ⓘ Check the condition of the wiper blades regularly and replace them in the event of visible damage or ongoing smearing.

Maintenance display

There is a maintenance display at the tip of the newly mounted wiper blade.

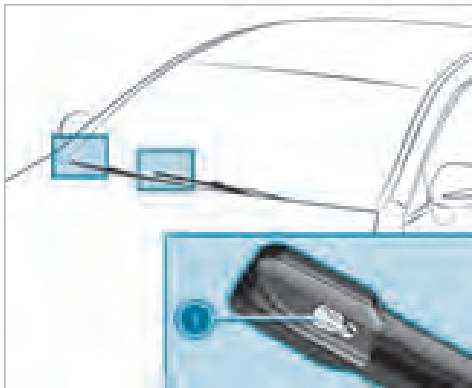

- ▶ Remove protective film ❶ from the maintenance display.

When the colour of the maintenance display changes from black to yellow, the wiper blades should be replaced.

Mirrors

Operating the outside mirrors

- ⚠ **WARNING** Risk of accident due to adjusting the vehicle settings while the vehicle is in motion

You could lose control of the vehicle in the following situations in particular:

- if you adjust the driver's seat, the head restraint, the steering wheel or the mirror while the vehicle is in motion
 - if you fasten your seat belt while the vehicle is in motion
- ▶ Before starting the vehicle: in particular, adjust the driver's seat, head restraint, steering wheel and mirror, and fasten your seat belt.

- ⚠ **WARNING** Risk of accident due to misjudgement of distance when using the outside mirror

The outside mirrors reflect objects on a smaller scale. The objects in view are in fact closer than they appear.

- ▶ Therefore, always look over your shoulder in order to ensure that you are aware of the actual distance between you and the road users driving behind you.

Adjusting the outside mirrors

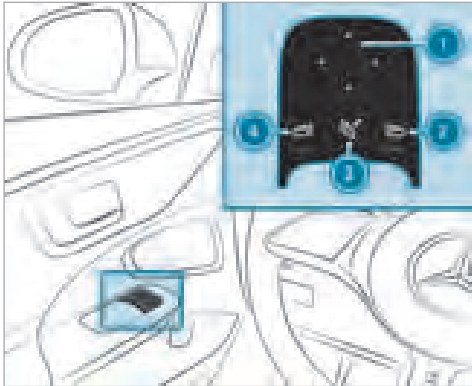

▶ Use button ② or ④ to select the desired mirror.

ⓘ In vehicles with MBUX Interior Assistant and driver camera, the required outside mirror can also be preselected automatically via a natural head movement to the left or right (→ page 350).

▶ Use button ① to adjust the position of the selected mirror.

Folding the outside mirrors in/out (vehicles with electrically folding outside mirrors)

▶ Briefly press button ③.

ⓘ If the battery has been disconnected or has discharged, the outside mirrors must be moved briefly using button ③. Only then will the automatic mirror folding function work properly.

Engaging the outside mirrors

If an outside mirror has been forcibly disengaged, proceed as follows.

▶ Vehicles without electrically folding outside mirrors: manually move the outside mirror into the correct position.

▶ Vehicles with electrically folding outside mirrors: press and hold button ③. You will hear a click and the mirror will audibly engage. The outside mirror will now be set to the correct position.

Automatic anti-dazzle mirrors function

⚠ WARNING Risk of acid burns and poisoning due to the anti-dazzle mirror electrolyte

Electrolyte may escape if the glass in an automatic anti-dazzle mirror breaks.

The electrolyte is hazardous to health and causes irritation. It must not come into contact with your skin, eyes, respiratory organs or clothing or be swallowed.

▶ If you come into contact with electrolyte, observe the following:

- Immediately rinse the electrolyte from your skin with water and seek medical attention.
- If electrolyte comes into contact with your eyes, immediately rinse them thoroughly with clean water and seek medical attention.
- If the electrolyte is swallowed, immediately rinse your mouth out thoroughly. Do not induce vomiting. Seek medical attention immediately.

- Immediately change out of clothing which has been contaminated with electrolyte.
- If an allergic reaction occurs, seek medical attention immediately.

The inside rearview mirror and the outside mirror on the driver's side will automatically go into anti-dazzle mode if light from a headlamp hits the sensor on the inside rearview mirror.

System limits

The system will not go into anti-dazzle mode if:

- The vehicle is switched off.
- Reverse gear is engaged.
- The interior lighting is switched on.

Front-passenger outside mirror parking position function

The parking position makes parking easier.

The front-passenger outside mirror will swivel downwards in the direction of the rear wheel on the front passenger's side when:

- the parking position is stored (→ page 166).
- the front-passenger mirror is selected.
- reverse gear is engaged.

The front-passenger outside mirror will move back to its original position when:

- you shift the transmission to another transmission position.
- you are travelling at a speed greater than 15 km/h.
- you press the button for the outside mirror on the driver's side.

Storing the parking position of the front-passenger outside mirror using reverse gear

Storing

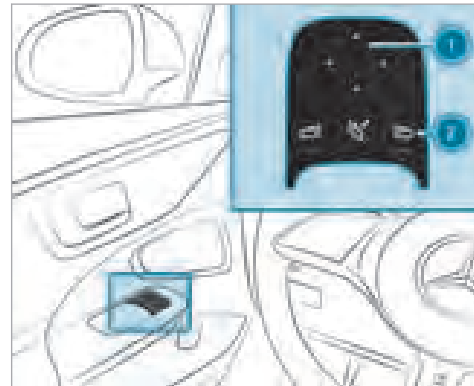

- ▶ Select the front-passenger outside mirror using button ②.
- ▶ Engage reverse gear.
- ▶ Move the front-passenger outside mirror into the desired parking position using button ①.

Calling up

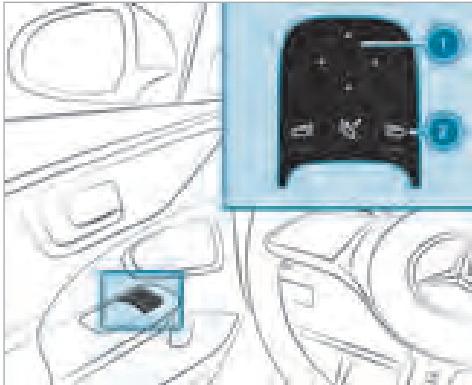

- ① Adjusts the outside mirrors.
- ② Selects the front-passenger outside mirror.
- ▶ Select the front-passenger outside mirror using button ②.
- ▶ Engage reverse gear.
The front-passenger outside mirror will move into the stored parking position.

Activating/deactivating the automatic mirror folding function

Multimedia system:

→ [Home] ▶▶ Settings ▶▶ Vehicle

▶▶ Opening/closing

- ▶ Activate or deactivate Automatic mirror fold-in.

Overview of climate control systems

Notes on climate control





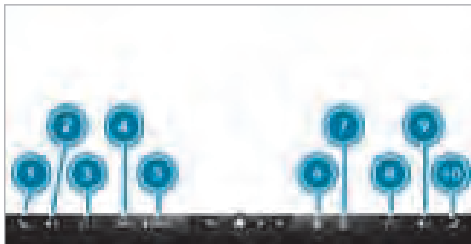

An interior filter in combination with the prefilter in the engine compartment must always be used so that the air conditioning system, pollution level monitoring and the air filtration work correctly. Use filters recommended and approved by Mercedes-Benz. Always have maintenance work carried out at a qualified specialist workshop.



Overview of the climate bar

The indicator lamps indicate that the corresponding functions are activated.



Front climate bar on the central display (example)

- ①  Sets the air distribution on the left
- ②  Increases or reduces the airflow on the left or switches on climate control (→ page 169)
- ③  Increases/reduces the temperature on the left
- ④  Calls up the fine particulate status display (→ page 171) or
- ⑤  Calls up the air conditioning menu (→ page 171)
- ⑥  Demists the windscreen

- ⑦ Example:  switches the rear window heater on/off.
The function of this button can be assigned via the climate menu.
- ⑧ Increases/reduces the temperature on the right
- ⑨  Increases or reduces the airflow on the right or switches on climate control (→ page 169)
- ⑩  Sets the air distribution on the right
- i The climate bar will remain visible even when the vehicle is parked or the air conditioning is switched off (→ page 169).
- i The airflow is automatically reduced in the event of an incoming call. The airflow can still be adjusted manually via ② and ⑨.
- i The availability of individual functions depends on the country and equipment.

Overview of the rear operating unit

The rear operating unit is available only for vehicles with the THERMOTRONIC air conditioning control panel.

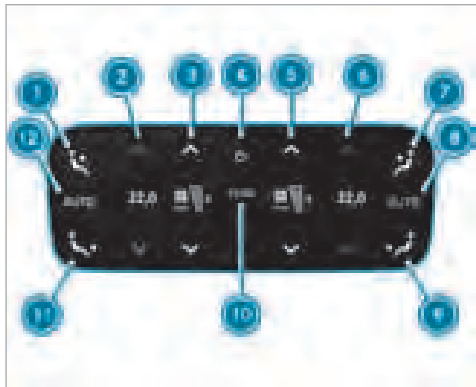

- ❶ Sets air distribution to the centre and side air vents in the rear passenger compartment, left
- ❷ Sets the temperature in the rear passenger compartment, left

- ❸ Sets the airflow in the rear passenger compartment, left, or switches climate control on/off (→ page 170)
- ❹ Switches climate control on/off (→ page 170)
- ❺ Sets the airflow in the rear passenger compartment, right, or switches climate control on/off (→ page 170)
- ❻ Sets the temperature in the rear passenger compartment, right
- ❼ Sets air distribution to the centre and side air vents in the rear passenger compartment, right
- ❽ Sets rear climate control to automatic mode, right (→ page 172)
- ❾ Sets the air distribution to the right rear footwell vents
- ❿ Synchronisation is activated (→ page 174)
- ⓫ Sets the air distribution to the rear left footwell vents
- ⓬ Sets rear climate control to automatic mode, left (→ page 172)

The settings for the second row of seats can be configured via the rear operating unit or the multimedia system (→ page 174) depending on the vehicle's equipment.

Operating the climate control system

Switching climate control on/off

Switching on climate control

- ▶ Set the airflow to level 1 or higher via on the climate bar on the central display
- or
- ▶ Press **AUTO** or .

Switching off climate control

- ▶ Set the airflow to level 0 via on the climate bar on the central display
- or
- ▶ Press .

If climate control is switched off, the windows may mist up more quickly. Switch climate control off only briefly.

- ❗ If climate control is switched off via , **OFF** will be shown on the climate bar.

Switching climate control on/off via the rear operating unit

Switching on

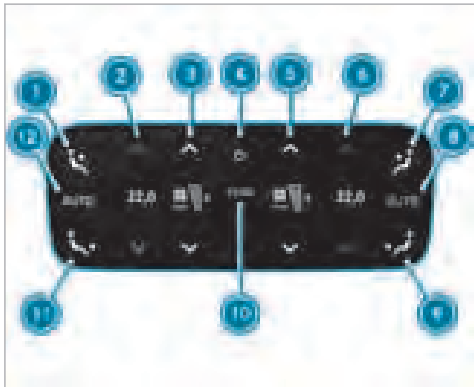

▶ Press the **4** button.

or

▶ Set the airflow to level 1 or higher using buttons **3** and **5**.

or

▶ Press buttons **2**, **6**, **8** or **12**.

Switching off

▶ Press the **4** button.

or

▶ Set the airflow to level 0 using buttons **3** and **5**.

i rear climate control is switched off via button **4**, **OFF** will be shown on the display.



Configuring the climate bar



Multimedia system:

↳ Climate menu ▶▶ First row of seats

In the climate menu, you can choose between the different assignments for the freely configurable button on the climate bar.

The following assignments are available on the climate menu:

-  Air quality
-  Recirculated air
-  A/C function

-  Synchronisation function
-  Rear window heater

i Functions that are not permanently set on the climate bar are available in the climate menu.

▶ Select .

▶ Select the desired function for the button in the window.
The function will be applied to the button.

i The window for assigning the button can also be accessed directly by pressing and holding the button once.

Setting the temperature and airflow

Calling up the controller for the temperature and airflow

▶ To call up the controller: press the temperature displayed or  on the climate bar of the central display





or

▶ press and hold the temperature displayed or  on the climate bar of the central display





or

- ▶ swipe on the displayed temperature or  on the climate bar of the central display.

Setting the temperature

- ▶ To increase the temperature: press  or move the controller. Press and hold  to set the temperature to the maximum.
 - ▶ To lower the temperature: press  or move the controller. To switch off climate control, press and hold .
- i** The temperature for the driver's and front passenger side can only be operated one after the other.



Setting the airflow

- ▶ Press  on the climate bar on the central display.
- ▶ To increase the airflow: press  or move the controller. Press and hold  to set the airflow to the maximum.
- ▶ To reduce the airflow: press  or move the controller. To switch off the airflow, press and hold .

- i** The airflow will remain active if the AUTO function is activated.

Activating/deactivating the A/C function via the climate bar

The A/C function heats, cools and dehumidifies the vehicle's interior air.

- ▶ Press  on the climate bar on the central display.
- i** The  button on the climate bar of the central display can also be assigned other functions. If the button on the climate bar is not available, the A/C function can be switched on and off via the climate menu.
- i** Switch off the A/C function only briefly; otherwise, the windows may mist up more quickly. Condensation may drip from the underside of the vehicle when cooling mode is active. This is not indicative of a fault.

Calling up the air conditioning menu using the climate bar

The air conditioning menu can be called up via the climate bar. The climate bar is always shown on the lower edge of the central display.

- ▶ Select the **Menu** entry in the climate bar. The **First row of seats** menu is opened.

Jumping directly to the Air quality menu

- ▶ Select the  fine particle prefilter status display in the air conditioning bar. The **Air quality** menu is opened. An animation of the automatic air cleaning taking place is shown.
- i** The fine particle prefilter status display is on the home screen next to the temperature display on the right and it informs you of the current particulate levels inside and outside of the vehicle. The measurement values are shown with the $\mu\text{g}/\text{m}^3$ units (microgrammes per cubic metre).

Strong acceleration after longer parking periods will lead to a detachment of the dust covering the



vehicle. This dust measured by the PM2.5 sensor might lead to a short rise of outside values.

Defrosting the windscreen via the climate bar

Switching on

▶ Press  on the climate bar on the central display.

Switching off

▶ Press , **AUTO** or  on the climate bar on the central display

or

▶ set the airflow to 0.

- i** When the defrost function is activated, some functions (e.g. the temperature setting or the air distribution) will automatically be deactivated.

Activating/deactivating the A/C function via the air conditioning menu

Multimedia system:

➔ Climate menu ➔ First row of seats

Depending on the external conditions, support for improved cooling and dehumidification of the interior air will be provided when the A/C function is activated. If it is not possible to operate the A/C function on the climate bar on the central display, switch the function on or off in the climate menu of the central display.

▶ Select **A/C** (A/C).



Switch off the A/C function only briefly; otherwise, the windows may mist up more quickly.

Condensation may drip from the underside of the vehicle when cooling mode is active. This is not indicative of a fault.

Setting climate control to automatic mode

In automatic mode, the set vehicle interior temperature is controlled automatically and maintained at a constant level by the air supply.

▶ Press  on the climate bar on the central display and then select **AUTO**.

- i** You can increase or reduce the airflow via a controller by pressing  on the climate bar of the multimedia system. In the event of an incoming call, the airflow is automatically reduced. The airflow can still be adjusted manually by pressing . In automatic mode, five levels can be set via the controller and seven levels can be set without automatic mode.

▶ **To switch to manual operation:** switch off automatic mode or adjust an aspect of air distribution, e.g. .

Setting climate control to automatic mode via the rear operating unit

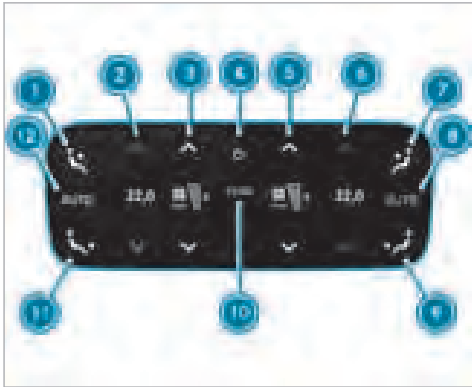

In automatic mode, the temperature is automatically regulated by the temperature of the dispersed air and the airflow.



- ▶ Press the 8 or 12 button.

Overview of the air distribution settings

The symbols on the central display indicate the vents through which the airflow is being directed:

-  Demister vents
-  Centre and side air vents





-  Footwell vents

Setting air distribution and air vents via the air conditioning menu

Multimedia system:

- ➔ Climate menu

Setting the air distribution

- ▶ Select **First row of seats** or **Second row of seats**.
- ▶ Select an air distribution option using the ,  or  buttons.
- i** When the air conditioning system is switched on, at least one zone is always active. However, several air distribution options can be selected at the same time, for example to set the climate control for the interior and the footwells simultaneously. In doing so, the  climate control for the windscreen can only be selected for the first seat row. When automatic mode is active, the buttons for setting the air distribution are automatically deactivated. When the air conditioning system

is switched off, the buttons remain operable and the last setting is saved.

Setting air distribution for the air vents

Air distribution for the first seat row can also be set automatically in the air conditioning menu using the hybrid operating concept of the air vents.

- ▶ Select **First row of seats**.
- ▶ Select .
- ▶ Select from the various settings **Towards the body**, **Head**, **Chest**, **Evenly** or **Away from the body**.
- ▶ The air vents automatically move into the set position.
- i** The air vents can also be set manually using the corresponding controller (→ page 178).
- i** The hybrid air vents are equipped with an automatic blockage detection feature. If the air vents are moved using the multimedia system but prevented from doing so by manual intervention or objects, the air vents will return to their previous starting position after two attempts.

Setting rear climate control using the air conditioning menu



Multimedia system:

➔ Climate menu

Setting the temperature



- ▶ Select **Second row of seats**.
- ▶ Set the temperature.

Setting the airflow

- ▶ Select **Second row of seats**.
- ▶ Set the air flow with  or .

Controlling the rear climate control automatically

- ▶ Select **AUTO**.

 When the defrost function is activated, some functions (e.g. the temperature setting) will automatically be deactivated. To deactivate the defrost function, press either , **AUTO** or  set the air flow to level 0 (→ page 172).

Deactivating rear climate control

- ▶ Select **REAR OFF**.

Switching the synchronisation function on/off via the air conditioning menu

Multimedia system:

➔ Climate menu ➔ First row of seats

The synchronisation function controls the climate control centrally. The driver's settings for temperature, airflow and air distribution are automatically adopted for each climate zone.

- ▶ Select **SYNC** (SYNC).

Demisting the windows

Windows misted up on the inside

- ▶ Press **AUTO** on the climate bar on the central display.
- ▶ If the windows remain misted up: press  on the climate bar on the central display.

Windows misted up on the outside

- ▶ Switch on the windscreen wipers.
- ▶ Press **AUTO** on the climate bar on the central display.

Switching air-recirculation mode on/off

- ▶ Press  on the climate bar on the central display.
The interior air will be recirculated.

Air-recirculation mode will automatically switch to fresh air mode after a while.

-  If air-recirculation mode is switched on, the windows may mist up more quickly. Switch on air-recirculation mode only briefly.

Switching the air-recirculation mode on/off via the air conditioning menu

Requirements

- A fine particle prefilter is installed in the vehicle.

Multimedia system:

➔ Climate menu ➔ Air quality

- ▶ Press  in the upper display area of the climate bar.
The interior air will be recirculated.

Air-recirculation mode will automatically switch to fresh air mode after a while.

- ❶ If air-recirculation mode is switched on, the windows may mist up more quickly. Switch on air-recirculation mode only briefly.
- ❷ By selecting the fine particle status display  on the climate bar, you can jump directly to the air quality menu.

Switching residual heat mode on/off via the climate bar

Requirements

- The residual heat function is available.
- The vehicle is parked.
- The coolant temperature is sufficiently high.

It is possible to make use of the residual heat from the engine to continue heating or ventilating the front compartment of the vehicle for approximately 30 minutes, depending on the temperature set.

- ▶ **To switch on or off:** select **Residual heat** on the climate bar of the central display.

The residual heat function will automatically switch off after some time.

- ❶ If residual engine heat utilisation is activated, the two buttons for setting the temperature and air distribution will automatically be deactivated.

Activating/deactivating ionisation

Multimedia system:

↪ Climate menu ▶▶ Air quality

When ionization is activated, the indoor air is enriched with negatively charged oxygen ions. These can promote the well-being of the occupants.

- ▶ Select **Ionisation**.

- ❶ The function can only be performed if the AUTO mode is activated or the air distribution is set to the side air vent. The function is restricted if the side air vents on the driver's side are closed.

Fragrance system

Activating/deactivating the fragrance system using the multimedia system

Requirements

- Automatic climate control is activated.
- The glove compartment will close.
- A flacon is inserted.

Multimedia system:

↪ Climate menu ▶▶ Air quality

The fragrance system distributes a pleasant fragrance throughout the vehicle interior from a flacon located in the glove box.

- ▶ Navigate down until the climate control bar is active.
- ▶ Select **Air freshener**.
- ▶ Activate or deactivate fragrancing.

Setting the fragrance system

Requirements

- The climate control system is switched on.
- The glove compartment will close.

- A flacon is inserted.

Multimedia system:

➔ [Climate menu](#) ➔ [Air quality](#)

The fragrance system distributes a pleasant fragrance throughout the vehicle interior from a flacon located in the glove box.

- ▶ Select [Air freshener](#).
- ▶ Keep pressing until the desired intensity is reached.

■ [Inserting or removing the flacon of the fragrance system](#)

⚠ WARNING Risk of injury from liquid perfume

If children open the flacon, they could drink the liquid perfume or it could come into contact with their eyes.

- ▶ Do not leave children unattended in the vehicle.
- ▶ Consult a doctor immediately if liquid perfume has been drunk.

- ▶ If liquid perfume comes into contact with your eyes or skin, rinse your eyes with clean water.
- ▶ If symptoms continue, consult a doctor.



ENVIRONMENTAL NOTE Environmental damage due to improper disposal of full flacons



Full flacons must not be disposed of with household waste.



Full flacons must be taken to a harmful substance collection point.

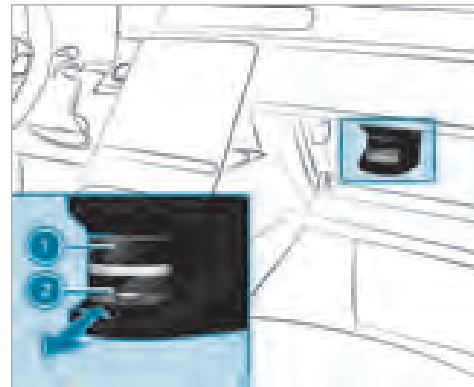

- 1 Cap
- 2 Flacon

- ▶ **To insert:** slide the flacon into the holder as far as it will go.
- ▶ **To remove:** after opening the glove box, wait for approximately seven seconds and pull out the flacon.

If you do not use genuine Mercedes-Benz interior perfumes, observe the manufacturers' safety notices on the perfume packaging.

Dispose of the genuine Mercedes-Benz interior perfume flacon when it is empty and do not refill it.

Refillable flacon

- ▶ Unscrew the cap of the empty flacon.
- ▶ Fill the flacon with a maximum of 15 ml.
- ▶ Screw the cap back onto the flacon.

Always refill the empty refillable flacon with the same perfume. Observe the separate information sheet with the flacon.

Stationary heater/ventilation

■ Stationary heater/ventilation function

- ① The following function is equipment-dependent.
 - The air inside the vehicle is heated or ventilated to the set temperature.

- The air inside the vehicle cannot be cooled down to temperatures below the outside temperature.
- If the outside temperature changes, ventilation mode will automatically switch to heating mode or heating mode will automatically switch to ventilation mode.

The stationary heater and the exhaust gas outlet are situated behind the right front wheel.

■ Switching the stationary heater/ventilation on/off

⚠ DANGER Risk of fatal injury due to poisonous exhaust gases

If the tailpipe is blocked or sufficient ventilation is not possible, poisonous exhaust gases such as carbon monoxide may enter the vehicle. This is the case in enclosed spaces or if the vehicle gets stuck in snow, for example.

- ▶ Always switch the stationary heater off in enclosed spaces without an air extraction system, e.g. in garages.

- ▶ Keep the tailpipe and the area around the vehicle free from snow when the vehicle or the auxiliary heating is running.
- ▶ Open a door or a roof hatch on the windward side of the vehicle to ensure an adequate supply of fresh air.

⚠ WARNING Risk of fire due to hot stationary heater components and exhaust gases

Flammable materials such as leaves, grass or twigs may ignite.

- ▶ When the stationary heater is switched on, make sure that:
 - hot vehicle parts do not come into contact with flammable materials.
 - the exhaust gas can flow out of the stationary heater exhaust pipe unhindered.
 - the exhaust gas does not come into contact with flammable materials.

! **NOTE** Battery discharge caused by stationary heater or stationary ventilation operation



Operating the stationary heater or stationary ventilation drains the battery.



▶ After heating or ventilating the vehicle twice, drive for a longer period of time.

Requirements

- The vehicle has a stationary heater.
- The outside temperature is below 15°C.
- The fuel tank is sufficiently full.

i If the fill level of the fuel tank is too low, auxiliary heating mode may be restricted.

▶ Set the temperature using the  and  arrows on the climate bar on the central display.

▶ Press the  button on the climate bar on the central display. The red or blue indicator lamp below the  button will light up or go out.

The colours of the indicator lamp have the following meanings:

- **Blue:** stationary ventilation is switched on.
- **Red:** the stationary heater is switched on.
- **Yellow:** the departure time is preselected.

The stationary heater/ventilation will switch off automatically after 50 minutes.

Setting the stationary heater/ventilation via the multimedia system

Requirements

- The vehicle is fitted with the stationary heater equipment.

Multimedia system:

 **Climate menu**  **Stationary heater**

Selecting the departure time

▶ Select **Time A**, **Time B** or **Time C**.

Setting the departure time

- ▶ Select **Time A**, **Time B** or **Time C**.
- ▶ Select the pen beside the time.
- ▶ Set a time.

Air vents

Adjusting the front air vents

! **WARNING** Risk of burns or frostbite due to being too close to the air vents

Very hot or very cold air can flow from the air vents.

▶ Make sure that all vehicle occupants always maintain a sufficient distance from the air vents.

▶ If necessary, direct the airflow to another area of the vehicle interior.

To guarantee the flow of fresh air through the air vents into the vehicle interior, note the following:

- Always keep the vents and ventilation grilles in the vehicle interior clear.
- Keep the air inlet free of residue build-up (→ page 477).

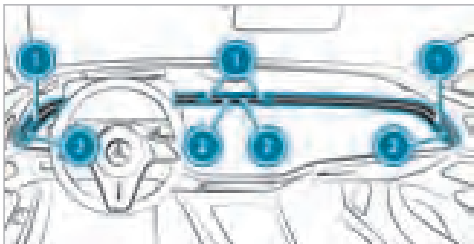

- ▶ **To set the airflow direction of the side air vents:** hold controller ① and move it up or down or to the left or right.
- ▶ **To set the airflow direction of the centre air vents:** hold controller ① and move it up or down or to the left or right.
- ▶ **To open or close the side air vents:** turn respective controller ② up or down as far as it will go.
- ▶ **To open or close the centre air vents:** turn respective controller ② to the left or right as far as it will go.

① The air distribution for the first row of seats can also be adjusted electrically via the multimedia system (→ page 173).

Adjusting the rear air vents

⚠ WARNING Risk of burns or frostbite due to being too close to the air vents

Very hot or very cold air can flow from the air vents.

- ▶ Make sure that all vehicle occupants always maintain a sufficient distance from the air vents.
- ▶ If necessary, direct the airflow to another area of the vehicle interior.

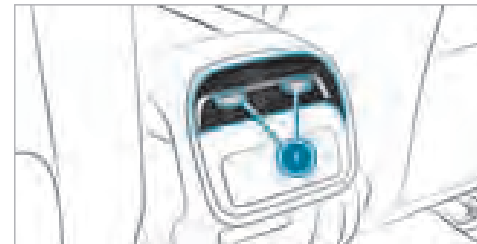

- ▶ **To open or close:** turn controller ② up or down as far as it will go.
- ▶ **To set the airflow direction:** hold the centre of controller ① and move it up or down or to the left or right.

Adjusting the rear side air vents

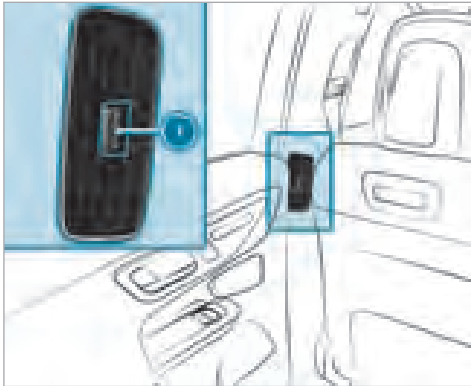

- ▶ **To open or close the side air vents in the rear passenger compartment:** hold the controller of side air vent ❶ and move it up or down as far as it will go.
- ▶ **To set the airflow direction of the side air vents:** hold controller ❶ and move it up or down or to the left or right.

Driving

Switching on the power supply or the vehicle

⚠ WARNING Accident- and risk of injury with unsupervised children in the vehicle

If you leave children unattended in the vehicle, they can in particular

- Open doors and thereby endanger other persons or road users.
- get out of the car and are hit by traffic.
- Operate vehicle equipment and become trapped, for example.

In addition, the children could also set the vehicle in motion, for example by:

- releasing the parking brake.
- change the gearbox setting.
- start the vehicle.

▶ Never leave children unattended in the vehicle.

- ▶ When leaving the vehicle, always take the SmartKey with you and lock the vehicle.
- ▶ Keep the key out of reach of children.

This also applies to the Digital Vehicle Key.

Requirements

- The key is in the vehicle and is recognised.
- **Vehicles with Digital Vehicle Key:** a Digital Vehicle Key with drive authorisation is detected.
- The brake pedal is not depressed.

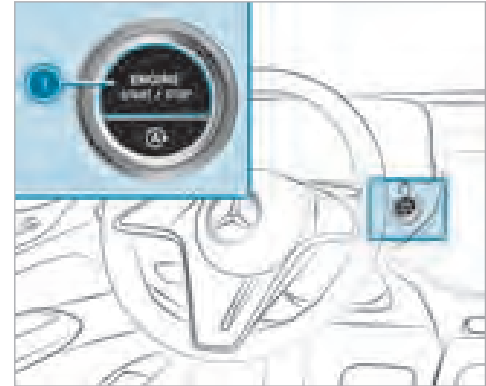

▶ **To switch on the power supply:** press button ① once. You can, for example, switch on the wind-screen wipers.

The power supply will be switched off again if the following conditions are met:

- You open the driver's door.
- You press button ① twice more.

▶ **To switch on the vehicle:** press button ① twice.

Indicator and warning lamps will light up on the driver's display.

The vehicle will be switched off again if one of the following conditions is met:

- You do not start the vehicle within 15 minutes and the transmission is in position **P** or the electric parking brake is applied.
- You press button ① once.

Starting the vehicle

▶ Starting the vehicle with the start/stop button

⚠ DANGER Risk of fatal injuries due to exhaust gases

Combustion engines emit poisonous exhaust gases such as carbon monoxide. Breathing in these exhaust gases is hazardous to health and results in poisoning.

- ▶ Never leave the engine and, if present, the stationary heater, running in an

enclosed space without sufficient ventilation.

⚠ WARNING Risk of fire due to flammable materials in the engine compartment or on the exhaust system

Flammable materials may ignite.

- ▶ Therefore, regularly check that there are no flammable foreign materials in the engine compartment or on the exhaust system.

⚠ WARNING Accident- and risk of injury with unsupervised children in the vehicle

If you leave children unattended in the vehicle, they can in particular

- Open doors and thereby endanger other persons or road users.
- get out of the car and are hit by traffic.
- Operate vehicle equipment and become trapped, for example.

In addition, the children could also set the vehicle in motion, for example by:

- releasing the parking brake.
- change the gearbox setting.
- start the vehicle.

- ▶ Never leave children unattended in the vehicle.
- ▶ When leaving the vehicle, always take the SmartKey with you and lock the vehicle.
- ▶ Keep the key out of reach of children.

This also applies to the Digital Vehicle Key.

Requirements

- The key is in the vehicle and is recognised.
- **Vehicles with Digital Vehicle Key:** a Digital Vehicle Key with drive authorisation is detected.



- ▶ Shift the transmission to position **P** or **N**.
- ▶ Depress the brake pedal and press button **1** once.
- ▶ If the vehicle does not start: switch off non-essential consumer equipment and press button **1** once.
- ▶ If the vehicle still does not start and the **Place the key in the marked space** See Owner's

Manual display message appears on the driver's display: start the vehicle with the key in the marked space (emergency operation mode) (→ page 185).

- i** You can switch off the vehicle while driving. To do this, press and hold button **1** for about three seconds or press button **1** three times within three seconds. Be sure to observe the safety notes concerning this under "Driving tips" (→ page 187).

Observe any information regarding display messages that may be shown on the driver's display.

■ Start the vehicle with the Digital Vehicle Key in the marked space (emergency operation mode)

! DANGER Risk of fatal injuries due to exhaust gases

Combustion engines emit poisonous exhaust gases such as carbon monoxide. Breathing in these exhaust gases is hazardous to health and results in poisoning.

- ▶ Never leave the engine and, if present, the stationary heater, running in an

enclosed space without sufficient ventilation.

! WARNING Risk of fire due to flammable materials in the engine compartment or on the exhaust system

Flammable materials may ignite.

- ▶ Therefore, regularly check that there are no flammable foreign materials in the engine compartment or on the exhaust system.

! WARNING Accident- and risk of injury with unsupervised children in the vehicle

If you leave children unattended in the vehicle, they can in particular

- Open doors and thereby endanger other persons or road users.
- get out of the car and are hit by traffic.
- Operate vehicle equipment and become trapped, foreexample.

In addition, the children could also set the vehicle in motion, for example by:

- releasing the parking brake.
- change the gearbox setting.
- start the vehicle.

- ▶ Never leave children unattended in the vehicle.
- ▶ When leaving the vehicle, always take the SmartKey with you and lock the vehicle.
- ▶ Keep the key out of reach of children.

This also applies to the Digital Vehicle Key.

Requirements

- The vehicle is equipped with the "Digital Vehicle Key" pre-installation.
- A suitable end device is activated as a Digital Vehicle Key.

- ⓘ Mercedes-Benz recommends that you carry the emergency key in case of function restrictions.

If the vehicle does not start and the **Please place key in the cup holder or Digital Vehicle Key in inductive charging bracket** See Owner's Manual display message appears on the driver's display, you can start the vehicle in emergency operation mode.

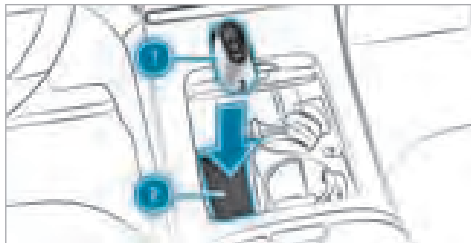

- ▶ Place key ① in stowage compartment ②.

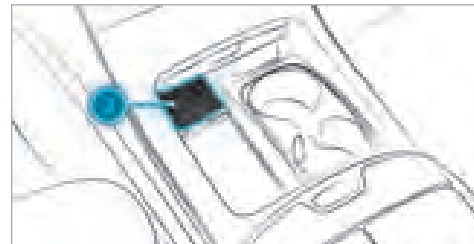

- ▶ Place the Digital Vehicle Key in stowage space ③.
- ▶ Depress the brake pedal and start the vehicle using the start/stop button. It may take a few seconds until the vehicle starts.
- ▶ When the **Key not detected** display message appears on the driver display, press the Start/Stop button again.

Starting the vehicle with the key in the marked space (emergency operation mode)

⚠ DANGER Risk of fatal injuries due to exhaust gases

Combustion engines emit poisonous exhaust gases such as carbon monoxide. Breathing in these exhaust gases is hazardous to health and results in poisoning.

▶ Never leave the engine and, if present, the stationary heater, running in an enclosed space without sufficient ventilation.

⚠ WARNING Risk of fire due to flammable materials in the engine compartment or on the exhaust system

Flammable materials may ignite.

▶ Therefore, regularly check that there are no flammable foreign materials in the engine compartment or on the exhaust system.

⚠ WARNING Accident- and risk of injury with unsupervised children in the vehicle

If you leave children unattended in the vehicle, they can in particular

- Open doors and thereby endanger other persons or road users.
- get out of the car and are hit by traffic.
- Operate vehicle equipment and become trapped, for example.

In addition, the children could also set the vehicle in motion, for example by:

- releasing the parking brake.
 - change the gearbox setting.
 - start the vehicle.
- ▶ Never leave children unattended in the vehicle.
- ▶ When leaving the vehicle, always take the SmartKey with you and lock the vehicle.
- ▶ Keep the key out of reach of children.

This also applies to the Digital Vehicle Key.

If the vehicle does not start and the **Place the key in the marked space** See *Owner's Manual* display message appears on the driver's display, you can start the vehicle in emergency operation mode.

Vehicles with Digital Vehicle Key: If the vehicle does not start and the **Please place key in the cup holder or Digital Vehicle Key in inductive charging bracket** See *Owner's Manual* display message appears on the driver's display, you can start the vehicle in emergency operation mode.

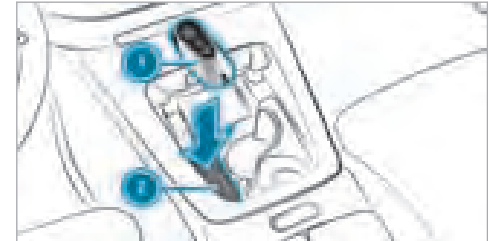

- ▶ Make sure that marked space ② is empty.
- ▶ Remove key ① from the key ring.

- ▶ Place key ① on the symbol in marked space ②.
The vehicle will start after a short time.
If you remove key ① from marked space ②, the vehicle can still be driven. For further engine starts, however, key ① must be located on the symbol in marked space ② during the entire journey.
- ▶ Have key ① checked at a qualified specialist workshop.

If the vehicle does not start:

- ▶ Place key ① in marked space ② and leave it there.
 - ▶ Depress the brake pedal and start the vehicle using the start/stop button.
- ① You can switch on the power supply or the vehicle with the start/stop button.

Observe any information regarding display messages that may be shown on the driver's display.

Running-in notes

To preserve the engine during the first 1500 km:

- Drive at varying road speeds and engine speeds.
- No faster than 140 km/h.
- Drive the vehicle in Drive mode **C** or **E**.
- Shift to the next higher gear at the very latest when the needle reaches the last third before the red area in the rev counter.
- Do not shift down manually in order to brake.
- Avoid overstraining the vehicle, e.g. driving at full throttle.
- Do not depress the accelerator pedal past the pressure point (kickdown).
- Only increase the engine speed gradually and accelerate the vehicle to full speed after 1500 km.

This also applies when the engine or parts of the drivetrain have been replaced.

Please also observe the following running-in notes:

- In certain handling and driving safety systems, the sensors adjust automatically while a certain distance is being driven after the vehicle has been delivered or after repairs. Full system effectiveness is only reached when this teaching-in process has concluded.
- Brake pads, brake disks and tyres that are either new or have been replaced only achieve optimum braking effect and grip after driving several hundred kilometres. Compensate the reduced braking effect by applying greater force to the brake pedal.

Notes on optimised acceleration

If all necessary requirements and activation conditions are fulfilled, the best possible acceleration can be achieved from a standstill.

Do not use optimised acceleration on public roads. Individual wheels could spin and you could lose control of the vehicle. There is an increased risk of skidding and/or accident.

Be sure to observe the safety notes and information on ESP® (→ page 218).

Pulling away with optimised acceleration

⚠ WARNING Risk of skidding and accidents due to wheelspin

If you pull away with optimised acceleration, individual wheels could spin and you could lose control of the vehicle.

There is a higher risk of skidding and accidents when ESP® is deactivated in particular.

▶ Make sure that there are no persons or obstacles in the vicinity of the vehicle.

Requirements

- the vehicle is run in (→ page 186).
- the vehicle and tyres are in good condition.
- the road surface is high-grip.
- the engine and transmission are at normal operating temperature.

! NOTE Increased wear due to optimised acceleration

When pulling away with optimised acceleration, all components of the drivetrain are subjected to a very high load.

This can lead to increased component wear.

▶ Do not always pull away with optimised acceleration.

- ▶ Engage drive position **D** (→ page 200).
- ▶ Move the steering wheel to the straight-ahead position.
- ▶ Select drive program **S** (→ page 195).
- ▶ Deactivate ESP® (→ page 220).
- ▶ Depress and hold the brake pedal firmly with your left foot.
- ▶ With your right foot, fully depress the accelerator pedal.

▶ After no more than five seconds, take your left foot quickly off the brake, but keep the accelerator pedal depressed.

The vehicle will pull away at maximum acceleration.

▶ Switch on ESP® once the acceleration procedure is complete.

Ending optimised acceleration

▶ Remove your foot from the accelerator pedal.

▶ Reactivate ESP®.

i After you pull away with optimised acceleration, components of the drivetrain can become very hot, which means that optimised acceleration values may be reached again only after a few minutes.

Notes on driving

⚠ WARNING Risk of accident due to objects in the driver's footwell

Objects in the driver's footwell may impede pedal travel or block a depressed pedal.

This jeopardises the operating and road safety of the vehicle.

- ▶ Stow all objects in the vehicle securely so that they cannot get into the driver's footwell.
- ▶ Always fit the floor mats securely and as prescribed in order to ensure that there is always sufficient room for the pedals.
- ▶ Do not use loose floor mats and do not place floor mats on top of one another.

⚠ WARNING Risk of accident due to incorrect footwear

Incorrect footwear includes, for example:

- shoes with platform soles
- shoes with high heels
- slippers

There is a risk of an accident.

- ▶ Always wear suitable footwear so that you can operate the pedals safely.

⚠ WARNING Risk of accident if the vehicle is switched off while driving

If you switch off the vehicle while driving, safety functions are restricted or no longer available.

This may affect the power steering system and the brake force boosting, for example.

You will need to use considerably more force to steer and brake, for example.

- ▶ Do not switch off the vehicle while driving.

⚠ DANGER Risk of fatal injuries due to exhaust gases

Combustion engines emit poisonous exhaust gases such as carbon monoxide. Breathing in these exhaust gases is hazardous to health and results in poisoning.

- ▶ Never leave the engine and, if present, the stationary heater, running in an enclosed space without sufficient ventilation.

⚠ WARNING Risk of skidding and of an accident due to shifting down on slippery road surfaces

If you shift down on slippery road surfaces to increase the engine braking effect, the drive wheels may lose traction.

- ▶ Do not shift down on slippery road surfaces to increase the engine braking effect.

⚠ DANGER Risk of fatal injury due to poisonous exhaust gases

If the tailpipe is blocked or sufficient ventilation is not possible, poisonous exhaust gases such as carbon monoxide may enter the vehicle. This is the case, for example, if the vehicle gets stuck in the snow.

- ▶ Keep the tailpipe and the area around the vehicle free from snow when the engine or the stationary heater is running.

- ▶ Open a window on the side of the vehicle facing away from the wind to ensure an adequate supply of fresh air.

! WARNING Risk of accident due to the brake system overheating

If you leave your foot on the brake pedal when driving, the brake system may overheat.

This increases the braking distance and the brake system can even fail.

- ▶ Never use the brake pedal as a footrest.
- ▶ Do not depress the brake pedal and the accelerator pedal at the same time while driving.

! NOTE Engine damage due to excessively high engine speeds

The engine will be damaged if you drive with the engine in the overrevving range.

- ▶ Do not drive with the engine in the overrevving range.

! NOTE Causing wear to the brake linings by permanently depressing the brake pedal

- ▶ Do not permanently depress the brake pedal while driving.
- ▶ To use braking effect of the engine, shift to a lower gear in good time.

! NOTE Damage to the drivetrain and engine when pulling away

- ▶ Do not warm up the engine while the vehicle is stationary. Pull away immediately.
- ▶ Avoid high engine speeds and driving at full throttle until the engine has reached its operating temperature.

! NOTE Damage to the catalytic converter due to non-combusted fuel

The engine is not running smoothly and is misfiring.

Non-combusted fuel may get into the catalytic converter.

- ▶ Only depress the accelerator pedal slightly.
- ▶ Have the cause rectified immediately at a qualified specialist workshop.

! NOTE Reduced battery life due to frequent short-distance trips

The 12 V battery may not be sufficiently charged when the vehicle is used only for short-distance trips. This reduces the life of the battery.

- ▶ Drive longer distances regularly to charge the battery.

! NOTE Damage to the vehicle due to not observing the maximum permitted headroom clearance

If the vehicle height is greater than the maximum permitted headroom clearance, the roof and other parts of the vehicle may be damaged.

- ▶ Observe the signposted headroom clearance.
- ▶ If the vehicle height is greater than the permitted headroom clearance, do not enter.
- ▶ Observe the changed vehicle height with add-on roof equipment.

i Please bear in mind that all the speed values stated in this Operator's Manual are approximate and are subject to a certain tolerance.

Notes on driving with a roof load, trailer or fully laden vehicle

When driving with a loaded roof luggage rack or trailer as well as with a fully laden or fully occupied vehicle, the vehicle's driving and steering characteristics change.

You should bear the following in mind:

- Do not exceed the permissible roof load and towing capacity. Also observe the information in the Technical Data.
- Distribute the roof load and the load inside the vehicle evenly, placing heavy objects at the

bottom. Also comply with the notes on loading the vehicle (→ page 129).

- Drive attentively, and avoid abrupt starts, braking and steering as well as rapid cornering.

Advice on driving on salt-strewn roads

The braking effect is limited on salt-strewn road surfaces.

Therefore, observe the following notes:

- Due to salt build-up on the brake disks and brake pads, the braking distance can increase considerably or result in one-sided braking.
- Maintain a much greater safety distance to the vehicle travelling ahead.

Remove salt build-up as follows:

- Brake occasionally, paying attention to the traffic conditions
- Carefully depress the brake pedal at the end of the journey and when starting the next journey

Notes on aquaplaning

Aquaplaning can take place if a certain depth of water has built up on the road surface.

Observe the following notes during heavy precipitation or in conditions in which aquaplaning may occur:

- Reduce speed
- Avoid tyre ruts
- Avoid sudden steering movements
- Brake carefully

i Also observe the notes on regularly checking wheels and tyres (→ page 509).

Notes on driving through water on the road

Water ingress can damage the engine, electrics and transmission.

Water can also enter the air intake of the engine and cause engine damage.

Observe the following if you have to drive through water:

- The water, when calm, may reach no higher than the lower edge of the vehicle body.
- Drive at walking speed at most; water can otherwise enter the vehicle interior or the engine compartment.

- Vehicles travelling ahead, or oncoming vehicles, can create waves which may exceed the maximum permissible depth of the water.

The braking effect of the brakes is reduced after fording. Brake carefully, paying attention to the traffic conditions until braking power has been fully restored.

Function of rear axle steering

The rear axle steering is an electromechanical auxiliary steering on the rear axle which adjusts the steering of the rear wheels according to the position of the front wheels, depending on the speed. This results in greater manoeuvrability and improved driving stability, e.g. when cornering.

Rear axle steering has the following characteristics:

- reduced steering effort and turning circle resulting in reduced parking effort
- improved driving stability, e.g. when cornering
- more direct steering resulting in improved handling of the vehicle

Observe the notes on snow chains and snow chain mode (→ page 510).

ECO start/stop function

■ ECO start/stop function

- ⓘ Depending on the engine, the ECO start/stop function is not available in all drive programs. Observe the status display on the driver's display concerning this.

The engine will be switched off automatically in the following situations if all vehicle conditions for an automatic engine stop are met:

- You brake the vehicle to a standstill in transmission position **D** or **N**.
- You depress the brake pedal when travelling at a low speed.

If the system has detected one of the following situations, the engine will not stop:

- You stop at a stop sign and there is no vehicle in front of you.
- The vehicle that stopped in front of you starts up again.





- You manoeuvre, turn the steering wheel sharply or engage reverse gear.

- ⓘ If the system detects an intelligent stop inhibitor, e.g. a stop sign, the engine will not stop. If you activate the HOLD function or engage the park position **P**, the engine can be switched off in spite of an intelligent stop inhibitor.

The engine will restart automatically in the following cases:

- You engage transmission position **D** or **R**.
- You depress the accelerator pedal.
- The vehicle requires an automatic engine start.
- You release the brake pedal.
- You release the brake pedal on a downhill gradient and the vehicle does not roll.
- The vehicle rolls on a downhill gradient and does not automatically enter glide mode at 20 km/h.

ECO start/stop function symbols on the driver's display:



- The  symbol (green) appears when the vehicle is at a standstill: the engine was switched off by the ECO start/stop function.
- The  symbol (yellow) appears when the vehicle is at a standstill: not all vehicle conditions for an engine stop have been met.
- Neither the  symbol nor the  symbol appears when the vehicle is at a standstill: an intelligent stop inhibitor, e.g. a stop sign, has been detected.
- The  symbol appears: the ECO start/stop function is deactivated or there is a malfunction.

If the engine was switched off by the ECO start/stop function and you leave the vehicle, a warning tone will sound and the engine will not be restarted. In addition, the following display message will appear on the driver's display:

Vehicle is operational Switch off vehicle before exiting

If you do not switch off the vehicle, it will automatically be switched off after three minutes.



Switching the ECO start/stop function on/off

- ▶ Press the  button.
A display will appear on the driver's display when you switch the ECO start/stop function on/off.
-   will be continuously shown on the driver's display while the ECO start/stop function is deactivated.

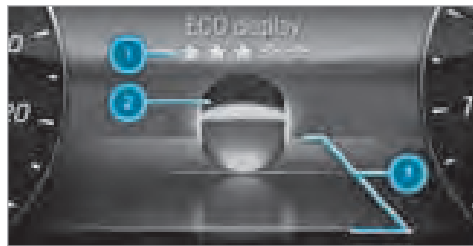
ECO display function



The ECO display shows an evaluation of your driving style on the driver's display depending on the situation. This enables you to check the efficiency of your driving style and adjust it if necessary. The **ECO display** menu shows a ball  that will roll forwards or backwards on a stylised road in the direction of travel according to the driving characteristics.

Above and below the road, lines mark the area for an efficient driving style . Ball  will light up in green if it is rolling within these lines. Outside the lines, the ball will light up in orange.

The ECO display assesses the following criteria for an economical driving style:

- coasting at the right times
- consistent speed
- moderate acceleration

The overall assessment of your driving style "from start" is indicated using stars . It starts with five empty stars, which you can fill one after the other if you drive efficiently. When all five stars are filled, a glow will appear in the background.

- ① You can call up the **ECO display** function via the **Classic** menu (→ page 306).

ECO Assist function (vehicles with 48 V on-board electrical system)

ECO Assist analyses data for the vehicle's expected route. This allows the system to optimally adjust the driving style for the route ahead, save fuel and recuperate. If the system detects an event ahead and the vehicle nears the event, ECO Assist will calculate the optimum speed for maximum fuel economy and recuperative energy based on the distance, speed and downhill gradient.

If the deceleration provided by ECO Assist is not sufficient, you must also brake with the service brake. This is especially the case if, for example, you pull away again in slow-moving traffic and the distance to the vehicle in front is very short.



- ① "Foot off the accelerator" recommendation
- ② Route event ahead







If a route event or vehicle that requires an adjustment of your driving style for more efficiency is detected ahead, corresponding symbol ② and the  symbol (grey) will be displayed.

If you release the accelerator pedal, the  symbol will turn green and recuperation in overrun mode will be initiated. If the deceleration is not sufficient, also apply the service brake. If ECO Assist intervenes for a route event ahead (not for a vehicle in front) and you then press the accelerator pedal again, you end ECO Assist's control.

The ECO Assist display is hidden again in the following cases:

- You do not react to the ECO Assist recommendation for a long time.
- You press the accelerator pedal while ECO Assist is intervening for a route event ahead (not for a vehicle in front).
- ECO Assist cannot identify any further recommendations from the route ahead.

In addition to a vehicle in front , ECO Assist can detect the following route events ② depending on the vehicle's equipment:

-  Roundabout
-  S-bend
-  Sharp bend
-  T-junction
-  Downhill gradient
-  Speed limit

System limits

If the calculated route is adhered to when route guidance is active, ECO Assist will operate with

greater accuracy. The basic function is also available without active route guidance. Not all information and traffic situations can be foreseen. The quality depends on the map data.

ECO Assist is only an aid. The driver is responsible for keeping a safe distance from the vehicle in front, for vehicle speed and for braking in good time.

The system may be impaired or may not function in the following situations:

- If there is poor visibility, e.g. due to insufficient illumination of the road, highly variable shade conditions, rain, snow, fog or heavy spray.
- If there is glare, e.g. from oncoming traffic, direct sunlight or reflections.
- If the windscreen is dirty in the vicinity of the multifunction camera.
- If the multifunction camera is misted up, damaged or obscured.
- If road signs are hard to detect, e.g. due to dirt, snow or insufficient lighting, or because they are obscured.

- If the information in the navigation system's digital map is incorrect or out of date.
- If signs are ambiguous, e.g. road signs in road-works or in adjacent lanes.
- If the radar sensors are dirty or obscured.
- When you drive on roads with steep uphill or downhill gradients.
- If there are narrow vehicles in front, such as bicycles or motorcycles.

DYNAMIC SELECT button

Function of the DYNAMIC SELECT button

 Depending on the engine and equipment, the vehicle has different drive programs.

Use the DYNAMIC SELECT button to change between the following drive programs:

The drive program selected will appear on the driver's display.

Individual

- Individual settings (→ page 195)

Sport

- Maximum output is available
- Sporty driving
- Sporty, but with an emphasis on stability
- Enables a sporty driver to adopt a more active driving style
- Suitable only for good road conditions, a dry surface and a clear stretch of road
- **Vehicles with AIRMATIC:** lowers the vehicle to low level -1

Comfort

- Comfortable and economical driving
- Balance between traction and stability
- Recommended for all road conditions
- **Vehicles with AIRMATIC:**
 - Adjusts the vehicle to normal level
 - From 120 km/h: lowers the vehicle to low level -1
 - Below 80 km/h: raises the vehicle to normal level

E Eco

- Particularly economical driving
- Balance between traction and stability
- Recommended for all road conditions
- **Vehicles with AIRMATIC:** lowers the vehicle to low level -1

i The ESP® settings in the drive programs **E** and **C** are designed for stability. Therefore, choose one of these drive programs especially when transporting roof loads, in trailer operation and when the vehicle is fully loaded or fully occupied.

Depending on the drive program, the following systems will change their characteristics:

- Drive
 - Engine and transmission management
 - Active Distance Assist DISTRONIC
 - Availability of Glide mode
- ESP®
- **Vehicles with AIRMATIC:** suspension
 - Suspension and damping

- Vehicle level

- Steering
- Sound characteristics of the engine in the vehicle interior

Selecting the drive program

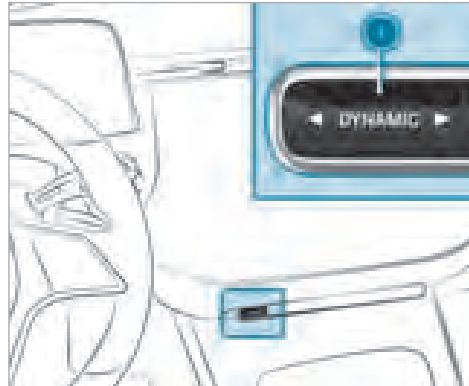

- ▶ Press the DYNAMIC SELECT button **1** on the left or right.
The drive program selected will appear on the driver's display.

Configuring DYNAMIC SELECT (multimedia system)

Multimedia system:

- ▶ ▶ Settings ▶ Vehicle
- ▶ DYNAMIC SELECT

Setting drive program I

- ▶ Select Individual.
- ▶ Select and set a category.

Displaying vehicle data

Multimedia system:

- ▶ ▶ Info
- ▶ Select Vehicle.
The vehicle data is displayed.

Displaying engine data

Multimedia system:



▶ Select **Engine**.

The engine data is displayed.

- ⓘ The actual (maximum) values that can be achieved for engine output and engine torque may deviate from the certified values within the country-specific guidelines for permissible tolerances (basis: UN-ECE No. 85 or country-specific guidelines).

Influencing variables that can influence this are, for example:

- Sea level
- Fuel quality
- Outside temperature
- Operating temperature of the engine

Adjust your driving style accordingly.

The  warning lamp in the driver's display is on until the engine has reached operating temperature.

- ⓘ The values displayed serve only as orientation. The values for engine output and engine torque shown on the central display may deviate from the actual values.
- ⓘ The  warning lamp to show the power output limitation after starting the vehicle is not available in all vehicle models.

Automatic transmission

DIRECT SELECT lever

Function of the DIRECT SELECT lever

⚠ WARNING Risk of accident due to incorrect gearshifting

If the engine speed is higher than the idle speed and you engage the transmission position **D** or **R**, the vehicle may accelerate sharply.

▶ If you engage the transmission position **D** or **R** when the vehicle is at a standstill, always depress the brake pedal

firmly and do not accelerate at the same time.

⚠ WARNING Accident- and risk of injury with unsupervised children in the vehicle

If you leave children unattended in the vehicle, they can in particular

- Open doors and thereby endanger other persons or road users.
- get out of the car and are hit by traffic.
- Operate vehicle equipment and become trapped, for example.

In addition, the children could also set the vehicle in motion, for example by:

- releasing the parking brake.
- change the gearbox setting.
- start the vehicle.

▶ Never leave children unattended in the vehicle.

- ▶ When leaving the vehicle, always take the SmartKey with you and lock the vehicle.
- ▶ Keep the key out of reach of children.

Use the DIRECT SELECT lever to switch the transmission position. The current transmission position will be shown on the driver's display.

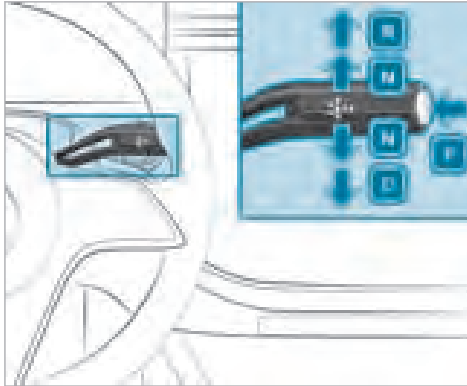

- P** Park position
- R** Reverse gear
- N** Neutral
- D** Drive position

Engaging reverse gear R

⚠ WARNING Risk of accident due to incorrect gearshifting

If the engine speed is higher than the idle speed and you engage the transmission position **D** or **R**, the vehicle may accelerate sharply.

- ▶ If you engage the transmission position **D** or **R** when the vehicle is at a standstill, always depress the brake pedal firmly and do not accelerate at the same time.

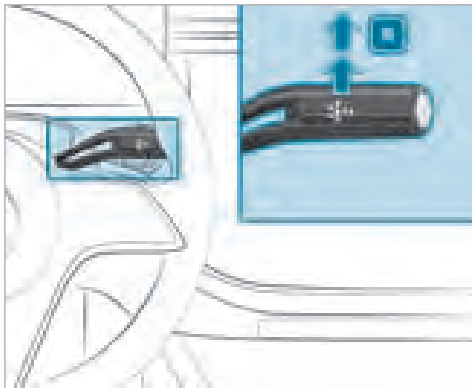

- ▶ Depress the brake pedal and push the DIRECT SELECT lever upwards past the first point of resistance.

Engaging neutral N

⚠ WARNING Risk of accident due to incorrect gearshifting

If the engine speed is higher than the idle speed and you engage the transmission position **D** or **R**, the vehicle may accelerate sharply.

- ▶ If you engage the transmission position **D** or **R** when the vehicle is at a standstill, always depress the brake pedal firmly and do not accelerate at the same time.

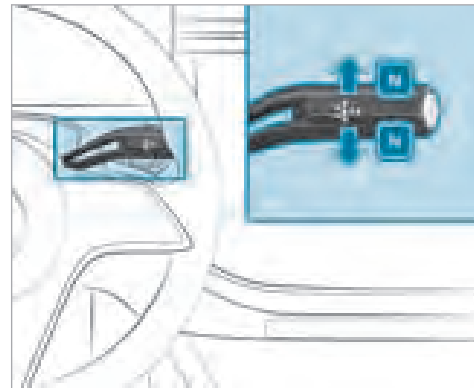

- ▶ Depress the brake pedal and push the DIRECT SELECT lever up or down to the first point of resistance.

- ⓘ To shift into neutral **N** with the vehicle switched on, push the selector lever up or down for several seconds to the first point of resistance.

Subsequently releasing the brake pedal will allow you to move the vehicle freely, e.g. to push it or tow it away.

Proceed as follows if you want the automatic transmission to remain in neutral **N, even if the vehicle is switched off or the driver's door is opened:**

- ▶ Depress the brake pedal and engage neutral **N** when the vehicle is at a standstill.
- ▶ Release the brake pedal.
- ▶ Switch off the vehicle.

The **Risk of vehicle rolling away N activated manually No automatic switch to P** message appears in the driver's display.

- ⓘ If you then exit the vehicle leaving the key in the vehicle, the automatic transmission remains in neutral **N**.

The park position **P** is automatically re-engaged as soon as one of the following conditions is met:

- You switch to transmission position **D** or **R**.
- You press the button **P**.

Engaging park position P

⚠ WARNING Accident- and risk of injury with unsupervised children in the vehicle

If you leave children unattended in the vehicle, they can in particular

- Open doors and thereby endanger other persons or road users.
- get out of the car and are hit by traffic.
- Operate vehicle equipment and become trapped, for example.

In addition, the children could also set the vehicle in motion, for example by:

- releasing the parking brake.
- change the gearbox setting.
- start the vehicle.

- ▶ Never leave children unattended in the vehicle.
- ▶ When leaving the vehicle, always take the SmartKey with you and lock the vehicle.
- ▶ Keep the key out of reach of children.

! **NOTE** Damage due to engaging park position **P** while the vehicle is rolling

If you shift the transmission into park position **P** while the vehicle is rolling, the transmission may be damaged.

- ▶ If the vehicle is rolling, do not open a door.
- ▶ Only engage the park position **P** when the vehicle is stationary.

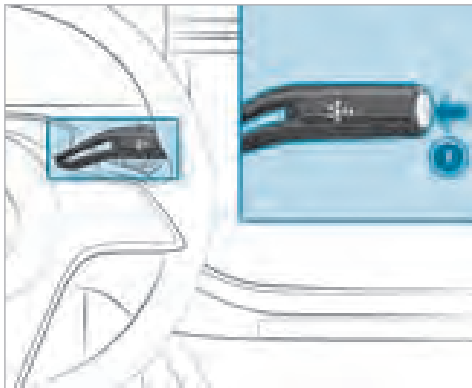

- ▶ Observe the notes on parking the vehicle (→ page 209).
- ▶ Depress the brake pedal until the vehicle comes to a standstill.
- ▶ When the vehicle is stationary, press button ①. When the transmission position display shows **P**, the park position is engaged. If the transmission position display **P** does not appear,

apply the parking brake and secure the vehicle to prevent it from rolling away.

- ① Depending on the situation, it may take a short time until **P** is engaged. Therefore, always pay attention to the transmission position display.

Park position **P** will be engaged automatically if one of the following conditions is met:

- You switch the stationary vehicle off in transmission position **D** or **R**.
- You open the driver's door when the vehicle is stationary in transmission position **D** or **R**.
- When the vehicle is rolling, you switch it off in transmission position **D** or **R** and bring it to a standstill.
- When the vehicle is rolling, you shift to transmission position **N**, bring the vehicle to a standstill and open the driver's door when the vehicle is stationary.
- Engaging park position **P** automatically is required by the vehicle.

- ① To manoeuvre with an open driver's door, open the driver's door while the vehicle is sta-

tionary and engage transmission position **D** or **R** again.

Engaging drive position D

⚠ WARNING Risk of accident due to incorrect gearshifting

If the engine speed is higher than the idle speed and you engage the transmission position **D** or **R**, the vehicle may accelerate sharply.

- ▶ If you engage the transmission position **D** or **R** when the vehicle is at a standstill, always depress the brake pedal firmly and do not accelerate at the same time.

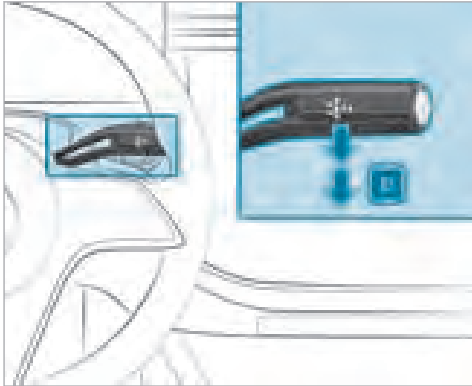

- ▶ Depress the brake pedal and push the DIRECT SELECT lever down past the first point of resistance.

When the automatic transmission is in transmission position **D**, it will shift gears automatically. This depends, among other things, on the following factors:

- The selected drive program
- The position of the accelerator pedal

- The driving speed

Manual gearshifting

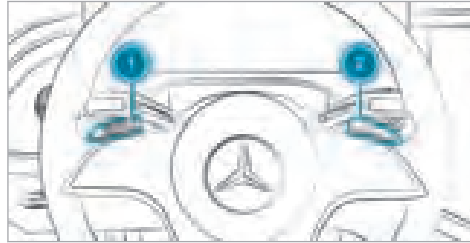

When the automatic transmission is shifted to position **D**, you can manually shift it with the steering wheel gearshift paddle. If permitted, the automatic transmission will shift to a higher or lower gear depending on the steering wheel gearshift paddle being pulled.

You have two options for manually shifting the automatic transmission:

- Temporary setting
- Permanent setting

The gears will shift automatically when manual shifting is deactivated.

Temporary setting:

- ▶ **To activate:** pull steering wheel gearshift paddle **1** or **2**. Manual shifting will be activated for a short time. The transmission position display will show **M** and the current gear.

- ⓘ How long manual shifting stays activated depends on various factors.

Manual shifting can be deactivated automatically in the following cases:

- When the drive program is changed
- When the vehicle is restarted
- When transmission position **D** is engaged again
- Driving style

- ▶ **To shift up:** pull steering wheel gearshift paddle **2**.

- ▶ **To shift down:** pull steering wheel gearshift paddle **1**.

▶ **To deactivate:** pull and hold steering wheel gearshift paddle ②.

The transmission position display will show **D**.

① You can also activate or deactivate manual shifting permanently in the multimedia system.

Gearshift recommendation

The gearshift recommendation assists you in adopting an economical driving style.



▶ When gearshift recommendation ① appears on the driver's display, shift to the recommended gear.

Using kickdown

▶ **Maximum acceleration:** depress the accelerator pedal beyond the point of resistance.

To protect against engine overrev, the automatic transmission will shift up to the next gear when maximum engine speed has been reached.

Glide mode function

With an anticipatory driving style, Glide mode helps you to reduce fuel consumption.

Glide mode is characterised by the following:

- The combustion engine is disconnected from the drivetrain and continues to run in neutral.
- The transmission position display **D** is shown in green.
- The combustion engine can be switched off. All of the vehicle functions remain active.

Glide mode will be activated if the following conditions are met:

- Drive program **E** is selected.
- The speed is within a suitable range.
- The road's course is suitable, e.g. no steep uphill or downhill gradients or tight bends.
- There is no trailer hitched up to the trailer hitch, and no bicycle rack fitted.
- You do not depress the accelerator or brake pedal (except for light brake applications).

① Glide mode can also be activated if you have selected the "Eco" setting for the drive in the drive program **I**.

Glide mode will be deactivated again if one of the conditions is no longer met.

Glide mode can also be prevented by the following parameters:

- Incline
- Downhill gradient
- Temperature
- Height

- speed
- Operating status of the engine
- Traffic situation

Function of 4MATIC

4MATIC ensures that all four wheels are driven. Together with ESP® and 4ETS, 4MATIC improves the traction of your vehicle whenever a driven wheel spins due to insufficient traction.

If you fail to adapt your driving style, 4MATIC can neither reduce the risk of an accident nor override the laws of physics. 4MATIC cannot take account of road, weather or traffic conditions. 4MATIC is only an aid. You are responsible especially for maintaining a safe distance from the vehicle in front, for vehicle speed, for braking in good time and for staying in lane.

- i** In wintry road conditions, the maximum effect of 4MATIC can be achieved only if you use winter tyres (M+S tyres), with snow chains if necessary.

Refuelling

Refuelling the vehicle

⚠ WARNING Risk of fire or explosion from fuel

Fuels are highly flammable.

- ▶ Fire, naked flames, smoking and creating sparks must be avoided.
- ▶ Before refuelling, switch off the vehicle and, if fitted, the stationary heater and keep switched off during filling.

⚠ WARNING Risk of injury from fuels

Fuels are poisonous and hazardous to your health.

- ▶ Do not swallow fuel or let it come into contact with skin, eyes or clothing.
- ▶ Do not inhale fuel vapour.
- ▶ Keep children away from fuel.
- ▶ Keep doors and windows closed during the refuelling process.

If you or other people come into contact with fuel, observe the following:

- ▶ Immediately rinse fuel off your skin with soap and water.
- ▶ If fuel comes into contact with your eyes, immediately rinse them thoroughly with clean water. Seek medical attention immediately.
- ▶ If you swallow fuel, seek medical attention immediately. Do not induce vomiting.
- ▶ Change immediately out of clothing that has come into contact with fuel.

⚠ WARNING Risk of fire and explosion due to electrostatic charge

Electrostatic charge can ignite fuel vapour.

- ▶ Before you open the fuel filler cap or take hold of the pump nozzle, touch the metallic vehicle body.

- ▶ To avoid creating another electrostatic charge, do not get into the vehicle again during the refuelling process.

⚠ WARNING Risk of fire from fuel mixture

Vehicles with a diesel engine:

If you mix diesel fuel with petrol, the flash point of the fuel mixture is lower than that of pure diesel fuel.

While the vehicle is running, component parts in the exhaust system may overheat without warning.

- ▶ Never refuel using petrol.
- ▶ Never mix petrol with diesel fuel.

! NOTE Damage caused by the wrong fuel

Vehicles with a petrol engine:

Even small amounts of the wrong fuel could result in damage to the fuel system, the engine and the emission control system.

- ▶ Only refuel using unleaded, sulphur-free spark-ignition engine fuel that conforms

to European EN 228, or an equivalent specification.

Fuel of this specification may contain up to 10% ethanol. Your vehicle is suitable for use with E10 fuel.

Never refuel with one of the following fuels:

- Diesel
- Regular petrol with an octane number lower than 91 RON
- Petrol with more than 10% ethanol by volume, e.g. E15, E20, E85, E100
- Petrol with more than 3% methanol by volume, e.g. M15, M30
- Petrol with additives containing metal

If you have accidentally refuelled with the wrong fuel:

- ▶ Do not switch on the vehicle.
- ▶ Consult a qualified specialist workshop.

! NOTE Damage caused by the wrong fuel

Vehicles with a diesel engine:

Even small amounts of the wrong fuel could result in damage to the fuel system, the engine and the emission control system.

- ▶ Only refuel using sulphur-free diesel fuel that conforms to European standard EN 590, or an equivalent specification. In countries without sulphur-free diesel fuel, refuel using only low-sulphur diesel fuel with a sulphur content less than 50 ppm.

Never refuel with one of the following fuels:

- Petrol
- Marine diesel
- Heating oil
- Pure bio-diesel or vegetable oil
- Paraffin or kerosene

If you have accidentally refuelled with the wrong fuel:

- ▶ Do not switch on the vehicle.
- ▶ Consult a qualified specialist workshop.

! **NOTE** Do not use diesel to refuel vehicles with a petrol engine

If you have accidentally refuelled with the wrong fuel:

- Do not switch on the vehicle. Otherwise fuel can enter the engine.

Even small amounts of the wrong fuel could result in damage to the fuel system and the engine. The repair costs are high.

- ▶ Consult a qualified specialist workshop.
- ▶ Have the fuel tank and fuel lines drained completely.

! **NOTE** Do not use petrol to refuel vehicles with a diesel engine

If you have accidentally refuelled with the wrong fuel:

- Do not switch on the vehicle. Otherwise, fuel can enter the fuel system.

Even small amounts of the wrong fuel could result in damage to the fuel system and the engine. The repair costs are high.

- ▶ Consult a qualified specialist workshop.
- ▶ Have the fuel tank and fuel lines drained completely.

! **NOTE** Damage to the fuel system due to overfilling the fuel tank

- ▶ Only fill the fuel tank until the pump nozzle switches off.

If too much fuel has been added due, for example, to a faulty filling pump:

- ▶ Do not switch on the vehicle.

- ▶ Consult a qualified specialist workshop.

! **NOTE** Fuel may spray out when you remove the fuel pump nozzle

- ▶ Only fill the fuel tank until the pump nozzle switches off.

Requirements

- The vehicle must be unlocked.

Observe the notes on service products and fuel.

The recommended octane number for your vehicle can be found on the information label in the fuel filler flap.

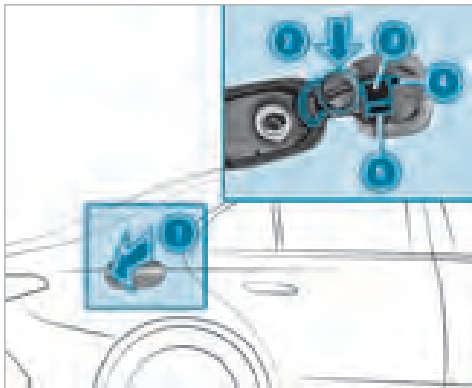

- ➊ Fuel filler flap
- ➋ Bracket for fuel filler cap
- ➌ Tyre pressure table
- ➍ QR code for rescue card
- ➎ Fuel type

- ▶ Press on the rear part of fuel filler flap ➊.
- ▶ Turn the fuel filler cap anti-clockwise and remove it.

- ▶ Insert fuel filler cap from above into bracket ➋.
- ▶ Completely insert the pump nozzle into the tank filler neck, hook in place and refuel.
- ▶ Only fill the fuel tank until the pump nozzle switches off.

- ➊ **Vehicles with a diesel engine:** The tank filler neck is designed for refuelling at diesel filling pumps. Your vehicle is equipped with a system that prevents filling up with the wrong fuel. This function may be deactivated in some countries due to local circumstances. For more information, consult a Mercedes-Benz service centre.
- ➋ **Vehicles with a diesel engine:** Refuel with at least 5 litres of diesel if the fuel tank has been run dry completely.
- ➌ **Vehicles with a diesel engine:** Use a filler neck with a large diameter for vehicles with a diesel engine when topping up fuel from a fuel can. Otherwise, the filler neck cannot be pushed into the tank shaft.

- ▶ Replace the cap on the filler neck and turn clockwise until it engages audibly.
- ▶ Close fuel filler flap ➍.

AdBlue® (vehicles with a diesel engine only)

■ Notes on topping up AdBlue®

AdBlue® is a water-soluble fluid for the NOx exhaust gas aftertreatment of diesel engines. In order for the exhaust gas aftertreatment to function properly, only use AdBlue® in accordance with ISO 22241.

AdBlue® is characterised by the following:

- non-toxic
- colourless and odourless
- non-flammable

If you open the AdBlue® tank, small amounts of ammonia vapour may be released. Only fill the AdBlue® tank in well-ventilated areas.

Do not let AdBlue® come into contact with skin, eyes or clothes. Keep AdBlue® away from children.

Do not ingest AdBlue®. If AdBlue® is swallowed, immediately rinse your mouth out thoroughly. Drink plenty of water. Seek medical attention at once.

Observe the notes on operating fluids (→ page 632).

AdBlue® is available here:

- AdBlue® can be topped up by fast service at a qualified specialist workshop, e.g. a Mercedes-Benz Service Centre.
 - AdBlue® is available at many filling stations from AdBlue® filling pumps.
 - Alternatively, AdBlue® is available at qualified specialist workshops, e.g. Mercedes-Benz Service Centres, and at many filling stations in AdBlue® refill canisters or AdBlue® refill bottles.
- i** Ensure the connection between the refill container and vehicle filler neck does not drip.

■ Topping up AdBlue®

! **NOTE** Engine damage due to AdBlue® being in the fuel

- ▶ AdBlue® must not be used to fill the fuel tank.
- ▶ Only use AdBlue® to fill the AdBlue® tank.
- ▶ Do not overfill the AdBlue® tank.

! **NOTE** Contamination of the vehicle interior due to AdBlue® leakage

- ▶ After topping up, carefully close the AdBlue® refill container.
- ▶ Avoid carrying AdBlue® refill containers permanently in the vehicle.

Requirements

- The vehicle is unlocked.

The following messages appear in order in the driver's display when the AdBlue® tank requires refilling:

- **Refill AdBlue See Owner's Manual.** The AdBlue® level has fallen into the reserve range. Refill AdBlue® immediately.
- **Top up AdBlue Emergency op. in XXX km See Owner's Manual.** The low AdBlue® level will lead to limited performance after the remaining distance displayed has been covered. Refill AdBlue® immediately.
- **Top up AdBlue XX,X l Emerg. op.: max. XXX km/h Start not poss. in XXX km.** The low AdBlue® level will lead to an output restriction from the speed displayed. After the remaining distance displayed has been covered, it will no longer be possible to start the vehicle. Refill at least the indicated amount of AdBlue®.
- **Top up AdBlue XX,X l Switch vehicle on, wait 60 sec. or engine start not poss..** The AdBlue® tank is empty. You can no longer start the vehicle. Refill at least the indicated amount of AdBlue®. Switch on the vehicle and

wait for approximately 60 seconds. Start the vehicle.

You can see the AdBlue® range and level in the **Service** menu in the driver's display.

- ① The AdBlue® range shown depends strongly on the driving style and operating conditions. The actual range can therefore differ from the calculated range.

Opening the AdBlue® filler cap

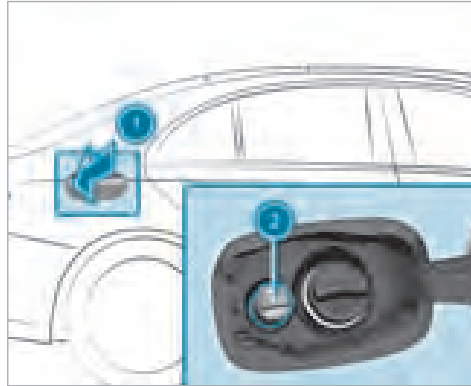

- ▶ Press on the rear part of fuel filler flap ①.
- ▶ Turn AdBlue® filler cap ② anti-clockwise and remove it.
- ① You can also place the AdBlue® filler cap in the fuel filler cap holder in the fuel filler flap hinge arm.

Topping up AdBlue®

Mercedes-Benz recommends refilling AdBlue® at a filling pump. If no AdBlue® filling pump is available, you can also top up AdBlue® using a canister.

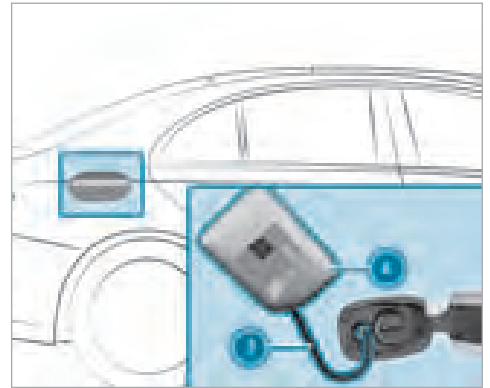

- ▶ Screw on the fastener of AdBlue® refill canister ④.

- ▶ Screw the disposable hose ③ onto the opening of AdBlue® refill canister ④ until hand-tight.
- ▶ Screw the disposable hose ③ onto the filler neck of the vehicle until hand-tight.
- ▶ Lift up and tip AdBlue® refill canister ④. The filling process stops when the AdBlue® tank is completely full.
The AdBlue® refill canister ④ can be removed even if it has been only partially emptied.
- ▶ Unscrew and close the disposable hose ③ and AdBlue® refill canister ④ in reverse order.
- ▶ Replace AdBlue® filler cap ② and turn it clockwise until it audibly engages.
- ▶ Close fuel filler flap ①.
- ▶ Switch on the vehicle for at least 60 seconds.
- ① If the vehicle could not be started because the AdBlue® tank was empty, it can take up to 60 seconds for the refill to be detected.
- ▶ Start the vehicle.

- ① Avoid storing AdBlue® refill containers permanently in the vehicle.

Parking

Parking the vehicle

- ⚠ **WARNING** Risk of accident and injury caused by an insufficiently secured vehicle rolling away

If the vehicle is not securely parked sufficiently, it can roll away in an uncontrolled way even at a slight downhill gradient.

- ▶ On uphill or downhill gradients, turn the front wheels so that the vehicle rolls towards the kerb if it starts moving.
- ▶ apply the parking brake.
- ▶ Switch the transmission to position **P**.

- ⚠ **WARNING** Risk of fire caused by hot exhaust system parts

Flammable materials such as leaves, grass or twigs may ignite.

- ▶ Park the vehicle so that no flammable material can come into contact with hot vehicle components.
- ▶ In particular, do not park on dry grass-land or harvested grain fields.

- ⚠ **WARNING** Accident- and risk of injury with unsupervised children in the vehicle

If you leave children unattended in the vehicle, they can in particular

- Open doors and thereby endanger other persons or road users.
- get out of the car and are hit by traffic.
- Operate vehicle equipment and become trapped, for example.

In addition, the children could also set the vehicle in motion, for example by:

- releasing the parking brake.
- change the gearbox setting.
- start the vehicle.

- ▶ Never leave children unattended in the vehicle.
- ▶ When leaving the vehicle, always take the SmartKey with you and lock the vehicle.
- ▶ Keep the key out of reach of children.

This also applies to the Digital Vehicle Key.

! **NOTE** Damage to the vehicle due to it rolling away

- ▶ Always secure the vehicle against rolling away.

! **NOTE** Damage caused by vehicle being lowered

Vehicles AIRMATIC: The vehicle can be lowered due to differences in temperature or extended non-operational times. This can cause damage to parts of the body.

- ▶ When stopping the vehicle and when driving off, make sure that there are no obstacles such as kerbs under or in the immediate vicinity of the body.



- ▶ Bring the vehicle to a standstill by depressing the brake pedal.
- ▶ On uphill or downhill gradients, turn the front wheels so that the vehicle rolls towards the kerb if it starts moving.
- ▶ Apply the electric parking brake.

- ▶ Engage transmission position **P** in a stationary vehicle with the brake pedal depressed (→ page 199).
 - ▶ Switch off the vehicle by pressing button **1**.
 - ▶ Release the service brake slowly.
 - ▶ Get out of the vehicle and lock it.
- i** When you park the vehicle, you can still operate the side windows and the panoramic sliding sunroof for approximately four minutes if the driver's door is closed.

Automatic shut-off function of the vehicle

If you leave the engine running and leave the vehicle, the driver's display will show the **Vehicle is ready to drive Shutdown occurs when locked or automatically in XX mins** display message.

The vehicle will then switch off automatically after 20 minutes.

If you leave the engine running and remain in the vehicle while it is in park position **P**, the **Vehicle is ready to drive Shutdown occurs when locked or automatically in XX mins** display message will appear on the driver's display after ten minutes.

The vehicle will be switched off automatically after a further ten minutes.

- ① To avoid automatic switch-off, acknowledge the message on the central display of the multimedia system.

Electric parking brake

Function of the electric parking brake (applying automatically)

⚠ WARNING Accident- and risk of injury with unsupervised children in the vehicle

If you leave children unattended in the vehicle, they can in particular

- Open doors and thereby endanger other persons or road users.
- get out of the car and are hit by traffic.
- Operate vehicle equipment and become trapped, foreexample.

In addition, the children could also set the vehicle in motion, for example by:

- releasing the parking brake.
 - change the gearbox setting.
 - start the vehicle.
- ▶ Never leave children unattended in the vehicle.
 - ▶ When leaving the vehicle, always take the SmartKey with you and lock the vehicle.
 - ▶ Keep the key out of reach of children.

This also applies to the Digital Vehicle Key.

The electric parking brake is applied if the transmission is in position **P and one of the following conditions is fulfilled:**

- The vehicle is switched off.
- The seat belt tongue is not inserted in the seat belt buckle of the driver's seat and the driver's door is opened.

- ① To prevent application: pull the handle of the electric parking brake (→ page 212).

In the following situations, the electric parking brake is also applied:

- The HOLD function is keeping the vehicle stationary.
- Active Parking Assist is keeping the vehicle stationary.
- Active Distance Assist DISTRONIC is bringing the vehicle to a standstill.
- **In addition, one of the following conditions must be fulfilled:**
 - The vehicle is switched off.
 - The seat belt tongue is not inserted in the seat belt buckle of the driver's seat and the driver's door is opened.
 - There is a system malfunction.
 - The power supply is insufficient.
 - The vehicle is stationary for a lengthy period.

When the electric parking brake is applied, the red **(P)** indicator lamp lights up in the driver's display.

- ⓘ The electric parking brake is not automatically applied if the vehicle is switched off by the ECO start/stop function.

■ Function of the electric parking brake (releasing automatically)

The electric parking brake is released when the following conditions are fulfilled:

- The driver's door is closed.
- The vehicle has been started.
- The transmission is in position **D** or **R** and you depress the accelerator pedal or you shift from transmission position **P** to **D** or **R** when on level ground.
- If the transmission is in position **R**, the boot lid must be closed.
- The seat belt tongue is inserted into the seat belt buckle of the driver's seat.

If the seat belt tongue is not inserted into the seat belt buckle of the driver's seat, one of the following conditions must be fulfilled:

- You shift from transmission position **P**.
- or

- You have previously driven at speeds greater than 3 km/h.

When the electric parking brake is released, the red  indicator lamp in the driver's display goes out.

■ Applying/releasing the electric parking brake manually

⚠ WARNING Accident- and risk of injury with unsupervised children in the vehicle

If you leave children unattended in the vehicle, they can in particular

- Open doors and thereby endanger other persons or road users.
- get out of the car and are hit by traffic.
- Operate vehicle equipment and become trapped, for example.

In addition, the children could also set the vehicle in motion, for example by:

- releasing the parking brake.

- change the gearbox setting.
- start the vehicle.

- ▶ Never leave children unattended in the vehicle.
- ▶ When leaving the vehicle, always take the SmartKey with you and lock the vehicle.
- ▶ Keep the key out of reach of children.

This also applies to the Digital Vehicle Key.

Applying

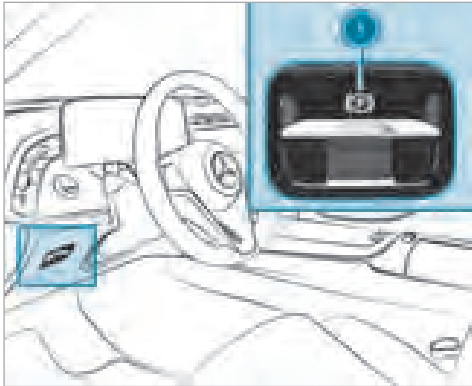

- ▶ Push handle ①.
The red (P) indicator lamp lights up in the driver's display.
- ⓘ The electric parking brake is only securely applied if the red (P) indicator lamp is lit continuously.

Releasing

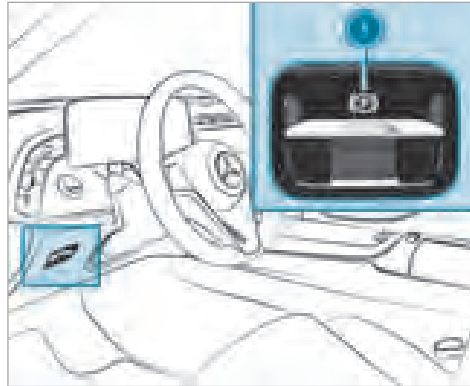

- ▶ Switch on the vehicle.
- ▶ Pull handle ①.
The red (P) indicator lamp in the driver's display goes out.

Emergency braking

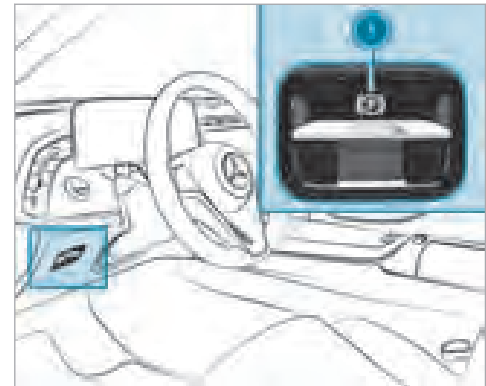

- ▶ Press and hold handle ①.
As long as the vehicle is in motion, the **Release parking brake** message is displayed and the red (P) indicator lamp flashes.
When the vehicle has been braked to a standstill, the electric parking brake is applied. The

red  indicator lamp lights up in the driver's display.

Information on collision detection on a parked vehicle

If a collision is detected on the locked vehicle when towing protection is switched on and collision detection is switched on, you will receive a message in the multimedia system when the vehicle is switched on.

You will receive information about the following points:

- The area of the vehicle that may have been damaged.
- The force of the impact.

The following situation can lead to inadvertent activation:

- The parked vehicle is moved, foreexample, in a two-storey garage.

 Deactivate tow-away protection in order to prevent inadvertent activation. If you deacti-

vate tow-away protection, collision detection will also be deactivated.

You can permanently deactivate collision detection via the multimedia system (→ page 214).

System limits

Detection may be restricted in the following situations:

- the vehicle is damaged without impact, foreexample, if an outside mirror is torn off or the paint is damaged by a key
 - an impact occurs at low speed
 - the electric parking brake is not applied
-  You are responsible for your vehicle. Convince yourself that your vehicle is free of damage and roadworthy.

Setting collision detection on a parked vehicle

Multimedia system:

  **Settings**  **Vehicle**
 **Open/close**  **Vehicle protection**

 Activate or deactivate the function via **Collision notification**.

 A maximum of three incidents can be registered. Up to 15 photos are taken for every incident. In the event of another incident, the photos of the first incident will be overwritten if they have not been deleted already.

Activating or deactivating the collision photos function

Note possible legal restrictions in some countries regarding automatic recording of the vehicle surroundings.

 Activate or deactivate **Collision photos**.

Transferring the collision photos with the Mercedes me App

 Select **Upload collision photos**.

 Select **Upload automatically**.

- ▶ Scan the generated QR code on the central display with the Mercedes me App. The encrypted collision photos will then be uploaded to Mercedes me.

- ❗ Any device that can scan QR codes can be used to view the collision photos in the Mercedes me App.

Copying the collision photos to a USB flash drive

- ▶ Connect a USB flash drive (→ page 456).
- ▶ Select **Manage collision photos**.
- ▶ Select **Copy (USB)**.
All collision photos are copied to the USB flash drive.

- ❗ To ensure secure operation, only use with FAT32 or exFAT formatted USB storage devices.

Deleting collision photos

- ▶ Select **Manage collision photos**.
- ▶ Select **Delete**.
All collision photos will be deleted.

Notes on parking up the vehicle

If you leave the vehicle parked up for longer than six weeks, it may suffer damage through disuse.

The 12 V battery may also be impaired or damaged by heavy discharging.

- ❗ Further information can be obtained at a qualified specialist workshop.

Driving and driving safety systems

Driving systems and your responsibility

Your vehicle is equipped with driving systems which assist you in driving, parking and manoeuvring the vehicle. The driving systems are only aids. They are not a substitute for you paying attention to your surroundings and do not relieve you of your responsibility pertaining to road traffic law. The driver is always responsible for maintaining a safe distance to the vehicle in front, for vehicle speed, for braking in good time and for staying in lane. Pay attention to the traffic conditions at all times and intervene when necessary. Be aware of the limitations regarding the safe use of these systems.

Driving systems can neither reduce the risk of accident if you fail to adapt your driving style nor override the laws of physics. They cannot always take into account road, weather or traffic conditions.

- ❗ Some driving systems can regulate or limit the speed to a previously set value. Draw attention to the stored speed when changing drivers.

Information on vehicle sensors and cameras

Some driving and driving safety systems use cameras as well as radar or ultrasonic sensors to monitor the area in front of, behind or next to the vehicle.

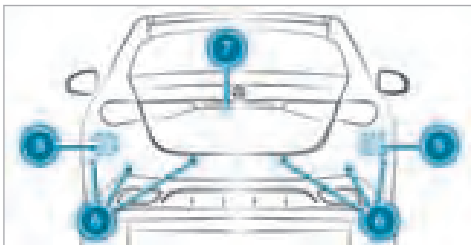
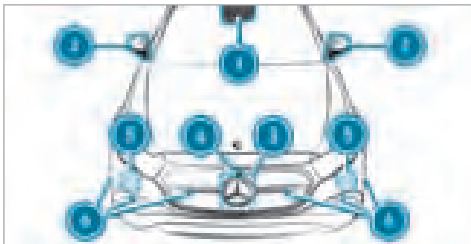

- ① Multifunction camera
- ② Cameras in the outside mirrors
- ③ Front radar
- ④ Front camera

- ⑤ Corner radars
- ⑥ Ultrasonic sensors
- ⑦ Reversing camera

⚠ WARNING Risk of accident due to restricted detection performance of vehicle sensors and cameras

If the area around vehicle sensors or cameras is covered, damaged or dirty, certain driving and safety systems cannot function correctly. There is a risk of an accident.

- ▶ Keep the area around vehicle sensors or cameras clear of any obstructions and clean.
- ▶ Have damage to the bumper, radiator grille or stone chipping in the area of the front and rear windows repaired at a qualified specialist workshop.

Particularly, keep the areas around the sensors and cameras free of dirt, ice or slush (→ page 481). The sensors and cameras must not be covered and the detection ranges around them must be kept free. Do not attach additional

licence plate brackets, advertisements, stickers, foils or foils to protect against stone chippings in the detection range of the sensors and cameras. Make sure that there are no overhanging loads protruding into the detection range.

If there is damage to a bumper or the radiator grille, or after an impact, have the function of the sensors checked at a qualified specialist workshop. Have damage or stone chipping in the area of the cameras on the front and rear windows repaired at a qualified specialist workshop.

- ⓘ The reversing camera can extend and retract automatically for the purpose of calibration, even though there is no camera image in the display.

Overview of driving systems and driving safety systems

- ABS (→ page 217)
- BAS (→ page 218)
- ESP® (→ page 218)
- ESP® Crosswind Assist (→ page 219)

- ESP® trailer stabilisation (→ page 219)
- EBD (→ page 220)
- STEER CONTROL (→ page 220)
- HOLD function (→ page 220)
- Hill Start Assist (→ page 221)
- Adaptive Brake Lights (→ page 222)
- ATTENTION ASSIST (→ page 222)
- Cruise control (→ page 224)
- Limiter (→ page 225)
- Speed Limit Assist (country-dependent) (→ page 248)
- Traffic Sign Assist (→ page 250)
- Traffic light view (→ page 255)

Driving Assistance Package

- i** The availability of some functions or sub-functions of the Driving Assistance Package is equipment- or country-specific. The functions of your Driving Assistance Package may differ from the functions listed here. Active Distance Assist DISTRONIC, Active Blind Spot Assist, Active Brake Assist, Active

Lane Keeping Assist and Active Emergency Stop Assist are also available without the Driving Assistance Package, albeit with restricted functionality.

- Active Distance Assist DISTRONIC (→ page 228)
- Active Speed Limit Assist (→ page 234)
- Route-based speed adaptation (→ page 235)
- Active Brake Assist (→ page 243)
- Active Steering Assist (→ page 237)
- Active Emergency Stop Assist (→ page 239)
- Active Lane Change Assist (→ page 241)
- Active Stop-and-Go Assist (→ page 236)
- Active Blind Spot Assist with exit warning (→ page 255)
- Active Lane Keeping Assist (→ page 258)
- PRE-SAFE® Impulse Side (→ page 53)

Parking Package

- i** The availability of individual functions depends on the country and equipment.
- Reversing camera (→ page 263)

- 360° Camera (→ page 265)
- Parking Assist PARKTRONIC (→ page 271)
- Active Parking Assist (→ page 275)
- Remote Parking Assist (→ page 281)
- Memory Parking Assist (country-dependent) (→ page 288)

Functions of ABS

The Anti-lock Brake System (ABS) regulates the brake pressure in critical driving situations:

- During braking, for instance, at maximum full-stop braking or if there is insufficient tyre traction, the wheels are prevented from locking.
- Vehicle steerability while braking is ensured.

If ABS intervenes when braking, you will feel a pulsing in the brake pedal. The pulsating brake pedal can be an indication of hazardous road conditions and can serve as a reminder to take extra care while driving.

System limits

- ABS is active from speeds of approx. 5 km/h.

- ABS may be impaired or may not function if a malfunction has occurred and the yellow  ABS warning lamp lights up continuously after the vehicle is started.

Function of BAS

⚠ WARNING Risk of an accident caused by a malfunction in BAS (Brake Assist System)

If BAS is malfunctioning, the braking distance in an emergency braking situation is increased.

- ▶ Depress the brake pedal with full force in emergency braking situations. ABS prevents the wheels from locking.

The Brake Assist System (BAS) supports your emergency braking situation with additional brake force.

If you depress the brake pedal quickly, BAS is activated:

- BAS automatically boosts the brake pressure.
- BAS can shorten the braking distance.

- ABS prevents the wheels from locking.

The brakes will function as usual once you release the brake pedal. BAS is deactivated.

Function of ESP®

⚠ WARNING Risk of skidding if ESP® is deactivated

If you deactivate ESP®, ESP® cannot carry out vehicle stabilisation.

- ▶ ESP® should only be deactivated in the following situations.

The Electronic Stability Program (ESP®) can monitor and improve driving stability and traction in the following situations within physical limits:

- When pulling away on wet or slippery carriageways.
- When braking.

If the vehicle deviates from the direction desired by the driver, ESP® can stabilise the vehicle by intervening in the following ways:

- One or more wheels are braked.
- The engine output is adapted according to the situation.

When ESP® is deactivated, the  warning lamp lights up continuously:

- Driving stability will no longer be improved.
- The drive wheels could spin.
- ETS/4ETS traction control is still active.

i When ESP® is deactivated, you are still assisted by ESP® when braking.

When the  warning lamp flashes, one or several wheels has reached its grip limit:

- Adapt your driving style to suit the current road and weather conditions.
- Do not deactivate ESP®.
- Only depress the accelerator pedal as far as is necessary when pulling away.

Deactivate ESP® in the following situations to improve traction:

- When using snow chains.
- In deep snow.
- On sand or gravel.

 Spinning the wheels results in a cutting action, which enhances traction.

If the  ESP® warning lamp lights up continuously, ESP® is not available due to a malfunction.

Observe the following information:

- Indicator and warning lamps (→ page 729)
- Display messages (→ page 644)

ETS/4ETS (Electronic Traction System)

ETS/4ETS traction control is part of ESP® and makes it possible to pull away and accelerate on a slippery carriageway.

ETS/4ETS can improve the vehicle's traction by intervening in the following ways:

- The drive wheels are braked individually if they spin.

- More drive torque is transferred to the wheel or wheels with traction.

Influence of drive programs on ESP®

The drive programs enable ESP® to adapt to different weather and road conditions as well as the driver's preferred driving style. Depending on the selected drive program, the appropriate ESP® mode will be activated. You can select the drive programs using the DYNAMIC SELECT switch (→ page 195).

Function of ESP® Crosswind Assist

ESP® Crosswind Assist detects sudden gusts of side wind and helps the driver to keep the vehicle in the lane:

- ESP® Crosswind Assist is active at vehicle speeds between approx. 80 km/h and 200 km/h when driving straight ahead or cornering slightly.
- The vehicle is stabilised by means of individual brake application on one side.

Function of ESP® trailer stabilisation

 **WARNING** Risk of accident in poor road and weather conditions

In poor road and weather conditions, the trailer stabilisation cannot prevent lurching of the vehicle/trailer combination. Trailers with a high centre of gravity may tip over before ESP® detects this.

 Always adapt your driving style to suit the current road and weather conditions.

When driving with a trailer, ESP® can stabilise your vehicle if the trailer begins to swerve from side to side:

- ESP® trailer stabilisation is active above speeds of 65 km/h.
- Slight swerving is reduced by means of a targeted, individual brake application on one side.
- In the event of severe swerving, the operating energy output is also reduced and all wheels are braked.

ESP® trailer stabilisation may be impaired or may not function if:

- The trailer is not connected correctly or is not detected properly by the vehicle.

Activating/deactivating ESP® (Electronic Stability Program)

Multimedia system:



- ▶ Select **ESP**.
- ▶ Select **On** or  **Off**.

ESP® is deactivated if the  ESP® OFF warning lamp lights up continuously in the driver's display.

Observe any information on warning lamps and display messages which may be shown in the driver's display.

Function of EBD

Electronic Brakeforce Distribution (EBD) is characterised by the following:

- Monitoring and regulating the brake pressure on the rear wheels.
- Improved driving stability when braking, especially on bends.

Function of STEER CONTROL

STEER CONTROL assists you by transmitting a noticeable steering force to the steering wheel in the direction required for vehicle stabilisation.

This steering recommendation is given in the following situations:

- both right wheels or both left wheels are on a wet or slippery road surface when you brake
- the vehicle starts to skid

System limits

STEER CONTROL may be impaired or may not function in the following situations:

- ESP® is deactivated.

- ESP® is malfunctioning.
- The steering is malfunctioning.

If ESP® is malfunctioning, you will be assisted further by the electric power steering.

HOLD function

■ HOLD function

The HOLD function holds the vehicle at a standstill without requiring you to depress the brake pedal, e.g. while waiting in traffic.

The HOLD function is only an aid. The responsibility for the vehicle safely standing still remains with the driver.

System limits

The HOLD function is only intended to provide assistance when driving and is not a sufficient means of safeguarding the vehicle against rolling away when stationary.

- The incline must not be greater than 30%.

Activating/deactivating the HOLD function

⚠ WARNING Risk of an accident due to the HOLD function being active when you leave the vehicle

If the vehicle is only braked with the HOLD function it could, in the following situations, roll away:

- If there is a malfunction in the system or in the power supply.
- If the HOLD function is deactivated by depressing the accelerator pedal or brake pedal, e.g. by a vehicle occupant.

▶ Always secure the vehicle against rolling away before you leave it.

Requirements

- The vehicle is stationary.
- The driver's door is closed or the seat belt on the driver's side is fastened.
- The vehicle has been started or has been automatically switched off by the ECO start/stop function.

- The electric parking brake is released.
- Active Distance Assist DISTRONIC is deactivated.
- The transmission is in position **D**, **R** or **N**.

Activating the HOLD function

- ▶ Depress the brake pedal, and after a short time quickly depress further until the **HOLD** display appears in the driver's display.
- ▶ Release the brake pedal.

Deactivating the HOLD function

- ▶ Depress the accelerator pedal to pull away.
- or
- ▶ Depress the brake pedal until the **HOLD** display disappears from the driver's display.

The HOLD function is deactivated in the following situations:

- Active Distance Assist DISTRONIC is activated.
- The transmission is shifted to position **P**.
- The vehicle is secured with the electric parking brake.

In the following situations, the vehicle is held by transmission position **P** and/or by the electric parking brake:

- The seat belt is unfastened and the driver's door is opened.
- The vehicle is switched off.
- There is a system malfunction.
- The power supply is insufficient.

In addition, the **Brake immediately** message may appear in the driver's display and a horn tone may sound at regular intervals.

- ▶ Immediately depress the brake pedal firmly until the warning message disappears. The HOLD function is deactivated.
- ▶ Additionally secure the vehicle against rolling away.

Function of Hill Start Assist

Hill Start Assist holds the vehicle for a short time when pulling away on a hill under the following conditions:

- The transmission is in position **D** or **R**.

- The electric parking brake is released.

This gives you enough time to move your foot from the brake pedal to the accelerator pedal and depress it before the vehicle begins to roll away.

⚠ WARNING Risk of accident and injury due to the vehicle rolling away

After a short time, Hill Start Assist no longer holds the vehicle.

▶ Swiftly move your foot from the brake pedal to the accelerator pedal. Do not leave the vehicle when it is being held by Hill Start Assist.

Function of Adaptive Brake Lights

Adaptive Brake Lights warn following traffic in an emergency braking situation with the following actions:

- flashing the brake lamps
- activating the hazard warning lights (→ page 150)

If the vehicle is braked sharply from speeds above 50 km/h, the brake lamps flash rapidly. This provides traffic travelling behind you with an even more noticeable warning.

ATTENTION ASSIST

Function of ATTENTION ASSIST

i Depending on the country and equipment, ATTENTION ASSIST has the sub-functions microsleep detection and distraction detection. These functions are only available in conjunction with the driver camera in the driver display (→ page 352).

ATTENTION ASSIST assists you on long, monotonous journeys, e.g. on motorways and trunk roads. If indicators of fatigue or increasing lapses in concentration on the part of the driver are detected, the system suggests taking a break.

ATTENTION ASSIST is only an aid. It cannot always detect fatigue or lapses in concentration in time. The system is not a substitute for a well-rested and attentive driver. On long journeys, take regular breaks in good time that allow for adequate recuperation.

You can choose between two settings:

- **Standard:** normal system sensitivity.
- **Sensitive:** higher system sensitivity. The driver is warned earlier and the attention level detected by ATTENTION ASSIST is adapted accordingly.

If fatigue or increasing inattention is detected, the warning appears in the driver display: **ATTENTION ASSIST: Take a break!** you can acknowledge the message and take a break if necessary. If you do not take a break and ATTENTION ASSIST continues to detect increasing lapses in concentration, you will be warned again after a minimum of 15 minutes.

If ATTENTION ASSIST is unable to calculate the attention level and cannot issue a warning, the **System suspended** message appears.

If the driver display shows a warning, a service area search is offered in the multimedia system. You can select a rest area and start navigation to this rest area.

When you restart the vehicle, ATTENTION ASSIST is automatically switched on. The last selected sensitivity level remains stored.



The following information is displayed in the driver's display:

- The length of the journey since the last break
- The attention level determined by ATTENTION ASSIST:
 - The more segments ② of the circle displayed, the higher the detected attention level.
 - Fewer segments ② are displayed in the circle as the attention level decreases.

- The status of microsleep and distraction detection ①:
 - Deactivated: display ① is hidden.
 - Activated but not operational: display ① is grey.
 - Activated and operational: display ① is green.

Microsleep detection

If the system, which uses the driver camera, detects indicators of microsleep, the **ATTENTION ASSIST Microsleep Take a break!** warning message appears in the driver's display and a warning tone sounds simultaneously. This warning message must be confirmed by Touch Control. It is recommended that you take a break immediately.

If the driver does not react to the microsleep warning, an emergency stop can be initiated by the system (→ page 239).

Distraction detection

Attention Assist can use the driver's camera to detect when the driver is distracted by averting his or her gaze from the road ahead.

If the system detects driver distraction, after a few seconds the white message **ATTENTION ASSIST Remain alert!** appears and a warning tone sounds. If the driver does not turn his gaze back to the traffic scene, the message is displayed in yellow and a continuous warning tone sounds. If the driver still does not react to the warning, an emergency stop can be initiated by the system (→ page 239).

System limits

ATTENTION ASSIST is active in the 60 km/h to 200 km/h speed range.

The microsleep detection function is available at a speed of 20 km/h and above.

If the system is not available due to an error, the ATTENTION ASSIST warning light  lights up continuously in the driver display.

Particularly in the following situations, ATTENTION ASSIST only functions in a restricted manner and warnings may be delayed or not occur:

- If you have been driving for less than approximately 30 minutes.

- If the road condition is poor (uneven road surface or potholes).
- If there is a strong side wind.
- If you adopt a sporty driving style (high cornering speeds or high rates of acceleration).
- If the Steering Assist function of Active Distance Assist DISTRONIC is active.
- If the clock is set to the incorrect time.
- If you change lanes and vary your speed frequently in active driving situations.

In addition, microsleep and distraction detection does not function when the driver camera cannot detect the driver's eyes, for example as a result of the following factors:

- The driver's eyes are covered due to the steering column position, for example.
- Poor lighting conditions.
- Some types of spectacles or sunglasses.
- The driver's line of vision is outside the driver camera's field of vision.

Also observe any information regarding display messages that can be displayed in the driver's display.

The ATTENTION ASSIST drowsiness or alertness assessment is reset and restarted when continuing the journey in the following situations:



- You switch off the vehicle.
- If you unfasten your seat belt and open the driver's door (e.g. to change drivers or take a break).

Setting ATTENTION ASSIST

Multimedia system:

  **Settings**  **Assistance**
 **Assistance**  **ATTENTION ASSIST**

Setting the sensitivity

-  Select  next to **ATTENTION ASSIST**.
-  Select **Standard** or **Sensitive**.

Activating/deactivating the microsleep warning

-  Activate or deactivate **Microsleep warning**.

Cruise control and limiter



Function of cruise control

Cruise control regulates the speed to the value selected by the driver.

If you accelerate to overtake, for example, the stored speed is not deleted. If you remove your foot from the accelerator pedal after overtaking, cruise control will resume speed regulation back to the stored speed.

Observe the notes on driving systems and your responsibility; you may otherwise fail to recognise dangers (→ page 215).

Displays in the driver's display

-  (grey): cruise control is selected but not yet active, or temporarily passive.
-  (green): cruise control is active.

A stored speed appears under the  display and is indicated in the speedometer.

System limits

Cruise control may be unable to maintain the stored speed on uphill gradients. The stored speed is resumed when the gradient evens out.

Change into a lower gear in good time on long and steep downhill gradients. Take particular note of this when driving a laden vehicle. By doing so, you will make use of the engine's braking effect. This relieves the load on the brake system and prevents the brakes from overheating and wearing too quickly.

Do not use cruise control in the following situations:

- in traffic situations which require frequent changes of speed, e.g. in heavy traffic, on winding roads
- on slippery roads. Accelerating can cause the drive wheels to lose traction and the vehicle could then skid.
- when visibility is poor

Function of the limiter

The limiter restricts the speed of the vehicle. To reduce the speed to the set speed, the limiter applies the brakes automatically.

You can limit the speed as follows:



- **Variable:** for a short-term speed restriction, e.g. in built-up areas

- **Permanent:** for a longer-term speed restriction, e.g. in winter tyre mode

You can store any speed above 20 km/h up to the maximum design speed or up to the set winter tyre limit. You can also perform settings while the vehicle is stationary if the vehicle has been started.

Observe the notes on driving systems and your responsibility; you may otherwise fail to recognise dangers (→ page 215).

Displays in the driver's display

-  (grey): variable limiter is selected but not yet activated.
-  (flashes grey): variable limiter is temporarily passive.
-  (green): variable limiter is activated.

A stored speed appears under the  display and is indicated in the speedometer.

If you depress the accelerator pedal beyond the pressure point (kickdown), the variable limiter switches to passive mode. The message 

passive appears in the driver's display and the display  flashes.

The variable limiter is reactivated in the following situations:

- If the vehicle speed drops below the stored speed.
- If the stored speed is called up.
- If you store a new speed.

Operating cruise control or the variable limiter

 **WARNING** Risk of accident due to stored speed

If you call up the stored speed and this is lower than your current speed, the vehicle decelerates.

 Take into account the traffic situation before calling up the stored speed.

Requirements

Cruise control

- Cruise control is selected.
- ESP[®] must be activated, but not intervening.

- The vehicle speed is at least 20 km/h.
- The transmission is in position **D**.

Variable limiter

- The variable limiter is selected.

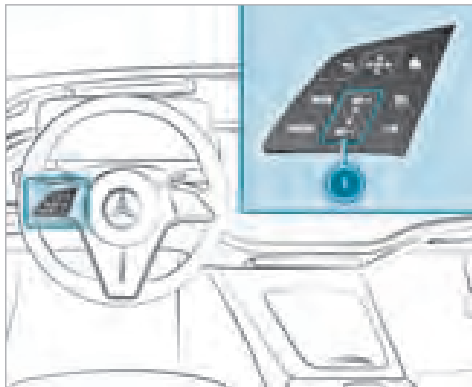

Steering wheel control panel for cruise control and variable limiter

- RES/Ⓢ** Adopts the stored/detected speed
- CANCEL** Deactivates cruise control/the variable limiter
- Selects cruise control
- LIM** Selects the variable limiter
- Control panel to increase/decrease speed

Operating cruise control and the variable limiter

- ▶ Press the corresponding button with only one finger or swipe on the control panel.

Switching between cruise control and the variable limiter

- ▶ To select cruise control: press .
- ▶ To select the variable limiter: press **LIM**.

Vehicles with Active Distance Assist DISTRONIC: the variable limiter is selected by a different button (→ page 231).

Activating cruise control or the variable limiter

- ▶ Press **SET/+** or **SET/-** on control panel . The current vehicle speed is stored and the vehicle maintains this speed (cruise control) or does not exceed it (variable limiter).

or

- ▶ Press **RES/Ⓢ**. The last stored speed is called up and the vehicle maintains this speed (cruise control) or does not exceed it (variable limiter).

If the last stored speed has previously been deleted, the current vehicle speed is stored.

- i** When you switch off the vehicle, the last speed stored is deleted.
When you activate cruise control or Active Distance Assist DISTRONIC, the last speed stored for the variable limiter is deleted.

Increasing/decreasing the stored speed

- ▶ To increase the stored speed: swipe upwards from the bottom of control panel **1**.
 - The stored speed is increased by 1 km/h.
- ▶ To decrease the stored speed: swipe downwards from the top of control panel **1**.
 - The stored speed is decreased by 1 km/h.

or

- ▶ Briefly press **SET/+** or **SET/-** on control panel **1**.
The stored speed is increased or decreased to the next increment of ten (e.g. to 50 km/h or 60 km/h).

or

- ▶ Press and hold **SET/+** or **SET/-** on control panel **1**.
The stored speed is increased or decreased to the next increment of ten and afterwards by increments of 10 km/h.

or

- ▶ Accelerate the vehicle to the desired speed.
- ▶ Press **SET/+** on control panel **1**.
- i** When the variable limiter is switched to passive mode, you cannot increase or decrease its stored speed in increments of 1 km/h.

Adopting a detected speed

If cruise control/variable limiter is activated and Traffic Sign Assist has detected a speed restriction sign with a maximum permissible speed and this is displayed in the driver's display:

- ▶ Press **RES/Ⓞ**.
The maximum permissible speed shown by the traffic sign is stored and the vehicle maintains or does not exceed this speed.

Deactivating cruise control or the variable limiter

- ▶ Press **CANCEL**.

- i** If you brake, deactivate ESP® or if ESP® intervenes, cruise control is deactivated. The variable limiter is not deactivated.
- i** When you switch off the vehicle, the last speed stored is deleted.
When you select cruise control or Active Distance Assist DISTRONIC, the last speed stored for the variable limiter is cleared.

Information on the permanent limiter

If the vehicle should never exceed a specific speed (e.g. for driving in winter tyre mode), you can set this speed with the permanent limiter.

You do this by limiting the speed between 160 km/h and 240 km/h in the multimedia system (→ page 228).

Shortly before the set speed is reached, it appears in the driver's display. When you confirm the message, display messages no longer appear until you switch off the vehicle. The speed will only be displayed again once the vehicle has been restarted or if the set speed is changed.

The permanent limiter does not switch to passive mode even during kickdown and the driven speed remains below the set speed.

Setting the speed limit for winter tyres

Multimedia system:

→  ► Settings ► Vehicle

►► Winter tyre limit

► Activate or deactivate **Winter tyre limit**.

Setting a speed

► Select **Winter tyre limit**.

► Select a speed.

Active Distance Assist DISTRONIC

Function of Active Distance Assist DISTRONIC

 The Active Distance Assist DISTRONIC described for vehicles without the Driving Assistance package is an on-demand feature (→ page 25).

DISTRONIC Active Distance Assist maintains the set speed when driving freely. If vehicles are detected ahead, the set distance is maintained, if necessary until the vehicle comes to a standstill. The vehicle accelerates or brakes depending on the distance to the vehicle in front and the set

speed. The speed and distance to the vehicle in front are set and saved using the steering wheel.

Available speed range:

- **Vehicles without Driving Assistance Package:**
20 km/h - 160 km/h
- **Vehicles with Driving Assistance Package:**
20 km/h - 210 km/h

 The adjustable set speed may differ if a limit speed (e.g. winter tyre limit) (→ page 227) is stored.

Other features of Active Distance Assist DISTRONIC:

- Adjusts the driving style depending on the selected drive program (energy-saving, comfortable or dynamic) (→ page 194)
- Initiates acceleration to the stored speed if the turn signal indicator is switched on to change to the overtaking lane
- **Vehicles with Driving Assistance Package:**
 - Reacts to stationary vehicles detected in urban speed ranges (except bicycles and motorcycles)

- Takes one-sided overtaking restrictions into account on motorways or on multi-lane roads with separate carriageways (country-dependent)

 In the DYNAMIC SELECT menu, it is possible to set the driving mode of the Active Distance Assist DISTRONIC. Depending on which drive program is selected, the driving characteristics can be geared towards energy economy, comfort or dynamic performance. In the Active Distance Assist menu, the driving style can be permanently set to Comfort or Dynamic (→ page 236).

Vehicles with Active Parking Assist and Driving Assistance Package: if Active Distance Assist DISTRONIC has braked the vehicle to a standstill, it can automatically follow the vehicle in front when driving off again within 30 seconds. If a critical situation is detected in the surrounding area when driving off, such as a person in the vehicle path, a visual and acoustic warning is given indicating that the driver must now take control of the vehicle. The vehicle is not accelerated any further.

Observe the notes on driving systems and your responsibility; you may otherwise fail to recognise dangers (→ page 215).

Display in the driver's display in the **Assistance** menu



- ① Vehicle in front
- ② Distance indicator
- ③ Set specified distance

Vehicle detected in front ① is highlighted in green. It may also be in the lane to the left of your vehicle in situations where it is not permitted to overtake on the right, for example on motorways.

Permanent status display

- (grey): Active Distance Assist DISTRONIC selected but not yet active
- (green speedometer, grey vehicle): Active Distance Assist DISTRONIC active, speed set
- (green): Active Distance Assist DISTRONIC active and vehicle detected

The stored speed is shown under the permanent status display and highlighted on the speedometer. When Active Distance Assist DISTRONIC is passive, the status display is greyed out.

If the speed of the vehicle in front or the speed adjustment is less than the stored speed due to the route event ahead, the segments in the speedometer light up.

If you increase or decrease the set specified distance, the display briefly shows .

- ① On motorways or high-speed major roads, the green vehicle symbol is displayed cyclically when the vehicle is ready to pull away.
- ① If you depress the accelerator pedal beyond the setting of the Active Distance Assist

DISTRONIC, the system is switched to passive mode. The following message appears briefly in the driver's display **suspended**.

System limits

The system may be impaired or may not function in the following situations, for example:

- In snow, rain, fog, heavy spray, if there is glare, in direct sunlight or in greatly varying light conditions.
- The windscreen in the area of the camera is dirty, misted up, damaged or covered.
- If the radar sensors are dirty or covered.
- In multi-storey car parks or on roads with steep uphill or downhill gradients.
- If there are narrow vehicles in front, such as bicycles or motorcycles.

In addition, on slippery roads, braking or accelerating can cause one or several wheels to lose traction and the vehicle could then skid.

Do not use Active Distance Assist DISTRONIC in these situations.

⚠ WARNING Risk of accident from acceleration or braking by Active Distance Assist DISTRONIC

Active Distance Assist DISTRONIC may accelerate or brake in the following cases, for example:

- If the vehicle pulls away using Active Distance Assist DISTRONIC.
- If the stored speed is called up and is considerably faster or slower than the currently driven speed.
- If Active Distance Assist DISTRONIC no longer detects a vehicle in front or does not react to relevant objects.

- ▶ Always carefully observe the traffic conditions and be ready to brake at all times.
- ▶ Take into account the traffic situation before calling up the stored speed.

⚠ WARNING Risk of accident due to insufficient deceleration by Active Distance Assist DISTRONIC

Active Distance Assist DISTRONIC brakes your vehicle with up to 50% of the possible deceleration. If this deceleration is not sufficient, Active Distance Assist DISTRONIC alerts you with a visual and acoustic warning.

- ▶ Adjust your speed and maintain a suitable distance from the vehicle in front.
- ▶ Brake the vehicle yourself and/or take evasive action.

⚠ WARNING Risk of accident if detection function of Active Distance Assist DISTRONIC is impaired

Active Distance Assist DISTRONIC does not react or has a limited reaction:

- when driving on a different lane or when changing lanes

- to pedestrians, animals, bicycles or stationary vehicles, or unexpected obstacles
- to complex traffic conditions
- to oncoming vehicles and crossing traffic

As a result, Active Distance Assist DISTRONIC may neither give warnings nor intervene in such situations.

- ▶ Always observe the traffic conditions carefully and react accordingly.

You can watch an animation on this topic via the following link:

Operating Active Distance Assist DISTRONIC and the variable limiter

⚠ WARNING Risk of accident if detection function of Active Distance Assist DISTRONIC is impaired

Active Distance Assist DISTRONIC does not react or has a limited reaction:

- when driving on a different lane or when changing lanes
- to pedestrians, animals, bicycles or stationary vehicles, or unexpected obstacles
- to complex traffic conditions
- to oncoming vehicles and crossing traffic

As a result, Active Distance Assist DISTRONIC may neither give warnings nor intervene in such situations.

- ▶ Always observe the traffic conditions carefully and react accordingly.

⚠ WARNING Risk of accident from acceleration or braking by Active Distance Assist DISTRONIC

Active Distance Assist DISTRONIC may accelerate or brake in the following cases, for example:

- If the vehicle pulls away using Active Distance Assist DISTRONIC.
 - If the stored speed is called up and is considerably faster or slower than the currently driven speed.
 - If Active Distance Assist DISTRONIC no longer detects a vehicle in front or does not react to relevant objects.
- ▶ Always carefully observe the traffic conditions and be ready to brake at all times.
 - ▶ Take into account the traffic situation before calling up the stored speed.

⚠ WARNING Risk of accident due to insufficient deceleration by Active Distance Assist DISTRONIC

Active Distance Assist DISTRONIC brakes your vehicle with up to 50% of the possible deceleration. If this deceleration is not sufficient, Active Distance Assist DISTRONIC alerts you with a visual and acoustic warning.

- ▶ Adjust your speed and maintain a suitable distance from the vehicle in front.
- ▶ Brake the vehicle yourself and/or take evasive action.

⚠ WARNING Risk of accident due to Active Speed Limit Assist adapting the vehicle's speed

The speed adopted by Active Speed Limit Assist may be too high or incorrect in some individual cases, such as:

- at speed limits below 20 km/h
- in wet conditions or in fog

- when towing a trailer
- ▶ Ensure that the driven speed complies with traffic regulations.
- ▶ Adjust the driving speed to suit current traffic and weather conditions.

Requirements

Active Distance Assist DISTRONIC:

- The electric parking brake is released.
- ESP® is activated and is not intervening.
- The transmission is in position **D**.
- All the doors are closed.
- Check of the radar sensor system has been successfully completed.
- Snow chain mode is not active (→ page 510).

Variable limiter:

- The variable limiter is selected.

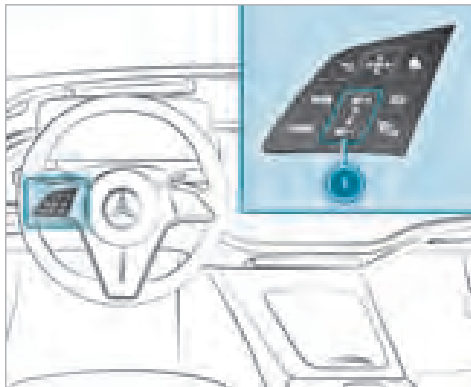

- RES/+** Adopts the stored/detected speed
- CANCEL** Deactivates Active Distance Assist DISTRONIC/ the variable limiter
- 1** Increases/decreases the speed
- ↔** Increases/decreases the specified distance
- LIM** Switches between the variable limiter and Active Distance Assist DISTRONIC

- ▶ To operate **Active Distance Assist DISTRONIC** or the **variable limiter**: press the respective button with only one finger or swipe on the control panel.

Switches between the variable limiter and Active Distance Assist DISTRONIC

- ▶ Press **LIM**.

Activating the variable limiter or Active Distance Assist DISTRONIC

- ▶ To activate **without a stored speed**: press **SET/+**, **SET/-** or **RES/0**. **Active Distance Assist DISTRONIC**: remove your foot from the accelerator pedal. The current vehicle speed is stored and maintained (Active Distance Assist DISTRONIC) or limited (variable limiter) by the vehicle.

or



- ▶ To activate **with a stored speed**: press **RES/0**. **Active Distance Assist DISTRONIC**: remove your foot from the accelerator pedal. The last stored speed is called up and the vehicle maintains this speed (Active Distance

Assist DISTRONIC) or does not exceed it (variable limiter).



If the stored speed has been deleted, the current vehicle speed is stored.

-  When you switch off the vehicle, the stored speed is deleted. When you activate Active Distance Assist DISTRONIC, the last speed stored for the variable limiter is deleted.



Increasing or reducing the speed

- ▶ To increase the stored speed: swipe upwards from the bottom of control panel .
 - The stored speed is increased by 1 km/h.
- ▶ To decrease the stored speed: swipe downwards from the top of control panel .
 - The stored speed is decreased by 1 km/h.



or

- ▶ Briefly press  on the upper section or  on the lower section of control panel . The stored speed is increased or reduced by 10 km/h.





or

- ▶ Press and hold  on the upper section or  on the lower section of control panel . The stored speed is increased or reduced in increments of 10 km/h.

or

- ▶ Accelerate the vehicle to the desired speed.
- ▶ Press  on the upper section of control panel .

Adopting the limit speed shown in the driver's display

- ▶ Activate Active Distance Assist DISTRONIC or the variable limiter: press ,  or .
- ▶ Accept the displayed speed limit: press . The limit speed displayed in the driver's display is adopted as the stored speed. The vehicle adapts its speed to that of the vehicle in front, but only up to the stored speed, or limits its speed accordingly.

-  A speed limit shown in the driver display is only adopted while driving, not when stationary.



Pulling away with Active Distance Assist DISTRONIC

- ▶ Activate Active Distance Assist DISTRONIC and remove your foot from the brake pedal.
- ▶ Press .

or

- ▶ Depress the accelerator pedal briefly and firmly. The functions of Active Distance Assist DISTRONIC continue to be carried out.

Reducing or increasing the specified distance from the vehicle in front

- ▶ Press . The  display appears. The specified distance is reduced by one level. If the lowest level is already selected, the selection jumps to the highest level.

Deactivating Active Distance Assist DISTRONIC or the variable limiter

⚠ WARNING Risk of an accident due to Active Distance Assist DISTRONIC being active when you leave the driver's seat

If you leave the driver's seat while the vehicle is being braked by Active Distance Assist DISTRONIC only, the vehicle can roll away.

▶ Always deactivate Active Distance Assist DISTRONIC and secure the vehicle to prevent it from rolling away before you leave the driver's seat.

▶ Press **CANCEL**.

ⓘ If you brake, deactivate ESP® or if ESP® intervenes, Active Distance Assist DISTRONIC is deactivated. The variable limiter is not deactivated.

Function of Active Speed Limit Assist

If a changed speed limit is detected and the automatic adoption of speed limits is switched on, this is automatically adopted as the stored speed

(→ page 236). Speed limits below 20 km/h are not accepted.

The driven speed is adjusted when the vehicle is level with the traffic sign at the latest. In the case of signs indicating entry into an urban area, the speed is adapted according to the speed permitted within the urban area. The speed limit display in the driver's display is always updated when the vehicle is level with the traffic sign.

If you are driving on German motorways and there is no speed limit, the system uses the speed stored for a stretch of road with no speed limit as the set speed. If you do not alter the stored speed on a stretch of road with no speed limit, the recommended speed of 130 km/h is adopted.

If Active Distance Assist DISTRONIC has been put into passive mode by pressing the accelerator pedal, only speed limits which are higher than the set speed are adopted.

The maximum permissible speed does not take the road condition and current weather and traffic conditions into account. Adjust your speed accordingly, when necessary.

Observe the notes on driving systems and your responsibility; you may otherwise fail to recognise dangers (→ page 215).

System limits

The system limits of Traffic Sign Assist apply to the detection of traffic signs (→ page 250).

Speed limits below 20 km/h are not automatically adopted by the system as the stored speed. Temporary speed restrictions (e.g. for a certain time or due to weather conditions) cannot be properly detected by the system.

The maximum permissible speed applying to a vehicle with a trailer is not detected by the system.

Adjust the speed in these situations.

⚠ WARNING Risk of accident due to Active Speed Limit Assist adapting the vehicle's speed

The speed adopted by Active Speed Limit Assist may be too high or incorrect in some individual cases, such as:

- at speed limits below 20 km/h
- in wet conditions or in fog
- when towing a trailer

- ▶ Ensure that the driven speed complies with traffic regulations.
- ▶ Adjust the driving speed to suit current traffic and weather conditions.

■ Function of route-based speed adaptation

When Active Distance Assist DISTRONIC is activated, the vehicle speed will be adapted accordingly to the route events ahead. Depending on the drive program selected, the vehicle negotiates a route event ahead in an energy-saving, comfortable or dynamic manner. When the route event has been passed, the vehicle accelerates again to the stored speed. The set distance to the vehicle in front, vehicles detected ahead and speed restrictions ahead are taken into account.

Route-based speed adaptation can be activated in the multimedia system (→ page 236).

The following route events are taken into account:

- Bends

- Roundabouts
- T-junctions
- Turns and exits
- Traffic jams ahead (only with Live Traffic (→ page 396))

Also, the speed is reduced if the turn signal indicator is switched on and one of the following situations is detected:

- Turning at junctions
- Driving on slowing-down lanes
- Driving on lanes adjacent to slowing-down lanes

The driver is responsible for choosing the right speed and observing other road users. This applies in particular to junctions, roundabouts and traffic lights, as route-based speed adaptation does not brake the vehicle to a standstill.

Speed adaptation is cancelled in the following cases:

- If the turn signal indicator is switched off before the route event and it is therefore

assumed that the route event is not relevant to the driver.

- If the driver depresses the accelerator or brake pedal during the process.

System limits

Route-based speed adaptation does not take right of way regulations into account. The driver is responsible for complying with road traffic regulations and driving at a suitable speed.

In difficult conditions, the speed selection made by the system may not always be suitable. This applies to the following situations, foreexample:

- the road's course not clearly visible
- Road narrowing
- varying maximum permissible speeds in individual lanes, foreexample at toll stations
- wet road surfaces, snow or ice
- If transport equipment, foreexample a trailer or bicycle rack, is attached to the trailer hitch and the electrical connection has been correctly established.

In these situations the driver must intervene accordingly.

⚠ WARNING Risk of accident in spite of route-based speed adaptation

Route-based speed adaptation can malfunction or be temporarily unavailable in the following situations:

- If the driver does not follow the calculated route
 - If map data is not up-to-date or available
 - In the event of roadworks
 - In bad weather or road conditions
 - If the accelerator pedal is depressed
 - In the event of electronically displayed speed limitations
- ▶ Adapt the speed to the traffic situation.

■ Setting Active Distance Assist DISTRONIC driving styles

Requirements:

- Active Distance Assist DISTRONIC is activated.

Multimedia system:

↩️ 🏠 ▶▶ Settings ▶▶ Assistance
▶▶ Driving ▶▶ Active Distance Assist

Selecting a driving style

▶ Select **Based on DYNAMIC SELECT**, **Dynamic** or **Comfortable**.

ⓘ Further information about Active Distance Assist DISTRONIC (→ page 231).

Setting speed adaptation

▶ Select **Route based** or **Speed limit**.
When these functions are active, the vehicle speed is adjusted depending on the route events ahead.

ⓘ When one of the following systems is active, the detected speed can be manually adopted as the speed limit:

- Active Distance Assist DISTRONIC
- Cruise control
- Variable limiter

ⓘ Further information on speed adaptation (→ page 235).

■ Function of Active Stop-and-Go Assist

Active Stop-and-Go Assist helps you when in traffic jams on multi-lane roads with separate carriageways by automatically pulling away within up to 60 seconds and with moderate steering manoeuvres. It orients itself using the vehicle in front and lane markings. Active Stop-and-Go Assist automatically maintains a safe distance from the vehicle in front and vehicles cutting in.

Active Stop-and-Go Assist requires you, as the driver, to keep your hands on the steering wheel at all times so that you are able to intervene at any time to correct the course of the vehicle and keep it in lane.

Observe the notes on driving systems and your responsibility; you may otherwise fail to recognise dangers (→ page 215).

Active Stop-and-Go Assist activates automatically when all of the following conditions are met:

- You are in a traffic jam on a motorway or high-speed major road.
- Active Distance Assist DISTRONIC is activated and active (→ page 231).
- Active Steering Assist is activated and active (→ page 239).
- You are travelling no faster than 60 km/h.

When Active Stop-and-Go Assist is active the  status display appears in the driver's display.

System limits

The system limitations of Active Distance Assist DISTRONIC and Active Steering Assist apply to Active Stop-and-Go Assist (→ page 237).

Active Steering Assist

Function of Active Steering Assist

Active Steering Assist is only available up to a speed of 210 km/h. The system helps you to stay in the centre of the lane by means of moderate steering interventions. Depending on the speed driven, Active Steering Assist uses the vehicles ahead and lane markings as a reference.

- ⓘ Depending on the country, in the lower speed range Active Steering Assist can use the surrounding traffic as a reference. If necessary, Active Steering Assist can then also provide assistance when driving outside the centre of the lane.

If the detection of lane markings and vehicles ahead is impaired, Active Steering Assist switches to passive mode. The system provides no support in this case.

Permanent status display in the driver's display



Grey: activated and passive





Green: activated and active



Red, flashing: prompt to the driver to actively confirm or transition from active to passive status, system limit detected



- ⓘ During the transition from active to passive status, the  symbol is shown as enlarged and flashing. Once the system is passive, the  symbol is shown as grey in the driver's display.

Contact detection

The driver is required to keep their hands on the steering wheel at all times and be able to intervene at any time to correct the course of the vehicle and keep it in lane. The driver must expect a change from active to passive mode or vice versa at any time.



If the system detects that the driver has not steered the vehicle for a considerable period of time or has removed their hands from the steering wheel, an optical warning is given first. Display ① appears in the driver's display. If the driver still does not steer the vehicle, or gives no confirmation to the system, a warning tone sounds in addition to the visual warning message.

If the driver does not react to this warning for a considerable period, an emergency stop is initiated (→ page 239).

The warning is not issued or is stopped as soon as the system detects that the driver has touched the steering wheel.

The touch detection may be limited or without function if there is no direct contact between the hand and the steering wheel, e.g. when wearing gloves or if there is a steering wheel cover on the steering wheel.

If Active Steering Assist detects that a system limit has been reached, a visual warning is issued and a warning tone sounds.

Observe the notes on driving systems and your responsibility; you may otherwise fail to recognise dangers (→ page 215).

System limits

Active Steering Assist has a limited steering torque for lateral guidance. In some cases, the steering intervention is not sufficient to keep the vehicle in the lane.

The system may be impaired or may not function in the following instances:

- There is poor visibility, e.g. due to snow, rain, fog, heavy spray, greatly varying light conditions or strong shadows on the carriageway.
- There is glare, e.g. from oncoming traffic, direct sunlight or reflections.

- Insufficient road illumination.
- The windscreen is dirty, misted up, damaged or covered in the vicinity of the camera, e.g. by a sticker.
- No, or several, unclear lane markings are present for one lane, or the markings change quickly, for example, in a construction area or junctions.
- The lane markings are worn away, dark or covered up, e.g. by dirt or snow.
- If the distance to the vehicle in front is too short and thus the lane markings cannot be detected.
- The road is narrow and winding.
- There are obstacles on the lane or projecting out into the lane, such as object markers.
- If transport equipment, for example a trailer or bicycle rack, is attached to the trailer hitch and the electrical connection has been correctly established.

The system does not provide assistance in the following conditions:

- On very tight bends and when turning.

- When crossing junctions.
- At roundabouts or toll stations.
- When actively changing lane without switching on the turn signal indicator.
- When the tyre pressure is too low.

⚠ WARNING Risk of accident if Active Steering Assist unexpectedly stops functioning

If the system limits of Active Steering Assist are reached there is no guarantee that the system will remain active or will keep the vehicle in lane.

- ▶ Always keep your hands on the steering wheel and observe the traffic carefully.
- ▶ Always steer the vehicle paying attention to traffic conditions.

⚠ WARNING Risk of accident if Active Steering Assist unexpectedly intervenes

The detection of lane markings and objects may malfunction and cause unexpected steering interventions.

▶ Steer according to traffic conditions.

You can watch an animation on this topic via the following link:

■ [Activating/deactivating Active Steering Assist](#)

Requirements

- ESP[®] is activated, but is not intervening.
- Active Distance Assist DISTRONIC is activated.

Multimedia system:

➔  ➔ [Settings](#) ➔ [Assistance](#)

➔ [Driving](#)

▶ Activate or deactivate [Active Steering Assist](#).

[Function of Active Emergency Stop Assist](#)

Active Emergency Stop Assist monitors the steering wheel and the accelerator and brake pedals. If the system detects a lack of driver activity and the vehicle threatens to leave the lane, a warning can be issued and an emergency stop initiated.

Vehicles without Driving Assistance Package: The system is available from a speed of approx. 60 km/h.

Vehicles with Driving Assistance package: If Active Steering Assist is switched off, the system is available from a speed of approx. 60 km/h.

If the system detects that the vehicle is threatening to leave the lane, a warning can be issued and an emergency stop initiated.

- The driver does not touch the steering wheel for a longer period of time or no steering movement can be measured for a longer period of time (depending on the vehicle equipment).
- Neither the accelerator nor the brake pedal is depressed.

i Vehicles with Driving Assistance package: if Active Steering Assist is switched on and active, only the steering wheel is monitored by the system. If the driver does not touch the steering wheel for a longer period of time, a warning may be given despite pedal actuation.

Also observe the instructions on the contact detection of Active Steering Assist (→ page 237).



Active Emergency Stop Assist issues the following warnings in order:

- Display message **1** appears in the driver's display.
- In addition to display **1** a warning tone sounds.
- The message **Beginning emergency stop** will appear in the driver's display, a continuous warning tone will sound, the vehicle will no longer accelerate and, if necessary, slight belt tensioning will be produced.

- The vehicle speed is reduced in increments until it is at a standstill. Sharp brake impulses are also produced.

i Vehicles with Driving Assistance Package: If Active Distance Assist DISTRONIC is active and the driver unfastens the seat belt and driver's door, an emergency stop can be initiated immediately.

Vehicles with Driving Assistance Package:

Depending on the country, a lane change to the adjacent lane is carried out, if possible. It is only possible to change across one lane and only into the outer lane, not onto the hard shoulder.

When automatic braking is initiated, Active Distance Assist DISTRONIC is deactivated. Depending on the country, the hazard warning light system is switched on.

When the vehicle is stationary, the following actions are carried out:

- The vehicle is secured with the electric parking brake.
- The vehicle is unlocked.

- If possible, an emergency call is placed to the Mercedes-Benz emergency call centre.

Before automatic braking is initiated, you can cancel Active Emergency Stop Assist by steering.

You can cancel the intervention by Active Emergency Stop Assist after automatic braking is initiated by one of the following actions:

- Accelerating or braking: the emergency stop is cancelled, but the warning message, warning tone and power steering remain active
- Steering: power-assisted steering is cancelled, the warning message and warning tone remain active and the vehicle continues to be braked

i Active Emergency Stop Assist can initiate an emergency stop a maximum of three times within a driving cycle. After that, Active Steering Assist and Active Emergency Stop Assist are disabled until the vehicle has been restarted.

System limits

For the detection of vehicles and other obstacles, observe the system limits of the following functions:

- Active Distance Assist DISTRONIC (→ page 228)
- Active Steering Assist (→ page 237)
- Active Lane Change Assist (→ page 241)
- Active Brake Assist (→ page 243)

Active Lane Change Assist

Function of Active Lane Change Assist

Active Lane Change Assist supports the driver when changing lanes and is activated by indicating briefly.

For this, the following conditions must be fulfilled:

- You are on a motorway or high-speed major road.
- The vehicle speed is between approximately 80 km/h and 180 km/h.
- The neighbouring lane is separated by a broken lane marking.

- No vehicle or obstacle is detected in the adjacent lane.
- Since the last time the vehicle was started, the sensors have detected a vehicle at a suitable distance behind your vehicle.
- Active Lane Change Assist is selected in the multimedia system.
- Active Distance Assist DISTRONIC and Active Steering Assist are activated on motorways.

The system is not available and must be reactivated in the following situations:

- Active Distance Assist DISTRONIC and Active Steering Assist were already activated before entering the motorway.
- The system briefly does not detect the road you are on as a motorway or a motorway-like road, e.g. on a motorway junction.



As soon as Active Lane Change Assist detects a suitable road, you can reactivate it with **RES/Ⓢ**, **SET/+** or **SET/-**.

Display in the driver's display in the Assistance menu





① Green arrow: lane change initiated

② Red arrow: lane change cancelled

When Active Lane Change Assist is available, the  display appears along with green arrows in the driver's display. If the system has been activated but is not currently available, the  display

appears along with grey arrows in the driver's display.

If no vehicle or obstacle is detected in the adjacent lane and a lane change is permitted, the lane change begins after the driver has indicated briefly. The lane change is shown to the driver with a flashing green arrow next to the  steering wheel symbol. Green arrow Assistance is displayed in the appropriate adjacent lane in the  menu in the driver's display. The message, for [Lane change to the left](#) example, also appears.

Active Lane Change Assist can be cancelled in various situations, including the following:

- Change in the surrounding conditions (e.g. detected obstacle).
- The driver removes their hands from the steering wheel.
- The driver steers with too much force or in the opposite direction.
- The driver moves the turn signal indicator in the opposite direction.
- Active Distance Assist DISTRONIC or Active Steering Assist is deactivated.

- The vehicle cannot make the lane change as planned.

Cancellation of Active Lane Change Assist is displayed as follows:

- The arrow in the selected direction of travel turns red.
- A corresponding message will also appear in the driver's display.
- In certain circumstances a warning tone sounds.

 **WARNING** Risk of accident when changing lane to an occupied adjacent lane

Lane Change Assist cannot always clearly detect if the adjacent lane is free.

The lane change might be initiated although the adjacent lane is not free.

- ▶ Before changing lanes, make sure that the neighbouring lane is free and there is no danger to other road users.
- ▶ Monitor the lane change.

 **WARNING** Risk of accident if Lane Change Assist unexpectedly stops functioning

If the system limitations for Lane Change Assist have been reached, there is no guarantee that the system will remain active.

Lane Change Assist cannot then assist you by applying steering torque.

- ▶ Always monitor the lane change and keep your hands on the steering wheel. Observe the traffic conditions and steer and/or brake if necessary.

System limits

The system limitations of Active Steering Assist apply to Active Lane Change Assist (→ page 237).

The system may also be impaired or may not function in the following situations:

- The sensors are damaged, covered or dirty (→ page 215).
- The exterior lighting shows a defect.

- The system does not detect a suitable road, for example, in tight bends or shortly after a slip road.
 - The vehicle is on a construction site.
- i** The Active Lane Change Assist sensors adjust automatically while a certain distance is being driven after the vehicle has been delivered. Active Lane Change Assist is unavailable or only partially available during this teach-in process, and no arrows are displayed next to the  Active Steering Assist symbol.

Observe the notes on driving systems and your responsibility; you may otherwise fail to recognise dangers (→ page 215).

■ Setting Active Lane Change Assist

Multimedia system:

→  **▶▶ Settings ▶▶ Assistance**
▶▶ Driving

- ▶ Select **Active Lane Change Assist**.
- ▶ Select between the **On**, **Also automatic** or **Off** setting options.

Active Brake Assist

■ Function of Active Brake Assist

Active Brake Assist consists of the following functions:

- Distance warning function
- Collision warning
- Autonomous braking function
- Situation-dependent brake force boosting
- Cornering Assist
- **Vehicles with Driving Assistance Package:** Evasive Steering Assist and intersection start-off function

Active Brake Assist can help you to minimise the risk of a collision with vehicles, cyclists or pedestrians or to reduce the effects of such a collision.

If Active Brake Assist has detected a risk of collision, a warning tone sounds and the  distance warning lamp lights up.

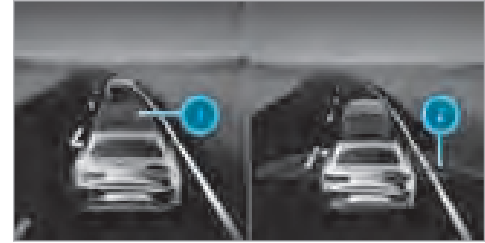

In the **Assistance** menu, an insufficient distance **①** to the vehicle in front is displayed in red. If you further reduce the distance, the vehicle in front is also highlighted in red. When the system detects a risk of collision, red radar waves **②** appear in front of the vehicle.

- i** **Vehicles with PRE-SAFE®:** depending on the country, an additional haptic warning occurs in the form of slight, repeated tensioning of the seat belt.
- i** **Vehicles with active ambient lighting:** if **Warning assistance** is activated, the Active Brake Assist warning is also accompanied by ambient lighting (→ page 160).

If you do not react to the warning, autonomous braking can be initiated in critical situations.

In particularly critical situations, Active Brake Assist can also initiate autonomous braking directly. In this case, the warning tone is sounded and the  distance warning lamp lights up simultaneously with the brake application.

If you apply the brake yourself in a critical situation or apply the brake during autonomous braking, situation-dependent brake force boosting occurs. The brake pressure increases up to maximum full-stop braking if necessary.



If autonomous braking or situation-dependent brake force boosting has occurred, pop up 

appears in the driver's display and then automatically goes out after a short time.

If the autonomous braking function or situation-dependent brake force boosting is triggered, additional preventive measures for occupant protection (PRE-SAFE®) may also be initiated.

⚠ WARNING Risk of an accident caused by limited detection performance of Active Brake Assist

Active Brake Assist cannot always clearly identify objects and complex traffic situations.

In such cases, Active Brake Assist might:

- Give a warning or brake without reason
- Not give a warning or not brake

Active Brake Assist is only an aid. The driver is responsible for maintaining a sufficiently safe distance to the vehicle in front, vehicle speed and for braking in good time.

▶ Always pay careful attention to the traffic situation; do not rely on Active Brake Assist alone.

▶ Be prepared to brake or swerve if necessary.

If Active Brake Assist is deactivated or the functions are restricted, e.g. due to activation of another driving system, the  Active Brake Assist warning lamp appears in the driver's display.

If the system is unavailable due to dirty or damaged sensors or due to a fault, or if the functions are restricted, the  Active Brake Assist warning lamp appears in the driver's display.

Also observe the system limits of Active Brake Assist.

The individual subfunctions are available in the following speed ranges:

Distance warning function

You are warned by the distance warning function from approximately 30 km/h if, over several seconds, the distance maintained to the vehicle travelling in front is insufficient for the driven speed. In this case, the  distance warning lamp in the driver's display lights up. If the distance to the vehicle in front continues to decrease at higher

speeds, the  distance warning lamp begins to flash.

Collision warning

Collision warning can assist you in the following situations from approximately 7 km/h with an intermittent warning tone and the  distance warning lamp.

Vehicles without Driving Assistance Package:

- at speeds up to approximately 250 km/h when approaching vehicles ahead
- at speeds up to approximately 80 km/h when approaching stationary vehicles, pedestrians walking in the direction of travel and cyclists ahead
- at speeds up to approximately 70 km/h when approaching crossing pedestrians and cyclists
- at speeds up to approximately 60 km/h when approaching stationary pedestrians and cyclists

Vehicles with Driving Assistance Package:

- at speeds up to approximately 250 km/h when approaching vehicles ahead

- at speeds up to approximately 120 km/h when approaching crossing vehicles, pedestrians and cyclists
- at speeds up to approximately 100 km/h when approaching stationary vehicles
- at speeds up to approximately 80 km/h when approaching cyclists ahead
- at speeds up to approximately 70 km/h when approaching stationary pedestrians and cyclists

Autonomous braking function

If the vehicle is travelling at speeds above approximately 7 km/h, the autonomous braking function may intervene in the following situations:

Vehicles without Driving Assistance Package:

- at speeds up to approximately 250 km/h when approaching vehicles ahead
- at speeds up to approximately 80 km/h when approaching cyclists ahead, pedestrians walking in the direction of travel and stationary vehicles
- at speeds up to approximately 70 km/h when approaching crossing pedestrians and cyclists

Vehicles with Driving Assistance Package:

- at speeds up to approximately 250 km/h when approaching vehicles ahead
- at speeds up to approximately 120 km/h when approaching crossing vehicles, pedestrians and cyclists
- at speeds up to approximately 100 km/h when approaching stationary vehicles
- at speeds up to approximately 80 km/h when approaching cyclists ahead
- at speeds up to approximately 70 km/h when approaching stationary pedestrians and cyclists

Situation-dependent brake force boosting

If the vehicle is travelling at speeds above approximately 7 km/h, situation-dependent brake force boosting may intervene in the following situations.

Vehicles without Driving Assistance Package:

- at speeds up to approximately 250 km/h when approaching vehicles ahead
- at speeds up to approximately 80 km/h when approaching cyclists ahead, pedestrians walk-

ing in the direction of travel and stationary vehicles

- at speeds up to approximately 70 km/h when approaching crossing pedestrians and cyclists
- at speeds up to approximately 60 km/h when approaching stationary pedestrians and cyclists

Vehicles with Driving Assistance Package:

- at speeds up to approximately 250 km/h when approaching vehicles ahead
- at speeds up to approximately 120 km/h when approaching crossing vehicles, pedestrians and cyclists
- at speeds up to approximately 100 km/h when approaching stationary vehicles
- at speeds up to approximately 80 km/h when approaching cyclists ahead
- at speeds up to approximately 70 km/h when approaching stationary pedestrians and cyclists

Cancelling a brake application of Active Brake Assist

You can cancel a brake application of Active Brake Assist at any time by:

- Fully depressing the accelerator pedal or with kickdown.
- Releasing the brake pedal.

Active Brake Assist may cancel the brake application when one of the following conditions is fulfilled:

- you manoeuvre to avoid the obstacle
- there is no longer a risk of collision
- an obstacle is no longer detected in front of your vehicle

Reaction to oncoming road users (only vehicles with Driving Assistance Package)

Active Brake Assist can also react to detected oncoming road users:

- Reaction up to speeds of approximately 100 km/h



- Warning for oncoming road users through acoustic warning and  distance warning lamp
- Autonomous braking application in order to reduce the severity of an accident

Cornering function

If the system detects a danger of collision from oncoming road users when turning across an oncoming lane, autonomous braking can be initiated at speeds of up to approx. 20 km/h.

Intersection start-off function (only vehicles with Driving Assistance Package)



If, when pulling away or driving at a walking pace, the risk of collision with other crossing vehicles is detected, three red arrows pointing in the direction of the crossing road user light up one by one along with the  distance warning lamp in the driver's display. If the situation is particularly critical, the arrows flash. A warning tone will also sound. If you do not react to the warning in critical situations, acceleration may be restricted or autonomous braking may be initiated. Autonomous braking can also prevent the vehicle from pulling away and hold it at a standstill. In particularly critical situations, Active Brake Assist can also initiate autonomous braking directly. In this case, the  distance warning lamp lights up and the warning tone is sounded simultaneously with the brake application.

If autonomous braking or situation-dependent brake force boosting has occurred, a pop up appears in the driver's display and then automatically goes out after a short time.

In the **Late** setting of Active Brake Assist, the purely visual warning level and the limitation of possible acceleration is deactivated. If the situation is particularly critical, a visual warning may

continue to be displayed, a warning tone may sound and autonomous braking may be initiated.

Evasive Steering Assist

 **WARNING** Risk of accident despite Evasive Steering Assist

Evasive Steering Assist cannot always recognise objects or complex traffic situations clearly.

Moreover, the steering support provided by Evasive Steering Assist is not sufficient to avoid a collision.

- ▶ Always pay careful attention to the traffic situation; do not rely on Evasive Steering Assist alone.
- ▶ Be prepared to brake or swerve if necessary.
- ▶ End the support by actively steering in non-critical situations.
- ▶ Drive at an appropriate speed if there are pedestrians close to the path of your vehicle.

Evasive Steering Assist has the following characteristics:

- Detection of pedestrians, cyclists and vehicles.
- Assistance through power-assisted steering if it detects a swerving manoeuvre.
- Activation by an abrupt steering movement during a swerving manoeuvre.
- Assistance during swerving and straightening of the vehicle.
- Reaction from a speed of approximately 20 km/h up to a speed of approximately 110 km/h.

The steering support of Evasive Steering Assist can be cancelled at any time by counter steering.

System limits

Full system performance is not available for a short time after switching on the vehicle or after driving off. As long as the functions are restricted, the  Active Brake Assist warning lamp can also be shown in the driver's display. Depending on the environmental conditions, it may take a

few minutes before full system performance is available.

The system may be impaired or may not function, particularly in the following situations:

- In snow, rain, fog, heavy spray, if there is glare, in direct sunlight or in greatly varying light conditions.
- If the sensors are dirty, misted up, damaged or covered. (→ page 215)
- If the sensors are impaired due to interference from other radar sources, e.g. strong radar reflections in multi-storey car parks.
- If a loss of tyre pressure or a defective tyre has been detected and displayed.
- In complex traffic situations where objects cannot always be clearly identified.
- If pedestrians, cyclists or vehicles move quickly into the sensor detection range.
- If road users are hidden by other objects or are located close to other objects.
- If the typical outline of a pedestrian or cyclist cannot be distinguished from the background.

- If a pedestrian or cyclist is not detected as such, e.g. due to special clothing or other objects.
- If the driver's seat belt is not fastened.
- On bends with a tight radius.

You can watch an animation on this topic via the following link:

■ Setting Active Brake Assist

Requirements:

- The vehicle is switched on.

Multimedia system:

→  » Settings » Assistance
» Collision avoidance

▶ Activate or deactivate the function.

- ① It is recommended that you always leave Active Brake Assist activated.

When Active Brake Assist is deactivated, the distance warning function, the collision warning, the autonomous braking function and Evasive Steering Assist are deactivated.

- ① If Active Brake Assist is deactivated, the  symbol appears in the status bar of the driver's display, and the system is reactivated the next time the vehicle is started.

Setting the time of the warnings

▶ Select  next to **Active Brake Assist**.

▶ Select **Early**, **Medium** or **Late**.

- ① If ATTENTION ASSIST has detected indications of fatigue or a microsleep, the system can issue a warning earlier than the set time (country-dependent). Further information about ATTENTION ASSIST (→ page 222).

Speed Limit Assist

■ Function of Speed Limit Assist

- ① Speed Limit Assist uses OpenStreetMap data, which is made available under the conditions of the Open Database License (ODbL). For more information, see: <https://www.osmfoundation.org/wiki/licence>.

Speed Limit Assist detects speed limits with a multifunction camera and shows them in the driv-

er's display and optionally in the head-up display. The camera also detects speed limits with a restriction indicated by an additional sign (e.g. when wet).

Observe the notes on driving systems and your responsibility to ensure that you can recognise any dangers (→ page 215).

Warning when the permissible maximum speed is exceeded

The system can warn you if you unintentionally exceed the permissible maximum speed. Depending on the country, you can set in the multimedia system by how much the permissible maximum speed may be exceeded before a warning is given. You can set whether the warning should be visual (by flashing the traffic sign in the driver display) or visual and acoustic. The selection of the type of warning is confirmed country-specifically by an indication in the driver display.

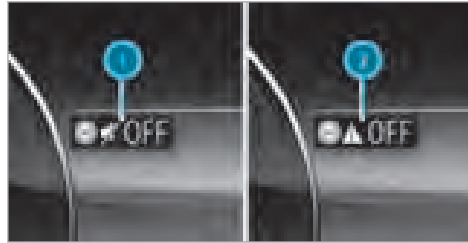

- ① Visual warning only
- ② Warning off
- ⓘ The type, duration and activation threshold of the speed warning, as well as the option of setting the activation threshold above which the warning is to be triggered, are subject to the legislation that is specific to the country in which the vehicle is delivered.

Display in the driver's display



- ① Permissible speed
- ② Permissible speed when there is a restriction
- ③ Additional sign with restriction
- ⓘ Traffic signs which have an impact on the permissible maximum speed, e.g. signs indicating the beginning or end of dual carriageways, can also be detected.

The system can show a maximum of two traffic signs in the driver's display simultaneously. The system always prioritises the display of speed limits. Up to one traffic sign with a permissible maximum speed can be shown in the head-up display.

If two speed signs are shown in the driver's display, for example when speed limits are detected, the value of left-hand speed limit  is transmitted to the limiter, cruise control or Active Distance Assist DISTRONIC for adoption and is shown in the head-up display.

If Speed Limit Assist cannot determine the current permissible maximum speed (e.g. if there is inadequate signage), the following display appears in the driver's display:



This is displayed continuously if the vehicle is in a country where Speed Limit Assist is not supported. Speed Limit Assist is not available in all countries.

If the system is temporarily or permanently unavailable due to a technical fault or dirt on the windscreen, a corresponding display message appears in the driver display. Depending on the country, the warning light  in the driver's display also lights up.

 Please also note the information on the display messages (→ page 644).

System limits

The system may be impaired or inoperative particularly in the following situations:

- If visibility is poor, e.g. due to insufficient illumination of the road, highly variable shade conditions, rain, snow, fog, swirling dust or heavy spray.
- If there is glare, e.g. from oncoming traffic, direct sunlight or reflections.
- If there is dirt on the windscreen in the vicinity of the multifunction camera or if the camera is misted up, damaged or obscured.
- If the traffic signs are difficult to see because, for example, they are dirty, obscured, faded, iced over, damaged, inconveniently positioned, insufficiently illuminated or distorted.
- Digital LED traffic signs may not be detected correctly or at all due to technical factors such as transmission frequency.
- If the signs, road markings or road layout are ambiguous, e.g. in the case of traffic signs in

construction sites, at exits and driveways, in the case of adjacent lanes or parallel roads, in the case of pedestrian crossing markings at traffic lights

- If the signage or road markings do not comply with the standard
- If the signage, road markings or road guidance is country-specific and deviates from the route guidance of the navigation system, e.g. in or after road works
- After sharp turns and tight bends, when traffic signs are outside the camera's field of vision.
- If you overtake vehicles with traffic signs which are affixed or attached to them.
- If you are using transport equipment secured with a trailer coupling, such as a bicycle rack, the system may react to restrictions for car/trailer combinations.

Traffic Sign Assist

Function of Traffic Sign Assist

-  This function is an on-demand feature (→ page 25).

The traffic sign assistant detects the traffic signs with the multifunction camera and compares them with the information on the digital road map of the navigation system. It assists you by displaying detected speed limits and overtaking restrictions in the driver's display and in the head-up display. The system can issue a warning when you exceed the maximum permissible speed.

The camera also detects and analyses traffic signs with a restriction indicated by an additional sign (e.g. when wet).

Traffic Sign Assist portrays only selected signs in the driver's display. Actual traffic signs and speed limits have priority over traffic signs and speed limits shown in the driver's display.

Also observe the following information:

- select a speed adapted to the traffic, surroundings and weather conditions
- observe actual traffic signs
- observe applicable traffic rules and regulations

Observe the notes on driving systems and your responsibility; you may otherwise fail to recognise dangers (→ page 215).

Displays in the driver's display

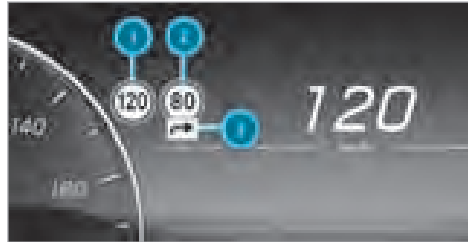

- ① Permissible speed
- ② Permissible speed when there is a restriction
- ③ Additional sign with restriction



Examples of traffic signs which can be displayed

Traffic Sign Assist can detect and display following traffic signs ①:

- speed limits
- end of the speed limit
- overtaking restrictions
- play streets
- depending on the country: signs showing the start or end of motorways and dual carriageways

Traffic Sign Assist can detect following additional signs ③ and, if necessary, analyse the relevance of the restrictions using other vehicle sensors:

- when wet
- slippery road surfaces
- in fog
- temporary restrictions
- exits
- restrictions for car/trailer combinations

Traffic Sign Assist also uses data from the digital street map in the navigation system. When you leave or enter a municipality or change roads, on a motorway exit or slip road for example, or after you turn at a junction, the display in the driver's display can thus be updated without a traffic sign having been detected.

- ① Regularly update the digital road map of the navigation system so that the traffic sign assistant can work optimally (→ page 404).

If Traffic Sign Assist cannot determine the currently applicable maximum permissible speed (e.g. due to missing signs), the following display appears in the driver's display:



Traffic Sign Assist is not available in all countries. If the vehicle is in a country where Traffic Sign Assist is not supported, this is displayed continuously.

If the Traffic Sign Assist is temporarily or permanently unavailable due to a technical malfunction or soiling of the windscreen, the Traffic Sign Assist warning light appears  in the driver's display.

- ① Please also note the information on the display messages of the traffic sign assistant (→ page 644).

Warning when the maximum permissible speed is exceeded

The system can warn you if you unintentionally exceed the maximum permissible speed. Depending on the country, you can set in the multimedia system by how much the maximum permitted speed may be exceeded before a warning is given. You can switch off the warning or set whether the

warning should be visual (by flashing the traffic sign in the driver display) or visual and audible. The selected setting is confirmed by an indication in the driver's display.



- ① Warning only visual
- ② WARNING off
- ① The type, duration and trigger levels of the speed warning, as well as the possibility of setting the trigger levels beyond which the warning is to be triggered, are subject to the country-specific legislation of the country in which the vehicle is delivered..

Additional functions of Traffic Sign Assist (country-specific)

Warning for no-entry signs: Traffic Sign Assist can warn you if you drive the wrong way down a section of road, for example on motorway slip roads or one-way streets.

Warning at pedestrian crossings: if you approach pedestrian crossings, provided that pedestrians are in the danger zone or are moving towards it, Traffic Sign Assist can warn you up to a speed of approximately 70 km/h.

Warning at stop signs: Traffic Sign Assist can warn you up to a speed of approximately 70 km/h if you are about to drive past a stop sign unintentionally. For this to be possible, the signs must be clear, for example if the system detects more than one stop sign, or a stop sign can be confirmed using the digital navigation map. No warning can be issued if several different signs are detected.

Warning at red lights: Traffic Sign Assist can warn you up to a speed of approximately 70 km/h if you are about to drive through a red light unintentionally.

The following conditions must be fulfilled:

- Several traffic lights have been detected.
- All traffic lights detected are red.
- At least one of the red traffic lights detected is on the front passenger side beside the vehicle's own lane.
- The traffic lights are in the following sequence (from top to bottom): red, yellow, green.
- ① If the function is available, you can activate or deactivate the warnings at pedestrian crossings, stop signs and red lights in the Traffic Sign Assist menu under **Further warnings** (→ page 254).

System limits

The system may be impaired or may not function particularly in the following situations:

- If visibility is poor, e.g. due to insufficient illumination of the road, highly variable shade conditions, rain, snow, fog, swirling dust or heavy spray.
- If there is glare, e.g. from oncoming traffic, direct sunlight or reflections.

- If there is dirt on the windscreen in the vicinity of the multifunction camera or if the camera is misted up, damaged or obscured.
- if the traffic signs are difficult to see because, for example, they are dirty, obscured, faded, iced over, damaged, inconveniently positioned, insufficiently illuminated or distorted.
- Active traffic signs with LED displays may not be detected correctly or at all due to technical factors, such as transmission frequency.
- If the information on the navigation system's digital map is incorrect, incomplete or out of date.
- if the signs, road markings or road layout are ambiguous, e.g. in the case of traffic signs in construction sites, at exits and driveways, in the case of adjacent lanes or parallel roads, in the case of pedestrian crossing markings at traffic lights
- if the road marking or road markings do not comply with the standard
- if the road marking, road markings or road guidance is country-specific and deviates from

the route guidance of the navigation system, e.g. in or after road works

- After sharp turns and tight bends, when traffic signs are outside the camera's field of vision.
- If you overtake vehicles with traffic signs which are affixed or attached to them.
- If you are using transport equipment secured to the vehicle with a trailer coupling, such as a bicycle rack, restrictions for car/trailer combinations may be considered valid if applicable.

Setting Traffic Sign Assist

Multimedia system:

- 

 ▶ Settings ▶ Assistance
 ▶ Assistance ▶ Traffic Sign Assist

Activating or deactivating the speed warning

- ① The speed warning is switched on by default (depending on the country).
- ▶ Switch off **Speed limit warning**.
The speed warning remains off according to country-specific legislation until the next time the vehicle is switched on or off and the driver's door is opened.

- ① The audible speed warning can also be switched off and on by quick access, by pressing and holding the mute button on the steering wheel, by pressing the speed icon in the status line of the central display or via a voice control command (functions are available depending on the country).

Change the type of speed warning

- ▶ Change the warning to **Visual only** or **Visual and acoustic**.

Setting the warning threshold

This value determines the speed at which a warning is issued when exceeded.

- ▶ Set the desired speed under Warning Threshold.
- ① The availability of the function is subject to country-specific legislation.

Switching the advisory tone for a new speed limit on or off

- ① The advisory tone for a new speed limit is switched off at the factory.

The function determines whether each change of the displayed speed in the driver's display is supported with a subtle, non-intrusive sound.

- ▶ Activate or deactivate the function.
- ① The availability of the function is dependent on the country.

Activating or deactivating further functions of Traffic Sign Assist

- ▶ Switch further warning contents on or off.
The available functions are switched on or off.

Set the type of warning for other functions

- ▶ Select **Visual only** or **Visual and acoustic**.

Traffic light view

Information about the traffic light view

The traffic light view supports the driver when waiting in front of a red light by displaying the camera image on the central display. The camera image is displayed when the driver is the first vehicle in front of the red light and faded out when the vehicle drives off.

■ Displaying traffic light view

Requirements

- The [Traffic light view](#) option is switched on.
- A traffic light view is available.



Multimedia system:

→  ▶ Settings ▶ Assistance
▶ Assistance ▶ Traffic light view

 This function is not available in all countries.

If the vehicle is in first position at a traffic light, the camera image with traffic light view is shown on the central display.

When the vehicle pulls away, the camera image is faded out.

▶ Activate  or deactivate  [Traffic light view](#).

Using other available functions

▶ Select .

▶ Select [On request](#) or [Automatic](#).

If [On request](#) is set and a traffic light view is available, the [Please tap here for traffic light](#)

[view](#). message is displayed. The camera image is shown after confirmation of the message.

When [Automatic](#) is set, the camera image is automatically displayed when the traffic light view is available.

Blind Spot Assist and Active Blind Spot Assist

■ Function of Blind Spot Assist and Active Blind Spot Assist with exit warning

Blind Spot Assist and Active Blind Spot Assist use radar sensors to monitor the area up to 40 m behind and 3 m next to your vehicle.

The system can detect vehicles travelling from speeds of approximately 12 km/h and issue a warning if they move into the monitoring range.

Status display in the driver's display

 **Grey:** the system is activated but inoperative.

 **Green:** the system is activated and operational.

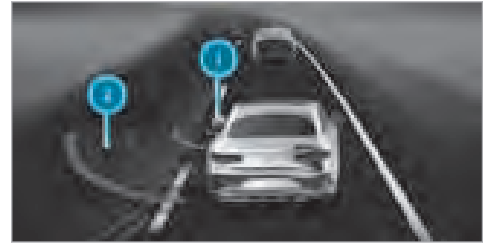

Display in the driver's display in the [Assistance](#) menu

If a vehicle is detected at speeds above approximately 12 km/h and this vehicle enters the warning range immediately afterwards, the warning lamp in the corresponding outside mirror lights up red. In the [Assistance](#) menu, the lamp in outside mirror  also lights up red, and the lane in which the vehicle is detected is hatched out.

If a vehicle is detected in the warning range and you switch on the turn signal indicator in the corresponding direction, a double warning tone sounds once, and the warning lamp flashes red in the corresponding outside mirror. Red radar

waves ② are displayed next to your vehicle in the assistance graphic.

If the turn signal indicator remains on, the display in the outside mirror flashes for all other detected vehicles, but no further warning tone sounds. If you overtake a vehicle quickly, no warning is given.

Observe the notes on driving systems and your responsibility; you may otherwise fail to recognise dangers (→ page 215).

⚠ WARNING Risk of accident despite Blind Spot Assist

Blind Spot Assist does not react to vehicles approaching and overtaking you at a greatly different speed.

Blind Spot Assist cannot warn drivers in this situation.

- ▶ Always pay careful attention to the traffic situation and maintain a safe distance at the side of the vehicle.

Exit warning

The exit warning is an additional function of Blind Spot Assist and Active Blind Spot Assist and can warn vehicle occupants attempting to leave a stationary vehicle about approaching vehicles.

⚠ WARNING Risk of accident despite exit warning

The exit warning neither reacts to stationary objects nor to persons or road users approaching you at a greatly differing speed. The exit warning cannot warn drivers in these situations.

- ▶ Always pay particular attention to the traffic situation when opening the doors and make sure there is sufficient clearance.

If a vehicle is detected in the monitoring range, the red warning lamp lights up in the corresponding outside mirror.

If a vehicle occupant pulls the door handle on the side of the warning, a warning tone sounds twice and the ambient lighting in the respective door

and the warning lamps in the corresponding outside mirror flash red.

Vehicles with MBUX Interior Assistant: the visual warning begins as soon as the hand of a vehicle occupant moves into the area of the door.

- ⓘ **Vehicles with ambient lighting:** the **Warning assistance** of the ambient lighting can be activated and deactivated (→ page 160).
- ⓘ The warning assistance can differ depending on the equipment and may vary according to the setting.

This exit warning is only available when Blind Spot Assist is active.

After the vehicle is switched off, the exit warning continues to function for a few minutes. When the outside mirror warning lamp flashes three times, the exit warning is no longer available.

The exit warning is only an aid and not a substitute for the attention of vehicle occupants. The responsibility for opening and closing the doors and for leaving the vehicle remains with the vehicle occupants.

System limits

Blind Spot Assist and Active Blind Spot Assist may be limited in the following situations, in particular:

- if there is dirt on the sensors or the sensors are obscured
- in poor visibility, e.g. due to fog, heavy rain or snow
- if there are narrow vehicles, e.g. bicycles or motorbikes
- if the road has very wide or narrow lanes
- if vehicles are not driving in the middle of their lane

Warnings may be issued in error when driving close to crash barriers or similar continuous lane borders. Always make sure that there is sufficient distance to the side for other traffic or obstacles.

Warnings may be interrupted when driving alongside long vehicles, for example lorries, for a prolonged time.

Blind Spot Assist and Active Blind Spot Assist are not operational when reverse gear is engaged.

Blind Spot Assist and Active Blind Spot Assist are not operational if transport equipment, for example a trailer or bicycle rack, is attached to the trailer hitch and the electrical connection has been correctly established.

Additionally, the exit warning may be limited in the following situations:

- when the sensors are covered by adjacent vehicles in narrow parking spaces
- when people approach the vehicle
- in the event of stationary or slowly moving objects

You can watch an animation on this topic via the following link:

Function of the brake application of Active Blind Spot Assist

 The brake application function is only available for vehicles with a Driving Assistance Package.

If Active Blind Spot Assist detects a risk of a side impact in the monitoring range, a course-correcting brake application is carried out. This is designed to help you avoid a collision.

The course-correcting brake application is available in the speed range between approximately 30 km/h and approximately 200 km/h.

WARNING Risk of accident despite brake application of Active Blind Spot Assist

A course-correcting brake application cannot always prevent a collision.

- ▶ Always steer, brake or accelerate yourself, especially if Active Blind Spot Assist warns you or makes a course-correcting brake application.
- ▶ Always maintain a safe distance at the sides.

WARNING Risk of accident despite Active Blind Spot Assist

Active Blind Spot Assist does not react in the following situations:

- If you overtake vehicles at a high speed.
- If vehicles approach and overtake you at a greatly different speed.

Active Blind Spot Assist may not give warnings or intervene in such situations.

- ▶ Always pay careful attention to the traffic situation and maintain a safe distance at the side of the vehicle.



If a course-correcting brake application occurs, the red warning lamp flashes in the outside mirror and a warning tone sounds. In addition, a display **1** indicating the danger of a side collision appears in the driver's display.

In rare cases, the system may make an inappropriate brake application. This brake application

may be interrupted at any time if you steer slightly in the opposite direction or accelerate.

System limits

Either a course-correcting brake application appropriate to the driving situation, or none at all, may occur especially in the following situations:

- Vehicles or obstacles, e.g. crash barriers, are located on both sides of your vehicle.
- A vehicle approaches too closely on the side.
- You have adopted a sporty driving style with high cornering speeds.
- You brake or accelerate significantly.
- A driving safety system intervenes, e.g. ESP® or Active Brake Assist.
- ESP® is deactivated.
- A loss of tyre pressure or a defective tyre is detected.
- Transport equipment, for example a trailer or bicycle rack, is attached to the trailer hitch and the electrical connection has been correctly established.

Activating/deactivating Blind Spot Assist or Active Blind Spot Assist

Multimedia system:

- ➔ ➔ Settings ➔ Assistance
- ➔ Collision avoidance

- ▶ Activate or deactivate **Active Blind Spot Assist**.

Active Lane Keeping Assist

Function of Active Lane Keeping Assist

Active Lane Keeping Assist monitors the area in front of your vehicle by means of the multifunction camera (→ page 215) and can warn you before you leave your lane unintentionally. The system can guide you back into your lane through a course-correcting steering intervention and additionally warns you with vibration pulses in the steering wheel. Active Lane Keeping Assist is available in the speed range between 60 km/h and 200 km/h.

The system can intervene in the following situations:

- Active Lane Keeping Assist detects a lane marking.
- One of your front wheels goes over a lane marking.

If you activate the turn signal indicator, a steering intervention does not occur on the corresponding side.

If you leave the lane without activating the turn signal indicator, but danger of a collision with a moving obstacle is detected in your lane, a steering intervention does not occur.

Vehicles with Blind Spot Assist or Driving Assistance Package: if the system detects an obstacle, such as another vehicle in the adjacent lane, a steering intervention will occur regardless of the turn signal indicator.

In the following situations (country-dependent), Active Lane Keeping Assist may already react from a speed of approximately 45 km/h:

- If your own vehicle is overtaken by another road user and the danger of a collision is

detected, a lane-correcting steering intervention occurs.

- If you drive over a detected lane marking, the system warns you with vibration pulses in the steering wheel.



Display ① will appear in the driver's display and a warning tone will sound in the following situations:

- A steering intervention by Active Lane Keeping Assist lasts longer than approximately ten seconds.
- The system carries out two or more steering interventions within approximately three minutes without any steering intervention from the driver.

In the Active Lane Keeping Assist settings, you can set the sensitivity of the system and set the level of support. Additionally, you can set whether the system should react to discontinuous lane markings or only continuous lane markings (→ page 261).

If ATTENTION ASSIST has detected indications of fatigue or a microsleep, the most sensitive setting is automatically selected (→ page 222).

Status displays for Active Lane Keeping Assist



White: Active Lane Keeping Assist is deactivated.

If ESP[®] is deactivated or a tyre pressure loss warning is displayed, Active Lane Keeping Assist is automatically deactivated.



Yellow: there is a malfunction. Please also observe the display messages.



Grey: Active Lane Keeping Assist is activated, but not operating.



Green: Active Lane Keeping Assist is activated and operating. If the system is opera-

tional on only one side, the lane marking is shown in green on the corresponding side.



Red: Active Lane Keeping Assist has guided you back into your lane with a course-correcting steering intervention. The status display will flash if there is also a haptic warning in the steering wheel. The lane marking is shown in red only on the side for which there is a warning.

Vehicles without Driving Assistance Package: if both lane markings are simultaneously shown in red in the status display, Active Lane Keeping Assist has initiated an emergency stop (→ page 239).

Active Lane Change Assist display in the "Assistance" menu



If the front wheel of the vehicle drives over a detected lane marking, this will be highlighted red in the **Assistance** menu in the driver's display.

i Vehicles with active ambient lighting: if **Warning assistance** is activated, the Active Lane Keeping Assist warning is also accompanied by ambient lighting (→ page 160).

System limits

In the following situations, a lane-correcting steering intervention may not occur but rather a warning may be given on the steering wheel, depending on the situation:

- You clearly and actively steer, brake or accelerate.
- If a driving safety system intervenes, such as ESP®, Active Brake Assist or Active Blind Spot Assist.
- You have adopted a sporty driving style with high cornering speeds or high rates of acceleration.
- If transport equipment, for example a trailer or bicycle rack, is attached to the trailer hitch and the electrical connection has been correctly established.

The system may be impaired or may not function particularly in the following situations:

- If there is poor visibility, e.g. due to insufficient illumination of the road, highly variable shade conditions, rain, snow, fog or heavy spray.

- If there is glare, e.g. from oncoming traffic, the sun or reflections.
- If there is dirt on the windscreen in the vicinity of the multifunction camera or if the camera is misted up, damaged or obscured.
- If there is dirt on the bumper in the area of the radar sensors, or if they are damaged or covered.
- If there are no lane markings, or several unclear lane markings are present for one lane, e.g. around roadworks.
- If the lane markings are worn, dark or covered.
- If the distance to the vehicle in front is too short and thus the lane markings cannot be detected.
- If the lane markings change quickly, e.g. lanes branch off, cross one another or merge.
- If the carriageway is very narrow and winding.

Observe the notes on driving systems and your responsibility; you may otherwise fail to recognise dangers (→ page 215).

■ Activating/deactivating Active Lane Keeping Assist

Multimedia system:

-  » Settings » Assistance
- » Collision avoidance
- » Active Lane Keeping Assist

▶ Activate or deactivate the function.

Alternatively, Active Lane Keeping Assist can be activated and deactivated via quick-access.

- ⓘ After starting the vehicle, the settings are country-specific.

■ Setting Active Lane Keeping Assist

Multimedia system:

-  » Settings » Assistance
- » Collision avoidance
- » Active Lane Keeping Assist

Setting the sensitivity

- ▶ Select .
- ▶ Select **Early**, **Med.** or **Late**.

The last selected setting will be adopted the next time the vehicle is started.

- ⓘ The standard setting for this function is dependent on the country.

Activating or deactivating assistance on discontinuous lane markings

▶ Select **Advanced support**.

The last selected setting will be adopted the next time the vehicle is started.

- ⓘ The standard setting for this function is dependent on the country.
- ⓘ This function must be activated in vehicles without Driving Assistance Package, so that Emergency Stop Assist is fully available. Further information on Emergency Stop Assist (→ page 239)

AIRMATIC

■ Function of AIRMATIC

AIRMATIC is an air suspension system with variable damping for improved driving comfort. The all-round level control system ensures the best possible suspension and constant ground clearance, even with a laden vehicle. When driving at speed,

the vehicle is lowered automatically to improve driving safety and to reduce energy consumption. You also have the option of manually adjusting the vehicle level.

AIRMATIC includes the following components and functions:

- air suspension with automatic all-round level control
- ADS PLUS (Adaptive Damping System with constant adjustment of damping characteristics)
- speed-dependent lowering of the vehicle level
- increased vehicle level for greater ground clearance, selected via the multimedia system

Suspension setting and vehicle level per drive program

Drive program **[C]**:

- comfortable suspension setting
- adjusting the vehicle to normal level
- lowering the vehicle at speeds above approx. 120 km/h to low level -1

- raising the vehicle at speeds below approx. 80 km/h

Drive program **[E]**:

- comfortable suspension setting
- adjusting the vehicle to low level -1

Drive program **[S]**:

- firmer suspension setting
- adjusting the vehicle to low level -1

Individual suspension settings can be called up in drive program **[I*]** (→ page 195).

i Operation with a trailer or bicycle rack: if transport equipment, such as a trailer or a bicycle rack, is attached to the trailer hitch and the electrical connection has been correctly established, the vehicle remains at normal level irrespective of speed or the drive program selected.

Setting the vehicle level

⚠ WARNING Risk of accident because vehicle level is too high

Driving characteristics may be impaired.

The vehicle can drift outwards, for example, when steering or cornering.

▶ Choose a vehicle level which is suited to the driving style and the road surface conditions.

⚠ WARNING Risk of entrapment from vehicle lowering

When lowering the vehicle, other people could become trapped if their limbs are between the vehicle body and the tyres or underneath the vehicle.

▶ Make sure no one is underneath the vehicle or in the immediate vicinity of the wheel arches when the vehicle is being lowered.

⚠ WARNING Risk of becoming trapped due to the vehicle lowering

Vehicles with AIRMATIC or level control: when you unload luggage or leave the vehicle, the vehicle first rises slightly and then returns to the set level shortly afterwards.

You or anyone else in the vicinity of the wheel arches or the underbody could thus become trapped.

The vehicle can also be lowered after being locked.

▶ When leaving the vehicle, make sure that nobody is in the vicinity of the wheel arches or the underbody.

! NOTE Damage due to vehicle lowering

Parts of the body could be damaged when the vehicle is lowered.

▶ Make sure that there are no obstacles such as kerbs underneath or in the immediate vicinity of the body when the vehicle is being lowered.

Requirements

- The vehicle has been started.
- The vehicle is not moving faster than 60 km/h.
- When the trailer socket is contacted (trailer/bicycle rack): the vehicle is not moving faster than 30 km/h.

Multimedia system:



Raising the vehicle

- ▶ Select .
- The indicator lamp lights up continuously.
- The vehicle is raised to off-road level +1.

Your selection is saved. Off-road level+1 set remains stored even after the vehicle has been switched off.

The vehicle is lowered again in the following situations:

- When driving faster than 80 km/h.

- When the trailer socket is contacted (trailer/bicycle rack): the vehicle is moving faster than 30 km/h.

Lowering the vehicle

- ▶ Select .
- The indicator lamp goes out.
- The vehicle is lowered to normal level.
- ⓘ In the Sport and Eco drive programs, only normal vehicle level is possible when the trailer socket is contacted (trailer/bicycle rack).

Reversing camera

Function of the reversing camera

The reversing camera is only an aid. It is not a substitute for your attention to the surroundings. The responsibility for safe manoeuvring and parking remains with you. Make sure that there are no persons, animals or objects etc., in the manoeuvring area while manoeuvring and parking.

- ⓘ The area behind the vehicle is displayed as a mirror image, as in the inside rear view mirror.



Camera views menu (top view)

- ① Menu **Parking Assistance**
- ② Reversing camera with top view
- ③ Wide-angle view
- ④ Trailer view
- ⑤ Activating/deactivating Parking Assist PARKTRONIC (→ page 274)

- ⑥ Warning display of Parking Assist PARKTRONIC (→ page 271, 292)
- ⑦ Guide lines at a distance of approximately 0.5 m, 1.0 m, 1.5 m and 3.0 m from the rear area
- ⑧ Lane marking the course the tyres will take with the current steering angle (dynamic)
- ⑨ Driven surface depending on the current steering angle (dynamic)
- ⑩ Guide line at a distance of approximately 0.3 m from the rear area
- ⓘ When Active Parking Assist is active, lanes ⑧ are displayed in green (→ page 275).

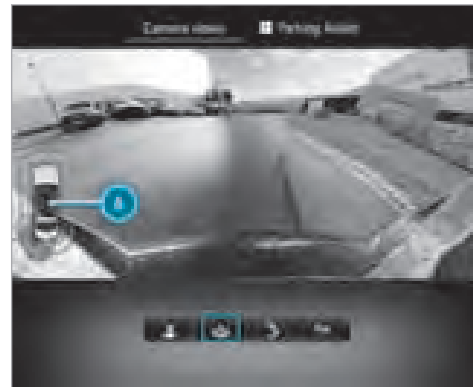

Wide-angle view



Trailer view

- ① Yellow guide line, locating aid
- ② Red guide line at a distance of approximately 0.3 m from the ball head of the trailer hitch
- ③ Ball head of the trailer hitch

System limits

If the system is not ready for operation, the **System inoperative** message appears in the central display.

The reversing camera will not function or will only partially function in the following situations:

- You are driving forwards at a speed greater than approximately 16 km/h.
- The boot lid is open.
- The weather conditions are poor, e.g. heavy rain, snow, fog, storm or spray.
- The light conditions are poor, e.g. at night or if light is shining into the camera.
- The camera lens is obstructed, dirty or misted up. Observe the notes on cleaning the reversing camera (→ page 481).
- The camera or rear of your vehicle is damaged. In this case, have the camera and its position and setting checked at a qualified specialist workshop.
- The detection range is limited by additional vehicle attachments at the rear, such as a licence plate bracket or bicycle rack.

Also observe the information on vehicle sensors and cameras (→ page 215).

- ① Do not use the reversing camera in these types of situations. You could otherwise injure others or collide with objects when parking the vehicle.
- ① The contrast of the display may be impaired by direct sunlight or by other light sources, e.g. when driving out of a garage. In this case, pay particular attention.
- ① Have the display repaired or replaced if, for example, pixel errors considerably restrict its use.

360° Camera

Function of the 360° Camera

The 360° Camera is a system that consists of four cameras which cover the immediate surroundings of the vehicle. The cameras assist you when you are parking, for example, or at exits with reduced visibility.

The 360° Camera includes the following cameras and evaluates their images:

- Reversing camera
- Front camera
- Two side cameras in the outside mirrors

The cameras are only an aid and may show a distorted view of obstacles, show them incorrectly or not show them at all. They are not a substitute for your attention to the surroundings. The responsibility for safe manoeuvring and parking remains with you. Make sure that there are no persons, animals or objects etc., in the manoeuvring area while manoeuvring and parking.

Menu overview **Camera views**

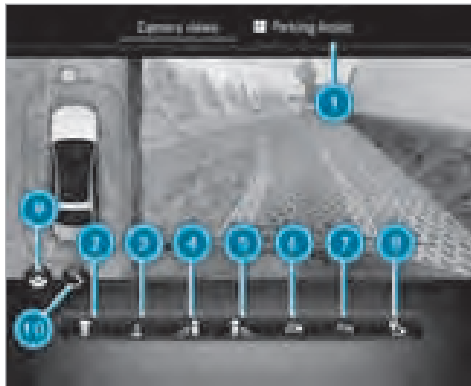

- 1 Menu **Parking Assistance**
- 2 Top view with image from the front camera
- 3 Top view with image from the reversing camera
- 4 3D view, left-hand side of the vehicle
- 5 3D view, right-hand side of the vehicle
- 6 3D auto view

- 7 Activating/deactivating Parking Assist PARKTRONIC (→ page 274)
 - 8 To set the GPS activation point
 - 9 To switch between standard and wide-angle view
 - 10 To switch between standard and trailer view
- i In all views, the Parking Assist PARKTRONIC warning display is shown (→ page 271).

Function of the guide lines

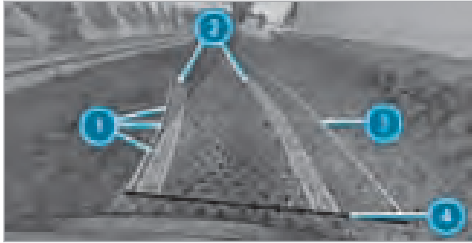

- ① Guide lines at a distance of approximately 0.5 m, 1.0 m, 1.5 m and 3.0 m Distance from the rear area
 - ② Lane marking the course the tyres will take with the current steering angle (dynamic)
 - ③ Driven surface depending on the current steering angle (dynamic)
 - ④ Guide line at a distance of approximately 0.3 m from the rear area
- i** When Active Parking Assist is active, lanes and guide lines are displayed in green instead of yellow (→ page 275).

Top view with image from the front or reversing camera



- ① Warning display of Parking Assist PARKTRONIC (→ page 271)
- ② Your vehicle from above
- ③ Lane indicating the route the vehicle will take at the current steering angle

3D view, left/right-hand side of the vehicle

! **NOTE** Risk of accident due to objects being severely distorted in the display or not displayed at all

Due to the projection of the cameras, objects in the 3D views may be severely distorted when displayed or not displayed at all.

▶ Make sure that there are no persons, animals or objects etc. in the manoeuvring area while manoeuvring and parking.



- ① Display of Parking Assist PARKTRONIC (→ page 271)

In the 3D view, left-/right-hand side of the vehicle, the virtual camera moves to the respective side of the vehicle. When you change the transmission position, the view is automatically adapted.

3D auto view

- ⓘ The area behind the vehicle is **not** displayed as a mirror image as is usual in the 3D views.

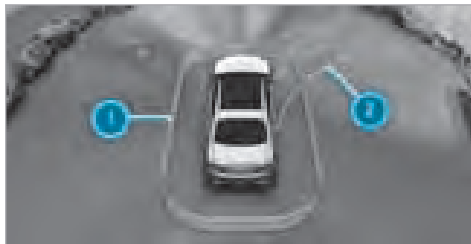

- ① Display of Parking Assist PARKTRONIC (→ page 271)
- ② Guide lines

In the 3D auto view, the virtual camera moves to the standard perspective, facing forward from the rear above the roof. The view changes automatically when approaching obstacles.

If you touch the touchscreen, the view changes to 3D view with free rotation. You can turn, tilt and zoom the views by touch.

Wide-angle view



- ① Display of Parking Assist PARKTRONIC (→ page 271)
- ② To switch between standard and wide-angle view

Trailer view

- ⓘ In trailer mode, the guide lines are shown at the level of the trailer hitch.

If you select trailer view and no trailer is coupled to the vehicle, the following display appears:

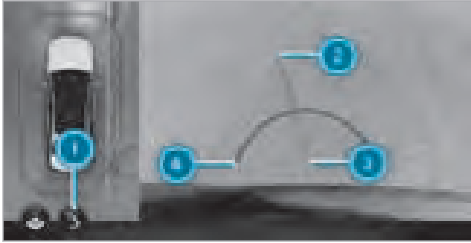

Trailer view: locating aid

- ① To switch between standard and trailer view
- ② Yellow locating aid
- ③ Ball head of the trailer hitch
- ④ Red guide line at a distance of approximately 0.3 m from the ball head of the trailer hitch

When the electrical connection is established between the vehicle and the trailer, the display changes to the side camera view.



Trailer view: side view of the mirror cameras

- ① To switch between standard and trailer view

System limits

If the system is not ready for operation, the **System inoperative** message appears in the central display.

The 360° Camera will not function or will only partially function in the following situations:

- You are driving forwards at a speed greater than approximately 16 km/h.
- The doors are open.
- An outside mirror is not completely folded out.
- The boot lid is open.

- The weather conditions are poor, e.g. heavy rain, snow, fog, storm or spray.
 - The light conditions are poor, e.g. at night or if light is shining into the camera.
 - The camera lens is obstructed, dirty or misted up.
 - If cameras or vehicle components in which the cameras are fitted are damaged. In this event, have the cameras, their positions and their setting checked at a qualified specialist workshop.
- ⓘ Do not use the 360° Camera under such circumstances. You could otherwise injure others or collide with objects when parking the vehicle.

For technical reasons, the standard height of the vehicle may be altered if the vehicle is carrying a heavy load and can result in inaccuracies in the guide lines and in the display of the generated images.

The field of vision and other functions of the camera system may be restricted due to additional attachments on the vehicle (e.g. licence plate bracket, bicycle rack).

ⓘ The contrast of the display may be impaired by abrupt, direct sunlight or by other light sources, e.g. when driving out of a garage. In this case, pay particular attention.

ⓘ Have the display repaired or replaced if, for example, pixel errors considerably restrict its use.

See the notes on cleaning the 360° Camera (→ page 481).

■ Calling up the 360° Camera views using the button

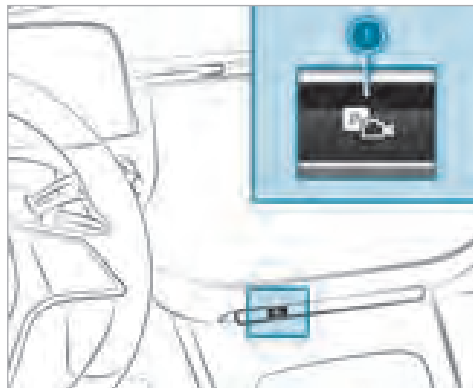

- ▶ Press button ⓘ.
- ▶ Select **Camera views** menu.
- ▶ Select the desired view in the multimedia system (→ page 265).

■ Selecting a view for the 360° Camera (reverse gear)

Requirements:

- The **Activation in R** setting is activated in the multimedia system (→ page 270).
- ▶ Engage reverse gear.
- ▶ Select the desired view in the multimedia system (→ page 265).

■ Setting the reversing camera or 360° Camera

Multimedia system:

→ [Home] ▶▶ Settings ▶▶ Assistance
▶▶ Camera

▶ Activate or deactivate **Activation in R**.

ⓘ The settings for deactivating the reversing camera are not available in every country.

■ Opening the camera cover

Multimedia system:

→ [Home] ▶▶ Settings ▶▶ Assistance
▶▶ Camera

▶ Select **Open camera cover**.

- ⓘ The camera cover closes automatically after some time or after the vehicle is switched on or off.

Parking Assist PARKTRONIC

Function of Parking Assist PARKTRONIC

Parking Assist PARKTRONIC is an electronic parking assistance system which monitors the area surrounding your vehicle and shows you the distance between the vehicle and a detected obstacle visually and audibly.

The passive side impact protection also warns you of obstacles to the side. These must be detected beforehand by the sensors in the front or rear bumper while driving by them. If you steer in the direction of a detected obstacle and there is a risk of a lateral collision, a warning is issued. The passive side impact protection can be activated and deactivated via the multimedia system.

In order for front or rear obstacles to the side to be displayed, the vehicle must first travel a distance of at least half a vehicle length. Once the vehicle has travelled one vehicle length, obstacles on all sides can be shown.

Parking Assist PARKTRONIC is only an aid. It is not a substitute for your attention to the surroundings. The responsibility for safe manoeuvring and parking remains with you. Make sure that there are no persons, animals or objects in the manoeuvring area while manoeuvring and parking in/exiting parking spaces.

Displays in the central display



Vehicles with 360° Camera



Vehicles with reversing camera

As soon as Parking Assist PARKTRONIC is ready for display, the respective areas of the display are shown in blue.

- ① Front and rear display ready
- ② All-round display ready
- ③ All around display ready and obstacles detected

The colour of the display changes depending on the distance to the detected obstacle:

- **Blue:** > 1 m (no obstacles detected)
- **Yellow:** approx. 1 m - 0.7 m

- **Orange:** approx. 0.7 m - 0.4 m
- **Red:** <0.4 m

Vehicles with 360° Camera: the boundary line shifts dynamically depending on the position and distance of the obstacles detected.

Depending on the distance to the obstacle detected, an intermittent warning tone also sounds. You can set the timing of the warnings in the multimedia system. In the **Warn early** setting, the system warns you from a distance of 1 m, in the standard setting only from 0.4 m.



Vehicles with 360° Camera



Vehicles with reversing camera

If you are not in the **Camera & parking** menu and an obstacle in the vehicle path is detected, pop-up window ① appears in the central display if the following requirements are met:

- **Vehicles without Active Parking Assist:** when driving no faster than 12 km/h.

- **Vehicles with Active Parking Assist:** when driving no faster than 18 km/h.

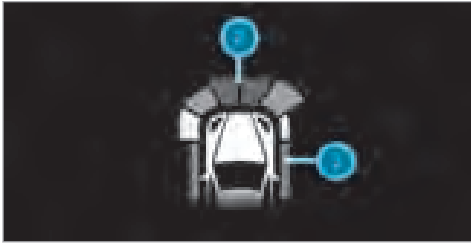

Optionally, obstacles detected by Parking Assist PARKTRONIC from a distance of approximately 1.0 m in front ② and 0.7 m on sides ③ can also be displayed in the head-up display.

Vehicles with active ambient lighting and Parking Package with remote parking functions

When **Warning assistance** is activated, the Parking Assist PARKTRONIC display is also accompanied by ambient lighting. If an obstacle is detected, the ambient lighting lights up in the same colour as the display in the central display.

The ambient lighting which accompanies the Parking Assist PARKTRONIC display is only intended to accentuate the display in the central display and does not replace it.

More information on ambient lighting:
(→ page 160)

- ① A display message for the ambient lighting does not occur in the area of the driver's display or in the rear compartment.
- ① Depending on the selected setting, other functions may supersede the ambient lighting effects of Parking Assist PARKTRONIC. In this case, the ambient lighting effects of Parking Assist PARKTRONIC do not occur.

System limits

Parking Assist PARKTRONIC does not necessarily take into account the following obstacles:

- Obstacles below the detection range, e.g. persons, animals or objects.
- Obstacles above the detection range, e.g. overhanging loads, overhangs or loading ramps of lorries.

- Pedestrians or animals approaching the vehicle from the side.
- Objects placed next to the vehicle

Obstacles on the sides are not shown in the following situations, for example:

- You park the vehicle and switch it off.
- You open the doors.

After the engine is restarted, obstacles must be detected again by driving past them before a new warning can be issued.

Also observe the system limits of the following systems:

- Reversing camera (→ page 263)
- 360° Camera (→ page 265)

Observe the information on vehicle sensors and cameras; otherwise, the system cannot function properly (→ page 215).

Vehicles with towbar: If a transport device, e.g. trailer or bicycle carrier, is attached to the towbar and the electrical connection is correctly established, Parking Assist PARKTRONIC is deactivated for the rear zone.

Problems with Parking Assist PARKTRONIC

If the Parking Assist PARKTRONIC display lights up red for approximately three seconds then goes out, and the  symbol appears in the driver's display, the system may have been deactivated due to signal interference. Start the vehicle again and check if Parking Assist PARKTRONIC is working at a different location.

If a warning tone also sounds, it may be due to one of the following causes:

- **The sensors are dirty:** clean the sensors and observe the notes on care of vehicle parts (→ page 481).
- **Parking Assist PARKTRONIC has been deactivated due to a malfunction:** restart the vehicle. If the problem persists, consult a qualified specialist workshop.

Activating/deactivating Parking Assist PARKTRONIC

 **NOTE** Risk of an accident from objects at close range

Parking Assist PARKTRONIC may not detect certain objects at close range.

- ▶ When parking or manoeuvring the vehicle, pay particular attention to any objects which are above or below the sensors, e.g. flowerpots or drawbars. The vehicle or other objects could otherwise be damaged.

Requirements:

- The camera menu is open.
 - Or: Active Parking Assist is active.
 - Or: the PARKTRONIC pop-up window appears.
- ▶ Press  in the central display.

If the indicator lamp is lit, Parking Assist PARKTRONIC is active. If the indicator lamp does not light up or the symbol  is displayed, PARKTRONIC Parking Assist is not active.

- ① Parking Assist PARKTRONIC is automatically activated when the vehicle is started.

Alternatively, Parking Assist PARKTRONIC can be activated or deactivated in the quick access menu.

Setting the warning tones of Parking Assist PARKTRONIC

Multimedia system:

- ▶  ▶ Settings ▶ Assistance ▶ Parking

Adjusting warning tones

- ▶ Select [Set warning tones](#).
- ▶ Set the desired level under [Volume](#) or [Tone pitch](#).

Activating/deactivating audio fadeout

- ▶ [Audio fadeout](#) select and [Audio fade for warnings](#) switch on or off. The volume of the currently playing media source is reduced during a Parking Assist PARKTRONIC warning tone.

or

- ▶ **Audio fadeout** select and **Audio fadeout in trans. position R** switch on or off.
The volume of the currently playing media source is reduced when reverse gear is engaged.

Setting the time of the warnings

- ▶ Select **Time of warning**
- ▶ Activate or deactivate **Side warning**.
- ▶ Set the desired warning time for **Front** or **Rear**.

Active Parking Assist

Function of Active Parking Assist

Active Parking Assist is an electronic parking assistance system, which uses ultrasound with the assistance of the reversing camera and 360° Camera. When you are driving forwards up to approximately 35 km/h, the system automatically measures parking spaces on both sides of the vehicle.

Active Parking Assist offers the following functions:

Vehicles with reversing camera

- Parking in parking spaces parallel to the road
- Reversing into parking spaces perpendicular to the road

Vehicles with 360° Camera

- Parking in parking spaces parallel to the road
- Parking in parking spaces perpendicular to the road (optionally either forwards or reverse)
- Parking in parking spaces that can only be detected as such due to markings (forexample at the roadside)
- Exiting a parking space parallel to the road
- Exiting a parking space perpendicular to the road (optionally either left or right)

Active Parking Assist is only an aid. It is not a substitute for your attention to the surroundings. The responsibility for safe manoeuvring and parking remains with you. Make sure that no persons, animals or objects etc. are in the manoeuvring range.



If Active Parking Assist is available, the  message appears in the driver's display. When the

system detects parking spaces,  appears. The arrows show on which side of the road free parking spaces are located. These are then shown in the central display.

When Active Parking Assist is activated, the turn signal indicators are activated based on the calculated path of your vehicle. When you are entering or exiting a parking space, the procedure is assisted by acceleration, braking, steering and gear changes.

To start the parking procedure, press the  button (→ page 277).

Active Parking Assist will be cancelled in the following situations:

- You deactivate Parking Assist PARKTRONIC.
- You press the  button again.
- You begin steering.
- You engage park position .
- ESP® intervenes.
- You open the driver's door.

System limits

If the exterior lighting is malfunctioning, Active Parking Assist is not available.

Also observe the system limits of the following systems:

- Reversing camera (→ page 263)
- 360° Camera (→ page 265)

Objects that are above or below the detection range of Active Parking Assist, e.g. protruding loads, overhangs or loading ramps of trucks or boundaries of parking spaces, are not detected when measuring the parking space. These are also then not taken into account when calculating the parking procedure. In some circumstances, Active Parking Assist may therefore guide you into the parking space prematurely or brake too late.

Certain environmental conditions, such as snowfall or heavy rain, may lead to a parking space being measured inaccurately. Parking spaces that are partially occupied by trailer drawbars might not be identified as such or be measured incorrectly. Only use Active Parking Assist on level, high-grip ground.

⚠ WARNING Risk of accident due to objects located above or below the detection range of Active Parking Assist

If there are objects above or below the detection range, the following situations may arise:

- Active Parking Assist may steer too early.
- The vehicle may not stop in front of these objects.

There is a danger of collision!

▶ In these situations, do not use Active Parking Assist.

Active Parking Assist can also display unsuitable parking spaces, e.g. parking spaces in which parking is not permitted or parking spaces on unsuitable surfaces.

Do not use Active Parking Assist in the following situations:

- In extreme weather conditions such as ice, packed snow or in heavy rain.
- When transporting a load that protrudes beyond the vehicle.

- If the parking space is on a steep downhill or uphill gradient.
- When snow chains are fitted.
- When a trailer or bicycle rack is attached.
- Directly after a tyre change or when spare tyres are fitted.
- If the tyre pressure is too low or too high.
- If the suspension is out of alignment, e.g. after bottoming out on a kerb.
- On steep inclines of more than approximately 15 %.

You can watch an animation on this topic via the following link:

Parking with Active Parking Assist

⚠ WARNING Risk of accident due to objects located above or below the detection range of Active Parking Assist

If there are objects above or below the detection range, the following situations may arise:

- Active Parking Assist may steer too early.
- The vehicle may not stop in front of these objects.

There is a danger of collision!

- ▶ In these situations, do not use Active Parking Assist.

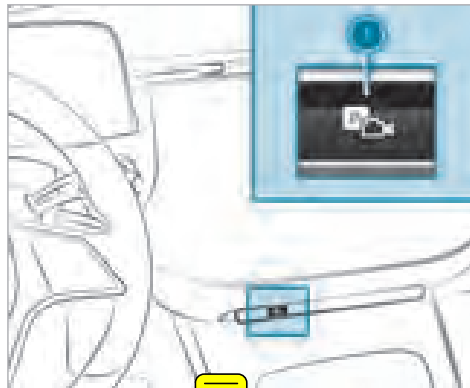

▶ Press ① button.

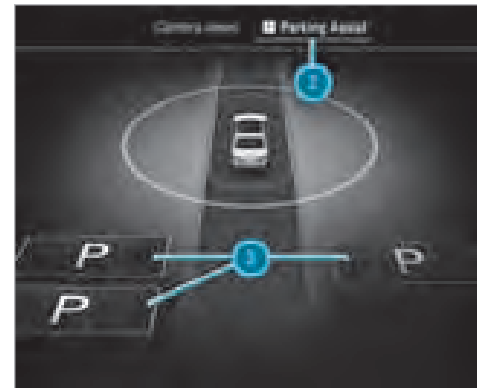

▶ Select ② Parking Assistance menu.

Parking spaces ③ detected by the system are shown in the central display.

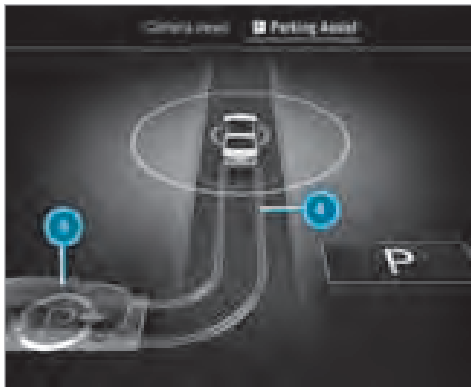

When the vehicle is stationary, indicated vehicle path ④ into currently selected parking space ⑤ also appears.

- ▶ If a parking space is displayed: stop the vehicle.
- ▶ If necessary, select another parking space.

- ▶ **Vehicles with 360° Camera:** to change the parking direction, tap the selected parking space again.
- ▶ **To start the parking procedure:** press button ① again.
The vehicle drives into the selected parking space.

The turn signal indicator is switched on automatically when the parking procedure begins. You are responsible for selecting the turn signal indicator in accordance with the traffic conditions. If necessary, select the turn signal indicator accordingly.

⚠ WARNING Risk of accident due to vehicle swinging out while parking or pulling out of a parking space

While parking or exiting a parking space, the vehicle swings out and can drive onto areas of the oncoming lane.

This could cause you to collide with objects or other road users.

- ▶ Pay attention to objects and other road users.

- ▶ Where necessary, stop the vehicle or cancel the parking procedure with Active Parking Assist.

On completion of the parking procedure, the **Active Parking Assist finished** display message appears.

- ▶ Secure the vehicle against rolling away. When required by legal requirements or local conditions: turn the wheels towards the kerb.
- ① You can stop the vehicle and change the transmission position during the parking procedure. The system then calculates a new vehicle path. If no new vehicle path is available, the transmission position can be changed again, or the process can be cancelled.

Immediate parking via the **Camera views** menu



- ▶ Select the **Camera views** menu.
- ▶ When the vehicle is stationary and in transmission position **[R]**, and symbol **6** appears in the camera image: press button **1** again. The parking procedure is initiated for the detected parking space.
- i** The parking space and parking direction cannot be changed in immediate parking.

Exiting a parking space with **Active Parking Assist**

⚠ WARNING Risk of accident due to objects located above or below the detection range of Active Parking Assist

If there are objects above or below the detection range, the following situations may arise:

- Active Parking Assist may steer too early.
- The vehicle may not stop in front of these objects.

There is a danger of collision!

- ▶ In these situations, do not use Active Parking Assist.

Requirements

- The vehicle is equipped with a 360° Camera.
 - The vehicle has been parked with Active Parking Assist.
- ▶ Start the vehicle.

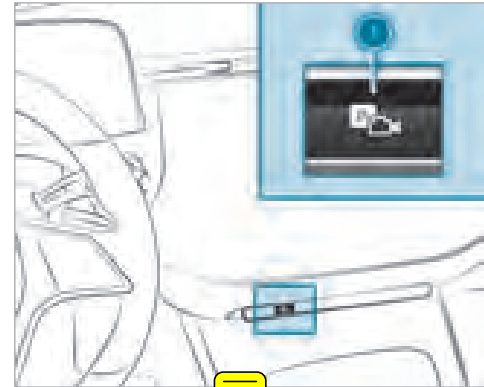

- ▶ Press button **1**.



- ▶ Select **Parking Assistance** ② menu.
- ▶ If necessary, change direction of exit ③.
- ▶ **To start exiting the parking space:** press button ① again.
- ▶ If necessary, change the gearbox setting. Observe any messages displayed in the driver's display and central display. The vehicle moves out of the parking space.

The turn signal indicator is automatically switched on when exiting a parking space begins and switched off when it is completed. You are responsible for selecting the turn signal indicator in accordance with the traffic conditions. If necessary, select the turn signal indicator accordingly.

⚠ WARNING Risk of accident due to vehicle swinging out while parking or pulling out of a parking space

While parking or exiting a parking space, the vehicle swings out and can drive onto areas of the oncoming lane.

This could cause you to collide with objects or other road users.

- ▶ Pay attention to objects and other road users.
- ▶ Where necessary, stop the vehicle or cancel the parking procedure with Active Parking Assist.

After the parking space has been exited, a warning tone and the  **Active Parking Assist finished, take control of vehicle** message prompt

you to take control of the vehicle. You have to accelerate, brake, steer and change gear yourself again.

If you do not react to the prompt to take control of the vehicle, the system will brake the vehicle to a standstill.

■ Pausing Active Parking Assist

⚠ WARNING Risk of accident due to objects located above or below the detection range of Active Parking Assist

If there are objects above or below the detection range, the following situations may arise:

- Active Parking Assist may steer too early.
- The vehicle may not stop in front of these objects.

There is a danger of collision!

- ▶ In these situations, do not use Active Parking Assist.

You can interrupt the parking or exiting procedure of Active Parking Assist by performing one of the following actions, for example:

- ▶ Depress the brake pedal.
 - ▶ Open the front passenger door, a rear door, the boot or the bonnet.
 - ▶ Apply the electric parking brake or activating the HOLD function.
 - ▶ **To resume the parking or exiting procedure:** gently depress the accelerator pedal.
- ⓘ If the electric parking brake was applied before Active Parking Assist was activated, depress the accelerator pedal lightly to start the parking or exiting procedure.

Check the area around your vehicle again before resuming a paused parking procedure. Make sure that persons, animals or objects are no longer in the manoeuvring range. Also observe the system limitations of Active Parking Assist.

Automatic braking function of Active Parking Assist

⚠ WARNING Risk of accident due to objects located above or below the detection range of Active Parking Assist

If there are objects above or below the detection range, the following situations may arise:

- Active Parking Assist may steer too early.
- The vehicle may not stop in front of these objects.

There is a danger of collision!

- ▶ In these situations, do not use Active Parking Assist.

Persons or objects detected in the manoeuvring range could cause the vehicle to brake sharply and interrupt the parking or exiting procedure. The vehicle will then be held at a standstill. If you depress the accelerator pedal, the parking or exiting procedure is resumed.

Check the area around your vehicle again before resuming the parking or exiting procedure. Make

sure that persons, animals or objects are no longer in the manoeuvring range. Also observe the system limitations of Active Parking Assist.

Remote Parking Assist

Function of Remote Parking Assist

- ⓘ Remote Parking Assist is an additional function of Active Parking Assist. Comply with local traffic laws and regulations when using Remote Parking Assist on public roads. If it is required to turn the wheels toward the kerb, you cannot use Remote Parking Assist. Please note that you can only use Remote Parking Assist if you have a valid driving licence and are in a fit state to drive.

Remote Parking Assist parks your vehicle or exits the parking space while you are outside of your vehicle. You can monitor the manoeuvring and parking procedure on your mobile phone.

With Remote Parking Assist, you can carry out all the parking procedures of Active Parking Assist. You can also position the vehicle directly in front of a garage or a driveway entrance and then use

Remote Parking Assist to enter or exit a parking space.

Remote Parking Assist manages pulling away, braking and steering. While Remote Parking Assist is active, the vehicle is locked.

Remote Parking Assist is only an aid. It is not a substitute for your attention to the surroundings. The responsibility for safe manoeuvring and parking remains with you. Interrupt or terminate the parking procedure if necessary. Make sure that no persons, animals or objects etc. are in the manoeuvring range. Make sure to also pay attention to other vehicles.

System limits

If the system detects a malfunction or a system limit during the manoeuvring or parking procedure, the procedure will be cancelled:

- The vehicle is brought to a standstill.
- Transmission position **P** is selected and the electric parking brake is applied automatically.
- The vehicle is switched off.
- The vehicle remains locked.

If the parking manoeuvre is cancelled, a corresponding message is displayed on the mobile phone.

Depending on the situation, you can then take control of the procedure, manoeuvre the vehicle back to the starting position or manually take control of the vehicle.

The system limits of Active Parking Assist apply (→ page 275).

Certain environmental conditions, such as snowfall or heavy rain, may lead to a parking space being measured inaccurately or to connection problems with the mobile phone. Only use Remote Parking Assist on level, high-grip ground.

During the parking procedure, you should not stand more than approx. 3.0 m away from the vehicle. At greater distances, the procedure will be interrupted and a corresponding message will be displayed on the mobile phone. If you move closer to the vehicle, you will be able to continue the procedure.

You can watch an animation on this topic via the following link:

Operating Remote Parking Assist

Requirements

For the Remote Park Assist function you need:

- a Mercedes me user account
- the current Remote Park Assist app for your vehicle type
- a mobile phone

i A list of compatible phones can be found at: <https://www.mercedes-benz-mobile.com/>

The following operating systems are supported:

- Android™
- Apple® iOS

⚠ WARNING Risk of accident due to objects located above or below the detection range of Active Parking Assist

If there are objects above or below the detection range, the following situations may arise:

- Active Parking Assist may steer too early.
- The vehicle may not stop in front of these objects.

There is a danger of collision!

- ▶ In these situations, do not use Active Parking Assist.

Objects located above the detection range of Active Parking Assist will not be detected when the parking space is measured. These are not taken into account when the parking procedure is calculated, e.g. overhanging loads, overhangs or loading ramps of goods vehicles. In some circumstances, Active Parking Assist may therefore guide you into the parking space prematurely.

⚠ WARNING Danger due to insufficient view of the vehicle surroundings

If you manoeuvre, park or exit a parking space with the vehicle using Remote Parking Assist, observe the following:

- ▶ Make sure that you have the best view possible of the vehicle and the vehicle's surroundings.
- ▶ Make sure that no persons, animals or objects are in the path of your vehicle.

- ▶ Make sure that you maintain a suitable distance to the vehicle and that neither you nor other road users could be endangered.
- ▶ Be aware of the vehicle's surroundings at all times and identify possible dangers.
- ▶ If necessary, cancel the parking procedure.

No persons or pets are permitted to remain in the vehicle during the parking procedure. Observe the system limits at all times. If necessary, cancel the parking procedure. Always ensure that vehicle access by other road users is maintained.

- ▶ Activate the "Remote Parking Assist" service e.g. via the Mercedes me homepage.
- ▶ Authorise the mobile phone using the Remote Parking Assist App in the vehicle (→ page 285).

Selecting the parking manoeuvre in advance while inside the vehicle

- ▶ Stop the vehicle and select transmission position **P**.

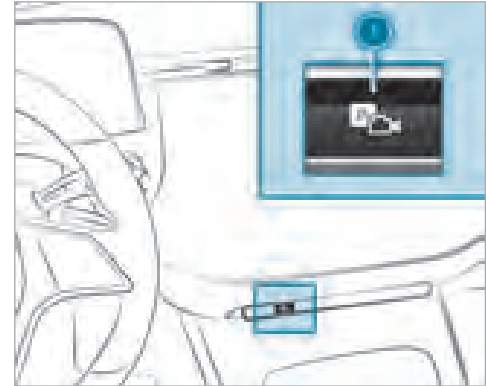

- ▶ Press button ①.

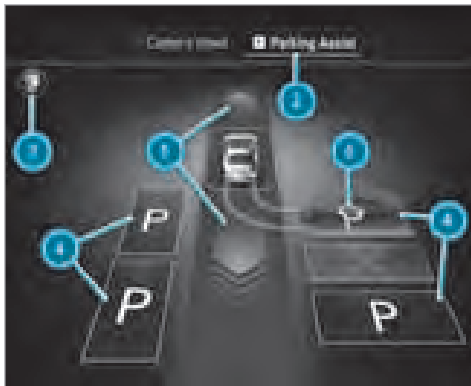

- ▶ Select **2** Parking Assistance menu.
- ▶ For further information on Remote Parking Assist: select **3**.
- ▶ If necessary, select another parking space **4** or select **5** to drive straight ahead into a garage, for example.
- ▶ If necessary, change parking direction **6**.

i Alternatively, you can begin parking with Active Parking Assist (→ page 277) and continue with the Remote Parking Assist from any vehicle position. To do this, stop the parking process and adjust the gearbox setting **P**.

- ▶ Switch off the vehicle and exit it with the key.

Starting the parking procedure without selecting in advance

- ▶ Stop the vehicle and select transmission position **P**.
- ▶ Switch off the vehicle and exit it with the key.

Starting the parking procedure while outside the vehicle

- ▶ Unlock the vehicle.

Carrying out a parking procedure with Remote Parking Assist

- i** Keep the vehicle key with you during the parking procedure. You can cancel the parking procedure and bring the vehicle to a standstill by pressing a button on the key.
- i** On completion of the parking procedure, the vehicle is locked.

If you have started the parking procedure as described above, the vehicle is ready to connect to your mobile phone for a limited time.

- ▶ Start the Remote Parking Assist App on the mobile phone and connect to the vehicle.
- ▶ Follow the instructions of the Remote Parking Assist App.

- i** The turn signal indicator is automatically switched on when starting parking and switched off when it is completed.
- i** If the connection between the vehicle and the mobile phone is interrupted while a parking manoeuvre is being performed, the manoeuvre can be continued if the connection is re-established within a short time.

⚠ WARNING Risk of accident due to vehicle swinging out while parking or pulling out of a parking space

While parking or pulling out of a parking space, the vehicle swings out and can drive onto areas of the oncoming lane.

This could cause you to collide with objects or other road users.

- ▶ Pay attention to objects and other road users.
- ▶ Where necessary, stop the vehicle or cancel the parking procedure with Remote Parking Assist.

- ▶ After ending the parking procedure, ensure that all vehicle doors, windows and the boot are closed. Secure the vehicle against rolling away.

Cancelling the parking procedure

You can cancel the parking procedure of Remote Parking Assist at any time and bring the vehicle to a standstill.

- ▶ Cancel the parking procedure in the Remote Parking Assist App.
- or
- ▶ Press a button on the vehicle key.
- or
- ▶ Pull a door handle.

Authorising/de-authorising a mobile phone for Remote Parking Assist

Multimedia system:

- ▶  ▶ Settings ▶ Assistance
- ▶ ▶ Parking

Authorising a new mobile phone

In order to be able to use the Remote Parking Assist function, you must authorise your mobile phone. You can authorise up to ten mobile phones.

- ▶ Select **Remote Parking Assist**.
- ▶ Select **Authorise a new device**.
Remote Parking Assist is ready to connect.
- ▶ Start the Remote Parking Assist App and additionally start the authorisation process.
A connection prompt is displayed.
- ▶ Scan the QR code on the central display.
The mobile phone is authorised.

De-authorising mobile phones

- ▶ Select **Remote Parking Assist**.
- ▶ Select **Deauthorise devices**.

- ▶ **To de-authorise a mobile phone:** select a mobile phone.
The mobile phone is deleted from the device list.
- ▶ **To de-authorise all mobile phones:** select **Deauthorise all devices**.
All mobile phones are deleted from the device list.

Manoeuvring assistant

Function of Drive Away Assist

Drive Away Assist can reduce the severity of an impact when pulling away. If the system detects an obstacle in the direction of travel, the vehicle's speed is briefly reduced to approximately 2 km/h. A risk of collision may occur in the following situations, for example:

- If the driver mixes up the accelerator and brake pedals.
- If the driver engages an incorrect gear.
- If the driver depresses the accelerator pedal with too much force.

Drive Away Assist is active under the following conditions:

- If the vehicle was stationary and the transmission position was changed to **R** or **D**.
- If the vehicle has rolled less than approximately 1.0 m since being at a standstill.
- If the detected obstacle is less than approx. 1.0 m away.

The **Drive-away Assist** can be deactivated or activated in the **Manoeuvring assistance** menu (→ page 288).

If a critical situation is detected, the  symbol appears in red in the selected view in the **Camera & parking** menu.

 If Drive Away Assist is not available, the same symbol appears in grey. If the **Camera & parking** menu is not opened in the central display, the symbol and pop-up of Parking Assist PARKTRONIC both appear.

Drive Away Assist is only an aid. It is not a substitute for your attention to the surroundings. The responsibility for safe manoeuvring and parking remains with you. Make sure that no persons, ani-

mals or objects etc. are in the manoeuvring range.

 **WARNING** Risk of accident caused by limited detection performance of Drive Away Assist

Drive Away Assist cannot always clearly identify objects and traffic situations.

- ▶ Always pay careful attention to the traffic situation; do not rely on Drive Away Assist alone.
- ▶ Be prepared to brake or swerve as necessary, provided the traffic situation permits and that it is safe to take evasive action.

System limits

The system limits of Active Parking Assist apply (→ page 275).

On uphill gradients, the performance of Drive Away Assist is restricted.

If a transport device, e.g. trailer or bicycle carrier, is attached to the hitch and the electrical connec-

tion is correctly established, the drive-away assistance is not available when reversing.

Function of cross traffic warning

The cross traffic warning can warn you of crossing traffic when you are exiting a parking space. The radar sensors in the bumper also monitor the area adjacent to the vehicle.

The cross traffic warning is active under the following conditions:

- **Warning for crossing traffic behind:** the vehicle is driving in reverse at a speed slower than approx. 10 km/h.
- **Warning for crossing traffic ahead:** the vehicle is driving forwards at a speed slower than approx. 10 km/h and the camera image is shown in the central display (→ page 270).

The **Warning for crossing traffic ahead** can be deactivated or activated in the **Manoeuvring assistance** menu.

Depending on the country, the **Warning for crossing traffic behind** can also be deactivated or activated (→ page 288).

If a critical situation is detected, the  symbol appears in red in the selected view in the **Camera & parking** menu.

Warning for crossing traffic behind

- The vehicle can be braked automatically when crossing traffic is detected.
- If the **Camera & parking** menu is not opened and a critical situation is detected, a warning appears in the central display together with the PARKTRONIC Parking Assist pop-up.

Warning for crossing traffic ahead

- If Active Parking Assist is active, the vehicle can be braked automatically when crossing traffic is detected.
- If Active Parking Assist is not active but the **Camera & parking** menu is opened, a warning appears.
- If the **Camera & parking** menu is not opened, the system cannot react to crossing traffic.

The cross traffic warning is only an aid and not a substitute for your attention to the surroundings. The responsibility for safe manoeuvring and park-

ing remains with you. Make sure that no persons, animals or objects etc. are in the manoeuvring range.

 **WARNING** Risk of accident caused by limited detection performance of the cross traffic warning

The cross traffic warning cannot always clearly identify objects and traffic situations.

- ▶ Always pay careful attention to the traffic situation; do not rely on the cross traffic warning alone.
- ▶ Be prepared to brake or swerve as necessary, provided the traffic situation permits and that it is safe to take evasive action.

System limits

- ⓘ If the cross traffic warning is not available, the  symbol appears in grey.

The system limits of Active Parking Assist apply (→ page 275).

If the radar sensors are obstructed by vehicles or other objects, detection is not possible.

In the following situations, the cross traffic warning is not available:

- on inclines
- **Warning for crossing traffic behind:** if a transport device, e.g. trailer or bicycle carrier, is attached to the hitch and the electrical connection is correctly established.

Manoeuvring brake function

The manoeuvring brake function can prevent collisions with pedestrians when the vehicle is reversing at slow speeds. If the reversing camera detects a person in the vehicle path, the vehicle can be braked to a standstill.

The manoeuvring brake function can intervene under the following conditions:

- The vehicle is reversing at a speed slower than 10 km/h.
- The camera image is shown in the central display (→ page 270).

If the manoeuvring brake function is triggered, the symbol appears  in red in the selected view in the menu **Camera & parking**.



-  If the manoeuvring brake function is not available, the same symbol appears in grey.

The manoeuvring brake function is only an aid. It is not a substitute for your attention to the surroundings. The responsibility for safe manoeuvring and parking remains with you. Make sure that no persons, animals or objects etc. are in the manoeuvring range.

 **WARNING** Risk of accident caused by limited detection by the manoeuvring brake function

The manoeuvring brake function cannot always clearly detect people. Other obstacles are not detected by the function.

In these cases, the function may brake unnecessarily or not brake at all.

-  Always pay careful attention to the traffic situation; do not rely on the manoeuvring brake function alone.
-  Be ready to brake.

System limits

Observe the system limits of the following functions:

- Active Parking Assist (→ page 275)
- 360° Camera (→ page 265)

The manoeuvring brake function is not available in the following situations:

- on inclines
- If transport equipment, foreexample a trailer or bicycle rack, is attached to the trailer hitch and the electrical connection has been correctly established.

Activating/deactivating manoeuvring assistance

Multimedia system:

  **Settings**  **Assistance**

 **Parking**

-  This function is an on-demand feature (→ page 25).

-  Select **Manoeuvring assistance**.

-  Activate or deactivate the desired manoeuvring assistance.

Memory Parking Assist

Function of Memory Parking Assist

Memory Parking Assist can park your vehicle using a previously stored parking space. You can store parking procedures with a total distance of up to 500 m (100 m per parking or exiting procedure).

During parking or exiting, the system can travel a previously stored path of up to approximately 100 m to or out of the desired parking space, for example, from the driveway entrance into the garage.

Within a radius of approx. 150 m, only one parking or exiting procedure can be recorded.

Only use Memory Parking Assist on private property. Use on public roads, e. g. in public parking spaces, is not permitted.

Memory Parking Assist is only an aid. It is not a substitute for your attention to the surroundings. The responsibility for safe manoeuvring and park-

ing remains with you. Make sure that no persons, animals or objects etc. are in the manoeuvring range.

System limits

Observe the system limitations of Active Parking Assist (→ page 275).

⚠ WARNING Risk of accident due to objects located above or below the detection range of Memory Parking Assist

If there are objects above or below the detection range, the following situations may arise:

- Memory Parking Assist may steer too early.
- The vehicle may not stop in front of these objects.

This result in a collision.

- ▶ In these situations, do not use Memory Parking Assist.

Objects located above or below the detection range of Memory Parking Assist may not be detected during the parking procedure.

Drawbars of parked trailers, among other objects, that protrude into the parking space may not be detected.

Do not use Memory Parking Assist in the following situations, for example:

- In extreme weather conditions such as ice, packed snow or in heavy rain.
- When transporting a load that protrudes beyond the vehicle.
- If the parking space is on a steep downhill or uphill gradient.
- When snow chains are fitted.

You can watch an animation on this topic via the following link:

■ Recording a parking procedure using Memory Parking Assist

Requirements

- The entire route is, for example, within your own property and not on public roads.
- The system needs reference points in the surroundings to orient itself, such as fences, walls or trees. Therefore, after starting the vehicle, a

certain distance must first be driven. If not enough reference points are detected in the surrounding area, no new route can be recorded.

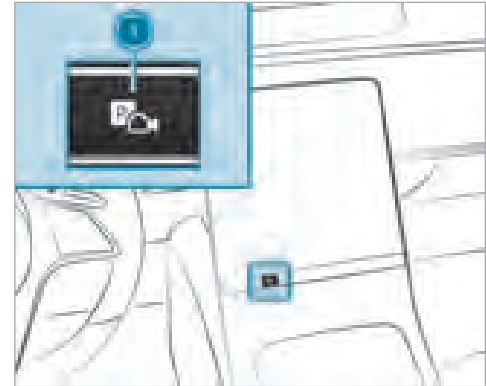

- ▶ Press button ①. The **Camera & parking** view opens in the central display.



- ▶ Select ② **Memory Parking Assist** menu.
 - ▶ Brake the vehicle to a standstill at the desired starting point of the assisted parking procedure, e.g. a driveway entrance.
 - ▶ **Start recording:** Tap ③.
- ⓘ If not all conditions for a recording are met, symbol ③ is greyed out.

- ▶ Park the vehicle in the desired parking space. Do not exceed 8 km/h.
 - ▶ **End recording:** Stop the vehicle and tap ③ again. The recording is stored.
- ⓘ In the Memory Parking Assist settings you can delete and rename stored parking procedures.

■ Parking with Memory Parking Assist

Requirements:

- A parking procedure has been recorded.

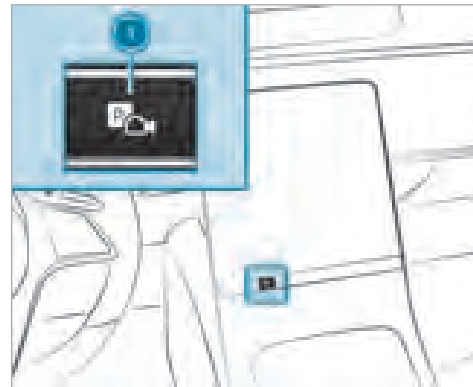

- ▶ Press button ①. The **Camera & parking** view opens in the central display.



- ▶ Select **Memory Parking Assist** ② menu.
- ▶ Brake the vehicle to a standstill at the starting point of the stored parking procedure.
- ▶ **To start the parking procedure:** press .
- ▶ Select the stored parking procedure from the list.

- ▶ Follow the instructions on the central display. The vehicle drives into the selected parking space.

i The turn signal indicator is not switched on automatically. You are responsible for selecting the turn signal indicator in accordance with the traffic conditions.

- ▶ After completion of the parking procedure, safeguard the vehicle against rolling away.

Exiting a parking space with Memory Parking Assist

Requirements:

- The exiting procedure was recorded together with the respective parking procedure and stored separately within one driving cycle.
- The vehicle was parked using Memory Parking Assist.

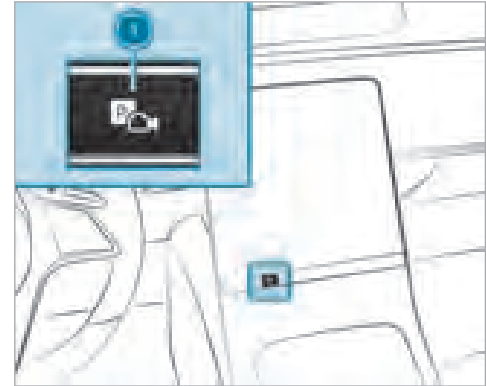

- ▶ Press button ①. The **Camera & parking** view opens in the central display.



- ▶ Select **Memory Parking Assist** ② menu.

Starting the exiting procedure

- ▶ Press .
- ▶ Confirm the saved exiting procedure.
- ▶ Follow the instructions on the central display. The vehicle drives the recorded route.

- ① The turn signal indicator is not switched on automatically. You are responsible for selecting the turn signal indicator in accordance with the traffic conditions.

- ▶ Take control of the vehicle after the exiting procedure has been completed.

Setting Memory Parking Assist

Multimedia system:

- ▶  ▶ Settings ▶ Assistance
- ▶ ▶ Parking ▶ Memory Parking Assist

Renaming a recording

- ▶ Select **Manage lanes**.
- ▶ Select  next to the desired recording.
- ▶ Enter a name and confirm with **OK**.

Deleting a recording

- ▶ Select **Manage lanes**.
- ▶ Select  next to the desired recording.
- ▶ Select **Delete entry**.

Deleting all recordings

- ▶ Select **Manage lanes**.

- ▶  button next to one of the desired recordings.

- ▶ Select **Delete all**.

- ① Alternatively, you can delete all data in Memory Parking Assist by resetting the multimedia system (→ page 362).

Trailer Manoeuvring Assist

Function of Trailer Manoeuvring Assist

- ① This function is an on-demand feature (→ page 25).

⚠ WARNING Risk of accident due to unsuitable trailers

Trailers with a steered axle or a fifth wheel cannot be used with Trailer Manoeuvring Assist.

Due to this, the trailer cannot be manoeuvred in the desired direction and you can cause a collision or the trailer can overturn.

- ▶ Only use Trailer Manoeuvring Assist with trailers with fixed drawbars and axles.

! **NOTE** Damage due to overhanging loads in front or drawbar installations

The vehicle and the trailer may be damaged during manoeuvring due to overhanging loads at the front of the trailer or drawbar installations.

▶ Pay attention to overhanging loads or drawbar installations while manoeuvring.

Trailer Manoeuvring Assist is only an aid. It is not a substitute for your attention to the surroundings. The responsibility for safe manoeuvring and parking remains with you. Make sure that there are no persons, animals or objects in the manoeuvring area while manoeuvring and parking in/exiting parking spaces.

Observe the notes on towing a trailer (→ page 294).

System limits

Observe the system limits of the following functions:

- Active Parking Assist (→ page 275)
- 360° Camera (→ page 265)

- Reversing camera (→ page 263)

The system may be impaired or may not function in the following situations:

- The gradient is greater than approximately 15 %.

Using Trailer Manoeuvring Assist

Requirements

- The vehicle has been started and is stationary.
- A trailer has been detected.
- The gradient is less than approximately 15 %.
- The boot lid is closed.
- The electric parking brake is not applied.
- The driver's seat belt is fastened.

Using Trailer Manoeuvring Assist

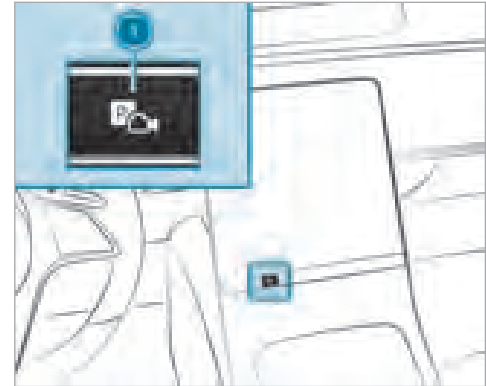

- ▶ Engage reverse **R** gear.
- ▶ Press button **1**.
The camera image is shown in the central display.

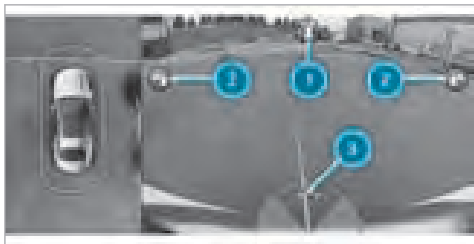

i The picture is exemplary and shown without trailer.

You can select various manoeuvres in the Trailer Manoeuvring Assist menu. The manoeuvres available depend on the current articulation angle and length of the trailer.

▶ To adjust the articulation angle: select **3**. In the central display, swipe the entire area of the camera image to the left or right to change the bend angle.

or

▶ To activate the straightening manoeuvre: select **1**.
The system calculates the articulation angle in such a way that the direction of the trailer at the time of activation is maintained. There is a short countersteering movement of the trailer while the vehicle is reversed, which then guides it back to the desired line. In this way, the vehicle is aligned straight with the trailer and, at the same time, the direction of the trailer is maintained.

or

▶ To activate the 90° manoeuvre:

- Align the vehicle in the same direction (line) as the trailer.
- Select (left or right) **2**.

The system calculates the articulation angle so that the trailer can be manoeuvred into a space perpendicular to the vehicle using the smallest possible angle. After the manoeuvre, the vehicle is aligned again in the direction of the trailer.

▶ Accelerate and brake as required.

- i** The maximum articulation angle depends on the length of the trailer. This is calculated by the system by driving the vehicle forwards, including cornering. Before the length of the trailer has been calculated, the maximum articulation angle is approximately 23°. The longer the trailer is, the higher the maximum articulation angle (max. approximately 60°).
- i** Pay attention to your surroundings and be ready to brake at all times.

Trailer hitch

Notes on trailer operation

! **NOTE** The operating permit may be invalidated due to the illegal installation of trailer hitches

The installation – including retrofitting – of a non-folding or non-removable trailer hitch that even partially conceals the license plate or the lighting system is prohibited.

▶ Observe the applicable legal regulations for the installation of trailer hitches.

⚠ WARNING Risk of accident due to car/trailer combination swerving

If you drive too fast in trailer operation, the car/trailer combination may start to swerve. This could cause you to lose control of the car/trailer combination. The car/trailer combination may even overturn.

- ▶ Under no circumstances should you try to straighten the car/trailer combination by increasing your speed.
- ▶ Reduce the speed and do not counter-steer.
- ▶ Brake if necessary.

! NOTE Damage to the engine due to overheating

- ▶ If you have a trailer hitch retrofitted, modifications to the engine cooling system may be necessary depending on the vehicle type.

If you have a trailer tow hitch retrofitted, observe the fastening points on the vehicle frame.

Retrofitting a trailer hitch is permissible only if a trailer load is specified in your vehicle documents. If this is not the case, the vehicle is not approved for trailer operation.

Further information can be obtained at a qualified specialist workshop.

Observe the following notes on the tongue weight:

- Do not use a tongue weight that exceeds or falls below the permissible tongue weight
- Use a tongue weight as close as possible to the maximum tongue weight

Do not exceed the following values:

- Permissible towing capacity
- Permissible rear axle load of the towing vehicle
- Permissible gross weight of the towing vehicle
- Permissible gross weight of the trailer
- Maximum permissible speed of the trailer

Ensure the following before starting a journey:

- The tyre pressure on the rear axle of the towing vehicle is set for a maximum load
- The lighting of the connected trailer is operational

In the event of increased rear axle load, the car/trailer combination must not exceed a maximum speed of 100 km/h for reasons concerning the operating permit. This also applies in countries in which the permissible maximum speed for car/trailer combinations is above 100 km/h.

- ⓘ When you are reversing with a trailer, remember to use the Trailer Manoeuvring Assist function (→ page 292).

Extending and retracting the ball neck fully electrically

⚠ WARNING Risk of accident due to the ball neck not being engaged

If the ball neck is not engaged, the trailer may come loose.

- ▶ Make sure that the ball neck securely engages and locks into place.

- ! **NOTE** Damage to the all-electric trailer hitch due to additional pressure

The all-electric trailer hitch could be mechanically damaged by applying additional pressure when the ball neck is being extended or retracted.

- ▶ Do not make the ball neck extend/retract faster by applying additional pressure.

- ! **NOTE** Increased risk of damage to property due to folded-out ball neck

- ▶ When the trailer is not coupled or the bicycle rack is attached, fold in the ball neck or, in the case of a fully electric trailer hitch, retract the ball neck.

- ! **NOTE** Damage to the vehicle due to incorrect use of the trailer hitch

If a trailer hitch is used to recover the vehicle, the vehicle or the trailer hitch itself may be damaged in the process.

- ▶ Use the trailer hitch only for pulling a trailer or attaching approved carrier systems (e.g. a bicycle rack).

Exception: Since vehicles with a trailer hitch do not have a fixture for a towing eye at the rear, towing or tow-starting is permitted.

- ▶ When towing or tow-starting with the trailer hitch, observe the information in the section "Fitting and removing the towing eye."

Extending the ball neck fully electrically

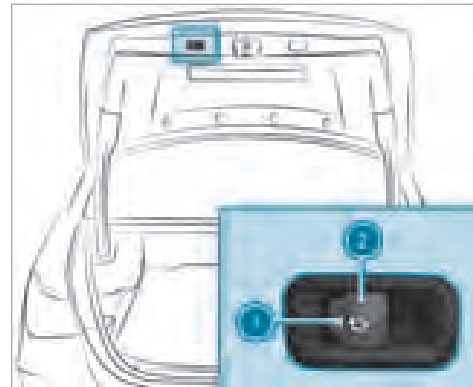

- ▶ Secure the vehicle against rolling away.
 - ▶ Keep the swivel range clear.
 - ▶ Pull button ②.
- Indicator lamp ① will flash and a message reading **Trailer coupling in motion** will appear on the driver's display.
- The ball neck will extend fully electrically.

- ▶ Wait until the ball neck has reached the swung-out position with a clear locking noise. When indicator lamp ❶ is continuously lit, the ball neck is securely locked in place.

If the ball neck is not securely locked in place, indicator lamp ❶ will flash and a message reading **Trailer coupling Check lock** will appear on the driver's display.

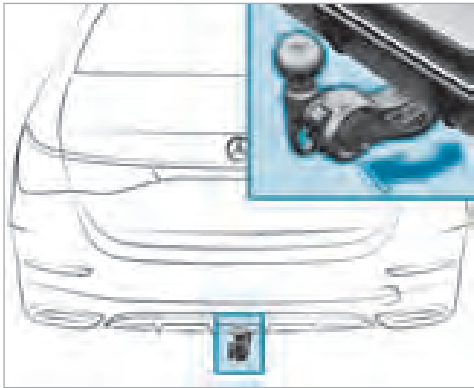

Retracting the ball neck fully electrically

- ▶ Remove the trailer cable or adapter plug.
 - ▶ Pull button ❷.
- Indicator lamp ❶ will flash and a message reading **Trailer coupling in motion** will appear on the driver's display.
- The ball neck will retract fully electrically.
- ▶ Wait until the ball neck has reached the swung-in locked position. When indicator lamp ❶ goes out, the ball neck is securely locked in place.
- If the ball neck is not securely locked in place, indicator lamp ❶ will flash and a message reading **Trailer coupling Check lock** will appear on the driver's display.

Observe the information about the displays on the driver's display:

- Indicator and warning lamps (→ page 729)
- Display messages (→ page 644)

Coupling up/uncoupling a trailer

⚠ WARNING Risk of injury due to a change in vehicle level

Vehicles with AIRMATIC: the vehicle level may be changed unintentionally, e.g. by other persons. If you couple or uncouple the trailer during this time, you may become trapped. In addition, other people could become trapped if their limbs are between the vehicle body and the tyres or underneath the vehicle.

Observe the following when coupling or uncoupling:

- ▶ Do not open or close any doors or the boot lid.
- ▶ Do not initiate the level control system and do not operate the DYNAMIC SELECT switch.
- ▶ Do not lock or unlock the vehicle.

The trailer will be correctly detected by the vehicle only if the following conditions are met:

- The ball neck is extended and engaged in a securely locked position.

- **Vehicles with AIRMATIC:** ensure the vehicle is at the normal level (→ page 262).

Use the normal level in trailer operation. Off-road-level driving is not permitted in trailer operation on public roads.

- A trailer is selected in the **Vehicle** menu (→ page 300).

Trailers with a 7-pin plug can be connected to the vehicle with the following adapters:

- Adapter plug
- Adapter cable

The trailer will be correctly detected by the vehicle only if the following conditions are met:

- The trailer is connected correctly.
- The trailer lighting system is in working order.

A correctly connected trailer influences, among other things, the functions of the following systems:

- ESP® trailer stabilisation
- Trailer Manoeuvring Assist
- Active Lane Keeping Assist

- Parking Assist PARKTRONIC
- Active Parking Assist
- Blind Spot Assist or Active Blind Spot Assist
- Drive Away Assist
- Cross traffic warning
- Manoeuvring brake function
- Reversing camera
- 360° camera
- AIRMATIC

Coupling up a trailer

! **NOTE** Damage to the starter battery due to full discharge

Charging the trailer battery using the power supply of the trailer can damage the starter battery.

▶ Do not use the vehicle's power supply to charge the trailer battery.

- ▶ Secure the vehicle against rolling away.

- ▶ Remove the cover cap from the ball head and store it in a safe place.
- ▶ Position the trailer on a level surface behind the vehicle and couple it up to the vehicle.

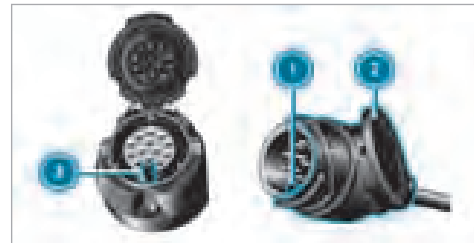

- ▶ Open the socket cap.
- ▶ Insert the plug with lug ① into groove ③ on the socket.
- ▶ Turn bayonet coupling ② to the right as far as it will go.
- ▶ Let the cap engage.
- ▶ Secure the cable to the trailer with cable ties (only if you are using an adapter cable).

- ▶ Make sure that the cable is always slack for ease of movement during cornering.

In the following circumstances, a message may appear on the driver's display even if the trailer has been connected correctly:

- LEDs have been installed in the trailer lighting system.
 - The current has fallen below the trailer lighting system's minimum current (50 mA).
- ⓘ Accessories can be connected to the permanent power supply up to 180 W and to the power supply that is switched on via the ignition lock.

Uncoupling a trailer

- ⚠ WARNING** Risk of being crushed and becoming trapped when uncoupling a trailer

When uncoupling a trailer with an engaged inertia-activated brake, your hand may become trapped between the vehicle and the trailer drawbar.

- ▶ Do not uncouple trailers with an engaged overrun brake.

- ⚠ NOTE** Damage during uncoupling with an engaged overrun brake

The vehicle may be damaged if you uncouple with an engaged overrun brake.

- ▶ Do not uncouple trailers with an engaged overrun brake.

- ⚠ WARNING** Risk of becoming trapped when disconnecting the trailer cable

Vehicles with AIRMATIC: the vehicle may lower when you disconnect the trailer cable.

This could result in other people becoming trapped if their limbs are between the vehicle body and the tyres or underneath the vehicle.

- ▶ Make sure nobody is underneath the vehicle or in the immediate vicinity of the wheel arches when you disconnect the trailer cable.

- ⚠ NOTE** Damage to the rear bumper from installing adapter cables or adapter plugs

The following parts could be damaged when swiveling the ball neck fully electrically:

- Bumper
 - Adapter cable
 - Adapter plug
- ▶ Always remove the adapter cable or adapter plug before swiveling the ball neck fully electrically.

- ▶ Secure the trailer against rolling away.
 - ▶ Disconnect the electrical connection between the vehicle and the trailer.
 - ▶ Uncouple the trailer.
 - ▶ Place the cover cap on the ball head.
- ⓘ **Trailers with LED lighting:** after uncoupling the trailer, switch the vehicle on and then off again.

Adjusting settings for trailer operation

Multimedia system:

Settings >> Vehicle >> Driving >> Trailer settings

Making settings for a trailer

The settings in this menu enable the calculation of a route suitable for the selected trailer and optimise the calculated arrival time.

- ▶ Select the desired trailer type.
- ▶ Enter the maximum permissible speed of the selected trailer.
- ▶ **To save changes:** select **Confirm**.

Bicycle rack function

⚠ WARNING Risk of an accident if the bicycle rack is used incorrectly

The bicycle rack may become detached from the vehicle in the following cases:

- the permissible load capacity of the trailer hitch is exceeded.
- the bicycle rack is used incorrectly.
- the bicycle rack is secured to the ball neck beneath the ball head.

Observe the following for your own safety and that of other road users:

- always adhere to the permissible load capacity of the trailer hitch.
- always observe the permissible rear axle load of the towing vehicle.
- use the bicycle rack only to transport bicycles.

- always mount the bicycle rack properly by attaching to the ball head and the ball neck guide pin, if possible.
- when transporting four bicycles, always use bicycle racks that have additional support on the ball neck guide pin.
- use only bicycle racks approved by Mercedes-Benz.
- always observe the bicycle rack operating instructions.

⚠ NOTE Damage to or breakage of the trailer hitch due to unsuitable or improperly used bicycle rack.

▶ Only use bicycle racks approved by Mercedes-Benz properly as described below.

⚠ NOTE Increased risk of damage to property due to folded-out ball neck

▶ When the trailer is not coupled or the bicycle rack is attached, fold in the ball

neck or, in the case of a fully electric trailer hitch, retract the ball neck.

! **NOTE** The operating permit may be invalidated due to the illegal installation of trailer hitches

The installation – including retrofitting – of a non-folding or non-removable trailer hitch that even partially conceals the license plate or the lighting system is prohibited.

► Observe the applicable legal regulations for the installation of trailer hitches.

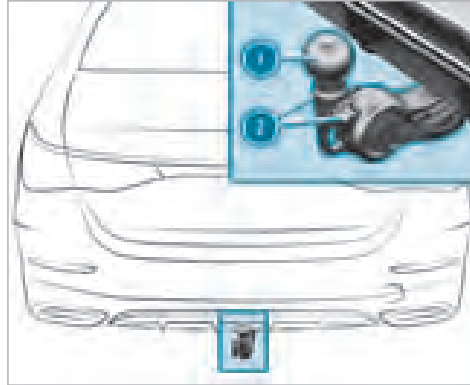

Trailer hitch with additional guide pin

Depending on the bicycle rack's design, different numbers of bicycles can be transported.

The following bicycle rack designs are possible:

- When mounted by attaching to ball head ①, the maximum load capacity is 75 kg. You can transport up to three bicycles.

- When mounted on ball head ① and guide pin ②, the maximum load capacity is 100 kg. You can transport up to four bicycles.

The maximum load capacity is calculated from the weight of the bicycle rack and the bicycle rack load.

Observe the notes on driving with a roof load, trailer or fully laden vehicle (→ page 187).

When using a bicycle rack, set the tyre pressure for increased load on the rear axle of the vehicle. Further information on the tyre pressure can be found in the tyre pressure table (→ page 511).

Notes on loading

The larger the distance between the load's centre of gravity and the ball head, the greater the load on the trailer hitch.

Observe the following notes:

- mount heavy bicycles as close to the vehicle as possible
- always distribute the load on the bicycle rack as evenly as possible across the vehicle's longitudinal axis

Mercedes-Benz recommends removing all detachable parts from bicycles (e.g. baskets, child seats, rechargeable batteries) before loading them onto the bicycle rack. This will improve the aerodynamic resistance and centre of gravity of the bicycle rack.

Always secure the bicycles to prevent them from moving around and check them at regular intervals to ensure that they are secure.

Do not use tarpaulins or other covers. The driving characteristics and rear view may be impaired. In addition, aerodynamic resistance and the load on the trailer hitch will increase.

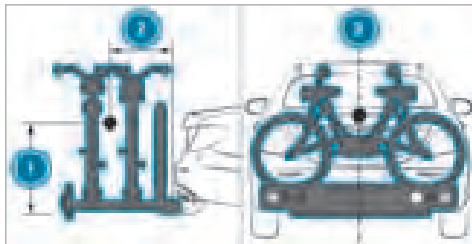

Load distribution on the bicycle rack

- ① Vertical distance between centre of gravity and ball head
- ② Horizontal distance between centre of gravity and ball head
- ③ The centre of gravity is on the vehicle's centre axis.

Observe the following information when loading the bicycle rack:

Loading the bicycle rack

	3 bicycles	4 bicycles
Total weight of bicycle rack and load	Up to 75 kg	Up to 100 kg
Max. distance ①	420 mm	420 mm
Max. distance ②	300 mm	400 mm

When transporting four bicycles or a total weight between 75 kg and 100 kg, always use bicycle racks with additional support on both trailer hitch guide pins.

Vehicle towing instructions

The vehicle is not suitable for the use of tow bar systems that are used for flat towing or dinghy towing, for example. Attaching and using tow bar systems may result in damage to the vehicle. When you are towing a vehicle with tow bar systems, safe driving characteristics cannot be guar-

anteed for the towing vehicle or the towed vehicle.
The vehicle-trailer combination may swerve from side to side.

Observe the following information:

- Permitted towing methods (→ page 498)
- The notes on towing the vehicle with both axles on the ground (→ page 499)

Notes on the driver's display

⚠ WARNING Risk of accident if the driver display fails

If the driver display has failed or is malfunctioning, function restrictions in systems relevant to safety cannot be detected.

The operating safety of your vehicle may be impaired.

- ▶ Drive on carefully.
- ▶ Have the vehicle checked immediately at a qualified specialist workshop.

If the operating safety of your vehicle is impaired, park the vehicle immediately and safely. Contact a qualified specialist workshop.

The driver's display shows basic information such as speed, engine speed, fuel level, coolant temperature as well as indicator and warning lamps.

The driver's display shows the following basic information:

- Speed and power meter level

- Range according to average consumption, personal driving style or high-consumption driving style
- State of charge of the high-voltage battery
- Indicator and warning lamps

Additional functions available include the following:

- Different menus, e.g. for assistance and navigation
- Status displays for the driving systems
- Display messages
- Information on speed, **Consumption** and range

Some menu content and settings can be customised (→ page 307).

Notes on the 3D driver display

⚠ WARNING Risk of accident if the driver display fails

If the driver display has failed or is malfunctioning, function restrictions in systems relevant to safety cannot be detected.

The operating safety of your vehicle may be impaired.

- ▶ Drive on carefully.
- ▶ Have the vehicle checked immediately at a qualified specialist workshop.

If the operating safety of your vehicle is impaired, park the vehicle immediately and safely. Contact a qualified specialist workshop.

The 3D driver's display enables a three-dimensional representation of the content of the driver's display. This requires the driver to be recorded by the driver camera.

The system may be impaired or may not function in the following situations:

- The driver camera is deactivated or is not working.
- The driver is outside the detection range of the driver camera.
- The operating conditions are not in place, e.g. if the outside temperature is too low or too high.

Operating the driver's display

⚠ WARNING Risk of distraction from information systems and communications equipment

If you operate information systems and communication devices integrated in the vehicle when driving, you could be distracted from the traffic situation. This could also cause you to lose control of the vehicle.

- ▶ Only operate this equipment when the traffic situation permits.

▶ If you cannot be sure of this, stop the vehicle whilst paying attention to road and traffic conditions and operate the equipment with the vehicle stationary.

Observe the legal requirements for the country in which you are currently driving when operating the driver's display.

Scrolling on the menu bar

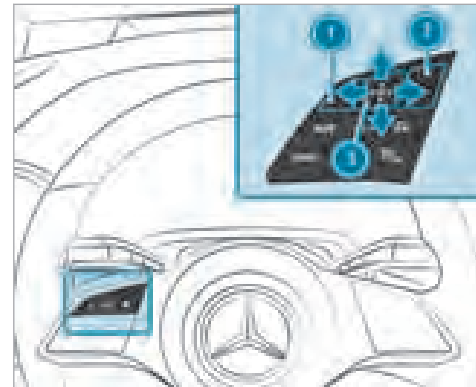

- ① Back button
- ② Main menu button
- ③ Touch Control

The content on the driver's display is controlled using the control elements on the left side of the steering wheel. You can use Touch Control ③ to navigate vertically and horizontally by swiping with

one finger. Confirm your selection by pressing the Touch Control.

i To operate Touch Control **3** in the most effective way, use the tip of your thumb if possible. You can also set the sensitivity of the Touch Control on the central display (→ page 333).

▶ Briefly press main menu button **2**.

▶ Select a menu by swiping to the left or right on Touch Control **3**.

▶ **To confirm:** press Touch Control **3**.

You can watch an animation on this topic via the following link:

Driver display menus

Notes on menus on the driver's display

! **WARNING** Risk of distraction from information systems and communications equipment

If you operate information systems and communication devices integrated in the vehicle when driving, you could be distracted from the traffic situation. This could also cause you to lose control of the vehicle.

▶ Only operate this equipment when the traffic situation permits.

▶ If you cannot be sure of this, stop the vehicle whilst paying attention to road and traffic conditions and operate the equipment with the vehicle stationary.

Observe the legal requirements for the country in which you are currently driving when operating the driver's display.

The following menus can be called up via the menu bar on the driver's display:

- [Classic](#)
- [Exclusive](#)
- [Sport](#)
- [Navigation](#)
- [Assistance](#)
- [Service](#)

On some of these menus, you can choose between different display content on the centre display area.

On most of the menus, you can use [Options](#) to configure further settings for the menu-specific display content.

You can watch an animation on this topic via the following link:

Calling up and operating menus on the driver's display

Calling up a menu via the driver's display menu bar

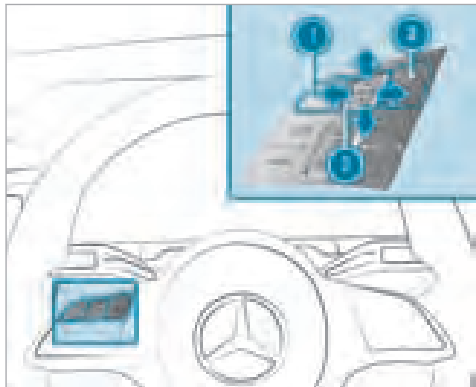

- ① Back button
- ② Main menu button
- ③ Touch Control

- ▶ Press main menu button ② on the steering wheel.
The driver's display menu bar will open.



- ▶ Swipe to the left or right on left-hand Touch Control ③ and select a menu (e.g. the **Classic** menu) on the menu bar.
- ▶ **To confirm:** press left-hand Touch Control ③.

Calling up or exiting the **Options** submenu

- ▶ **To call up:** press left-hand Touch Control ③.
- ▶ **To exit:** press back button ①.

Browsing through display content or lists

- ▶ Swipe up, down, left or right on left-hand Touch Control ③.

- ① Within different menus, icons will also appear at the right edge of the centre display section to indicate the current position on a list.

Setting display content as the standard display

You can set custom-configured menu display content as the standard display.

- ▶ Press and hold left-hand Touch Control ③ until the bar display that appears is completely filled.
The **Set direct entry?** prompt will appear.
- ▶ Swipe left on left-hand Touch Control ③ and select **Yes**.
- ▶ **To confirm:** press left-hand Touch Control ③.
- ▶ **To call up standard displays:** press back button ① on the upper level of a menu.
- ① Pressing back button ① on the standard display will call up the previous menu.

Resetting values

- ▶ To call up the **Options submenu**: press left-hand Touch Control ③.
- ▶ Select **Yes**.
- ▶ To confirm: press left-hand Touch Control ③.

Configuring settings on the Classic or Exclusive menus

Driver's display:

↳ Classic

Selecting display content in the centre display area of the Classic and Exclusive menus

- ▶ Call up the **Classic** or **Exclusive** menu via the driver's display menu bar.
- ▶ To select display content: swipe upwards or downwards on the left-hand Touch Control and select the desired display content.

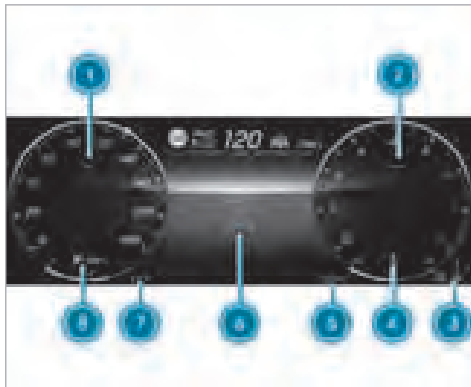

Vehicles with combustion engines

- ① Speedometer
- ② Rev counter
- ③ Transmission position
- ④ Coolant temperature display
- ⑤ Outside temperature
- ⑥ Display content, centre on the **Classic** menu (example: trip distance)

- ⑦ Time
- ⑧ Fuel level and fuel filler flap location indicator

The following content can be shown in centre display area ⑥ of the **Classic** and **Exclusive** menus:

- Trip and total distance
 - Trip computer **From start** and **From reset**
 - ECO display
 - Consumption
 - ATTENTION ASSIST
 - Audio
 - Navigation
- ⓘ If navigation is selected as the display content in the centre display area, navigation instructions that vary depending on the driving situation will appear.
- ⓘ If you have selected display content in the centre display area of the **Classic** or **Exclusive** menus and switch to the other menu, the selected display content will also be transferred.

Changing the radio station or track on the station or track list

You can select radio stations or tracks on the station or track list in the audio display content of the **Classic** and **Exclusive** menus.

The following adjustments can be made in the MBUX multimedia system:

- Configuring the station or track list
- Switching between media sources
- Setting the frequency band

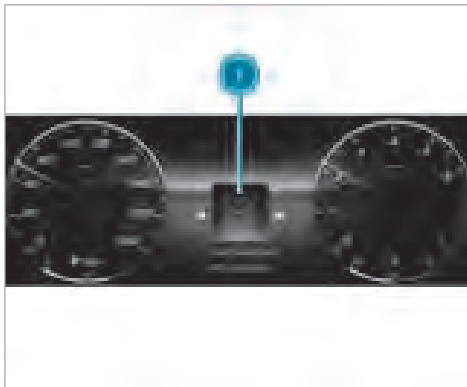

Track list for the audio display content in the centre display area (example)

- ▶ **To change radio stations or tracks:** swipe left or right on the left-hand Touch Control and select a radio station or track on station or track list ①.

- ① The radio station or track displayed when the vehicle is restarted depends on the user profile used for the previous trip.

The following functions may be available on the **Options** submenu, for example:

- Navigation: selecting and adjusting zoom, route guidance and map settings
- Resetting the trip odometer
- Resetting the trip computer **From start**
- Resetting the trip computer **From reset**
- Resetting the ECO display values

Calling up the Service menu

Driver's display:



The current status of the vehicle is shown on the **Service** menu.

- ▶ **To call up the menu:** press the left-hand Touch Control.

The following display content is available on the **Service** menu (equipment-dependent):

- Information about how many messages are in the message memory
- **AdBlue:** AdBlue® range and fill level
- **Tyre pressure:**
 - Restarting the tyre pressure loss warning system (→ page 514)
 - Checking the tyre pressure with the tyre pressure monitoring system (→ page 512)
 - Restarting the tyre pressure monitoring system (→ page 513)
- **ASSYST PLUS:** calling up the service due date (→ page 468)
- **Engine oil level:** checking the engine oil level (→ page 473)
- Coolant indicator

The following functions are available on the **Options** submenu:

- Tyre pressure (→ page 512)
- Message memory (→ page 644)

Calling up the assistant display on the Assistance menu

Driver's display:



Various driver assistance systems and navigation instructions are displayed on the **Assistance** menu.

To call up the menu: press the left-hand Touch Control.

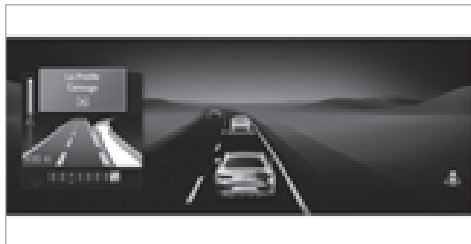

Active Distance Assist DISTRONIC display on the assistant display (example)

In vehicles with the Driving Assistance Plus Package, the following displays may vary depending on the driving situation:

- The navigation instructions in the left-hand display section
- The traffic light view in the right-hand display section
- The display of the driver assistance systems
- The level of detail on the assistant display

In vehicles without the Driving Assistance Plus Package, your lane and the vehicle in front will be displayed.

The following status displays are available on the assistant display:

- Green: pedestrian detection active
- Grey: pedestrian detection enabled
- Green radar waves next to vehicle: Blind Spot Assist or Active Blind Spot Assist enabled and ready for operation
- Grey radar waves next to vehicle: Blind Spot Assist or Active Blind Spot Assist enabled but not ready for operation

The content on the assistant display will adapt to the following situations:

- Number of lanes detected
 - Change of direction, e.g. lane change
 - Current road conditions
 - Road users detected
- ① The assistant display does not display other detected obstacles with the exception of road users.

The following functions are available on the **Options** submenu:

- Starting route guidance
- With active route guidance: end route guidance
- Call up previous destinations and favourites
- Start new route guidance to a recent destination
- Start new route guidance to a favourite

Calling up displays on the Sport menu

Driver's display:



The **Sport** menu provides information about the engine data of the vehicle.

- ① When you call up the **Sport** menu on the menu bar of the driver's display, the menu colour setting will automatically be applied to the MBUX multimedia system.

▶ **To call up the menu:** press the left-hand Touch Control.



- ① Current torque
② G-meter

- ③ Current power output
④ Boost pressure
⑤ Engine oil temperature
⑥ Engine speed

Calling up navigation instructions on the driver's display

Driver's display:



▶ **To call up the menu:** press the left-hand Touch Control.

Changing the scale of the selected map view



- ① Distance to the change of direction
② Road to which the change of direction leads
③ Display of traffic incident
④ Currently selected route

- ⑤ Indicator showing vehicle's current position
 - ⑥ Change-of-direction symbol
 - ⑦ Recommended lane (white)
 - ⑧ Lane not recommended (grey)
 - ⑨ Current lane
- ① The level of detail in the navigation instructions in the left-hand display section may vary.

▶ **To zoom in and out on the map directly:** swipe upwards or downwards on the left-hand Touch Control.

- ① If no operation is performed within a short time of the autozoom being activated, the set map scale of the map view already selected will appear.
- You can set the permanent map scale display in the MBUX multimedia system (→ page 402).

The following functions are available on the **Options** submenu:

- With active route guidance: end route guidance
- Select route guidance

- Map settings

- ① If the current route guidance is ended on the **Navigation** menu of the driver's display, it will also be ended in the MBUX multimedia system.

On the **Options** submenu, you can use other functions in the **Destinations** and **Map settings** categories.

You can use the following functions in the **Destinations** category:

- Call up previous destinations and favourites
- Start new route guidance to a favourite

- ① The two options **Work** and **Home** will be displayed in **Favourites** even if no address is stored.

You can use the following functions in the **Map settings** category:

- Activate auto zoom
- Set the map view, satellite view and route overview.

The following map views are available on the **Navigation** menu:

- Entire route
- 2D direction of travel
- 2D north-up
- 3D map

- ① There is an additional navigation view on the front passenger display. The front passenger can thus assist the driver with route guidance (→ page 390).

Head-up display

Function of the head-up display

The head-up display projects various content into the driver's field of vision, for example.

You can use the head-up display menu bar to select various contexts, e.g.:

- Minimal
- Sport
- Standard
- ECO display (→ page 192)

- Settings
- Head-up display on/off

Head-up display content with navigation (9x3°)

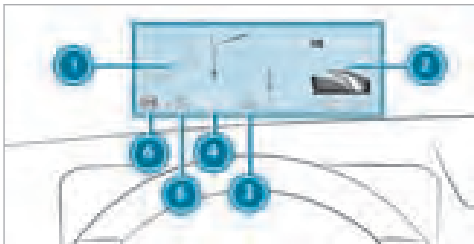

- 1 Navigation instructions
- 2 Navigation instructions (distance to the next route event)
- 3 Steer Assist status
- 4 Current speed
- 5 Set speed in the driving system (e.g. cruise control)
- 6 Detected traffic signs (Traffic Sign Assist)

When you receive a call, the  **Call waiting** message will appear on the head-up display and the driver's display.

System limits

Visibility is particularly influenced by the following conditions:

- Seat position
- Image position setting
- Light conditions
- Wet road surfaces
- Objects on the display cover
- Polarisation in sunglasses

Operating the head-up display

Selecting display content of the head-up display via the menu bar of the driver's display

- ▶ Press the main menu button  on the left.
- ▶ **To select the menu bar of the head-up display:** swipe upwards on the left-hand Touch Control.





Switching between display content on the head-up display

- ▶ Swipe to the left or right on the left-hand Touch Control. A preview of the selected display content will appear on the head-up display.
- ▶ **To confirm:** press the  button.

Switching back to the driver's display

- ▶ Press the  or  button.

Setting the position and brightness

- ▶ Swipe to the left or right on the left-hand Touch Control and select **Settings** on the menu bar of the head-up display.
- ▶ Press the left-hand Touch Control. The current position and brightness settings will be displayed as graphics on the head-up display as well as on the driver's display.
- ▶ **To adjust the position:** swipe upwards or downwards on the left-hand Touch Control.
- ▶ **To adjust the brightness:** swipe to the left or right on the left-hand Touch Control. The settings configured for position and brightness will be saved automatically.
- ▶ Press the  or  button to exit the settings.

Switching the head-up display on/off

Driver's display:



Switching on

- ▶ Swipe upwards on the left-hand Touch Control.
- ▶ Press  on the left-hand Touch Control.

Switching off

- ▶ Swipe upwards on the left-hand Touch Control.
- ▶ Swipe on the left-hand Touch Control and select **Head-up display**.
- ▶ Press  on the left-hand Touch Control.

Vehicles with a 48 V on-board electrical system

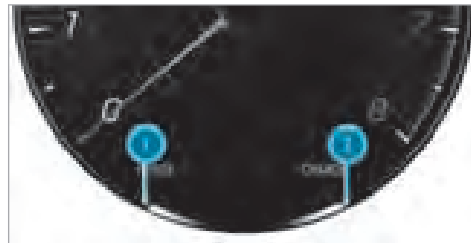







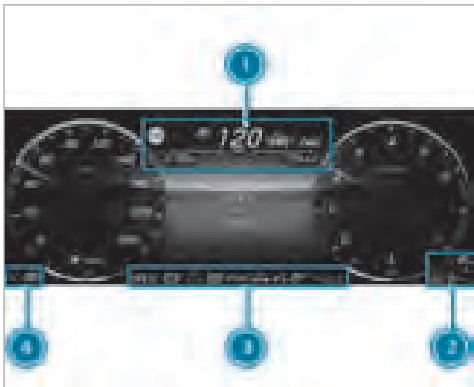











- ① Electric drive support
- ② Recuperation behaviour of the electric motor
- ⓘ Due to various system limits, the values displayed may temporarily differ slightly from the actual value.



Overview of status displays on the driver's display

The status displays for the driving and driving safety systems can be found in display sections ① to ④.



-  Pedestrian detection (only on assistant display)
-  Active Parking Assist is available (→ page 277)
-  Active Parking Assist has recognised a parking space (→ page 277)
-  Parking Assist PARKTRONIC deactivated (→ page 274)

-  Cruise control (→ page 224)
-  **LIM** Limiter (→ page 225)
-  Active Distance Assist DISTRONIC (→ page 228)
-  Specified distance for Active Distance Assist DISTRONIC (→ page 228)
-  Active Brake Assist switched off (→ page 248)
-  Active Brake Assist impaired or not functioning (→ page 248)
-  Active Steering Assist (→ page 237)
-  Active Lane Change Assist (→ page 241)
-  Active Lane Keeping Assist (→ page 258)
-  Active Blind Spot Assist (only on assistant display) (→ page 257)
-  **(A)** ECO start/stop function (→ page 191)
-  **HOLD** HOLD function (→ page 220)
-  **(A)** Adaptive Highbeam Assist (→ page 155)
-  Adaptive Highbeam Assist Plus (→ page 156)

-  **120 km/h!** Maximum permissible speed exceeded (for certain countries only)
-  Active Stop-and-Go Assist (→ page 236)
-  ***** Slippery road surface warning

Vehicles with Speed Limit Assist: detected instructions and traffic signs (→ page 248)

Vehicles with Traffic Sign Assist: detected instructions and traffic signs (→ page 250)

Notes on operating safety

For your own safety, always observe the following points when operating mobile communications equipment and especially your Voice Assistant:

- Observe the legal requirements for the country in which you are driving.
- If you use the Voice Assistant in an emergency your voice can change and your telephone call, e.g. an emergency call, can thereby be delayed.
- Familiarise yourself with the Voice Assistant functions before starting the journey.

The Voice Assistant does not replace the Owner's Manual.

The answers from the Voice Assistant do not provide the complete scope of information contained in the Owner's Manual. The Voice Assistant also does not give detailed warning or damage information. You can get the full scope of information about the function and safe operation of the systems and components in the vehicle in the Owner's Manual.

Operation

Function of the MBUX voice assistant

You can watch an animation on this topic via the following link:

Using the MBUX voice assistant, vehicle functions and various areas of the MBUX multimedia system can be operated by voice input, e.g. Navigation or Telephone. The MBUX voice assistant is operational about half a minute after switching on the vehicle and can be operated from all seats (depending on the special equipment).

Conducting a dialogue

Requirements

- Voice activation must be switched on in the multimedia system (→ page 317).
- For corrections during output, the **Voice barge-in** option must be activated in the multimedia system (→ page 317).

Starting a dialogue

- ▶ Say **Hey Mercedes** to activate the MBUX voice assistant.

or

- ▶ Press the  button on the multifunction steering wheel.
A blue wave appears in the MBUX multimedia system. The dialogue can be started.

For the dialogue with the MBUX voice assistant, you can use complete sentences of colloquial language as voice commands. Voice activation can also be combined directly with a voice command, e.g. **Hey Mercedes, how warm is it outside?**

Interrupting the dialogue

- ▶ During the dialogue say **Pause**.
The dialogue is interrupted.
- ▶ Say **Hey Mercedes** to continue the dialogue.

Changing dialogue level

- ▶ During the dialogue, say **Back**.
The MBUX voice assistant jumps back to the previous dialogue step.

Navigating in the selection list

If a voice command does not achieve a clear result, a selection list is shown.

- ▶ Say the line number or the content to select an entry or to have further details shown.
- ▶ Say **Next page** or **Previous page** to browse the selection list.

Calling up help

- ▶ **Current application:** say **Help**. You will receive suggestions and information about operation of the MBUX voice assistant for the current application.
- ▶ **Specific function:** call up the voice command for the required function, for example with **Hey Mercedes, I need help with Radio**.

Overview of the operable functions of the MBUX voice assistant

You can use the MBUX voice assistant to operate the following functions depending on the vehicle equipment:

- Telephone
- Text message and e-mail
- Navigation
- Radio and media

- Vehicle functions
- Online functions

Full functionality of the Voice Assistant is only available for you with activation of online voice control (→ page 317).

Information on the language setting

You can change the language of the MBUX voice assistant via the system language settings (→ page 358). If the set system language is not supported by the MBUX voice assistant, English will be selected.

Setting functions of MBUX voice assistant using the multimedia system

Multimedia system:

- ▶  ▶ **Settings** ▶ **System**
- ▶ **Voice assistant**

Switching voice activation of MBUX voice assistant on or off

- ① For vehicles with driver camera or MBUX Interior Assistant, the MBUX voice assistant can be switched on or off in the Intelligent Assistants menu.

- ▶ Select **Hey Mercedes**. When the function is active, the **Hey Mercedes** voice command can activate the dialogue.

Switching direct commands on or off

- ▶ Select .
- ▶ Activate or deactivate the function. If the function is active, some commands can be used without **Hey Mercedes**, for example **Next track**.

Switching voice activation for individual seats on or off

- ▶ Select .
- ▶ Switch the function for the desired seats on or off.

Switching voice interruption on or off

- ▶ Select [Further settings](#).
- ▶ Select [Voice barge-in](#).
If the function is active, a command can be interjected during voice output of the system.

Switching proactivity on or off

- ▶ Select [Further settings](#).
- ▶ Select the desired situation, e.g. [Activate your profile](#) or [Don't forget your phone](#).
When the function is active, the voice assistant proactively provides information in specific situations.

Activating or deactivating online voice control

- ❗ Online voice control is activated at the factory.
- ▶ Select [Online recognition](#).

- ▶ Activate or deactivate the function.
If the function is activated and a Mercedes me user account is linked to the vehicle, additional results are available through the provision of external information, e.g. information on POIs. By clicking the symbol in the blue wave, more information about the online voice control can be displayed.

Activating or deactivating contacts for online use

- ▶ Select [Contact upload for online recognition](#).
When the function is active, contacts will be found more easily and accurately using voice input.

Using MBUX voice assistant effectively

Notes on optimum use of MBUX voice assistant

- The MBUX voice assistant is operational half a minute after switching on the vehicle and can be operated from all seats, depending on the equipment installed. The system recognises from which seat the command was spoken and performs actions according to the seat position.

- If a dialogue has been ended, the MBUX voice assistant continues to be active, as long as the blue wave is shown in the multimedia system. You can say another voice command without saying **Hey Mercedes**.
- Using the direct command **Change language to English**, the system language can be changed to English without **Hey Mercedes**. Direct commands must be activated for this.
- With the MBUX voice assistant, incoming calls can be accepted or rejected without the keyword **Hey Mercedes**.

Information on the MBUX online voice assistant

The online voice control facilitates recognition and thanks to external information makes additional results available.

Therefore, Mercedes-Benz recommends that you activate online voice control (→ page 317).

You will need a Mercedes me user account for this. If you do not yet have a user account you have to create one and connect it with your vehicle (→ page 435).

Then call up your Mercedes me user account. The Mercedes me services are shown and can be activated (→ page 435).

By clicking on the symbols displayed in the blue wave, further information on the online status is displayed.

When online voice control is active, additional functions are available such as:

- Weather
- General knowledge
- Public holidays and school holidays
- Smarthome
- Messages
- Time, date and time zones
- Pocket and currency calculator
- Football results and fixture lists
- Share prices
- Calendar
- ChitChat
- Horoscope
- Geo Quiz

i The availability of these functions is country and equipment-dependent.

i Text content is taken from Wikipedia in accordance with the CC BY-SA 3.0 licence.

Essential voice commands

Notes on voice commands

It is not necessary to use exact voice commands to call up a specific function. The MBUX voice assistant also understands you when you use your colloquial speech. Some examples are listed below. For some languages however these examples are only available to a limited extent.

Examples of voice commands:

- Navigation (→ page 319)
- Telephone (→ page 320)
- Radio and TV (→ page 320)
- Media player (→ page 320)
- Messages (→ page 320)
- Vehicle functions (→ page 321)
- Online functions (→ page 321)

Examples of navigation voice commands

You can operate the navigation system using the MBUX voice assistant. The following list offers just a small selection of the possible navigation commands. You will receive additional suggestions if you say Help for navigation.

- Drive me home.
- Where is the nearest service station?
- Is there a service area along the route?
- Set Central Park as intermediate destination.
- Cancel the route guidance.
- Show my last destination.
- I want to buy juice.
- Search for a French restaurant in South London.
- Search for a filling station near the Mercedes-Benz Museum in Stuttgart.
- Navigate me to Warsaw and avoid toll roads.
- How is the traffic on the way to work?

Examples of telephone voice commands

You can operate phones connected with MBUX multimedia system the using the MBUX voice assistant. The following list offers just a small selection of the possible telephone commands. You will receive additional suggestions if you say Help for phone.

- Call Peter Miller on the mobile phone.
- Dial 0711 17 0.
- Call my father.
- Write a text message to Jane Smith.
- Search for the contact Peter Miller.
- Tell Peter Müller: "I'll be there five minutes later".
- Read me my new text messages.
- Show me the missed calls.
- Switch to address book

For an incoming call:

- Reject call
- Accept call

Examples of radio and TV voice commands

Depending on the vehicle equipment, you can operate the radio and TV using the MBUX voice assistant. The following list offers just a small selection of the possible radio or TV voice commands. You will receive additional suggestions if you say Help for radio or Help for TV.

- Play the radio station Heart FM.
- Next station.
- Previous station.
- Show me the list of radio stations
- Save the station
- What am I listening to?

Examples of media voice commands

You can operate connected media sources and online music using the MBUX voice assistant. The following list offers just a small selection of the possible media voice commands. You will receive additional suggestions if you say Help for media or Help for player.

- Play Michael Jackson.

- Play Michael Jackson on Spotify.
- Play "Yellow Submarine" by the Beatles.
- Next track.
- Previous track.
- Play similar track.
- Repeat this track.
- Please skip five seconds.
- Please go back five seconds.
- Switch on random playback.
- Set the music volume to level six.
- Mute the music.
- Switch to USB.

Examples of message voice commands

Messages can be created, edited and listened to using the MBUX voice assistant. The following list offers just a small selection of the possible message commands. You will receive additional suggestions if you say Help for messaging.

- Write a text message to Jane Smith: When will the next meeting take place?

- Show me my new e-mails.
- Write an e-mail to Jane Smith.
- Read me my new text messages.
- Show all new text messages.
- Write an e-mail to John Smith in English

Examples of vehicle voice commands

You can operate vehicle settings and vehicle functions using the MBUX voice assistant. The following list offers just a small selection of the possible vehicle voice commands.

-  If no seat is mentioned for commands, the action is carried out automatically for the seat from which the command was spoken or for the function which is closest to that seat.
- Switch the seat heating to level 2.
- My feet are cold.
- Start the Refresh programme.
- Switch the massage function on.
- I would like to set the ambient light to blue
- Switch on the reading lamp.

- Turn off the rear light.
- Open all the windows.
- Switch the driver's display to 3D.
- How fast can I drive here?
- Tell me my next service appointment
- How warm is it outside?

Information about the vehicle can also be requested:

- Information about individual items of the vehicle equipment
 - Hey Mercedes, which massage programs do you have?
 - Hey Mercedes, do I have Blind Spot Assist?
 - Hey Mercedes, where is the warning triangle?
- Information about functioning of the systems and components installed in the vehicle
 - Hey Mercedes, what is DISTRONIC?
 - Hey Mercedes, what do I need ESP for?
 - Hey Mercedes, what is MBUX?

- Information about operating the systems and components installed in the vehicle
 - Hey Mercedes, how do I connect my smartphone?
 - Hey Mercedes, how can I turn on the high-beam headlamps?
 - Hey Mercedes, how do I stop the ionisation function?

Examples of online functions

Depending on the country, language and vehicle equipment, additional functions are available when online voice control is active. The system accesses external information and can, among other things, answer questions about general knowledge, provide information about weather or locations, perform calculations, etc.

- Is the sun shining in Manchester?
- Is it raining at my location?
- What are the skiing conditions on the Zugspitze?
- What's the time in Sydney now?

- In which country do you pay with dollars?
 - How many Swiss francs make 25 euros?
 - How long now until the holidays?
 - What day is it tomorrow?
 - What is 20% of 29?
 - What does my horoscope say?
 - What is the price of Mercedes-Benz Group shares?
 - Let's play Geo Quiz.
 - I'm bored.
 - Who is the current prime minister?
 - What do you know about the Globe Theatre in London?
 - Who painted the picture "The Scream"?
 - What's the status in the Premier League?
 - Create a calendar entry tomorrow at 9 am.
 - What's my next task?
 - Tell me a joke.
 - How many languages do you speak?
 - What is your favourite animal?
- Are there any updates?

Overview and operation

Overview of the MBUX multimedia system

⚠ WARNING Risk of distraction from information systems and communications equipment

If you operate information systems and communication devices integrated in the vehicle when driving, you could be distracted from the traffic situation. This could also cause you to lose control of the vehicle.

- ▶ Only operate this equipment when the traffic situation permits.
- ▶ If you cannot be sure of this, stop the vehicle whilst paying attention to road and traffic conditions and operate the equipment with the vehicle stationary.

You must observe the legal requirements for the country in which you are currently driving when operating the multimedia system.

! **NOTE** Increased surface temperature due to direct sunlight on the central display/ front passenger display

The surface of the display is very dark.



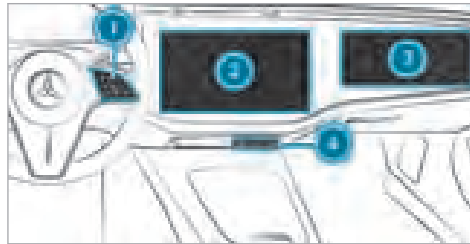

If the display is exposed to direct sunlight, the surface may heat up considerably.

- ▶ If the display has been exposed to direct sunlight, allow it to cool down before touching it for a longer period of time.



Vehicles with MBUX Hyperscreen

- ① Touch Control and control panel for the MBUX multimedia system

- Operates Touch Control (→ page 332)
- ② Central display with touch functionality for the driver
 - Overview of the zero layer (→ page 326)
 - Calls up and operates the zero layer (→ page 328)
 - Home screen overview (→ page 330)
 - Operates the touchscreen (→ page 333)
 - Sets haptic operation for the touchscreen (→ page 334)
- ③ Front passenger display with touch functionality
- ④ Switch panel with:
 -  Fingerprint sensor
 -  Switches the MBUX multimedia system on or off, switches the driver's and front passenger displays on or off
 -  Switches sound on or off
 -  Adjusts the volume
- ① Various MBUX multimedia system apps offer the option of linking with a QR code. Scan this QR code with your mobile phone before starting the journey.

- ❗ Alternatively, the MBUX voice assistant allows voice dialogue. Operation with natural speech starts after the wake-up call "Hey Mercedes" (→ page 316). You can start a voice navigation, for example, with the input of a three-word address from what3words.
- ❗ If the vehicle is equipped with the MBUX Interior Assistant, vehicle and infotainment functions can be used contact-free. The interaction then follows intelligently, reactively or with hand or head movements.

Numerous application, online services, services and apps are available for you. These can be called up via the home screen.

In the zero layer, entertainment sources as well as telephone, active applications and suggestions are directly available to you. You can conveniently call up and add your favourite destinations using the  button on the steering wheel.

Quick-access in the home screen and in the applications serve to select functions more quickly.

If you use the learning function of the multimedia system, during operation phone numbers dialled, active massage programmes or vehicle functions

are suggested to you, for example. Suggestions are displayed on the zero layer based on context and your user behaviour. The configuration of the suggestions is completed in the system settings. Furthermore, the multimedia system learns routines. Routines are actions that run automatically under certain conditions. You can compile your user profile from various vehicle settings and settings of the multimedia system. Some functions and services are protected by a PIN. If you teach in biometric procedures, you can identify yourself with these instead of the four-digit Mercedes me PIN.

The Notifications Centre collects incoming notifications, e.g. about an available software update. Depending on the type of notification it offers various actions. The call is made via the Control Center.

Overview of the front passenger display (only vehicles with MBUX Hyperscreen)

⚠ WARNING Risk of accident and injury due to distraction when the driver is looking at the front passenger display

If you look at the front passenger display while driving, you may be distracted from the traffic. This could also cause you to lose control of the vehicle. The front passenger display is intended exclusively for the front passenger.

- ▶ Keep the actual traffic situation constantly in view.
- ▶ Avoid looking at the front passenger display while driving.

The front passenger display is an additional touchscreen specifically for the front passenger.

Requirements for displaying content on the front passenger display while driving:

- The passenger is sitting on the passenger seat.
- The driver camera is switched on (→ page 353).

In the status line of the central display is shown as a  white symbol.

- The driver camera detects the driver's head and line of sight.

It displays content from the MBUX multimedia system independently of the central display.

Depending on the application, operation is independent of the driver. Depending on the market, extended content, e.g. playback of media content, is also available while driving.

For the playback of certain content on the front passenger display, e.g. moving images, it is necessary to connect Bluetooth® headphones.

-  When the vehicle is parked, the front passenger can use the front passenger display under the following conditions:
- The passenger is sitting on the passenger seat.
 - There is interaction with the MBUX multimedia system.

If the driver has left the vehicle briefly, e.g. to go shopping, the front passenger display can also be operated.

-  If no front passenger is present, a digital decorative image can be shown on the front passenger display (→ page 354).

Visual shield function for front passenger display

The visual shield function helps to avoid the driver viewing the front passenger display while driving.

Certain content on the front passenger display is dimmed for the driver.

Requirements for activating the visual shield function:

- The content shown on the front passenger display is blocked for the driver while driving, e.g. playback of videos.
- Content is blocked automatically via the MBUX multimedia system.
- The driver camera is switched on.
In the status line of the central display is shown as a  white symbol.

- The driver camera detects the driver's head and line of sight directed to the front passenger display. If the driver looks at the front passenger display for too long while driving, content subject to blocking is also dim-

med for the front passenger. A message appears on the front passenger display.

The front passenger display shows the contents again in the usual way under the following conditions:

- The driver looks forward again.
- No blocked content is shown on the front passenger display.

Anti-theft protection

This device is equipped with technical provisions to protect it against theft. More detailed information about anti-theft protection can be obtained at a qualified specialist workshop.

Zero layer

Function of the zero layer

-  Your software can be upgraded to a more current version at a later date.

The zero layer provides you with dynamic content from the MBUX multimedia system and is used to quickly access and control the applications you use. When you select  on the central display,

the digital map with the applications appears in the lower display area. Compared to the home screen with a classic menu, the steps required to call up the applications are reduced. You can switch between the zero layer and the home screen with a classic menu.

The applications can be hidden from the display area and shown again.

The zero layer provides the following modules and applications:

- Navigation module

In the expanded view you can, for example, display the route overview, switch on the display of traffic information and make settings for **View** (map), **Messages & tones**, **Route**.

- Entertainment (media, radio) and telephone

When the lower display area is shown, the entertainment sources are always displayed.

A mobile phone must be connected to the MBUX multimedia system for the phone to be displayed.

- Active applications

The lower display area shows an active massage programme, for example.

- Suggestions

Suggestions are displayed on the lower display area based on context and your user behaviour. Here are a few examples:

- Latest calls
- Active massage programs
- Vehicle functions
- Online voice applications
- Personalised routines

The learning function of the system recognises your typical operating sequences and offers to perform these automatically for you as a routine.

Modules and applications are first shown in a reduced view. By tapping on them, you can operate them or open the associated menu (expanded view).

A long press on a suggestion opens a context menu in which further functions are available.

The learning function can be switched on and off for the options (→ page 359).

■ Overview zero layer

Digital map and user-specific applications (example)



- ① Navigation module (reduced view)
- ② Enters a destination (→ page 375)
Searching for parking
- ③ Calls up the Control Centre: pull the bar down
- ④ Status line
- ⑤ Calls up user profile settings
- ⑥ Suggestion

Requirement: suggestions are activated (→ page 359).

7 Active application

8 Telephone

Requirement for phone: the mobile phone is connected to the MBUX multimedia system.

9 

Press briefly: shows all applications (→ page 328)

Press and hold: calls up the home screen with classic menu (→ page 330)

10 Entertainment sources (media, radio)

11 Route monitor

e.g. route list, lane recommendations, 3D image of the upcoming driving manoeuvre

The zero layer shows the digital map and the user-specific applications.

The following user-specific applications are displayed in the lower display area:

- Suggestions

Requirement: suggestions are activated (→ page 359).

- Active applications
e.g. a massage programme
- Telephone 7
- Entertainment sources 8
- Online voice applications

The lower display area can be hidden and shown (→ page 328).

Information about entertainment sources

You can operate the applications in the reduced view or in the menu (expanded view) (→ page 328).

Examples:

- Control a media source, e.g. pause/play, next track, set a station
- Select tracks from the current playlist or stations from the station list
- Select a media source

The media source must be connected to the MBUX multimedia system.

Information about the telephone

To use the functions, the mobile phones must be connected to the MBUX multimedia system.

Requirement for suggestions: the **Calls & messages** option is activated in the suggestions.

Examples:

- Answer a call and call a missed call
The missed calls are displayed for the mobile phones connected to the MBUX multimedia system.
- Display contacts and call list and call a contact
- Use voice functions
- Suggest contacts
The contacts are suggested for the mobile phones connected to the MBUX multimedia system. No contacts are suggested for the mobile phones that are linked to another user profile.
- Write messages to contacts (suggestion)
- Connect a device via the device manager (suggestion)

Information about active applications

The following functions are available:

- Operating the massage programme
- Operating an ENERGIZING COMFORT programme

Suggestions for comfort and vehicle functions as well as navigation

Requirement: the **Comfort**, **Vehicle** and **Navigation** options are activated in the suggestions.

- Operating the massage programme
For example, the multimedia system suggests a programme at a certain time.
- Opening the boot lid
Requirement: the vehicle is equipped with boot lid convenience closing.
- Operating an ENERGIZING COMFORT programme
- Making heating settings
- Activating/deactivating Parking Assist PARKTRONIC
- Selecting previous destinations and destinations from favourites

Suggestions for online voice applications

Requirement: the **Online voice services** option is activated in the suggestions.

The suggested voice applications are made available online and are based on your previous voice inputs.

Examples:

- What will the weather be like tomorrow?
- Play the messages.
- Start geoquiz.
- Open the garage door.

Suggestions for activating recognised routines



Requirement: the **Learning & suggestions** option is activated in the suggestions.

Routines are actions that run automatically under certain conditions. An example of a routine: Whenever you drive to work in the morning (condition), the MBUX multimedia system should set a certain massage programme (action). Routines can also perform different actions.



Calling up and operating the zero layer

Calling up the zero layer

When the vehicle has been switched on, the zero layer is displayed with the digital map. Navigation is active.



- ▶ **From another application:** press the  button on the right side of the steering wheel.
or
- ▶ Tap on .

Operating applications in the reduced view (examples)

- ▶ **Media:** to play the previous or next track, tap  or .
- ▶ **To answer a call or call a missed call:** tap on the contact.
After the connection has been established, the call functions are available.
- ▶ **To end a call:** tap on the contact again.
- ▶ **To reply to message:** tap on a message and dictate the message via the MBUX Voice Assistant.

- ▶ **To start a massage programme:** tap on the application and start the massage programme.
- ▶ **To select a previous destination:** tap on the application and select one of the previous destinations.
- ▶ **To select a destination from the favourites:** tap on the application and select the destination.

Hiding and showing the display area with applications

- ▶ **To hide:** pull the applications down.
 - ▶ **To show:** pull the bar above  upwards.
- or
- ▶ Select .
- or
- ▶ Press the  button on the steering wheel on the right.

Navigation module (expanded view)



Example: route guidance is active

- ① Traffic event on the route
Distance from current vehicle position and remaining driving time
- ② Destination
- ③ Searches for a filling station
- ④ Switches traffic information display on or off

- ▶ Tap on the navigation module (→ page 326).
- ▶ Select **Route** in the lower menu bar.

Operating a menu in the lower display area (example: active massage programme)

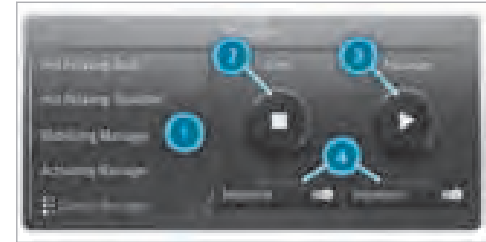

- ① Selects a massage programme
- ② Starts/stops a programme for the driver
- ③ Starts/stops a programme for the front passenger
- ④ Sets the massage programme intensity for the driver's or front passenger seat

▶ Tap on the application.
The expanded view of the application is displayed.

▶ **To close the menu:** select .

Opening and closing the context menu for a suggestion

▶ Press and hold on a suggestion.
The context menu opens and shows the **Do not suggest** option, for example.

▶ **To close:** swipe downwards.

Removing a suggestion from the display area

▶ Swipe the suggestion upwards.

Showing all applications

▶ Press  briefly.
Available applications are displayed.

▶ **To hide applications:** briefly press  again.

Switching between zero layer and home screen with classic menu

▶ Long press on .
The home screen with classic menu is shown.

▶ **To return to the zero layer:** press and hold on .

Home screen overview

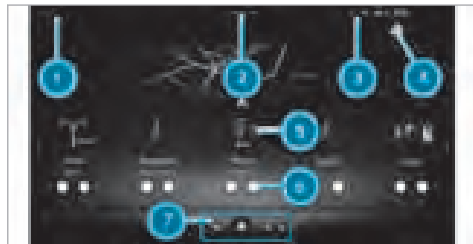

- ① Status line
 - ② Calls up the Control Centre
 - ③ Displays in the status line
 - ④ Calls up user profile settings and switches user
 - ⑤ Calls up an application
 - ⑥ Quick-access to application
 - ⑦ Global menu
-  Calls up previous menu

 Press and hold: switches between home screen and zero layer

 Previous track or previous radio station

 Next track or next radio station

① During a telephone call, the call duration is displayed in global menu ⑦.

Alternatively, to switch between the home screen and the zero layer, press and hold the  button on the steering wheel on the right.

When bar ② is pulled down, the Control Centre appears.

The following functions are called up in the Control Centre:

- Notifications Centre
- Quick vehicle access

Personalised routines

Overview of personalised routines

The MBUX multimedia system supports you with daily routine tasks and can run them automatically. The system's learning function recognises

your typical operating sequences and suggests them as a routine in recurring situations.

When the system recognises a routine, it is proposed to you on the zero layer for activation.

Routines are actions that run automatically under certain conditions. An example of a routine: Whenever you drive to work in the morning (condition), the MBUX multimedia system should set a certain massage programme (action). Routines can also perform different actions.

Routines are available to you via three options:

- The MBUX multimedia system learns and suggests routines.
- You create your own routines.
- You select predefined routines (templates).

If the learning function **Learning & suggestions** is switched on and enough data is available, the system suggests a routine on the zero layer. You can activate or reject these. In the future, when the conditions for the routine are met, you will receive a notification with a timer. After confirmation or expiry of the timer, the actions of the routine are executed. If you tap  in the notification, the

routine is cancelled. No actions are performed. However, the routine is still activated. If the conditions for the routine are met again, you will receive a notification again.

You can create your own routines or select predefined routines via the **Routines** app.

Conditions for routines are, for example:

- When should a routine start?
 - Weekdays at 8 a.m.
- Where should a routine start?
 - Start at home, start at work, tunnel passage
- At what temperature should a routine start?
 - From 0 °C
- At which event should a routine start?
 - Incoming or outgoing call
 - Strong sunlight

You can select the following actions, for example, from categories:

- Comfort
 - Selecting a massage programme

- Setting the seat heating
- Selecting the ENERGIZING COMFORT programme
- Climate control
 - Set temperature (front, rear)
 - Activate or deactivate the AC function
 - Adjusting the air vents
- Entertainment and navigation
 - Selecting a radio station
 - Select a media source
 - Switch off navigation announcements

■ Activating and starting suggested routines

Multimedia system:



▶ Activating routines

When a new routine is detected, it is suggested for automation on the zero layer.

▶ Select **Yes**.

In the future, when the conditions for the routine are met, a notification will be displayed to prepare you to execute the routine.

or

- ▶ **To reject the routine this time:** select **Decide later**.
You can find the routine in the **Routines** app and can activate or delete it there at any time.

Starting routines

A notification is displayed with a timer. When the timer has expired, the routine starts automatically.

- ▶ **To start the routine immediately:** tap the notification text.
- ▶ **To reject routine this time:** tap .
If the conditions for the routine are met, the routine will be offered again in the future.

Creating your own routines

Multimedia system:

  ▶▶ **Routines** ▶▶ **Create routines**

Configuring conditions

- ▶ Select .
- ▶ Select the condition, e.g. **Weekdays**.
- ▶ Select further conditions if required.

Configuring actions

- ▶ Select .
- ▶ Select the category, e.g. **Comfort**.
- ▶ Select the action, e.g. **Classic Massage**.
- ▶ If required, select further actions also from other categories.
- ▶ Select **Next**.
- ▶ Select a symbol and enter a name, e.g. **My first routine**.
- ▶ Select **Create skill**.
The routine appears in the overview. When the conditions for the routine are met, a notification is displayed. The routine can be started.

 You can edit a created routine at any time.

Selecting predefined routines

Multimedia system:

  ▶▶ **Routines** ▶▶ **Templates**







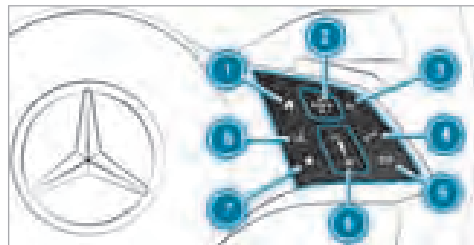

- ▶ Activate the desired routine.
When the conditions for the routine are met, a notification is displayed. The routine can be started.





 Templates can be edited like your own routines.

Touch Control

Operating Touch Control (MBUX multimedia system)



-  Shows zero layer/home screen
-  Touch Control
    Swipe in the direction of the arrow (navigate)
 Press (confirm)
-  Returns to the previous display

- ④  Makes or accepts a call
- ⑤  Rejects or ends a call
- ⑥ To increase volume: swipe upwards
To reduce volume: swipe down
-  To switch off the sound: press
- ⑦  Calls up favourite destinations (press briefly) or adds a destination to favourites (press and hold)
- ⑧  Starts the MBUX voice assistant
- ① To operate Touch Control ② in the most effective way, use the tip of your thumb if possible.

You can navigate through menus and lists via the touch-sensitive surface of Touch Control ② using a **single-finger swipe**, for example:

- ▶ **To enter a character:** select a character using the keyboard and press on Touch Control ②.
- ▶ **To select a menu option:** scroll in a list and press Touch Control ②.
- ▶ **To move the digital map:** swipe in any direction.

Setting the sensitivity for Touch Control

Multimedia system:

- ↳  ▶▶ Settings ▶▶ System
- ▶▶ Control elements
- ▶▶ Touch Control sensitivity
- ▶ Select **Fast**, **Medium** or **Slow**.

Setting acoustic operational feedback for all control elements

Multimedia system:

- ↳  ▶▶ Settings ▶▶ System
- ▶▶ Control elements ▶▶ Acoustic feedback

The function is supported by the selection in a list.

- ▶ Set **Off**, **Unleaded** or **Loud**.
If the function is activated you will hear a clicking sound when selecting control elements or when scrolling in a list. When the beginning or end of the list is reached you will hear another clicking sound.

Touchscreen

Operating the touchscreen

Tapping

- ▶ **To select a menu item or entry:** tap on a symbol or an entry.
- ▶ **To increase the map scale:** tap twice quickly with one finger.
- ▶ **To reduce the map scale:** tap with two fingers.
- ▶ **To enter characters with the keypad:** tap on a button.

Single-finger swipe

- ▶ **To navigate in menus:** swipe up, down, left or right.
- ▶ **To move the digital map:** swipe in any direction.
- ▶ **To use handwriting to enter characters:** write the character with one finger on the touchscreen.

Two-finger swipe

- ▶ **To zoom in and out of the map:** move two fingers together or apart.

- ▶ **To enlarge or reduce the size of a section of a website:** move two fingers together or apart.
- ▶ **To turn the map:** turn anti-clockwise or clockwise using two fingers.

Three-finger swipe

- ▶ **To call up the home screen:** swipe up with three fingers in an application.

Touching, holding and moving

- ▶ **To move the map:** touch the touchscreen and move your finger in any direction.
- ▶ **To set the volume on a scale:** touch the touchscreen and move the finger to the left or right.

Touching and holding

- ▶ **To save the destination in the map:** touch the touchscreen and hold until a message is shown.
- ▶ **To call up a global menu in the applications:** touch the touchscreen and hold until the **Options** menu appears.

Switching haptic operation for the touchscreen on and off

Multimedia system:

- ▶ **Settings** ▶ **System**
- ▶ **Control elements** ▶ **Touch & feel disp.**

- ▶ **Activate or deactivate the function.**
If the function is switched off, all you need to do is tap or swipe on the display to make an entry.

If the function is switched on, the system supports you with discreet tactile aids when you tap or swipe on the display.

- ▶ **You can operate the function on the central display.**

Overview of the fingerprint sensor

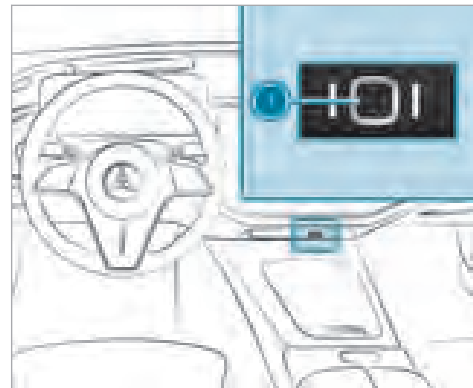

Equipment with MBUX Hyperscreen

Fingerprint sensor ⓘ allows you to conveniently access protected MBUX multimedia system functions and services. Compared to protection provided by the Mercedes me PIN, the entry of a four-digit number is not required to activate services and functions with personal content.

The fingerprint sensor must be set up before use (→ page 337).

If equipped with a front passenger display, one fingerprint can be scanned in for the driver's seat and one for the front passenger seat. These fingerprints are then assigned to the respective seat. They can be used for authentication or to activate your own user profile on the assigned display.

- ❗ The fingerprint sensor stores only a data model and no image of the fingerprint. The data model is only processed in the vehicle and is not transmitted from the vehicle.

User

Notes on user profiles

⚠ WARNING Risk of becoming trapped during adjustment of the driver's seat after calling up a driver profile

Selecting a user profile may trigger an adjustment of the driver's seat to the position saved under the user profile. You or other vehicle occupants could be injured in the process.

- ▶ Make sure that when the position of driver's seat is being adjusted using the multimedia system, no people or body parts are in the seat's range of movement.

If there is a risk of someone becoming trapped, immediately stop the adjustment process by:

- ▶ a) Pressing the warning message on the central display.
 - or
 - ▶ b) Pressing a position button of the memory function or a seat adjustment switch in the driver's door.
- The adjustment process is stopped.

The driver's seat is equipped with an anti-entrapment feature.

If the driver's door is open, the driver's seat will **not** be set after calling up the driver's profile.

Overview of user profiles

Requirements for use

- You have a Mercedes me user account.

- You have a Mercedes me PIN.
 - You have agreed to the terms of use.
 - The vehicle is linked to a Mercedes me user account.
- ❗ If one of the pre-requisites listed is missing or if no user profile has been selected, the data described in the following section will be saved in the vehicle as the standard setting. Standard settings can be changed by all vehicle users.

User profiles save personal settings. If the vehicle is used by several people, a person can change their profile settings without changing the settings of other users.

- ❗ Some settings apply to the entire vehicle and are displayed in all user profiles, e.g. ambient lighting and the current navigation settings. These initially belong to the driver, but can also be changed by the other vehicle occupants in their user profile.

You can individualise a user profile in the vehicle using the set-up assistant or using the settings in your user profile. Some settings, e.g. the Mercedes me PIN and a profile photo are made in

the Mercedes me App or in the Mercedes me Portal.

- ❗ If the user profile is downloaded while traveling, user profiles are not set up using the set-up assistant.

User-specific content and applications with personal data are protected by different levels of security (→ page 337).

To access protected content, the Mercedes me PIN and, depending on the vehicle equipment, biometric sensors are used.

- ❗ The security level is set by the multimedia system and calculated from the combination of all sensor inputs. Some security levels cannot be turned off.
- ❗ When a user profile is activated, the following personalised comfort systems, for example, can be adjusted or their settings loaded:
 - Seat
 - Ambient light
 - Outside mirrors
 - **Roller blinds**
 - Climate control settings

- Head-up display

If the user profile is activated when driving, the driver's seat position will not be adjusted.

User-specific content

Depending on the vehicle equipment you can, as a user, save the following settings, for example:

- Driver's seat, steering wheel and mirror settings
- Climate control
- Ambient light
- Radio (including station list)
- Suggestions

This function is an on-demand feature (→ page 25): If the vehicle key is linked to the user profile, the user profile is pre-activated when unlocking the vehicle or approaching a vehicle with KEYLESS-GO. Light, mirror and seat adjustments are made during this process. To use a user profile or an application, the vehicle key also serves as a sensor input for authorisation.

You can watch an animation on this topic via the following link:

Adding a user

Requirements

- The vehicle is stationary.

Multimedia system:

→  →  → [Change user](#)

- ▶ Select  [Add user](#).
A QR code is loaded.
- ▶ Scan the displayed QR code with the Mercedes me App or any QR code scanner on a mobile device. If the Mercedes me App is not yet installed on your mobile device, you will be directed to the store of your mobile device.
- ▶ Follow the steps in the Mercedes me App. The vehicle is connected with your Mercedes me user account. This automatically creates your user profile in the vehicle.
If only your user profile is available, it will be loaded automatically.
If more than one user profile is available, you will be directed to the user selection.

When the vehicle is stationary, the set-up assistant starts automatically after user selection.

- ⓘ When the user has been added, they can be selected (→ page 339).

Selecting user options

Multimedia system:



Protecting user-specific content and applications

If you add a new user, access protection is already activated for the user profile. The Mercedes me PIN and, depending on the vehicle equipment, biometric sensors are available for access. Biometric sensors in the vehicle must be taught in. The authentication process then takes all taught-in and available sensors into account.

The following user-specific content and applications are protected, for example:

- User selection and user profile settings
- Biometric sensors
 - The teaching-in of biometric sensors

For teaching in and editing biometric recognition see the following section.

- Suggestions
 - The data and determination of the most probable navigation destinations, media sources, radio stations, contacts and messages.
- ENERGIZING COACH
 - The recorded health data and its evaluation.
- In-Car Calendar
 - The calendar
- Parking service
 - The payment transactions.
- Mercedes me Store
 - The purchase of services.
- System activations of paid vehicle functions

In the following cases you will be prompted for authentication or re-authentication using a sensor or the Mercedes me PIN:

- When selecting a protected user profile
- When calling a function requiring special protection

- If biometric sensors provide insufficient or contradictory information
- If the multimedia system no longer trusts a sensor
- If the seat belt buckle and the door are opened at the same seat and a function requiring special protection is called up

- ⓘ Facial recognition for re-authentication in the driver's seat is only possible once the door has been closed or the seat belt buckle has been fastened again.

▶ Select **Protect content**.

▶ Switch **Access protection** on or off.

- ⓘ When access protection is switched off, your user profile can be viewed from any seat and changes can be made.
- ⓘ Access protection is switched on or off on a vehicle-specific basis.
- ⓘ Please note that authentication is necessary for several functions such as In-Car Calendar and cannot therefore be completely switched off.

Setting up and editing biometric recognition

The biometric data models are saved in the sensors in the vehicle. If recognition has been set up, this sensor serves as a contributory factor for authentication on the multimedia system.

- ▶ Select **Protect content**.

- ▶ Select **Facial recognition** or **Fingerprint recognition**.

i If necessary, authenticate yourself on the multimedia system.

Setting up facial recognition

- ▶ Close the driver's door or fasten the driver's seat belt.

- ▶ Follow the system's instructions. Your face is scanned. A message in the driver's display or central display shows whether facial recognition was successful or not. You can unlock your user profile and protected applications with the facial scan.

Setting up fingerprint recognition

- ▶ Place and lift your finger several times on the fingerprint sensor under the touchscreen (→ page 334).

The finger is scanned. If the scanning procedure is successful, a message appears on the central display. You can unlock your user profile and protected applications with your fingerprint.

Deleting biometric data

- ▶ Tap on  , for example, behind **Fingerprint recognition**.

- ▶ Select **Yes**.

Calling up the set-up assistant

- ▶ Select **Profile**.

- ▶ Select **Set-up assistant**.

- ▶ Follow the directions from the set-up assistant.

Changing a user name or profile photo

- ▶ Select **Profile**.

- ▶ Select **Change user name**.

or

- ▶ Select **Profile picture**.

- ▶ Enter the user name or select a user image.

- ▶ Select **Finished**.

i You can store your photo in the Mercedes me user account using the app or in the portal. The photo will then be shown in the vehicle. In the vehicle itself, you can select other sample images instead of the photo.

Deleting a user profile

- ▶ Select **Profile**.

- ▶ Select **Remove**.

- ▶ Select **Remove user profile**.

i Your Mercedes me user account and your personal data will remain within the Mercedes me ecosystem.

Resetting the user profile to factory settings

- ▶ Select **Profile**.

- ▶ Select **Reset**.

- ▶ Select **Yes**.

- ⓘ This resets the contents of the user profile to factory settings, but not the vehicle.

You can watch an animation on this topic via the following link:

■ Selecting a user

Multimedia system:



- ⓘ When you call up your driver profile, the driver's seat and the steering wheel can be set.

You can cancel the setting process with the following actions:

- Press [Tap here to cancel.](#) message on the central display.
- Press one of the seat operating buttons in the driver's door.

- ▶ Select [Change user.](#)
- ▶ Select a user.
- ▶ When requested to do so, authenticate with the Mercedes me PIN or a taught-in biometric characteristic.
The user profile is loaded and activated.

- ⓘ If you select [Continue without selecting user](#), no specific settings for the user profile are loaded.

■ Synchronising user profiles

Requirements

- You have a Mercedes me user account.
- The vehicle is connected with your Mercedes me user account.

Multimedia system:



▶▶ Synchronisation

▶ Allow synchronisation .

When the vehicle is switched on or off, the data stored in the vehicle is automatically synchronised with the Mercedes me user accounts. This synchronization is done for all user profiles and is not profile-specific.

or

▶ Select [Synchronise now.](#)

After selecting this option, the data stored in the vehicle is synchronised with the Mercedes me user accounts.

- ⓘ Not all user profile functions are available during synchronization.

- ⓘ If the personalisation service in the vehicle is deactivated, only the following user profile master data is synchronised:

- Profile name
- Profile image
- Mercedes me PIN

Notifications Centre

■ Overview of the Notifications Centre

The following communications are collected in the Notifications Centre:

- Communications which are generated by the vehicle or from the multimedia system.
- Communications which are received through the use of services.

The following notification types are available for you:

- Navigable destinations and routes
- Messages (text messages)

- Calendar entries and reminders, e.g. from In-Car Calendar

This function is not available in all countries.

- System information, e.g. **Important software update available. Confirm to start the update.**
- Other notifications, e.g. from additional online services that can be subscribed to or emergency reports (e.g. tornado)

The Notifications Centre is in the Control Center.

Depending on the style set, newly received notifications are shown using a coloured dot.

Notifications are normally briefly shown as they are received. If you take no action, these are stored for future access in the Notifications Centre.

The notifications are sorted chronologically. The most recent notifications are at the top.



Example of a message

- 1 Calls up the Notifications Centre
- 2 Symbol for a pinned notification
- 3 Time message received
- 4 Calls up the settings
- 5 Notification
- 6 Description of the notification and the issuing service

- 7 Symbol for notifications
- 8 Date of the received notifications

Depending on the type of notification, up to four different actions are available. If available these are shown as symbols.

Examples of actions include:

- Reading aloud
- Placing a call
- Replying
- Calling up a web page
- Navigation

Some notifications, e.g. a navigation destination, are stored longer. Therefore, it is not necessary to carry out available actions directly upon receipt of the notifications. A route guidance can be started at a later time.

You can pin a notification so that this is not deleted automatically after a certain time. The notification is then denoted by symbol 2.

Calling up notifications

Opening the Notifications Centre

▶ In the zero layer pull down bar  in the centre of the status line (→ page 326).

or

▶ In the home screen pull down bar  in the centre of the status line (→ page 330).

The Control Centre opens.

▶ Select  in the Control Center.

Selecting a notification

▶ If several messages are available swipe up or down.

▶ Select an action.

Closing the Notifications Centre

▶ Select .

Selecting actions for a notification

The following options are available:

- Select the action directly after a notification is received and shown.

- Select the action later after calling up in the Notifications Centre.

▶ Up to two actions available: select the action.

▶ More than two actions available: select .

▶ Select the action.
The notification is still available.

▶ Close the actions with .

Editing notifications

▶ Call up the Notifications Centre (→ page 341).

Configuring settings

▶ Select  **Settings** .

▶ Select the service.

▶ Switch the options on or off.

The following options are available depending on the service:

- [Allow notifications](#)
- [Display in notification centre](#)
- [Show notifications](#)
- Switch [Acoustic signals](#) on or off

External access

The option allows an external service access to specific data, e.g. the current vehicle position. The detailed, approved information is shown with .

If [Allow notifications](#) is switched off, the options cannot be selected with the exception of [External access](#).

Pinning a notification

▶ Drag a notification to the right on the touchscreen.

A pin appears.

▶ Tap on the pin.
The notification is marked with a pin.

Deleting notifications

▶ Drag a notification to the left on the touchscreen.

or

▶ Select .

▶ Select **Yes**.
All messages are deleted.

Switching the sound for the MBUX multimedia system on or off

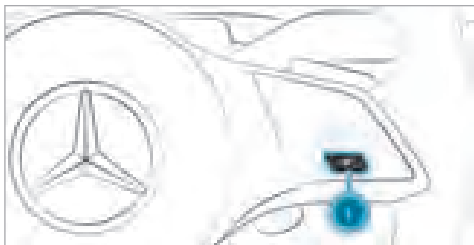

On the steering wheel

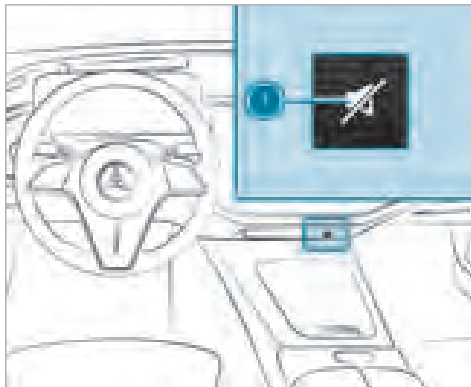

On the control panel when equipped with MBUX Hyperscreen

- ▶ **To switch off:** press button ①.
The current audio source is muted.
The  symbol appears in the status line of the central display.

If you are listening to a radio station, for example, and switch off the sound then all media sources will be muted.

Traffic and navigation announcements can still be heard in this case. The MBUX voice assistant and telephony are also not affected.

Switching on

- ▶ Press button ① again.
- or
- ▶ Set the volume.
- or
- ▶ The media source changes.

Entering characters

Using the character input function

Requirements

- **For the handwriting recognition read-aloud function:** the MBUX multimedia system is equipped with the MBUX voice assistant.
- The read-aloud function is available for the selected system language.

- The handwriting recognition read-aloud function is activated.

Enter the characters on the Touch Control or on the touchscreen. Character input can be started with a control element and resumed with another.

- ▶ When the keypad is shown, enter the characters by swiping and pressing on the Touch Control or by tapping on the touchscreen.

or

- ▶ If handwriting recognition has been selected, write the characters on the touchscreen.

Examples for character entry include for example, the entry of a navigation destination or a message.

The touchscreen supports character input with the following functions:

- Handwriting recognition offers character suggestions.
- If the read aloud function is activated for handwriting recognition then the entered characters are read aloud.

Entering characters on the touchscreen

Requirements

- If you wish to have the character input read aloud: the read aloud function of the handwriting recognition is switched on (→ page 344).
- An online connection is required for some functions.

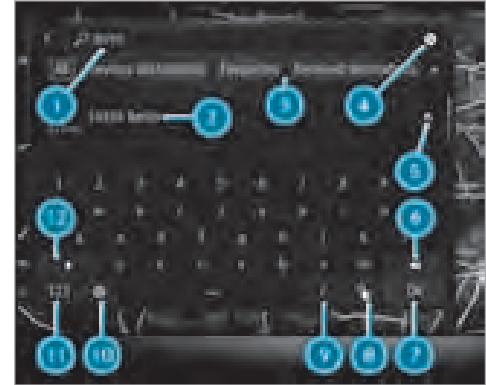

Example: character input with the keypad

- ① Input line with current entry
- ② Search result
- ③ Selects destination input, displays further destination inputs with double arrow
- ④ Deletes an entry
- ⑤ Adopts the search result in the input line and continues the search

- ⑥ Deletes the last character entered
- ⑦ Hides the keypad
- ⑧ Switches to handwriting recognition
- ⑨ Starts the MBUX voice assistant (→ page 316)
- ⑩ Sets the written language
- ⑪ Switches to digits and special characters
- ⑫ Switches to upper-case or lower-case letters

▶ Example: call up the navigation and enter a destination address (→ page 375).

▶ Briefly press on a character. The character is entered in input line ①.

▶ Resume character input.

ⓘ The available editing functions depend on the editing task, the language set and the character level.

Entering alternative characters

- ▶ Press and hold on a character.
- ▶ Select the character.

Ending character input

- ▶ Hide keypad ⑦.

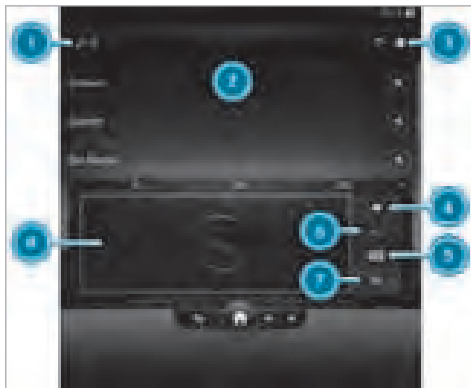

Example: entering characters with handwriting recognition

- ① Input line
- ② Shows suggestions during input
- ③ Deletes an entry
- ④ Last character entered
Pressing and holding deletes the entry
- ⑤ Switches to input using the keyboard



- ⑥ Enters a space
- ⑦ Accepts an entry
- ⑧ Writing area

If available, the  symbol allows you to change to voice input.

▶ When the keyboard is displayed, select .

▶ Write the character with one finger on the touchscreen. The letters can be written next to each other or above each other. The character is entered in input line ①. Suggestions are shown in ②.

▶ Select one of the suggestions.

▶ If available, display additional suggestions with  or .

▶ **To end character entry:** press briefly on .

Setting the keyboard and handwriting recognition for character entry

Requirements

- The read-aloud function is available for the selected system language.

Multimedia system:

- ➔  ➔ Settings ➔ System
- ➔ Keyboards and handwriting

Setting the keyboard language

- ▶ Select [Keyboard languages](#).
- ▶ Select one or more keyboard languages.

Setting the writing speed

- ▶ Select [Handwriting recognition](#).
- ▶ Select an option, e.g. [Medium](#).

Activating the read-aloud function

- ▶ Select [Handwriting recognition](#).
- ▶ Switch on [Read out](#) .

The letter that you write on the touchscreen is read aloud.

Activating handwriting recognition on the keyboard

- ▶ Select [Handwriting recognition](#).
- ▶ Switch on [Handwriting recognition](#) .

You can write characters directly on the keyboard.

Deleting the user dictionary

The user dictionary learns from your inputs and offers suggestions during character input. You can reset the user dictionary.

- ▶ Select [Reset my dictionary](#).
- ▶ Select [Yes](#).

MBUX Interior Assistant

Notes on lasers and laser classification

⚠ WARNING Risk of injury from the camera's laser radiation

This product uses a classification 1 laser system. If the housing is opened or damaged, laser radiation may damage your retina.

- ▶ Do not open the housing.
- ▶ Always have maintenance work and repairs carried out by a qualified specialist workshop.

This device is a class 1 laser product in accordance with IEC 60825-1:2014 and DIN EN 60825-1:2014.

- ① The camera records image data for the applications, for example body, head and hand detection.

The camera converts the image data directly into meta data. No image data is saved in the process. The data is processed in the vehicle and is not transmitted from the vehicle. When you start the vehicle, the MBUX Interior Assistant is activated automatically. You can switch the Interior Assistant on or off (→ page 352).

Overview of the MBUX Interior Assistant

The MBUX Interior Assistant detects the front vehicle occupants via 3D laser cameras in the overhead control panel. The Assistant interprets natural hand, head and body movements contextually or upon the explicit request of the driver or front passenger. The Assistant can thus automatically trigger vehicle interior functions and assist appropriately to the situation.

The Assistant recognises driver and front passenger interactions.

The applications are available under the following conditions:

- The MBUX Interior Assistant is activated (→ page 352).
- The MBUX multimedia system is activated.



Cameras **i** are located in the overhead control panel.

The Assistant supports vehicle and infotainment functions at three interaction levels:

- **INTELLIGENT**
The Assistant recognises vehicle occupants and objects automatically and activates functions.

- **REACTIVE**
The Assistant recognises the natural body language of a vehicle occupant and carries out functions automatically, appropriate to the situation.
- **CONTACTLESS**
The vehicle occupant actively requests a function using a hand movement.

The Assistant offers functions for the following:

- **SAFETY**
The Assistant supports vehicle occupants with the use of restraint systems.
- **COMFORT**
The Assistant enhances comfort by automating functions inside the vehicle and supporting natural interaction with the vehicle.
- **INFOTAINMENT**
The Assistant facilitates operation of the Infotainment functions.

System limits, display messages and notes for rectification

- i** System limits that only apply to one application are described in the corresponding section.

The error messages are shown on the central display, for example.

The system may be impaired or may not function in the following situations:

- The camera in the overhead control panel may heat up due to operating conditions. As a result the camera may switch off temporarily, particularly during longer periods of operation and at high outside temperatures.
Do not touch or cover the camera. Wait until the camera has cooled down and is available again.
The **Interior assistant unavailable. Notification to follow.** message appears.
You receive a message when the camera is available again.
- The camera is covered, dirty, misted up or scratched.

Wait until the camera has cooled down before cleaning the camera cover.

The **Currently unavailable, see Owner's Manual.** message appears.

Clean the outside of the camera cover with a dry or damp cotton cloth. Do not use microfibre cloths. Do **not** remove the cover when cleaning.

- A vehicle occupant is very large. Clothing being worn (gloves, hat, scarf, colour of cloth-

ing) or objects carried on a person, for example a watch with a large display, can affect the camera view. Or the detection range of the camera is restricted.

The **Interior assist. only available to driver to limited extent, see Owner's Manual** message appears.

Keep the camera's field of vision clear.

Objects in the detection range of the camera can restrict the camera view. Please make

sure that no objects hang on the inside rear-view mirror, for example.

- The MBUX Interior Assistant is faulty.
The **Interior assistant is unavailable. Please contact a Mercedes-Benz workshop.** message appears.
Consult a Mercedes-Benz service centre.

The three types of interaction:

Type of interaction	Description and example of application
INTELLIGENT	The Assistant detects the presence of vehicle occupants and objects. Depending on the situation, functions are carried out automatically. Example of application: prompt about fastening the child seat (safety)
REACTIVE	The natural body language of a vehicle occupant, e.g. a hand or head movement, is recognised and triggers a function implicitly. Example of application: switching the search light on or off (comfort)
CONTACTLESS	The vehicle occupant triggers a function by actively demanding this with a hand movement. Example of application: opening and closing the sliding sunroof and roller sunblind (Comfort)

You can watch an animation on this topic via the following link:

[Anticipatory exit warning \(SAFETY/reactive\)](#)

Requirements

- The vehicle is equipped with Active Blind Spot Assist with exit warning.

- Active Blind Spot Assist is activated (→ page 258).
 - The vehicle is equipped with active ambient lighting or ambient lighting.
- i** Observe the information on the system limits of Active Blind Spot Assist with exit warning (→ page 255).

The function can warn vehicle occupants about a possible collision with an approaching vehicle or bicycle when they exit the vehicle.

As soon as the driver or front passenger moves their hand towards the door handle, depending on the vehicle equipment, the following warnings are issued:

- The active ambient lighting or ambient lighting flashes red.

- The warning lamp in the outside mirror also flashes red for one of the front doors.
 - When the door is opened, a warning tone sounds.
- ⓘ The visual warning is thus already given **before** the door is opened.
- ⓘ Further information on Active Blind Spot Assist with exit warning (→ page 255) and on ambient lighting (→ page 160).

Notes on fastening the child seat (SAFETY/intelligent)

The MBUX Interior Assistant detects child restraint systems on the front passenger seat. If a child restraint system is not fastened, e.g. a rearward-facing child seat, a message appears on the central display.

The function assists you in making sure that a child restraint system is secured with the seat belt on the front passenger seat.

- ⓘ For further information on securing a child restraint system with the seat belt on the front passenger seat (→ page 71).

- ⓘ The MBUX Interior Assistant cannot check whether the child is correctly restrained in the child restraint system.

Switching the reading light on or off (COMFORT/contactless)

Requirements:

- The driver's and front passenger's hand movement takes place under the inside rearview mirror.

A brief movement of the hand up and down, switches the reading light on or off.



Carrying out operation of the reading light for the driver and front passenger

- ▶ Move your hand up and down under the inside rearview mirror.
The reading light is switched on or off.
- ⓘ Further information on switching the reading lamps on and off (→ page 159).

Switching the search light on or off (COMFORT/reactive)

Requirements:

- The function is available in the vehicle when it is dark.

- The front passenger seat is not occupied or a child is sitting in a child restraint system.
- The hand movement is made by the driver in the interaction area above the front passenger seat.

The function enhances the comfort in the vehicle interior.

Stretching out a hand over the front passenger seat switches a search light on automatically for the driver when it is dark. Pulling the hand back switches the search light off again.



Interaction area for activation of the search light

Automatic preselection of the outside mirrors (COMFORT/reactive)

Until now, to set the outside mirrors the desired mirror had to be selected using a preselection button in the driver's door.

With the MBUX Interior Assistant, the mirror to be set is preselected automatically by the natural movement of your head to the left or right. When the hand touches the button for adjusting the outside mirror, the LED under the button of the preselected mirror side lights up.

Use the button to set the position of the active outside mirror.

- i** Preselection of the outside mirrors using buttons is still possible. Further information on adjusting the outside mirrors (→ page 164).
- i** The driver camera is also used for this application. Further information on the driver camera (→ page 352).

i This function is not supported if the MBUX Interior Assistant is not available.

Opening or closing the roller sunblind on the rear window (COMFORT/reactive)

Requirements

- The vehicle is equipped with a roller sunblind for the rear window.
- Reverse gear is engaged.

If the driver glances back over their shoulder in the direction of the rear window, the roller sunblind opens automatically.

If the roller sunblind was closed before reversing, it will be closed automatically in the following situations:

- Park position **P** is selected.
- The vehicle exceeds a minimum speed when moving forward.

The function facilitates a good view when reversing, e.g. when parking, and reduces the number of operating steps.

- i** Further information on opening and closing the roller sunblind on the rear window (→ page 107).

i This function is not supported if the MBUX Interior Assistant is not available.

Opening and closing the sliding sunroof and roller sunblind (COMFORT/contactless)

Requirements

- The vehicle is equipped with a panoramic sliding sunroof.
- Always operate directly under the overhead control panel.
- The doors are closed.
- The vehicle is switched on.

Opening the roller sunblind and sliding sunroof

The MBUX Interior Assistant allows contactless operation of the roller sunblind and the sliding sunroof. The functions are available to the driver and front passenger.



Possible hand position at the beginning of the opening of the roller sunblind and sliding sunroof

- ▶ Extend your hand upwards and hold it in front of the inside rearview mirror. The palm of the hand can face forward or backward.



Hand movement to operate the roller sunblind and sliding sunroof

- ▶ Move your hand away from the inside rearview mirror directly under the overhead control panel to the rear and out of the area again. The roller sunblind opens.
- ▶ When the roller sunblind is open, repeat the hand movement. The sliding sunroof opens.

Closing the roller sunblind and sliding sunroof

- ▶ Extend your hand upwards and move it forward to the inside rearview mirror directly under the overhead control panel and out of

the area again. The palm of the hand can face forward or backward.

The sliding sunroof closes.

- ▶ When the sliding sunroof is closed, repeat the hand movement.

The roller sunblind closes.

- ▶ **To cancel opening or closing:** move your hand under the overhead control panel. The opening/closing process will be stopped.

- ① Further information on opening and closing the sliding sunroof and the roller sunblind (→ page 102).



- ② This function is not supported if the MBUX Interior Assistant is not available.

Selecting settings for the MBUX Interior Assistant

Multimedia system:

→  ▶ Settings ▶ System
▶▶ Intelligent assistants

Switching the MBUX Interior Assistant on or off

- ▶ Activate  or deactivate  the Assistant. If the Assistant is activated, full functionality is used.

Driver camera

Overview of the driver camera

⚠ WARNING Risk of injury from infrared radiation from the camera

This product uses an infrared lighting system of risk group 0 (RG0). If the housing is opened or damaged, infrared radiation may damage your retina.

- ▶ Do not open the housing.

- ▶ Always have maintenance work and repairs carried out by a qualified specialist workshop.

This device is a product of risk group 0 (RG0) according to IEC 62471: 2006 (First Edition) & DIN EN 62471: 2008.

Depending on the equipment, the driver camera is located either in the driver's display or in the nozzle strip.

The driver camera is available either as a mono or a stereo camera.

The driver camera detects the following characteristics:

- Head position
- Viewing direction
- Eyelid closure characteristics
- Driver's face

- ① The driver camera is automatically activated each time the vehicle is opened with the key. The current status of the  driver camera is shown in the status line of the central display.

- i** The driver camera records image data for applications such as ATTENTION ASSIST and facial recognition, for example. The driver camera converts the image data directly into meta data. No image data is saved in the process. The data is only processed in the vehicle and is not transmitted from the vehicle.

The driver camera must be set up for facial recognition before use (→ page 337).

System limits

The system may be impaired or may not function in the following situations:

- The driver camera is covered or dirty, misted up or scratched.
- The driver's face and/or eyes are covered.
- The driver is wearing glasses that block infrared.

Display messages

In the following situations display messages may be shown:

- If the driver camera is not functioning.

The driver camera is malfunctioning.

The **Driver camera inoperative See Owner's Manual** message appears.

- If the driver camera cannot capture the position of your head.

The **Change steering wheel/ seat position until 6 dots are visible on the upper edge of the screen** message appears.

- If the view of the driver camera is reduced or restricted.

The camera's view of the driver is currently impeded Affected functions: see Owner's Manual message appears.

The message can appear, for example, in the following cases:

- The camera's view is obstructed, e.g. due to a scarf or hat being worn.
- The driver is wearing glasses that block infrared.
- If hair partially obstructs the eyes, e.g. as with a long fringe.

- In the event of strong direct sunlight. The driver camera cannot detect the driver's eyes if the light-dark contrast is too strong.
- When one hand or both hands are on top of the steering wheel (twelve o'clock position).

Notes on care

Please comply with the notes on caring for the interior (→ page 482).

Switching the driver camera on or off

Multimedia system:

  **» Settings » System**
» Intelligent assistants

The driver camera is automatically activated each time the vehicle is switched on.

 Select **On** or **Off**.

When the driver camera is switched off or the **The camera's view of the driver is currently impeded** Affected functions: see Owner's Manual message appears, the following functions are not available or limited:

- **The 3D driver display (only for stereo camera) (→ page 304)**
- The microsleep and distraction detection function of ATTENTION ASSIST (→ page 222)
- The facial recognition
This function serves as sensor input for authentication and unlocking of the user profile and protected applications (→ page 337).
- The mirror preselection
This function allows the natural movement of the head to the left or right to automatically preselect the outside mirror to be adjusted. (→ page 164)

System settings

Display

Configuring display settings



Multimedia system:

 **Settings** **System** **Display**

Adjusting the brightness

- ▶ Select **Display brightness**.
- ▶ Vehicles with a driver's display and central display: Adjust the display brightness of the driver's display or central display.
- ▶ Vehicles with the MBUX Hyperscreen: Adjust the display brightness of the driver's display, central display or the front passenger display.

Switching the head-up display on/off

- ▶ Switch the head-up display on  or off .

Setting the decorative image for the front passenger display (vehicles with MBUX Hyperscreen)

- ⓘ The function is country-dependent.

- ▶ Select **Screensaver, passenger display**.
A selection of decorative images is displayed.
- ▶ Select the desired decorative image.
- ⓘ The number of available decorative images is variable.
- ⓘ If no user is logged in to the front passenger display and the front passenger display is switched on, the decorative image is visible.

Time and date

Setting the time zone

Multimedia system:

 **Settings** **System**
Time and date

- ▶ Select **Time zone**.
The list of countries is displayed.
- ⓘ If there are several time zones available in a country, these will be shown after the country is selected.
- ▶ Select a country and, if required, a time zone.
The time zone set is displayed after **Time zone**.

or

- ▶ Select the **Automatic time zone** entry from the country list.
The time zone will be set automatically according to the vehicle location.

ⓘ The **Automatic time zone** option is available for vehicles with satellite reception.

■ Setting the time and date format

Multimedia system:

- ➔  ▶▶ Settings ▶▶ System
- ▶▶ Time and date ▶▶ Set format

- ▶ Select a time and date format.

■ Setting the time and date manually

Requirements:

- The vehicle does not have satellite reception.

Multimedia system:

- ➔  ▶▶ Settings ▶▶ System
- ▶▶ Time and date

Setting the time

- ▶ Select **Set time**.

- ▶ Set a time.
- ▶ **Press OK to confirm.**

Setting the date

- ▶ Select **Set date**.
- ▶ Select a date.
- ▶ **Press OK to confirm.**

ⓘ On vehicles with satellite reception, the time and date settings are determined automatically based on the vehicle location and cannot be set manually.

Adjusting the time

- ▶ Select **Adjust time**.
- ▶ Set a value.
- ▶ **Press OK to confirm.**

ⓘ The function is only available in vehicles with satellite reception.

Vehicle position

■ Switching transmission of the vehicle position on or off

Requirements

- A Mercedes me user account is available.
 - At least one service is activated in the Mercedes me user account which has access to the transmitted position data.
- ⓘ The function is country-dependent. For more information, consult a Mercedes-Benz service centre.

Multimedia system:

- ➔  ▶▶ Settings ▶▶ System
- ▶▶ Data protection

- ▶ Activate or deactivate the **Transmit veh. position** function.

ⓘ Alternatively, you can also switch the function on or off in the status line via .

Setting permissions

Multimedia system:

→  >> Settings >> System
>> Data protection >> Permissions

In the **Permissions** menu, you can set access permissions for various data points (such as microphone, camera) used in an application. You can change permissions that have already been granted here. You can set permissions either for individual data points or for certain applications or websites.

- ▶ Select **Requests** or **Apps/websites**.
- ▶ Make the required settings for the permissions.

Bluetooth®

Information about Bluetooth®

Bluetooth® technology is a standard for short-range wireless data transfer up to approximately 10 m.

You can use Bluetooth® to connect your mobile phone to the multimedia system and use the following functions, for example:

- Hands-free system with access to the following options:
 - Contacts (→ page 418)
 - Call lists (→ page 420)
 - Text messages (→ page 421)

Bluetooth® is a registered trademark of Bluetooth Special Interest Group (SIG) Inc.

Activating/deactivating Bluetooth®

Multimedia system:

→  >> Settings >> System
>> Internet and Bluetooth

- ▶ Switch **Bluetooth** on or off.

Wi-Fi

Wi-Fi connection overview

You can use Wi-Fi to set up a connection to the Internet or to external network devices.

- ⓘ The availability of the function is dependent on the country.

Generally, two types of Wi-Fi connection are available:

- **Using the multimedia system as a Wi-Fi hotspot** (→ page 357)
The vehicle's multimedia system serves as Wi-Fi hotspot for mobile communication devices, such as smartphone or tablet PC, for example.
- **Using a mobile communication device as a Wi-Fi hotspot (tethering)** (→ page 447)

An external Wi-Fi hotspot is accessed for the Internet connection of the vehicle's multimedia system.

Switching Wi-Fi on or off

Multimedia system:

→  >> Settings >> System
>> Internet and Bluetooth

- ▶ Select **Wi-Fi**.
The controller is to the right: Wi-Fi is switched on.

When Wi-Fi is switched on, you can connect the multimedia system with external hotspots or make it available as a hotspot for external devices.

When Wi-Fi is switched off, it is not possible to establish a hotspot connection.

-  The availability of the function is dependent on the country.

■ Using the multimedia system as a Wi-Fi hotspot

Requirements:



- The device to be connected supports at least one of the types of connection described.

The connection types shown depend on the device to be connected. The function must be supported by the multimedia system and by the device to be connected. The type of connection established must be selected on the multimedia system and on the device to be connected.

-  The data volume of the vehicle or an already connected tethering device is used for the data connection.

Vehicle data volumes: Depending on the vehicle equipment, you can purchase a data pack-

age directly from a mobile phone network provider via the Mercedes me Store. To be able to use the data package, you conclude a separate contract with a mobile phone network provider via the Mercedes me Store, which can be terminated at any time and for which there are no costs. This contract is a prerequisite for using the services from the previously purchased package. The availability of this option is dependent on the country. If the data package option is not available or can be upgraded, you can purchase data volume directly from the mobile phone network provider for a fee.

-  Some functions may first need to be activated on the device being connected. More detailed information can be found in the manufacturer's operating instructions.
-  The use of the vehicle data tariff by external devices is not available in all countries.

Multimedia system:

  Settings  System

 Internet and Bluetooth

-  Select MBUX hotspot.

-  Select one of the following connection options.



Connecting using a QR code

Requirement: an app for scanning the QR code is installed on the device being connected.



Alternatively: the device being connected has an integrated QR code scanner (see manufacturer's operating instructions).

-  Scan the QR code shown.
The Wi-Fi connection is established.

Connecting using a security key

-  Select the vehicle from the device to be connected. The vehicle is displayed with the **MBUX XXXXX** network name.
-  Enter the security key which is shown in the central display on the device to be connected.
-  Confirm the entry.

Generating a new security key

-  Select the **Generate new security key** option in the **MBUX hotspot** menu.
-  Confirm the prompt with **Yes**.
A new security key is generated.

A connection will be established with the newly created security key.

- ⓘ When a new security key is generated, all existing Wi-Fi connections are then disconnected. If the Wi-Fi connections are being re-established, the new security key must be entered.

System language

Notes on the system language

This function allows you to determine the language for the menu displays and the navigation announcements. The selected language affects the characters available for entry. The navigation announcements are not available in all languages. If a language is not available, the navigation announcements will be in English.

Setting the language

Multimedia system:

- →  → Settings → System → Language

Setting the system language

A list of the available system languages is shown.

- ▶ Select a language.
The system language is switched to the selected language.

Setting the distance unit

Multimedia system:

- →  → Settings → System → Display

- ⓘ This function is not available in all countries.

- ▶ Select **Units**.
- ▶ Select a unit for the distance.
- ▶ For an additional display in the driver display of the instrument cluster, switch **Additional speedometer** on.

Activating/deactivating system PIN protection

Multimedia system:

- →  → Settings → System → Data protection → PIN protection

Setting the system PIN

- ▶ Select **Set PIN**.

- ▶ Enter a four-digit system PIN.
- ▶ Enter the four-digit system PIN again.
If both system PINs match, then the system PIN protection is active.

Changing the system PIN

- ▶ Select **Change settings**.
- ▶ Enter the current system PIN.
- ▶ Select **Change PIN**.
- ▶ Set a new system PIN.

Activating system PIN protection for software updates

- ▶ Select **Protect software updates**.
- ▶ Activate or deactivate the function.

Configuring suggestions

Multimedia system:

➔  ➔ Settings ➔ System
➔ Suggestions

- ▶ Activate or deactivate **Learning & suggestions**.
If the user profile is active and the function is switched on, personalised suggestions can be derived for activated applications.
- ▶ Select .
- ▶ Switch the options on or off individually.
If an option is switched on and sufficient data has been gathered, personalised suggestions based on your user behaviour will be offered to you. These are, for example, navigation destinations visited, phone numbers dialled as well as suggestions based on your music preferences.

Navigation

When **Allow destination suggestions** is switched on, the vehicle makes suggestions based on your visited navigation destinations.

If **Activate commuter route** is switched on, the navigation automatically detects that the vehicle is on a commuter route.

Calls & messages

Suggestions are offered for numbers dialled and messages sent.

Comfort

The vehicle makes suggestions based on the use of your comfort functions, e.g. which massage programme should be started at what time.

Entertainment

Suggestions are offered for the currently played media source. Suggestions are also made for online digital services, e.g. Spotify, TuneIn Radio and streaming services, and for categories, e.g. genre, artist and mood.

Climate control

The suggestions for quick temperature adjustment in the vehicle are displayed.

Vehicle

The suggestions for vehicle functions are displayed, e.g. for Parking Assist PARKTRONIC and for opening the boot.

In-Car Calendar

The suggestions for the calendar are displayed in the zero layer.

Online voice services

The suggestions are made available online based on your voice input and are offered on the zero layer.

- ⓘ The suggestions offered depend on the equipment.

Deleting collected suggestions

Multimedia system:

➔  ➔ Settings ➔ System
➔ Suggestions

- ▶ Select .
- ▶ Select **Yes**.
The suggestions are reset.

Software update

Information on software updates

Software updates keep your vehicle and the related systems up-to-date and prevent security flaws.

Software updates are available for vehicle components such as control units, convenience systems, locking and safety systems, driver assistance systems, suspension and drive systems as well as for the MBUX multimedia system. Software updates are available via the communication module or a Wi-Fi connection to an external hotspot.

The navigation maps are also updated via updates from external storage media (e.g. USB flash drive).

Install available software updates regularly. Otherwise the security of your MBUX multimedia system and individual vehicle components cannot be ensured.

 Software updates can be protected with a system PIN. Further information about the system PIN (→ page 358).

Further information about software updates can be found at <https://me.secure.mercedes-benz.com>.

Carrying out software updates

Requirements

For software updates via the communication module and Wi-Fi:

- Your vehicle is linked to a Mercedes me user account (→ page 435).
- Software updates without Mercedes me user account: The [Allow software updates](#) option is activated in the [Software update](#) menu.
- For software updates via the communication module: an Internet connection exists via the communication module (→ page 446).
- For software updates via Wi-Fi: a connection to an external Wi-Fi hotspot exists (→ page 447).

 Depending on the software update, this is started via the  communication module,  Wi-Fi or  external storage medium.



 Online software updates cannot be performed via external Wi-Fi hotspots that are encrypted via TKIP.

 If the Wi-Fi hotspot requires logging in via the browser, once the connection is successfully established the browser will open in order to start the update. Follow the instructions in the browser in order to start the download.

Multimedia system:

   [Settings](#)  [System](#)
 [Software update](#) 

Starting a map update from an external storage medium

-  Connect the storage medium with the vehicle via a media interface.
A message about an available map update appears on the central display.
-  Select the message.
-  Select [Start](#).
The map update is started.

Starting the software update via the communication module

If the [Automatic online update](#) option is active, available software updates are downloaded and installed automatically. Activate the option in

order to always keep your vehicle up-to-date and avoid security flaws.

- ▶ Select **Automatic online update**.
The software update is downloaded and installed automatically.

If the option is deactivated, you will be informed of new software updates once. The updates are available for downloading for a limited period of time.

- ▶ Select an update from the list of available updates.
- ▶ Start the update.
The software update is downloaded and installed automatically.

Starting a software update via Wi-Fi

Some software updates require an additional connection to a Wi-Fi hotspot. The connection to an external hotspot can be established when the software update is started.

- ▶ Select an update from the list of available updates.
- ▶ Start the update.

- ▶ Establish the connection to a Wi-Fi hotspot. The update is downloaded and installed automatically.

For software updates requiring a safe vehicle status: when the last installation step is reached, a message appears on the central display after the vehicle is switched off. Follow the step-by-step instructions on the central display to complete the installation.

There are software updates that can only be installed when the vehicle is safely parked, there are no more people in the vehicle and the vehicle is locked.

Installing software updates

Software updates are installed automatically after they are downloaded. As soon as the software update has been completed, a message appears in the central display. It may be necessary to restart the MBUX multimedia system.

Some software updates require a safe vehicle status for the installation to be completed. They can only be carried out in a safely parked vehicle with the vehicle switched off. If this is necessary, a

message appears on the central display after the vehicle is switched off.

- ▶ Follow the instructions on the central display.

For some software updates, you can set a time for installation. The installation is carried out automatically at the scheduled time. You do not need to be in the vehicle during installation. Note that the planned installation is cancelled as soon as the vehicle door is opened.

If an installation is available where you can set the time, a message appears on the central display after the vehicle is switched off.

- ▶ Follow the instructions on the central display.

The vehicle cannot be used while these software updates are being installed. Make sure that no persons or animals are in the path of your vehicle. Events stored in the vehicle's control units can be overwritten.

Availability of the driver's and central display

During the installation of software updates, it is not possible to use the vehicle, driver's display and central display. You may receive the following display messages when an installation is running:



i The display message does not appear every time a software update is installed.

In rare cases, an error can occur during the installation. The multimedia system automatically attempts to restore the previous version.

If it is not possible to restore the previous version, the display message shown above appears every time the vehicle is started.

Failure of the driver's display:

If the driver's display fails or there is a malfunction, you may not recognise limitations in the functions of systems relevant to safety or the speed display, for example. The operating safety of the vehicle may be impaired. Drive on carefully

and have the vehicle checked at a qualified specialist workshop immediately (→ page 668).

Further information about software updates can be found at <https://me.secure.mercedes-benz.com>

Failure of the central display:

If the central display fails or the display message shown above is shown continuously, several systems such as the reversing camera, PARKTRONIC or climate control are no longer available. Drive on carefully and consult a specialist workshop as soon as possible.

Front passenger display failure (only vehicles with MBUX Hyperscreen):

If the front passenger display has failed or a display message appears permanently, functions and systems are no longer available via the front passenger display. Visit a qualified specialist workshop.

Resetting the multimedia system (reset function)

⚠ WARNING Risk of accident due to failure of central display functions

While the multimedia system is reset, its functions, such as the reversing camera, are not available.

▶ Only reset the multimedia system when the vehicle is stationary.

Requirements

- The vehicle is switched on.
- Some settings can only be reset when the vehicle is stationary.

Multimedia system:

➔  ➔ **Settings** ➔ **System** ➔ **Reset**

When resetting the system, personal data and settings are deleted, for example:

- Connected devices
- Individual user profiles
- Biometric data

- Vehicles with rear telephony: handset connection
- ① The data used and saved in the multimedia system by the driver assistance systems is deleted.
- ① Vehicles with rear telephony: The handset must be in the cradle while the system is reset.
- ▶ Select **Reset**.
A query appears asking if the system should really be reset.
- ▶ Select **Yes**.
The multimedia system is reset to the factory settings. The multimedia system is restarted after the system reset.
- ① Due to data protection, as well as the function of individual driving systems and driving safety systems, it is a requirement to carry out a complete system reset before selling the vehicle or transferring it to a third party, or after use as a hire car.

AMG TRACK PACE

Function of AMG TRACK PACE

- ① This function is an on-demand feature (→ page 25).

With AMG TRACK PACE, the driving characteristics on race tracks can be analysed and optimised. You can drive previously saved race tracks (e.g. Hockenheimring), or record and save new tracks. The driven lap times are stored for every track. These can be analysed and compared to other lap times to achieve the best possible race results. Additionally, acceleration and braking manoeuvres can be measured and stored.



Note: Use AMG TRACK PACE only on closed-off routes outside the public traffic area. Adapt your driving style to your personal performance and environmental conditions. As the driver, you alone are responsible for driving your vehicle. Park your vehicle safely before operating the application.

Setting Track Race



Multimedia system:

↳ TRACK PACE ▶▶ Track Race

Recording a new track

- ▶ Select  **New track**.
- ▶ Select  **Start Record**. at the desired starting point.
The track recording starts at this point.

During track recording, sectors can be set to divide up the track.



- ▶  Select **Set Sector**.
- ▶ Select  **Stop Recording** to end track recording or cross the starting line again.
- ▶ Confirm the prompt with **Yes**.
- ▶ Select the weather.

- ① The temperature is determined automatically.
- ▶ Enter a name.
- ▶ Press  to confirm.
The track is saved under the name entered.

Searching by track name



- ▶ Select  **Search** .
- ▶ Enter the desired track name.
Tracks with the searched name are displayed.

Measuring time on a saved track

- ▶  Select **All tracks**.
- ▶ Select the desired track.
- ▶ Select .
- ▶ Select **Start timing** if you are already at the starting line.

or

- ▶ Select **Navigate to** for navigation to the starting line.
Timing begins automatically when the starting line has been crossed.



 When  is selected, the track display can be switched to AR. In addition, it is possible to switch to the telemetry display by selecting .

- ▶ Select  **Stop timekeeping** to end timekeeping.

- ▶ Confirm the prompt with **OK**.
- ▶ Select the weather.
- ▶ Select **Yes** to save the times driven for this track.



Showing readings during Track Race

The following readings can be shown:

- Tyre temperature
 - Miniature map
 - Sector overview
 - G-force display
 - Lap overview
- ▶ Select  **Start timing** .
 - ▶ Select .
 - ▶ Drag the desired display from the grid on the left or right edge of the central display.
The readings are shown during the Track Race.

By selecting  on the active display, you can deactivate this.

Displaying the analysis

- ▶  Select **All tracks**.
An overview of all the driven tracks appears.
- ▶ Select a track.
- ▶ Select a session.
The following data are displayed:
 - Lap and sector times
 - Average and top speed
 - Driver
 - Vehicle
 - Date
 - Weather
- ▶ Select **Add recording** to use a different session as a reference value.
- ▶ Select  to return to the overview.
- ▶ Select **Diagram**.
- ▶ Set the desired parameters.
The analysis is displayed.





- ① Lap overview
 - ② Parameter overview
 - ③ Editing parameters
 - ④ Deleting parameters
 - ⑤ Adding new parameters
- ⑥ The following values can be set for the parameters, for example:
- Speed



- Longitudinal/lateral acceleration
- Steering angle
- Engine speed
- Engine oil/tyre temperature

Based on the analysis, you can check and optimise the driving behaviour for any position on the track.

Exporting tracks (USB)

- ▶ Select  **Tracks** .
An overview of all stored tracks appears.
- ▶ Select the desired track.
- ▶ Select options  for the desired track.
- ▶ Select **Export track to...**
The selected track can be exported to a USB storage device connected to the vehicle.

Editing tracks and recordings

- ▶ Select  **Tracks** .
- ▶ Select the desired track.
- ▶ Select options  for the desired track.
- ▶ Select **Rename** or **Delete**.

or

- ▶ Select a track.
- ▶ Highlight the desired recording.
- ▶ Select  options.
- ▶ Select **Exporting to...** or **Delete**.

Setting Drag Race

Multimedia system:

↳ TRACK PACE ▶▶ Drag Race

Measuring acceleration

- ▶ Select  **Drag race options**.
- ▶ Select **Acceleration**.
- ▶ Set a starting speed or select **Automatic**.
Measurement begins as soon as the specified starting speed has been reached.
- ▶ Set a target speed.
Measurement stops as soon as the specified target speed has been reached.
- ▶ Start off and begin the measurement.
Measurement begins when the vehicle accelerates.

Measurement can be stopped early by interrupting the acceleration manoeuvre.

Quarter mile race

- ▶ Select  [Drag race options](#).
- ▶ Select [Quarter-mile](#).
- ▶ Set a target distance.
Measurement stops as soon as the specified target distance has been reached.
- ▶ Start off and begin the measurement.
Measurement begins when the vehicle accelerates. Timing runs until the target distance or a maximum of one mile has been covered.

Measurement can be stopped early by interrupting the acceleration manoeuvre.

Measuring braking

- ▶  [Drag Race options](#)
- ▶ Select [Braking](#).
- ▶ Set a starting speed or select [Automatic](#).
- ▶ Start off and begin the measurement.

- ▶ Brake to a stop.
Measurement is carried out in increments of 10 km/h to a stop. If the braking manoeuvre is started e.g. at a speed of 157 km/h, measurement starts as soon as 150 km/h has been reached

Storing and calling up measured values

If measurement is completed or cancelled, a prompt appears asking whether the measurement should be saved.

- ▶ Confirm the prompt with [OK](#) to save.

Calling up saved measurements

- ▶  Select [History](#).
 - ▶ Select [Acceleration](#), [Quarter-mile](#) or [Braking](#).
 - ▶ Select a measurement.
The desired measurement is displayed in detail.
- or
- ▶ Delete a measurement.

Calling up the telemetry display

Multimedia system:

 [TRACK PACE](#)  [Telemetry](#)

The telemetry display shows current vehicle data as a digital value and as a diagram. Up to four parameters can be selected to be shown on the display.

For example:

- Engine speed
- Wheel angle
- Speed
- Steering angle

- ▶ Set the parameters.
- ▶ Set the time.
The set parameters are evaluated in the diagram for the selected time.

Configuring AMG TRACK PACE

Requirements

To connect a mobile device to the TRACK PACE app:

- The TRACK PACE app must be installed on the mobile end device.
- The mobile end device must be connected to the multimedia system via Wi-Fi (→ page 356).

Multimedia system:



Connect mobile device via the TRACK PACE app

The TRACK PACE app makes it possible to record videos and to synchronise them with stored tracks.

- ▶ Select **TRACK PACE App**.
- ▶ Select **Authorise new device**.
- ▶ Start the TRACK PACE app on the device to be connected.
- ▶ Select **Continue** and confirm the authorisation prompt.
A four-digit code is shown on the central display.
- ▶ Enter the code on the smartphone.
The device is authorised.

De-authorising the mobile device

- ▶ Select **TRACK PACE App**.
- ▶ Select a device.
- ▶ Confirm the message prompt with Yes.
The device is de-authorised.

Setting the TRACK PACE display on the head-up display and driver's display

- ▶ Select **IC and HUD contents**.
- ▶ Activate or deactivate the desired contents.
The contents on the head-up display and the driver's display are adapted.
- ⓘ For further information on the Head-up Display (→ page 312).
- ⓘ Further information about the driver's display (→ page 304).

Setting acoustic feedback

- ▶ Select **Acoustic feedback**.
A scale with values from 0 to 10 is shown.
- ▶ Select a setting.

Displaying statistics

- ▶ Select **TRACK PACE statistics**.
Statistics on the current user profile are displayed.
The following data are displayed:
 - Driving time
 - Track driven
 - Recorded tracks
 - Recorded Track Races
 - Laps recorded
 - Recorded Drag Races
 - Maximum design speed

Activating the ambient light

If this function is active, the vehicle interior is lit in red or green depending on delta time.

- ▶ Select **Ambient light**.
- ▶ Activate or deactivate the function.

Adjusting the dashcam

If the vehicle is equipped with a dashcam, it can be used in AMG TRACK PACE.

- ▶ Select [Dashcam](#).
- ▶ Select [Track Race](#) or [Drag Race](#) and activate [Activate recording](#).
- ▶ You can set which overlay is to be used in the recorded video under [Video overlay contents](#).

Fit & Healthy

Setting ENERGIZING seat kinetics

Requirements

- ⓘ These functions are available only for fully electric seats with a memory function.

Multimedia system:

→  ▶▶ [Comfort](#) ▶▶ [Seat](#)

- ▶ Select [Seat kinetics](#).

ENERGIZING seat kinetics can support back health by changing the seat position during a journey. This involves repeatedly stressing and relieving the muscles and joints by means of minor movements of the cushion and backrest.

Starting seat kinetics

- ▶ Select  for the desired seat. The programme will run for the set duration.

Configuring seat kinetics

- ▶ Select  for the desired seat.
- ▶ Select [Backrest](#), [Backrest & seat surface](#) or [Seat surface](#).
- ▶ Select the desired duration for the selected seat.

Vehicles with a multicontour seat:

In addition to the seat backrest and seat cushion, the lumbar region can be activated for the function.

- ▶ Activate or deactivate [Including lumbar](#).

ENERGIZING COMFORT

Overview of ENERGIZING COMFORT programs

You can watch an animation on this topic via the following link:

- ⓘ Note that the available programs and the associated functions depend on your vehicle

equipment. Depending on your equipment, fewer functions may be available.

Program overview

- **Refresh:** Can have a refreshing effect with short, cool puffs of air. The seat is ventilated, the vehicle interior is illuminated with cool colours and the program is completed with appropriate sound. In addition, the vitalising movement in the cushions can loosen the muscles.
- **Warmth:** Can increase the comfort level for the vehicle occupants. Seat, surface and steering wheel heating provide soothing warmth. The program is completed with unobtrusive sound and warm colours.
- **Vitality:** Can counteract diminishing attentiveness in monotonous driving situations. The activating stimulation of the vehicle occupants is carried out with invigorating sound, activating light and a vitalising movement.
- **Joy:** Can promote a positive mood in the vehicle occupants as well as mental regeneration. This results from the activation of a massage

program, friendly sound and illumination with suitable colours.

- **Well-being:** Can help relax the vehicle occupants. This results from a relaxing hot-stone massage program, friendly sound and illumination with suitable colours.
- **Forest Glade:** Can have a calming and soothing effect on the vehicle occupants thanks to the acoustics of the forest. The ambience is supported by a suitable animation, colours and sound.
- **Sounds of the Sea:** Can contribute to calming the vehicle occupants. The acoustics of the sound of waves and seagulls in combination with other vehicle functions create a relaxing seashore atmosphere.
- **Summer Rain:** Can help relax the vehicle occupants. The relaxing effect of a rain shower can be experienced via acoustics and other vehicle functions inside the vehicle.
- **Anti-travel sickness (only front passenger):** Can help to prevent, mitigate or delay symptoms of travel sickness. The light, sound and animation are adapted accordingly. The air-

conditioning system and the seat cushion are actively targeted. The effect can be enhanced by manually tilting the backrest back slightly. At the end of the program, the seat cushion and the backrest are automatically returned to their original position.

- **Power Nap:** The program consists of three phases.
 - Falling asleep phase: here relaxing music is played.
 - Sleep phase: the active functions are deactivated or restricted as much as possible.
 - Waking phase: here slightly stimulating music is played. Additionally, functions such as seat ventilation and massage are activated.
- **Training:** Can counteract the onset of muscle tension, limbs falling asleep or stress with targeted relaxation or stimulation exercises. The exercises are demonstrated in short videos. The training consists of audio content and a brief animation. The audio content is conceived so that it can also be played back when

you are driving. Animations are only shown when the vehicle is stationary. Always observe the traffic conditions if you are training when driving.

- **Tips:** The system gives auditory tips for possible exercises or measures for improving the comfort level of the vehicle occupants. By selecting the desired area of the body you can receive targeted tips for the comfort level of this area.

Most programs that have been started for one seat can also be transferred simultaneously to another seat.

■ Starting the ENERGIZING COMFORT programme

⚠ WARNING Increased risk of accidents when using the ENERGIZING COMFORT programmes **Tips** and **Training**

The **Tips** and **Training** ENERGIZING COMFORT programmes can distract you when driving.

- ▶ Only carry out exercises if the traffic situation permits.

- ▶ When listening to the tips, make sure you are aware of the traffic around you at all times.

⚠ WARNING Risk of entrapment when using the ENERGIZING COMFORT programme **Power Nap**

With the **Power Nap** ENERGIZING COMFORT programme the following systems are moved automatically if required:

- Seats
- Side windows
- Sliding sunroof
- Roller sunblinds

This can cause you or another vehicle occupant to be trapped.

- ▶ Make sure that there is sufficient space behind the front seats.
- ▶ Make sure that no body parts are in the areas of movement.

⚠ WARNING Increased risk of accidents due to an incorrect seat position when using the **Motion sickness prevention** ENERGIZING COMFORT programme for the front passenger

The **Motion sickness prevention** programme is only available for the front passenger. Improper adjustment of the seat position increases the risk of injury in the event of an accident.

- ▶ When adjusting the seat backrest to a slightly flatter position, always maintain a basically upright sitting posture. Never adopt a reclining sitting posture while driving. Further information on occupant safety .
- ▶ Always ensure correct belt routing, especially in the shoulder and hip area. Observe the information on the protective potential of the restraint systems and the correct belt installation in this Owner's Manual.
- ▶ If necessary, correct the seat adjustment (fore-and-aft adjustment, backrest incli-

nation). If in doubt, do not use a flatter backrest position.

- ▶ The responsibility for seat position and belt routing always lies with the vehicle occupant.

⚠ WARNING Increased risk of accidents when using the **Motion sickness prevention** ENERGIZING COMFORT programme for the front passenger with a child restraint system

The **Motion sickness prevention** programme is only available for the front passenger. If the programme is used improperly in conjunction with child seats and booster seats there is an increased risk of injury in the event of an accident.

- ▶ Make sure that no child seats or booster seats are installed in the vehicle.
- ▶ The programme may not be used as long as child seats and booster seats are in use.

Requirements

- The vehicle is switched on.



For the start of **Power Nap**:

- Only the power supply is on.
- The doors are closed.
- The vehicle is secured against rolling away.
- The state of charge of the high-voltage battery is sufficient for the use of the auxiliary climate control.

Multimedia system:



Starting and stopping a programme

- ▶ Select a programme.
- ▶ Select  for the desired seat.
- ▶ Select  to stop the program.

- ⓘ If, during an active programme, a function requirement is no longer met, a corresponding message appears. The active programme is cancelled.

Starting a Power Nap

- ▶ Select **Power Nap**.
- ▶ Select  for the desired seat.

When the vehicle is stationary, the following actions are carried out when Power Nap is started:



- The roller sunblinds are extended.
- The doors are locked.
- The windows and sliding sunroof are closed.
- The seats are moved into the fully reclined position.
- The parking brake is applied.
- ▶ Select  to stop the program.

Starting the training programme

- ▶ Select **Training**.
- ▶ Select a programme .
- ▶ Select  to stop the training programme.

- ⓘ The animations demonstrating the exercises are faded out when the vehicle is in motion and you only hear the instructions.

Starting tips

- ▶ Select **Tips**.
- ▶ Select  a region of the body.
- ▶ Select  to stop playback of the tip.

ENERGIZING apps

Functions of the ENERGIZING app

Function of the ENERGIZING COACH

Requirements for use of the ENERGIZING COACH

- The **ENERGIZING COACH** service is activated in the Mercedes me portal or the Mercedes me App.
- The Mercedes me ENERGIZING app is installed on the mobile phone to use the service.

With ENERGIZING COACH you can evaluate the driving and driver situation. Depending on the situation, it offers recommendations for the start of an appropriate ENERGIZING COMFORT programme.

The following programmes could be suggested:

- **Vitality**

As an activating programme in monotonous driving situations or for long journey times, for example

Information on the vitality program see (→ page 368).

- **Joy**

As a balancing programme in demanding driving situations

Information on the Joy program see (→ page 368).

- **Refresh**

As a refreshing programme when temperatures rise

Information on the Refresh programme; see (→ page 368).

- **Warmth**

As a warming programme when temperatures drop

Information on the Warmth programme; see (→ page 368).

By connecting a Garmin fitness tracker, for example the Garmin vivoactive® 3, additional informa-

tion can be entered into the evaluation for the recommendation of an ENERGIZING COMFORT programme. The additional information includes the stress level, that is calculated by the fitness tracker. The stress level is based primarily on the pulse rate.

Requirements for the integration of additional information via a Garmin fitness tracker:

- Your fitness tracker is connected with your Garmin account.
- Your Garmin account is connected with your Mercedes me user account.

If you wear your Garmin fitness tracker at night also, the sleep data is included in the evaluation of the ENERGIZING COACH.

Requirement for the integration of the sleep data:

- The Garmin fitness tracker is synchronised with the Garmin account before the beginning of the journey.
- i** If ATTENTION ASSIST determines an excessive lack of attention, ENERGIZING COACH makes no further suggestions. Further infor-

mation about ATTENTION ASSIST (→ page 224).

Function of the ENERGIZING Biofeedback

Requirements for use of the ENERGIZING Biofeedback

- The vehicle is switched on.
- i** For full use, a connection with a fitness tracker must be established and the Mercedes me ENERGIZING app must also be installed on the mobile phone to use the service.

The ENERGIZING Biofeedback programme is designed to help reduce stress and increase concentration. It can be used with or without a connected mobile device or fitness tracker.

By connecting a mobile device, additional information about the user's vital signs can be accessed and it is indicated whether the exercise is having the desired effect. A stress-reduced state is indicated by a green display of the ENERGIZING biofeedback, a red display indicates a deterioration of the state.

-  When the mobile device is not connected, the programme is displayed in a neutral colour and no feedback can be given on the impact.

■ Calling up the ENERGIZING COACH display

Requirements:

- The fitness tracker is connected with your Garmin account
- Your Garmin account is connected with your Mercedes me user account in the Mercedes me ENERGIZING app.
- The mobile phone is connected to the multimedia system (→ page 414).
- You are logged in with your Mercedes me profile both in the vehicle and in the Mercedes me ENERGIZING app.

Multimedia system:

   **Apps**  **ENERGIZING COACH**

-  Your current pulse as well as an evaluation of your pulse for the last 30 minutes driving time are shown.
A corresponding fault message is shown if there is no mobile phone connected or no

pulse can be sent to the system for an extended period.

-  Only pulse values in the range of 30 - 140 (possibly 150) bpm are shown on the central display. The pulse values have no medical validity but are only informative in nature and are therefore also not required to be accurate.

■ Calling up ENERGIZING Biofeedback



Requirements:

- The vehicle is switched on.

Multimedia system:



   **Apps**
 **ENERGIZING Biofeedback**

Starting and stopping ENERGIZING Biofeedback



-  Operate  to start the program.
A video is played giving a calming breathing frequency with opening and closing circles, supported by an audio with wave sounds.
-  The circles are only shown when the vehicle is stationary, or only to the front passenger when the vehicle is moving, so as not to endanger the driver's attention.

-  Select  to stop the program.



Connecting a new device

-  Select .
-  Select **Device selection**.
The desired device can be chosen from the list of connected mobile devices.

Selecting a program

-  Select **Program settings**.
-  Switch the supporting functions from ENERGIZING COMFORT via massage, ambient lighting and suggested programs on or off.

Setting the duration of the program

-  Select **Program settings**.
-  Under **Duration of programme** set the desired duration. You can choose between three, five or seven minutes.

Navigation and traffic

Switching navigation on

Multimedia system:





- Alternatively, press the  button on the steering wheel on the right (→ page 332). The zero layer with the digital map is displayed.

Calling up the navigation module in the expanded view

Multimedia system:





-  **Navigation** means: tap on navigation module  on the zero layer (→ page 374).

The navigation module is called up in the expanded view and shows the route overview with additional functions.

- Select one of the functions (→ page 385).

The following functions are available, for example:

- Switch the traffic information display on or off.
- Select **Previous dest..**
- Search for **Filling stations**.
- Search for **Parking spaces**.
- Select **Other routes**.
- Enter a destination with .
- Make settings for **View**, **Messages & tones** and **Route** with .

Navigation overview

Digital map





-  Navigation module (reduced view)
Route guidance active:

The navigation module shows the information relevant to the route in the zoomed-out view, e.g. the arrival time at the destination or a traffic delay



-  Ends the current route guidance

Tapping opens the navigation module in the expanded view with the **Route** (→ page 385)

-  Destination entry
-  Searches for a parking space

- ④ Map orientation  and set map type
- ⑤ Current vehicle position (vehicle symbol or arrow)
- ⑥ Display area with entertainment sources, phone, active applications and suggestions
- ⑦ Navigation window shows the next driving manoeuvre in the reduced view when guidance is active or an enlarged view with a detailed display of the upcoming driving manoeuvre when approaching a driving manoeuvre, e.g. a map section, 3D images or lane recommendations

When route guidance is active, tapping on the navigation window opens the route monitor, which shows information for the entire route, e.g. upcoming driving manoeuvres, destinations, motorway exits or rest areas with points of interest

-  Switches off navigation announcements
-  Switches on navigation announcements

Pressing ④ several times changes the map orientation in this order:

- 2D and to the north

- 2D and direction of travel
- 3D and direction of travel
- Map with complete route

- ① If the map is moved, the map switches between 3D direction of travel and 2D north orientation.
- ① If you notice a problem with the digital map you can report this under <https://mapfeedback.here.com/#/report>.
The digital map is not provided by the HERE map service in all countries.

Destination entry

Notes on destination entry

⚠ WARNING Risk of distraction from operating integrated communication equipment while the vehicle is in motion

If you operate communication equipment integrated in the vehicle when driving, you could be distracted from the traffic situation. This

could also cause you to lose control of the vehicle.

- ▶ Only operate this equipment when the traffic situation permits.
- ▶ If you cannot be sure of this, stop the vehicle whilst paying attention to road and traffic conditions and operate the equipment with the vehicle stationary.

You must observe the legal requirements for the country in which you are currently driving when operating the multimedia system.

Entering a POI or address

Requirements

- For the online search:
 - There is an Internet connection.
 - Mercedes me connect is available.
 - You have set up a user account in the Mercedes me Portal.
 - The vehicle is connected with the user account and you have accepted the terms of use.

- Further information can be found at:
<https://www.mercedes.me>
- The service is available and has been activated.

i If Online Search is not available, the search is performed using the data of the digital map.

Multimedia system:

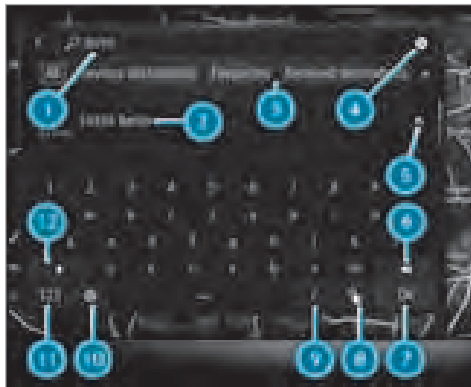

Example: entering a POI or address

- 1 Input line with current entry
- 2 Search result
- 3 Selects destination search, displays further destination searches with double arrow
- 4 Deletes an entry

- 5 Adopts the search result in the input line and continues the search
- 6 Deletes the last character entered
- 7 Hides the keypad
- 8 Switches to handwriting recognition (→ page 343)
- 9 Starts the MBUX voice assistant (→ page 316)
- 10 Sets the written language
- 11 Switches to digits and special characters
- 12 Switches to upper-case or lower-case letters

▶ Enter a destination. The entries can be made in any order.
The search results are displayed in a list.

i Online search results for POIs may contain additional information, for example opening times and ratings. The information is provided by an online map service.
This online function is not available in all countries.

The following entries can be made, for example in ①:

- Town, street, house number or street, town
- Postcode
- POI name or POI category, e.g. **Restaurants**
- Town, POI name
- **Contact name**
- **Junctions in the following entry format: "road A" and "road B"**
- Geo-coordinates (→ page 379)
- **Three-word addresses from what3words (→ page 379)**

Entering three-word addresses is possible in the online search .

▶ Hide the keyboard with **OK**.

▶ Select the destination in the list.

The following menu shows the selected destination with the address information and a corresponding map section.

The menu enables the route to be calculated.

Selecting a destination suggestion

Requirements:

- The **Allow destination suggestions** option is switched on (→ page 359).
- The multimedia system has gathered sufficient data in order to show destination suggestions.

Multimedia system:



▶ Select **Suggestions** and accept a destination suggestion.

or

▶ Select a destination suggestion directly on the Zero Layer (→ page 325). The route is calculated in the following menu.

① If **Suggestions** has been selected, a menu is available via **...**. The menu offers settings for the suggestions and memory functions.

① Managing destination suggestions (→ page 395).

Selecting previous destinations

Multimedia system:



▶ Select **Previous destinations**.

▶ Select a destination.

The following menu enables the route to be calculated.

① You can save a destination as a favourite (→ page 395).

Selecting a POI

Requirements

- **For use of personal POIs:** a USB device is connected with the multimedia system.
- Personal POIs with the GPS Exchange format (.gpx) have been saved in the PersonalPOI folder on the USB device.

Multimedia system:



▶ Select **POIs**.

▶ Select one of the displayed quick-access categories, e.g. **P**.

- ▶ Select the POI.

The following menu enables the route to be calculated.

or

- ▶ Select **All categories** or **Personal POIs** (see requirements).

- ▶ Select the category.

- ▶ Select the POI.

The following menu enables the route to be calculated.

Setting a search filter after selecting a POI category

The preset search position depends on the status of the route guidance:

- If route guidance is not active, **In the vicinity** is searched.
- If route guidance is active, **Along the route** is searched.

- ▶ When the search results are displayed, select **Filter**.

- ▶ Select the search position, e.g. **In the vicinity**.

- ▶ If a route with intermediate destinations already exists and **Near destination** has been selected in the search filters, the destination is selected for the search.

or

- ▶ Select the desired travelling time to the point of interest.

- ▶ Select **Search results**.

Configuring categories for quick access

The categories are displayed:

- As symbols after calling up the destination entry via 
- As a list after calling up **All categories**

- ▶ In the POI menu, select **All categories**.

- ▶ Select  or  for a category. Tapping on  adds the category.

Tapping on  removes the category.

- ▶ Use  to change back. The new categories are shown after the destination entry is called up the next time.

- ⓘ If all available quick-access positions are full, select the category to be replaced.

Changing the order of quick-access categories

- ▶ In the POI menu, press and hold a category for quick access.

- ▶ Tap on the arrows next to the selected category. The arrows for the other categories are greyed out.

- ▶ Drag the category up or down.

- ▶ Select .

Deleting quick-access categories

- ▶ Select  for the chosen category.

- ▶ Select **Delete**.

- ▶ Select .

Changing categories for personal POIs

- ▶ Select **Personal POIs**.

- ▶ Press on a category as long as is necessary until a menu appears.

- ▶ Select **Change name** and enter a name.

- ▶ Select **Change icon** and select a symbol.
- ▶ Select **Delete** and confirm the prompt with **Yes**.

Selecting a contact for destination entry

Requirements:

- A mobile phone is connected to the multimedia system (→ page 414).
- The contacts from the mobile phone have been downloaded.
- The contact has a navigable address.
- The address data can be located on the digital map.

Multimedia system:



- ▶ Enter a contact in the entry line.
- ▶ Select the address.

The following menu allows you to calculate the route.

- ⓘ Alternatively, after calling up the destination entry, you can enter the name of a contact in the search field.

Entering geo-coordinates

Multimedia system:



- ▶ Enter the geo-coordinates as latitude and longitude.

Examples of input formats:

- 47°58'11"N 7°57'25"E (degrees, minutes and seconds)
- 47.969722 7.956944 (decimal degrees)

- ▶ Confirm the entry.

The following menu enables the route to be calculated.

Entering the destination as a three-word address

Requirements

- An active Internet connection is indicated in the status line on the central display with the  symbol.
- The online search is active.

Multimedia system:



- ▶ Enter the destination as a three-word address from what3words. The entry can be made with spaces between the words instead of dots. The search results are displayed.
- ▶ Select the destination in the list. The following menu enables the route to be calculated.

The Brandenburg Gate has this language dependent three-word address:

- German: tapfer.gebäude.verliehen
- English: that.lands.winning
- French: postaux.bobineur.ombrant

- ⓘ Searching for a destination using three-word addresses is not possible in all countries and in all languages.

Alternatively, use the following entry options:

- Voice navigation (→ page 316)

Example: during a telephone call you are given a 3 word address. After activating the MBUX

voice assistant, say one of the following two voice commands:

- **Navigate to** tapfer gebäude verliehen
- **Navigate to** tapfer Punkt gebäude Punkt verliehen



Three-word addresses from what3words are an alternative addressing system for multilingual georeferencing of global locations with a resolution of three metres. Using this grid, locations on the Earth's surface are included which do not have a building address such as a street and house number, for example.

i Three-word addresses are unique, easy to remember and suffice for most routine applications.

You can convert addresses to three-word addresses and back again:

- At the website <https://what3words.com>
- In the what3words apps

Selecting a destination on the map

Multimedia system:



- ▶ If necessary, move the map (→ page 401).
- ▶ Press and hold on the map. Available destinations are displayed.

or

- ▶ Briefly press on a POI symbol. The POI is selected. If there are several POIs at this map position, a list appears.
- ▶ Select the destination in the **Selected objects** list.

The following menu allows the route to be calculated.

Selecting a destination from favourites

Requirements:

- Destinations are saved as favourites. Save a previous destination or a destination suggestion as a favourite (→ page 395).

Multimedia system:



- ▶ Select **Favourites**.
- ▶ Select a favourite.

The following menu allows you to calculate the route.

Addresses for home and work are already set

- ▶ Select **Home** or **Work**. The route is calculated in the following menu.

Addresses for home and work are not yet set

- ▶ Select **Home** or **Work**. The prompt **No "Home" address available. Set address now?** appears, for example.
- ▶ Select **Yes**.
- ▶ Search for or select the address.

- ▶ Select **Save**.

Deleting favourites

- ▶ Select for a favourite.
- ▶ Select **Delete**.

or

- ▶ Select **Delete all**.
- ▶ Confirm the prompt.
When all the favourites have been deleted, **Add favourite** is available, for example.

Selecting received destinations

Requirements

- There is an Internet connection for receiving external destinations.
- A destination has been sent to the vehicle.
- Destinations have been shared from another seat in the vehicle.

Multimedia system:



The vehicle can receive destinations from services or apps. You will be informed when a destination is received.

- ▶ Select **Received destinations**.

- ▶ Select a destination.
The route is calculated in the following menu.

- ▶ **i** You can save a received destination in the favourites (→ page 395).

Deleting received destinations

- ▶ Select for a destination.
- ▶ Select **Delete** or **Delete all**.
The destination or all destinations are deleted.

Route

Calculating a route

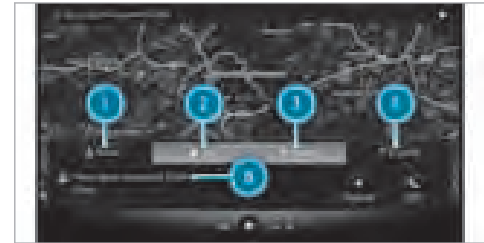

Example: detailed display

- 1 Calls up alternative routes
- 2 Adds the chosen destination to the existing destination as the next intermediate and recalculates the route
- 3 Calculates a new route to the chosen destination

- ④ Selects a point of interest in the vicinity of the destination
- ⑤ Detailed display with destination address, three-word address from what3words and online content

After selection of ② or ③, the route is recalculated.

- ▶ Select one of the options.

Calling up alternative routes

- ▶ Select [Routes](#).
- ▶ Select an alternative route.

Starting route guidance

- ▶ Select  [Let's go!](#).

Calling up the detailed display with destination address

- ▶ Pull the bar above the  [Let's go!](#) symbol upwards.
Depending on the destination selection and availability, online content, for example ratings and weather information, is shown.

- ▶ **To share a destination:** select  [Share](#). This option allows you to scan the displayed QR code.

- ▶ **To save a destination as a favourite:** select  [Favourite](#) and then an option.

- ▶ **To call up an Internet address:** if a web address is available, select [www](#).

- ▶ **To call the destination:** if a telephone number is available, select [Call](#).

Searching for POIs in the vicinity of the destination shown

- ▶ Select [In the vicinity](#).
- ▶ Search using categories, enter a search entry or search for a personal POI (→ page 377).

Adding an intermediate destination to the existing route or starting a new route guidance

- ▶ Select  [Add](#).
The selected destination address is set as the next intermediate destination. Route guidance begins.
- ▶ **There are already four intermediate destinations:** confirm the prompt with [Yes](#) and select

an intermediate destinations in the route overview (→ page 385), that should be overwritten with the new intermediate destination.

or

- ▶ Select  [Replace](#).
The selected destination address is set as a new destination. Route guidance begins.

Switching low-emission zones for the route on or off

Requirements

- Mercedes me connect is available.
- You have a Mercedes me connect user account and the vehicle is connected with the account.
- The "Traffic Restriction Zones" service is available and activated in the Mercedes me Portal. After registration the service is free of charge for the term offered.

Multimedia system:

  **Navigation**  **View**

- ▶ Switch on **Low emission zones**.

The low emission zones along the route are shown on the digital map and in the route overview.

Before you enter a low emission zone, you will be shown a notification in the central display.

Selecting a route type

Multimedia system:

  **Navigation**  **Route**

Using trailer mode and online routes

The route is calculated as a fast route with a short journey time.

Trailer mode is available if a trailer has been coupled with the vehicle. If available, you can select online routes.

- ⓘ Trailer mode and online routes are not available in all countries and for all vehicles.

- ▶ Select **Trailer mode**.

A prompt is shown in the multimedia system.

- ▶ Confirm the prompt.

The arrival time at the destination takes into account a reduced driving speed with trailer.

- ▶ **To use online routes:** switch on the option.

Taking traffic information for the route into account

- ▶ Select one of the options.

Explanation of the options:

- **Automatic**

Traffic reports via Live Traffic Information are taken into account (→ page 396).

If a new route with a shorter journey time is determined based on traffic reports, the current route is shown in blue and the new route in grey on the map. You can accept the new route by tapping on the grey line or keep the current route.

Live Traffic Information is not available in all countries.

- **Off**

No traffic reports are taken into account for the route.

Calculating alternative routes

Multimedia system:

  **Navigation**  **View**

- ▶ Activate **Overview of route after start**.

Alternative routes are calculated for every route.

Selecting route options

Multimedia system:

  **Navigation**  **Route**

Avoiding or using route sections, e.g. motorways or ferries

- ▶ Activate or deactivate the avoid option.

Avoid: the option is activated. The route avoids motorways, for example.

Use: the option is deactivated. The route takes motorways into consideration, for example.

- ⓘ The selected route options cannot always be taken into account. Therefore, a route may include a ferry, for instance, even though the **Avoid ferries** avoid option is enabled. A message then appears and you will hear a corresponding message.

Avoiding or using toll roads

The use of toll roads requires a usage fee (toll).

- ▶ Select **Toll roads** .
- ▶ Activate or deactivate **Avoid all**.
If the option is activated, the route avoids toll roads.
If the option is deactivated, the route takes toll roads into account.

or

- ▶ Select an option for **Payment by cash or card** or **Electronic billing**.
Avoid: the route avoids toll roads with the selected method of payment.

Use: the route takes into account roads that require a toll corresponding with the payment type selected.

Avoiding or using roads requiring a special toll sticker

A vignette allows for the use of a route network for a limited time period.

- ▶ Select **Avoid vignette roads** .
- ▶ Activate or deactivate **Avoid all**.

or

- ▶ Switch individual countries on or off in the list.
Avoid: the option is activated. The route avoids roads requiring a special toll sticker in the selected countries.

Use: the option is deactivated. The route takes into account roads in the selected country which require you to pay a time-based fee (vignette).

-  These route options are not available in every country.

Avoiding or using areas with low emission zones

-  The function is available when there is an active internet connection.

- ▶ Activate or deactivate **Area with low emission zones**.
Avoid: the option is activated. The route avoids all low emission zones restricted for the vehicle. These are displayed in red on the map.

Use: the option is deactivated. The restricted low emission zones for the vehicle are passed through on the route. A warning is displayed before you drive into a low emission zone.

Avoiding areas



- ▶ Select **Avoid areas**  (→ page 403).

Selecting notifications for the route

Requirements:

- **For an audible indication when approaching a personal POI:** the USB device contains personal POIs.
- The USB device is connected with the multimedia system.
- The category in which the personal POI belongs is activated.

Multimedia system:

-   **Navigation**  
- ▶ **Messages & tones**

Switching navigation announcements on or off

- ▶ Activate **Reduced messages**.
If a driving instruction is available for a simple change in direction, you hear a brief announcement, e.g. "turn right in 200 m". The number of driving instructions along the route is minimised.

▶ Activate **Detailed messages**.

If a driving instruction is available and there is a complex driving situation, you hear supplementary information, e.g. "In 200 m turn right and continue to follow the major road". Additional driving instructions are issued for the route, for example on turning major roads.

▶ Activate **Announce street names**.

The name of the street into which the vehicle should turn is announced.

- ⓘ This option is not available in all countries and languages.

Switching traffic announcements on or off

▶ Activate or deactivate **Announce traffic warnings**.

If available, traffic warnings are announced, e.g. before the end of traffic jams that pose a risk.

Audible indication when approaching a personal POI

▶ Select **Personal POIs**.

▶ Activate a category.

When approaching a personal POI in the selected category an audible indication will be issued.

Displaying a route overview

Requirements

- A destination is entered.

Multimedia system:

▶ ▶ **Navigation**

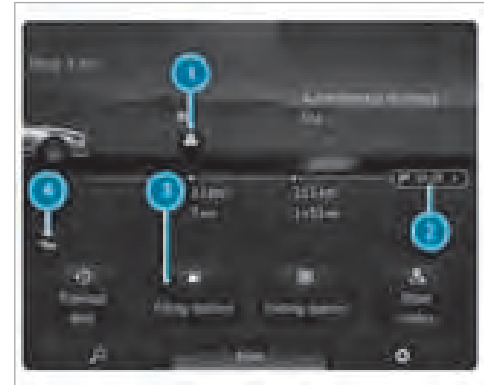

Example: route guidance is active

- ① Traffic event on the route
Distance from current vehicle position and remaining driving time
- ② Destination

- ③ Searches for a filling station
- ④ Switches traffic information display on or off

When route guidance is active, the destination and entered intermediate destinations are shown.

Depending on the route, traffic situation and available data, further information can be displayed.

The route can include up to four intermediate destinations.

- ▶ If route guidance is not active, select **Previous destinations** in addition to ③, for example.
- ▶ Select the destination and calculate the route.

i The following options are available for route planning in the route overview:

- Changing the order of the destinations (→ page 386).
- Deleting a destination.
- Substituting an intermediate destination along the route.

Planning routes

Multimedia system:



- ▶ Enter the intermediate destination (→ page 375).

After entering the destination and new calculation of the route, the map is shown again. The route contains a new intermediate destination.

- i** If there are already four intermediate destinations, delete an intermediate destination (→ page 386).

Editing a route with intermediate destinations

Requirements

- The destination and at least one intermediate destination have been entered.

Multimedia system:



Changing the order of the destinations

- ▶ In the route overview, press and hold on a destination.

- ▶ Move the destination with or .

- ▶ Tap on **Finished** . The editing mode is ended.

Deleting a destination

- ▶ In the route overview tap on for a destination.

Substituting an intermediate destination along the route

If an intermediate destination is entered and there are already four intermediate destinations, you will be asked to substitute one of intermediate destination. A prompt appears.

- ▶ Select **Yes**.
- ▶ In the route overview, tap on for the intermediate destination to be substituted. The new intermediate destination is added to the route.

■ Displaying the route list



Multimedia system:



- ▶ Tap on the navigation window ⑦
(→ page 374).



Example: route list

- ① Upcoming manoeuvre with turning arrow, distance to manoeuvre, street number, street name
 -  Switches off navigation announcements
 -  Switches on navigation announcements

Including the following route sections on the route to the destination

- ② Current vehicle position

The route sections are displayed in the navigation window. The route list is updated during the journey.

- ③ **Motorway information shows the available service facilities. After selecting symbols, e.g. for car parks, service areas or motorway exits, the POI is adopted as an intermediate destination or destination.**

- ▶ Press the arrow at the bottom of the navigation window briefly.
- ▶ Swipe up or down.
- ▶ Select a route section.
The map section is displayed.

■ Selecting an alternative route

Requirements

- A route has already been created.

Multimedia system:



The original route is shown in the navigation window and is highlighted on the map.

Alternative routes are shown on the map together with the difference in travelling time.

- ④ A faster route may be shown as an alternative route that is considerably longer.

The following route information is displayed:

- Driving time
 - Time of arrival
 - Distance to the destination
 - Avoid options based on the set route options
 - Driving time saved or lost compared with the original route
- ▶ When the alternative routes have been calculated, display the route in the navigation window by swiping to the right or left.

Changing route type

- ▶ Select **Filter**.
- ▶ Switching the route type on or off.

Avoiding or using route options

- ▶ Select **Filter**.
- ▶ Switch the route options on or off (→ page 383).
- ▶ Confirm the settings with **Finished**.
- ▶ **To start route guidance to the alternative route:** select **Start**.
- ▶ **To select an alternative route on the map:** touch any point on the alternative route. The alternative route is highlighted.

■ Activating a commuter route

Requirements

- You have created a profile (→ page 336).
- The **Allow destination suggestions** option is switched on (→ page 337).
- The **Activate commuter route** option is switched on .
- The multimedia system has gathered sufficient data in order to show destination suggestions.
- Routes have been learned for these destination suggestions.

- Route guidance is not active.

- ❗ This commuter route is not available in all countries.

Multimedia system:

→  ▶ **Navigation** ▶  ▶ **Route**

- ▶ Activate **Activate commuter route**.
The navigation system automatically detects that the vehicle is on a commuter route.
For the daily commuter route, traffic events on the route are also reported when driving without active route guidance.
- ▶ **To select commuter route:** select **Start**.
Route guidance begins without spoken driving instructions.

- ❗ A commuter route is suggested even with delays on the route.

- ▶ **To delete a commuter route:** select .

■ Adjusting the route on the map

Requirements:

- A route has already been created.

You can change the course of the original route on the map. A new intermediate destination is set in the process.

- ❗ If the maximum number of intermediate destinations is reached, the function is not supported. Press the **OK** button to confirm the message.

- ▶ Press lightly on the route with one finger and hold the finger in place. A symbol appears. The route can be changed.
- ▶ Drag and hold the route with your finger to a desired map position. The new route is displayed. The route is recalculated.

When the route is calculated, the journey time and distance are compared with the original route.

When the finger is pulled away from the display, the intermediate destination is shown on the map.

- ▶ Accept the route with **Confirm** or reject it with **Cancel** and return to the original route.

Switching the automatic filling station search on or off

Multimedia system:

 **Settings** **Vehicle**

- ▶ Select **Other functions**.
- ▶ Activate or deactivate **Automatic filling station search**.
If **Automatic filling station search** is switched on, a notification appears in which the search for filling stations is started.

Starting an automatic filling station search



Requirements

- The automatic filling station search is activated (→ page 389).

Driving situation

The fuel level in the fuel tank reaches the reserve fuel level.

The central display shows the following notification: **Reserve fuel** [Tap here to search for filling stations](#).

- ▶ Confirm the notification.
The automatic filling station search begins. The available filling stations along the route or in the vicinity of the vehicle's current position are displayed.
- ▶ Select a filling station.
- ▶ Calculate the route with the filling station as  an intermediate destination or as  a destination (→ page 381).
- ▶ **If there are already four intermediate destinations:** select **Yes** in the prompt.
The selected filling station is entered in the route overview at position 1. Intermediate destination 4 is deleted. Route guidance begins.



Starting the automatic service station search

Requirements:

- ATTENTION ASSIST is activated (→ page 224).
- You are driving on a motorway.
- There are service stations along the route section ahead.

Driving situation

The following notification is shown on the central display **ATTENTION ASSIST** [Tap here to search for rest areas..](#)

- ▶ Confirm the notification.
The service station search starts. The available service stations along the route or in the vicinity of the vehicle's current position are displayed.
- ▶ Select a service station.
- ▶ Calculate the route with the service station as an  intermediate destination or as a  destination (→ page 381).
- ▶ **If there are already four intermediate destinations:** select **Yes** in the prompt.
The selected service station is entered in the route overview at position 1. Intermediate destination 4 is deleted. Route guidance begins.

Starting and editing a stored route

Requirements:

- A USB device with stored routes is connected with the multimedia system (→ page 456).

- The route is stored in the "Routes" folder with the GPS Exchange format (.gpx).

Multimedia system:



- ▶ Press the double arrow in the destination input line until **Stored routes** is displayed.
- ▶ Select **Stored routes**.

Starting a saved route

- ▶ Select a route.
- ▶ Select **Start: route guidance at start** or **Start: current location**.
Route guidance begins.

Renaming a route

- ▶ Press on a route until a menu is shown.
- ▶ Select **Rename**.
- ▶ Enter the name.
- ▶ Select **OK**.

Recording and storing a route

Requirements:

- A USB device is connected with the multimedia system (→ page 456).

Multimedia system:



- ▶ Press the double arrow in the destination input line until **Stored routes** is displayed.
- ▶ Select **Stored routes**.

Starting recording

- ▶ Select **Start recording**.
A white rectangle is displayed.
The route is stored on the USB device.

Stopping recording

- ▶ Press the white rectangle.
- ▶ Select **End recording**.

Route guidance

Notes on route guidance

⚠ WARNING Risk of distraction from operating integrated communication equipment while the vehicle is in motion

If you operate communication equipment integrated in the vehicle when driving, you could be distracted from the traffic situation. This could also cause you to lose control of the vehicle.

- ▶ Only operate this equipment when the traffic situation permits.
- ▶ If you cannot be sure of this, stop the vehicle whilst paying attention to road and traffic conditions and operate the equipment with the vehicle stationary.

You must observe the legal requirements for the country in which you are currently driving when operating the multimedia system. Route guidance begins once a route has been calculated. The road and traffic rules and regulations always have priority over multimedia system driv-

ing instructions. Driving instructions are, for example navigation announcements, changes in direction and lane recommendations.

Changes in direction and lane recommendations are shown in the navigation window.

The following displays and functions are also available in the navigation window, for example:

- Route list
- Destination information
- Traffic information, e.g. length of traffic jam, delay
- Motorway facilities
- Car park search
- Emergency lanes

If you do not follow the driving instructions or if you leave the calculated route, a new route is calculated automatically.

If, for example, the route is diverted or the direction of a one-way road has been reversed, driving instructions may deviate from the actual traffic situation.

Alternatives may be offered during route guidance, e.g. before passing a motorway exit road. The additional driving time for the journey along the motorway exit is shown.

For this reason, you must always observe road and traffic rules and regulations during your journey as well as the prevailing traffic conditions.

The route can differ from the ideal route, for example in the event of roadworks or incomplete digital map data.

Notes on satellite reception

The correct function of the navigation system depends amongst other things on reception of the satellite system used. In certain situations satellite reception can be impaired, malfunction or even not possible, e.g. in tunnels or in multi-storey car parks.

Changing direction overview

Changes of direction are shown in the following displays:

- Detailed image of the junction

The display appears when you drive into a junction.

- 3D image

The display appears when driving on junction-free, multi-lane roads, for example at motorway exits and motorway interchanges.



Example: detailed image of the crossing with upcoming changes of direction

- 1 Name of the street to turn into
- 2 Blue highlighted route (also on the map)
- 3 Current distance to the change of direction



Example: 3D image of the upcoming change of direction

- ① Manoeuvre point
- ② Blue highlighted route (also on the map)

Larger map scales show change of direction points instead of change of direction arrows.

- ③ Current vehicle position
- ④ Current distance to the change of direction

There are three phases when changing direction:

- Preparation phase

If there is enough time between the changes of direction, the multimedia system prepares you for the upcoming change of direction. A

navigation announcement is issued, e.g. "Prepare to turn right".

The navigation window shows: the direction information or the name of the road which is to be turned into as well as the distance to the change of direction.

- Announcement phase

The multimedia system announces the upcoming change of direction, e.g. by announcing "Turn right in 300 m".

When the **Auto zoom** map orientation is switched off (→ page 405), a detailed representation of the junction or a 3D image of the upcoming change of direction appears in the navigation window.

- Change-of-direction phase

The multimedia system announces the imminent change of direction, e.g. by announcing "Now turn right".

Example 3D image: when the distance to the driving manoeuvre ① is displayed with 0 m the driving manoeuvre is performed.

- ① Changes in direction are also displayed on the driver's display and head-up display.

■ Lane recommendations overview



Example: lane recommendations

- ① Lane not recommended (grey arrow)
- ② Possible lane (white arrow)
- ③ Recommended lane (white arrow, blue background)

This display appears for multi-lane roads.

If the digital map contains the relevant data, lane recommendations are displayed in the navigation window.

Explanation of the displayed lanes:

- Recommended lane
In this lane, you will be able to complete both the next change of direction and the one after that.
- Possible lane
In this lane, you will only be able to complete the next change of direction.
- Non-recommended lane
In this lane, you will not be able to complete the next change of direction without changing lane.

During the change of direction, new lanes may be added. Bus lanes are also shown.

- ❗ Lane recommendations are also displayed on the driver's display and head-up display.

Using motorway information

When driving on the motorway, upcoming motorway facilities and available service facilities are shown in the route list. These include car parks, service stations or motorway exits with service POIs, for example.

The entries are sorted according to increasing distance from the current vehicle position.

- ▶ Select an entry.
 - ▶ If several service facilities are available, select a service facility from the list. The destination address and the map position are shown.
 - ▶ Calculate the route (→ page 381).
- or
- ▶ Search for a POI in the vicinity.
- or
- ▶ Use other functions, e.g. store the destination address of the service facility.

Destination reached

Once the destination is reached, you will see the  chequered flag. Route guidance will now be complete. The navigation menu is shown.



When an intermediate destination has been reached, you will see the intermediate destination flag with the number of your  intermediate destination. Route guidance is continued.

Switching navigation announcements on or off



Switching off

- ▶ Press the  button on the steering wheel or on the MBUX multimedia system during a navigation announcement (→ page 342). The **Spoken driving recommendations have been deactivated.** message appears.

or

- ▶ Show the navigation menu (→ page 374).
 - ▶ Select .
- The symbol changes to .



Switching on

- ▶ In the navigation window, select  for an upcoming driving manoeuvre. The current navigation announcement is played.
- The symbol changes to .

Switching navigation announcements on or off during a phone call



- ▶ Press the  button on the steering wheel on the right.

or

- ▶ Press  in the central display.
- ▶ Select **Settings**.
- ▶ Select **System**.
- ▶ Select **Audio**.
- ▶ **Select Voice output.**
- ▶ Activate or deactivate **Driving recommendations during call**.
- ▶ **To leave the menu:** select .

Adjusting the volume of navigation announcements

Multimedia system:

- ▶  ▶ **Settings** ▶ **System** ▶ **Audio** ▶ **Voice output**
- ▶ Select **Driving recommendation vol..**
- ▶ Set the volume.
- ▶ **To leave the menu:** select .



Route guidance is active

- ▶ Set the volume during a navigation announcement on the steering wheel or under the touchscreen .

Switching audio fadeout on or off during navigation announcements

- ▶ Press the  button on the steering wheel on the right.

or





- ▶ Press  in the central display.
- ▶ Select **Settings**.
- ▶ Select **System**.
- ▶ Select **Audio**.
- ▶ **Select Voice output.**
- ▶ Activate or deactivate **Lower audio for driving recomm..**
- ▶ **To leave the menu:** select .

Repeating navigation announcements

Requirements

- A route has already been created.
- Route guidance is active.

Multimedia system:

- ▶  
- ▶ In the navigation window, select  for an upcoming driving manoeuvre.
- ▶ Select . The current navigation announcement is repeated.

■ Cancelling route guidance

Requirements

- A route has already been created.
- Route guidance is active.
- ▶ Select  in the navigation module (→ page 374).

■ Overview of off-road status during route guidance

Due to roadworks, for example, there may be differences between the data on the digital map and the actual course of the road. In such cases, the multimedia system will temporarily be unable to locate the vehicle's current position on the digital map. The vehicle is off-road.

You can see the **Please follow the arrow** display and hear the corresponding navigation announcement. Route guidance may be restricted.

When the vehicle is back on a road known to the multimedia system, route guidance continues as normal.

Destination

Saving the current vehicle position

Multimedia system:



- ▶ When the map is shown, tap on the  current vehicle position.
- ▶ Select **Store position**.
- ▶ **To save as a favourite:** select **Save as favourite**.
- ▶ **To save as "Home" address:** select **Home**.
- ▶ **To save as "Work" address:** select **Work**.

Managing previous destinations

Multimedia system:



- ▶ Select **Previous destinations**.

Saving the last destination as a favourite

- ▶ **For a last destination, select .**

A menu appears.

- ▶ **To save as a favourite:** select **Save as favourite**.
- ▶ **To save as "Home" address:** select **Home**.
- ▶ **To save as "Work" address:** select **Work**.

Deleting a previous destination

- ▶ **For a last destination, select .**

- ▶ Select **Delete**.

or

- ▶ Select **Delete all**.
- ▶ Confirm the prompt.

Editing destination suggestions

Requirements:

- The **Allow destination suggestions** option is switched on (→ page 359).
- For the display of destination suggestions: the multimedia system has gathered sufficient data.

Multimedia system:



- ▶ Press and hold on a destination suggestion. A menu appears.
- ▶ **To cancel a destination suggestion:** select **Do not suggest now** or **Do not suggest**.
- ▶ **To save a destination suggestion:** select **Save as favourite**, **Home** or **Work**.
- ⓘ Delete a destination suggestion from the favourites (→ page 380).

Route guidance with current traffic reports

Traffic information overview

Current traffic reports are received with the Live Traffic Information subscription service.

- ❗ Live Traffic Information is not available in all countries.

The service must be registered in the Mercedes me user account (→ page 396). This ensures the free usage period.

The service updates the traffic situation via the Internet connection at short, regular intervals.

Information on the vehicle's position is regularly sent to Mercedes-Benz AG. The data is immediately rendered anonymous by Mercedes-Benz AG and forwarded to the traffic data provider. Using this data, traffic reports relevant to the vehicle's position are sent to the vehicle. The vehicle acts as a sensor for the flow of traffic and helps to improve the quality of the traffic reports.

- ❗ There may be differences between the traffic reports received and the actual road and traffic conditions.

If you do not want to transmit the vehicle position, you have the following options:

- You deactivate the service in the Mercedes me user account.
 - You have the service deactivated at a Mercedes-Benz service centre.
- ❗ Hazard warnings can be received using the Car-to-X service (→ page 398).

Showing information from the service provider for Live Traffic Information

Requirements:

- The vehicle is equipped with Live Traffic Information.

Multimedia system:

→  » Apps » Mercedes me
» My services

▶ Select **Live Traffic Information**.

Registering Live Traffic Information

Requirements

- You have a Mercedes me user account.

- The vehicle is equipped with Live Traffic Information.

- ▶ Create a Mercedes me user account at: <https://www.mercedes.me>. A valid email address is required for this.
- ▶ Register the vehicle using the vehicle identification number (VIN).
- ▶ Connect the vehicle with your Mercedes me user account. A code is sent to the multimedia system.
- ▶ Enter the code into the multimedia system.
- ▶ Accept the general and specific terms of use.
- ❗ Alternatively, you can have the connection completed at a Mercedes-Benz service centre.

Extending a Live Traffic Information subscription

Requirements:

- You have a Mercedes me user account.
- The vehicle is equipped with Live Traffic Information.