

RADIO TEST REPORT

FCC 47 CFR PART 15 SUBPART C

Test Standard	FCC Part 15.247
Product name	COMMUN.CONT.UNIT ASSY(BT Dongle)
Brand Name	YAMAHA
Model No.	Y08U-A01
Test Result	Pass
Statements of Conformity	Determination of compliance is based on the results of the compliance measurement, not taking into account measurement instrumentation uncertainty.

The test Result was tested by Compliance Certification Services Inc. The test data, data evaluation, test procedures, and equipment configurations shown in this report were given in ANSI C63.10: 2013 and compliance standards.

The test results of this report relate only to the tested sample (EUT) identified in this report.

The test Report of full or partial shall not copy. Without written approval of Compliance Certification Services Inc. (Wugu Laboratory)

Approved by:

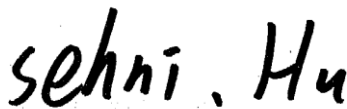

Sehni Hu
Supervisor

Unless otherwise stated the results shown in this test report refer only to the sample(s) tested and such sample(s) are retained for 90 days only.
除非另有說明，此報告結果僅對測試之樣品負責，同時此樣品僅保留90天。本報告未經本公司書面許可，不可部份複製。

This document is issued by the Company subject to its General Conditions of Service printed overleaf, available on request or accessible at <http://www.sgs.com.tw/Terms-and-Conditions> and, for electronic format documents, subject to Terms and Conditions for Electronic Documents at <http://www.sgs.com.tw/Terms-and-Conditions>. Attention is drawn to the limitation of liability, indemnification and jurisdiction issues defined therein. Any holder of this document is advised that information contained hereon reflects the Company's findings at the time of its intervention only and within the limits of client's instruction, if any. The Company's sole responsibility is to its Client and this document does not exonerate parties to a transaction from exercising all their rights and obligations under the transaction documents. This document cannot be reproduced, except in full, without prior written approval of the Company. Any unauthorized alteration, forgery or falsification of the content or appearance of this document is unlawful and offenders may be prosecuted to the fullest extent of the law.

Revision History

Rev.	Issue Date	Revisions	Effect Page	Revised By
00	January 6, 2023	Initial Issue	ALL	Doris Chu

Table of contents

1.	GENERAL INFORMATION	4
1.1	EUT INFORMATION	4
1.2	EUT CHANNEL INFORMATION	5
1.3	ANTENNA INFORMATION	5
1.4	MEASUREMENT UNCERTAINTY.....	6
1.5	FACILITIES AND TEST LOCATION	7
1.6	INSTRUMENT CALIBRATION	8
1.7	SUPPORT AND EUT ACCESSORIES EQUIPMENT	10
1.8	TEST METHODOLOGY AND APPLIED STANDARDS	10
2.	TEST SUMMARY	11
3.	DESCRIPTION OF TEST MODES.....	12
3.1	THE WORST MODE OF OPERATING CONDITION	12
3.2	THE WORST MODE OF MEASUREMENT	13
3.3	EUT DUTY CYCLE.....	14
4.	TEST RESULT	15
4.1	AC POWER LINE CONDUCTED EMISSION	15
4.2	6DB BANDWIDTH AND OCCUPIED BANDWIDTH (99%)	16
4.3	OUTPUT POWER MEASUREMENT	22
4.4	POWER SPECTRAL DENSITY.....	24
4.5	CONDUCTED BAND EDGE AND SPURIOUS EMISSION	28
4.6	RADIATION BANDEDGE AND SPURIOUS EMISSION	35
APPENDIX 1 - PHOTOGRAPHS OF EUT		

Report No.: TMWK2212005033KR

1. GENERAL INFORMATION

1.1 EUT INFORMATION

Applicant	CHAO LONG MOTOR PARTS CORP. No.10, Lane 151, Sec.2, Guangming Rd., Luzhu Dist., Taoyuan City, 33848 Taiwan
Manufacturer	PT Chao Long Motor Parts Indonesia. Jl. Meranti I Blok L2 No.5-6, Delta Silicon Industrial Park Lippo Cikarang,Bekasi, Jawa Barat 17750 Indonesia
Equipment	COMMUN.CONT.UNIT ASSY(BT Dongle)
Model Name	Y08U-A01
Model Discrepancy	N/A
Brand Name	YAMAHA
Received Date	December 6, 2022
Date of Test	December 8 ~ 12, 2022
Power Supply	Power from Battery. (DC 12V)

Remark:

1. For more details, please refer to the User's manual of the EUT.
2. Disclaimer: Antenna information is provided by the applicant, test results of this report are applicable to the sample EUT received.

Report No.: TMWK2212005033KR

1.2 EUT CHANNEL INFORMATION

Frequency Range	2402MHz-2480MHz
Modulation Type	GFSK for BLE 1 Mbps GFSK for BLE 2 Mbps
Number of channels	40 Channels

Remark:

Refer as ANSI C63.10: 2013 clause 5.6.1 Table 4 for test channels

Number of frequencies to be tested		
Frequency range in which device operates	Number of frequencies	Location in frequency range of operation
<input type="checkbox"/> 1 MHz or less	1	Middle
<input type="checkbox"/> 1 MHz to 10 MHz	2	1 near top and 1 near bottom
<input checked="" type="checkbox"/> More than 10 MHz	3	1 near top, 1 near middle, and 1 near bottom

1.3 ANTENNA INFORMATION

Antenna Specification	<input type="checkbox"/> PIFA <input checked="" type="checkbox"/> PCB <input type="checkbox"/> Dipole <input type="checkbox"/> Coils
Antenna Gain	Gain: 2 dBi
Antenna connector	N/A

Notes:

1.The antenna(s) of the EUT are permanently attached and there are no provisions for connection to an external antenna. So the EUT complies with the requirements of §15.203.

1.4 MEASUREMENT UNCERTAINTY

PARAMETER	UNCERTAINTY
AC Powerline Conducted Emission	± 2.1183
Channel Bandwidth	± 2.1863
RF output power (Power Meter + Power sensor)	± 1.2688
Power Spectral density	± 2.1855
Conducted Bandedge	± 2.1866
Conducted Spurious Emission	± 2.1859
Radiated Emission_9kHz-30MHz	± 3.814
Radiated Emission_30MHz-200MHz	± 4.272
Radiated Emission_200MHz-1GHz	± 4.619
Radiated Emission_1GHz-6GHz	± 5.522
Radiated Emission_6GHz-18GHz	± 5.228
Radiated Emission_18GHz-26GHz	± 4.089
Radiated Emission_26GHz-40GHz	± 4.019

Remark:

- 1.This uncertainty represents an expanded uncertainty expressed at approximately the 95% confidence level using a coverage factor of k=2
2. ISO/IEC 17025 requires that an estimate of the measurement uncertainties associated with the emissions test results be included in the report.

1.5 FACILITIES AND TEST LOCATION

All measurement facilities used to collect the measurement data are located at

No.11, Wugong 6th Rd., Wugu Dist., New Taipei City, Taiwan.

No. 12, Ln. 116, Wugong 3rd Rd., Wugu Dist., New Taipei City, Taiwan 24803

CAB identifier: TW1309

Test site	Test Engineer	Remark
AC Conduction Room	-	Not applicable, because EUT not connect to AC Main Source direct.
Radiation	Ray Li	-
RF Conducted	Jack Chen	-

Remark: The lab has been recognized as the FCC accredited lab. under the KDB 974614 D01 and is listed in the FCC public Access Link (PAL) database, FCC Registration No. :444940, the FCC Designation No.:TW1309

1.6 INSTRUMENT CALIBRATION

RF Conducted Test Site					
Name of Equipment	Manufacturer	Model	Serial Number	Calibration Date	Calibration Due
Power Meter	Anritsu	ML2496A	2136002	2022-11-24	2023-11-23
EXA Signal Analyzer	Keysight	N9010B	MY60242460	2022-01-30	2023-01-29
Power Sensor	Anritsu	MA2411B	1911386	2022-08-08	2023-08-07
Power Sensor	Anritsu	MA2411B	1911387	2022-08-08	2023-08-07
Software	Radio Test Software Ver. 21				

3M 966 Chamber Test Site (Bandedge+TX_30MHz~18GHz)					
Name of Equipment	Manufacturer	Model	Serial Number	Calibration Date	Calibration Due
High Pass Filters	Titan Microwave	T04H30001800070S01	22011402-4	2022-06-29	2023-06-28
PXA Signal Analyzer	Keysight Technologies	N9030B	MY62291089	2022-10-14	2023-10-13
Loop Antenna	COM-POWER	AL-130	121051	2022-04-13	2023-04-12
Preamplifier	EMEC	EM330	060609	2022-02-23	2023-02-22
Thermo-Hygro Meter	WISEWIND	1110	D06	2021-12-28	2022-12-27
Preamplifier	HP	8449B	3008A00965	2021-12-24	2022-12-23
Bi-Log Antenna	Sunol Sciences	JB3	A030105	2022-08-03	2023-08-02
Cable	Huber+Suhner	104PEA	20995+11112+182330	2022-02-23	2023-02-22
Coaxial Cable	EMCI	EMC105	190914+33953	2022-06-15	2023-06-14
Horn Antenna	ETC	MCTD 1209	DRH13M02003	2022-01-25	2023-01-24
Turn Table	CCS	CC-T-1F	N/A	N.C.R	N.C.R
Controller	CCS	CC-C-1F	N/A	N.C.R	N.C.R
Antenna Tower	CCS	CC-A-1F	N/A	N.C.R	N.C.R
Software	e3 V9-210616c				

3M 966 Chamber Test Site (TX18GHz~26.5GHz)					
Name of Equipment	Manufacturer	Model	Serial Number	Calibration Date	Calibration Due
High Pass Filters	Titan Microwave	T04H30001800070S0 1	22011402-4	2022-06-29	2023-06-28
PXA Signal Analyzer	Keysight Technologies	N9030B	MY62291089	2022-10-14	2023-10-13
Thermo-Hygro Meter	WISEWIND	1110	D06	2021-12-28	2022-12-27
Preamplifier	HP	8449B	3008A00965	2021-12-24	2022-12-23
Cable	Huber+Suhner	104PEA	20995+11112+182330	2022-02-23	2023-02-22
Coaxial Cable	EMCI	EMC105	190914+33953	2022-06-15	2023-06-14
Horn Antenna	SCHWARZBECK	BBHA9170	1047	2022-01-11	2023-01-10
Pre-Amplifier	EMCI	EMC184045SE	980860	2021-12-28	2022-12-27
Cable	EMCI	EMC101G	211010+211011+2110 12	2022-12-12	2023-12-11
Turn Table	CCS	CC-T-1F	N/A	N.C.R	N.C.R
Controller	CCS	CC-C-1F	N/A	N.C.R	N.C.R
Antenna Tower	CCS	CC-A-1F	N/A	N.C.R	N.C.R
Software	e3 6.11-20180419c				

AC Conducted Emissions Test Site					
Equipment	Manufacturer	Model	S/N	Cal Date	Cal Due
N/A					

Remark:

1. Each piece of equipment is scheduled for calibration once a year.
2. N.C.R. = No Calibration Required.

1.7 SUPPORT AND EUT ACCESSORIES EQUIPMENT

EUT Accessories Equipment						
No.	Equipment	Brand	Model	Series No.	FCC ID	IC
	N/A					

Support Equipment						
No.	Equipment	Brand	Model	Series No.	FCC ID	IC
1	NB(E)	Lenovo	T460	N/A	N/A	N/A
2	Battery	YUASA	75D23L	N/A	N/A	N/A

1.8 TEST METHODOLOGY AND APPLIED STANDARDS

The test methodology, setups and results comply with all requirements in accordance with ANSI C63.10:2013, FCC Part 2, FCC Part 15.247 and FCC KDB 558074 D01.

2. TEST SUMMARY

FCC Standard Section	Report Section	Test Item	Result
15.203	1.3	Antenna Requirement	Pass
15.207(a)	4.1	AC Conducted Emission	N/A
15.247(a)(2)	4.2	6 dB Bandwidth	Pass
-	4.2	Occupied Bandwidth (99%)	Pass
15.247(b)(3)	4.3	Output Power Measurement	Pass
15.247(e)	4.4	Power Spectral Density	Pass
15.247(d)	4.5	Conducted Band Edge	Pass
15.247(d)	4.5	Conducted Spurious Emission	Pass
15.247(d)	4.6	Radiation Band Edge	Pass
15.247(d)	4.6	Radiation Spurious Emission	Pass

Report No.: TMWK2212005033KR

3. DESCRIPTION OF TEST MODES

3.1 THE WORST MODE OF OPERATING CONDITION

Operation mode	BLE Mode (1Mbps) BLE Mode (2Mbps)
Test Channel Frequencies	1.Lowest Channel : 2402MHz 2.Middle Channel : 2440MHz 3.Highest Channel : 2480MHz

Remark:

1. EUT pre-scanned data rate of output power for each mode, the worst data rate were recorded in this report.

Report No.: TMWK2212005033KR

3.2 THE WORST MODE OF MEASUREMENT

Radiated Emission Measurement Above 1G	
Test Condition	Radiated Emission Above 1G
Power supply Mode	Mode 1: EUT power by Battery
Worst Mode	<input checked="" type="checkbox"/> Mode 1 <input type="checkbox"/> Mode 2 <input type="checkbox"/> Mode 3 <input type="checkbox"/> Mode 4
Worst Position	<input type="checkbox"/> Placed in fixed position. <input type="checkbox"/> Placed in fixed position at X-Plane (E2-Plane) <input checked="" type="checkbox"/> Placed in fixed position at Y-Plane (E1-Plane) <input type="checkbox"/> Placed in fixed position at Z-Plane (H-Plane)

Radiated Emission Measurement Below 1G	
Test Condition	Radiated Emission Below 1G
Power supply Mode	Mode 1: EUT power by Battery
Worst Mode	<input checked="" type="checkbox"/> Mode 1 <input type="checkbox"/> Mode 2 <input type="checkbox"/> Mode 3 <input type="checkbox"/> Mode 4

Remark:

1. The worst mode was record in this test report.
2. EUT pre-scanned in three axis ,X,Y, Z and two polarity, for radiated measurement. The worst case(Y-Plane) were recorded in this report
3. For below 1G radiation emission were performed the EUT transmit at the highest output power channel as worst case.

Report No.: TMWK2212005033KR

3.3 EUT DUTY CYCLE

Temperature: 23.2°C

Test date: December 8, 2022

Humidity: 60% RH

Tested by: Jack Chen

Duty Cycle				
Configuration	Duty Cycle (%) = Ton / (Ton+Toff)	Duty Factor (dB) =10*log (1/Duty Cycle)	1/T (kHz)	VBW setting (kHz)
BLE 1M	63.20	1.99	2.53	3.00
BLE 2M	32.80	4.84	4.88	5.00

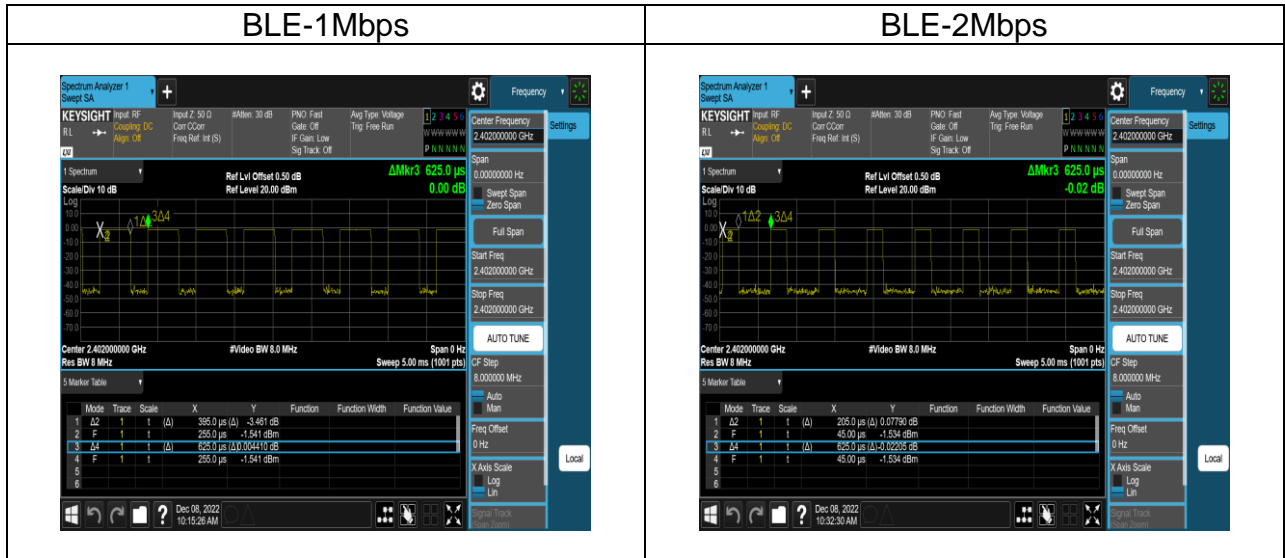

Report No.: TMWK2212005033KR

4. TEST RESULT

4.1 AC POWER LINE CONDUCTED EMISSION

4.1.1 Test Limit

According to §15.207(a),

Frequency Range (MHz)	Limits(dB μ V)	
	Quasi-peak	Average
0.15 to 0.50	66 to 56*	56 to 46*
0.50 to 5	56	46
5 to 30	60	50

* Decreases with the logarithm of the frequency.

4.1.2 Test Procedure

Test method Refer as ANSI C63.10: 2013 clause 6.2,

1. The EUT was placed above horizontal ground plane and 0.4m above vertical ground plane
2. EUT connected to the line impedance stabilization network (LISN)
3. Receiver set RBW of 9kHz and Detector Peak, and note as quasi-peak and average.
4. Maximum procedure was performed on the six highest emissions to ensure EUT compliance.
5. Recorded Line for Neutral and Line.

4.1.3 Test Setup

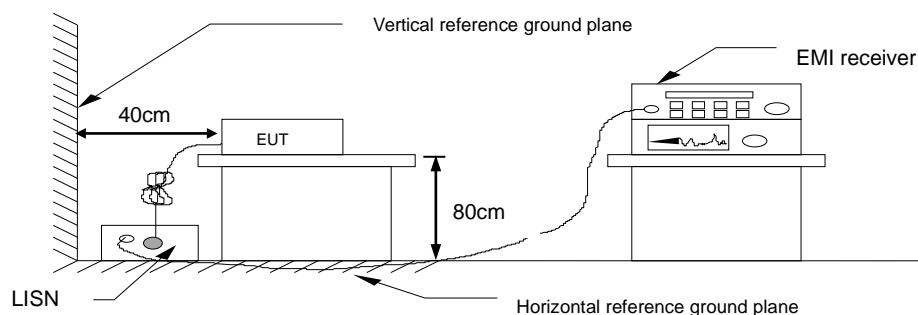

4.1.4 Test Result

Not applicable, because EUT not connect to AC Main Source direct.

Report No.: TMWK2212005033KR

4.2 6dB BANDWIDTH AND OCCUPIED BANDWIDTH (99%)

4.2.1 Test Limit

According to §15.247(a)(2)

6 dB Bandwidth :

Limit	Shall be at least 500kHz
-------	--------------------------

Occupied Bandwidth(99%) : For reporting purposes only.

4.2.2 Test Procedure

Test method Refer as ANSI C63.10: 2013,

1. The EUT RF output connected to the spectrum analyzer by RF cable.
2. Setting maximum power transmit of EUT.
3. SA set RBW =100KHz, VBW = 300KHz and Detector = Peak, to measurement 6dB Bandwidth.
4. SA set RBW = 1% ~ 5% OBW, VBW = three times the RBW and Detector = Peak, to measurement 99% Bandwidth.
5. Measure and record the result of 6 dB Bandwidth and 99% Bandwidth. in the test report.

4.2.3 Test Setup

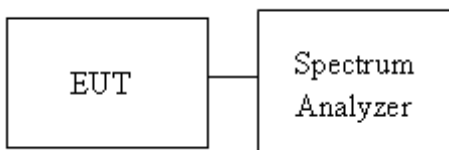

Report No.: TMWK2212005033KR

4.2.4 Test Result

Temperature: 23.2°C

Test date: December 8, 2022

Humidity: 60% RH

Tested by: Jack Chen

Test mode: BLE-1Mbps mode / 2402-2480 MHz				
Channel	Frequency (MHz)	OBW (99%) (MHz)	6dB BW (MHz)	6dB limit (kHz)
Low	2402	1.0404	0.7062	≥500
Mid	2440	1.0419	0.7086	
High	2480	1.0439	0.7099	

Test mode: BLE-2Mbps mode / 2402-2480 MHz				
Channel	Frequency (MHz)	OBW (99%) (MHz)	6dB BW (MHz)	6dB limit (kHz)
Low	2402	2.0401	1.157	≥500
Mid	2440	2.0403	1.156	
High	2480	2.0453	1.155	

Report No.: TMWK2212005033KR

Test Data

6dB BANDWIDTH

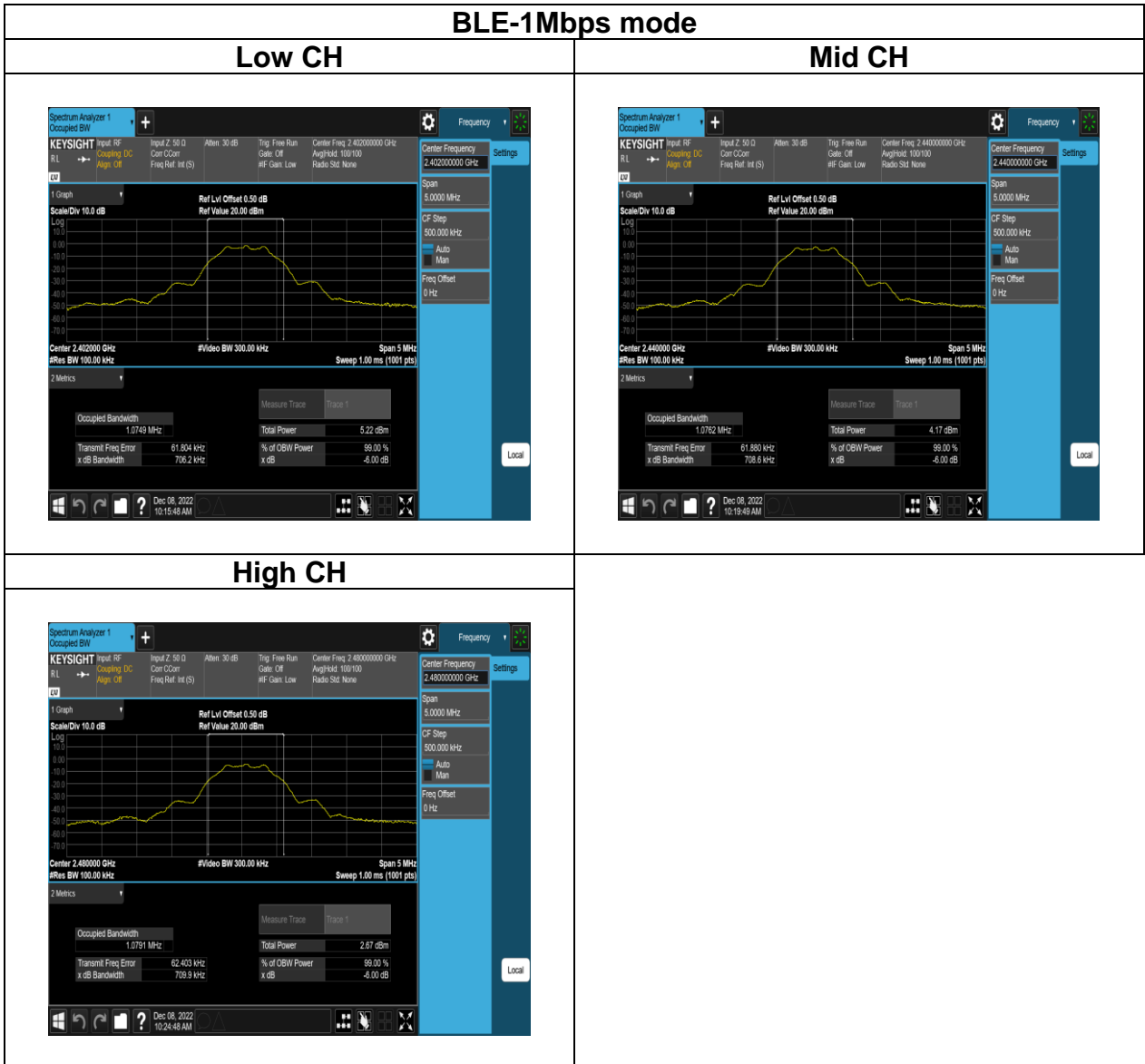

Report No.: TMWK2212005033KR

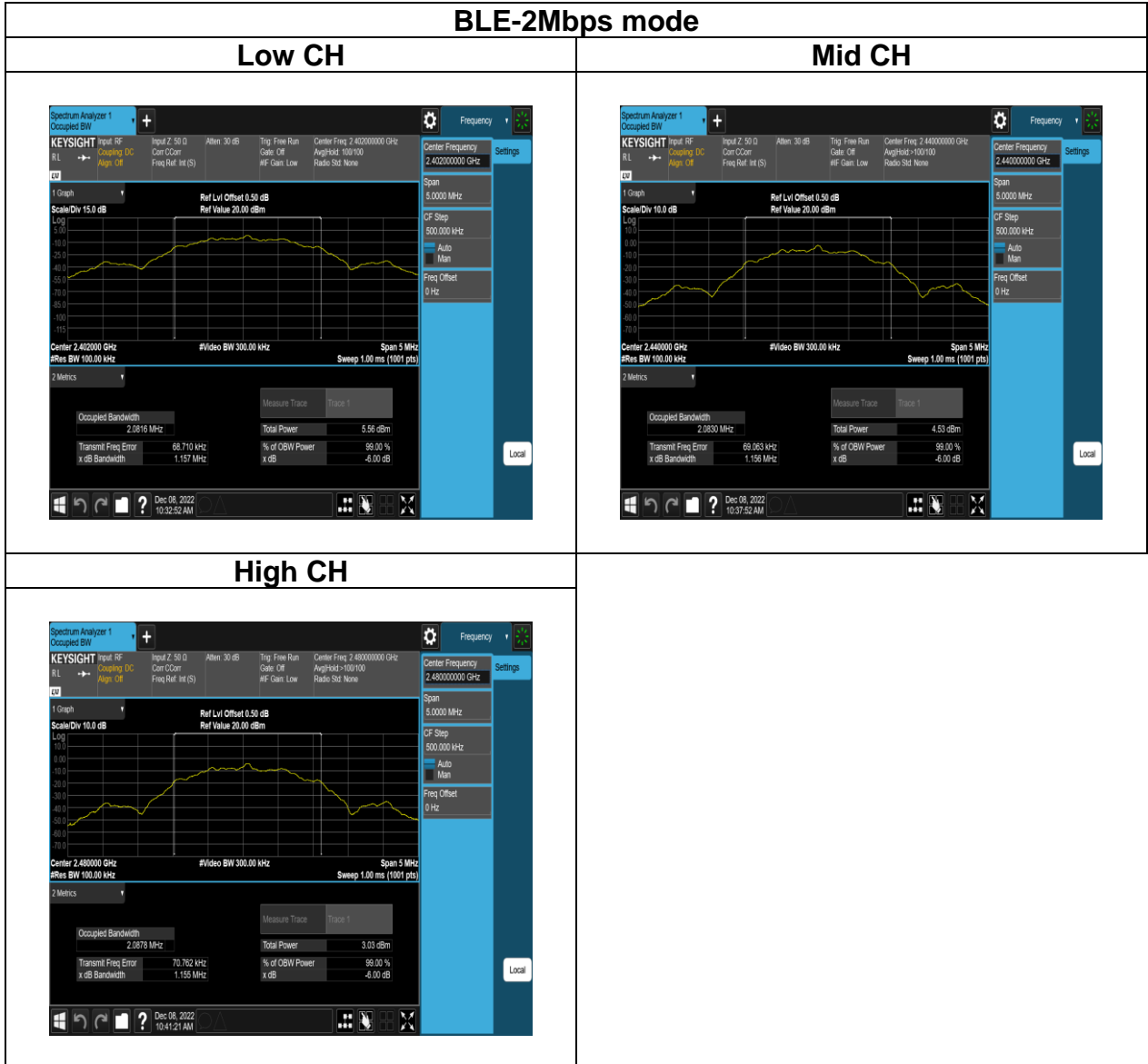

Report No.: TMWK2212005033KR

Test Data

BANDWIDTH (99%)

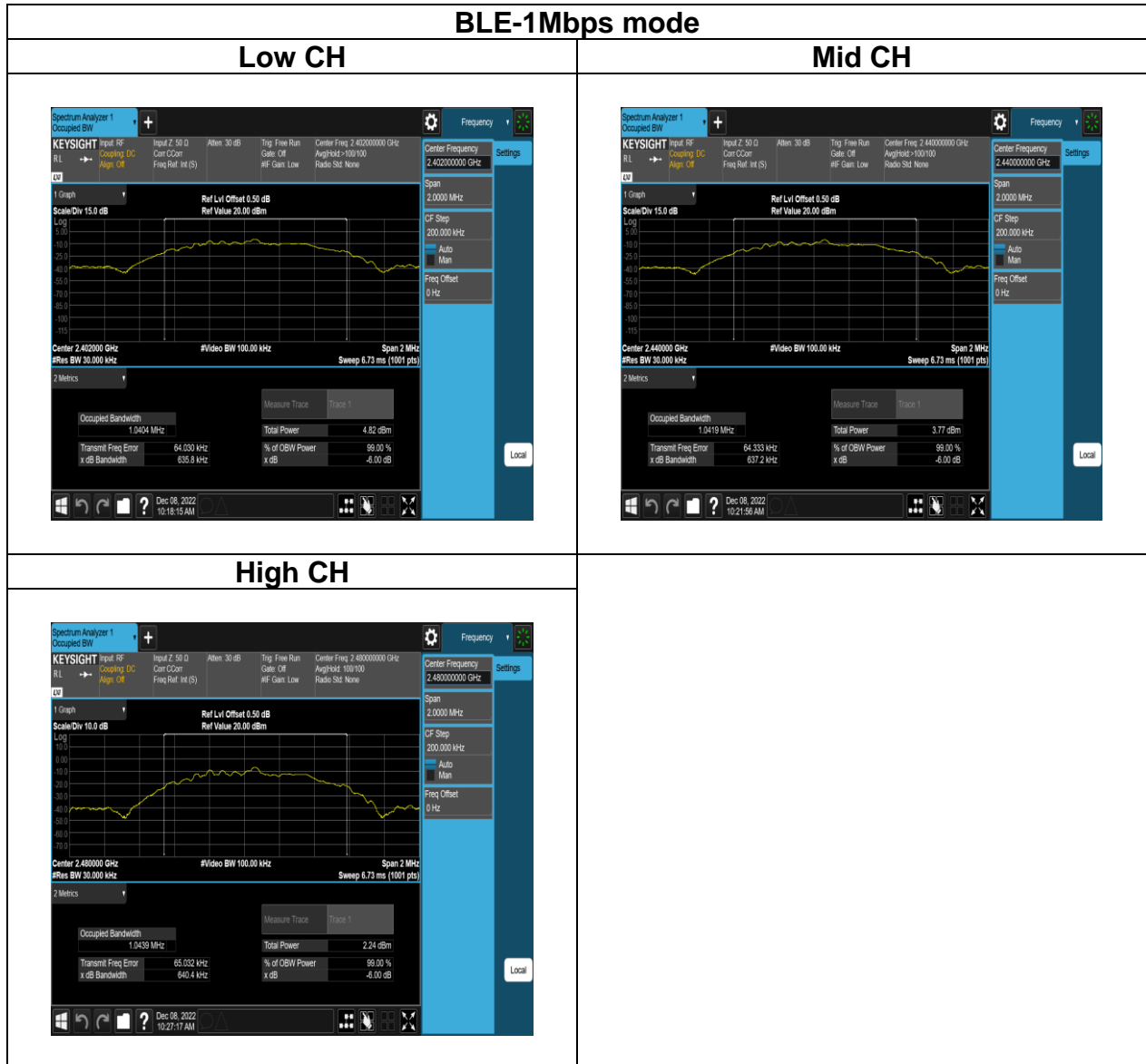

Report No.: TMWK2212005033KR

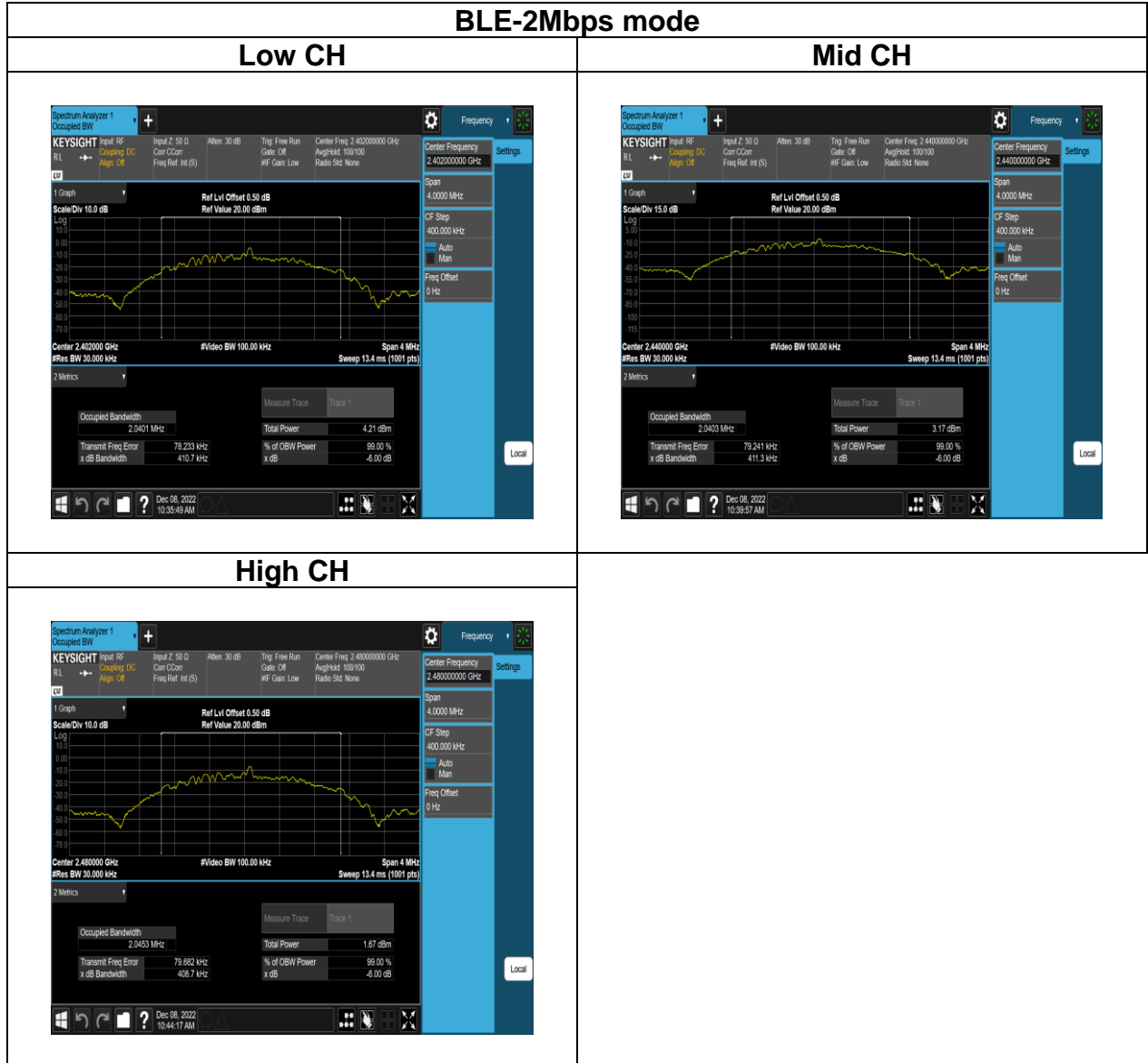

Report No.: TMWK2212005033KR

4.3 OUTPUT POWER MEASUREMENT

4.3.1 Test Limit

According to §15.247(b)(3)

Peak output power :

FCC

For systems using digital modulation in the 902-928 MHz, 2400-2483.5 MHz, and 5725-5850 MHz bands: 1 Watt. As an alternative to a peak power measurement,

Limit	<input checked="" type="checkbox"/> Antenna not exceed 6 dBi : 30dBm <input type="checkbox"/> Antenna with DG greater than 6 dBi [Limit = 30 – (DG – 6)] <input type="checkbox"/> Point-to-point operation
-------	---

Average output power : For reporting purposes only.

4.3.2 Test Procedure

Test method Refer as ANSI C63.10:2013.

1. The EUT RF output connected to the power meter by RF cable.
2. Setting maximum power transmit of EUT.
3. The path loss was compensated to the results for each measurement.
4. Measure and record the result of Peak output power and Average output power. in the test report.

4.3.3 Test Setup

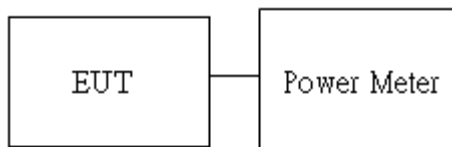

4.3.4 Test Result

Temperature: 23.2°C

Test date: December 8, 2022

Humidity: 60% RH

Tested by: Jack Chen

Peak output power :

BLE 1M mode:

CH	Frequency (MHz)	Power set	Peak Power Output (dBm)	Required Limit (dBm)
Low	2402	default	-1.41	30
Mid	2440	default	-2.59	30
High	2480	default	-4.31	30

BLE 2M mode:

CH	Frequency (MHz)	Power set	Peak Power Output (dBm)	Required Limit (dBm)
Low	2402	default	-1.40	30
Mid	2440	default	-2.57	30
High	2480	default	-4.32	30

Average output power :

BLE 1M mode:

CH	Frequency (MHz)	Power set	Average Power Output (dBm)	Required Limit (dBm)
Low	2402	default	-4.06	30
Mid	2440	default	-5.16	30
High	2480	default	-7.10	30

BLE 2M mode:

CH	Frequency (MHz)	Power set	Average Power Output (dBm)	Required Limit (dBm)
Low	2402	default	-1.66	30
Mid	2440	default	-2.87	30
High	2480	default	-4.63	30

Report No.: TMWK2212005033KR

4.4 POWER SPECTRAL DENSITY

4.4.1 Test Limit

According to §15.247(e)

For digitally modulated systems, the power spectral density conducted from the intentional radiator to the antenna shall not be greater than 8 dBm in any 3 kHz band during any time interval of continuous transmission.

Limit	<input checked="" type="checkbox"/> Antenna not exceed 6 dBi : 8dBm <input type="checkbox"/> Antenna with DG greater than 6 dBi [Limit = 8 – (DG – 6)] <input type="checkbox"/> Point-to-point operation :
-------	---

4.4.2 Test Procedure

Test method Refer as ANSI C63.10:2013.

1. The EUT RF output connected to the spectrum analyzer by RF cable.
2. Setting maximum power transmit of EUT
3. SA set RBW = 3kHz, VBW = 10kHz, Span = 1.5 times DTS Bandwidth (6 dB BW), Detector = Peak, Sweep Time = Auto and Trace = Max hold.
4. The path loss and Duty Factor were compensated to the results for each measurement by SA.
5. Mark the maximum level.
6. Measure and record the result of power spectral density. in the test report.

4.4.3 Test Setup



4.4.4 Test Result

Temperature: 23.2°C

Test date: December 8, 2022

Humidity: 60% RH

Tested by: Jack Chen

BLE 1M mode

Frequency (MHz)	RF Power Density (dBm/3kHz)	Maximum Limit (dBm/3kHz)	Result
2402	-16.890	8	PASS
2440	-18.020	8	PASS
2480	-19.450	8	PASS

BLE 2M mode

Frequency (MHz)	RF Power Density (dBm/3kHz)	Maximum Limit (dBm/3kHz)	Result
2402	-19.450	8	PASS
2440	-20.600	8	PASS
2480	-21.960	8	PASS

Report No.: TMWK2212005033KR

Test Data

BLE-1Mbps mode

Low CH

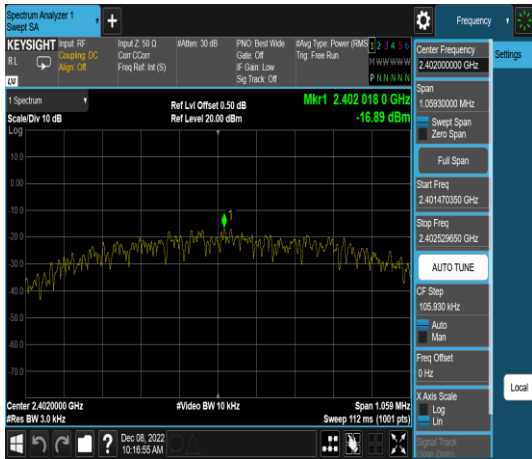

Mid CH

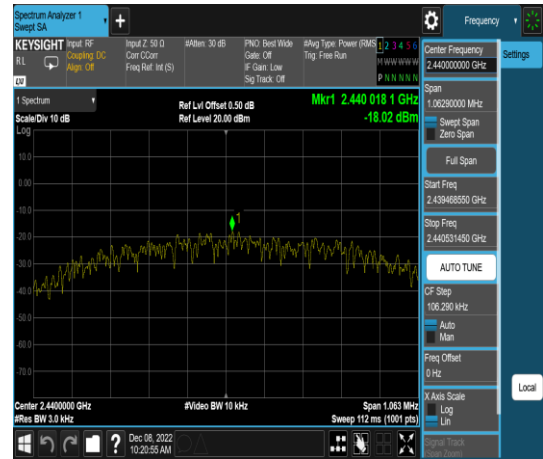

High CH

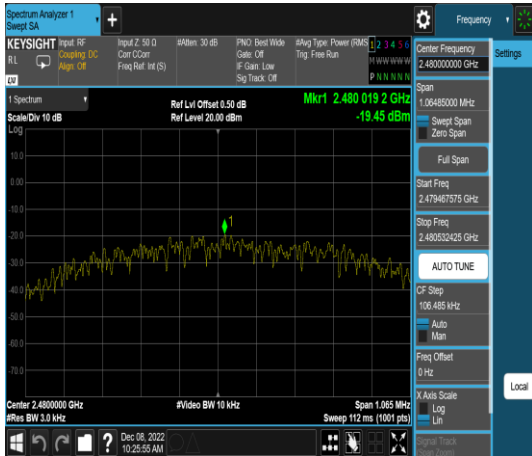

Report No.: TMWK2212005033KR

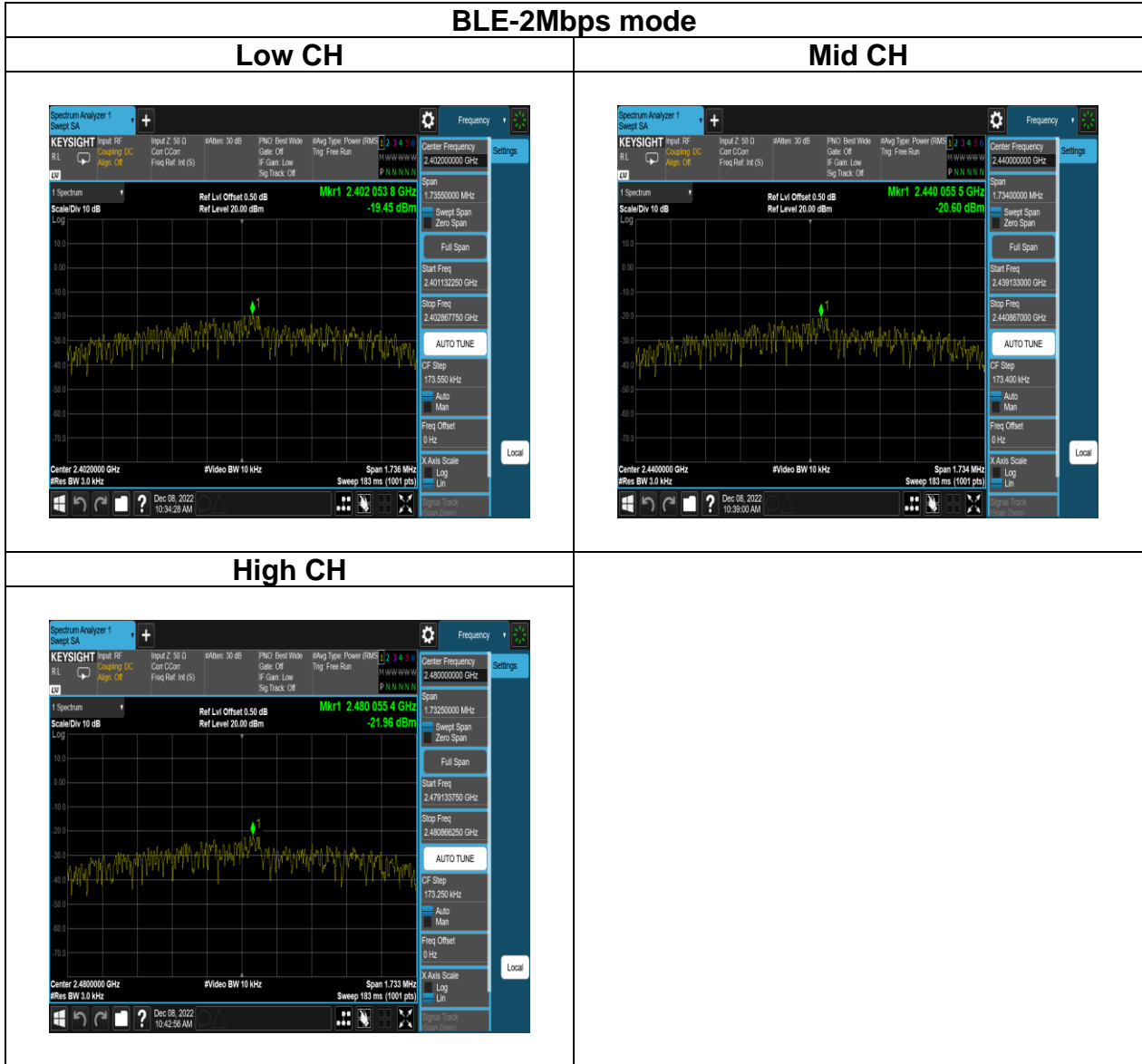

4.5 CONDUCTED BAND EDGE AND SPURIOUS EMISSION

4.5.1 Test Limit

According to §15.247(d)

FCC: In any 100 kHz bandwidth outside the authorized frequency band,

Non-restricted bands shall be attenuated at least 20 dB/30 dB relative to the maximum PSD level in 100 kHz by RF conducted or a radiated measurement which fall in the restricted bands, as defined in §15.205(a), must also comply with the radiated emission limits specified in §15.209(a).

4.5.2 Test Procedure

Test method Refer as ANSI C63.10:2013.

1. EUT RF output port connected to the SA by RF cable, and the path loss was compensated to result.
2. SA setting, RBW=100kHz, VBW=300kHz, Detector=Peak, Trace mode = max hold, SWT = Auto.
3. In any 100 kHz bandwidth outside the authorized frequency band, shall be attenuated at least 20 dB relative to the maximum in-band peak PSD level in 100 kHz when conducted power procedure is used. If the transmitter complies with the conducted power limits based on the use of RMS averaging over a time interval, the attenuation required under this paragraph shall be 30 dB instead of 20 dB.

4.5.3 Test Setup

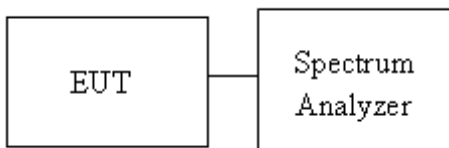

Report No.: TMWK2212005033KR

4.5.4 Test Result

Test Data

Temperature: 23.2°C

Test date: December 8, 2022

Humidity: 60% RH

Tested by: Jack Chen

BLE-1Mbps mode Low CH

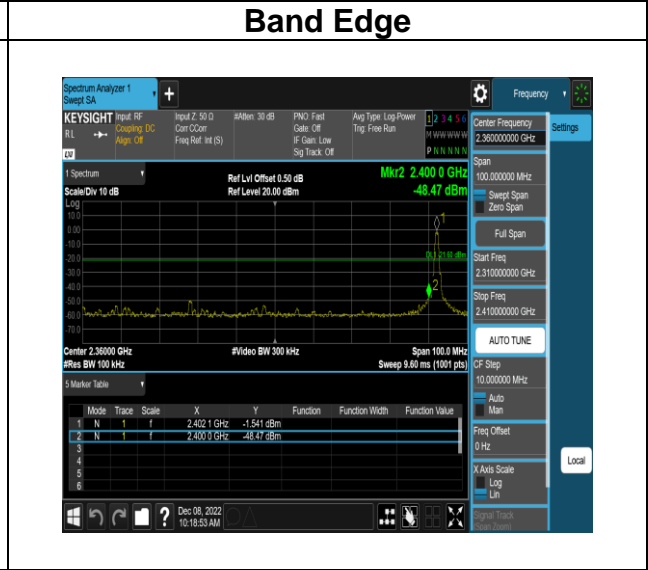
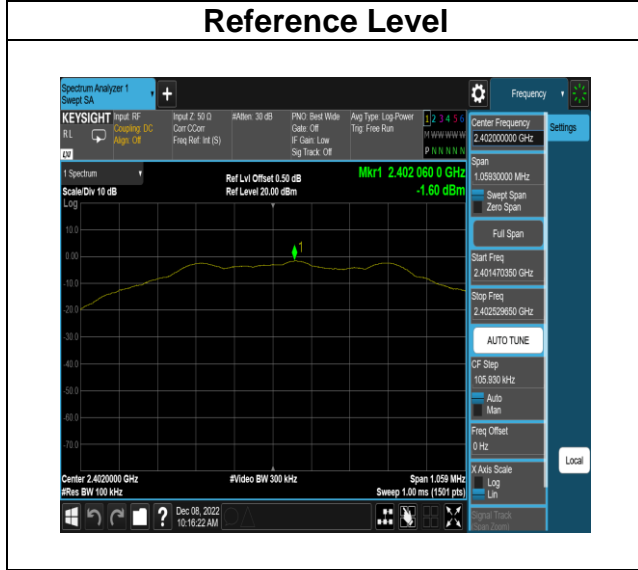

Spurious Emission 30MHz-25GHz

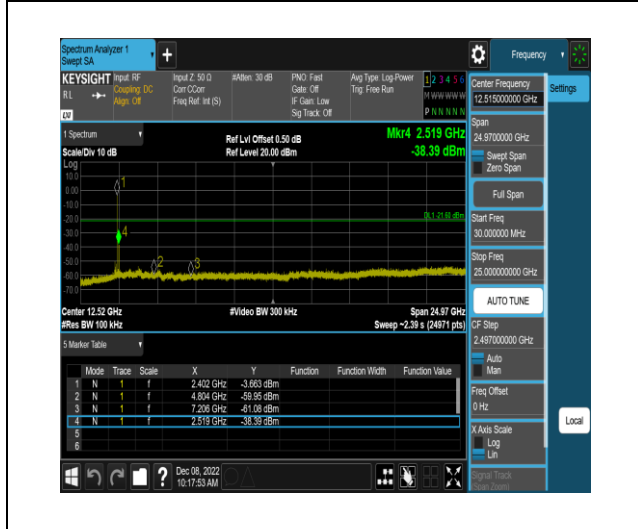

Report No.: TMWK2212005033KR

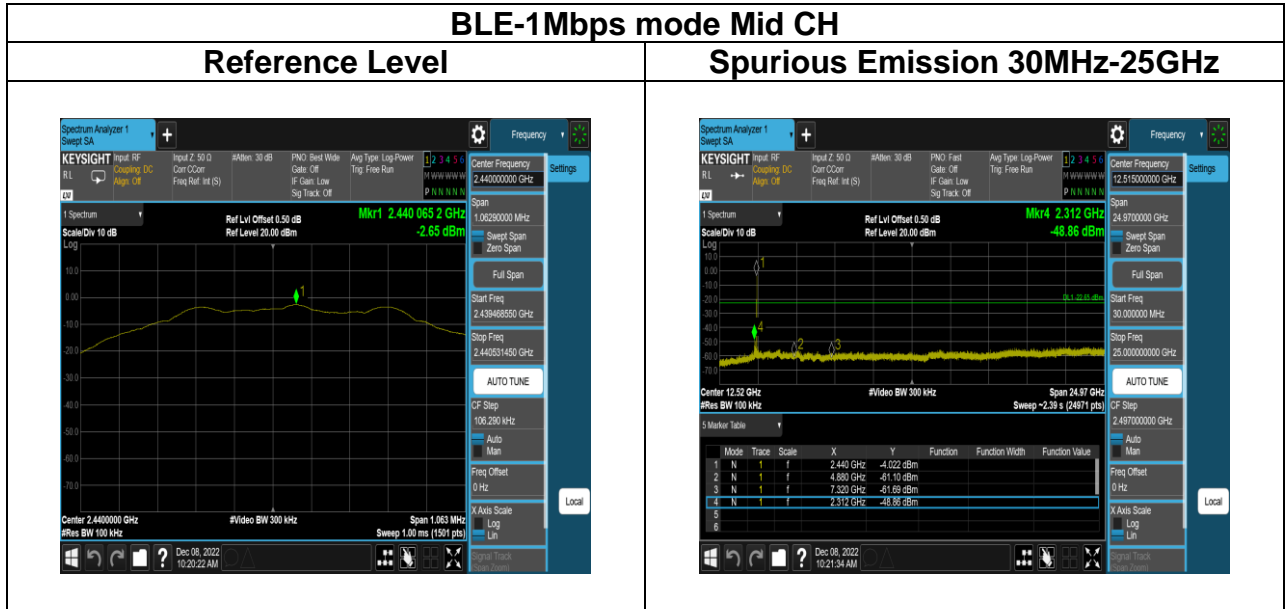

Report No.: TMWK2212005033KR

BLE-1Mbps mode High CH

Reference Level

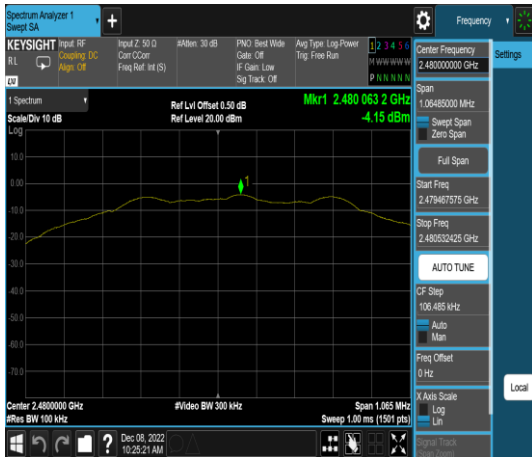

Band Edge



Spurious Emission 30MHz-25GHz

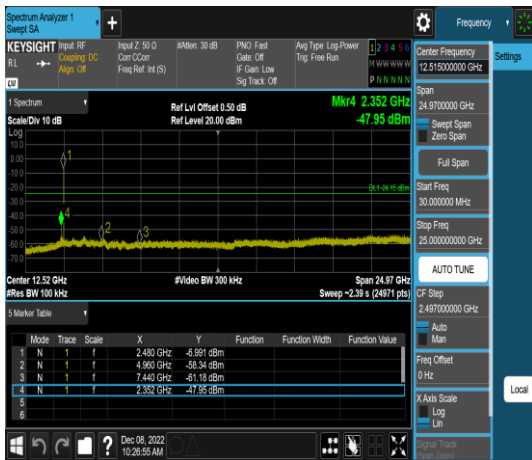

Report No.: TMWK2212005033KR

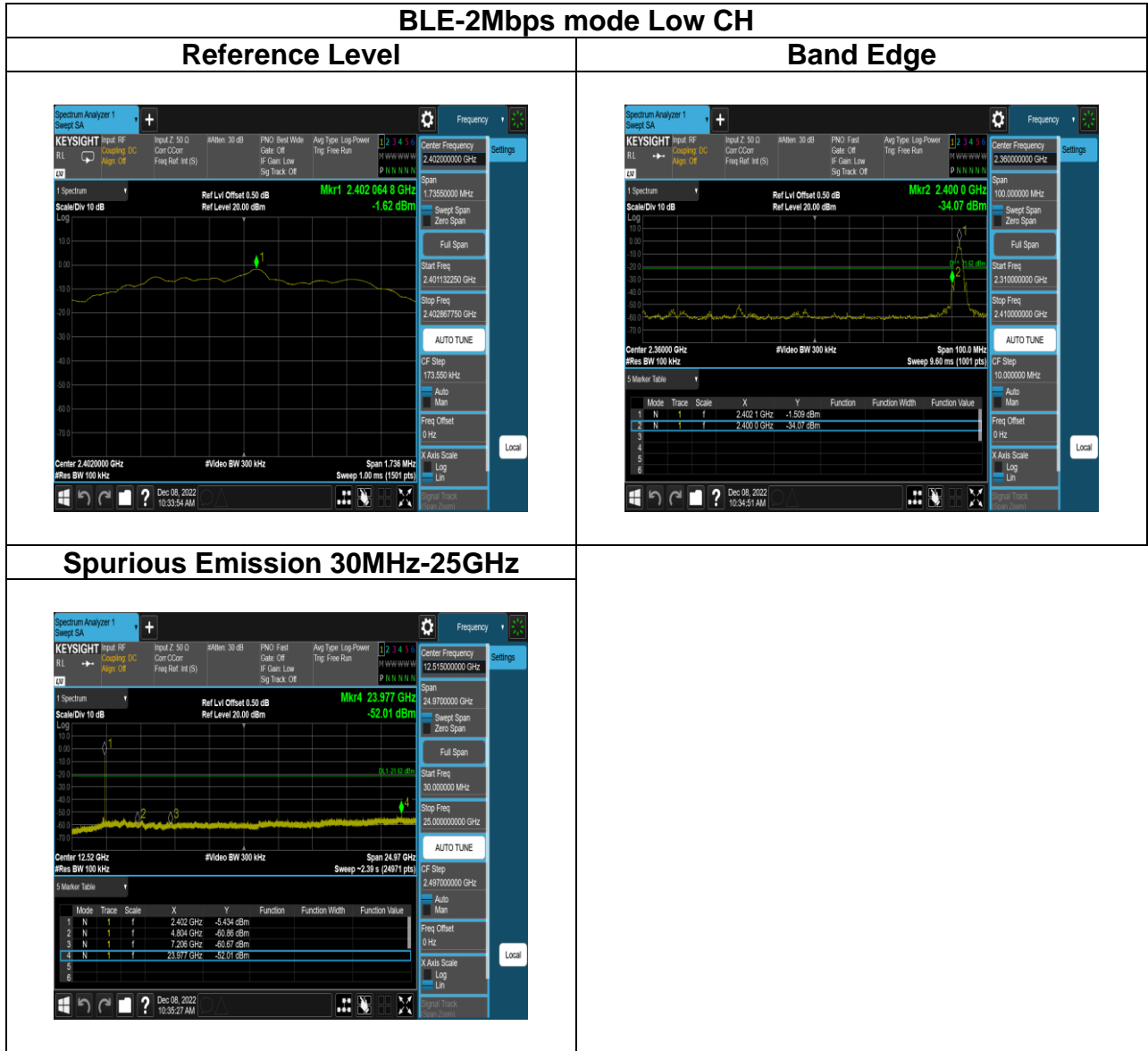

Report No.: TMWK2212005033KR

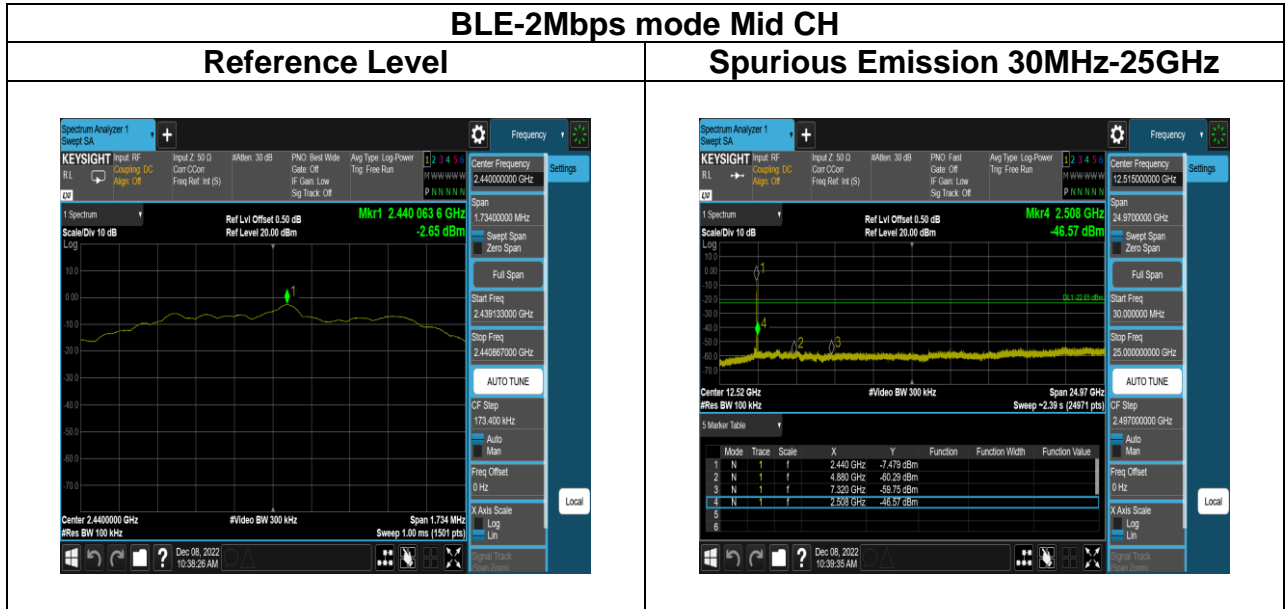

Report No.: TMWK2212005033KR

BLE-2Mbps mode High CH

Reference Level

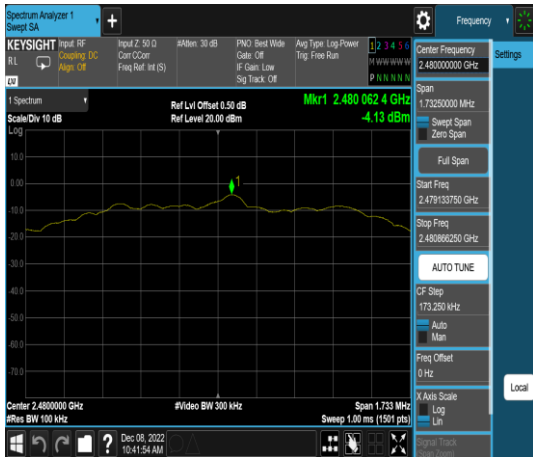

Band Edge



Spurious Emission 30MHz-25GHz

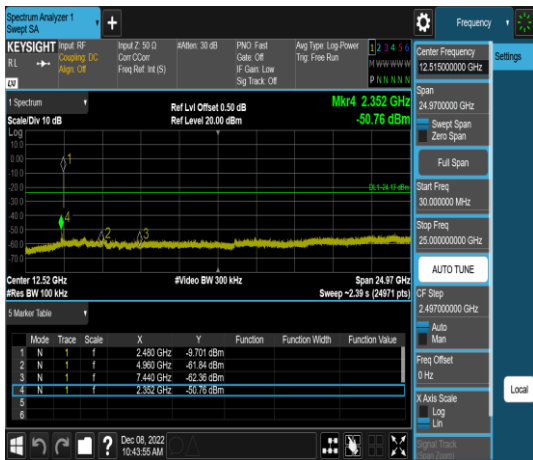

Report No.: TMWK2212005033KR

4.6 RADIATION BANDEDGE AND SPURIOUS EMISSION

4.6.1 Test Limit

FCC according to §15.247(d), §15.209 and §15.205,

In any 100 kHz bandwidth outside the authorized frequency band, all harmonic and spurious must be least 20 dB below the highest emission level with the authorized frequency band. Radiation emission which fall in the restricted bands must also follow the FCC section 15.209 as below limit in table.

Below 30 MHz

Frequency	Field Strength (microvolts/m)	Magnetic H-Field (microamperes/m)	Measurement Distance (metres)
9-490 kHz	2,400/F (F in kHz)	2,400/F (F in kHz)	300
490-1,705 kHz	24,000/F (F in kHz)	24,000/F (F in kHz)	30
1.705-30 MHz	30	N/A	30

Above 30 MHz

Frequency (MHz)	Field Strength microvolts/m at 3 metres (watts, e.i.r.p.)	
	Transmitters	Receivers
30-88	100 (3 nW)	100 (3 nW)
88-216	150 (6.8 nW)	150 (6.8 nW)
216-960	200 (12 nW)	200 (12 nW)
Above 960	500 (75 nW)	500 (75 nW)

Remark:

Although these tests were performed other than open area test site, adequate comparison measurements were confirmed against 30 m open area test site. Therefore sufficient tests were made to demonstrate that the alternative site produces results that correlate with the ones of tests made in an open field based on KDB 414788.

4.6.2 Test Procedure

Test method Refer as ANSI C63.10:2013.

1. The EUT is placed on a turntable, Above 1 GHz is 1.5m and below 1 GHz is 0.8m above ground plane. The EUT Configured un accordance with ANSI C63.10: 2013, and the EUT set in a continuous mode.
2. The turntable shall be rotated for 360 degrees to determine the position of maximum emission level. And EUT is set 3m away from the receiving antenna, which is scanned from 1m to 4m above the ground plane to find out the highest emissions. Measurement are made polarized in both the vertical and the horizontal positions with antenna.
3. Span shall wide enough to full capture the emission measured. The SA from 9KHz to 26.5GHz set to the low, Mid and High channels with the EUT transmit.

Remark:

1. Although these tests were performed other than open area test site, adequate comparison measurements were confirmed against 30 m open are test site. Therefore sufficient tests were made to demonstrate that the alternative site produces results that correlate with the ones of tests made in an open field based on KDB 414788.
2. No emission found between lowest internal used/generated frequency to 30MHz (9kHz~30MHz).
3. The SA setting following :
 - (1) Below 1G : RBW = 100kHz, VBW \geq 3 RBW, Sweep = Auto, Detector = Peak, Trace = Max hold.
 - (2) Above 1G :
 - (2.1) For Peak measurement : RBW = 1MHz, VBW \geq 3 RBW, Sweep = Auto, Detector = Peak, Trace = Max hold.
 - (2.2) For Average measurement : RBW = 1MHz, VBW
 - If Duty Cycle \geq 98%, VBW=10Hz.
 - If Duty Cycle < 98%, VBW=1/T.

4. Data result

Actual FS=Spectrum Reading Level+Factor

Margin=Actual FS- Limit

Report No.: TMWK2212005033KR

4.6.3 Test Setup

9kHz ~ 30MHz

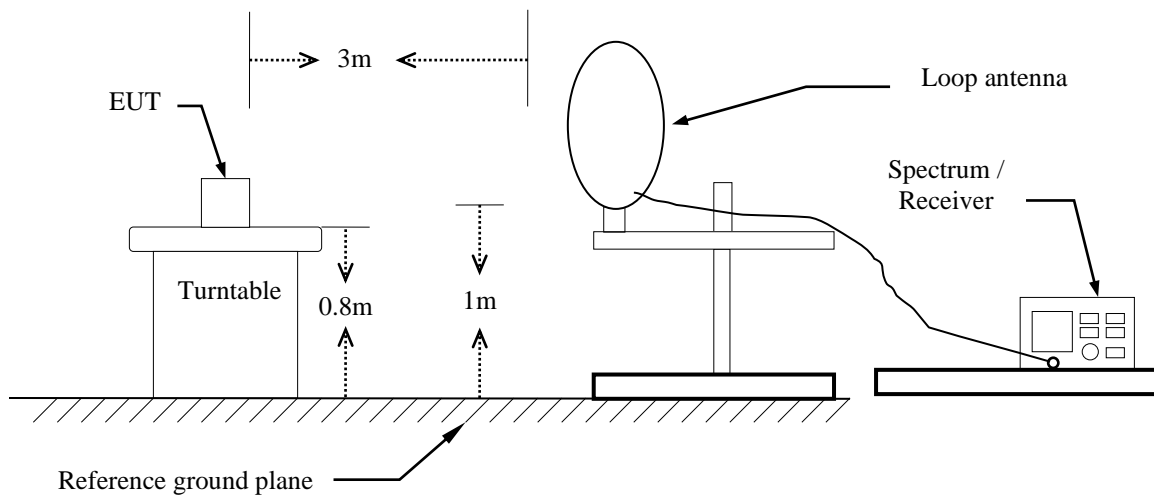

30MHz ~ 1GHz

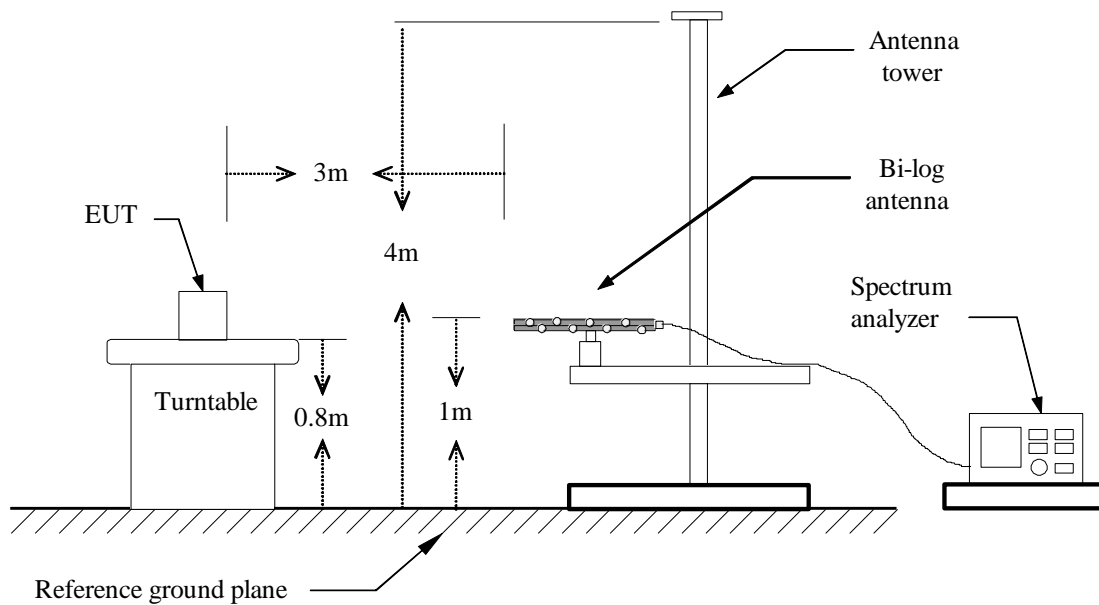

Above 1 GHz

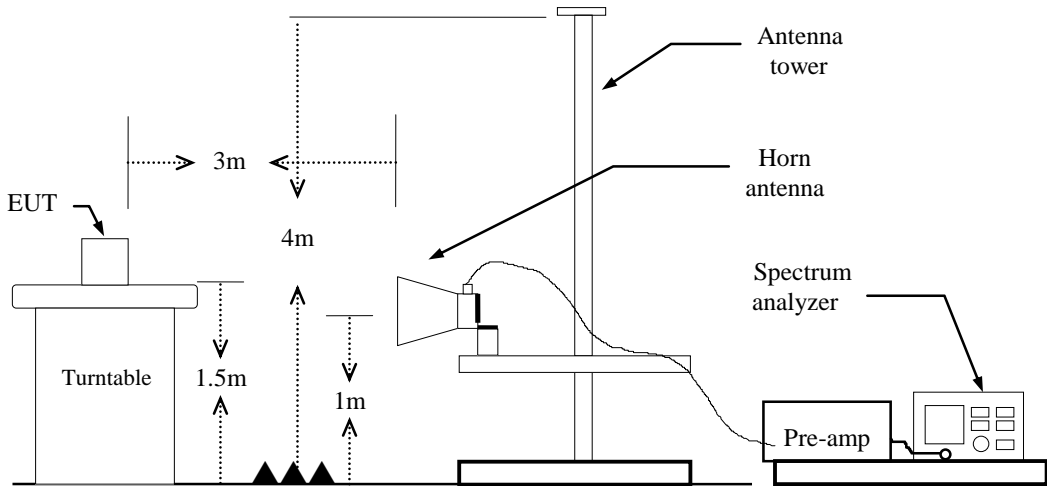

Report No.: TMWK2212005033KR

4.6.4 Test Result

Band Edge Test Data

Test Mode:	BLE-1Mbps Low CH	Temp/Hum	24.5(°C) / 61%RH
Test Item	Band Edge	Test Date	December 8, 2022
Polarize	Vertical	Test Engineer	Ray Li
Detector	Peak / Average		

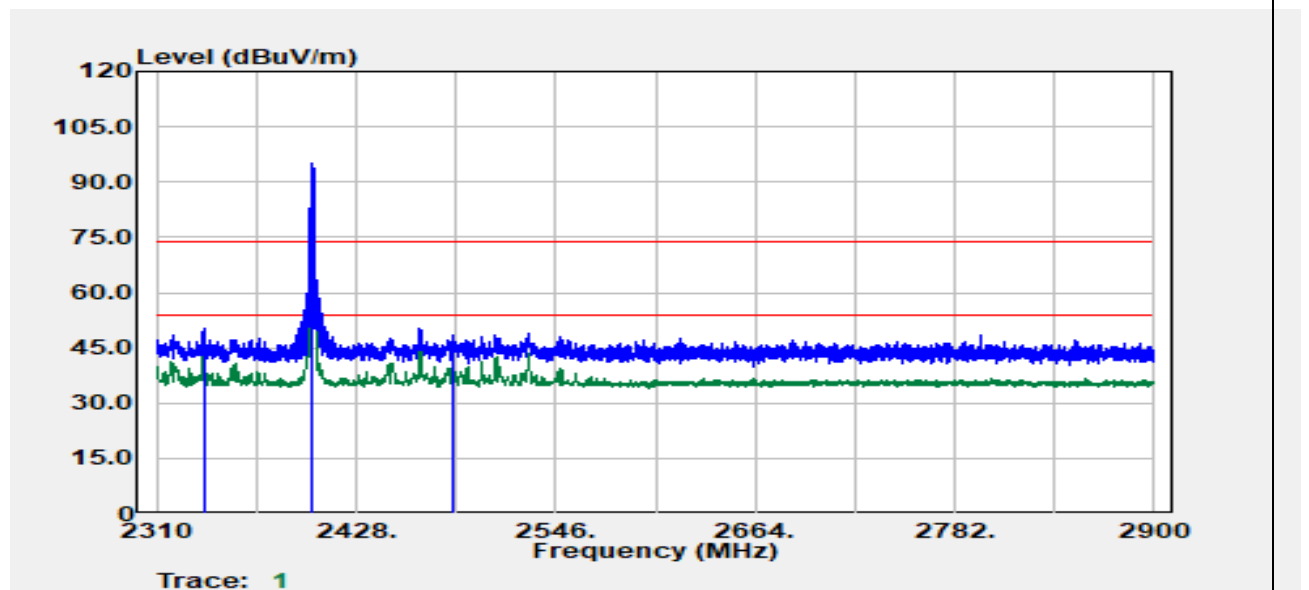

Freq. (MHz)	Detector Mode (PK/QP/AV)	Spectrum Reading Level (dBμV)	Factor (dB)	Actual FS (dBμV/m)	Limit @3m (dBμV/m)	Margin (dB)
2338.084	Average	37.13	7.62	44.75	54.00	-9.25
2338.202	Peak	42.82	7.62	50.44	74.00	-23.56
2402.000	Peak	87.46	7.79	95.25	--	--
2402.000	Average	86.76	7.79	94.56	--	--
2485.230	Peak	39.98	8.27	48.25	74.00	-25.75
2485.230	Average	33.17	8.27	41.44	54.00	-12.56

Report No.: TMWK2212005033KR

Test Mode:	BLE-1Mbps Low CH	Temp/Hum	24.5(°C) / 61%RH
Test Item	Band Edge	Test Date	December 8, 2022
Polarize	Horizontal	Test Engineer	Ray Li
Detector	Peak / Average		

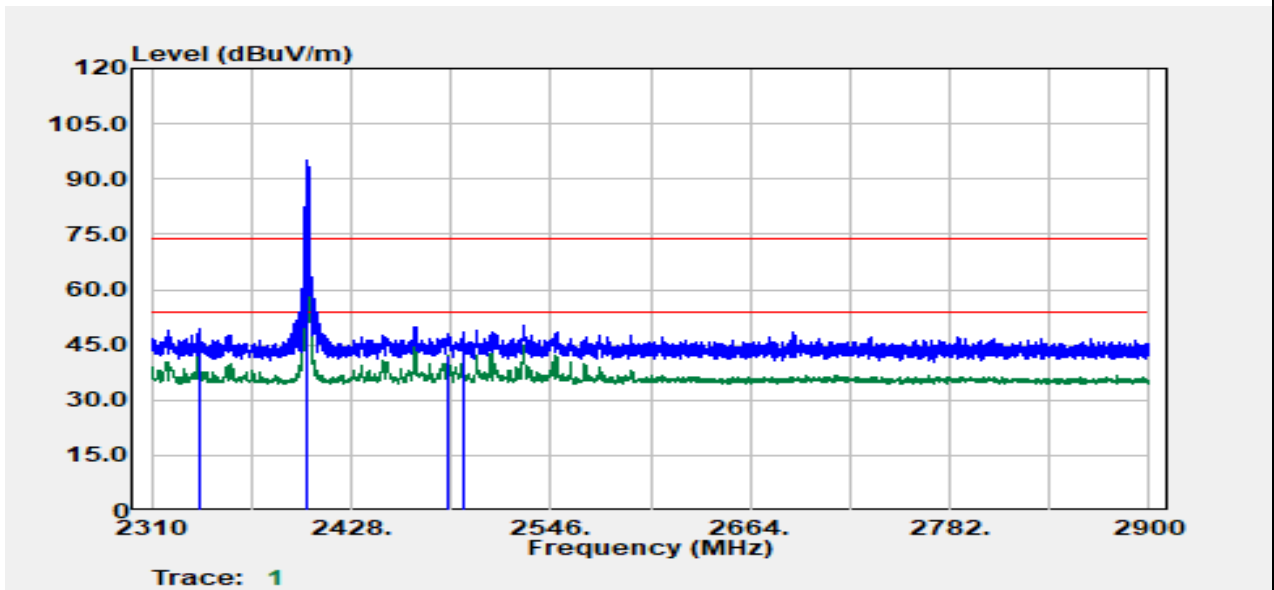

Freq. (MHz)	Detector Mode (PK/QP/AV)	Spectrum Reading Level (dBμV)	Factor (dB)	Actual FS (dBUV/m)	Limit @3m (dBUV/m)	Margin (dB)
2337.966	Average	36.26	7.62	43.88	54.00	-10.12
2338.084	Peak	41.69	7.62	49.31	74.00	-24.69
2402.000	Peak	87.24	7.79	95.03	--	--
2402.000	Average	86.63	7.79	94.42	--	--
2485.230	Average	33.92	8.27	42.19	54.00	-11.81
2494.198	Peak	40.05	8.31	48.36	74.00	-25.64

Report No.: TMWK2212005033KR

Test Mode:	BLE-1Mbps High CH	Temp/Hum	24.5(°C) / 61%RH
Test Item	Band Edge	Test Date	December 8, 2022
Polarize	Vertical	Test Engineer	Ray Li
Detector	Peak / Average		

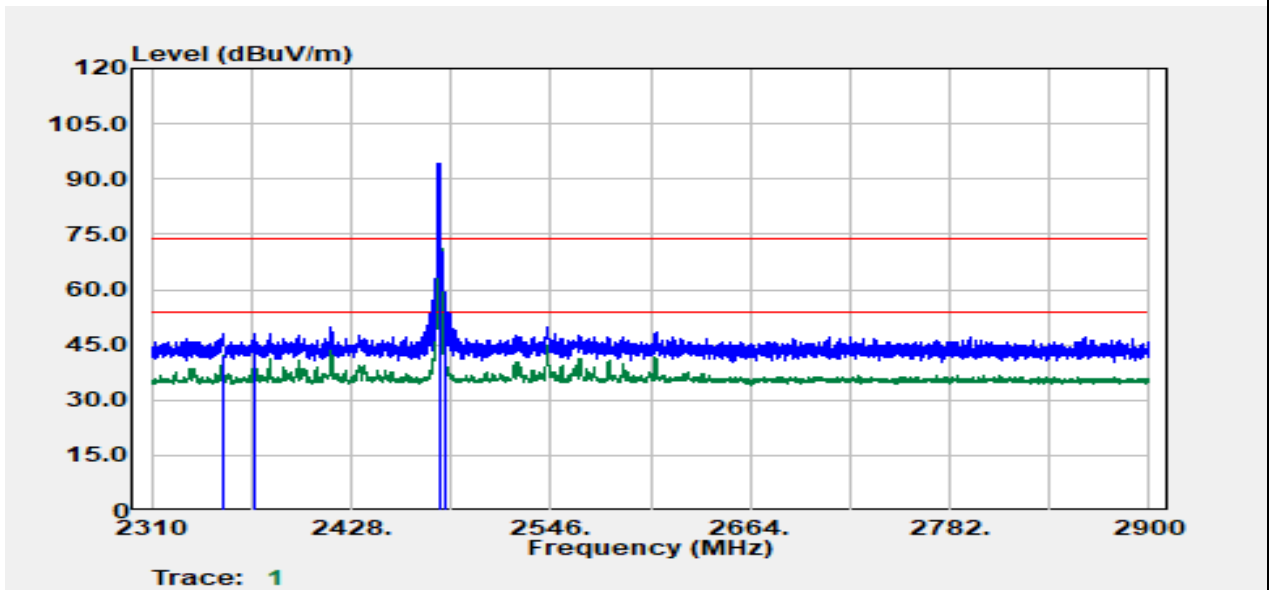

Freq. (MHz)	Detector Mode (PK/QP/AV)	Spectrum Reading Level (dBμV)	Factor (dB)	Actual FS (dBUV/m)	Limit @3m (dBUV/m)	Margin (dB)
2352.008	Average	34.55	7.65	42.19	54.00	-11.81
2370.888	Peak	40.30	7.70	48.00	74.00	-26.00
2480.000	Peak	86.06	8.24	94.30	--	--
2480.000	Average	85.50	8.24	93.75	--	--
2483.500	Peak	49.67	8.26	57.93	74.00	-16.07
2483.578	Average	32.58	8.26	40.84	54.00	-13.16

Report No.: TMWK2212005033KR

Test Mode:	BLE-1Mbps High CH	Temp/Hum	24.5(°C) / 61%RH
Test Item	Band Edge	Test Date	December 8, 2022
Polarize	Horizontal	Test Engineer	Ray Li
Detector	Peak / Average		

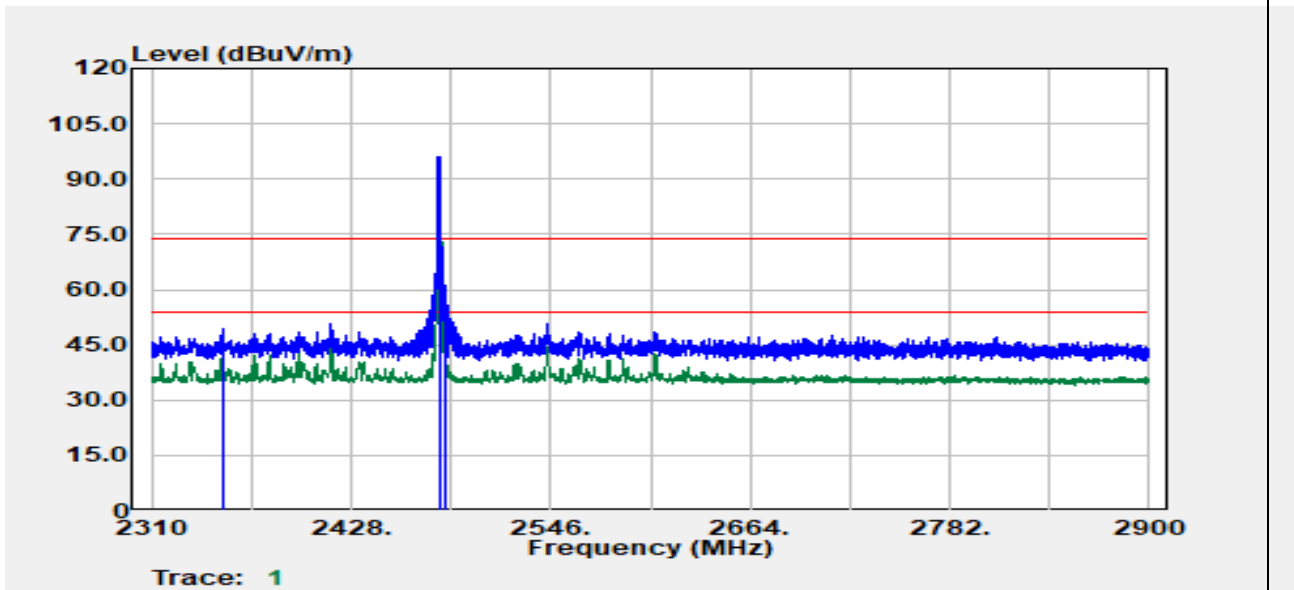

Freq. (MHz)	Detector Mode (PK/QP/AV)	Spectrum Reading Level (dBμV)	Factor (dB)	Actual FS (dBμV/m)	Limit @3m (dBμV/m)	Margin (dB)
2351.890	Peak	41.89	7.65	49.54	74.00	-24.46
2352.008	Average	36.89	7.65	44.54	54.00	-9.46
2480.000	Peak	87.53	8.24	95.77	--	--
2480.000	Average	86.90	8.24	95.14	--	--
2483.500	Peak	50.94	8.26	59.20	74.00	-14.80
2483.500	Average	33.68	8.26	41.94	54.00	-12.06

Report No.: TMWK2212005033KR

Test Mode:	BLE-2Mbps Low CH	Temp/Hum	24.5(°C) / 61%RH
Test Item	Band Edge	Test Date	December 8, 2022
Polarize	Vertical	Test Engineer	Ray Li
Detector	Peak / Average		

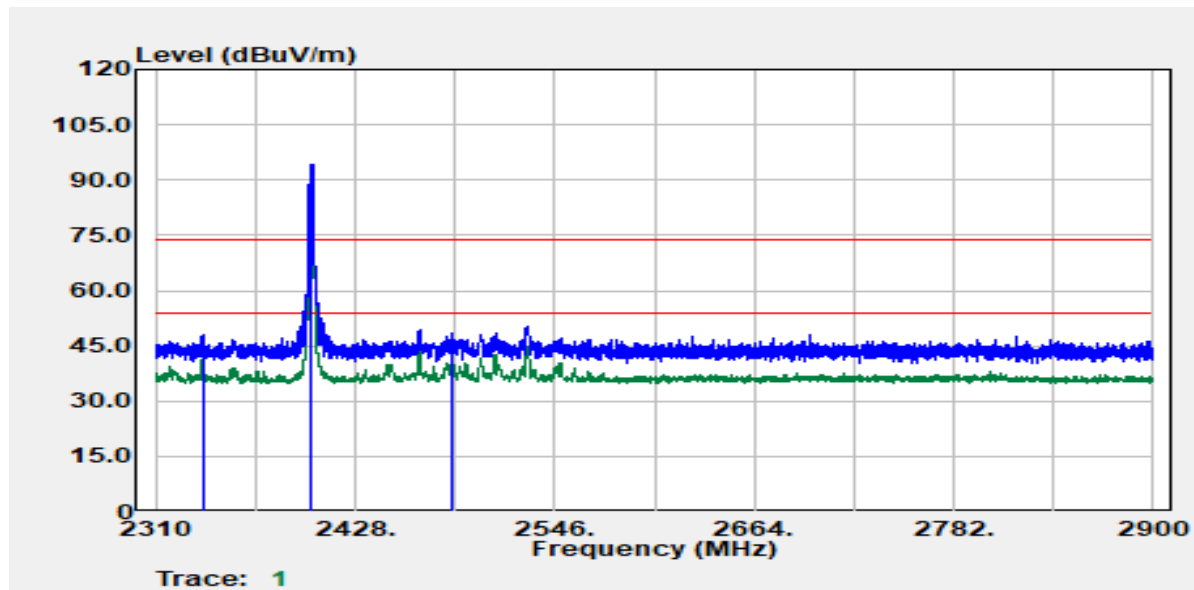

Freq. (MHz)	Detector Mode (PK/QP/AV)	Spectrum Reading Level (dBµV)	Factor (dB)	Actual FS (dBµV/m)	Limit @3m (dBµV/m)	Margin (dB)
2337.730	Peak	40.26	7.62	47.88	74.00	-26.12
2337.848	Average	34.22	7.62	41.84	54.00	-12.16
2402.000	Peak	86.40	7.79	94.20	--	--
2402.000	Average	84.44	7.79	92.24	--	--
2485.112	Average	33.31	8.27	41.58	54.00	-12.42
2485.584	Peak	40.31	8.27	48.58	74.00	-25.42

Report No.: TMWK2212005033KR

Test Mode:	BLE-2Mbps Low CH	Temp/Hum	24.5(°C) / 61%RH
Test Item	Band Edge	Test Date	December 8, 2022
Polarize	Horizontal	Test Engineer	Ray Li
Detector	Peak / Average		

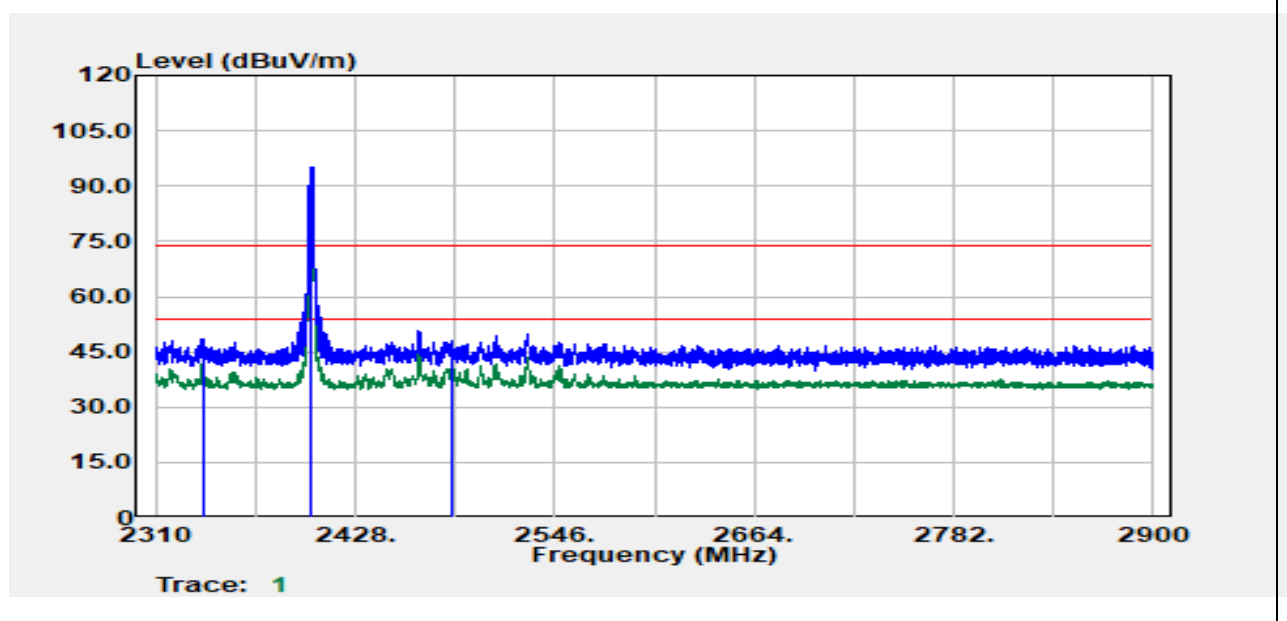

Freq. (MHz)	Detector Mode (PK/QP/AV)	Spectrum Reading Level (dBμV)	Factor (dB)	Actual FS (dBμV/m)	Limit @3m (dBμV/m)	Margin (dB)
2338.084	Average	35.40	7.62	43.03	54.00	-10.97
2338.556	Peak	41.02	7.62	48.64	74.00	-25.36
2402.000	Peak	87.44	7.79	95.24	--	--
2402.000	Average	85.60	7.79	93.39	--	--
2485.112	Average	33.53	8.27	41.80	54.00	-12.20
2485.230	Peak	39.74	8.27	48.01	74.00	-25.99

Report No.: TMWK2212005033KR

Test Mode:	BLE-2Mbps High CH	Temp/Hum	24.5(°C) / 61%RH
Test Item	Band Edge	Test Date	December 8, 2022
Polarize	Vertical	Test Engineer	Ray Li
Detector	Peak / Average		

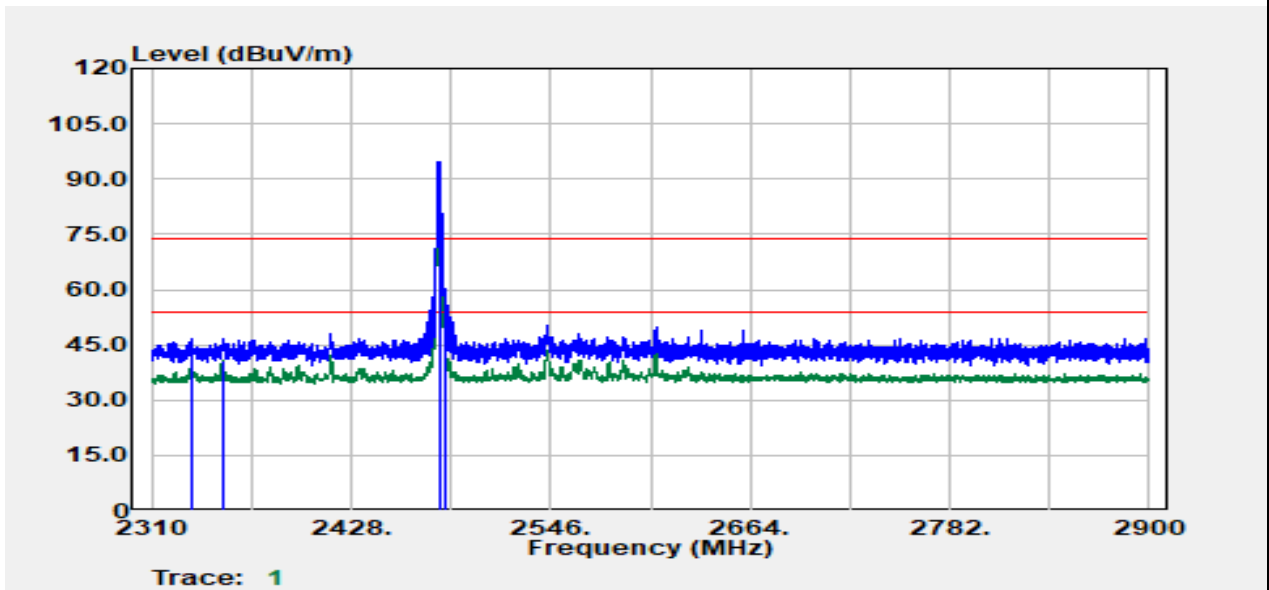

Freq. (MHz)	Detector Mode (PK/QP/AV)	Spectrum Reading Level (dBμV)	Factor (dB)	Actual FS (dBμV/m)	Limit @3m (dBμV/m)	Margin (dB)
2333.718	Peak	39.24	7.61	46.85	74.00	-27.15
2352.008	Average	33.19	7.65	40.84	54.00	-13.16
2480.000	Peak	86.47	8.24	94.71	--	--
2480.000	Average	84.50	8.24	92.74	--	--
2483.578	Average	34.94	8.26	43.20	54.00	-10.80
2483.932	Peak	48.82	8.26	57.08	74.00	-16.92

Report No.: TMWK2212005033KR

Test Mode:	BLE-2Mbps High CH	Temp/Hum	24.5(°C) / 61%RH
Test Item	Band Edge	Test Date	December 8, 2022
Polarize	Horizontal	Test Engineer	Ray Li
Detector	Peak / Average		

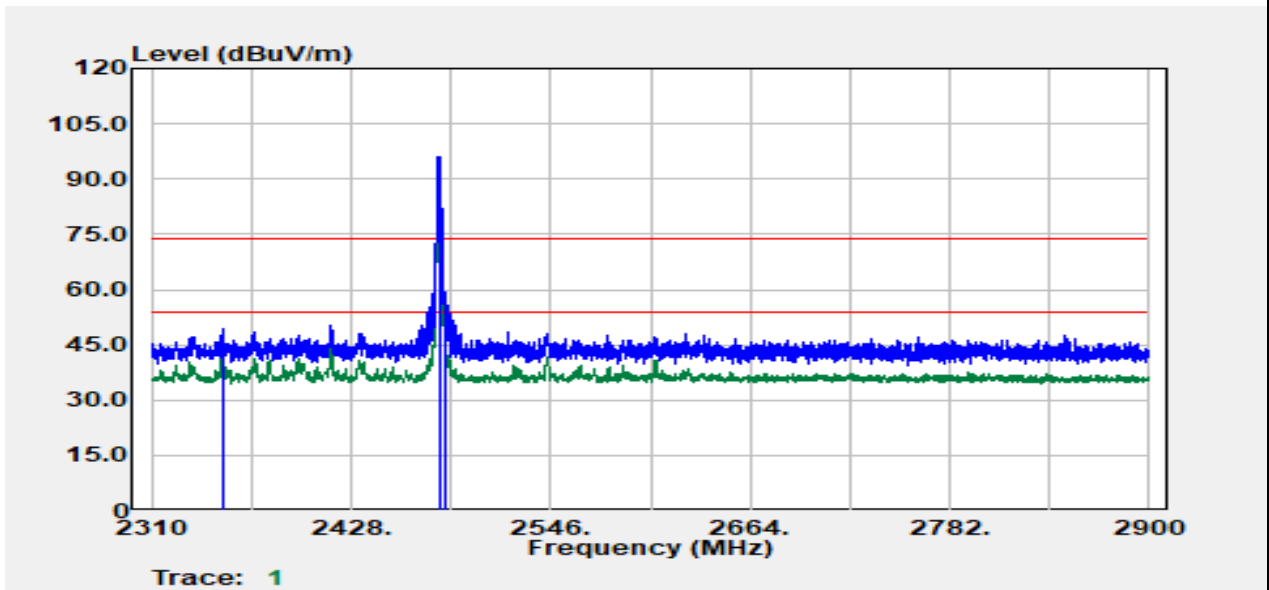

Freq. (MHz)	Detector Mode (PK/QP/AV)	Spectrum Reading Level (dBμV)	Factor (dB)	Actual FS (dBμV/m)	Limit @3m (dBμV/m)	Margin (dB)
2351.654	Peak	41.77	7.64	49.42	74.00	-24.58
2352.244	Average	35.51	7.65	43.16	54.00	-10.84
2480.000	Peak	87.63	8.24	95.87	--	--
2480.000	Average	85.69	8.24	93.93	--	--
2483.500	Average	37.36	8.26	45.62	54.00	-8.38
2483.696	Peak	50.34	8.26	58.60	74.00	-15.40

Report No.: TMWK2212005033KR

Below 1G Test Data

Test Mode:	BLE-1Mbps Mode	Temp/Hum	24.5(°C) / 61%RH
Test Item	30MHz-1GHz	Test Date	December 8, 2022
Polarize	Vertical	Test Engineer	Ray Li
Detector	Peak		

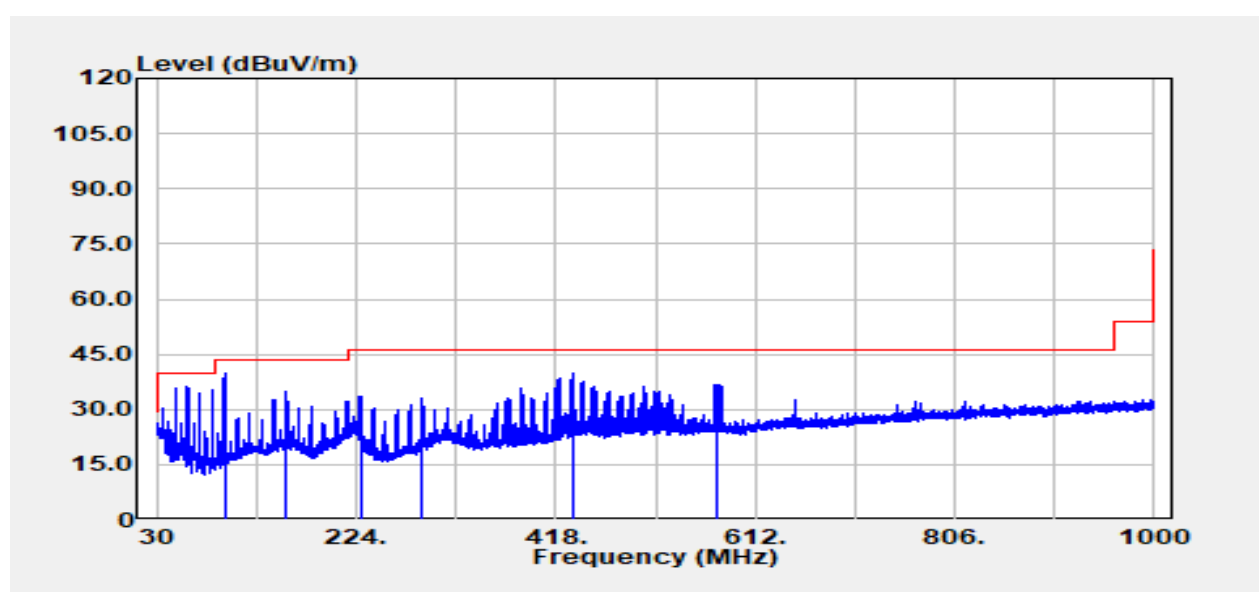

Freq. (MHz)	Detector Mode (PK/QP/AV)	Spectrum Reading Level (dBμV)	Factor (dB)	Actual FS (dBUV/m)	Limit @3m (dBUV/m)	Margin (dB)
96.445	Peak	53.98	-14.08	39.90	43.50	-3.60
155.251	Peak	45.40	-10.59	34.81	43.50	-8.69
227.880	Peak	45.17	-11.67	33.50	46.00	-12.50
287.899	Peak	41.98	-8.97	33.01	46.00	-12.99
434.005	Peak	45.04	-5.08	39.96	46.00	-6.04
573.564	Peak	39.26	-2.42	36.85	46.00	-9.15

Note: No emission found between lowest internal used/generated frequency to 30MHz (9kHz~30MHz).

Report No.: TMWK2212005033KR

Test Mode:	BLE-1Mbps Mode	Temp/Hum	24.5(°C) / 61%RH
Test Item	30MHz-1GHz	Test Date	December 8, 2022
Polarize	Horizontal	Test Engineer	Ray Li
Detector	Peak		

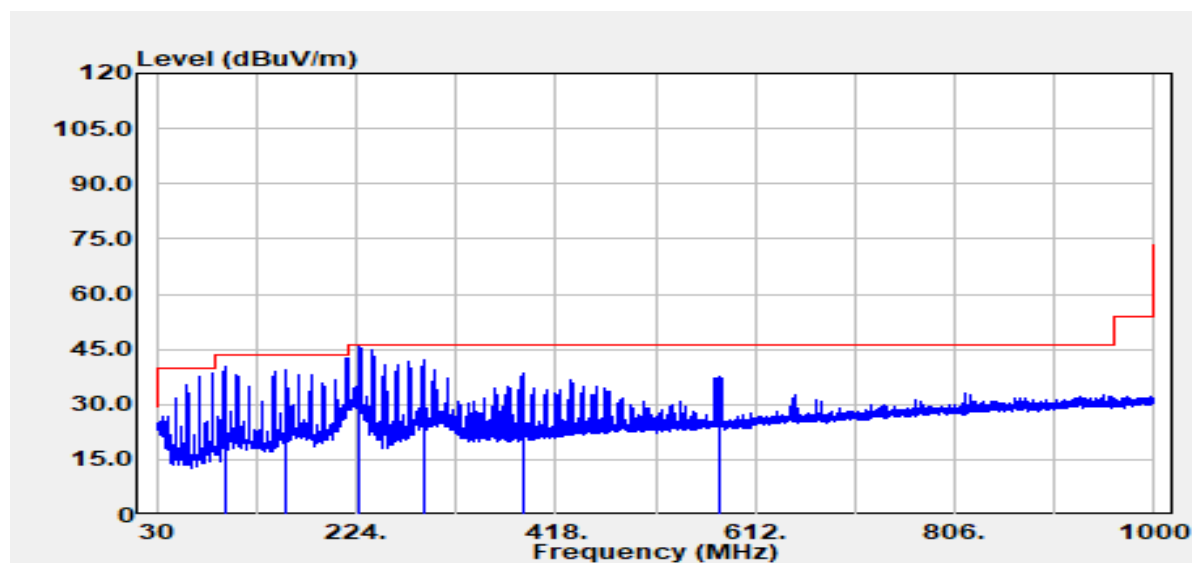

Freq. (MHz)	Detector Mode (PK/QP/AV)	Spectrum Reading Level (dB μ V)	Factor (dB)	Actual FS (dB μ V/m)	Limit @3m (dB μ V/m)	Margin (dB)
95.960	Peak	54.61	-14.19	40.43	43.50	-3.07
155.979	Peak	50.04	-10.73	39.30	43.50	-4.20
226.789	QP	51.41	-11.77	39.65	46.00	-6.35
289.354	Peak	50.93	-8.98	41.95	46.00	-4.05
385.748	Peak	45.20	-6.59	38.61	46.00	-7.39
576.231	Peak	40.05	-2.44	37.62	46.00	-8.38

Note: No emission found between lowest internal used/generated frequency to 30MHz (9kHz~30MHz).

Report No.: TMWK2212005033KR

Above 1G Test Data

Test Mode:	BLE-1Mbps Low CH	Temp/Hum	23.4(°C) / 64%RH
Test Item	Harmonic	Test Date	December 12, 2022
Polarize	Vertical	Test Engineer	Ray Li
Detector	Peak / Average		

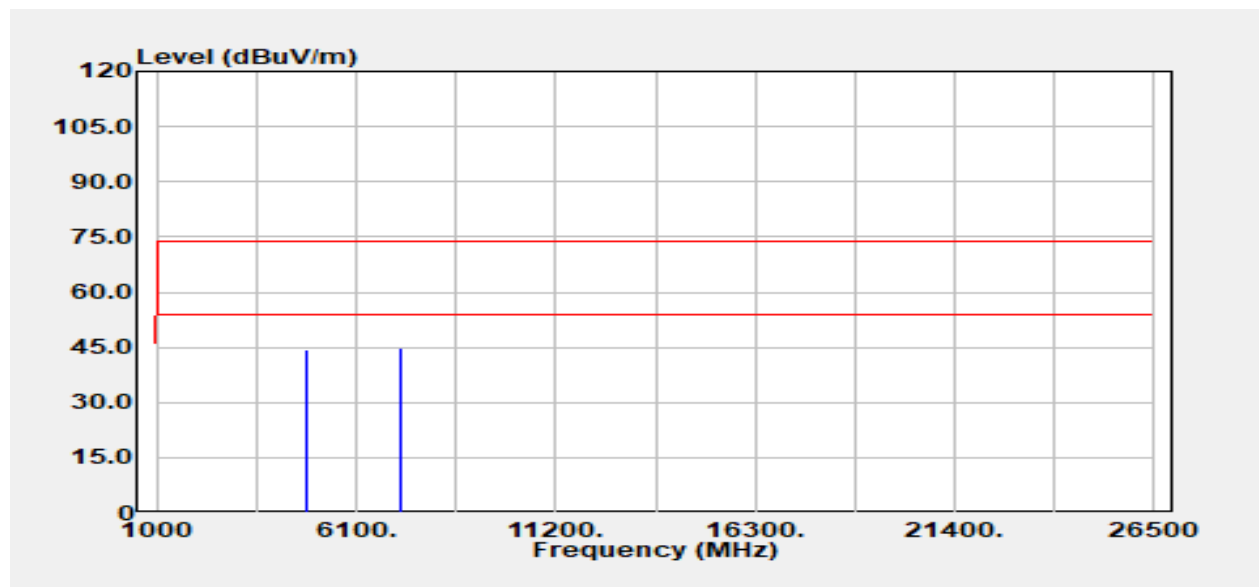

Freq. (MHz)	Detector Mode (PK/QP/AV)	Spectrum Reading Level (dBµV)	Factor (dB)	Actual FS (dBµV/m)	Limit @3m (dBµV/m)	Margin (dB)
4804.000	Peak	38.67	5.87	44.53	74.00	-29.47
4804.000	Average	32.74	5.87	38.61	54.00	-15.39
7206.000	Peak	31.66	13.25	44.91	74.00	-29.09
7206.000	Average	26.20	13.25	39.45	54.00	-14.55
N/A						

Remark:

1. Measuring frequencies from 1 GHz to the 10th harmonic of highest fundamental frequency.

Report No.: TMWK2212005033KR

Test Mode:	BLE-1Mbps Low CH	Temp/Hum	23.4(°C) / 64%RH
Test Item	Harmonic	Test Date	December 12, 2022
Polarize	Horizontal	Test Engineer	Ray Li
Detector	Peak / Average		

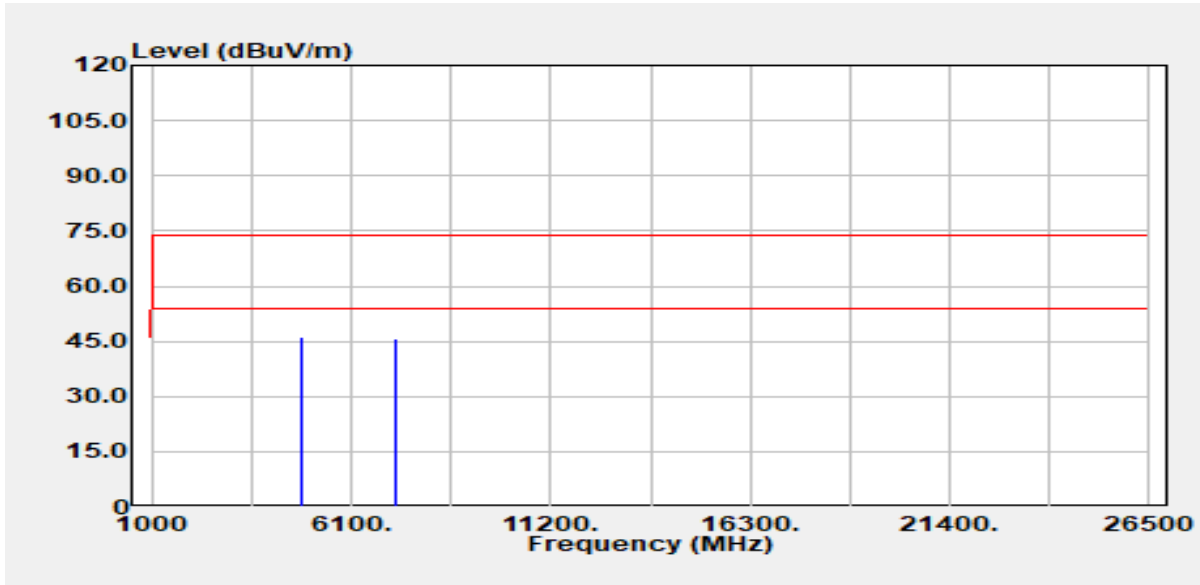

Freq. (MHz)	Detector Mode (PK/QP/AV)	Spectrum Reading Level (dBμV)	Factor (dB)	Actual FS (dBμV/m)	Limit @3m (dBμV/m)	Margin (dB)
4804.000	Peak	40.30	5.87	46.16	74.00	-27.84
4804.000	Average	36.69	5.87	42.55	54.00	-11.45
7206.000	Peak	32.53	13.25	45.78	74.00	-28.22
7206.000	Average	26.65	13.25	39.91	54.00	-14.09
N/A						

Remark:

1. Measuring frequencies from 1 GHz to the 10th harmonic of highest fundamental frequency.

Report No.: TMWK2212005033KR

Test Mode:	BLE-1Mbps Mid CH	Temp/Hum	23.4(°C) / 64%RH
Test Item	Harmonic	Test Date	December 12, 2022
Polarize	Vertical	Test Engineer	Ray Li
Detector	Peak / Average		

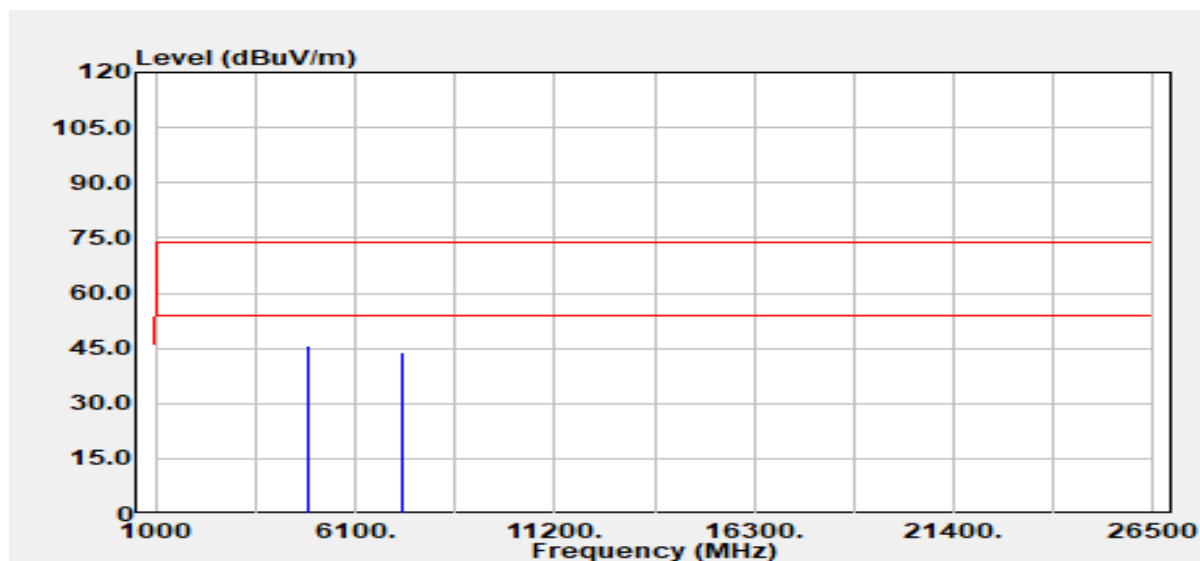

Freq. (MHz)	Detector Mode (PK/QP/AV)	Spectrum Reading Level (dBµV)	Factor (dB)	Actual FS (dBµV/m)	Limit @3m (dBµV/m)	Margin (dB)
4880.000	Peak	39.57	6.13	45.70	74.00	-28.30
4880.000	Average	35.08	6.13	41.21	54.00	-12.79
7320.000	Peak	30.56	13.35	43.91	74.00	-30.09
7320.000	Average	24.78	13.35	38.13	54.00	-15.87
N/A						

Remark:

1. Measuring frequencies from 1 GHz to the 10th harmonic of highest fundamental frequency.

Report No.: TMWK2212005033KR

Test Mode:	BLE-1Mbps Mid CH	Temp/Hum	23.4(°C) / 64%RH
Test Item	Harmonic	Test Date	December 12, 2022
Polarize	Horizontal	Test Engineer	Ray Li
Detector	Peak / Average		

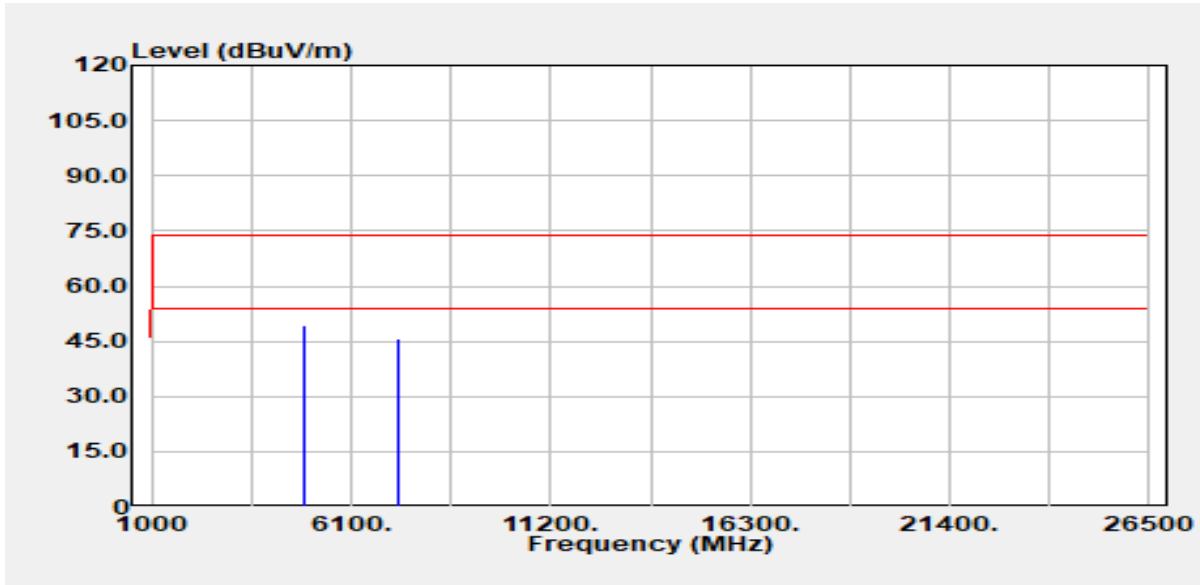

Freq. (MHz)	Detector Mode (PK/QP/AV)	Spectrum Reading Level (dBμV)	Factor (dB)	Actual FS (dBμV/m)	Limit @3m (dBμV/m)	Margin (dB)
4880.000	Peak	43.04	6.13	49.17	74.00	-24.83
4880.000	Average	38.59	6.13	44.72	54.00	-9.28
7320.000	Peak	32.24	13.35	45.59	74.00	-28.41
7320.000	Average	28.66	13.35	42.01	54.00	-11.99
N/A						

Remark:

1. Measuring frequencies from 1 GHz to the 10th harmonic of highest fundamental frequency.

Report No.: TMWK2212005033KR

Test Mode:	BLE-1Mbps High CH	Temp/Hum	23.4(°C) / 64%RH
Test Item	Harmonic	Test Date	December 12, 2022
Polarize	Vertical	Test Engineer	Ray Li
Detector	Peak / Average		

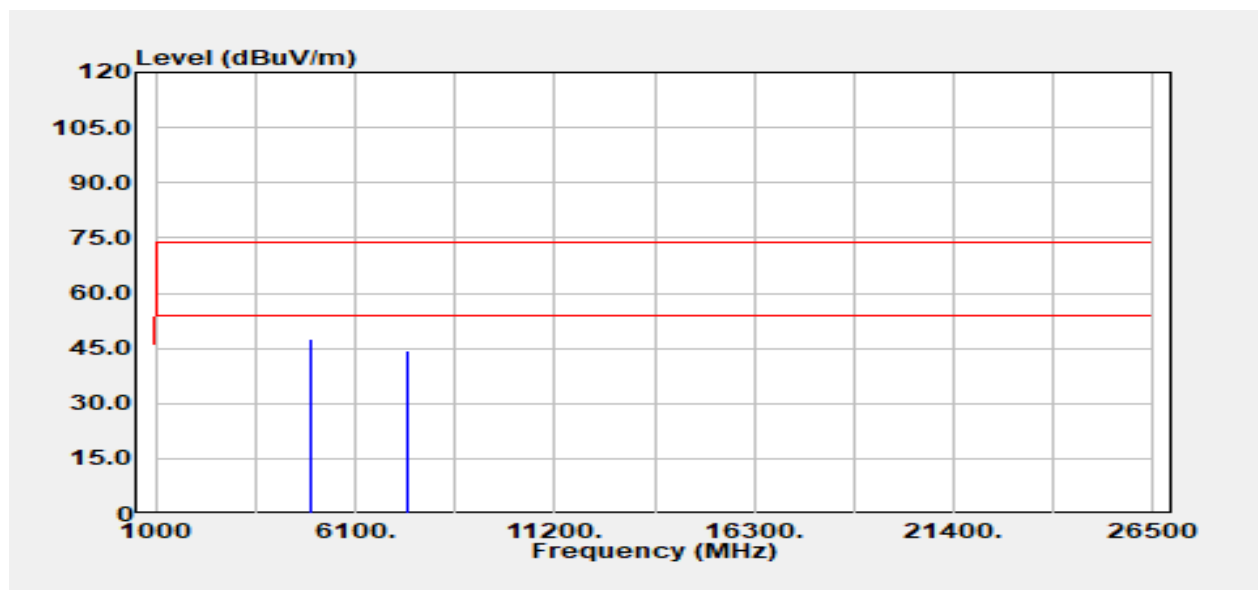

Freq. (MHz)	Detector Mode (PK/QP/AV)	Spectrum Reading Level (dB μ V)	Factor (dB)	Actual FS (dB μ V/m)	Limit @3m (dB μ V/m)	Margin (dB)
4960.000	Peak	40.80	6.91	47.72	74.00	-26.28
4960.000	Average	36.91	6.91	43.82	54.00	-10.18
7440.000	Peak	31.08	13.22	44.30	74.00	-29.70
7440.000	Average	25.90	13.22	39.12	54.00	-14.88
N/A						

Remark:

1. Measuring frequencies from 1 GHz to the 10th harmonic of highest fundamental frequency.

Report No.: TMWK2212005033KR

Test Mode:	BLE-1Mbps High CH	Temp/Hum	23.4(°C) / 64%RH
Test Item	Harmonic	Test Date	December 12, 2022
Polarize	Horizontal	Test Engineer	Ray Li
Detector	Peak / Average		

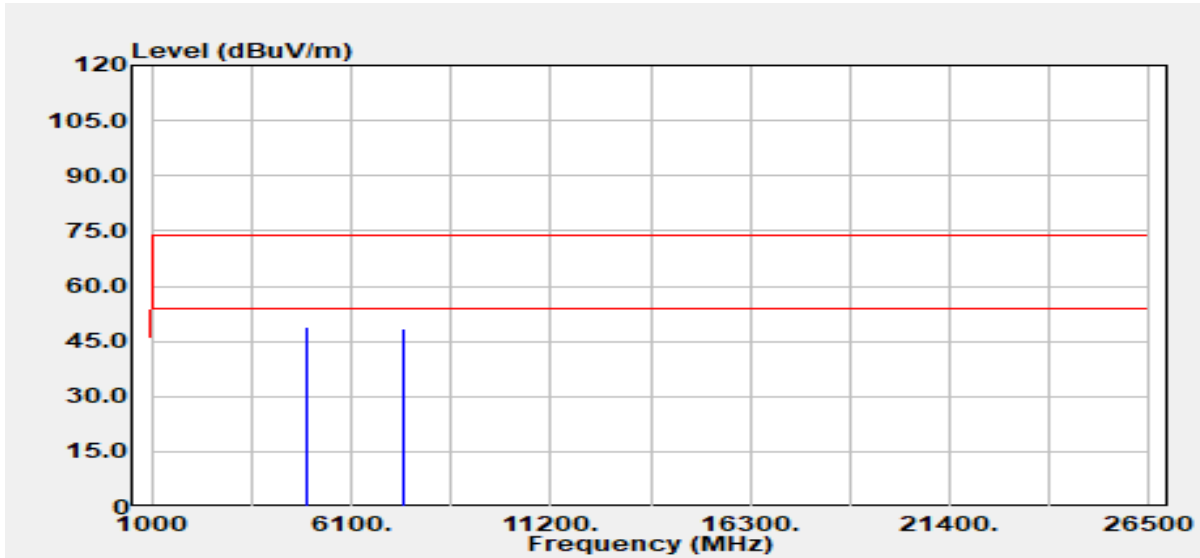

Freq. (MHz)	Detector Mode (PK/QP/AV)	Spectrum Reading Level (dBμV)	Factor (dB)	Actual FS (dBμV/m)	Limit @3m (dBμV/m)	Margin (dB)
4960.000	Peak	41.85	6.91	48.77	74.00	-25.23
4960.000	Average	38.34	6.91	45.26	54.00	-8.74
7440.000	Peak	35.38	13.22	48.60	74.00	-25.40
7440.000	Average	31.68	13.22	44.90	54.00	-9.10
N/A						

Remark:

1. Measuring frequencies from 1 GHz to the 10th harmonic of highest fundamental frequency.

Test Mode:	BLE-2Mbps Low CH	Temp/Hum	23.4(°C) / 64%RH
Test Item	Harmonic	Test Date	December 12, 2022
Polarize	Vertical	Test Engineer	Ray Li
Detector	Peak / Average		

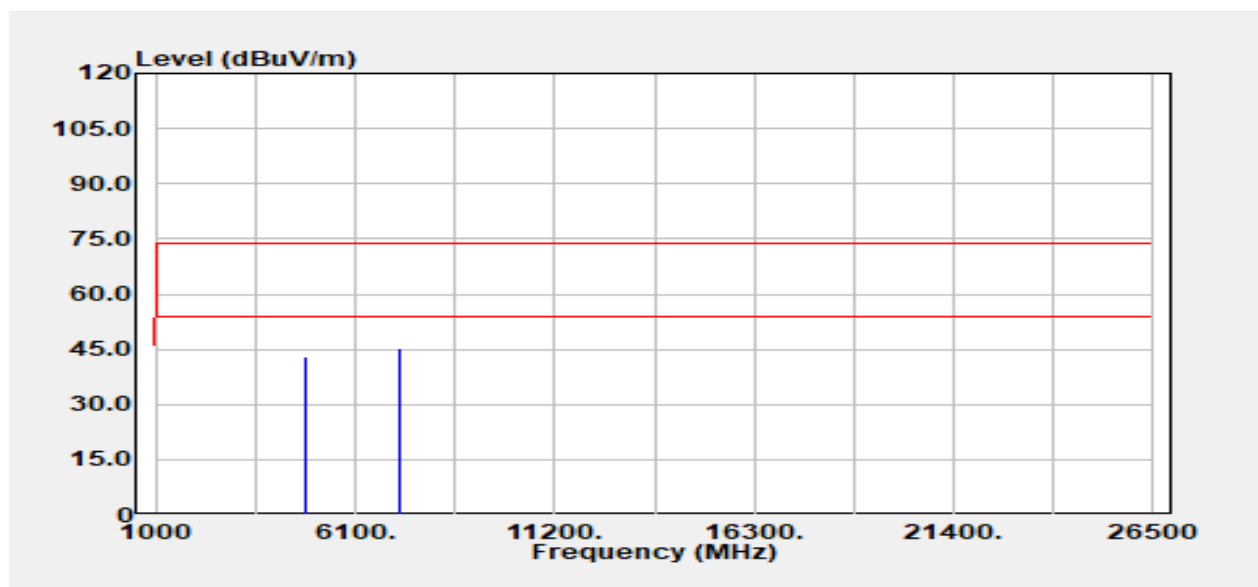

Freq. (MHz)	Detector Mode (PK/QP/AV)	Spectrum Reading Level (dBµV)	Factor (dB)	Actual FS (dBµV/m)	Limit @3m (dBµV/m)	Margin (dB)
4804.000	Peak	37.32	5.87	43.19	74.00	-30.81
4804.000	Average	32.59	5.87	38.46	54.00	-15.54
7206.000	Peak	32.14	13.25	45.39	74.00	-28.61
7206.000	Average	25.17	13.25	38.42	54.00	-15.58
N/A						

Remark:

1. Measuring frequencies from 1 GHz to the 10th harmonic of highest fundamental frequency.

Report No.: TMWK2212005033KR

Test Mode:	BLE-2Mbps Low CH	Temp/Hum	23.4(°C) / 64%RH
Test Item	Harmonic	Test Date	December 12, 2022
Polarize	Horizontal	Test Engineer	Ray Li
Detector	Peak / Average		

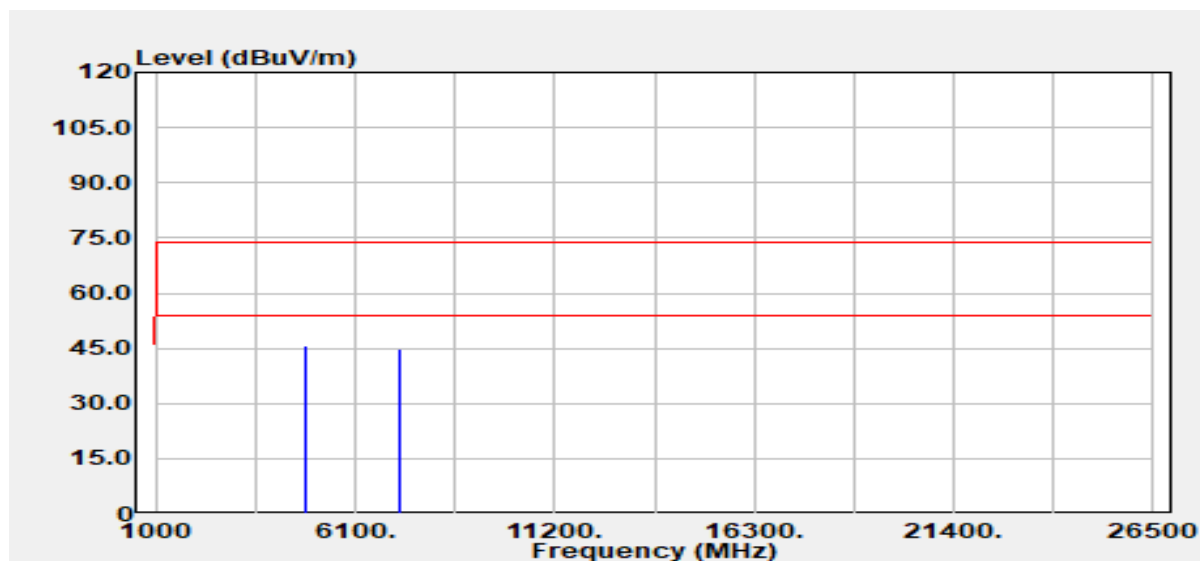

Freq. (MHz)	Detector Mode (PK/QP/AV)	Spectrum Reading Level (dB μ V)	Factor (dB)	Actual FS (dB μ V/m)	Limit @3m (dB μ V/m)	Margin (dB)
4804.000	Peak	39.74	5.87	45.61	74.00	-28.39
4804.000	Average	35.32	5.87	41.19	54.00	-12.81
7206.000	Peak	31.49	13.25	44.74	74.00	-29.26
7206.000	Average	25.52	13.25	38.77	54.00	-15.23
N/A						

Remark:

1. Measuring frequencies from 1 GHz to the 10th harmonic of highest fundamental frequency.

Report No.: TMWK2212005033KR

Test Mode:	BLE-2Mbps Mid CH	Temp/Hum	23.4(°C) / 64%RH
Test Item	Harmonic	Test Date	December 12, 2022
Polarize	Vertical	Test Engineer	Ray Li
Detector	Peak / Average		

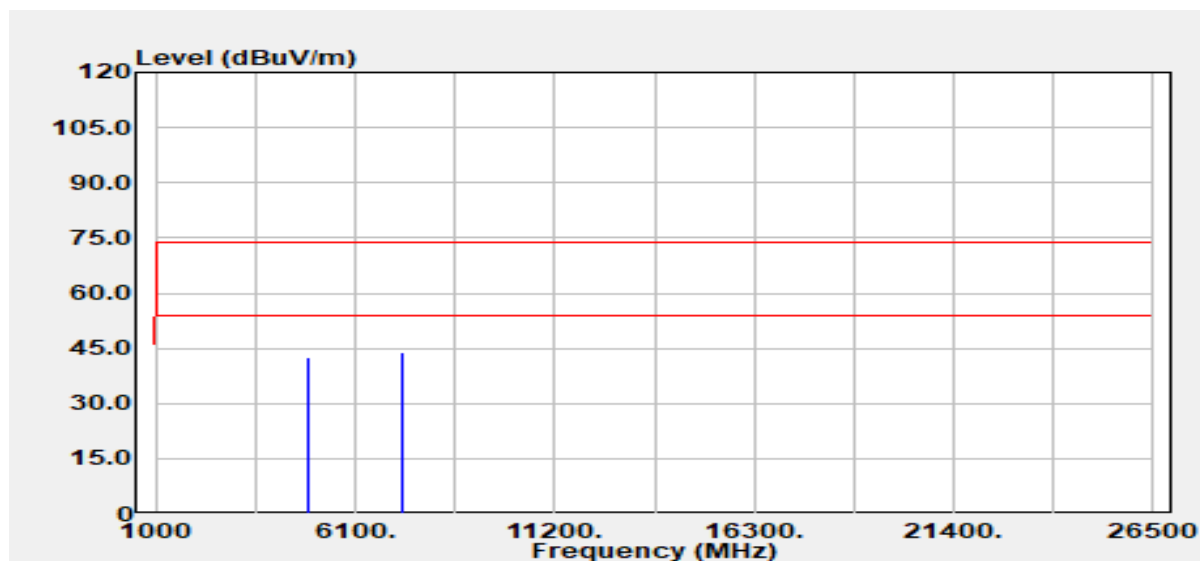

Freq. (MHz)	Detector Mode (PK/QP/AV)	Spectrum Reading Level (dB μ V)	Factor (dB)	Actual FS (dB μ V/m)	Limit @3m (dB μ V/m)	Margin (dB)
4880.000	Peak	36.53	6.13	42.65	74.00	-31.35
4880.000	Average	32.33	6.13	38.46	54.00	-15.54
7320.000	Peak	30.64	13.35	43.99	74.00	-30.01
7320.000	Average	25.03	13.35	38.38	54.00	-15.62
N/A						

Remark:

1. Measuring frequencies from 1 GHz to the 10th harmonic of highest fundamental frequency.

Report No.: TMWK2212005033KR

Test Mode:	BLE-2Mbps Mid CH	Temp/Hum	23.4(°C) / 64%RH
Test Item	Harmonic	Test Date	December 12, 2022
Polarize	Horizontal	Test Engineer	Ray Li
Detector	Peak / Average		

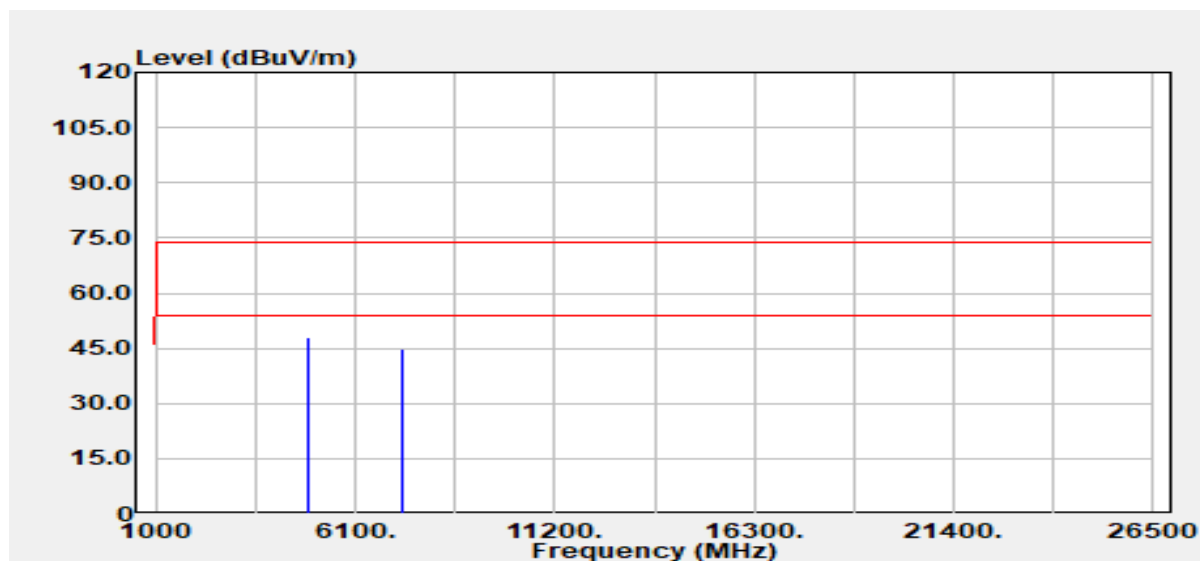

Freq. (MHz)	Detector Mode (PK/QP/AV)	Spectrum Reading Level (dBµV)	Factor (dB)	Actual FS (dBµV/m)	Limit @3m (dBµV/m)	Margin (dB)
4880.000	Peak	41.97	6.13	48.10	74.00	-25.90
4880.000	Average	36.48	6.13	42.61	54.00	-11.39
7320.000	Peak	31.53	13.35	44.88	74.00	-29.12
7320.000	Average	26.23	13.35	39.58	54.00	-14.42
N/A						

Remark:

1. Measuring frequencies from 1 GHz to the 10th harmonic of highest fundamental frequency.

Report No.: TMWK2212005033KR

Test Mode:	BLE-2Mbps High CH	Temp/Hum	23.4(°C) / 64%RH
Test Item	Harmonic	Test Date	December 12, 2022
Polarize	Vertical	Test Engineer	Ray Li
Detector	Peak / Average		

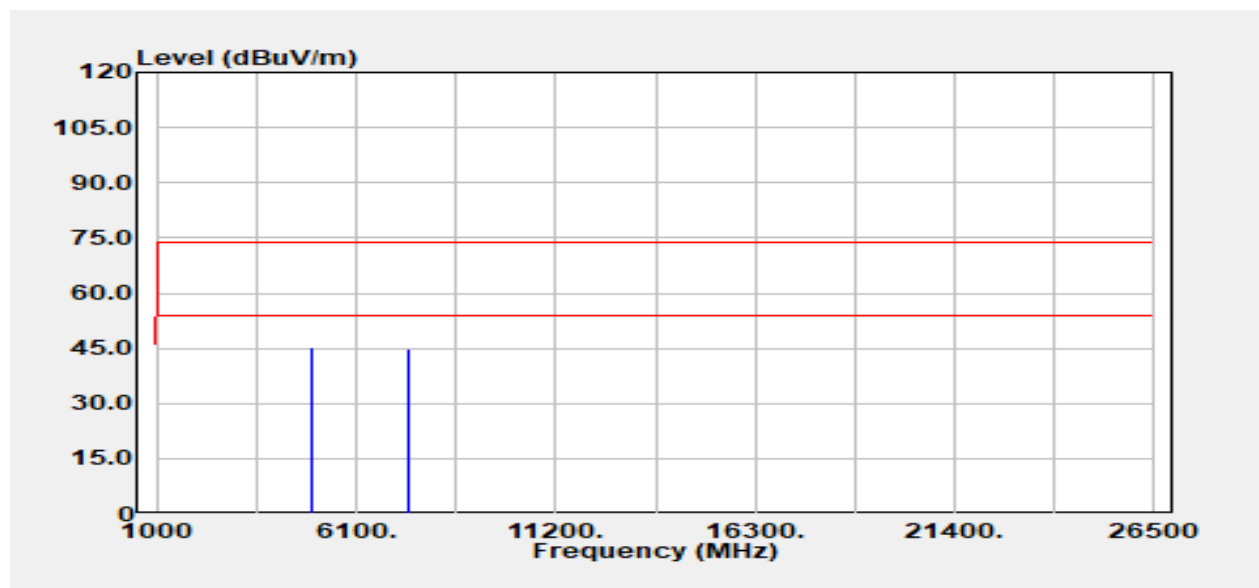

Freq. (MHz)	Detector Mode (PK/QP/AV)	Spectrum Reading Level (dBμV)	Factor (dB)	Actual FS (dBμV/m)	Limit @3m (dBμV/m)	Margin (dB)
4960.000	Peak	38.47	6.91	45.38	74.00	-28.62
4960.000	Average	32.81	6.91	39.72	54.00	-14.28
7440.000	Peak	31.52	13.22	44.74	74.00	-29.26
7440.000	Average	25.17	13.22	38.39	54.00	-15.61
N/A						

Remark:

1. Measuring frequencies from 1 GHz to the 10th harmonic of highest fundamental frequency.

Report No.: TMWK2212005033KR

Test Mode:	BLE-2Mbps High CH	Temp/Hum	23.4(°C) / 64%RH
Test Item	Harmonic	Test Date	December 12, 2022
Polarize	Horizontal	Test Engineer	Ray Li
Detector	Peak / Average		

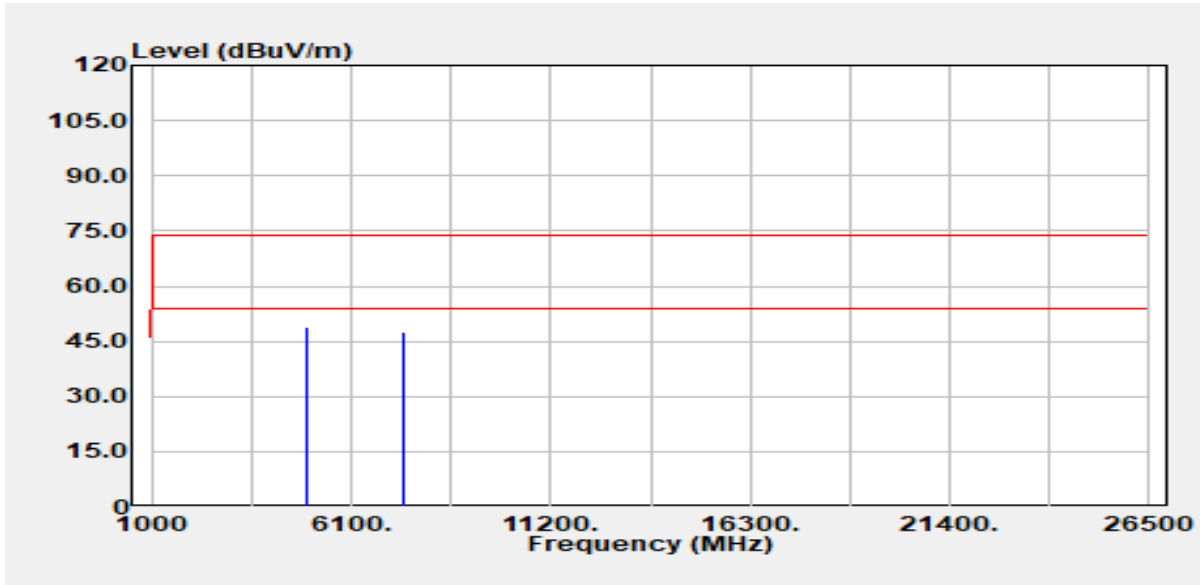

Freq. (MHz)	Detector Mode (PK/QP/AV)	Spectrum Reading Level (dBµV)	Factor (dB)	Actual FS (dBµV/m)	Limit @3m (dBµV/m)	Margin (dB)
4960.000	Peak	41.83	6.91	48.75	74.00	-25.25
4960.000	Average	37.10	6.91	44.01	54.00	-9.99
7440.000	Peak	34.37	13.22	47.59	74.00	-26.41
7440.000	Average	30.75	13.22	43.97	54.00	-10.03
N/A						

Remark:

1. Measuring frequencies from 1 GHz to the 10th harmonic of highest fundamental frequency.

--End of Test Report--