

BUTTONS AND SWITCHES

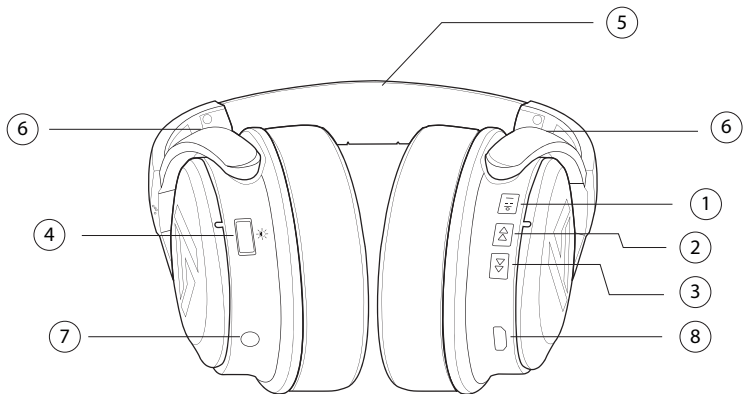

1. Multi- function Button/Play/Pause

2. Volume Down/ Previous Track

3. Volume Up/ Next Track

4. Lighting Effects

5. Headband

6. Headband Extension

7. Headphone 3.5mm Input Jack

8. Micro USB Charging Jack

POWER ON AND OFF YOUR HEADPHONES:

1. To power on your headphones, press the Multi-function Button (1) for 2 seconds.
2. To power off your headphones, press the Multi-function Button (1) for 3 seconds.

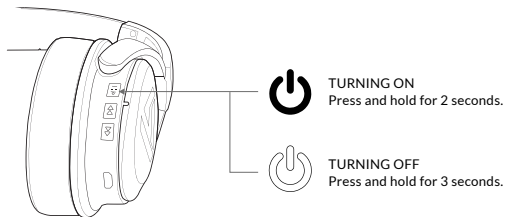

CONNECTING TO A BLUETOOTH DEVICE:

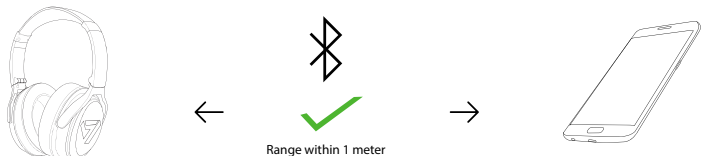

1. Turn on your mobile device and go to the Bluetooth menu.
2. Make sure the headphones are within one meter from the mobile device.

3. Press and hold the Multi-function Button (1) on your headphones for 3 seconds.

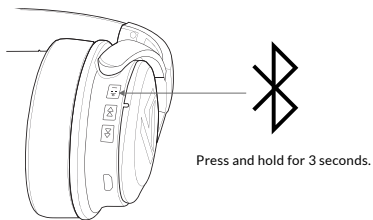

4. Select NEON 100 on the Bluetooth device menu. Ensure that the device shows "Connected" in the status display. (IF a PIN is required, enter 0000.)

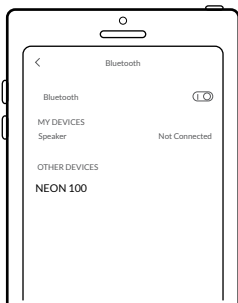

RECONNECTING TO A DISCONNECTED DEVICE:

1. If previously connected to a Bluetooth device, the NEON 100 will automatically reconnect with the device when powered on.

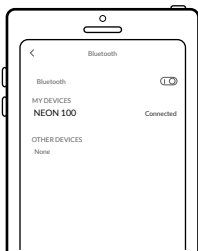

2. The headphones will not automatically reconnect if the one meter distance is exceeded.



Range more
than 1 meter



CONNECTION WAITING MODE:

1. If the headphones are powered on and no Bluetooth device is available for pairing, the headphones will enter "Connection Waiting Mode". If a Bluetooth device becomes available, press the Multi-function Button (1) to connect automatically.

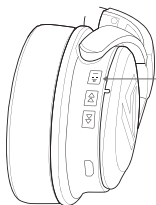

Press and hold
for 3 seconds.



2. If no Bluetooth device becomes available, the headphones will power off automatically after five minutes.



Automatically
turn off 5 minutes
when not used.

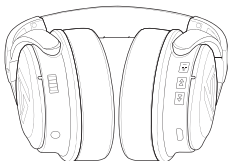

PLAYING AND CONTROLLING MUSIC:

1. Press the Multi-function Button (1) one time to play music from your Bluetooth device.
2. Press the Multi-function Button (1) for 1 second when music is playing to pause the music.
3. Press the Multi-function Button (1) for 1 second when music is paused to begin playing again.

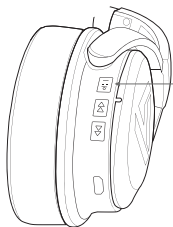

PLAY MODE

One time press to play music.

PAUSE MODE

One time press to play music.

RESUME PLAY

Press 1 second to resume music when paused.

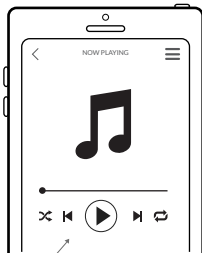

Icon change when Multi-function Button(1) press.

- To go back to the previous track, press the Volume Down Button (2) for 1 second.
- To skip to the next track, press the Volume Up Button (3) for 1 second.

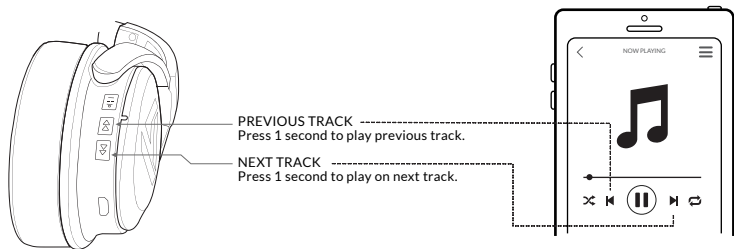

- To lower the volume, press and hold the Volume Down Button (2) for more than 1 second.
- To raise the volume, press and hold the Volume Up Button (3) for more than 1 second.

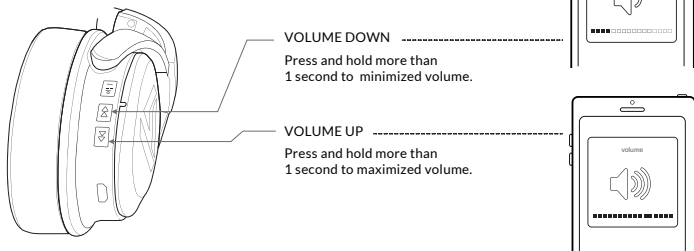

FCC STATEMENT :

This device complies with Part 15 of the FCC Rules. Operation is subject to the following two conditions:

- (1) This device may not cause harmful interference, and
- (2) This device must accept any interference received, including interference that may cause undesired operation.

Warning: Changes or modifications not expressly approved by the party responsible for compliance could void the user's authority to operate the equipment.

NOTE: This equipment has been tested and found to comply with the limits for a Class B digital device, pursuant to Part 15 of the FCC Rules. These limits are designed to provide reasonable protection against harmful interference in a residential installation. This equipment generates uses and can radiate radio frequency energy and, if not installed and used in accordance with the instructions, may cause harmful interference to radio communications. However, there is no guarantee that interference will not occur in a particular installation. If this equipment does cause harmful interference to radio or television reception, which can be determined by turning the equipment off and on, the user is encouraged to try to correct the interference by one or more of the following measures:

- Reorient or relocate the receiving antenna.

- Increase the separation between the equipment and receiver.

- Connect the equipment into an outlet on a circuit different from that to which the receiver is connected.

- Consult the dealer or an experienced radio/TV technician for help.

RF warning statement:

The device has been evaluated to meet general RF exposure requirement. The device can be used in portable exposure condition without restriction.