



FCC PART18 TEST REPORT

Applicant	:	THAI TOSHIBA ELECTRIC INDUSTRIES COMPANY LIMITED
Address of Applicant	:	129/1-5, Tiwanon Road, Tha Sai Sub-district, Mueang Nonthaburi District, Nonthaburi Province, Thailand
Manufacturer	:	THAI TOSHIBA ELECTRIC INDUSTRIES COMPANY LIMITED
Address of Manufacturer	:	129/1-5, Tiwanon Road, Tha Sai Sub-district, Mueang Nonthaburi District, Nonthaburi Province, Thailand
Equipment under Test	:	Microwave Oven
Trade Name	:	Midea, GE APPLIANCES
Model No.	:	EM831C##-P(GE), EM831C***-P(GE), PCHK11S1WBB, PCHK11S1WWW, PCHK11S1WSS
Model Tested	:	EM831C5H-P(GE)
FCC ID	:	2AULTEM831CYYGEW
Test Standard(s)	:	FCC Rules and Regulations Part 18 FCC/OST MP-5:1986
Report No.	:	DDT-RE25081412-1E01
Issue Date	:	2025/09/08
Issued By	:	Guangdong Dongdian Testing Service Co., Ltd. Unit 2, Building 1, No. 17, Zongbu 2nd Road, Songshan Lake Park, Dongguan, Guangdong, China, 523808

REPORT

Table of Contents

1.	Summary of Test Results	6
2.	General Test Information.....	7
2.1.	Description of EUT	7
2.2.	Accessories of EUT	8
2.3.	Assistant equipment used for test	8
2.4.	Block diagram EUT configuration for test.....	8
2.5.	Decision of final test mode	8
2.6.	Deviations of test standard	9
2.7.	Test environment conditions	9
2.8.	Test laboratory	9
2.9.	Measurement uncertainty	10
3.	AC Power Port Conducted Emission.....	11
3.1.	Test equipment.....	11
3.2.	Block diagram of test setup	11
3.3.	Limits	12
3.4.	Test procedure	13
3.5.	Test result.....	13
3.6.	Test data	14
3.7.	Test photo	16
4.	Radiated Emissions Test.....	17
4.1.	Test equipment.....	17
4.2.	Block diagram of test setup	18
4.3.	Limits	21
4.4.	Test procedure	22
4.5.	Test result.....	22
4.6.	Test data	23
4.7.	Test photo	26
5.	Operating frequency Test.....	27
5.1.	Test equipment.....	27
5.2.	Limits	27
5.3.	Test procedure	28
5.4.	Test result.....	28
6.	Radiation Hazard Test.....	29
6.1.	Test equipment.....	29
6.2.	Limits	29
6.3.	Test procedure	29

6.4.	Test result.....	29
6.5.	Test photo	29
7.	RF Output Power Measurement.....	30
7.1.	Test equipment.....	30
7.2.	Test procedure	30
7.3.	Test result.....	30
8.	Photos of the EUT	31

Test Report Declare

Applicant	:	THAI TOSHIBA ELECTRIC INDUSTRIES COMPANY LIMITED
Address	:	129/1-5, Tiwanon Road, Tha Sai Sub-district, Mueang Nonthaburi District, Nonthaburi Province, Thailand
Equipment under Test	:	Microwave Oven
Trade Name	:	Midea, GE APPLIANCES
Model No.	:	EM831C##-P(GE), EM831C***-P(GE), PCHK11S1WBB, PCHK11S1WWW, PCHK11S1WSS
Manufacturer	:	THAI TOSHIBA ELECTRIC INDUSTRIES COMPANY LIMITED
Address	:	129/1-5, Tiwanon Road, Tha Sai Sub-district, Mueang Nonthaburi District, Nonthaburi Province, Thailand



Test Standard Used:

FCC Rules and Regulations Part 18,
FCC/OST MP-5:1986

We Declare:

The equipment described above is tested by Guangdong Dongdian Testing Service Co., Ltd. and in the configuration tested the equipment complied with the standards specified above. The test results are contained in this test report and Guangdong Dongdian Testing Service Co., Ltd. is assumed of full responsibility for the accuracy and completeness of these tests.

Report No.:	DDT-RE25081412-1E01		
Date of Receipt:	2025/08/19	Date of Test:	2025/08/19--2025/08/28

Created: Sincere Luo	Reviewed: Lori Mi	Approved: Damon Hu
		
2025/08/28	2025/09/08	2025/09/08

Note: This report applies to above tested sample only. This report shall not be reproduced in parts without written approval of Guangdong Dongdian Testing Service Co., Ltd.

Revision History

Version	Revision Content	Issue Date	Approved
V0	Initial issue	2025/09/08	Damon Hu

1. Summary of Test Results

EMISSION (EMI)			
Description of Test Item	Standard	Result	Memo
AC Power Port Conducted Emission	FCC Rules and Regulations Part 18.307(b)	PASS	/
Radiated Emissions Test	FCC Rules and Regulations Part 18.305(b)	PASS	/
Operating frequency	FCC Rules and Regulations Part 18, FCC/OST MP-5:1986	PASS	/
Radiation Hazard Test	FCC Rules and Regulations Part 18, FCC/OST MP-5:1986	PASS	/
RF Output Power Measurement	FCC Rules and Regulations Part 18, FCC/OST MP-5:1986	PASS	/

Note 1: N/A is an abbreviation for Not Applicable, and means this item is not applicable for this device or no need to test according to standard.

Note 2: For the EMI measurements have made the EUT operated in a mode producing the highest emission level, and attempted to vary the configuration of the EUT radiated the highest emission.

2. General Test Information

2.1. Description of EUT

EUT* Name	: Microwave Oven
Trade Name	: Midea, GE APPLIANCES
Model Number	: EM831C##-P(GE), EM831C***-P(GE), PCHK11S1WBB, PCHK11S1WWW, PCHK11S1WSS
Difference of model number	<p>Model designations as follows: E: Film type keypad; M: Indicates Microwave; 831: "8" indicates the microwave output power is 800W, "31" indicates cavity capacity is 31 liters; C: Indicates the design No.; ##/***: "#", "*" = 0-9, A-Z or blank, indicates different appearance; -P (GE): Wi-Fi function.</p> <p>All the above-mentioned models are identical to the model of EM831C5H-P(GE) except for model name, trade mark and appearance. Model of EM831C5H-P(GE) was selected for final testing.</p>
EUT Function Description	: Please reference user manual of this device
Power Supply	: AC 120V/60Hz
Rated input Power (microwave)	: 1200W
Rated output Power (microwave)	: 800W
EUT Class (Only For EMI)	: Class B
Operation Frequency	: 2450MHz
Magnetron Model	: 2M519J
Magnetron Manufacturer	: WITOL
Sample Number	: S25081412-001
Description of Support Units	<ul style="list-style-type: none"> -Load for power output measurement: 1000 milliliters of water in the beaker located in the center of the oven. -Load for frequency measurement: 1000 milliliters of water in the beaker located in the center of the oven. -Load for measurement of radiation on second and third harmonic: Two loads, one of 700 and the other of 300 milliliters, of water are used. Each load is tested both with the beaker located in the center of the oven and with it in the right front corner. -Load for all other measurements: 700 milliliters of water, with the beaker located in the center of the oven.

Note 1: EUT is the abbreviation of equipment under test.

Note 2: "☑" means to be chosen or applicable; "☐" means don't to be chosen or not applicable; This note applies to entire report.

Note 3: Equipment meeting Class A requirements may not offer adequate protection to broadcast services within a residential environment; The Class B requirements for equipment are intended to offer adequate protection to broadcast services within the residential environment. Equipment

compliant with the class A requirements should have a warning notice in the user manual stating that it could cause radio interference. For example, Warning: Operation of this equipment in a residential environment could cause radio interference.

2.2. Accessories of EUT

Accessories	Manufacturer	Model number	Description
/	/	/	/

2.3. Assistant equipment used for test

Assistant equipment	Manufacturer	Model number	Description	other
/	/	/	/	/

2.4. Block diagram EUT configuration for test

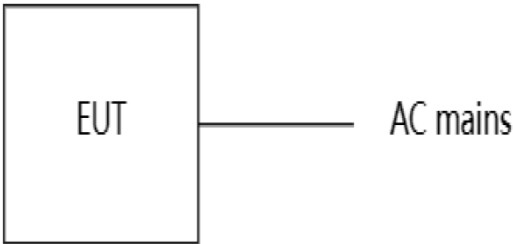
Mode No	Mode	Configuration diagram
Mode 1	Heating mode	 <pre> graph LR EUT[EUT] --- AC_mains[AC mains] </pre>

2.5. Decision of final test mode

AC Power Port Conducted Emission	Mode 1: Heating mode
Radiated Emissions Test	Mode 1: Heating mode
Operating frequency	Mode 1: Heating mode
Radiation Hazard Test	Mode 1: Heating mode
RF Output Power Measurement	Mode 1: Heating mode

2.6. Deviations of test standard

No deviation.

2.7. Test environment conditions

During the measurement the environmental conditions were within the listed ranges:

Temperature range:	20-25°C
Humidity range:	40-75%
Pressure range:	86-106 kPa

Note: The specific temperature and humidity information of each test item refers to the temperature and humidity record in the corresponding test data.

2.8. Test laboratory

Guangdong Dongdian Testing Service Co., Ltd.

Add.: Unit 2, Building 1, No. 17, Zongbu 2nd Road, Songshan Lake Park, Dongguan, Guangdong, China, 523808.

Tel.: +86-0769-38826678, <http://www.dgddt.com>, Email: ddt@dgddt.com.

CNAS Accreditation No. L6451; A2LA Accreditation Number: 3870.01

FCC Designation Number: CN1182, Test Firm Registration Number: 540522

Innovation, Science and Economic Development Canada Site Registration Number: 10288A

Conformity Assessment Body identifier: CN0048

VCCI facility registration number: C-20087, T-20088, R-20123, R-20155, G-20118

2.9. Measurement uncertainty

Test Item	Uncertainty
Conducted disturbance at mains terminals	1#: 3.72dB (9 kHz to 150 kHz), 3.34dB (150 kHz to 30 MHz)
	2#: 3.75dB (9 kHz to 150 kHz), 3.39dB (150 kHz to 30 MHz)
	3#: 3.78dB (9 kHz to 150 kHz), 3.37dB (150 kHz to 30 MHz)
Uncertainty for Antenna Power Conduction Measurement for Antenna port of Receivers	1#: AAN with aLCL = 55 ... 40 dBc: 3.64 dB AAN with aLCL = 65 ... 50 dBc: 4.08 dB AAN with aLCL = 75 ... 60 dBc: 4.56 dB
	2#: AAN with aLCL = 55 ... 40 dBc: 3.82 dB AAN with aLCL = 65 ... 50 dBc: 3.96 dB AAN with aLCL = 75 ... 60 dBc: 4.12 dB
Uncertainty for Radiation Emission test (30MHz-1GHz)	1#: 4.94 dB (Antenna Polarize: V) 4.68 dB (Antenna Polarize: H)
	2#: 4.94 dB (Antenna Polarize: V) 4.68 dB (Antenna Polarize: H)
	3#: 4.96 dB (Antenna Polarize: V) 4.98 dB (Antenna Polarize: H)
	10m: 4.48 dB (Antenna Polarize: V) 4.64 dB (Antenna Polarize: H)
Uncertainty for Radiation disturbance test (1GHz to 6GHz)	1#: 4.10 dB (1-6 GHz)
	3#: 4.54 dB (1-6 GHz)
Uncertainty for Radiation disturbance test (6GHz to 18GHz)	1#: 4.40 dB (6-18 GHz)
	3#: 4.80 dB (6-18 GHz)
Uncertainty for Radiation disturbance test (18GHz to 40GHz)	1#: 4.58 dB (18-40 GHz)
	3#: 4.58 dB (18-40 GHz)
Temperature	0.4 °C
Humidity	2%
Note: This uncertainty represents an expanded uncertainty expressed at approximately the 95% confidence level using a coverage factor of k=2.	

3. AC Power Port Conducted Emission

3.1. Test equipment

Equipment	Manufacturer	Model No.	Equipment No.	Cal Due To
EMI Test Receiver	R&S	ESCI 3	DDT-ZC01972	2026/03/28
Two Line V-Network	R&S	ENV216	DDT-ZC00586	2026/07/06
Pulse Limiter	R&S	KH43101	DDT-ZC00747	2026/03/28
Coaxial signal signal cable	H&S	RG214-5	DDT-ZC01817	2026/03/28
Conducted Radiated Software	Audix	E3	DDT-ZC00562	/
Two Line V-Network	R&S	ENV216	DDT-ZC02058	2026/07/06

3.2. Block diagram of test setup

For table-top equipment

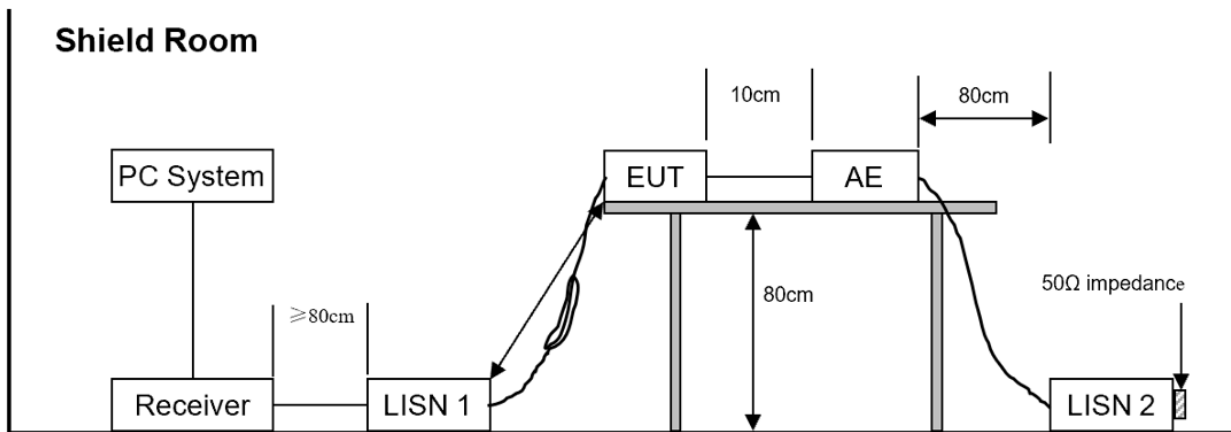

For floor standing equipment

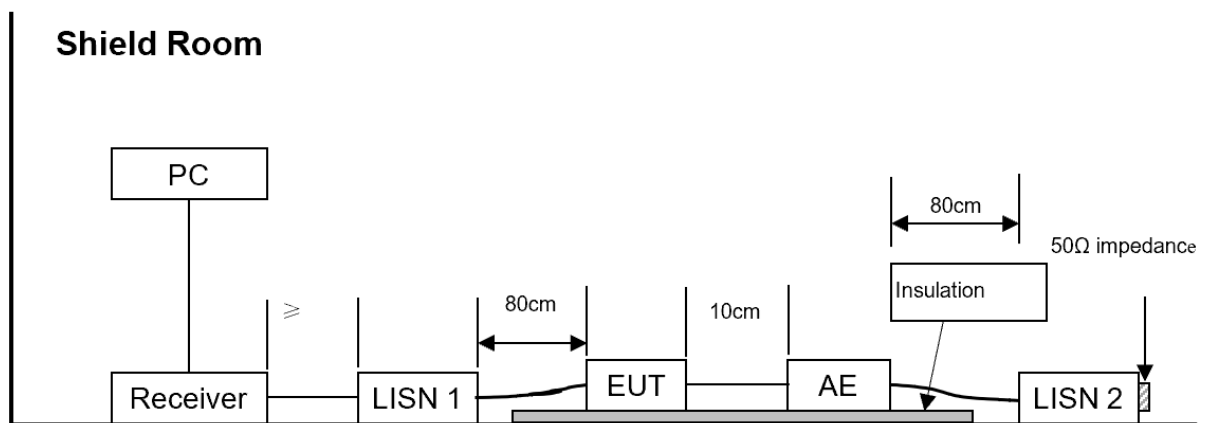

For combinations equipment

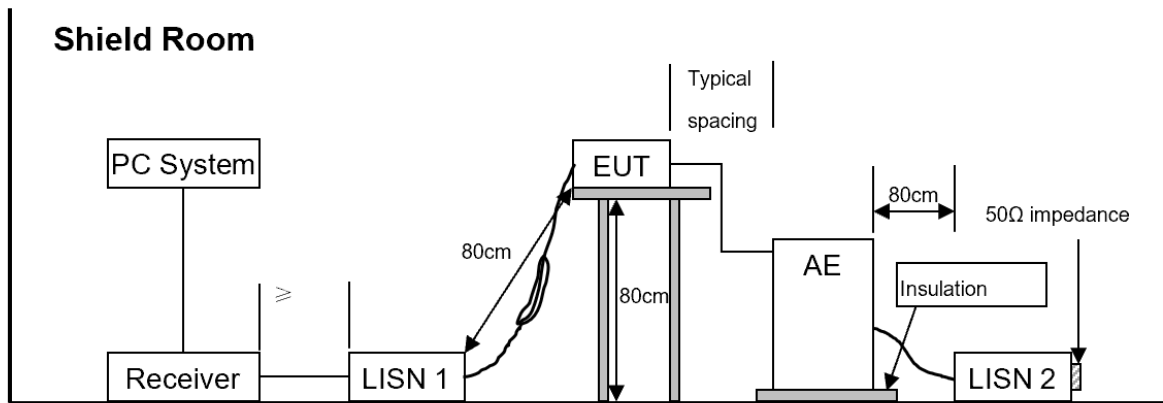

3.3. Limits

Class A		
Frequency	Quasi-Peak Level dB(μ V)	Average Level dB(μ V)
150 kHz~500 kHz	79	66
500 kHz~30 MHz	73	60
Class B		
Frequency	Quasi-Peak Level dB(μ V)	Average Level dB(μ V)
150 kHz~500 kHz	66 ~ 56*	56 ~ 46*
500 kHz~5 MHz	56	46
5 MHz~30 MHz	60	50

Notes:

- * Decreasing linearly with logarithm of frequency.
- The lower limit shall apply at the transition frequencies.

3.4. Test procedure

The EUT and Support equipment, if needed, were put placed on a non-metallic table, 0.8m (table-top device)/0.1m (floor stand device) above the ground plane.

All I/O cables were positioned to simulate typical actual usage as per ANSI C63.4.

All support equipment power received from a second LISN.

Emissions were measured on each current carrying line of the EUT using an EMI Test Receiver connected to the LISN powering the EUT.

The Receiver scanned from 150 kHz to 30MHz for emissions in each of the test modes.

During the above scans, the emissions were maximized by cable manipulation.

After the preliminary scan, we found the test mode producing the highest emission level.

The EUT configuration and worse cable configuration of the above highest emission levels were recorded for reference of the final test.

EUT and support equipment were set up on the test bench as per the configuration with highest emission level in the preliminary test.

A scan was taken on both power lines, Neutral and Line, recording at least the six highest emissions. Emission frequency and amplitude were recorded into a computer in which correction factors were used to calculate the emission level and compare reading to the applicable limit.

The test data of the worst-case condition(s) was recorded.

The bandwidth of test receiver is set at 9 kHz.

3.5. Test result

PASS. (See below detailed test result)

Note 1: All emissions not reported below are too low against the prescribed limits.

Note 2: "-----" means Peak detection; "-----" means Average detection.

3.6. Test data

TR-4-E-010 Conducted Emission Test Result

Test Site : DDT 5# Shield Room **D:\2025 report data\Q25081412-1E0823 CE.EM6**
Test Date : 2025-08-23 **Tested By** : Alex Liu
EUT : Microwave Oven **Model Number** : EM831C5H-P(GE)
Power Supply : AC 120V/60Hz **Test Mode** : Heating mode
Condition : Temp:24.9°C,Humi:53.8% **LISN** : 2025 2# 216/NEUTRAL
Memo :

Data: 2

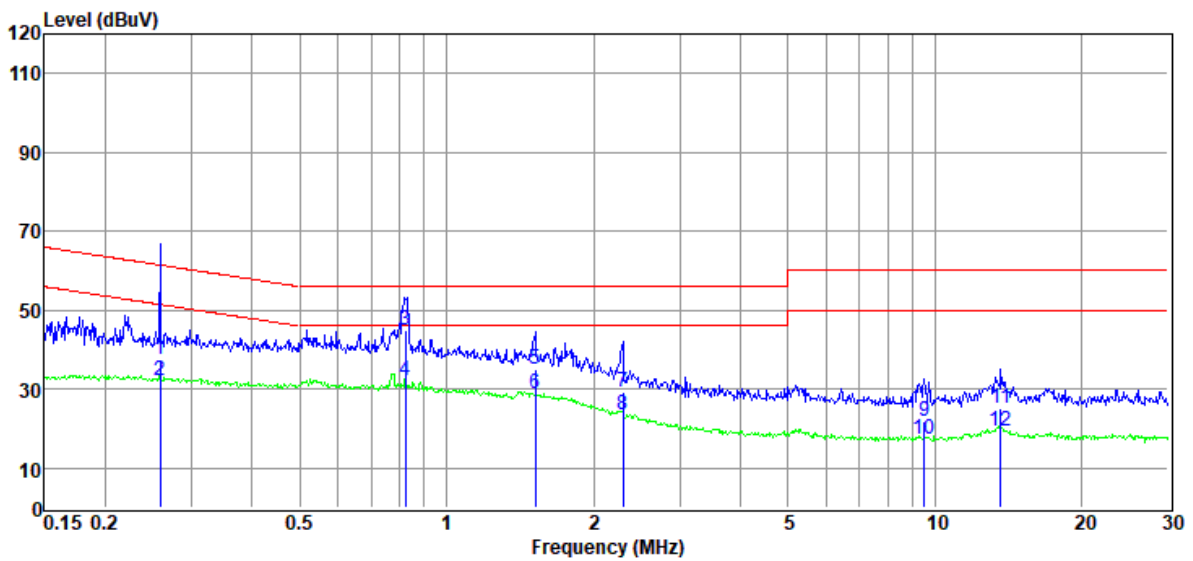

Item (Mark)	Freq. (MHz)	Read Level (dB μ V)	LISN Factor (dB)	Cable Loss (dB)	Pulse Limiter Factor (dB)	Result Level (dB μ V)	Limit Line (dB μ V)	Over Limit (dB)	Detector	Phase
1	0.26	17.91	9.48	0.06	10.23	37.68	61.47	-23.79	QP	NEUTRAL
2	0.26	12.43	9.48	0.06	10.23	32.20	51.47	-19.27	Average	NEUTRAL
3	0.82	24.74	9.48	0.15	10.38	44.75	56.00	-11.25	QP	NEUTRAL
4	0.82	12.02	9.48	0.15	10.38	32.03	46.00	-13.97	Average	NEUTRAL
5	1.52	15.16	9.50	0.20	10.39	35.25	56.00	-20.75	QP	NEUTRAL
6	1.52	8.78	9.50	0.20	10.39	28.87	46.00	-17.13	Average	NEUTRAL
7	2.30	9.08	9.50	0.21	10.37	29.16	56.00	-26.84	QP	NEUTRAL
8	2.30	3.57	9.50	0.21	10.37	23.65	46.00	-22.35	Average	NEUTRAL
9	9.50	1.83	9.61	0.27	10.15	21.86	60.00	-38.14	QP	NEUTRAL
10	9.50	-2.75	9.61	0.27	10.15	17.28	50.00	-32.72	Average	NEUTRAL
11	13.62	4.75	9.76	0.31	10.19	25.01	60.00	-34.99	QP	NEUTRAL
12	13.62	-0.74	9.76	0.31	10.19	19.52	50.00	-30.48	Average	NEUTRAL

Note: 1. Result Level = Read Level + LISN Factor + Pulse Limiter Factor + Cable loss.

2. If QP Result complies with AV limit, AV Result is deemed to comply with AV limit.

3. Test setup: RBW: 200 Hz (9 kHz—150 kHz), 9 kHz (150 kHz—30 MHz).

4. Step size: 80Hz (0.009MHz-0.15MHz), 4 kHz (0.15MHz-30MHz), Scan time: auto.

TR-4-E-010 Conducted Emission Test Result

Test Site : DDT 5# Shield Room **D:\2025 report data\Q25081412-1E\0823 CE.EM6**
Test Date : 2025-08-23 **Tested By** : Alex Liu
EUT : Microwave Oven **Model Number** : EM831C5H-P(GE)
Power Supply : AC 120V/60Hz **Test Mode** : Heating mode
Condition : Temp:24.9°C,Humi:53.8% **LISN** : 2025 2# 216/LINE
Memo :

Data: 4

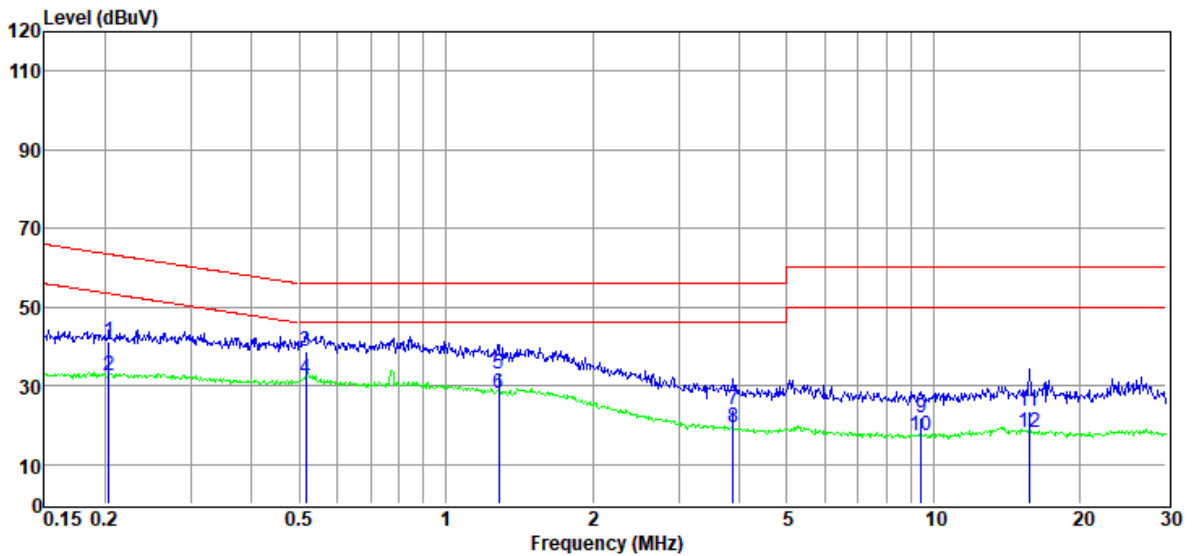

Item (Mark)	Freq. (MHz)	Read Level (dBuV)	LISN Factor (dB)	Cable Loss (dB)	Pulse Limiter Factor (dB)	Result Level (dBuV)	Limit Line (dBuV)	Over Limit (dB)	Detector	Phase
1	0.20	21.43	9.46	0.05	10.20	41.14	63.45	-22.31	QP	LINE
2	0.20	12.92	9.46	0.05	10.20	32.63	53.45	-20.82	Average	LINE
3	0.52	18.79	9.49	0.10	10.32	38.70	56.00	-17.30	QP	LINE
4	0.52	11.64	9.49	0.10	10.32	31.55	46.00	-14.45	Average	LINE
5	1.28	12.99	9.49	0.19	10.40	33.07	56.00	-22.93	QP	LINE
6	1.28	8.08	9.49	0.19	10.40	28.16	46.00	-17.84	Average	LINE
7	3.88	3.86	9.53	0.23	10.30	23.92	56.00	-32.08	QP	LINE
8	3.88	-0.88	9.53	0.23	10.30	19.18	46.00	-26.82	Average	LINE
9	9.45	2.03	9.58	0.27	10.15	22.03	60.00	-37.97	QP	LINE
10	9.45	-2.84	9.58	0.27	10.15	17.16	50.00	-32.84	Average	LINE
11	15.72	3.26	9.76	0.32	10.23	23.57	60.00	-36.43	QP	LINE
12	15.72	-2.07	9.76	0.32	10.23	18.24	50.00	-31.76	Average	LINE

- Note: 1. Result Level = Read Level + LISN Factor + Pulse Limiter Factor + Cable loss.
 2. If QP Result complies with AV limit, AV Result is deemed to comply with AV limit.
 3. Test setup: RBW: 200 Hz (9 kHz—150 kHz), 9 kHz (150 kHz—30 MHz).
 4. Step size: 80Hz (0.009MHz-0.15MHz), 4 kHz (0.15MHz-30MHz), Scan time: auto.

3.7. Test photo

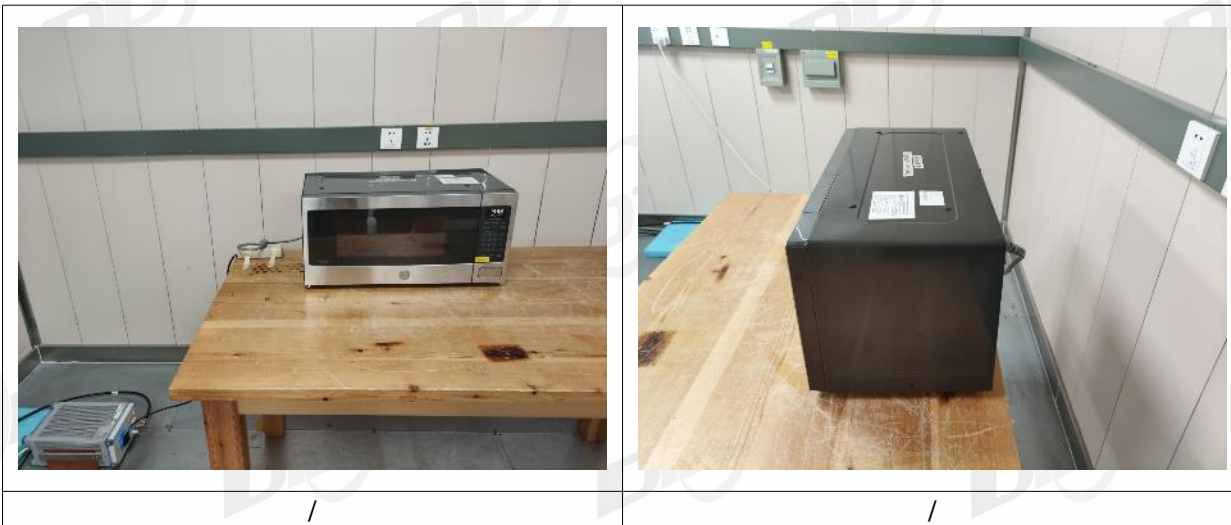

4. Radiated Emissions Test

4.1. Test equipment

Equipment	Manufacturer	Model No.	Equipment No.	Cal Due To
EMI Test Receiver	R&S	ESCI 3	DDT-ZC01972	2026/03/28
Active Loop Antenna	Schwarzbeck	FMZB1519	DDT-ZC00524	2025/09/11
Trilog Broadband Antenna	Schwarzbeck	VULB 9163	DDT-ZC00246	2026/07/18
RF Cable	H&S	RG214-11	DDT-ZC01497	2026/03/28
Spectrum Analyzer	Agilent	E4440A	DDT-ZC01445	2026/03/28
Broad-Band Horn Antenna	Schwarzbeck	BBHA 9170	DDT-ZC00506	2026/04/01
Horn Antenna	SCHWARZBEC K	BBHA9120 D	DDT-ZC01218	2027/08/10
Preamplifier	COM-POWER	PAM-118A	DDT-ZC01489	2026/08/10
Pre-amplifier	COM-POWER	PAM-840A	DDT-ZC01693	2026/03/28
EMI Test Software	Audix/TW	e3	DDT-ZC01252	/
RF cable	Zhongke Junchuang	JCTB810-NJ-NJ- 7M	DDT-ZC02759	2026/07/22

4.2. Block diagram of test setup

In 3 m Anechoic Chamber Test Setup Diagram for 9 kHz ~ 30 MHz

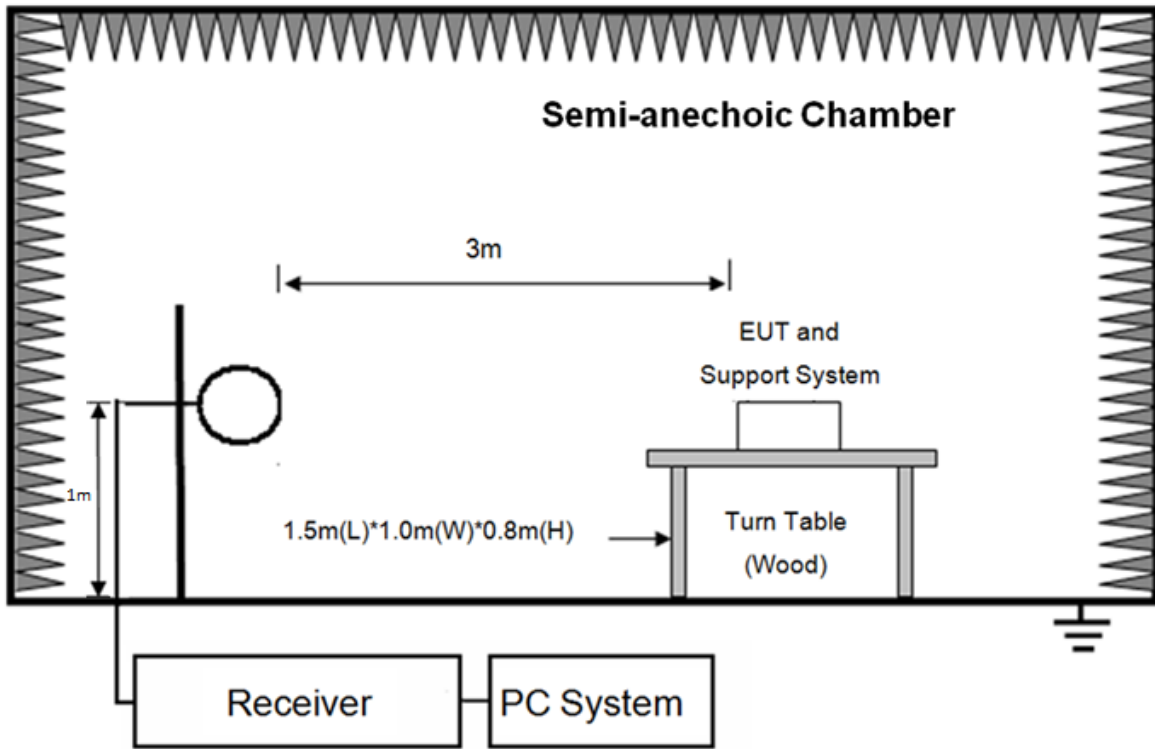

Below 1 GHz

For table-top equipment

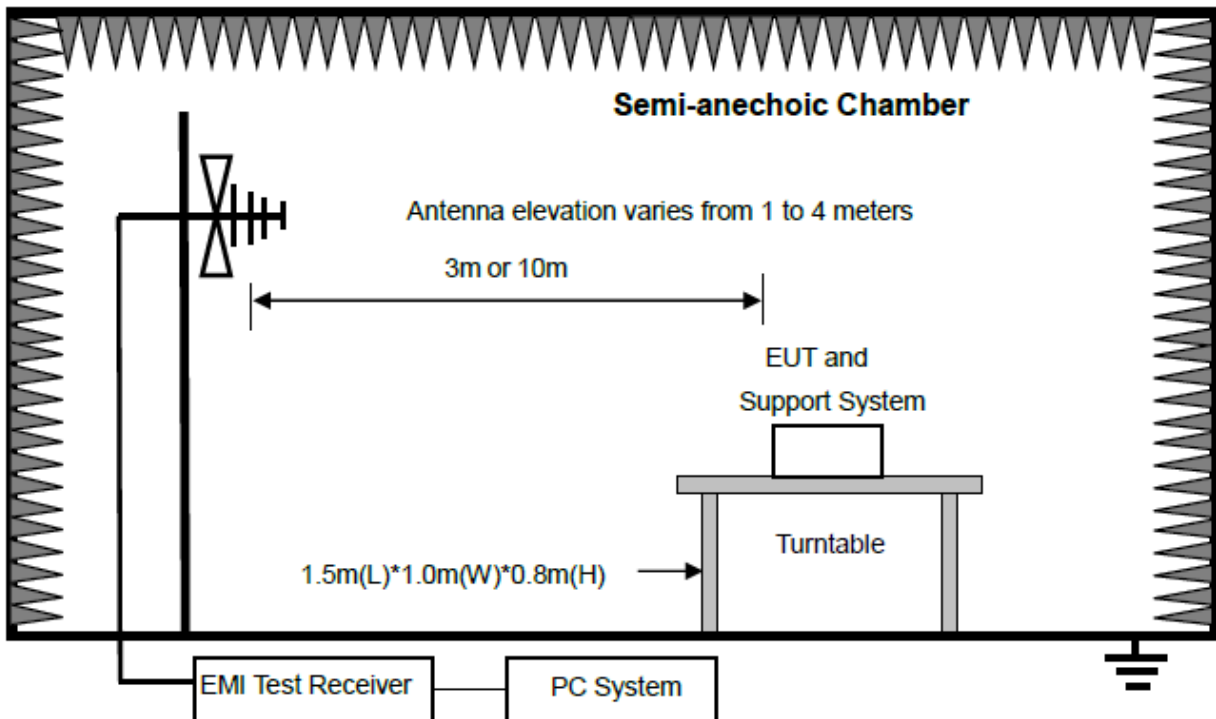

For floor standing equipment

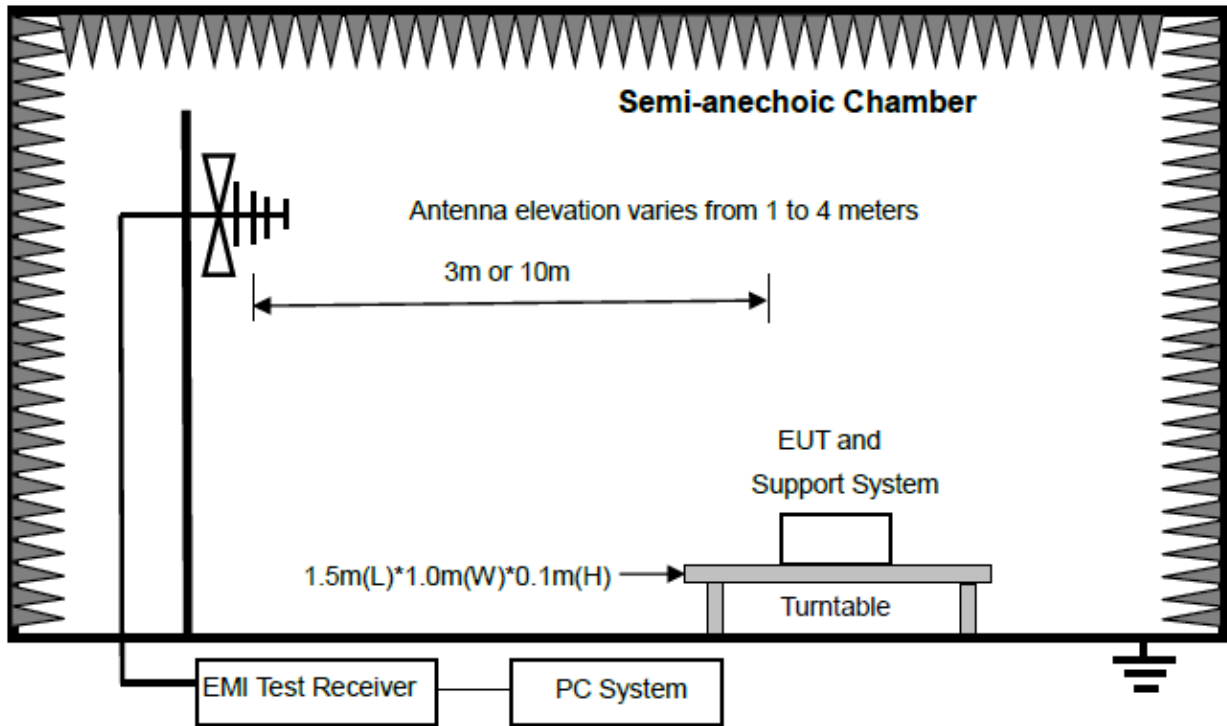

For combinations equipment

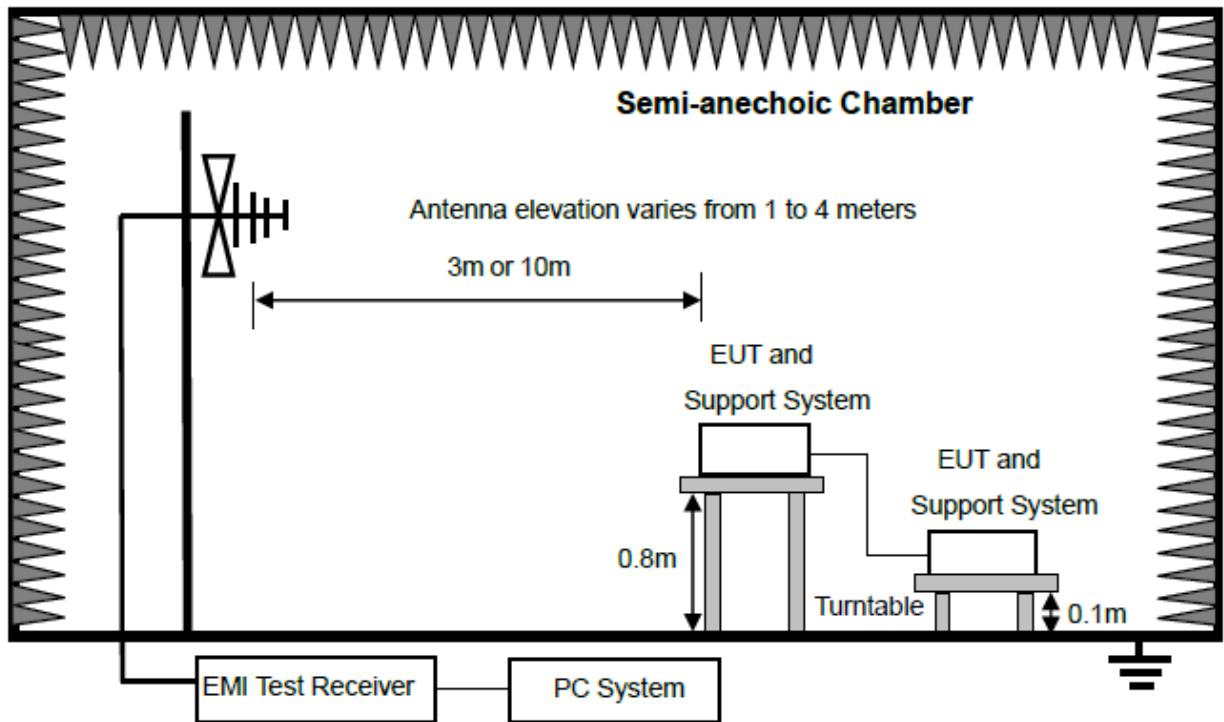

Above 1 GHz

For table-top equipment

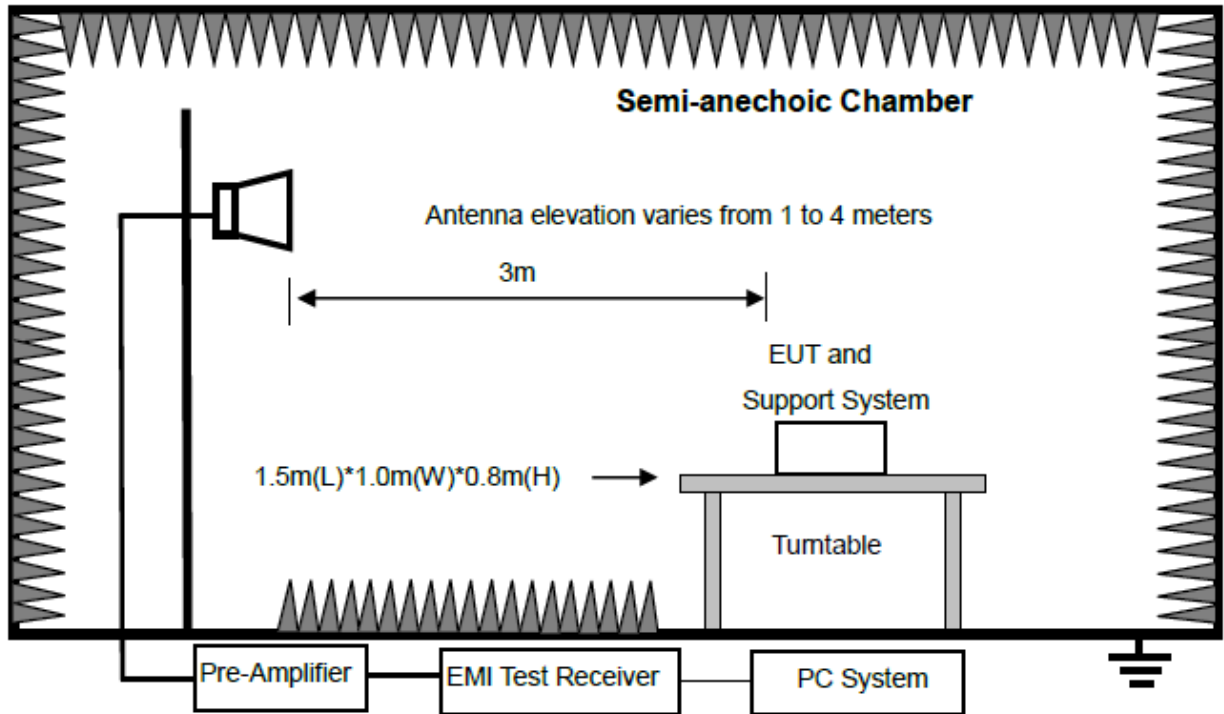

For floor standing equipment

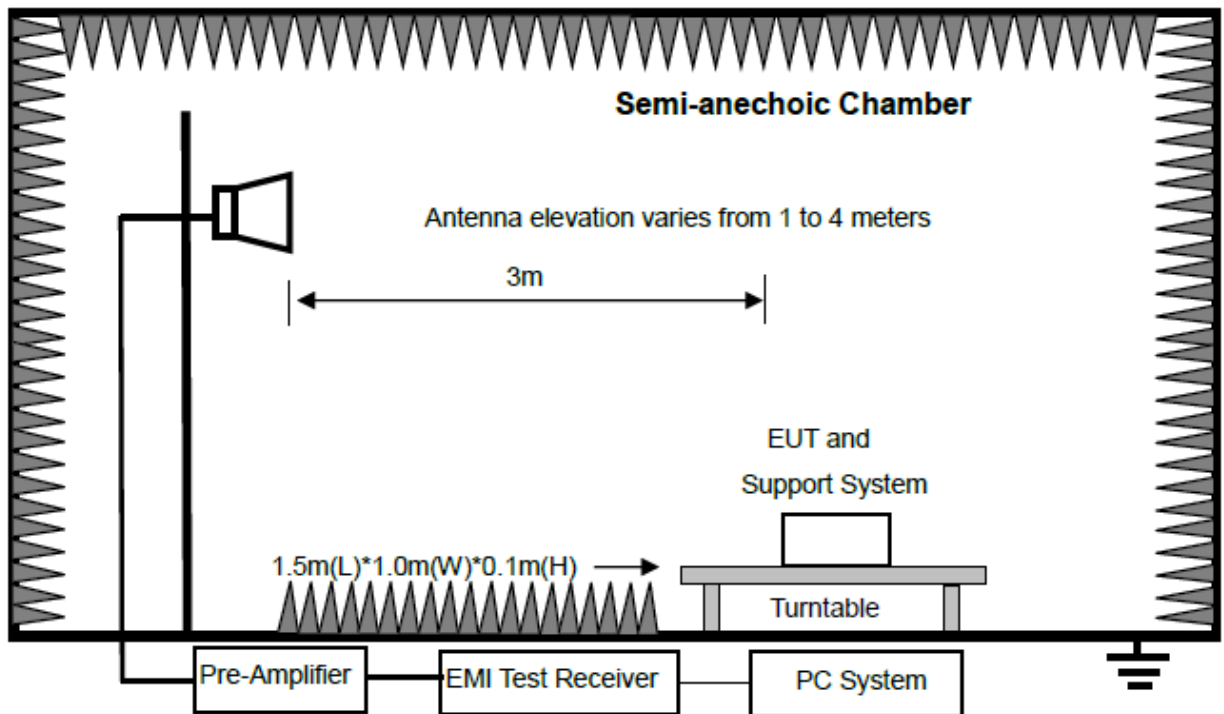

For combinations equipment

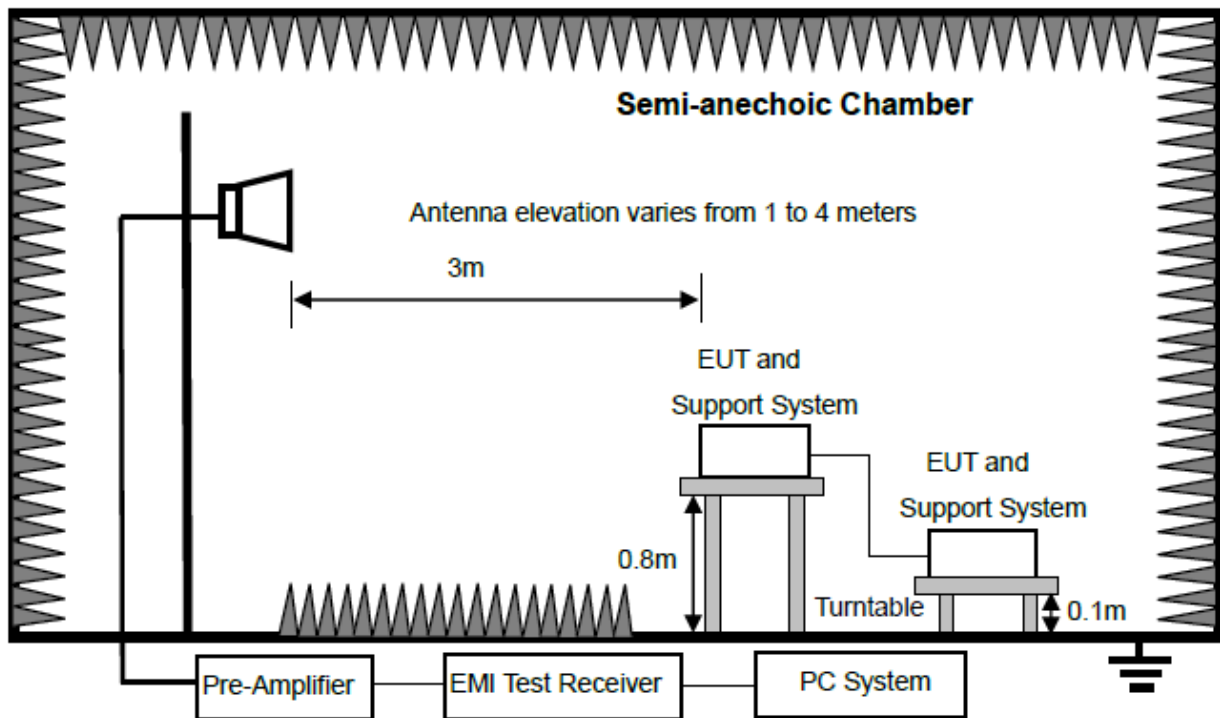

4.3. Limits

- (a) ISM equipment operation on a frequency specified in §18.301 is permitted unlimited radiated energy in the band specified for that frequency.
- (b) The field strength levels of emissions which lie outside the bands specified in §18.301, unless otherwise indicated, shall not exceed the following:

RF Power generated by equipment(watts)	Field strength limit(uV/m) @300m
Below 500	25
On or Above 500	$25 \cdot \sqrt{\text{power}/500}$

Power=701.11W

Limit $20 \lg(25 \cdot \sqrt{\text{power}/500}) + 20 \lg(300/3)$ @ 3m distance.

4.4. Test procedure

Procedure of Preliminary Test

The EUT and Support equipment, if needed, were put placed on a non-metallic table, 0.8m (table-top device)/0.1m (floor stand device) above the ground plane.

Configuration EUT to simulate typical usage as described in as shown above block diagram and equipment list of this report.

All I/O cables were positioned to simulate typical actual usage as per FCC/OET MP-5.

Mains cables, telephone lines or other connections to auxiliary equipment located outside the test are shall drape to the floor, be fitted with ferrite clamps or ferrite tubes placed on the floor at the point where the cable reaches the floor and then routed to the place where they leave the turntable. No extension cords shall be used to mains receptacle.

The antenna was placed at 3 meter away from the EUT as stated in FCC/OET MP-5. The antenna connected to the Spectrum Analyzer via a cable and at times a pre-amplifier would be used.

The Analyzer / Receiver quickly scanned from 9 kHz to 30 MHz/18 GHz. The EUT test program was started. Emissions were scanned and measured rotating the EUT to 360 degrees and positioning the antenna 1 to 4 meters above the ground plane, in both the vertical and the horizontal polarization, to maximize the emission reading level.

After the preliminary scan, we found the test mode producing the highest emission level. The EUT and cable configuration, antenna position, polarization and turntable position of the above highest emission level were recorded for the final test.

Procedure of Final Test

EUT and support equipment were set up on the turntable as per the configuration with highest emission level in the preliminary test.

The Analyzer / Receiver scanned from 9 kHz to 30 M Hz/18 GHz. Emissions were scanned and measured rotating the EUT to 360 degrees, varying cable placement and positioning the antenna 1 to 4 meters above the ground plane, in both the vertical and the horizontal polarization, to maximize the emission reading level.

Recorded at least the six highest emissions. Emission frequency, amplitude, antenna position, polarization and turntable position were recorded into a computer in which correction factors were used to calculate the emission level and compare reading to the applicable limit and only Q.P. reading is presented.

For emissions from 30 MHz to 1 GHz, Quasi-Peak values were measured with EMI Receiver and the bandwidth of Receiver is 120 kHz.

For emissions above 1 GHz, both Peak and Average level were measured with Spectrum Analyzer, and the RBW is set at 1 MHz VBW is set at 3 MHz.

The test data of the worst-case condition(s) was recorded.

4.5. Test result

PASS. (See below detailed test result)

Note 1: All emissions not reported below are too low against the prescribed limits.

Note 2: "----" means Peak detection.

4.6. Test data

TR-4-E-009 Radiated Emission Test Result

Test Site : DDT 3m Chamber 2# **D:\2025 RE2# Report Data\Q25081412-1E\0822 RE.EM6**
Test Date : 2025-08-22 **Tested By** : Aaron Liu
EUT : Microwave Oven **Model Number** : EM831C5H-P(GE)
Power Supply : AC 120V/60Hz **Test Mode** : Heating mode
Condition : Temp:21.9 °C,Humi:49.8% **Antenna/Distance** : 2025 VULB9163 2#/3m/VERTICAL
Memo :
 Data: 1

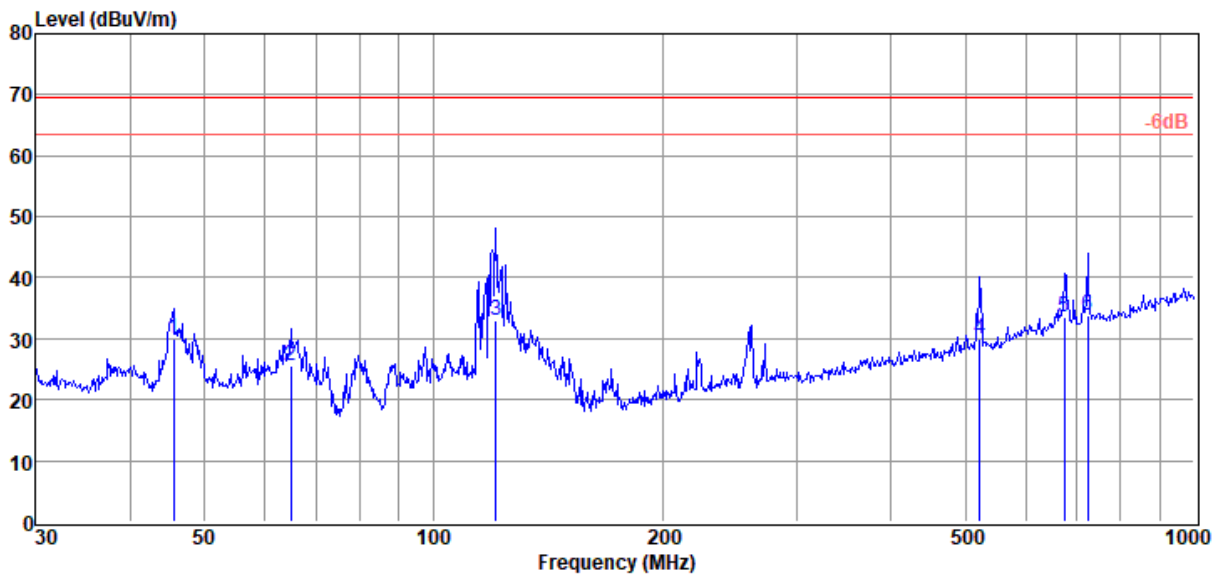

Item (Mark)	Freq. (MHz)	Read Level (dB μ V)	Antenna Factor (dB/m)	Cable Loss (dB)	Result Level (dB μ V/m)	Limit Line (dB μ V/m)	Over Limit (dB)	Detector	Polarization
1	45.54	12.64	13.33	4.00	29.97	69.42	-39.45	QP	VERTICAL
2	64.89	9.08	12.25	4.21	25.54	69.42	-43.88	QP	VERTICAL
3	120.70	18.87	9.75	4.46	33.08	69.42	-36.34	QP	VERTICAL
4	522.72	6.03	17.09	6.90	30.02	69.42	-39.40	QP	VERTICAL
5	675.21	6.14	19.70	7.73	33.57	69.42	-35.85	QP	VERTICAL
6	724.26	5.99	19.91	8.00	33.90	69.42	-35.52	QP	VERTICAL

Note: 1. Result Level = Read Level + Antenna Factor + Cable loss.

2. If Peak Result complies with QP limit, QP Result is deemed to comply with QP limit.

3. Test setup: RBW: 120 kHz, VBW: 300 kHz, Sweep time: auto.

TR-4-E-009 Radiated Emission Test Result

Test Site : DDT 3m Chamber 2# **D:\2025 RE2# Report Data\Q25081412-1E\0822 RE.EM6**
Test Date : 2025-08-22 **Tested By** : Aaron Liu
EUT : Microwave Oven **Model Number** : EM831C5H-P(GE)
Power Supply : AC 120V/60Hz **Test Mode** : Heating mode
Condition : Temp:21.9 °C,Humi:49.8% **Antenna/Distance** : 2025 VULB9163 2#/3m/HORIZONTAL
Memo :

Data: 2

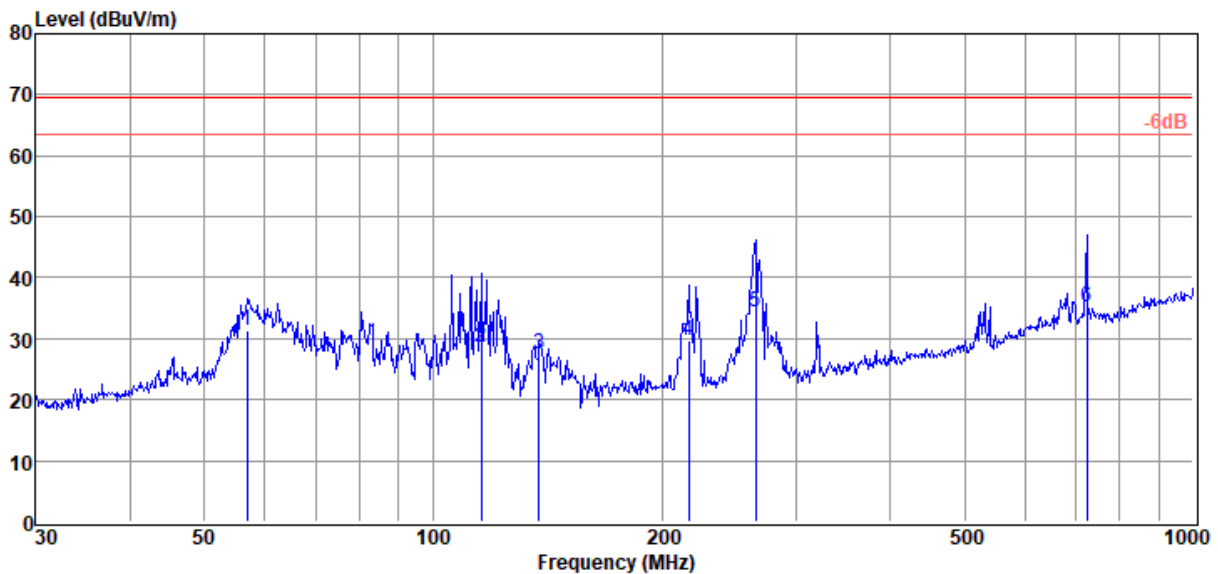

Item (Mark)	Freq. (MHz)	Read Level (dB μ V)	Antenna Factor (dB/m)	Cable Loss dB	Result Level (dB μ V/m)	Limit Line (dB μ V/m)	Over Limit (dB)	Detector	Polarization
1	56.99	14.89	12.41	4.13	31.43	69.42	-37.99	QP	HORIZONTAL
2	115.73	13.65	10.48	4.46	28.59	69.42	-40.83	QP	HORIZONTAL
3	137.90	14.80	8.20	4.45	27.45	69.42	-41.97	QP	HORIZONTAL
4	216.78	13.27	11.01	5.35	29.63	69.42	-39.79	QP	HORIZONTAL
5	265.68	16.29	12.34	5.67	34.30	69.42	-35.12	QP	HORIZONTAL
6	724.26	7.23	19.91	8.00	35.14	69.42	-34.28	QP	HORIZONTAL

Note: 1. Result Level = Read Level + Antenna Factor + Cable loss.

2. If Peak Result complies with QP limit, QP Result is deemed to comply with QP limit.

3. Test setup: RBW: 120 kHz, VBW: 300 kHz, Sweep time: auto.

Radiated Emission test (Above 1GHz)

Item (Mark)	Freq. (MHz)	Read Level (dB μ V)	Antenna Factor (dB/m)	PRM Factor dB	Cable Loss dB	Result Level (dB μ V/m)	Limit Line (dB μ V/m)	Over Limit (dB)	Polarization
1	2479.00	54.96	27.37	53.91	4.42	32.84	69.42	-36.58	HORIZONTAL
2	9160.00	53.66	37.44	53.60	8.09	45.59	69.42	-23.83	HORIZONTAL
3	9874.00	53.30	39.05	53.17	8.28	47.46	69.42	-21.96	HORIZONTAL
4	14770.00	52.82	40.84	53.17	9.75	50.24	69.42	-19.18	HORIZONTAL
5	17235.00	51.33	41.67	52.40	15.46	56.06	69.42	-13.36	HORIZONTAL
6	17524.00	52.24	42.08	52.29	15.41	57.44	69.42	-11.98	HORIZONTAL

Item (Mark)	Freq. (MHz)	Read Level (dB μ V)	Antenna Factor (dB/m)	PRM Factor dB	Cable Loss dB	Result Level (dB μ V/m)	Limit Line (dB μ V/m)	Over Limit (dB)	Polarization
1	9296.00	52.71	37.53	53.52	8.13	44.85	69.42	-24.57	VERTICAL
2	9840.00	58.41	38.96	53.19	8.27	52.45	69.42	-16.97	VERTICAL
3	10129.00	51.19	39.64	53.01	8.26	46.08	69.42	-23.34	VERTICAL
4	14770.00	48.71	40.84	53.17	9.75	46.13	69.42	-23.29	VERTICAL
5	17235.00	47.52	41.67	52.40	15.46	52.25	69.42	-17.17	VERTICAL
6	17524.00	50.41	42.08	52.29	15.41	55.61	69.42	-13.81	VERTICAL

Note: 1. Result Level = Read Level + Antenna Factor + Cable loss - PRM Factor.

2. If Peak Result complies with AV limit, AV Result is deemed to comply with AV limit.

3. Test setup: RBW: 1 MHz, VBW: 3 MHz, Sweep time: auto.

4. According to standard requirements, the radio carrier and harmonic frequencies of the samples are not included in the test results.

4.7. Test photo

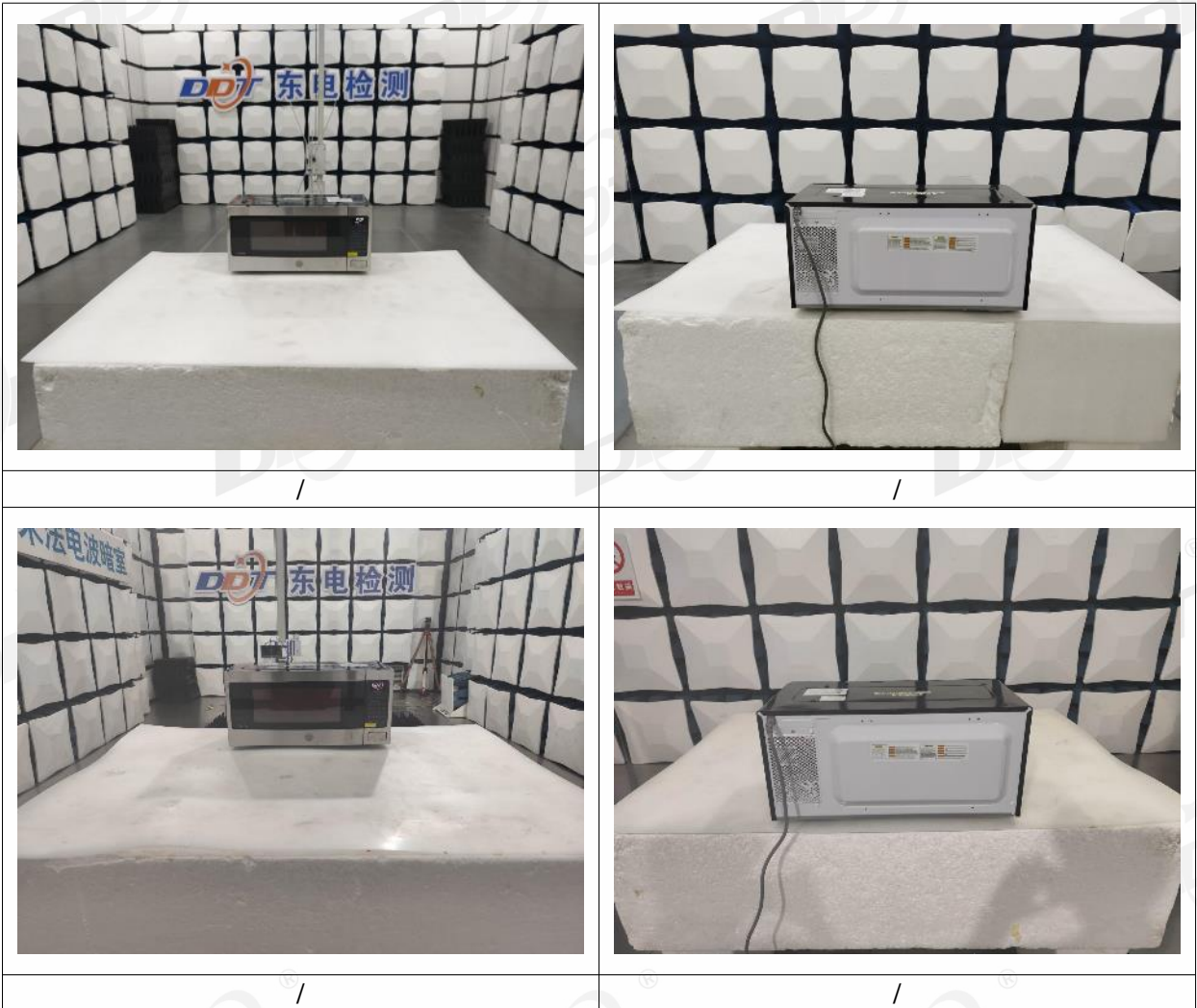

5. Operating frequency Test

5.1. Test equipment

Equipment	Manufacturer	Model No.	Equipment No.	Cal Due To
EMI Test Receiver	R&S	ESCI 3	DDT-ZC01972	2026/03/28
Active Loop Antenna	Schwarzbeck	FMZB1519	DDT-ZC00524	2025/09/11
Trilog Broadband Antenna	Schwarzbeck	VULB 9163	DDT-ZC00246	2026/07/18
RF Cable	H&S	RG214-11	DDT-ZC01497	2026/03/28
EMI Test Software	Audix/TW	e3	DDT-ZC01252	/
Horn Antenna	SCHWARZBECK	BBHA9120 D	DDT-ZC01218	2025/08/27
Preamplifier	COM-POWER	PAM-118A	DDT-ZC01489	2025/08/12
Spectrum Analyzer	Agilent	E4440A	DDT-ZC01445	2026/03/28
RF cable	Zhongke Junchuang	JCTB810-NJ-NJ-7M	DDT-ZC02759	2026/07/22
Spectrum Analyzer	Agilent	E4440A	DDT-ZC01445	2026/03/28
Broad-Band Horn Antenna	Schwarzbeck	BBHA 9170	DDT-ZC00506	2026/04/01
Horn Antenna	SCHWARZBECK	BBHA9120 D	DDT-ZC01218	2025/08/27
Preamplifier	COM-POWER	PAM-118A	DDT-ZC01489	2025/08/12
Pre-amplifier	COM-POWER	PAM-840A	DDT-ZC01693	2026/03/28
RF cable	Zhongke Junchuang	JCTB810-NJ-NJ-7M	DDT-ZC02759	2026/07/22

5.2. Limits

Detector: Peak

Limit: ISM equipment may be operated at any frequency above 9KHz and the frequency band 2400-2500MHz is allocated for use by ISM equipment

ISM frequency	Tolerance
6.78 MHz	±15.0 kHz
13.56 MHz	±7.0 kHz
27.12 MHz	±163.0 kHz
40.68 MHz	±20.0 kHz
915 MHz	±13.0 MHz
2,450 MHz	±50.0 MHz
5,800 MHz	±75.0 MHz
24,125 MHz	±125.0 MHz
61.25 GHz	±250.0 MHz
122.50 GHz	±500.0 MHz
245.00 GHz	±1.0 GHz

5.3. Test procedure

Frequency For Normal Voltage

The operating frequency was measured using a spectrum analyzer: Starting with the EUT at room temperature, a 1000mL water load was placed in the center of the oven and the oven was operated at maximum output power. The fundamental operating frequency was monitored until the water load was reduced to 20 percent of the original load.

Frequency For Line Voltage

The EUT was operated / warmed by at least 10 minutes of use with a 1000mL water load at room temperature at the beginning of the test. Then the operating frequency was monitored as the input voltage was varied between 80 and 125 percent of the nominal rating.

5.4. Test result

Operating Mode	Frequency (MHz)
Normal Voltage	2430-2475
Line Voltage	2430-2475

6. Radiation Hazard Test

6.1. Test equipment

Equipment	Manufacturer	Model No.	Equipment No.	Cal Due To
Microwave Test Instrument	ETS LINDGREN	HI1501	00058640	2026/07/02

6.2. Limits

A maximum of 1.0mW/cm² is allowed in according with the applicable FCC standards.

6.3. Test procedure

The EUT was set-up according to the FCC MP-5 and FCC Part 18 for radiation hazard measurement. The measurement was using a microwave leakage meter to measure the radiation leakage in the as received condition with the oven door closed. A 700 mL water load in a breaker was located in the center of the oven and the microwave oven was set to maximum power. While the oven operating, the microwave meter will check the leakage and then record the maximum leakage.

6.4. Test result

Test location	Test result (mW/cm ²)	Limit (mW/cm ²)	Verdict
Left side	0.16	1.0	Pass
Right side	0.12	1.0	Pass
Front	0.32	1.0	Pass
Rear	0.20	1.0	Pass

There was no microwave leakage exceeding a power level of 0.32 mW/cm² observed at any point 5cm or more from the external surface of the oven.

6.5. Test photo



/

/

7. RF Output Power Measurement

7.1. Test equipment

Equipment	Manufacturer	Model No.	Equipment No.	Cal Due To
Digital Multimeter	FLUKE	287C	DDT-ZC04864	2026/02/23

7.2. Test procedure

Test the EUT in microwave mode with full power. A quantity of 1 000 g/+5 g of water is added to the container and its actual mass obtained. The food support for microwave heating is placed in the center of the support immediately. The oven is operated and the time for the water temperature to attain 20-/+2 C is measured. The oven is then switched off and the final water temperature is measured with in 60s.

7.3. Test result

Mass of Water(g)	Mass of the container(g)	ambient temperature (°C)	Initial temperature (°C)	Final temperature (°C)	Heating Time(S)	Output Power (Watt)
1000	440	20.0	9.9	19.0	54	701.11

Formula:

The microwave power output is calculated from the formula

$$P = \frac{4,187 \cdot m_w (T_1 - T_0) + 0,55 \cdot m_c (T_1 - T_A)}{t}$$

where

P is the microwave power output, (W);

m_w is the mass of the water, (g);

m_c is the mass of the container, (g);

T_A is the ambient temperature, (°C);

T_0 is the initial temperature of the water, (°C);

T_1 is the final temperature of the water, (°C);

t is the heating time, in seconds, excluding the magnetron filament heating-up time. \square

The microwave power output is stated in watts, rounded to the nearest 50 W.

8. Photos of the EUT



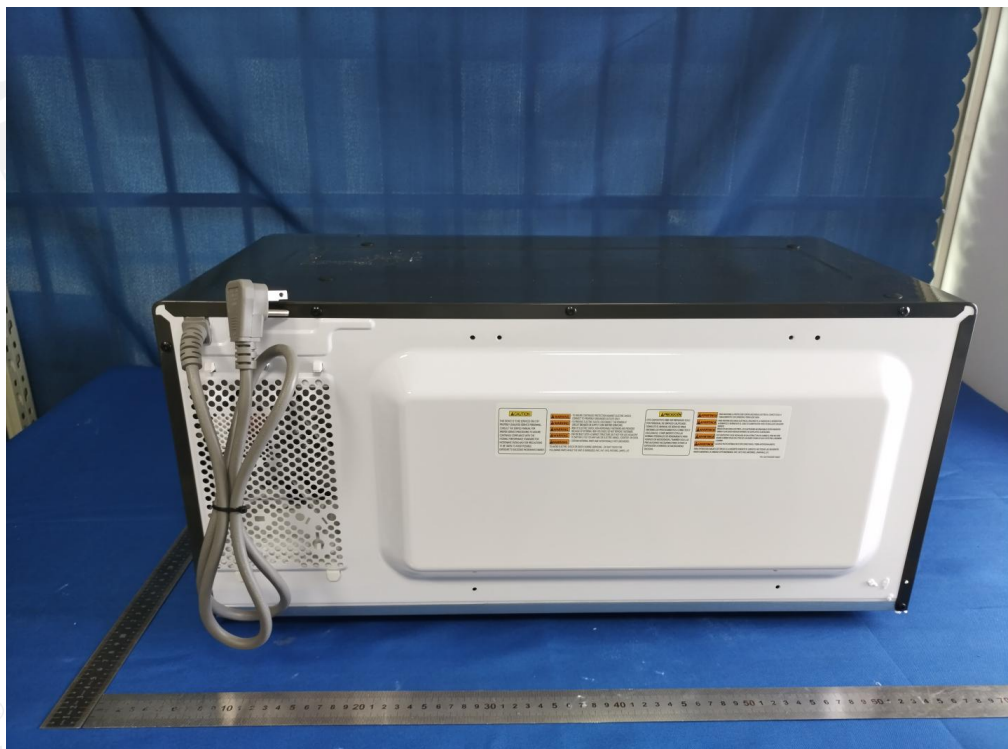
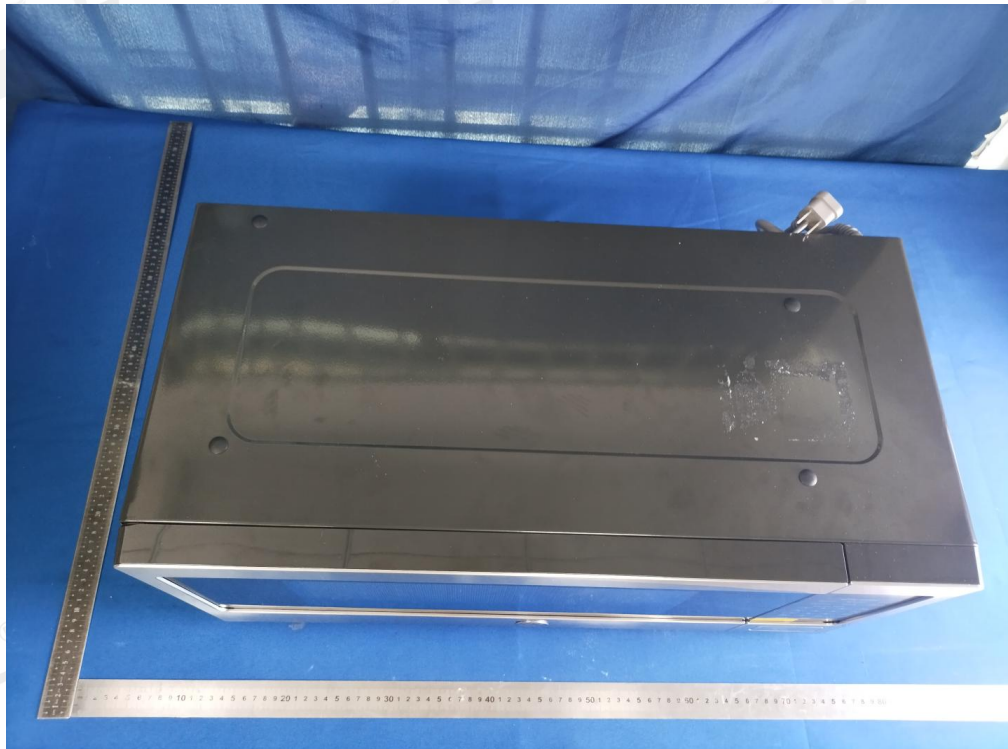

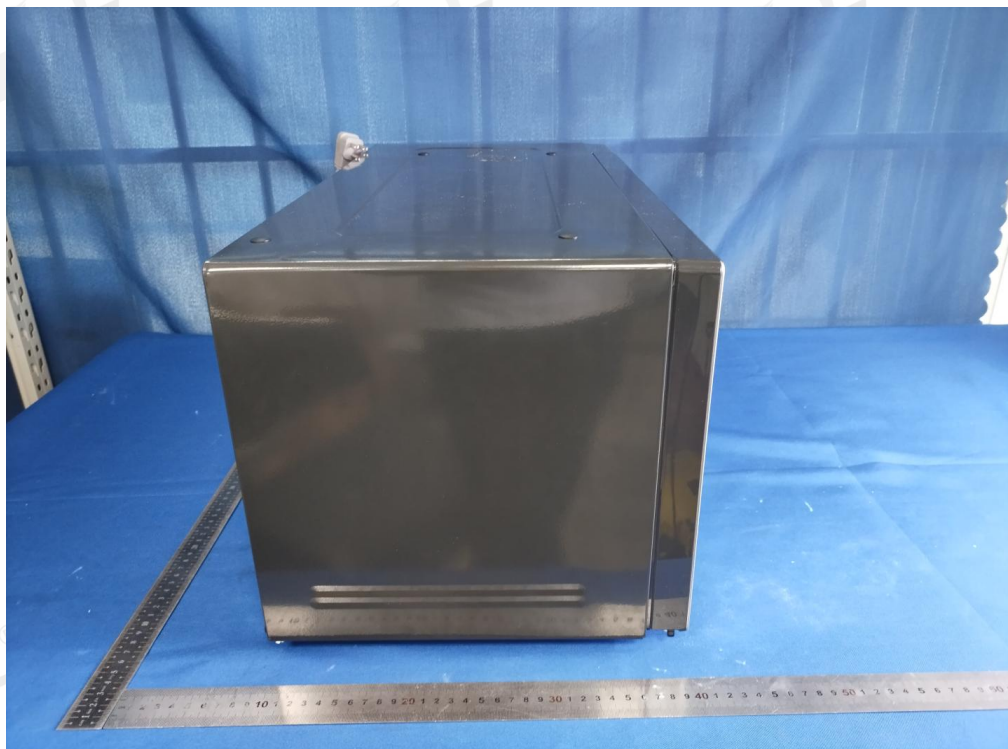

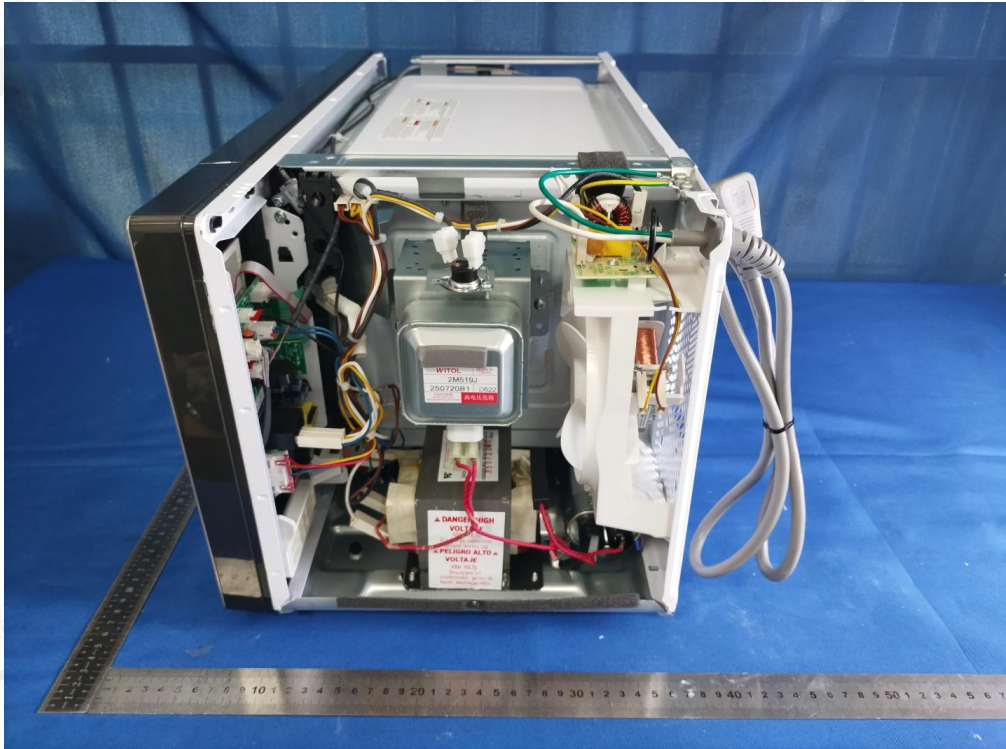

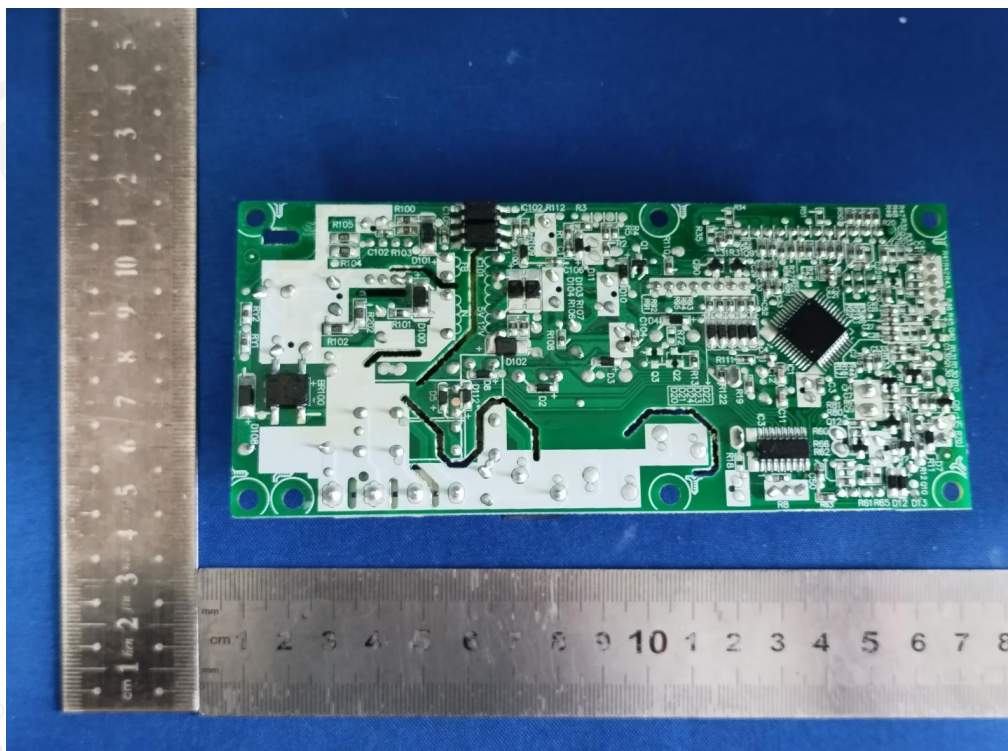
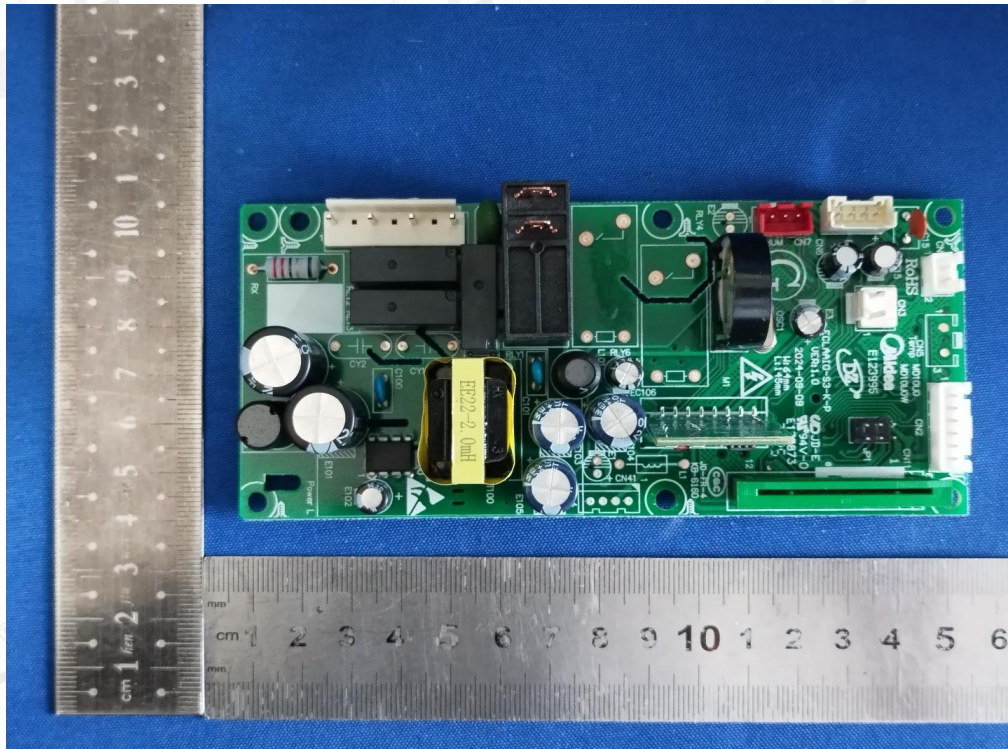

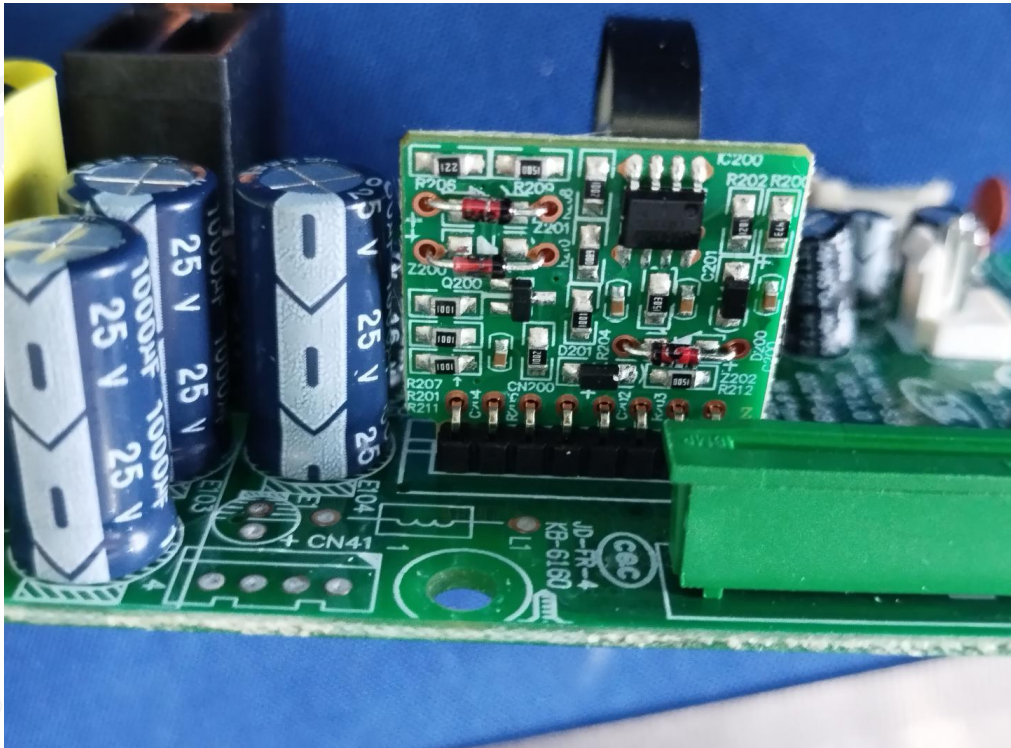
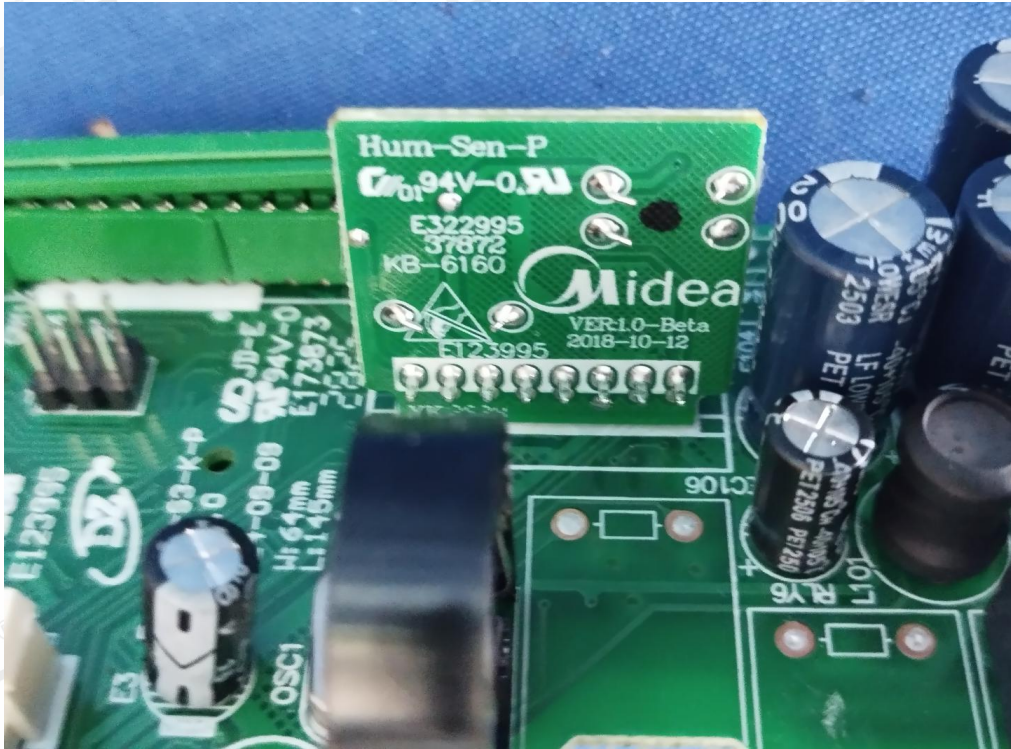

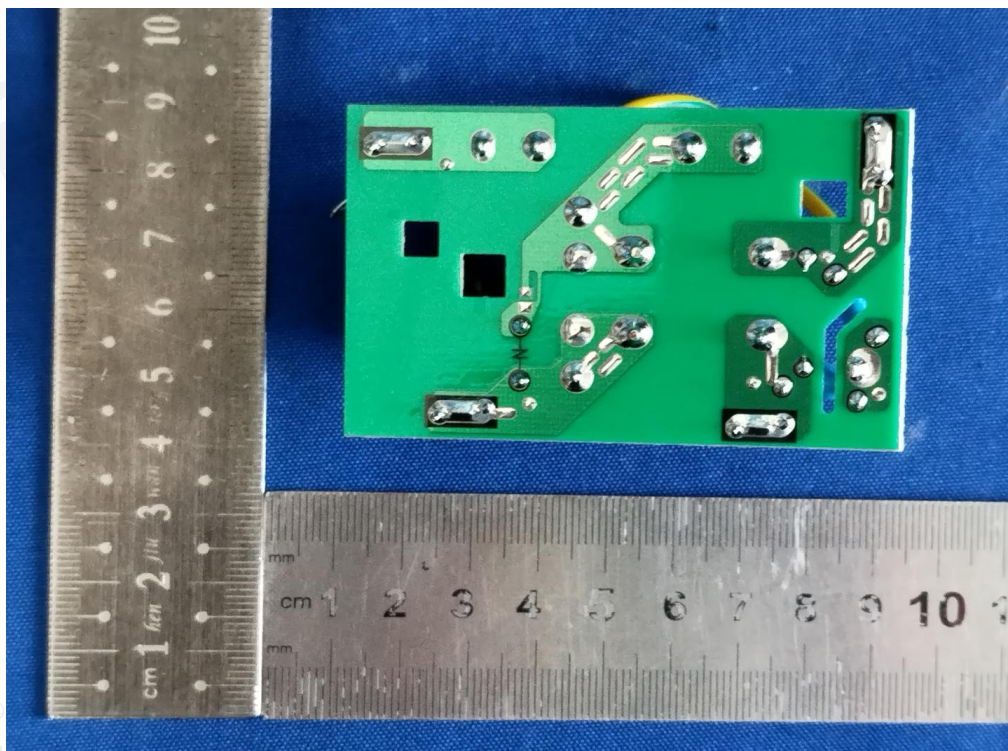
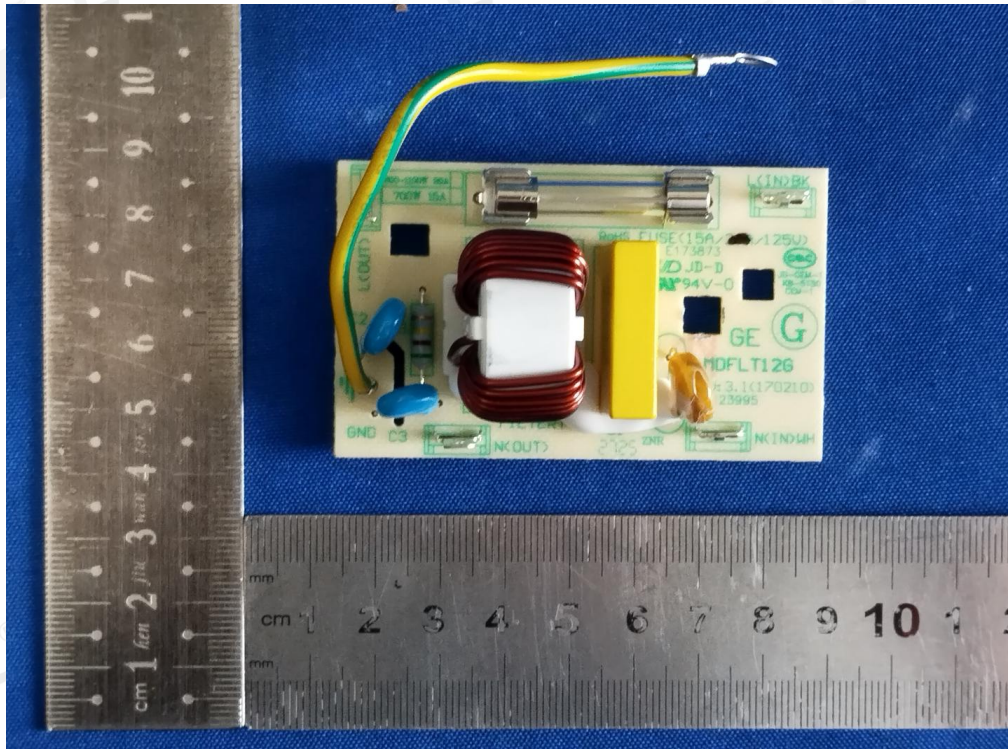

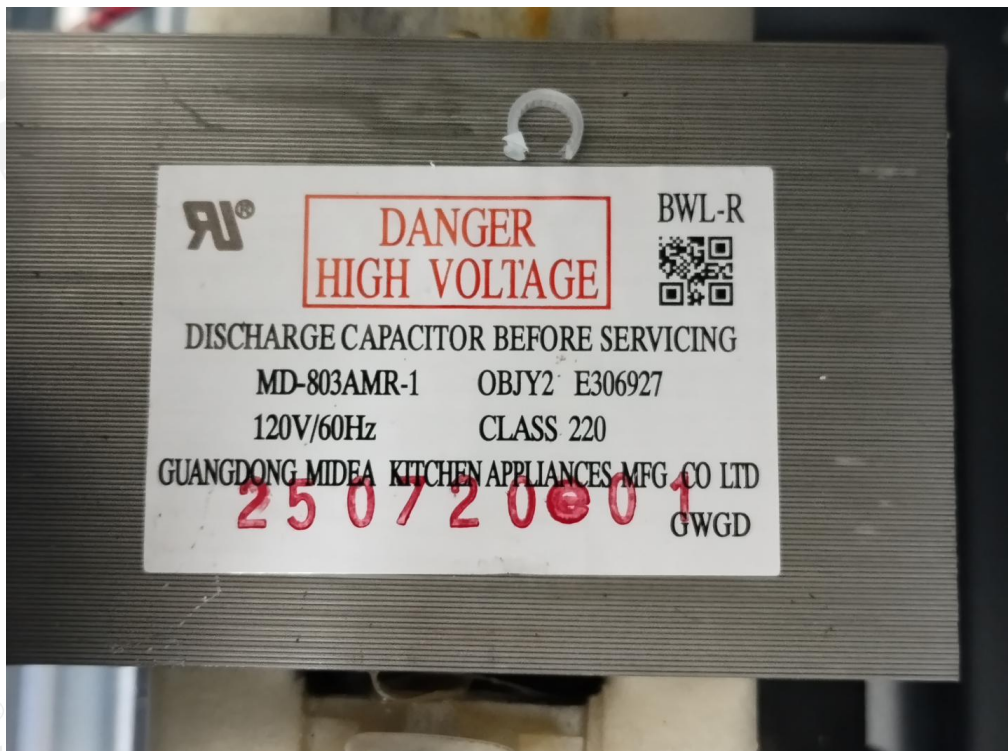
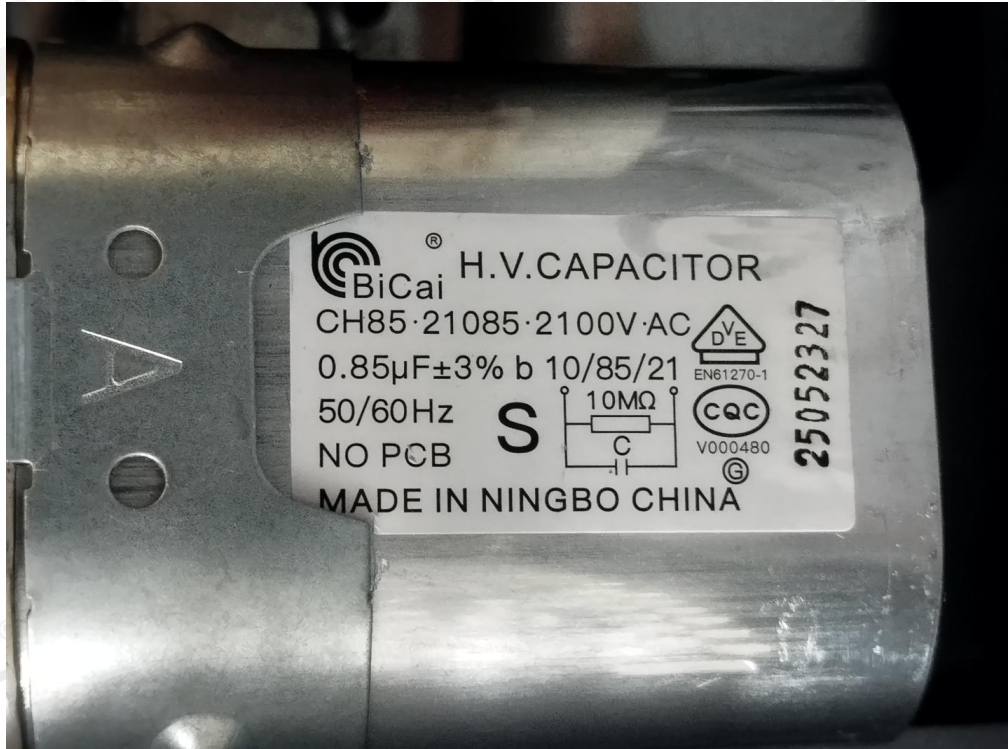

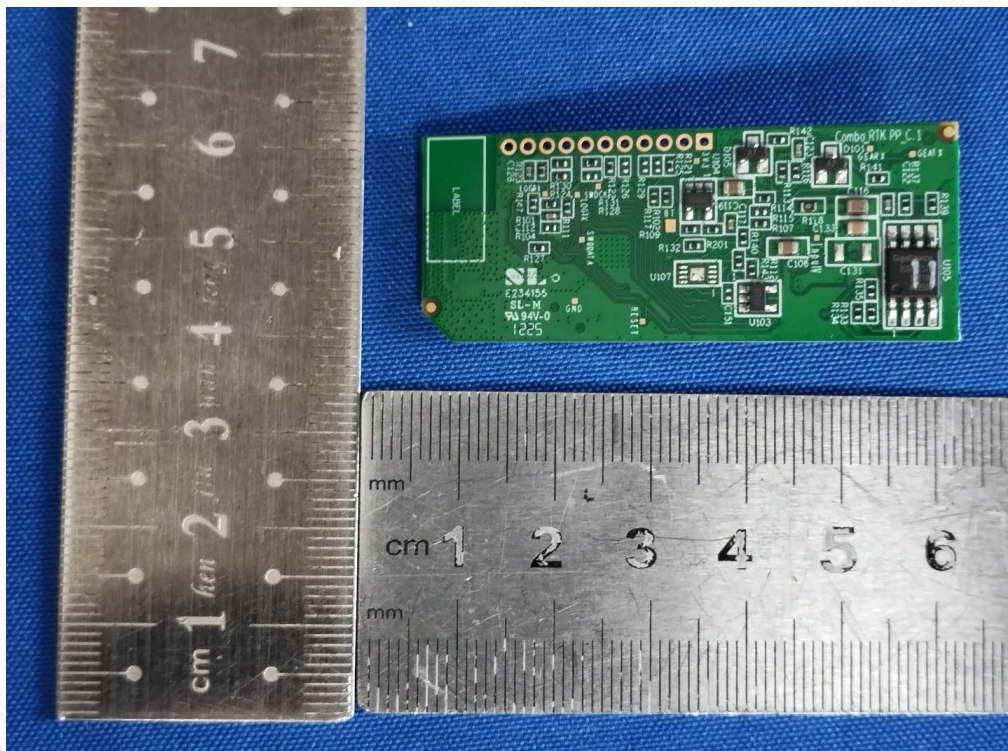
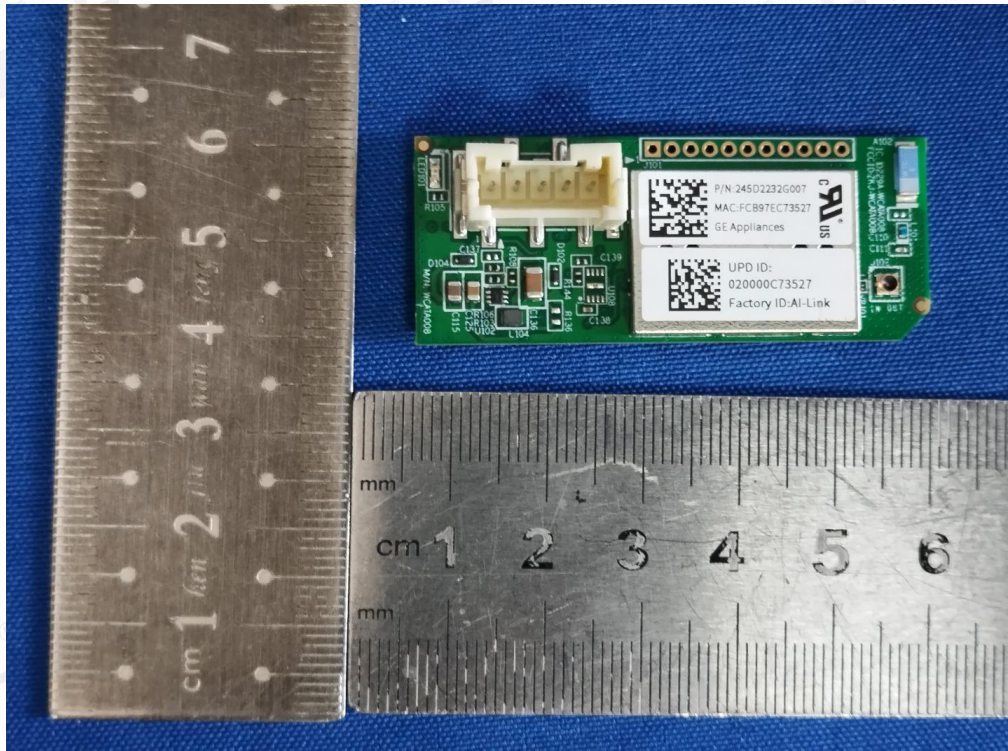

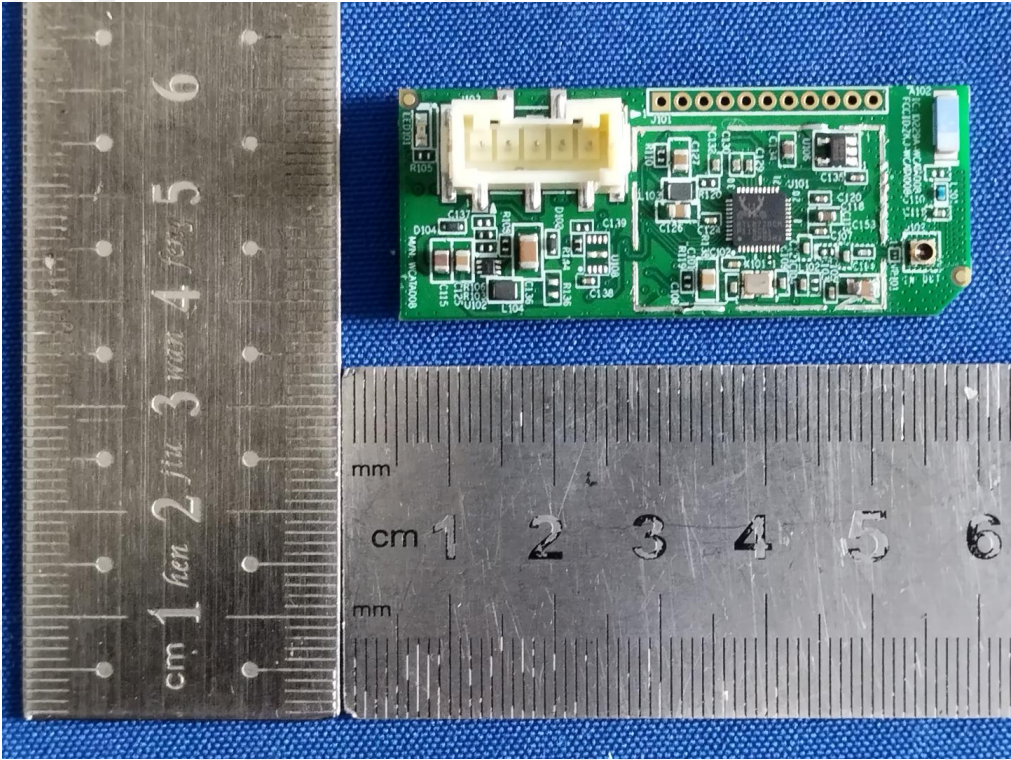

-----End Report-----