

TEST REPORT

Applicant Name: Shenzhen Youmi Intelligent Technology Co., Ltd.
Address: 406-407 Jinqi Zhigu Building, 4/F, 1 Tangling Road, Nanshan District, Shenzhen City, China
Report Number: 2401Y99438E-SAA
FCC ID: 2ATZ4-GA20N2

Test Standard (s)

FCC 47 CFR part 2.1093

Sample Description

Product Type: Smart phone
Model No.: PG4RBG100
Multiple Model(s) No.: PG4RB100A
Trade Mark: UMIDIGI
Serial Number: 2SY2-1
Date Received: 2024/10/15
Date of Test: 2024/11/10~2024/11/16
Issue Date: 2024/12/05

Test Result:

Pass▲

▲ In the configuration tested, the EUT complied with the standards above.

Prepared and Checked By:

Sid Luo

Sid Luo
SAR Engineer

Approved By:

Luke Jiang

Luke Jiang
SAR Engineer

Note: The information marked*is provided by the applicant, the laboratory is not responsible for its authenticity and this information can affect the validity of the result in the test report. Customer model name, addresses, names, trademarks etc. are included.

This report cannot be reproduced except in full, without prior written approval of the Company. Unless otherwise stated the results shown in this test report refer only to the sample(s) tested. This report is valid only with a valid digital signature. The digital signature may be available only under the Adobe software above version 7.0.

This report must not be used by the customer to claim product certification, approval, or endorsement by NVLAP or any agency of the U.S. Government.

This report may contain data that are not covered by the NVLAP accreditation and are marked with an asterisk "▼".

Bay Area Compliance Laboratories Corp. (Shenzhen)

5F(B-West), 6F, 7F, the 3rd Phase of Wan Li Industrial Building D, Shihua Rd, FuTian Free Trade Zone, Shenzhen, China
Tel: +86-755-33320018 Fax: +86-755-33320008 www.baclcorp.com.cn

Attestation of Test Results		
Frequency Band	Max. SAR Level(s) Reported(W/kg)	Limit(W/Kg)
GSM 850	0.08 W/kg 1g Head SAR 0.26 W/kg 1g Body SAR	1.6
PCS 1900	0.91 W/kg 1g Head SAR 0.47 W/kg 1g Body SAR	
WCDMA Band 2	0.96 W/kg 1g Head SAR 0.31 W/kg 1g Body SAR	
WCDMA Band 5	0.22 W/kg 1g Head SAR 0.28 W/kg 1g Body SAR	
LTE Band 2	0.66 W/kg 1g Head SAR 0.33 W/kg 1g Body SAR	
LTE Band 5	0.08 W/kg 1g Head SAR 0.27 W/kg 1g Body SAR	
LTE Band 12	0.07 W/kg 1g Head SAR 0.43 W/kg 1g Body SAR	
LTE Band 13	0.04 W/kg 1g Head SAR 0.19 W/kg 1g Body SAR	
LTE Band 41	0.94 W/kg 1g Head SAR 0.58 W/kg 1g Body SAR	
WLAN 2.4G	0.35 W/kg 1g Head SAR 0.19 W/kg 1g Body SAR	
WLAN 5.2G	0.30 W/kg 1g Head SAR 0.12 W/kg 1g Body SAR	
WLAN 5.8G	0.43 W/kg 1g Head SAR 0.19 W/kg 1g Body SAR	
Simultaneous(tx)	1.39 W/kg 1g Head SAR 0.77 W/kg 1g Body SAR 0.77 W/kg 1g Hotspot SAR	
Applicable Standards	FCC 47 CFR part 2.1093 Radiofrequency radiation exposure evaluation: portable devices	
	RF Exposure Procedures: TCB Workshop April 2019	
	IEEE1528:2013 IEEE Recommended Practice for Determining the Peak Spatial-Average Specific Absorption Rate (SAR) in the Human Head from Wireless Communications Devices: Measurement Techniques	
	KDB procedures KDB 447498 D01 General RF Exposure Guidance v06 KDB 648474 D04 Handset SAR v01r03 KDB 865664 D01 SAR Measurement 100 MHz to 6 GHz v01r04 KDB 865664 D02 RF Exposure Reporting v01r02 KDB 941225 D01 3G SAR Procedures v03 KDB 941225 D05 SAR for LTE Devices v02r05 KDB 941225 D06 Hotspot Mode v02r01 KDB 248227 D01 802.11 Wi-Fi SAR v02r02	
<p>Note: This wireless device has been shown to be capable of compliance for localized specific absorption rate (SAR) for General Population/Uncontrolled Exposure limits specified in FCC 47 CFR part 2.1093 and has been tested in accordance with the measurement procedures specified in IEEE 1528-2013 and RF exposure KDB procedures.</p> <p>The results and statements contained in this report pertain only to the device(s) evaluated.</p>		

TABLE OF CONTENTS

DOCUMENT REVISION HISTORY	4
EUT DESCRIPTION	5
TECHNICAL SPECIFICATION.....	5
REFERENCE, STANDARDS, AND GUIDELINES	6
SAR LIMITS	6
FACILITIES	7
DESCRIPTION OF TEST SYSTEM	8
EQUIPMENT LIST AND CALIBRATION	15
EQUIPMENT’S LIST & CALIBRATION INFORMATION	15
SAR MEASUREMENT SYSTEM VERIFICATION	16
LIQUID VERIFICATION.....	16
SYSTEM ACCURACY VERIFICATION	19
SAR SYSTEM VALIDATION DATA	20
EUT TEST STRATEGY AND METHODOLOGY	29
TEST POSITIONS FOR DEVICE OPERATING NEXT TO A PERSON’S EAR	29
CHEEK/TOUCH POSITION	30
EAR/TILT POSITION.....	30
TEST POSITIONS FOR BODY-WORN AND OTHER CONFIGURATIONS	31
TEST DISTANCE FOR SAR EVALUATION	31
SAR EVALUATION PROCEDURE	32
CONDUCTED OUTPUT POWER MEASUREMENT	33
TEST PROCEDURE.....	33
DESCRIPTION OF TEST CONFIGURATION	34
MAXIMUM TARGET OUTPUT POWER.....	39
TEST RESULTS.....	41
STANDALONE SAR TEST EXCLUSION CONSIDERATIONS	55
ANTENNAS LOCATION:	55
ANTENNA DISTANCE TO EDGE (TRX)	56
SAR TEST EXCLUSION FOR THE EUT EDGE CONSIDERATIONS RESULT.....	56
STANDALONE SAR TEST EXCLUSION CONSIDERATIONS	56
STANDALONE SAR ESTIMATION:	57
SAR MEASUREMENT RESULTS	58
TEST RESULTS:.....	58
SAR MEASUREMENT VARIABILITY	72
SAR SIMULTANEOUS TRANSMISSION DESCRIPTION	73
SAR PLOTS	74
APPENDIX A MEASUREMENT UNCERTAINTY	75
APPENDIX B EUT TEST POSITION PHOTOS	76
APPENDIX C CALIBRATION CERTIFICATES	77
APPENDIX D RETURN LOSS&IMPEDANCE MEASUREMENT	78

DOCUMENT REVISION HISTORY

Revision Number	Report Number	Description of Revision	Date of Revision
0	2401Y99438-SAA	Original Report	2024/12/05

EUT DESCRIPTION

This report has been prepared on behalf of **Shenzhen Youmi Intelligent Technology Co., Ltd.** and their product **Smart phone**, Model: **PG4RBG100, PG4RB100A**, Test Model: **PG4RBG100**, FCC ID: **2ATZ4-GA20N2** or the EUT (Equipment under Test) as referred to in the rest of this report.

**All measurement and test data in this report was gathered from production sample serial number: 2SY2-1 (Assigned by BACL, Shenzhen). The EUT supplied by the applicant was received on 2024-10-15.*

Technical Specification

Product Type:	Portable
Exposure Category:	Population / Uncontrolled
Antenna Type(s):	Internal Antenna
Proximity Sensor:	None
Operation modes:	GSM Voice, GPRS/EDGE Data, WCDMA (R99, HSUPA/ HSDPA/ HSPA+), FDD-LTE, TDD-LTE, WLAN, Bluetooth, NFC
Frequency Band:	GSM 850: 824-849 MHz(TX); 869-894 MHz(RX) PCS 1900: 1850-1910 MHz(TX); 1930-1990 MHz(RX) WCDMA Band 2: 1850-1910 MHz(TX); 1930-1990 MHz(RX) WCDMA Band 5: 824-849 MHz(TX); 869-894 MHz(RX) LTE Band 2: 1850-1910 MHz(TX); 1930-1990 MHz(RX) LTE Band 5: 824-849 MHz(TX); 869-894 MHz(RX) LTE Band 12: 699-716 MHz(TX); 729-746 MHz(RX) LTE Band 13: 777-787 MHz(TX); 746-756 MHz(RX) LTE Band 41: 2496-2690 MHz(TX/RX) WLAN 2.4G: 2412-2462 MHz (TX/RX) WLAN 5.2G: 5150 -5250 MHz(TX/RX) WLAN 5.8G: 5725-5850 MHz(TX/RX) Bluetooth: 2402-2480MHz(TX/RX) BLE_1M:2402-2480 MHz(TX/RX) BLE_2M:2402-2480 MHz(TX/RX) NFC: 13.56MHz
Dimensions (L×W×H):	170 × 76 × 8 mm
Rated Input Voltage:	DC 3.89V from battery
Normal Operation:	Head and Body
Note: The Multiple models are electrically identical with the test model except for model name and sales channels. Please refer to the declaration letter [#] for more detail, which was provided by manufacturer.	

REFERENCE, STANDARDS, AND GUIDELINES

FCC:

The Report and Order requires routine SAR evaluation prior to equipment authorization of portable transmitter devices, including portable telephones. For consumer products, the applicable limit is 1.6 mW/g as recommended by the ANSI/IEEE standard C95.1-1992 [6] for an uncontrolled environment (Paragraph 65). According to the Supplement C of OET Bulletin 65 "Evaluating Compliance with FCC Guide-lines for Human Exposure to Radio frequency Electromagnetic Fields", released on Jun 29, 2001 by the FCC, the device should be evaluated at maximum output power (radiated from the antenna) under "worst-case" conditions for normal or intended use, incorporating normal antenna operating positions, device peak performance frequencies and positions for maximum RF energy coupling.

This report describes the methodology and results of experiments performed on wireless data terminal. The objective was to determine if there is RF radiation and if radiation is found, what is the extent of radiation with respect to safety limits. SAR (Specific Absorption Rate) is the measure of RF exposure determined by the amount of RF energy absorbed by human body (or its parts) – to determine how the RF energy couples to the body or head which is a primary health concern for body worn devices. The limit below which the exposure to RF is considered safe by regulatory bodies in North America is 1.6 mW/g average over 1 gram of tissue mass.

SAR Limits

FCC Limit (1g Tissue)

EXPOSURE LIMITS	SAR (W/kg)	
	(General Population / Uncontrolled Exposure Environment)	(Occupational / Controlled Exposure Environment)
Spatial Average (averaged over the whole body)	0.08	0.4
Spatial Peak (averaged over any 1 g of tissue)	1.6	8.0
Spatial Peak (hands/wrists/feet/ankles averaged over 10 g)	4.0	20.0

Population/Uncontrolled Environments are defined as locations where there is the exposure of individual who have no knowledge or control of their exposure.

Occupational/Controlled Environments are defined as locations where there is exposure that maybe incurred by people who are aware of the potential for exposure (i.e. as a result of employment or occupation).

General Population/Uncontrolled environments Spatial Peak limit 1.6W/kg for 1g SAR applied to the EUT.

FACILITIES

The test site used by Bay Area Compliance Laboratories Corp. (Shenzhen) to collect data is located at 5F(B-West) ,6F,7F,the 3rd Phase of Wan Li Industrial Building D,Shihua Rd, FuTian Free Trade Zone, Shenzhen, China

The lab has been recognized as the FCC accredited lab under the KDB 974614 D01 and is listed in the FCC Public Access Link (PAL) database, FCC Registration No.: 715558, the FCC Designation No.: CN5045.

Each test item follows test standards and with no deviation.

DESCRIPTION OF TEST SYSTEM

These measurements were performed with the automated near-field scanning system DASY6 from Schmid & Partner Engineering AG (SPEAG) which is the Fifth generation of the system shown in the figure hereinafter:

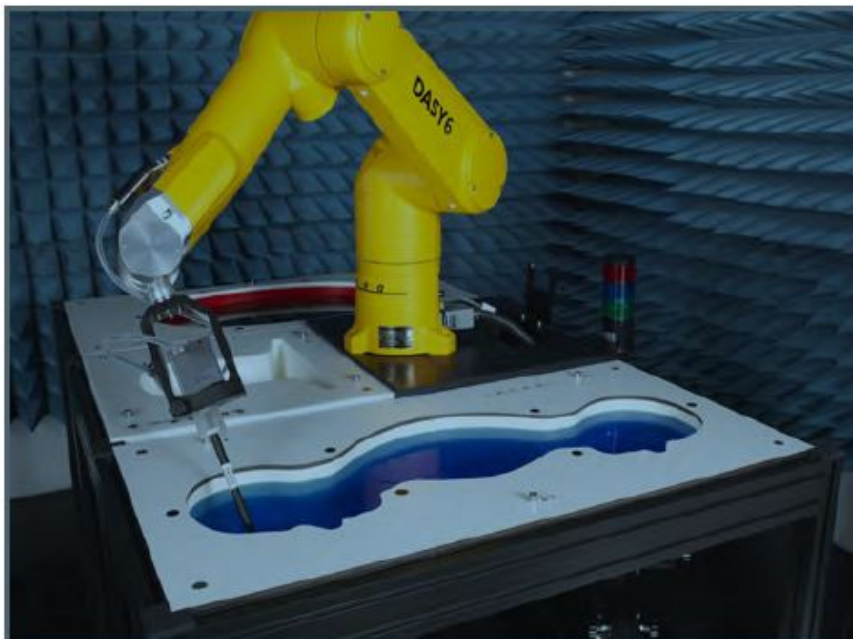

DASY6 System Description

The DASY6 system for performing compliance tests consists of the following items:

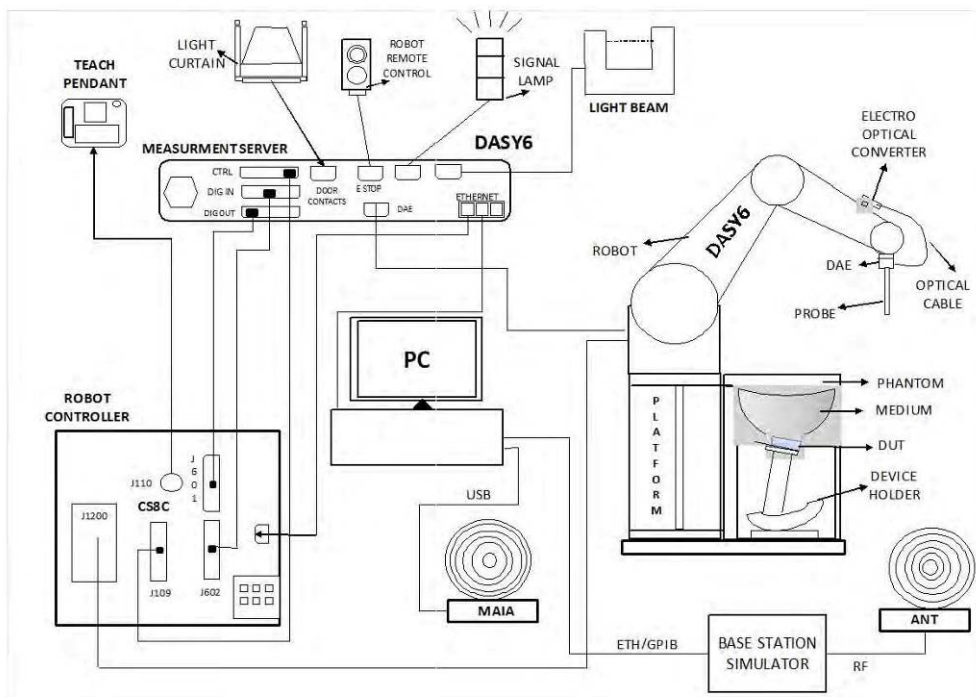

- A standard high precision 6-axis robot (Staubli TX=RX family) with controller, teach pendant and software. An arm extension for accommodating the data acquisition electronics (DAE).
- An isotropic field probe optimized and calibrated for the targeted measurement.
- A data acquisition electronics (DAE) which performs the signal application, signal multiplexing, AD-conversion, offset measurements, mechanical surface detection, collision detection, etc. The unit is battery powered with standard or rechargeable batteries. The signal is optically transmitted to the EOC.
- The Electro-optical converter (EOC) performs the conversion from optical to electrical signals for the digital communication to the DAE. To use optical surface detection, a special version of the EOC is required. The EOC signal is transmitted to the measurement server.
- The function of the measurement server is to perform the time critical tasks such as signal filtering, control of the robot operation and fast movement interrupts.
- The Light Beam used is for probe alignment. This improves the (absolute) accuracy of the probe positioning.
- A computer running Win7 professional operating system and the DASY52 software.
- Remote control and teach pendant as well as additional circuitry for robot safety such as warning lamps, etc.
- The phantom, the device holder and other accessories according to the targeted measurement.

DASY6 Measurement Server

The DASY6 measurement server is based on a PC/104 CPU board with a 400 MHz Intel ULV Celeron, 128 MB chip-disk and 128 MB RAM. The necessary circuits for communication with the DAE4 (or DAE3) electronics box, as well as the 16-bit AD converter system for optical detection and digital I/O interface are contained on the DASY6 I/O board, which is directly connected to the PC/104 bus of the CPU board.



The measurement server performs all real-time data evaluations of field measurements and surface detection, controls robot movements, and handles safety operations. The PC operating system cannot interfere with these time-critical processes. All connections are supervised by a watchdog, and disconnection of any of the cables to the measurement server will automatically disarm the robot and disable all program-controlled robot movements. Furthermore, the measurement server is equipped with an expansion port, which is reserved for future applications. Please note that this expansion port does not have a standardized pinout, and therefore only devices provided by SPEAG can be connected. Connection of devices from any other supplier could seriously damage the measurement server.

Data Acquisition Electronics

The data acquisition electronics (DAE4) consist of a highly sensitive electrometer-grade preamplifier with auto-zeroing, a channel and gain-switching multiplexer, a fast 16 bit AD-converter and a command decoder with a control logic unit. Transmission to the measurement server is accomplished through an optical downlink for data and status information, as well as an optical uplink for commands and the clock.

The mechanical probe mounting device includes two different sensor systems for frontal and sideways probe contacts. They are used for mechanical surface detection and probe collision detection.

The input impedance of both the DAE4 as well as of the DAE3 box is 200M Ω ; the inputs are symmetrical and floating. Common mode rejection is above 80 dB.

EX3DV4 E-Field Probes

Frequency	4 MHz to >10 GHz Linearity: ± 0.2 dB (30 MHz to 10 GHz)
Directivity	± 0.1 dB in TSL (rotation around probe axis) ± 0.3 dB in TSL (rotation normal to probe axis)
Dynamic Range	10 µW/g to > 100 mW/g Linearity: ± 0.2 dB (noise: typically < 1 µW/g)
Dimensions	Overall length: 337 mm (Tip: 20 mm) Tip diameter: 2.5 mm (Body: 12 mm) Typical distance from probe tip to dipole centers: 1 mm
Application	High precision dosimetric measurements in any exposure scenario (e.g., very strong gradient fields); the only probe that enables compliance testing for frequencies up to 6 GHz with precision of better 30%.
Compatibility	DASY3, DASY4, DASY52 SAR and higher, EASY6, EASY4/MRI

SAM Twin Phantom

The SAM Twin Phantom (shown in front of DASY6) is a fiberglass shell phantom with shell thickness 2 mm, except in the ear region where the thickness is increased to 6 mm. The phantom has three measurement areas: 1) Left Head, 2) Right Head, and 3) Flat Section. For larger devices, the use of the ELI-Phantom (shown behind DASY6) is required. For devices such as glasses with a wireless link, the Face Down Phantom is the most suitable (between the SAM Twin and ELI phantoms).

When the phantom is mounted inside allocated slot of the DASY6 platform, phantom reference points can be taught directly in the DASY5 V5.2 software. When the DASY6 platform is used to mount the

Phantom, some of the phantom teaching points cannot be reached by the robot in DASY5 V5.2. A special tool called P1a-P2aX-Former is provided to transform two of the three points, P1 and P2, to reachable locations. To use these new teaching points, a revised phantom configuration file is required.

In addition to our standard broadband liquids, the phantom can be used with the following tissue simulating liquids:

Sugar-water-based liquids can be left permanently in the phantom. Always cover the liquid when the system is not in use to prevent changes in liquid parameters due to water evaporation.

DGBE-based liquids should be used with care. As DGBE is a softener for most plastics, the liquid should be taken out of the phantom, and the phantom should be dried when the system is not in use (desirable at least once a week).

Do not use other organic solvents without previously testing the solvent resistivity of the phantom. Approximately 25 liters of liquid is required to fill the SAM Twin phantom.

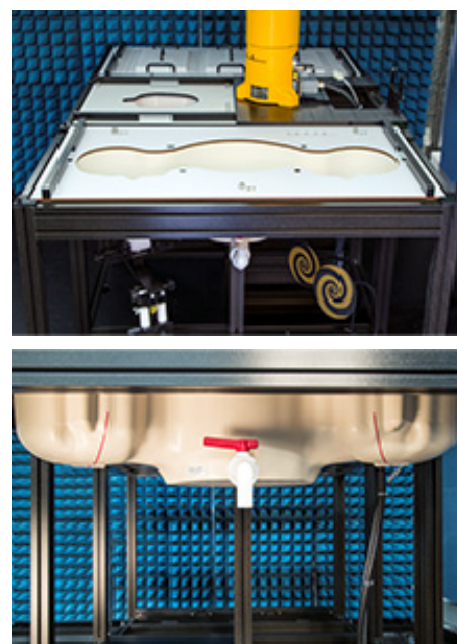

ELI Phantom

The ELI phantom is intended for compliance testing of handheld and body-mounted wireless devices in the frequency range of 30MHz to 6 GHz. ELI is fully compatible with the latest draft of the standard IEEE 1528 and the use of all known tissue simulating liquids. ELI has been optimized for performance and can be integrated into a SPEAG standard phantom table. A cover is provided to prevent evaporation of water and changes in liquid parameters. Reference markings on the phantom allow installation of the complete setup, including all predefined phantom positions and measurement grids, by teaching three points.

The phantom can be used with the following tissue simulating liquids:

- Sugar-water-based liquids can be left permanently in the phantom. Always cover the liquid when the system is not in use to prevent changes in liquid parameters due to water evaporation.
- DGBE-based liquids should be used with care. As DGBE is a softener for most plastics, the liquid should be taken out of the phantom, and the phantom should be dried when the system is not in use (desirable at least once a week).
- Do not use other organic solvents without previously testing the solvent resistivity of the phantom.

Approximately 25 liters of liquid is required to fill the ELI phantom.

Robots

The DASY6 system uses the high-precision industrial robots TX60L, TX90XL, and RX160L from Staubli SA (France). The TX robot family - the successor of the well-known RX robot family - continues to offer the features important for DASY6 applications:

- High precision (repeatability 0.02mm)
- High reliability (industrial design)
- Low maintenance costs (virtually maintenance free due to direct drive gears; no belt drives)
- Jerk-free straight movements (brushless synchrony motors; no stepper motors)
- Low ELF interference (motor control fields shielded via the closed metallic construction shields)

The robots are controlled by the Staubli CS8c robot controllers. All information regarding the use and maintenance of the robot arm and the robot controller is provided

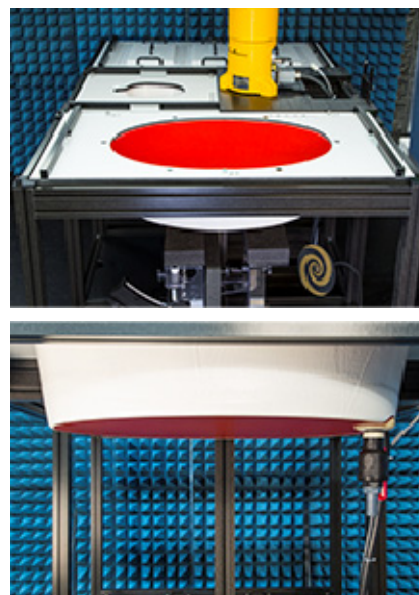

Calibration Frequency Points for EX3DV4 E-Field Probes SN: 7783 Calibrated: 2024/04/12

Calibration Frequency Point (MHz)	Frequency Range (MHz)		Conversion Factor		
	From	To	X	Y	Z
750 Head	650	800	9.40	9.40	9.40
835 Head	800	875	9.10	9.10	9.10
900 Head	875	1000	9.05	9.05	9.05
1750 Head	1650	1850	7.73	7.73	7.73
1900 Head	1850	2000	7.38	7.38	7.38
2300 Head	2200	2400	7.18	7.18	7.18
2450 Head	2400	2550	6.85	6.85	6.85
2600 Head	2550	2700	6.65	6.65	6.65
5250 Head	5140	5360	5.00	5.00	5.00
5600 Head	5490	5700	4.35	4.35	4.35
5750 Head	5700	5860	4.55	4.55	4.55

SAR Scan Procedures

Step 1: Power Reference Measurement

The Power Reference Measurement and Power Drift Measurements are for monitoring the power drift of the device under test in the batch process. The minimum distance of probe sensors to surface determines the closest measurement point to phantom surface. The minimum distance of probe sensors to surface is 1.4 mm. This distance cannot be smaller than the distance of sensor calibration points to probe tip as defined in the probe properties.

Step 2: Area Scans

Area scans are defined prior to the measurement process being executed with a user defined variable spacing between each measurement point (integral) allowing low uncertainty measurements to be conducted. Scans defined for FCC applications utilize a 15mm² step integral, with 1.5mm interpolation used to locate the peak SAR area used for zoom scan assessments.

Where the system identifies multiple SAR peaks (which are within 25% of peak value) the system will provide the user with the option of assessing each peak location individually for zoom scan averaging.

Area Scan Parameters extracted from KDB 865664 D01 SAR Measurement 100 MHz to 6 GHz

	≤ 3 GHz	> 3 GHz
Maximum distance from closest measurement point (geometric center of probe sensors) to phantom surface	5 mm ± 1 mm	$\frac{1}{2} \cdot \delta \cdot \ln(2)$ mm ± 0.5 mm
Maximum probe angle from probe axis to phantom surface normal at the measurement location	30° ± 1°	20° ± 1°
Maximum area scan spatial resolution: Δx_{Area} , Δy_{Area}	≤ 2 GHz: ≤ 15 mm 2 – 3 GHz: ≤ 12 mm	3 – 4 GHz: ≤ 12 mm 4 – 6 GHz: ≤ 10 mm
	When the x or y dimension of the test device, in the measurement plane orientation, is smaller than the above, the measurement resolution must be ≤ the corresponding x or y dimension of the test device with at least one measurement point on the test device.	

Step 3: Zoom Scan (Cube Scan Averaging)

The averaging zoom scan volume utilized in the DASY5 software is in the shape of a cube and the side dimension of a 1 g or 10 g mass is dependent on the density of the liquid representing the simulated tissue. A density of 1000 kg/m³ is used to represent the head and body tissue density and not the phantom liquid density, in order to be consistent with the definition of the liquid dielectric properties, i.e. the side length of the 1g cube is 5mm, with the side length of the 10g cube is 21.5mm.

Zoom Scan Parameters extracted from KDB 865664 D01 SAR Measurement 100 MHz to 6 GHz

Maximum zoom scan spatial resolution: $\Delta x_{Zoom}, \Delta y_{Zoom}$		≤ 2 GHz: ≤ 8 mm 2 – 3 GHz: ≤ 5 mm*	3 – 4 GHz: ≤ 5 mm* 4 – 6 GHz: ≤ 4 mm*
Maximum zoom scan spatial resolution, normal to phantom surface	uniform grid: $\Delta z_{Zoom}(n)$	≤ 5 mm	3 – 4 GHz: ≤ 4 mm 4 – 5 GHz: ≤ 3 mm 5 – 6 GHz: ≤ 2 mm
	graded grid	$\Delta z_{Zoom}(1)$: between 1 st two points closest to phantom surface	≤ 4 mm
		$\Delta z_{Zoom}(n>1)$: between subsequent points	$\leq 1.5 \cdot \Delta z_{Zoom}(n-1)$ mm
Minimum zoom scan volume	x, y, z	≥ 30 mm	3 – 4 GHz: ≥ 28 mm 4 – 5 GHz: ≥ 25 mm 5 – 6 GHz: ≥ 22 mm
<p>Note: δ is the penetration depth of a plane-wave at normal incidence to the tissue medium; see IEEE Std 1528-2013 for details.</p> <p>* When zoom scan is required and the <i>reported</i> SAR from the <i>area scan based 1-g SAR estimation</i> procedures of KDB Publication 447498 is ≤ 1.4 W/kg, ≤ 8 mm, ≤ 7 mm and ≤ 5 mm zoom scan resolution may be applied, respectively, for 2 GHz to 3 GHz, 3 GHz to 4 GHz and 4 GHz to 6 GHz.</p>			

Step 4: Power Drift Measurement

The Power Drift Measurement measures the field at the same location as the most recent power reference measurement within the same procedure, and with the same settings. The Power Drift Measurement gives the field difference in dB from the reading conducted within the last Power Reference Measurement. This allows a user to monitor the power drift of the device under test within a batch process. The measurement procedure is the same as Step 1.

When the cube intersects with the surface of the phantom, it is oriented so that 3 vertices touch the surface of the shell or the center of a face is tangent to the surface. The face of the cube closest to the surface is modified in order to conform to the tangent surface.

The zoom scan integer steps can be user defined so as to reduce uncertainty, but normal practice for typical test applications (including FCC) utilize a physical step of 7 x7 x 7 (5mmx5mmx5mm) providing a volume of 30 mm in the X & Y & Z axis.

Tissue Dielectric Parameters for Head and Body Phantoms

The head tissue dielectric parameters recommended by the IEEE 1528:2013

Recommended Tissue Dielectric Parameters for Head liquid

Table A.3 – Dielectric properties of the head tissue-equivalent liquid

Frequency MHz	Relative permittivity ϵ_r	Conductivity (σ) S/m
300	45,3	0,87
450	43,5	0,87
<i>750</i>	<i>41,9</i>	<i>0,89</i>
835	41,5	0,90
900	41,5	0,97
1 450	40,5	1,20
<i>1 500</i>	<i>40,4</i>	<i>1,23</i>
<i>1 640</i>	<i>40,2</i>	<i>1,31</i>
<i>1 750</i>	<i>40,1</i>	<i>1,37</i>
1 800	40,0	1,40
1 900	40,0	1,40
2 000	40,0	1,40
<i>2 100</i>	<i>39,8</i>	<i>1,49</i>
<i>2 300</i>	<i>39,5</i>	<i>1,67</i>
2 450	39,2	1,80
<i>2 600</i>	<i>39,0</i>	<i>1,96</i>
3 000	38,5	2,40
<i>3 500</i>	<i>37,9</i>	<i>2,91</i>
<i>4 000</i>	<i>37,4</i>	<i>3,43</i>
<i>4 500</i>	<i>36,8</i>	<i>3,94</i>
<i>5 000</i>	<i>36,2</i>	<i>4,45</i>
<i>5 200</i>	<i>36,0</i>	<i>4,66</i>
<i>5 400</i>	<i>35,8</i>	<i>4,86</i>
<i>5 600</i>	<i>35,5</i>	<i>5,07</i>
<i>5 800</i>	<i>35,3</i>	<i>5,27</i>
<i>6 000</i>	<i>35,1</i>	<i>5,48</i>

NOTE For convenience, permittivity and conductivity values at those frequencies which are not part of the original data provided by Drossos et al. [33] or the extension to 5 800 MHz are provided (i.e. the values shown *in italics*). These values were linearly interpolated between the values in this table that are immediately above and below these values, except the values at 6 000 MHz that were linearly extrapolated from the values at 3 000 MHz and 5 800 MHz.

EQUIPMENT LIST AND CALIBRATION

Equipment's List & Calibration Information

Equipment	Model	S/N	Calibration Date	Calibration Due Date
DASY5 Test Software	DASY52 52.10.2	N/A	NCR	NCR
DASY6 Measurement Server	DASY6 6.0.31	N/A	NCR	NCR
Data Acquisition Electronics	DAE4	1724	2024/03/28	2025/03/27
Dosimetric E-field Probes	EX3DV4	7783	2024/04/12	2025/04/11
Mounting Device	MD4HHTV5	SD 000 H01 KA	NCR	NCR
SAM Twin Phantom	SAM-Twin V8.0	1962	NCR	NCR
Dipole, 750MHz	D750V3	1229	2023/03/24	2026/03/23
Dipole, 835MHz	D835V2	453	2024/08/20	2027/08/19
Dipole, 1900MHz	D1900V2	5d231	2023/02/17	2026/02/16
Dipole, 2450MHz	D2450V2	1103	2023/03/27	2026/03/26
Dipole, 2600MHz	D2600V2	1207	2023/03/27	2026/03/26
Dipole,5GHz	D5GHzV2	1374	2023/03/27	2026/03/26
Simulated Tissue Liquid Head	HBBL600-10000V6	2200808-2	Each Time	/
Network Analyzer	E5071C	SER MY46519680	2024/05/21	2025/05/20
Dielectric Assessment Kit	DAK-3.5	1248	NCR	NCR
MXG Analog Signal Generator	N5181A	MY48180408	2024/01/16	2025/01/15
USB wideband power sensor	U2021XA	MY52350001	2024/05/21	2025/05/20
Directional Coupler	855673	3307	NCR	NCR
20dB Attenuator	2	BH9879	NCR	NCR
RF Power Amplifier	5205FE	1014	NCR	NCR
Amplifier	ZVE-8G+	558401902	NCR	NCR
Wideband Radio Communication Tester	CMW500	146520	2024/05/21	2025/05/20
Spectrum Analyzer	FSV40	101942	2024/09/20	2025/09/19
Thermometer	DTM3000	N/A	2024/01/16	2025/01/15
Temperature & Humidity Meter	10316377	N/A	2024/01/17	2025/01/16

NCR: No Calibration Required.

SAR MEASUREMENT SYSTEM VERIFICATION

Liquid Verification

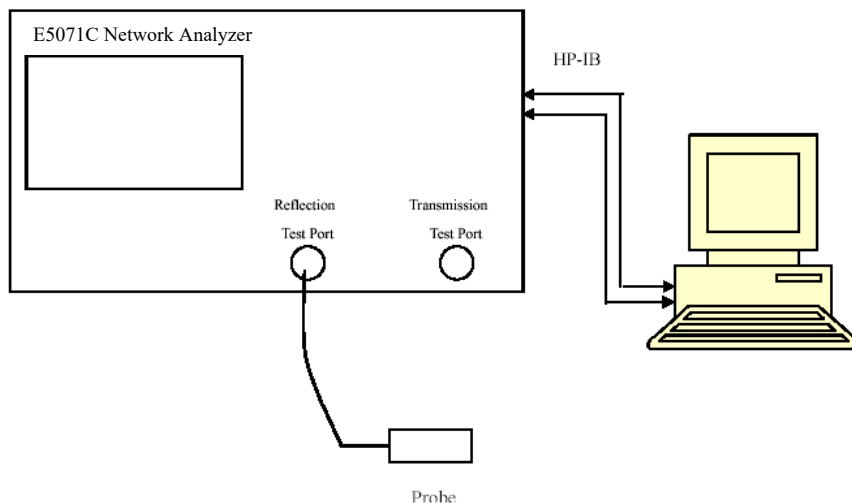

Liquid Verification Setup Block Diagram

Liquid Verification Results

Frequency (MHz)	Liquid Type	Liquid Parameter		Target Value		Delta (%)		Tolerance (%)
		ϵ_r	σ (S/m)	ϵ_r	σ (S/m)	$\Delta\epsilon_r$	$\Delta\sigma$ (S/m)	
700.5	Simulated Tissue Liquid Head	41.081	0.894	42.16	0.89	-2.56	0.45	±5
704	Simulated Tissue Liquid Head	41.077	0.894	42.15	0.89	-2.55	0.45	±5
707.5	Simulated Tissue Liquid Head	41.073	0.894	42.13	0.89	-2.51	0.45	±5
711	Simulated Tissue Liquid Head	41.069	0.894	42.11	0.89	-2.47	0.45	±5
714.5	Simulated Tissue Liquid Head	41.064	0.894	42.09	0.89	-2.44	0.45	±5
750	Simulated Tissue Liquid Head	41.022	0.895	41.90	0.89	-2.10	0.56	±5
782	Simulated Tissue Liquid Head	40.985	0.896	41.75	0.89	-1.83	0.67	±5

*Liquid Verification above was performed on 2024/11/10.

Frequency (MHz)	Liquid Type	Liquid Parameter		Target Value		Delta (%)		Tolerance (%)
		ϵ_r	σ (S/m)	ϵ_r	σ (S/m)	$\Delta\epsilon_r$	$\Delta\sigma$ (S/m)	
824.2	Simulated Tissue Liquid Head	41.378	0.938	41.55	0.90	-0.41	4.22	±5
826.4	Simulated Tissue Liquid Head	41.377	0.939	41.54	0.90	-0.39	4.33	±5
835	Simulated Tissue Liquid Head	41.370	0.939	41.50	0.90	-0.31	4.33	±5
836.6	Simulated Tissue Liquid Head	41.369	0.939	41.50	0.90	-0.32	4.33	±5
846.6	Simulated Tissue Liquid Head	41.361	0.941	41.50	0.91	-0.33	3.41	±5
848.8	Simulated Tissue Liquid Head	41.359	0.941	41.50	0.91	-0.34	3.41	±5

*Liquid Verification above was performed on 2024/11/11.

Frequency (MHz)	Liquid Type	Liquid Parameter		Target Value		Delta (%)		Tolerance (%)
		ϵ_r	σ (S/m)	ϵ_r	σ (S/m)	$\Delta\epsilon_r$	$\Delta\sigma$ (S/m)	
829	Simulated Tissue Liquid Head	42.277	0.894	41.53	0.90	1.80	-0.67	±5
835	Simulated Tissue Liquid Head	42.240	0.895	41.50	0.90	1.78	-0.56	±5
836.5	Simulated Tissue Liquid Head	42.230	0.895	41.50	0.90	1.76	-0.56	±5
844	Simulated Tissue Liquid Head	42.184	0.895	41.50	0.91	1.65	-1.65	±5

*Liquid Verification above was performed on 2024/11/12.

Frequency (MHz)	Liquid Type	Liquid Parameter		Target Value		Delta (%)		Tolerance (%)
		ϵ_r	σ (S/m)	ϵ_r	σ (S/m)	$\Delta\epsilon_r$	$\Delta\sigma$ (S/m)	
1850.2	Simulated Tissue Liquid Head	39.778	1.353	40.00	1.40	-0.56	-3.36	±5
1852.4	Simulated Tissue Liquid Head	39.775	1.354	40.00	1.40	-0.56	-3.29	±5
1880	Simulated Tissue Liquid Head	39.743	1.369	40.00	1.40	-0.64	-2.21	±5
1900	Simulated Tissue Liquid Head	39.720	1.380	40.00	1.40	-0.70	-1.43	±5
1907.6	Simulated Tissue Liquid Head	39.711	1.384	40.00	1.40	-0.72	-1.14	±5
1909.8	Simulated Tissue Liquid Head	39.708	1.386	40.00	1.40	-0.73	-1.00	±5

*Liquid Verification above was performed on 2024/11/13.

Frequency (MHz)	Liquid Type	Liquid Parameter		Target Value		Delta (%)		Tolerance (%)
		ϵ_r	σ (S/m)	ϵ_r	σ (S/m)	$\Delta\epsilon_r$	$\Delta\sigma$ (S/m)	
1860	Simulated Tissue Liquid Head	40.462	1.400	40.00	1.40	1.16	0.00	±5
1880	Simulated Tissue Liquid Head	40.462	1.404	40.00	1.40	1.16	0.29	±5
1900	Simulated Tissue Liquid Head	40.462	1.409	40.00	1.40	1.16	0.64	±5

*Liquid Verification above was performed on 2024/11/14.

Frequency (MHz)	Liquid Type	Liquid Parameter		Target Value		Delta (%)		Tolerance (%)
		ϵ_r	σ (S/m)	ϵ_r	σ (S/m)	$\Delta\epsilon_r$	$\Delta\sigma$ (S/m)	
2412	Simulated Tissue Liquid Head	38.342	1.801	39.27	1.77	-2.36	1.75	±5
2437	Simulated Tissue Liquid Head	38.330	1.816	39.22	1.79	-2.27	1.45	±5
2450	Simulated Tissue Liquid Head	38.324	1.824	39.20	1.80	-2.23	1.33	±5
2462	Simulated Tissue Liquid Head	38.319	1.831	39.18	1.81	-2.20	1.16	±5
2506	Simulated Tissue Liquid Head	38.298	1.857	39.13	1.86	-2.13	-0.16	±5
2549.5	Simulated Tissue Liquid Head	38.278	1.882	39.07	1.91	-2.03	-1.47	±5

*Liquid Verification above was performed on 2024/11/15.

Frequency (MHz)	Liquid Type	Liquid Parameter		Target Value		Delta (%)		Tolerance (%)
		ϵ_r	σ (S/m)	ϵ_r	σ (S/m)	$\Delta\epsilon_r$	$\Delta\sigma$ (S/m)	
2593	Simulated Tissue Liquid Head	38.423	1.973	39.01	1.95	-1.50	1.18	±5
2600	Simulated Tissue Liquid Head	38.410	1.981	39.00	1.96	-1.51	1.07	±5
2636.5	Simulated Tissue Liquid Head	38.347	2.021	38.95	2.00	-1.55	1.05	±5
2680	Simulated Tissue Liquid Head	38.272	2.069	38.90	2.05	-1.61	0.93	±5

*Liquid Verification above was performed on 2024/11/15.

Frequency (MHz)	Liquid Type	Liquid Parameter		Target Value		Delta (%)		Tolerance (%)
		ϵ_r	σ (S/m)	ϵ_r	σ (S/m)	$\Delta\epsilon_r$	$\Delta\sigma$ (S/m)	
5180	Simulated Tissue Liquid Head	35.322	4.532	36.02	4.64	-1.94	-2.33	±5
5200	Simulated Tissue Liquid Head	35.321	4.563	36.00	4.66	-1.89	-2.08	±5
5240	Simulated Tissue Liquid Head	35.318	4.625	35.96	4.70	-1.79	-1.60	±5
5250	Simulated Tissue Liquid Head	35.317	4.640	35.95	4.71	-1.76	-1.49	±5

*Liquid Verification above was performed on 2024/11/16.

Frequency (MHz)	Liquid Type	Liquid Parameter		Target Value		Delta (%)		Tolerance (%)
		ϵ_r	σ (S/m)	ϵ_r	σ (S/m)	$\Delta\epsilon_r$	$\Delta\sigma$ (S/m)	
5745	Simulated Tissue Liquid Head	34.565	5.407	35.36	5.22	-2.25	3.58	±5
5785	Simulated Tissue Liquid Head	34.487	5.455	35.32	5.26	-2.36	3.71	±5
5800	Simulated Tissue Liquid Head	34.458	5.473	35.30	5.27	-2.39	3.85	±5
5825	Simulated Tissue Liquid Head	34.410	5.503	35.28	5.30	-2.47	3.83	±5

*Liquid Verification above was performed on 2024/11/16.

System Accuracy Verification

Prior to the assessment, the system validation kit was used to test whether the system was operating within its specifications of $\pm 10\%$. The validation results are tabulated below. And also the corresponding SAR plot is attached as well in the SAR plots files.

The spacing distances in the **System Verification Setup Block Diagram** is given by the following:

- a) $s = 15 \text{ mm} \pm 0,2 \text{ mm}$ for $300 \text{ MHz} \leq f \leq 1 \text{ 000 MHz}$;
- b) $s = 10 \text{ mm} \pm 0,2 \text{ mm}$ for $1 \text{ 000 MHz} < f \leq 3 \text{ 000 MHz}$;
- c) $s = 10 \text{ mm} \pm 0,2 \text{ mm}$ for $3 \text{ 000 MHz} < f \leq 6 \text{ 000 MHz}$.

System Verification Setup Block Diagram

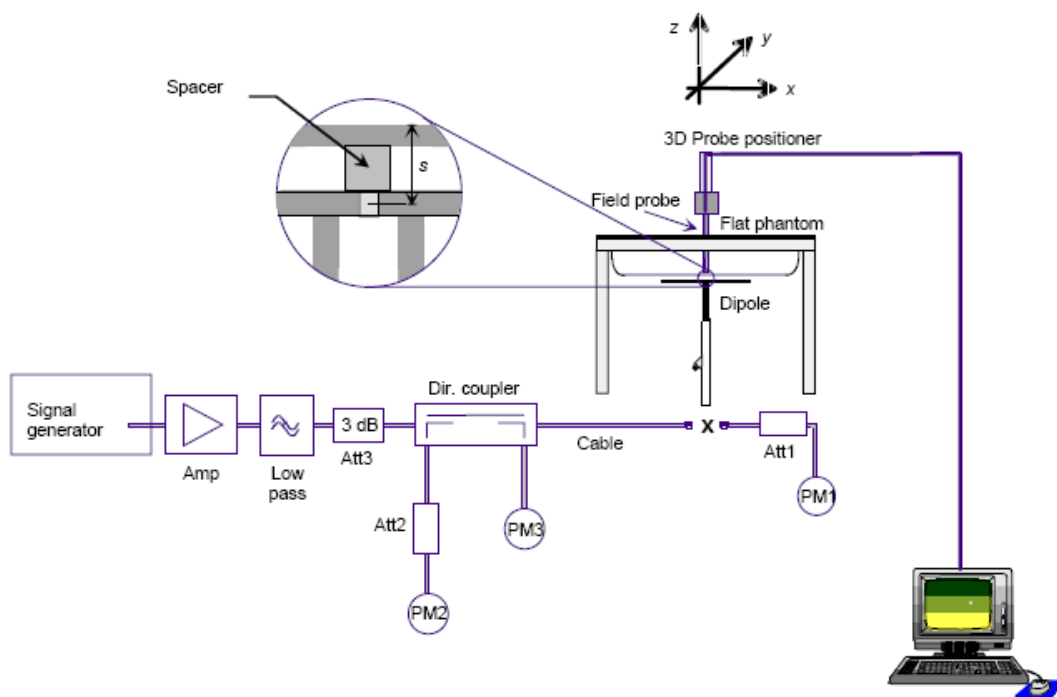

System Accuracy Check Results

Date	Frequency Band (MHz)	Liquid Type	Input Power (mW)	Measured SAR (W/kg)	Normalized to 1W (W/kg)	Target Value (W/Kg)	Delta (%)	Tolerance (%)
2024/11/10	750	Head	100	1g 0.832	8.32	8.41	-1.070	± 10
2024/11/11	835	Head	100	1g 0.891	8.91	9.44	-5.614	± 10
2024/11/12	835	Head	100	1g 0.970	9.70	9.44	2.754	± 10
2024/11/13	1900	Head	100	1g 3.79	37.9	39.9	-5.013	± 10
2024/11/14	1900	Head	100	1g 4.10	41.0	39.9	2.757	± 10
2024/11/15	2450	Head	100	1g 5.15	51.5	51.7	-0.387	± 10
2024/11/15	2600	Head	100	1g 5.32	53.2	55.2	-3.623	± 10
2024/11/16	5250	Head	100	1g 7.95	79.5	80.1	-0.749	± 10
2024/11/16	5800	Head	100	1g 8.33	83.3	81.4	2.334	± 10

Note:
All the SAR values are normalized to 1Watt forward power.

SAR SYSTEM VALIDATION DATA

System Performance 750 MHz Head (Date 2024/11/10)

DUT: Dipole 750 MHz; Type: D750V3; Serial: 1229

Communication System: UID 0, CW (0); Frequency: 750 MHz;Duty Cycle: 1:1

Medium parameters used: $f = 750 \text{ MHz}$; $\sigma = 0.895 \text{ S/m}$; $\epsilon_r = 41.022$; $\rho = 1000 \text{ kg/m}^3$

Phantom section: Flat Section

DASY5 Configuration:

- Probe: EX3DV4 - SN7783; ConvF(9.4, 9.4, 9.4) @ 750 MHz;
- Sensor-Surface: 1.4mm (Mechanical Surface Detection)
- Electronics: DAE4 Sn1724; Calibrated: 3/28/2024
- Phantom: SAM-Twin V8.0 P1aP2a; Type: QD 000 P41 AA ; Serial: 1962
- Measurement SW: DASY52, Version 52.10 (2);

Configuration/Head 750MHz Pin=100mW/Area Scan (11x19x1): Measurement grid: $dx=10\text{mm}$, $dy=10\text{mm}$

Maximum value of SAR (measured) = 1.17 W/kg

Configuration/Head 750MHz Pin=100mW/Zoom Scan (7x7x7)/Cube 0: Measurement grid: $dx=5\text{mm}$, $dy=5\text{mm}$, $dz=5\text{mm}$

Reference Value = 31.82 V/m; Power Drift = -0.07 dB

Peak SAR (extrapolated) = 1.34 W/kg

SAR(1 g) = 0.832 W/kg; SAR(10 g) = 0.556 W/kg

Maximum value of SAR (measured) = 1.15 W/kg

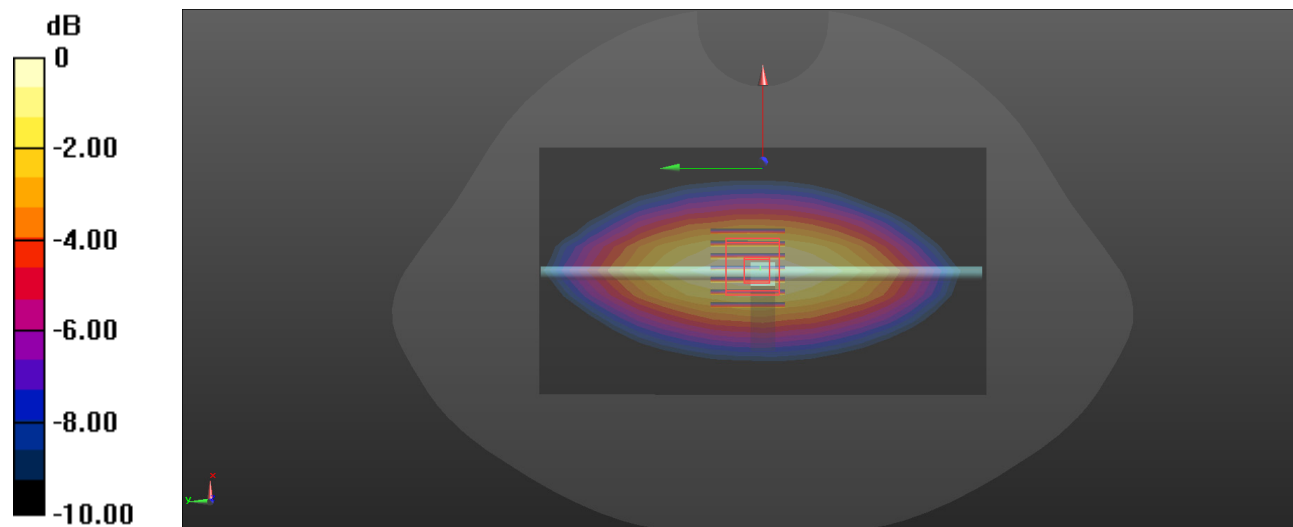

0 dB = 1.15 W/kg = 0.61 dBW/kg

System Performance 835 MHz Head (Date 2024/11/11)

DUT: Dipole 835 MHz; Type: D835V2; Serial: 453

Communication System: UID 0, CW (0); Frequency: 835 MHz;Duty Cycle: 1:1
 Medium parameters used: $f = 835 \text{ MHz}$; $\sigma = 0.939 \text{ S/m}$; $\epsilon_r = 41.37$; $\rho = 1000 \text{ kg/m}^3$
 Phantom section: Flat Section

DASY5 Configuration:

- Probe: EX3DV4 - SN7783; ConvF(9.1, 9.1, 9.1) @ 835 MHz;
- Sensor-Surface: 1.4mm (Mechanical Surface Detection)
- Electronics: DAE4 Sn1724; Calibrated: 3/28/2024
- Phantom: SAM-Twin V8.0 P1aP2a; Type: QD 000 P41 AA ; Serial: 1962
- Measurement SW: DASY52, Version 52.10 (2);

Configuration/Head 835MHz Pin=100mW/Area Scan (8x11x1): Measurement grid: $dx=15\text{mm}$, $dy=15\text{mm}$
 Maximum value of SAR (measured) = 0.957 W/kg

Configuration/Head 835MHz Pin=100mW/Zoom Scan (5x5x7)/Cube 0: Measurement grid: $dx=8\text{mm}$, $dy=8\text{mm}$, $dz=5\text{mm}$

Reference Value = 34.83 V/m; Power Drift = -0.12 dB

Peak SAR (extrapolated) = 1.34 W/kg

SAR(1 g) = 0.891 W/kg; SAR(10 g) = 0.581 W/kg

Maximum value of SAR (measured) = 0.965 W/kg

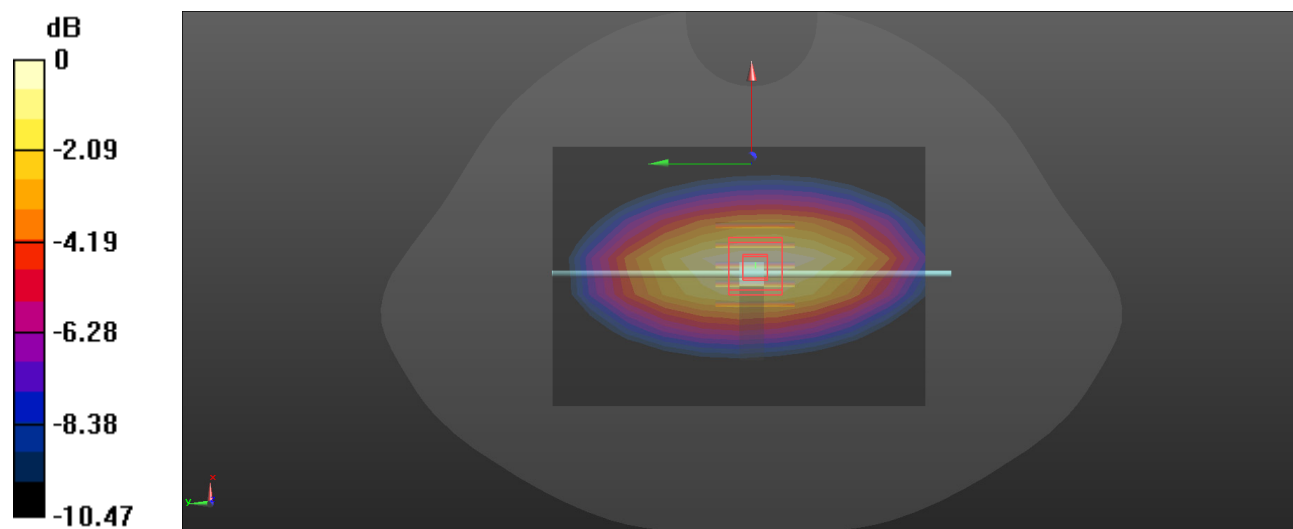

0 dB = 0.965 W/kg = -0.15 dBW/kg

System Performance 835 MHz Head (Date 2024/11/12)

DUT: Dipole 835 MHz; Type: D835V2; Serial: 453

Communication System: UID 0, CW (0); Frequency: 835 MHz;Duty Cycle: 1:1
 Medium parameters used: $f = 835 \text{ MHz}$; $\sigma = 0.895 \text{ S/m}$; $\epsilon_r = 42.24$; $\rho = 1000 \text{ kg/m}^3$
 Phantom section: Flat Section

DASY5 Configuration:

- Probe: EX3DV4 - SN7783; ConvF(9.1, 9.1, 9.1) @ 835 MHz;
- Sensor-Surface: 1.4mm (Mechanical Surface Detection)
- Electronics: DAE4 Sn1724; Calibrated: 3/28/2024
- Phantom: SAM-Twin V8.0 P1aP2a; Type: QD 000 P41 AA ; Serial: 1962
- Measurement SW: DASY52, Version 52.10 (2);

Configuration/Head 835MHz Pin=100mW/Area Scan (11x15x1): Measurement grid: $dx=10\text{mm}$, $dy=10\text{mm}$
 Maximum value of SAR (measured) = 1.05 W/kg

Configuration/Head 835MHz Pin=100mW/Zoom Scan (7x7x7)/Cube 0: Measurement grid: $dx=5\text{mm}$, $dy=5\text{mm}$, $dz=5\text{mm}$

Reference Value = 34.92 V/m; Power Drift = -0.03 dB

Peak SAR (extrapolated) = 1.48 W/kg

SAR(1 g) = 0.970 W/kg; SAR(10 g) = 0.615 W/kg

Maximum value of SAR (measured) = 1.03 W/kg

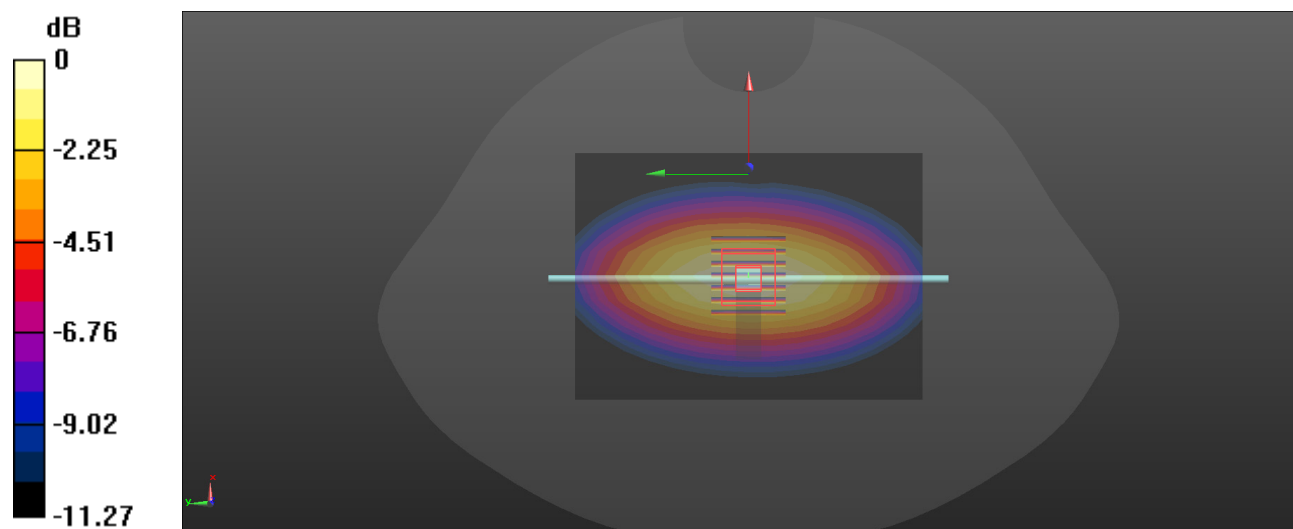

0 dB = 1.03 W/kg = 0.13 dBW/kg

System Performance 1900 MHz Head (Date 2024/11/13)

DUT: Dipole 1900 MHz; Type: D1900V2; Serial: 5d231

Communication System: UID 0, CW (0); Frequency: 1900 MHz; Duty Cycle: 1:1
 Medium parameters used: $f = 1900 \text{ MHz}$; $\sigma = 1.38 \text{ S/m}$; $\epsilon_r = 39.72$; $\rho = 1000 \text{ kg/m}^3$
 Phantom section: Flat Section

DASY5 Configuration:

- Probe: EX3DV4 - SN7783; ConvF(7.38, 7.38, 7.38) @ 1900 MHz;
- Sensor-Surface: 1.4mm (Mechanical Surface Detection)
- Electronics: DAE4 Sn1724; Calibrated: 3/28/2024
- Phantom: SAM-Twin V8.0 P1aP2a; Type: QD 000 P41 AA ; Serial: 1962
- Measurement SW: DASY52, Version 52.10 (2);

Configuration/Head 1900MHz Pin=100mW/Area Scan (9x13x1): Measurement grid: $dx=10\text{mm}$, $dy=10\text{mm}$
 Maximum value of SAR (measured) = 5.45 W/kg

Configuration/Head 1900MHz Pin=100mW/Zoom Scan (7x7x7)/Cube 0: Measurement grid: $dx=5\text{mm}$, $dy=5\text{mm}$, $dz=5\text{mm}$

Reference Value = 54.60 V/m; Power Drift = -0.20 dB

Peak SAR (extrapolated) = 6.91 W/kg

SAR(1 g) = 3.79 W/kg; SAR(10 g) = 2.04 W/kg

Maximum value of SAR (measured) = 5.78 W/kg

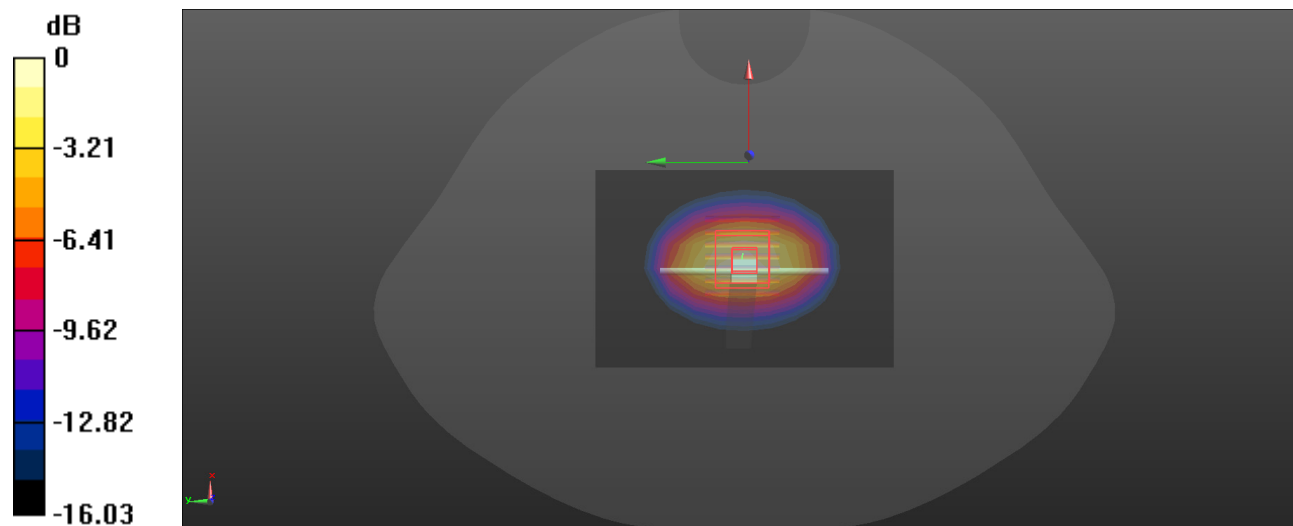

0 dB = 5.78 W/kg = 7.62 dBW/kg

System Performance 1900 MHz Head (Date 2024/11/14)

DUT: Dipole 1900 MHz; Type: D1900V2; Serial: 5d231

Communication System: UID 0, CW (0); Frequency: 1900 MHz;Duty Cycle: 1:1
 Medium parameters used: f = 1900 MHz; $\sigma = 1.409$ S/m; $\epsilon_r = 40.462$; $\rho = 1000$ kg/m³
 Phantom section: Flat Section

DASY5 Configuration:

- Probe: EX3DV4 - SN7783; ConvF(7.38, 7.38, 7.38) @ 1900 MHz;
- Sensor-Surface: 1.4mm (Mechanical Surface Detection)
- Electronics: DAE4 Sn1724; Calibrated: 3/28/2024
- Phantom: SAM-Twin V8.0 P1aP2a; Type: QD 000 P41 AA ; Serial: 1962
- Measurement SW: DASY52, Version 52.10 (2);

Configuration/Head 1900MHz Pin=100mW/Area Scan (9x13x1): Measurement grid: dx=10mm, dy=10mm
 Maximum value of SAR (measured) = 6.32 W/kg

Configuration/Head 1900MHz Pin=100mW/Zoom Scan (7x7x7)/Cube 0: Measurement grid: dx=5mm, dy=5mm, dz=5mm

Reference Value = 57.53 V/m; Power Drift = -0.12 dB

Peak SAR (extrapolated) = 7.50 W/kg

SAR(1 g) = 4.1 W/kg; SAR(10 g) = 2.2 W/kg

Maximum value of SAR (measured) = 6.30 W/kg

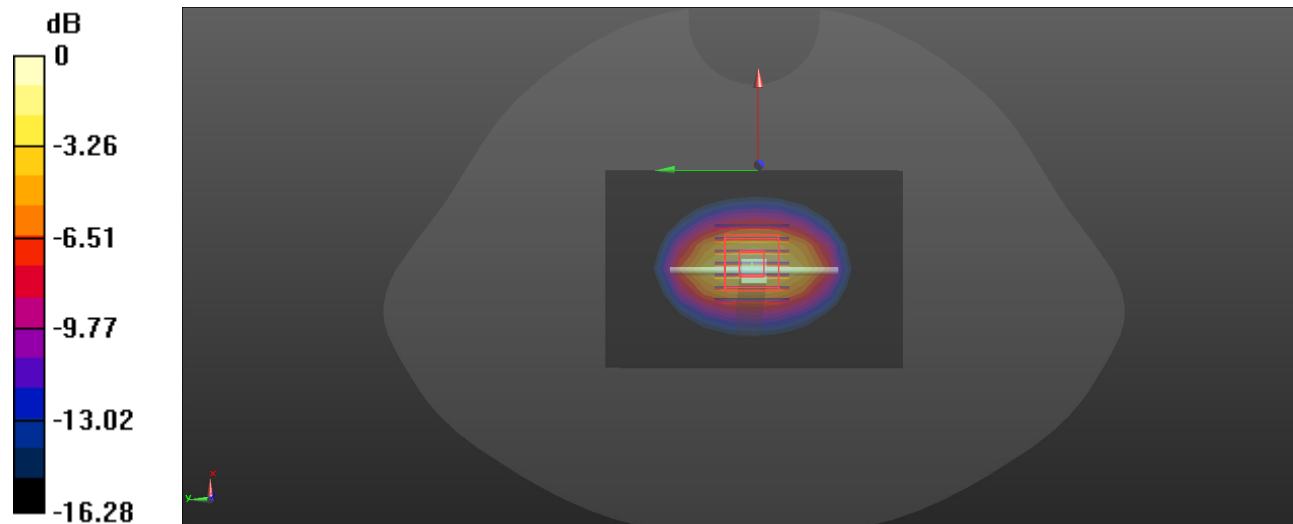

0 dB = 6.30 W/kg = 7.99 dBW/kg

System Performance 2450 MHz Head (Date 2024/11/15)

DUT: Dipole 2450 MHz; Type: D2450V2; Serial: 1103

Communication System: UID 0, CW (0); Frequency: 2450 MHz;Duty Cycle: 1:1
 Medium parameters used: $f = 2450 \text{ MHz}$; $\sigma = 1.824 \text{ S/m}$; $\epsilon_r = 38.324$; $\rho = 1000 \text{ kg/m}^3$
 Phantom section: Flat Section

DASY5 Configuration:

- Probe: EX3DV4 - SN7783; ConvF(6.85, 6.85, 6.85) @ 2450 MHz;
- Sensor-Surface: 1.4mm (Mechanical Surface Detection)
- Electronics: DAE4 Sn1724; Calibrated: 3/28/2024
- Phantom: SAM-Twin V8.0 P1aP2a; Type: QD 000 P41 AA ; Serial: 1962
- Measurement SW: DASY52, Version 52.10 (2);

Configuration/Head 2450MHz Pin=100mW/Area Scan (9x10x1): Measurement grid: dx=10mm, dy=10mm
 Maximum value of SAR (measured) = 6.79 W/kg

Configuration/Head 2450MHz Pin=100mW/Zoom Scan (7x7x7)/Cube 0: Measurement grid: dx=5mm, dy=5mm, dz=5mm

Reference Value = 55.36 V/m; Power Drift = -0.13 dB

Peak SAR (extrapolated) = 9.92 W/kg

SAR(1 g) = 5.15 W/kg; SAR(10 g) = 2.49 W/kg

Maximum value of SAR (measured) = 8.32 W/kg

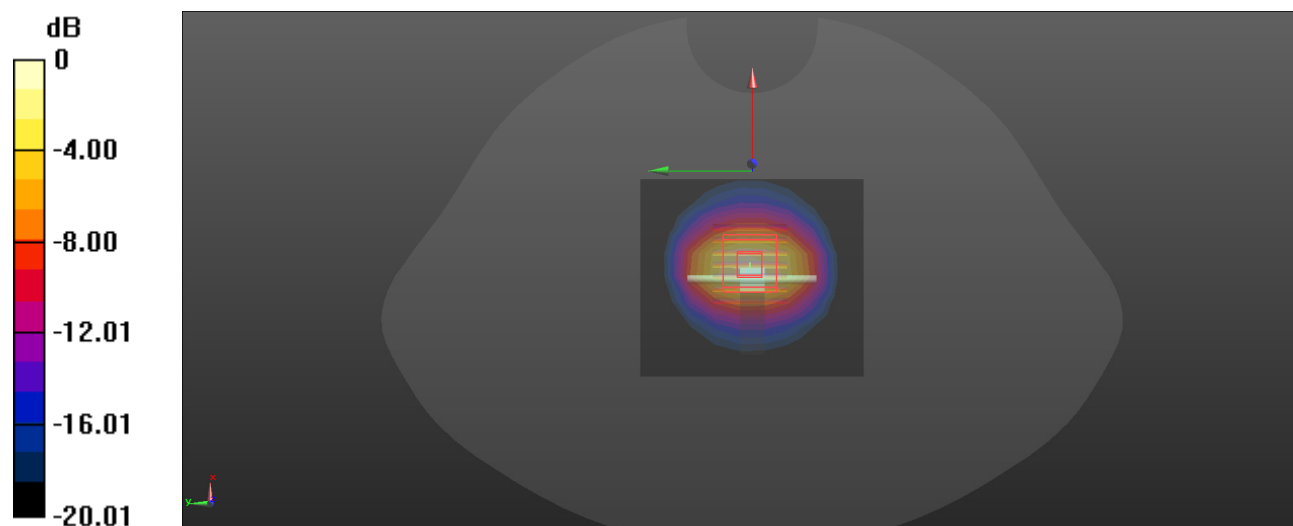

0 dB = 8.32 W/kg = 9.20 dBW/kg

System Performance 2600 MHz Head (Date 2024/11/15)

DUT: Dipole 2600 MHz; Type: D2600V2; Serial: 1207

Communication System: UID 0, CW (0); Frequency: 2600 MHz;Duty Cycle: 1:1

Medium parameters used: $f = 2600 \text{ MHz}$; $\sigma = 1.981 \text{ S/m}$; $\epsilon_r = 38.41$; $\rho = 1000 \text{ kg/m}^3$

Phantom section: Flat Section

DASY5 Configuration:

- Probe: EX3DV4 - SN7783; ConvF(6.65, 6.65, 6.65) @ 2600 MHz;
- Sensor-Surface: 1.4mm (Mechanical Surface Detection)
- Electronics: DAE4 Sn1724; Calibrated: 3/28/2024
- Phantom: SAM-Twin V8.0 P1aP2a; Type: QD 000 P41 AA ; Serial: 1962
- Measurement SW: DASY52, Version 52.10 (2);

Configuration/Head 2600MHz Pin=100mW/Area Scan (9x10x1): Measurement grid: dx=10mm, dy=10mm
 Maximum value of SAR (measured) = 7.31 W/kg

Configuration/Head 2600MHz Pin=100mW/Zoom Scan (7x7x7)/Cube 0: Measurement grid: dx=5mm, dy=5mm, dz=5mm

Reference Value = 55.56 V/m; Power Drift = -0.12 dB

Peak SAR (extrapolated) = 10.5 W/kg

SAR(1 g) = 5.32 W/kg; SAR(10 g) = 2.5 W/kg

Maximum value of SAR (measured) = 8.71 W/kg

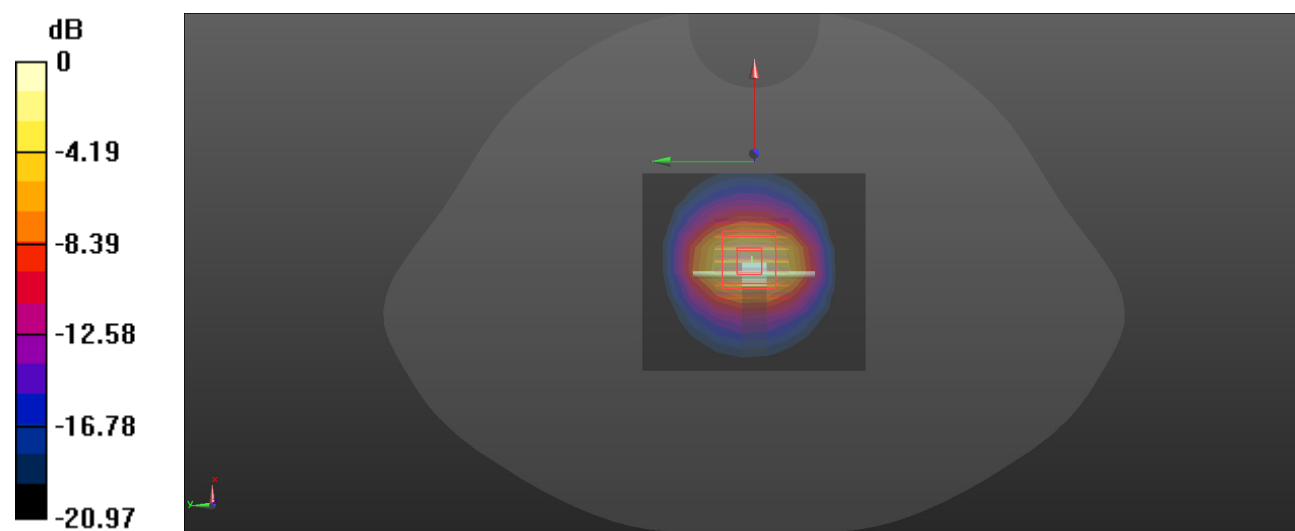

0 dB = 8.71 W/kg = 9.40 dBW/kg

System Performance 5250 MHz Head (Date 2024/11/16)

DUT: Dipole D5GHz; Type: D5GHzV2; Serial: 1374

Communication System: UID 0, CW (0); Frequency: 5250 MHz;Duty Cycle: 1:1

Medium parameters used: $f = 5250 \text{ MHz}$; $\sigma = 4.64 \text{ S/m}$; $\epsilon_r = 35.317$; $\rho = 1000 \text{ kg/m}^3$

Phantom section: Flat Section

DASY5 Configuration:

- Probe: EX3DV4 - SN7783; ConvF(5, 5, 5) @ 5250 MHz;
- Sensor-Surface: 1.4mm (Mechanical Surface Detection)
- Electronics: DAE4 Sn1724; Calibrated: 3/28/2024
- Phantom: SAM-Twin V8.0 P1aP2a; Type: QD 000 P41 AA ; Serial: 1962
- Measurement SW: DASY52, Version 52.10 (2);

Configuration/Head 5250MHz Pin=100mW/Area Scan (7x9x1): Measurement grid: dx=10mm, dy=10mm

Maximum value of SAR (measured) = 18.3 W/kg

Configuration/Head 5250MHz Pin=100mW/Zoom Scan (8x8x12)/Cube 0: Measurement grid: dx=4mm, dy=4mm, dz=2mm

Reference Value = 46.73 V/m; Power Drift = -0.08 dB

Peak SAR (extrapolated) = 26.0 W/kg

SAR(1 g) = 7.95 W/kg; SAR(10 g) = 2.36 W/kg

Maximum value of SAR (measured) = 17.4 W/kg

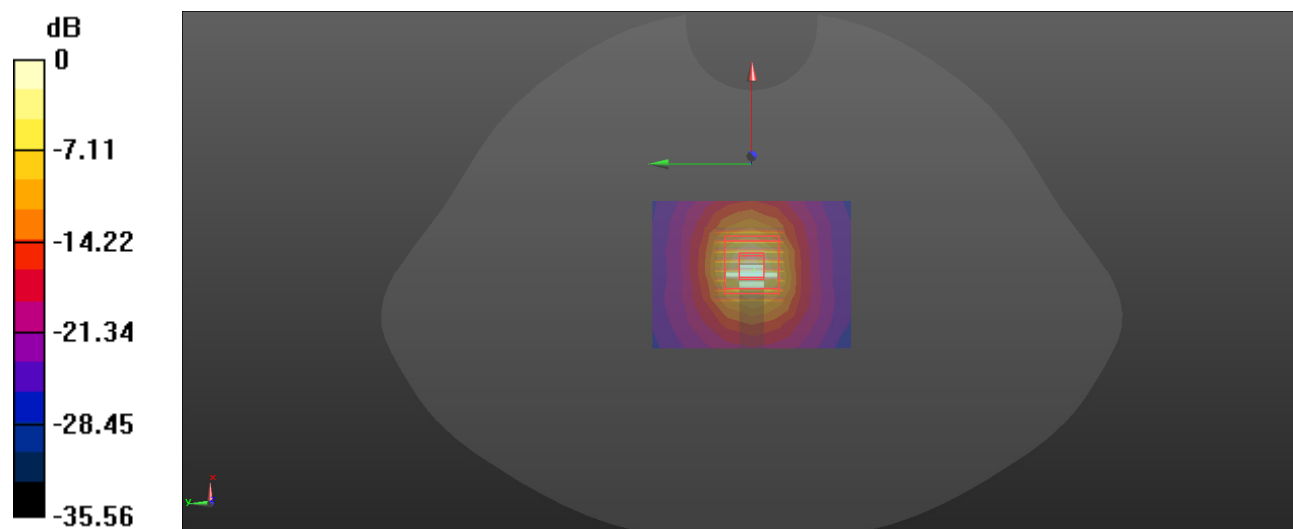

0 dB = 17.4 W/kg = 12.41 dBW/kg

System Performance 5800 MHz Head (Date 2024/11/16)

DUT: Dipole D5GHz; Type: D5GHzV2; Serial: 1374

Communication System: UID 0, CW (0); Frequency: 5800 MHz;Duty Cycle: 1:1
 Medium parameters used: $f = 5800 \text{ MHz}$; $\sigma = 5.473 \text{ S/m}$; $\epsilon_r = 34.458$; $\rho = 1000 \text{ kg/m}^3$
 Phantom section: Flat Section

DASY5 Configuration:

- Probe: EX3DV4 - SN7783; ConvF(4.55, 4.55, 4.55) @ 5800 MHz;
- Sensor-Surface: 1.4mm (Mechanical Surface Detection)
- Electronics: DAE4 Sn1724; Calibrated: 3/28/2024
- Phantom: SAM-Twin V8.0 P1aP2a; Type: QD 000 P41 AA ; Serial: 1962
- Measurement SW: DASY52, Version 52.10 (2);

Configuration/Head 5800MHz Pin=100mW/Area Scan (7x9x1): Measurement grid: $dx=10\text{mm}$, $dy=10\text{mm}$
 Maximum value of SAR (measured) = 22.1 W/kg

Configuration/Head 5800MHz Pin=100mW/Zoom Scan (8x8x12)/Cube 0: Measurement grid: $dx=4\text{mm}$, $dy=4\text{mm}$, $dz=2\text{mm}$

Reference Value = 45.07 V/m; Power Drift = -0.05 dB

Peak SAR (extrapolated) = 31.0 W/kg

SAR(1 g) = 8.33 W/kg; SAR(10 g) = 2.45 W/kg

Maximum value of SAR (measured) = 19.7 W/kg

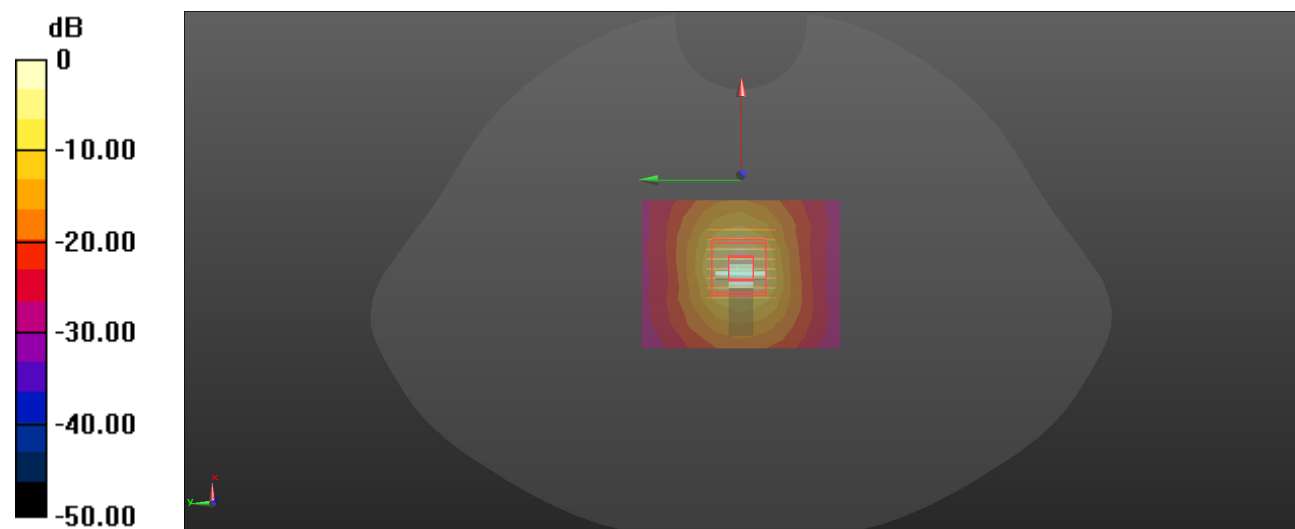

0 dB = 19.7 W/kg = 12.94 dBW/kg

EUT TEST STRATEGY AND METHODOLOGY

Test Positions for Device Operating Next to a Person’s Ear

This category includes most wireless handsets with fixed, retractable or internal antennas located toward the top half of the device, with or without a foldout, sliding or similar keypad cover. The handset should have its earpiece located within the upper ¼ of the device, either along the centerline or off-centered, as perceived by its users. This type of handset should be positioned in a normal operating position with the “test device reference point” located along the “vertical centerline” on the front of the device aligned to the “ear reference point”. The “test device reference point” should be located at the same level as the center of the earpiece region. The “vertical centerline” should bisect the front surface of the handset at its top and bottom edges. A “ear reference point” is located on the outer surface of the head phantom on each ear spacer. It is located 1.5 cm above the center of the ear canal entrance in the “phantom reference plane” defined by the three lines joining the center of each “ear reference point” (left and right) and the tip of the mouth.

A handset should be initially positioned with the earpiece region pressed against the ear spacer of a head phantom. For the SCC-34/SC-2 head phantom, the device should be positioned parallel to the “N-F” line defined along the base of the ear spacer that contains the “ear reference point”. For interim head phantoms, the device should be positioned parallel to the cheek for maximum RF energy coupling. The “test device reference point” is aligned to the “ear reference point” on the head phantom and the “vertical centerline” is aligned to the “phantom reference plane”. This is called the “initial ear position”. While maintaining these three alignments, the body of the handset is gradually adjusted to each of the following positions for evaluating SAR:

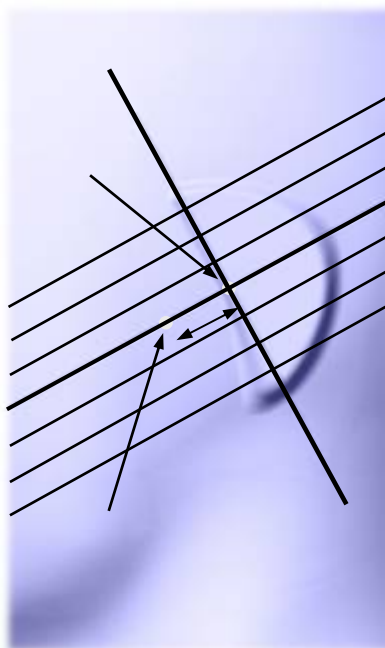
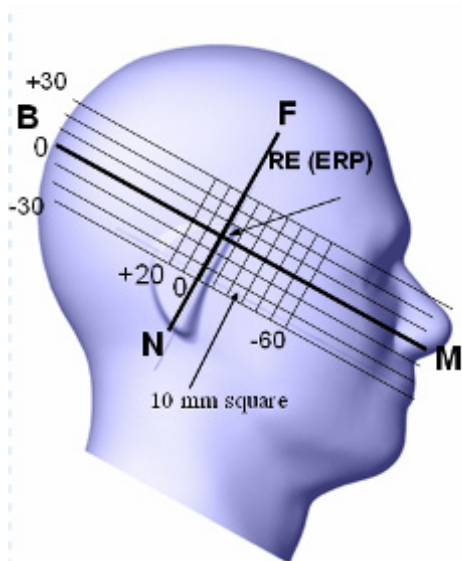

Cheek/Touch Position

The device is brought toward the mouth of the head phantom by pivoting against the “ear reference point” or along the “N-F” line for the SCC-34/SC-2 head phantom.

This test position is established:

When any point on the display, keypad or mouthpiece portions of the handset is in contact with the phantom.

(or) When any portion of a foldout, sliding or similar keypad cover opened to its intended self-adjusting normal use position is in contact with the cheek or mouth of the phantom.

For existing head phantoms – when the handset loses contact with the phantom at the pivoting point, rotation should continue until the device touches the cheek of the phantom or breaks its last contact from the ear spacer.

Cheek /Touch Position

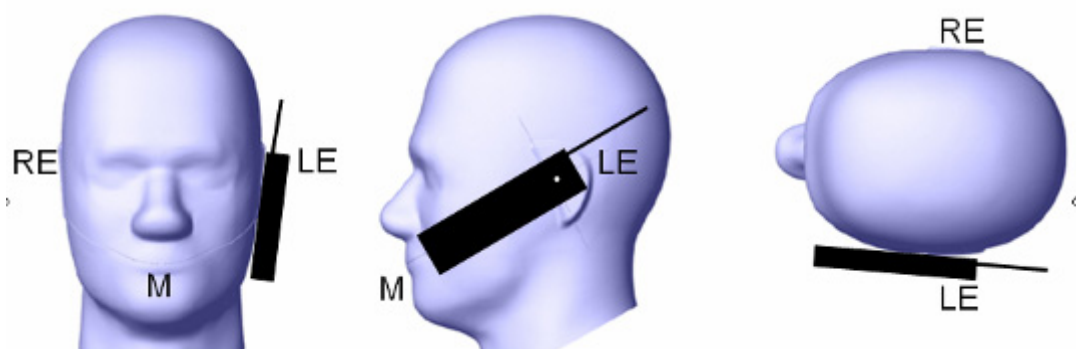

Ear/Tilt Position

With the handset aligned in the “Cheek/Touch Position”:

1) If the earpiece of the handset is not in full contact with the phantom’s ear spacer (in the “Cheek/Touch position”) and the peak SAR location for the “Cheek/Touch” position is located at the ear spacer region or corresponds to the earpiece region of the handset, the device should be returned to the “initial ear position” by rotating it away from the mouth until the earpiece is in full contact with the ear spacer.

2) (otherwise) The handset should be moved (translated) away from the cheek perpendicular to the line passes through both “ear reference points” (note: one of these ear reference points may not physically exist on a split head model) for approximate 2-3 cm. While it is in this position, the device handset is tilted away from the mouth with respect to the “test device reference point” until the inside angle between the vertical centerline on the front surface of the phone and the horizontal line passing through the ear reference point is by 15 80°. After the tilt, it is then moved (translated) back toward the head perpendicular to the line passes through both “ear reference points” until the device touches the phantom or the ear spacer. If the antenna touches the head first, the positioning process should be repeated with a tilt angle less than 15° so that the device and its antenna would touch the phantom simultaneously. This test position may require a device holder or positioner to achieve the translation and tilting with acceptable positioning repeatability.

If a device is also designed to transmit with its keypad cover closed for operating in the head position, such positions should also be considered in the SAR evaluation. The device should be tested on the left and right side of the head phantom in the “Cheek/Touch” and “Ear/Tilt” positions. When applicable, each configuration should be tested with the antenna in its fully extended and fully retracted positions. These test configurations should be tested at the high, middle and low frequency channels of each operating mode; for example, AMPS, CDMA, and TDMA. If the SAR measured at the middle channel for each test configuration (left, right, Cheek/Touch, Tilt/Ear, extended and retracted) is at least 2.0 dB lower than the SAR limit, testing at the high and low channels is optional for such test configuration(s). If the transmission band of the test device is less than 10 MHz, testing at the high and low frequency channels is optional.

Ear /Tilt 15° Position

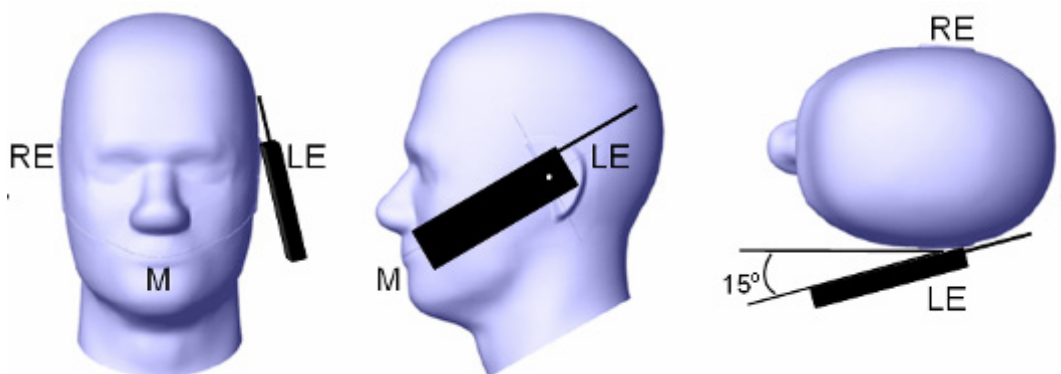

Test positions for body-worn and other configurations

Body-worn operating configurations should be tested with the belt-clips and holsters attached to the device and positioned against a flat phantom in normal use configurations. Devices with a headset output should be tested with a headset connected to the device. When multiple accessories that do not contain metallic components are supplied with the device, the device may be tested with only the accessory that dictates the closest spacing to the body. When multiple accessories that contain metallic components are supplied with the device, the device must be tested with each accessory that contains a unique metallic component. If multiple accessories share an identical metallic component (e.g., the same metallic belt-clip used with different holsters with no other metallic components), only the accessory that dictates the closest spacing to the body must be tested.

Body-worn accessories may not always be supplied or available as options for some devices that are intended to be authorized for body-worn use. A separation distance of 1.5 cm between the back of the device and a flat phantom is recommended for testing body-worn SAR compliance under such circumstances. Other separation distances may be used, but they should not exceed 2.5 cm. In these cases, the device may use body-worn accessories that provide a separation distance greater than that tested for the device provided however that the accessory contains no metallic components.

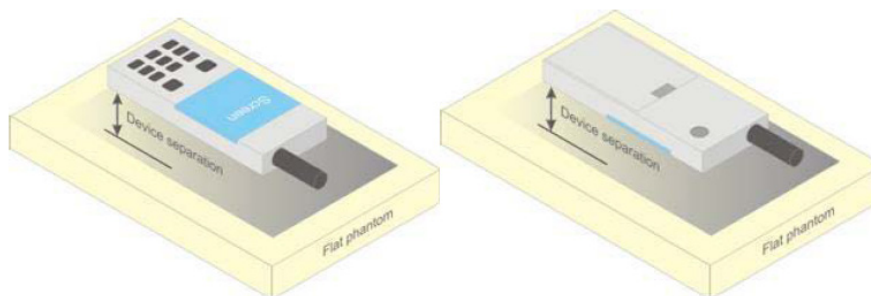

Figure 5 – Test positions for body-worn devices

Test Distance for SAR Evaluation

In this case the EUT (Equipment Under Test) is set 10mm away from the phantom, the test distance is 10mm.

SAR Evaluation Procedure

The evaluation was performed with the following procedure:

Step 1: Measurement of the SAR value at a fixed location above the ear point or central position was used as a reference value for assessing the power drop. The SAR at this point is measured at the start of the test and then again at the end of the testing.

Step 2: The SAR distribution at the exposed side of the head was measured at a distance of 4 mm from the inner surface of the shell. The area covered the entire dimension of the head or radiating structures of the EUT, the horizontal grid spacing was 15 mm x 15 mm, and the SAR distribution was determined by integrated grid of 1.5mm x 1.5mm. Based on these data, the area of the maximum absorption was determined by spline interpolation. The first Area Scan covers the entire dimension of the EUT to ensure that the hotspot was correctly identified.

Step 3: Around this point, a volume of 30 mm x 30 mm x 30 mm was assessed by measuring 7x 7 x 7 points. On the basis of this data set, the spatial peak SAR value was evaluated under the following procedure:

- 1) The data at the surface were extrapolated, since the center of the dipoles is 1.2 mm away from the tip of the probe and the distance between the surface and the lowest measuring point is 1.3 mm. The extrapolation was based on a least square algorithm. A polynomial of the fourth order was calculated through the points in z-axes. This polynomial was then used to evaluate the points between the surface and the probe tip.

- 2) The maximum Measured value was searched with a straightforward algorithm. Around this maximum the SAR values averaged over the spatial volumes (1 g or 10 g) were computed by the 3D-Spline interpolation algorithm. The 3D-Spline is composed of three one dimensional splines with the "Not a knot"-condition (in x, y and z-directions). The volume was integrated with the trapezoidal-algorithm. One thousand points (10 x 10 x 10) were Measured to calculate the averages.

All neighboring volumes were evaluated until no neighboring volume with a higher average value was found.

Step 4: Re-measurement of the SAR value at the same location as in Step 1. If the value changed by more than 5%, the evaluation was repeated.

CONDUCTED OUTPUT POWER MEASUREMENT

Test Procedure

The RF output of the transmitter was connected to the input of the Wireless Communication Test Set through Connector.

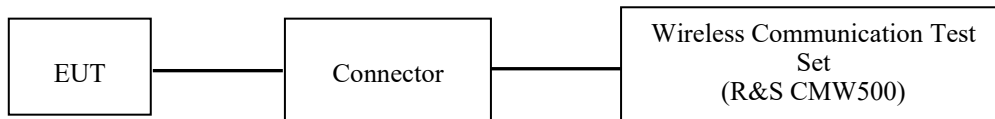

GSM/WCDMA/LTE

The RF output of the transmitter was connected to the input of the Spectrum Analyzer.

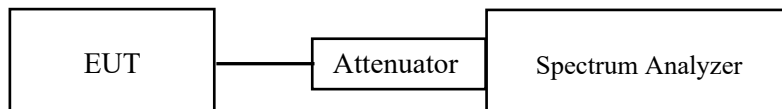

Bluetooth/BLE/WLAN

Description of Test Configuration

EUT Operation Condition:

EUT Operation Mode:	The system was configured for testing in each operation mode.
Equipment Modifications:	No
EUT Exercise Software:	No
<p>The maximum power was configured per 3GPP Standard for each operation modes as below setting:</p> <p>GSM/GPRS/EGPRS</p> <p>Function: Menu select > GSM Mobile Station > GSM 850/1900 Press Connection control to choose the different menus Press RESET > choose all the reset all settings Connection Press Signal Off to turn off the signal and change settings Network Support > GSM + GPRS or GSM + EGSM Main Service > Packet Data Service selection > Test Mode A – Auto Slot Config. off MS Signal Press Slot Config Bottom on the right twice to select and change the number of time slots and power setting > Slot configuration > Uplink/Gamma > 33 dBm for GPRS 850 > 30 dBm for GPRS 1900 > 27 dBm for EGPRS 850 > 26 dBm for EGPRS 1900 BS Signal channel Enter the same channel number for TCH channel (test channel) and BCCH Frequency Offset > + 0 Hz Mode > BCCH and TCH</p> <p>BCCH Level > -85 dBm (May need to adjust if link is not stable) BCCH Channel > choose desire test channel [Enter the same channel number for TCH channel (test channel) and BCCH channel]</p> <p>Channel Type > Off P0 > 4 dB Slot Config> Unchanged (if already set under MS signal) TCH > choose desired test channel Hopping > Off Main Timeslot > 3 Network Coding Scheme > CS4 (GPRS) and MCS5 (EGPRS)</p> <p>Bit Stream > 2E9-1 PSR Bit Stream AF/RF Enter appropriate offsets for Ext. Att. Output and Ext. Att. Input Connection Press Sign</p>	

WCDMA-Release 99

The following tests were conducted according to the test requirements outlines in section 5.2 of the 3GPP TS34.121-1 specification. The EUT has a nominal maximum output power of 24dBm (+1.7/-3.7).

WCDMA General Settings	Loopback Mode	Test Mode 1
	Rel99 RMC	12.2kbps RMC
	Power Control Algorithm	Algorithm2
	β_c / β_d	8/15

WCDMA HSDPA

The following tests were conducted according to the test requirements outlines in section 5.2 of the 3GPP TS34.121-1 specification.

	Mode	HSDPA	HSDPA	HSDPA	HSDPA
	Subset	1	2	3	4
WCDMA General Set ings	Loopback Mode	Test Mode 1			
	Rel99 RMC	12.2kbps RMC			
	HSDPA FRC	H-Set1			
	Power Control Algorithm	Algorithm2			
	β_c	2/15	12/15	15/15	15/15
	β_d	1 /15	15/15	8/15	4/15
	β_d (SF)	64			
	β_c/β_d	2/15	12/15	15/8	15/4
	β_{hs}	4/15	24/15	30/15	30/15
MPR(dB)	0	0	0.5	0.5	
HSDPA Specific Settings	DACK	8			
	DNAK	8			
	DCQI	8			
	Ack-Nack repetition factor	3			
	CQI Feedback	4ms			
	CQI Repetition Factor	2			
	Ahs= β_{hs}/β_c	30/15			

HSPA+

The following tests were conducted according to the test requirements in Table C.11.1.4 of 3GPP TS 34.121-1

Sub-test	β_c (Note3)	β_d	β_{hs} (Note1)	β_{ec}	β_{ed} (2xSF2) (Note 4)	β_{ed} (2xSF4) (Note 4)	CM (dB) (Note 2)	MPR (dB) (Note 2)	AG Index (Note 4)	E-TFCI (Note 5)	E-TFCI (boost)
1	1	0	30/15	30/15	β_{ed1} : 30/15 β_{ed2} : 30/15	β_{ed3} : 24/15 β_{ed4} : 24/15	3.5	2.5	14	105	105

- Note 1: $\Delta_{ACK}, \Delta_{NACK}$ and $\Delta_{CQI} = 30/15$ with $\beta_{hs} = 30/15 * \beta_c$.
- Note 2: CM = 3.5 and the MPR is based on the relative CM difference, MPR = MAX(CM-1,0).
- Note 3: DPDCH is not configured, therefore the β_c is set to 1 and $\beta_d = 0$ by default.
- Note 4: β_{ed} can not be set directly; it is set by Absolute Grant Value.
- Note 5: All the sub-tests require the UE to transmit 2SF2+2SF4 16QAM EDCH and they apply for UE using E-DPDCH category 7. E-DCH TTI is set to 2ms TTI and E-DCH table index = 2. To support these E-DCH configurations DPDCH is not allocated. The UE is signalled to use the extrapolation algorithm.

WCDMA HSUPA

The following tests were conducted according to the test requirements outlines in section 5.2 of the 3GPP TS34.121-1 specification.

	Mode	HSUPA	HSUPA	HSUPA	HSUPA	HSUPA
	Subset	1	2	4	5	
WCDMA General Settings	Loopback Mode	Test Mode 1				
	Rel99 RMC	12.2kbps RMC				
	HSDPA FRC	H-Set1				
	HSUPA Test	HSUPA Loopback				
	Power Control Algorithm	Algorithm2				
	β_c	11/15	6/15	15/15	2/15	15/15
	β_d	15/15	15/15	9/15	15/15	0
	β_{ec}	209/225	12/15	30 15	2/15	5/15
	β_c/β_d	11/15	6/15	15/9	2/15	-
	β_{hs}	22/15	12/15	30/15	4/15	5/15
	CM(dB)	1.0	3.0	2.0	3.0	1.0
MPR(dB)	0	2	1	2	0	
HSDPA Specific Settings	DACK	8				
	DNAK	8				
	DCQI	8				
	Ack-Nack repetition factor	3				
	CQI Feedback	4ms				
	CQI Repetition Factor	2				
	$A_{hs}=\beta_{hs}/\beta_c$	30/15				
HSUPA Specific Settings	DE-DPCCH	6	8	8	5	7
	DHARQ	0	0	0	0	0
	AG Index	20	12	15	17	21
	ETFCI	75	67	92	71	81
	Associated Max UL Data Rate k ps	242.1	174.9	482.8	205.8	308.9
	Reference E_FCIs	E-TFCI 11 E E-TFCI PO 4 E-TFCI 67 E-TFCI PO 18 E-TFCI 71 E-TFCI PO23 E-TFCI 75 E-TFCI PO26 E-TFCI 81 E-TFCI PO 27	E-TFCI 11 E-TFCI PO4 E-TFCI 92 E-TFCI PO 18	E-TFCI 11 E E-TFCI PO 4 E-TFCI 67 E-TFCI PO 18 E-TFCI 71 E-TFCI PO23 E-TFCI 75 E-TFCI PO26 E-TFCI 81 E-TFCI PO 27		

LTE (FDD):

The following tests were conducted according to the test requirements in 3GPP TS36.101

The following tests were conducted according to the test requirements outlined in section 6.2 of the 3GPP TS36.101 specification.

UE Power Class: 3 (23 +/- 2dBm). The allowed Maximum Power Reduction (MPR) for the maximum output power due to higher order modulation and transmit bandwidth configuration (resource blocks) is specified in Table 6.2.3-1 of the 3GPP TS36.101.

Table 6.2.3-1: Maximum Power Reduction (MPR) for Power Class 3

Modulation	Channel bandwidth / Transmission bandwidth (RB)						MPR (dB)
	1.4 MHz	3.0 MHz	5 MHz	10 MHz	15 MHz	20 MHz	
QPSK	> 5	> 4	> 8	> 12	> 16	> 18	≤ 1
16 QAM	≤ 5	≤ 4	≤ 8	≤ 12	≤ 16	≤ 18	≤ 1
16 QAM	> 5	> 4	> 8	> 12	> 16	> 18	≤ 2

The allowed A-MPR values specified below in Table 6.2.4.-1 of 3GPP TS36.101 are in addition to the allowed MPR requirements. All the measurements below were performed with A-MPR disabled, by using Network Signaling Value of "NS_01".

Table 6.2.4-1: Additional Maximum Power Reduction (A-MPR)

Network Signalling value	Requirements (sub-clause)	E-UTRA Band	Channel bandwidth (MHz)	Resources Blocks (N_{RB})	A-MPR (dB)
NS_01	6.6.2.1.1	Table 5.5-1	1.4, 3, 5, 10, 15, 20	Table 5.6-1	NA
NS_03	6.6.2.2.1	2, 4, 10, 23, 25, 35, 36	3	>5	≤ 1
			5	>6	≤ 1
			10	>6	≤ 1
			15	>8	≤ 1
NS_04	6.6.2.2.2	41	20	>10	≤ 1
			5	>6	≤ 1
NS_05	6.6.3.3.1	1	10, 15, 20	≥ 50	≤ 1
NS_06	6.6.2.2.3	12, 13, 14, 17	1.4, 3, 5, 10	Table 5.6-1	n/a
NS_07	6.6.2.2.3	13	10	Table 6.2.4-2	Table 6.2.4-2
	6.6.3.3.2				
NS_08	6.6.3.3.3	19	10, 15	> 44	≤ 3
NS_09	6.6.3.3.4	21	10, 15	> 40	≤ 1
				> 55	≤ 2
NS_10		20	15, 20	Table 6.2.4-3	Table 6.2.4-3
NS_11	6.6.2.2.1	23 ¹	1.4, 3, 5, 10	Table 6.2.4-5	Table 6.2.4-5
..					
NS_32	-	-	-	-	-

Note 1: Applies to the lower block of Band 23, i.e. a carrier placed in the 2000-2010 MHz region.

TDD-LTE

P TS 36.211 section 4.2 for Type 2 Frame Structure and Table 4.2-2 for uplink-downlink configurations and Table 4.2-1 for Special subframe configurations.

Table 4.2-1: Configuration of special subframe (lengths of DwPTS/GP/UpPTS).

Special subframe configuration	Normal cyclic prefix in downlink			Extended cyclic prefix in downlink		
	DwPTS	UpPTS		DwPTS	UpPTS	
		Normal cyclic prefix in uplink	Extended cyclic prefix in uplink		Normal cyclic prefix in uplink	Extended cyclic prefix in uplink
0	$6592 \cdot T_s$	$2192 \cdot T_s$	$2560 \cdot T_s$	$7680 \cdot T_s$	$2192 \cdot T_s$	$2560 \cdot T_s$
1	$19760 \cdot T_s$			$20480 \cdot T_s$		
2	$21952 \cdot T_s$			$23040 \cdot T_s$		
3	$24144 \cdot T_s$			$25600 \cdot T_s$		
4	$26336 \cdot T_s$			$7680 \cdot T_s$		
5	$6592 \cdot T_s$	$4384 \cdot T_s$	$5120 \cdot T_s$	$20480 \cdot T_s$	$4384 \cdot T_s$	$5120 \cdot T_s$
6	$19760 \cdot T_s$			$23040 \cdot T_s$		
7	$21952 \cdot T_s$			$12800 \cdot T_s$		
8	$24144 \cdot T_s$			-		
9	$13168 \cdot T_s$			-		

Table 4.2-2: Uplink-downlink configurations.

Uplink-downlink configuration	Downlink-to-Uplink Switch-point periodicity	Subframe number									
		0	1	2	3	4	5	6	7	8	9
0	5 ms	D	S	U	U	U	D	S	U	U	U
1	5 ms	D	S	U	U	D	D	S	U	U	D
2	5 ms	D	S	U	D	D	D	S	U	D	D
3	10 ms	D	S	U	U	U	D	D	D	D	D
4	10 ms	D	S	U	U	D	D	D	D	D	D
5	10 ms	D	S	U	D	D	D	D	D	D	D
6	5 ms	D	S	U	U	U	D	S	U	U	D

Calculated Duty Cycle

Uplink-Downlink Configuration	Downlink-to-Uplink Switch-point Periodicity	Subframe Number										Calculated Duty Cycle (%)
		0	1	2	3	4	5	6	7	8	9	
0	5 ms	D	S	U	U	U	D	S	U	U	U	63.33
1	5 ms	D	S	U	U	D	D	S	U	U	D	43.33
2	5 ms	D	S	U	D	D	D	S	U	D	D	23.33
3	10 ms	D	S	U	U	U	D	D	D	D	D	31.67
4	10 ms	D	S	U	U	D	D	D	D	D	D	21.67
5	10 ms	D	S	U	D	D	D	D	D	D	D	11.67
6	5 ms	D	S	U	U	U	D	S	U	U	D	53.33

We used configuration 0 for LTE Band 41 SAR test, that is 63.33%(1:1.58)for duty cycle.

Maximum Target Output Power

Max Target Power(dBm)			
Mode/Band	Channel		
	Low	Middle	High
GSM 850	33.0	33.0	33.0
GPRS 1 TX Slot	33.0	33.0	33.0
GPRS 2 TX Slot	31.0	31.0	31.0
GPRS 3 TX Slot	29.0	29.0	29.0
GPRS 4 TX Slot	27.2	27.2	27.2
EGPRS 1 TX Slot	26.5	26.5	26.5
EGPRS 2 TX Slot	25.0	25.0	25.0
EGPRS 3 TX Slot	23.0	23.0	23.0
EGPRS 4 TX Slot	21.0	21.0	21.0
PCS 1900	29.8	29.8	29.8
GPRS 1 TX Slot	30.0	30.0	30.0
GPRS 2 TX Slot	27.6	27.6	27.6
GPRS 3 TX Slot	26.0	26.0	26.0
GPRS 4 TX Slot	24.0	24.0	24.0
EGPRS 1 TX Slot	27.0	27.0	27.0
EGPRS 2 TX Slot	25.5	25.5	25.5
EGPRS 3 TX Slot	23.3	23.3	23.3
EGPRS 4 TX Slot	21.0	21.0	21.0
WCDMA Band 2	24.0	24.0	24.0
HSDPA	22.2	22.2	22.2
HSUPA Subtest 1	21.5	21.5	21.5
HSUPA Subtest 2	22.5	22.5	22.5
HSUPA Subtest 3	21.5	24.0	23.5
HSUPA Subtest 4	22.0	22.0	22.0
HSUPA Subtest 5	22.5	22.5	22.5
HSPA+	22.0	22.0	22.0
WCDMA Band 5	24.0	24.0	24.0
HSDPA	22.5	22.5	22.5
HSUPA	22.5	22.5	22.5
HSPA+	22.5	22.5	22.5
LTE Band 2	21.8	21.8	21.8
LTE Band 5	23.0	23.0	23.0
LTE Band 12	22.2	22.2	22.2
LTE Band 13	21.0	23.5	23.5
LTE Band 41	21.3	21.3	21.3

Max Target Power(dBm)			
Mode/Band	Channel		
	Low	Middle	High
WLAN 2.4G 802.11b	7.5	7.5	7.5
WLAN 2.4G 802.11g	8.4	8.4	8.4
WLAN 2.4G 802.11n20	8.4	8.4	8.4
WLAN 2.4G 802.11n40	7.5	7.5	7.5
WLAN 5.2G 802.11a	8.8	8.8	8.8
WLAN 5.2G 802.11n20	8.7	8.7	8.7
WLAN 5.2G 802.11n40	8.7	/	8.7
WLAN 5.2G 802.11ac20	8.7	8.7	8.7
WLAN 5.2G 802.11ac40	8.7	/	8.7
WLAN 5.8G 802.11a	9.3	9.3	9.3
WLAN 5.8G 802.11n20	9.0	9.0	9.0
WLAN 5.8G 802.11n40	9.0	/	9.0
WLAN 5.8G 802.11ac20	9.0	9.0	9.0
WLAN 5.8G 802.11ac40	9.0	/	9.0
BDR(GFSK)	0.5	0.5	0.5
EDR($\pi/4$ -DQPSK)	0.5	0.5	0.5
EDR(8DPSK)	0.5	0.5	0.5
BLE 1M	1.5	1.5	1.5
BLE 2M	1.2	1.2	1.2

Note: The Maximum Target Power for LTE bands corresponds to their maximum power in QPSK modes with maximum bandwidth.

Test Results

GSM:

Band	Channel No.	Frequency (MHz)	RF Output Power (dBm)
GSM 850	128	824.2	32.90
	190	836.6	32.92
	251	848.8	32.85
PCS 1900	512	1850.2	29.61
	661	1880	29.67
	810	1909.8	29.59

GPRS:

Band	Channel No.	Frequency (MHz)	RF Output Power (dBm)			
			1 slot	2 slots	3 slots	4 slots
GSM 850	128	824.2	32.85	30.79	28.77	26.83
	190	836.6	32.87	30.87	28.89	27.02
	251	848.8	32.86	30.83	28.95	27.04
PCS 1900	512	1850.2	29.53	27.44	25.84	23.85
	661	1880	29.85	27.47	25.88	23.74
	810	1909.8	29.83	27.11	25.39	23.51

EGPRS:

Band	Channel No.	Frequency (MHz)	RF Output Power (dBm)			
			1 slot	2 slots	3 slots	4 slots
GSM 850	128	824.2	25.90	24.57	22.38	20.11
	190	836.6	26.35	24.90	22.58	20.54
	251	848.8	26.04	24.68	22.16	20.22
PCS 1900	512	1850.2	26.51	25.24	22.77	20.51
	661	1880	26.58	25.25	23.07	20.65
	810	1909.8	26.32	25.05	23.02	20.62

For SAR, the time based average power is relevant, the difference in between depends on the duty cycle of the TDMA signal.

Number of Time slot	1	2	3	4
Duty Cycle	1:8	1:4	1:2.66	1:2
Time based Ave. power compared to slotted Ave. power	-9 dB	-6 dB	-4.25 dB	-3 dB
Crest Factor	8	4	2.66	2

The time based average power for GSM

Band	Channel No.	Frequency (MHz)	RF Output Power (dBm)
EGSM 900	975	880.2	23.90
	60	902.0	23.92
	124	914.8	23.85
GSM 1800	513	1710.4	20.61
	700	1747.8	20.67
	884	1784.6	20.59

The time based average power for GPRS

Band	Channel No.	Frequency (MHz)	Time based average Power (dBm)			
			1 slot	2 slot	3 slots	4 slots
GSM 850	128	824.2	23.85	24.79	24.52	23.83
	190	836.6	23.87	24.87	24.64	24.02
	251	848.8	23.86	24.83	24.70	24.04
PCS 1900	512	1850.2	20.53	21.44	21.59	20.85
	661	1880	20.85	21.47	21.63	20.74
	810	1909.8	20.83	21.11	21.14	20.51

The time based average power for EGPRS

Band	Channel No.	Frequency (MHz)	Time based average Power (dBm)			
			1 slot	2 slot	3 slots	4 slots
GSM 850	128	824.2	16.90	18.57	18.13	17.11
	190	836.6	17.35	18.90	18.33	17.54
	251	848.8	17.04	18.68	17.91	17.22
PCS 1900	512	1850.2	17.51	19.24	18.52	17.51
	661	1880	17.58	19.25	18.82	17.65
	810	1909.8	17.32	19.05	18.77	17.62

Note:

1. Rohde & Schwarz Radio Communication Tester (CMW500) was used for the measurement of GSM peak and average output power for active timeslots.
- 2 .For GSM voice, 1 timeslot has been activated with power level 5 (850 MHz band) and 0 (1900 MHz band).
- 3 .For GPRS, 1, 2, 3 and 4timeslots has been activated separately with power level 3(850 MHz band) and 3(1900 MHz band).

WCDMA:**WCDMA Band 2:**

Test Mode	Conducted Average Output Power(dBm)		
	Lowest Channel	Middle Channel	Highest Channel
WCDMA R99	23.77	23.73	23.79
HSDPA Subtest 1	21.73	21.55	21.21
HSDPA Subtest 2	21.57	21.67	22.04
HSDPA Subtest 3	21.57	21.76	22.05
HSDPA Subtest 4	21.57	21.61	20.38
HSUPA Subtest 1	20.68	21.33	21.36
HSUPA Subtest 2	21.17	21.42	22.04
HSUPA Subtest 3	21.45	23.67	23.10
HSUPA Subtest 4	21.43	21.37	21.56
HSUPA Subtest 5	21.56	22.06	21.58
HSPA+ Subtest 1	21.37	21.87	21.66

WCDMA Band 5:

Test Mode	Conducted Average Output Power(dBm)		
	Lowest Channel	Middle Channel	Highest Channel
WCDMA R99	23.57	23.63	23.59
HSDPA Subtest 1	22.12	22.12	22.19
HSDPA Subtest 2	21.92	22.11	22.27
HSDPA Subtest 3	22.09	22.18	22.25
HSDPA Subtest 4	21.86	22.35	22.17
HSUPA Subtest 1	22.15	22.15	22.09
HSUPA Subtest 2	22.11	21.99	22.07
HSUPA Subtest 3	22.07	22.16	21.36
HSUPA Subtest 4	22.09	22.08	22.01
HSUPA Subtest 5	21.81	22.28	21.84
HSPA+ Subtest 1	22.08	22.13	21.94

Note:

1. The default test configuration is to measure SAR with an established radio link between the EUT and a communication test set using a 12.2 kbps RMC (reference measurement Channel) Configured in Test Loop Model 1.
2. KDB 941225 D01-Body SAR is not required for HSDPA/HSUPA /HSPA+ when the maximum average output of each RF channel is less than ¼ dB higher than measured 12.2kbps RMC or the maximum SAR for 12.2kbps RMC is < 75% of SAR limit.

**LTE Band
Band 2:**

Test Bandwidth & Modulation	Resource Block & RB offset	Conducted Average Output Power(dBm)		
		Lowest Channel	Middle Channel	Highest Channel
1.4MHz QPSK	RB1#0	21.35	21.60	21.63
	RB1#3	21.43	21.47	21.48
	RB1#5	21.37	21.43	21.49
	RB3#0	21.46	21.48	21.57
	RB3#1	21.37	21.38	21.56
	RB3#3	21.48	21.50	21.59
	RB6#0	21.42	21.40	21.55
1.4MHz 16QAM	RB1#0	21.39	21.57	21.46
	RB1#3	21.47	21.60	21.42
	RB1#5	21.54	21.48	21.58
	RB3#0	21.52	21.59	21.60
	RB3#1	21.47	21.55	21.58
	RB3#3	21.45	21.59	21.54
	RB6#0	21.48	21.48	21.57
3MHz QPSK	RB1#0	21.43	21.49	21.49
	RB1#14	21.48	21.45	21.59
	RB1#8	21.35	21.44	21.51
	RB15#0	21.36	21.47	21.52
	RB8#0	21.46	21.50	21.56
	RB8#4	21.35	21.58	21.46
	RB8#7	21.44	21.46	21.54
3MHz 16QAM	RB1#0	21.44	21.57	21.67
	RB1#14	21.45	21.47	21.57
	RB1#8	21.50	21.56	21.52
	RB15#0	21.52	21.59	21.51
	RB8#0	21.48	21.54	21.63
	RB8#4	21.48	21.57	21.57
	RB8#7	21.45	21.45	21.55
5MHz QPSK	RB1#0	21.44	21.46	21.64
	RB1#12	21.42	21.45	21.59
	RB1#24	21.42	21.43	21.60
	RB12#0	21.42	21.43	21.45
	RB12#13	21.42	21.40	21.56
	RB12#7	21.49	21.40	21.52
	RB25#0	21.41	21.42	21.58
5MHz 16QAM	RB1#0	21.42	21.38	21.43
	RB1#12	21.41	21.31	21.42
	RB1#24	21.41	21.30	21.46
	RB12#0	21.46	21.33	21.53

		RB12#13	21.48	21.52	21.47
		RB12#7	21.51	21.48	21.63
		RB25#0	21.47	21.44	21.54
10MHz QPSK		RB1#0	21.46	21.37	21.47
		RB1#25	21.45	21.52	21.68
		RB1#49	21.37	21.52	21.63
		RB25#0	21.39	21.58	21.58
		RB25#12	21.32	21.45	21.60
		RB25#25	21.38	21.49	21.55
		RB50#0	21.33	21.58	21.65
10MHz 16QAM		RB1#0	21.42	21.46	21.67
		RB1#25	21.33	21.53	21.60
		RB1#49	21.43	21.52	21.63
		RB25#12	21.49	21.54	21.67
		RB25#25	21.36	21.47	21.63
		RB50#0	21.36	21.48	21.51
15MHz QPSK		RB1#0	21.45	21.46	21.56
		RB1#37	21.41	21.56	21.65
		RB1#74	21.48	21.48	21.62
		RB36#0	21.42	21.57	21.62
		RB36#20	21.47	21.60	21.59
		RB36#39	21.36	21.55	21.66
		RB75#0	21.57	21.53	21.72
15MHz 16QAM		RB1#0	21.48	21.42	21.63
		RB1#37	21.45	21.48	21.65
		RB1#74	21.61	21.56	21.67
		RB36#0	21.46	21.44	21.72
		RB36#20	21.34	21.49	21.60
		RB36#39	21.49	21.56	21.57
		RB75#0	21.45	21.49	21.63
20MHz QPSK		RB1#0	21.39	21.48	21.54
		RB1#49	21.37	21.45	21.49
		RB1#99	21.34	21.46	21.49
		RB100#0	21.49	21.40	21.42
		RB50#0	21.37	21.40	21.40
		RB50#24	21.35	21.37	21.45
		RB50#50	21.40	21.36	21.41
20MHz 16QAM		RB1#0	21.34	21.39	21.40
		RB1#49	21.42	21.49	21.55
		RB1#99	21.43	21.34	21.53
		RB100#0	21.39	21.53	21.53
		RB50#0	21.50	21.39	21.44
		RB50#24	21.49	21.48	21.53
		RB50#50	21.48	21.51	21.40

Band 5:

Test Bandwidth & Modulation	Resource Block & RB offset	Conducted Average Output Power(dBm)		
		Lowest Channel	Middle Channel	Highest Channel
1.4MHz QPSK	RB1#0	22.69	22.81	22.64
	RB1#3	22.78	22.73	22.71
	RB1#5	22.75	22.78	22.73
	RB3#0	22.72	22.74	22.65
	RB3#1	22.75	22.74	22.61
	RB3#3	22.67	22.83	22.58
	RB6#0	22.84	22.74	22.69
1.4MHz 16QAM	RB1#0	22.83	22.81	22.71
	RB1#3	22.79	22.81	22.74
	RB1#5	22.77	22.76	22.67
	RB3#0	22.78	22.86	22.67
	RB3#1	22.70	22.89	22.75
	RB3#3	22.78	22.95	22.56
	RB6#0	22.75	22.86	22.76
3MHz QPSK	RB1#0	22.92	22.73	22.69
	RB1#14	22.90	22.70	22.75
	RB1#8	22.78	22.78	22.84
	RB15#0	22.80	22.78	22.69
	RB8#0	22.88	22.73	22.81
	RB8#4	22.91	22.71	22.70
	RB8#7	22.83	22.72	22.68
3MHz 16QAM	RB1#0	22.80	22.71	22.81
	RB1#14	22.81	22.69	22.77
	RB1#8	22.81	22.79	22.69
	RB15#0	22.88	22.66	22.69
	RB8#0	22.77	22.81	22.70
	RB8#4	22.83	22.67	22.81
	RB8#7	22.88	22.71	22.66
5MHz QPSK	RB1#0	22.81	22.77	22.78
	RB1#12	22.83	22.77	22.86
	RB1#24	22.86	22.81	22.90
	RB12#0	22.89	22.71	22.88
	RB12#13	22.83	22.75	22.84
	RB12#7	22.91	22.76	22.81
	RB25#0	22.82	22.73	22.80
5MHz 16QAM	RB1#0	22.80	22.72	22.79
	RB1#12	22.88	22.88	22.90
	RB1#24	22.87	22.76	22.75
	RB12#0	22.90	22.91	22.81

	RB12#13	22.90	22.89	22.81
	RB12#7	22.83	22.87	22.90
	RB25#0	22.74	22.84	22.88
10MHz QPSK	RB1#0	22.93	22.83	22.90
	RB1#25	22.89	22.81	22.89
	RB1#49	22.91	22.79	22.88
	RB25#0	22.83	22.74	22.83
	RB25#12	22.82	22.76	22.86
	RB25#25	22.86	22.75	22.84
	RB50#0	22.85	22.72	22.78
10MHz 16QAM	RB1#0	22.90	22.79	22.93
	RB1#25	22.85	22.79	22.85
	RB1#49	22.96	22.73	22.87
	RB25#0	22.87	22.72	22.87
	RB25#25	22.89	22.79	22.84
	RB50#0	22.88	22.79	22.82

Band 12:

Test Bandwidth & Modulation	Resource Block & RB offset	Conducted Average Output Power(dBm)		
		Lowest Channel	Middle Channel	Highest Channel
1.4MHz QPSK	RB1#0	21.30	21.21	21.35
	RB1#3	21.30	21.07	21.13
	RB1#5	21.42	21.08	21.02
	RB3#0	21.39	20.99	21.15
	RB3#1	21.30	20.91	22.00
	RB3#3	21.26	21.12	22.03
	RB6#0	21.35	20.37	20.94
1.4MHz 16QAM	RB1#0	21.35	21.26	21.64
	RB1#3	21.58	21.10	21.49
	RB1#5	21.50	20.91	22.11
	RB3#0	19.80	20.11	20.84
	RB3#1	19.82	20.22	21.04
	RB3#3	19.31	20.02	21.15
	RB6#0	18.65	18.99	19.77
3MHz QPSK	RB1#0	21.33	21.86	20.91
	RB1#14	21.88	21.97	21.57
	RB1#8	22.05	20.75	20.49
	RB15#0	20.75	19.72	19.60
	RB8#0	20.92	19.79	19.34
	RB8#4	20.00	19.62	19.32
	RB8#7	20.98	19.59	19.30
3MHz 16QAM	RB1#0	21.51	20.44	20.52
	RB1#14	21.52	21.38	20.43
	RB1#8	22.13	20.29	20.53
	RB15#0	19.89	18.68	18.62
	RB8#0	20.17	18.45	18.15
	RB8#4	19.97	18.29	19.62
	RB8#7	20.50	18.09	19.34
5MHz QPSK	RB1#0	21.01	21.44	20.34
	RB1#12	20.58	20.42	20.18
	RB1#24	20.68	20.29	19.93
	RB12#0	19.22	19.30	18.79
	RB12#13	19.22	19.33	18.87
	RB12#7	19.35	19.11	18.86
	RB25#0	19.30	18.66	18.76
5MHz 16QAM	RB1#0	19.66	19.57	18.97
	RB1#12	19.78	19.29	19.12
	RB1#24	21.04	19.71	19.18

	RB12#0	18.60	17.90	17.58
	RB12#13	20.25	17.67	17.89
	RB12#7	20.16	17.66	17.99
	RB25#0	20.41	17.87	18.07
10MHz QPSK	RB1#0	20.14	20.39	20.41
	RB1#25	19.97	20.25	20.33
	RB1#49	19.99	20.38	20.26
	RB25#0	18.63	19.04	18.93
	RB25#12	18.68	19.17	18.96
	RB25#25	18.81	19.02	19.02
	RB50#0	18.67	19.10	18.84
10MHz 16QAM	RB1#0	19.46	19.78	19.99
	RB1#25	19.80	19.54	19.97
	RB1#49	20.30	19.49	21.86
	RB25#0	18.75	18.03	19.72
	RB25#25	18.18	17.97	19.86
	RB50#0	18.40	17.88	19.71

Band 13:

Test Bandwidth & Modulation	Resource Block & RB offset	Conducted Average Output Power(dBm)		
		Lowest Channel	Middle Channel	Highest Channel
5MHz QPSK	RB1#0	20.76	/	23.03
	RB1#13	20.89	/	22.88
	RB1#24	20.92	/	22.98
	RB12#0	20.45	/	22.95
	RB12#13	20.55	/	22.92
	RB12#7	20.65	/	22.92
	RB25#0	20.62	/	22.87
5MHz 16QAM	RB1#0	20.56	/	22.96
	RB1#13	20.99	/	22.91
	RB1#24	20.98	/	22.90
	RB12#0	19.60	/	22.88
	RB12#13	19.50	/	22.96
	RB12#7	20.90	/	22.92
	RB25#0	20.93	/	22.91
10MHz QPSK	RB1#0	/	22.98	/
	RB1#25	/	23.03	/
	RB1#49	/	23.08	/
	RB25#0	/	23.03	/
	RB25#12	/	23.05	/
	RB25#25	/	23.02	/
	RB50#0	/	23.01	/
10MHz 16QAM	RB1#0	/	23.04	/
	RB1#25	/	23.05	/
	RB1#49	/	23.05	/
	RB25#12	/	22.96	/
	RB25#25	/	23.03	/
	RB50#0	/	23.06	/

Band 41:

Test Bandwidth & Modulation	Resource Block & RB offset	Conducted Average Output Power(dBm)				
		Lowest Channel	Low-Mid Channel (2549.5MHz)	Middle Channel	Mid-High Channel (2636.5MHz)	Highest Channel
5MHz QPSK	RB1#0	20.94	20.97	21.02	20.15	20.04
	RB1#13	20.89	20.96	21.00	20.03	20.12
	RB1#24	20.99	20.85	21.07	20.16	20.17
	RB12#0	20.88	20.90	21.12	20.05	20.15
	RB12#13	20.97	20.87	21.11	20.06	20.18
	RB12#7	20.98	20.86	21.23	20.09	20.19
	RB25#0	20.94	20.95	21.23	20.02	20.17
5MHz 16QAM	RB1#0	20.91	20.90	21.13	20.08	20.17
	RB1#13	20.92	20.91	21.19	20.08	20.08
	RB1#24	20.92	20.91	21.14	20.05	20.05
	RB12#0	20.93	20.90	21.14	20.07	20.11
	RB12#13	20.96	20.89	21.20	20.05	20.21
	RB12#7	20.99	21.02	21.18	20.20	20.16
	RB25#0	20.91	21.01	21.18	20.15	20.15
10MHz QPSK	RB1#0	20.54	20.52	20.80	19.92	19.78
	RB1#25	20.53	20.67	20.75	19.84	19.94
	RB1#49	20.62	20.57	20.78	19.80	19.81
	RB25#0	20.59	20.50	20.70	19.92	19.84
	RB25#12	20.49	20.60	20.77	19.84	19.82
	RB25#25	20.49	20.47	20.71	19.89	19.81
	RB50#0	20.54	20.57	20.71	19.91	19.83
10MHz 16QAM	RB1#0	20.59	20.51	20.69	19.80	19.81
	RB1#25	20.50	20.48	20.72	19.85	19.83
	RB1#49	20.49	20.45	20.69	19.90	19.83
	RB25#12	20.58	20.49	20.78	19.80	19.82
	RB25#25	20.55	20.49	20.78	19.83	19.95
	RB50#0	20.58	20.44	20.84	19.95	19.93
15MHz QPSK	RB1#0	20.58	20.56	20.80	19.79	19.79
	RB1#37	20.71	20.72	20.81	19.74	19.74
	RB1#74	20.67	20.66	20.82	19.82	19.89
	RB36#0	20.59	20.57	20.75	19.83	19.86
	RB36#20	20.54	20.62	20.69	19.77	19.83
	RB36#39	20.59	20.56	20.84	19.77	19.91
	RB75#0	20.58	20.66	20.74	19.91	19.79
15MHz 16QAM	RB1#0	20.59	20.52	20.68	19.90	19.90
	RB1#37	20.61	20.58	20.72	19.80	19.81
	RB1#74	20.68	20.57	20.70	19.91	19.77
	RB36#0	20.53	20.64	20.67	19.86	19.86

	RB36#20	20.60	20.51	20.70	19.86	19.91
	RB36#39	20.59	20.63	20.76	19.77	19.89
	RB75#0	20.63	20.61	20.77	19.77	19.91
20MHz QPSK	RB1#0	20.65	20.69	20.85	20.06	20.08
	RB1#49	20.56	20.62	20.82	20.03	19.89
	RB1#99	20.58	20.51	20.81	19.95	20.03
	RB100#0	20.49	20.62	20.75	20.01	19.91
	RB50#0	20.61	20.63	20.78	20.03	19.93
	RB50#24	20.60	20.50	20.73	19.97	19.90
	RB50#50	20.53	20.61	20.72	19.99	19.92
20MHz 16QAM	RB1#0	20.55	20.55	20.80	20.01	19.94
	RB1#49	20.52	20.50	20.83	20.02	20.06
	RB1#99	20.54	20.54	20.78	20.02	19.92
	RB100#0	20.56	20.51	20.74	19.99	20.01
	RB50#0	20.55	20.57	20.74	19.97	19.91
	RB50#24	20.54	20.53	20.78	19.92	19.96
	RB50#50	20.53	20.48	20.76	19.98	20.00

WLAN 2.4G:

Mode	Channel frequency (MHz)	Data Rate	Duty Cycle [%]	RF Average Output Power (dBm)
802.11b	2412	1Mbps	100	5.85
	2437			7.20
	2462			6.25
802.11g	2412	6Mbps	100	6.55
	2437			8.11
	2462			7.55
802.11 n20	2412	MCS0	100	6.41
	2437			8.21
	2462			7.27
802.11 n40	2422	MCS0	100	5.56
	2437			7.42
	2452			6.12

Note: Duty cycle was from the Radio report.

WLAN 5.2G:

Mode	Channel frequency (MHz)	Data Rate	Duty Cycle [%]	RF Average Output Power (dBm)
802.11a	5180	1Mbps	100	8.37
	5200			8.31
	5240			8.60
802.11n20	5180	MCS0	100	8.34
	5200			8.38
	5240			8.48
802.11 n40	5190	MCS0	100	8.36
	5230			8.51
802.11 ac20	5180	MCS0	100	8.35
	5200			8.43
	5240			8.42
802.11 ac40	5190	MCS0	100	8.47
	5230			8.51

Note: Duty cycle was from the Radio report.

WLAN 5.8G:

Mode	Channel frequency (MHz)	Data Rate	Duty Cycle [%]	RF Average Output Power (dBm)
802.11a	5745	1Mbps	100	9.02
	5785			8.24
	5825			7.64
802.11n20	5745	MCS0	100	8.89
	5785			8.19
	5825			7.68
802.11 n40	5755	MCS0	100	8.54
	5795			7.57
802.11 ac20	5745	MCS0	100	8.79
	5785			8.21
	5825			7.64
802.11 ac40	5755	MCS0	100	8.52
	5795			7.50

Note: Duty cycle was from the Radio report.

Bluetooth:

Mode	Channel frequency (MHz)	Duty cycle (%)	RF Conducted Output Power (dBm)
BDR(GFSK)	2402	/	0.21
	2441		-0.30
	2480		-0.98
EDR($\pi/4$ -DQPSK)	2402		-0.15
	2441		0.22
	2480		-1.01
EDR(8DPSK)	2402		-0.08
	2441		0.09
	2480		-0.88
BLE 1M	2402	87.11	1.06
	2440	87.24	1.22
	2480	87.06	0.88
BLE 2M	2402	65.75	0.96
	2440	65.78	1.09
	2480	65.83	0.79

Note: Duty cycle was from the Radio report.

STANDALONE SAR TEST EXCLUSION CONSIDERATIONS

Antennas Location:

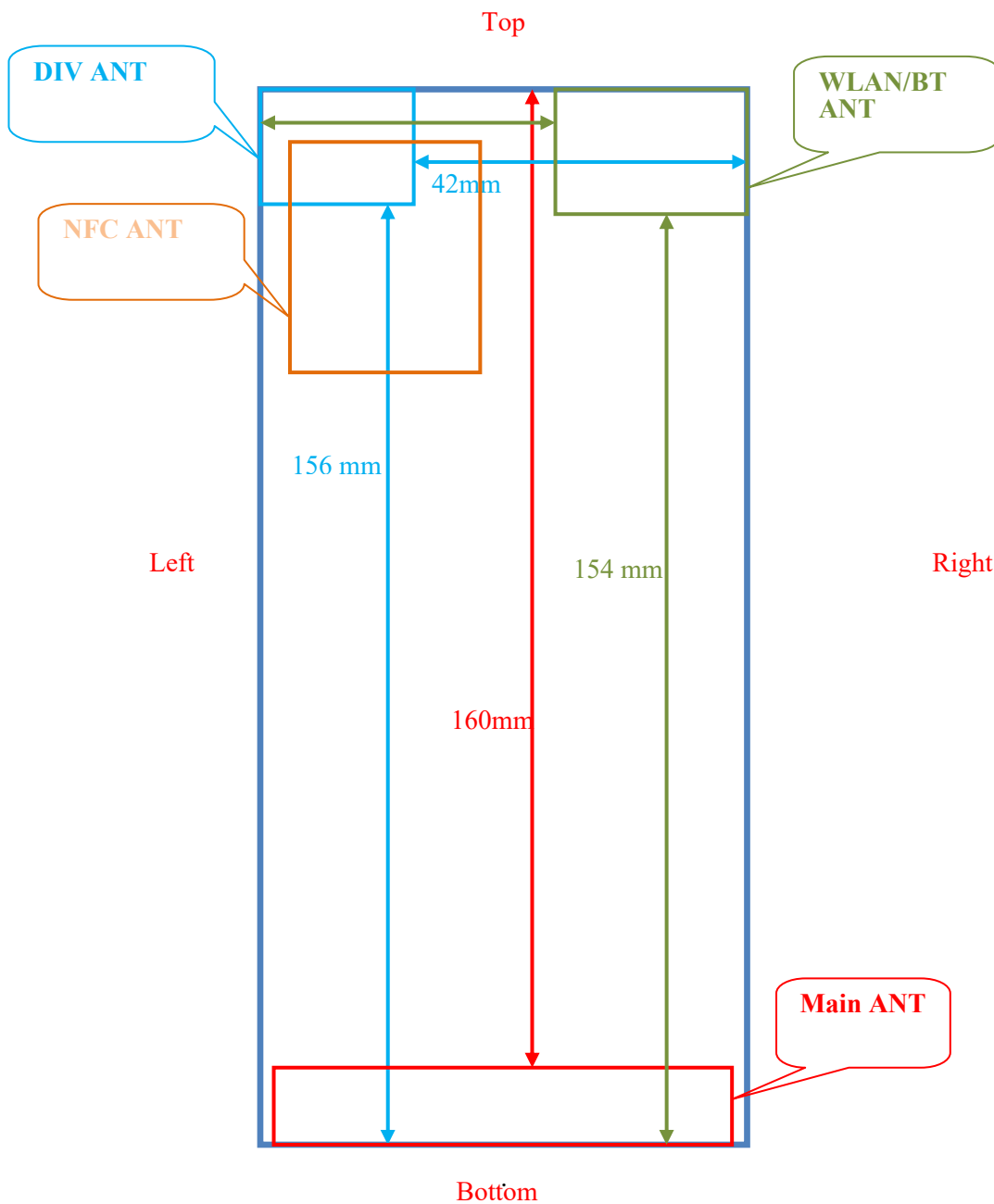

EUT Front View

Antenna	Description
MAIN	GSM 850, WCDMA B5, LTE B5/12/13
DIV	PCS 1900, WCDMA B2, LTE B2/41
WLAN/BT	WLAN 2.4G/5.2G/5.8G, Bluetooth/BLE
NFC	NFC

Note: The above statistics only include antennas with transmitting

Antenna Distance To Edge (TRX)

Antenna Distance To Edge(mm)						
Antenna	Back	Front	Left	Right	Top	Bottom
MAIN	< 5	< 5	< 5	< 5	160	< 5
DIV	< 5	< 5	< 5	42	< 5	156
WLAN	< 5	< 5	35	< 5	< 5	154

SAR test exclusion for the EUT edge considerations Result

Expand Use Mode:

Antenna	Back	Front	Left	Right	Top	Bottom
MAIN	Required	Required	Required	Required	Exclusion	Required
DIV	Required	Required	Required	Exclusion	Required	Exclusion
WLAN	Required	Required	Exclusion	Required	Required	Exclusion

Note:

Required : The distance to Edge is less than 25mm, testing is required.

Exclusion: The distance to Edge is more than 25 mm, testing is not required.

Standalone SAR test exclusion considerations

Mode	Frequency (MHz)	Output Power (dBm)	Output Power (mW)	Distance (mm)	Calculated value	Threshold (1-g)	SAR Test Exclusion
Bluetooth	2480	1.5	1.41	< 5	0.4	3	YES

NOTE:

The 1-g and 10-g SAR test exclusion thresholds for 100 MHz to 6 GHz at test separation distances ≤ 50 mm are determined by:

$$[(\text{max. power of channel, including tune-up tolerance, mW}) / (\text{min. test separation distance, mm})] \cdot [\sqrt{f(\text{GHz})}] \leq 3.0 \text{ for 1-g SAR and } \leq 7.5 \text{ for 10-g extremity SAR, where}$$

1. f(GHz) is the RF channel transmit frequency in GHz.
2. Power and distance are rounded to the nearest mW and mm before calculation.
3. The result is rounded to one decimal place for comparison.
4. When the minimum test separation distance is < 5 mm, a distance of 5 mm is applied to determine SAR test Exclusion.

Standalone SAR estimation:

Mode	Frequency (MHz)	Output Power (dBm)	Output Power (mW)	Distance (mm)	Estimated 1-g (W/kg)
BT Head	2480	1.5	1.41	0	0.06
BT Body	2480	1.5	1.41	10	0.03

Note: The Bluetooth based peak power for calculation.

When standalone SAR test exclusion applies to an antenna that transmits simultaneously with other antennas, the standalone SAR must be estimated according to following to determine simultaneous transmission SAR test exclusion:

$$[(\text{max. power of channel, including tune-up tolerance , mW}) / (\text{min. test separation distance, mm})] \cdot [\sqrt{f(\text{GHz})} / x]$$

W/kg for test separation distances ≤50 mm;

where x = 7.5 for 1-g SAR.

When the minimum test separation distance is < 5 mm, a distance of 5 mm is applied to determine SAR test Exclusion.

Extremity Exposure Considerations

Per KDB 648474 D04v01r03, this device is considered a “Phablet” since the diagonal dimension is >160mm and < 200mm, when hotspot mode applies, extremity SAR is required only for the surfaces and edges with hotspot mode scaled to the maximum output power (with tolerance is 1g SAR > 1.2W/kg)

Extremity Exposure Condition		
Worst Mode	Hotspot SAR value	Extremity Condition Test
LTE Band 41	0.58 W/kg@1g	Exclusion

SAR MEASUREMENT RESULTS

This page summarizes the results of the performed dosimetry evaluation.

Test Results:

Environmental Conditions:

Temperature:	20.8 ~ 21.8°C	21.9 ~ 22.8°C	21.6 ~ 23.1°C	21.8 ~ 23.2°C
Relative Humidity:	55 ~ 62%	53 ~ 61%	51 ~ 62%	54 ~ 64%
ATM Pressure:	101.3 kPa	101.3 kPa	101.3 kPa	101.3 kPa
Test Date:	2024/11/10	2024/11/11	2024/11/12	2024/11/13

Temperature:	21.9 ~ 23.8°C	21.7 ~ 22.9°C	21.7 ~ 23°C
Relative Humidity:	52 ~ 66%	51 ~ 66%	54 ~ 63%
ATM Pressure:	101.3 kPa	101.3 kPa	101.3 kPa
Test Date:	2024/11/14	2024/11/15	2024/11/16

* Testing was performed by Bob Lu, Calvin Li and Sid Luo.

GSM 850:

EUT Position	Frequency (MHz)	Test Mode	Max. Meas. Power (dBm)	Max. Rated Power (dBm)	1g SAR (W/kg)			
					Scaled Factor	Meas. SAR	Scaled SAR	Plot
Head Left Cheek	824.2	GPRS	/	/	/	/	/	/
	836.6	GPRS	30.87	31.0	1.030	0.053	0.06	/
	848.8	GPRS	/	/	/	/	/	/
Head Left Tilt	824.2	GPRS	/	/	/	/	/	/
	836.6	GPRS	30.87	31.0	1.030	0.043	0.05	/
	848.8	GPRS	/	/	/	/	/	/
Head Right Cheek	824.2	GPRS	30.79	31.0	1.050	0.062	0.07	/
	836.6	GPRS	30.87	31.0	1.030	0.073	0.08	1#
	848.8	GPRS	30.83	31.0	1.040	0.069	0.08	/
Head Right Tilt	824.2	GPRS	/	/	/	/	/	/
	836.6	GPRS	30.87	31.0	1.030	0.046	0.05	/
	848.8	GPRS	/	/	/	/	/	/
Body Worn Front (10mm)	824.2	GSM	/	/	/	/	/	/
	836.6	GSM	32.92	33.0	1.019	0.149	0.16	/
	848.8	GSM	/	/	/	/	/	/
Body Worn Back (10mm)	824.2	GSM	32.90	33.0	1.023	0.170	0.18	/
	836.6	GSM	32.92	33.0	1.019	0.210	0.22	/
	848.8	GSM	32.85	33.0	1.035	0.242	0.26	2#
Body Front (10mm)	824.2	GPRS	/	/	/	/	/	/
	836.6	GPRS	30.87	31.0	1.030	0.140	0.15	/
	848.8	GPRS	/	/	/	/	/	/
Body Back (10mm)	824.2	GPRS	/	/	/	/	/	/
	836.6	GPRS	30.87	31.0	1.030	0.190	0.20	/
	848.8	GPRS	/	/	/	/	/	/
Body Left (10mm)	824.2	GPRS	/	/	/	/	/	/
	836.6	GPRS	30.87	31.0	1.030	0.094	0.10	/
	848.8	GPRS	/	/	/	/	/	/
Body Right (10mm)	824.2	GPRS	/	/	/	/	/	/
	836.6	GPRS	30.87	31.0	1.030	0.144	0.15	/
	848.8	GPRS	/	/	/	/	/	/
Body Bottom (10mm)	824.2	GPRS	/	/	/	/	/	/
	836.6	GPRS	30.87	31.0	1.030	0.109	0.12	/
	848.8	GPRS	/	/	/	/	/	/

The data above was performed on 2024/11/11.

Note:

1. When the 1-g SAR is $\leq 0.8W/Kg$, testing for other channels are optional.
2. The EUT transmit and receive through the same GSM antenna while testing SAR.
3. When SAR or MPE is not measured at the maximum power level allowed for production units, the results must be scaled to the maximum tune-up tolerance limit according to the power applied to the individual channels tested to determine compliance.
4. When the maximum output power variation across the required test channels is > 0.5 dB, instead of the middle channel, the highest output power channel must be used.
5. The Multi-slot Classes of EUT is Class 12 which has maximum 4 Downlink slots and 4 Uplink slots, the maximum active slots is 5, when perform the multiple slots scan, 3DL+2UL is the worst case.
6. The max. time based average power of GSM/GPRS/EGPRS mode was selected to Head SAR testing.

PCS 1900:

EUT Position	Frequency (MHz)	Test Mode	Max. Meas. Power (dBm)	Max. Rated Power (dBm)	1g SAR (W/kg)			
					Scaled Factor	Meas. SAR	Scaled SAR	Plot
Head Left Cheek	1850.2	GPRS	/	/	/	/	/	/
	1880	GPRS	25.88	26.0	1.028	0.555	0.58	/
	1909.8	GPRS	/	/	/	/	/	/
Head Left Tilt	1850.2	GPRS	/	/	/	/	/	/
	1880	GPRS	25.88	26.0	1.028	0.575	0.60	/
	1909.8	GPRS	/	/	/	/	/	/
Head Right Cheek	1850.2	GPRS	25.84	26.0	1.038	0.874	0.91	3#
	1880	GPRS	25.88	26.0	1.028	0.726	0.75	/
	1909.8	GPRS	25.39	26.0	1.151	0.629	0.73	/
Head Right Tilt	1850.2	GPRS	/	/	/	/	/	/
	1880	GPRS	25.88	26.0	1.028	0.649	0.67	/
	1909.8	GPRS	/	/	/	/	/	/
Body Worn Front (10mm)	1850.2	GSM	/	/	/	/	/	/
	1880	GSM	29.67	29.8	1.030	0.200	0.21	/
	1909.8	GSM	/	/	/	/	/	/
Body Worn Back (10mm)	1850.2	GSM	/	/	/	/	/	/
	1880	GSM	29.67	29.8	1.030	0.310	0.32	/
	1909.8	GSM	/	/	/	/	/	/
Body Front (10mm)	1850.2	GPRS	/	/	/	/	/	/
	1880	GPRS	25.88	26.0	1.028	0.254	0.27	/
	1909.8	GPRS	/	/	/	/	/	/
Body Back (10mm)	1850.2	GPRS	25.84	26.0	1.038	0.449	0.47	4#
	1880	GPRS	25.88	26.0	1.028	0.416	0.43	/
	1909.8	GPRS	25.39	26.0	1.151	0.318	0.37	/
Body Left (10mm)	1850.2	GPRS	/	/	/	/	/	/
	1880	GPRS	25.88	26.0	1.028	0.121	0.13	/
	1909.8	GPRS	/	/	/	/	/	/
Body Top (10mm)	1850.2	GPRS	/	/	/	/	/	/
	1880	GPRS	25.88	26.0	1.028	0.284	0.30	/
	1909.8	GPRS	/	/	/	/	/	/

The data above was performed on 2024/11/13.

Note:

1. When the 1-g SAR is $\leq 0.8\text{W/Kg}$, testing for other channels are optional.
2. The EUT transmit and receive through the same GSM antenna while testing SAR.
3. When SAR or MPE is not measured at the maximum power level allowed for production units, the results must be scaled to the maximum tune-up tolerance limit according to the power applied to the individual channels tested to determine compliance.
4. When the maximum output power variation across the required test channels is $> 0.5\text{ dB}$, instead of the middle channel, the highest output power channel must be used.
5. The Multi-slot Classes of EUT is Class 12 which has maximum 4 Downlink slots and 4 Uplink slots, the maximum active slots is 5, when perform the multiple slots scan, 2DL+3UL is the worst case.
6. The max. time based average power of GSM/GPRS/EGPRS mode was selected to Head SAR testing.

WCDMA Band 2 :

EUT Position	Frequency (MHz)	Test Mode	Max. Meas. Power (dBm)	Max. Rated Power (dBm)	1g SAR (W/kg)			
					Scaled Factor	Meas. SAR	Scaled SAR	Plot
Head Left Cheek	1852.4	RMC	/	/	/	/	/	/
	1880	RMC	23.73	24.0	1.064	0.467	0.50	/
	1907.6	RMC	/	/	/	/	/	/
Head Left Tilt	1852.4	RMC	/	/	/	/	/	/
	1880	RMC	23.73	24.0	1.064	0.521	0.56	/
	1907.6	RMC	/	/	/	/	/	/
Head Right Cheek	1852.4	RMC	23.77	24.0	1.054	0.905	0.96	5#
	1880	RMC	23.73	24.0	1.064	0.770	0.82	/
	1907.6	RMC	23.79	24.0	1.050	0.842	0.89	/
Head Right Tilt	1852.4	RMC	/	/	/	/	/	/
	1880	RMC	23.73	24.0	1.064	0.698	0.75	/
	1907.6	RMC	/	/	/	/	/	/
Body Front (10mm)	1852.4	RMC	/	/	/	/	/	/
	1880	RMC	23.73	24.0	1.064	0.163	0.18	/
	1907.6	RMC	/	/	/	/	/	/
Body Back (10mm)	1852.4	RMC	23.77	24.0	1.054	0.276	0.30	/
	1880	RMC	23.73	24.0	1.064	0.283	0.31	6#
	1907.6	RMC	23.79	24.0	1.050	0.275	0.29	/
Body Left (10mm)	1852.4	RMC	/	/	/	/	/	/
	1880	RMC	23.73	24.0	1.064	0.108	0.12	/
	1907.6	RMC	/	/	/	/	/	/
Body Top (10mm)	1852.4	RMC	/	/	/	/	/	/
	1880	RMC	23.73	24.0	1.064	0.192	0.21	/
	1907.6	RMC	/	/	/	/	/	/

The data above was performed on 2024/11/13.

WCDMA Band 5 :

EUT Position	Frequency (MHz)	Test Mode	Max. Meas. Power (dBm)	Max. Rated Power (dBm)	1g SAR (W/kg)			
					Scaled Factor	Meas. SAR	Scaled SAR	Plot
Head Left Cheek	826.4	RMC	/	/	/	/	/	/
	836.6	RMC	23.63	24.0	1.089	0.130	0.15	/
	846.6	RMC	/	/	/	/	/	/
Head Left Tilt	826.4	RMC	/	/	/	/	/	/
	836.6	RMC	23.63	24.0	1.089	0.082	0.09	/
	846.6	RMC	/	/	/	/	/	/
Head Right Cheek	826.4	RMC	23.57	24.0	1.104	0.175	0.20	/
	836.6	RMC	23.63	24.0	1.089	0.190	0.21	/
	846.6	RMC	23.59	24.0	1.099	0.198	0.22	7#
Head Right Tilt	826.4	RMC	/	/	/	/	/	/
	836.6	RMC	23.63	24.0	1.089	0.090	0.10	/
	846.6	RMC	/	/	/	/	/	/
Body Front (10mm)	826.4	RMC	/	/	/	/	/	/
	836.6	RMC	23.63	24.0	1.089	0.154	0.17	/
	846.6	RMC	/	/	/	/	/	/
Body Back (10mm)	826.4	RMC	23.57	24.0	1.104	0.237	0.27	/
	836.6	RMC	23.63	24.0	1.089	0.230	0.26	/
	846.6	RMC	23.59	24.0	1.099	0.246	0.28	8#
Body Left (10mm)	826.4	RMC	/	/	/	/	/	/
	836.6	RMC	23.63	24.0	1.089	0.084	0.10	/
	846.6	RMC	/	/	/	/	/	/
Body Right (10mm)	826.4	RMC	/	/	/	/	/	/
	836.6	RMC	23.63	24.0	1.089	0.157	0.18	/
	846.6	RMC	/	/	/	/	/	/
Body Bottom (10mm)	826.4	RMC	/	/	/	/	/	/
	836.6	RMC	23.63	24.0	1.089	0.136	0.15	/
	846.6	RMC	/	/	/	/	/	/

The data above was performed on 2024/11/11.

Note:

1. When the 1-g SAR is $\leq 0.8W/Kg$, testing for other channels are optional.
2. The EUT transmit and receive through the same antenna while testing SAR.
3. The default test configuration is to measure SAR with an established radio link between the EUT and a communication test set using a 12.2 kbps RMC (reference measurement Channel) Configured in Test Loop Model.
4. KDB 941225 D01-Body SAR is not required for HSDPA/HSUPA/ HSPA+ when the maximum average output of each RF channel is less than $\frac{1}{4}$ dB higher than measured 12.2kbps RMC or the maximum SAR for 12.2kbps RMC is $< 75\%$ of SAR limit.
5. When SAR or MPE is not measured at the maximum power level allowed for production units, the results must be scaled to the maximum tune-up tolerance limit according to the power applied to the individual channels tested to determine compliance.

LTE Band 2:

EUT Position	Frequency (MHz)	Bandwidth (MHz)	Test Mode	Max. Meas. Power (dBm)	Max. Rated Power (dBm)	1g SAR (W/kg)			
						Scaled Factor	Meas. SAR	Scaled SAR	Plot
Head Left Cheek	1860	20	1RB	/	/	/	/	/	/
	1880	20	1RB	21.48	21.8	1.076	0.563	0.61	/
	1900	20	1RB	/	/	/	/	/	/
	1880	20	50%RB	21.40	21.8	1.096	0.536	0.59	/
Head Left Tilt	1860	20	1RB	/	/	/	/	/	/
	1880	20	1RB	21.48	21.8	1.076	0.297	0.32	/
	1900	20	1RB	/	/	/	/	/	/
	1880	20	50%RB	21.40	21.8	1.096	0.271	0.30	/
Head Right Cheek	1860	20	1RB	21.39	21.8	1.099	0.480	0.53	/
	1880	20	1RB	21.48	21.8	1.076	0.606	0.66	9#
	1900	20	1RB	21.54	21.8	1.062	0.514	0.55	/
	1880	20	50%RB	21.40	21.8	1.096	0.485	0.54	/
Head Right Tilt	1860	20	1RB	/	/	/	/	/	/
	1880	20	1RB	21.48	21.8	1.076	0.538	0.58	/
	1900	20	1RB	/	/	/	/	/	/
	1880	20	50%RB	21.40	21.8	1.096	0.456	0.50	/
Body Front (10 mm)	1860	20	1RB	/	/	/	/	/	/
	1880	20	1RB	21.48	21.8	1.076	0.240	0.26	/
	1900	20	1RB	/	/	/	/	/	/
	1880	20	50%RB	21.40	21.8	1.096	0.193	0.22	/
Body Back (10 mm)	1860	20	1RB	21.39	21.8	1.099	0.296	0.33	/
	1880	20	1RB	21.48	21.8	1.076	0.292	0.32	/
	1900	20	1RB	21.54	21.8	1.062	0.309	0.33	10#
	1880	20	50%RB	21.40	21.8	1.096	0.278	0.31	/
Body Left (10 mm)	1860	20	1RB	/	/	/	/	/	/
	1880	20	1RB	21.48	21.8	1.076	0.236	0.26	/
	1900	20	1RB	/	/	/	/	/	/
	1880	20	50%RB	21.40	21.8	1.096	0.235	0.26	/
Body Top (10 mm)	1860	20	1RB	/	/	/	/	/	/
	1880	20	1RB	21.48	21.8	1.076	0.195	0.21	/
	1900	20	1RB	/	/	/	/	/	/
	1880	20	50%RB	21.40	21.8	1.096	0.178	0.20	/

The data above was performed on 2024/11/14.

LTE Band 5:

EUT Position	Frequency (MHz)	Bandwidth (MHz)	Test Mode	Max. Meas. Power (dBm)	Max. Rated Power (dBm)	1g SAR (W/kg)			
						Scaled Factor	Meas. SAR	Scaled SAR	Plot
Head Left Cheek	829	10	1RB	/	/	/	/	/	/
	836.5	10	1RB	22.83	23.0	1.040	0.043	0.05	/
	844	10	1RB	/	/	/	/	/	/
	836.5	10	50%RB	22.76	23.0	1.057	0.032	0.04	/
Head Left Tilt	829	10	1RB	/	/	/	/	/	/
	836.5	10	1RB	22.83	23.0	1.040	0.024	0.03	/
	844	10	1RB	/	/	/	/	/	/
	836.5	10	50%RB	22.76	23.0	1.057	0.018	0.02	/
Head Right Cheek	829	10	1RB	22.93	23.0	1.016	0.074	0.08	11#
	836.5	10	1RB	22.83	23.0	1.040	0.066	0.07	/
	844	10	1RB	22.90	23.0	1.023	0.059	0.07	/
	836.5	10	50%RB	22.76	23.0	1.057	0.051	0.06	/
Head Right Tilt	829	10	1RB	/	/	/	/	/	/
	836.5	10	1RB	22.83	23.0	1.040	0.043	0.05	/
	844	10	1RB	/	/	/	/	/	/
	836.5	10	50%RB	22.76	23.0	1.057	0.032	0.04	/
Body Front (10 mm)	829	10	1RB	/	/	/	/	/	/
	836.5	10	1RB	22.83	23.0	1.040	0.158	0.17	/
	844	10	1RB	/	/	/	/	/	/
	836.5	10	50%RB	22.76	23.0	1.057	0.134	0.15	/
Body Back (10 mm)	829	10	1RB	22.93	23.0	1.016	0.215	0.22	/
	836.5	10	1RB	22.83	23.0	1.040	0.205	0.22	/
	844	10	1RB	22.90	23.0	1.023	0.259	0.27	12#
	836.5	10	50%RB	22.76	23.0	1.057	0.184	0.20	/
Body Left (10 mm)	829	10	1RB	/	/	/	/	/	/
	836.5	10	1RB	22.83	23.0	1.040	0.114	0.12	/
	844	10	1RB	/	/	/	/	/	/
	836.5	10	50%RB	22.76	23.0	1.057	0.094	0.10	/
Body Right (10 mm)	829	10	1RB	/	/	/	/	/	/
	836.5	10	1RB	22.83	23.0	1.040	0.110	0.12	/
	844	10	1RB	/	/	/	/	/	/
	836.5	10	50%RB	22.76	23.0	1.057	0.089	0.10	/
Body Bottom (10 mm)	829	10	1RB	/	/	/	/	/	/
	836.5	10	1RB	22.83	23.0	1.040	0.124	0.13	/
	844	10	1RB	/	/	/	/	/	/
	836.5	10	50%RB	22.76	23.0	1.057	0.105	0.12	/

The data above was performed on 2024/11/12.

LTE Band 12:

EUT Position	Frequency (MHz)	Bandwidth (MHz)	Test Mode	Max. Meas. Power (dBm)	Max. Rated Power (dBm)	1g SAR (W/kg)			
						Scaled Factor	Meas. SAR	Scaled SAR	Plot
Head Left Cheek	704	10	1RB	/	/	/	/	/	/
	707.5	10	1RB	20.39	22.2	1.517	0.032	0.05	/
	711	10	1RB	/	/	/	/	/	/
	707.5	10	50%RB	19.17	22.2	2.009	0.022	0.05	/
Head Left Tilt	704	10	1RB	/	/	/	/	/	/
	707.5	10	1RB	20.39	22.2	1.517	0.014	0.03	/
	711	10	1RB	/	/	/	/	/	/
	707.5	10	50%RB	19.17	22.2	2.009	0.014	0.03	/
Head Right Cheek	704	10	1RB	20.14	22.2	1.607	0.040	0.07	13#
	707.5	10	1RB	20.39	22.2	1.517	0.038	0.06	/
	711	10	1RB	20.41	22.2	1.510	0.034	0.06	/
	707.5	10	50%RB	19.17	22.2	2.009	0.028	0.06	/
Head Right Tilt	704	10	1RB	/	/	/	/	/	/
	707.5	10	1RB	20.39	22.2	1.517	0.026	0.04	/
	711	10	1RB	/	/	/	/	/	/
	707.5	10	50%RB	19.17	22.2	2.009	0.018	0.04	/
Body Front (10 mm)	704	10	1RB	/	/	/	/	/	/
	707.5	10	1RB	20.39	22.2	1.517	0.193	0.30	/
	711	10	1RB	/	/	/	/	/	/
	707.5	10	50%RB	19.17	22.2	2.009	0.150	0.31	/
Body Back (10 mm)	704	10	1RB	/	/	/	/	/	/
	707.5	10	1RB	20.39	22.2	1.517	0.238	0.37	/
	711	10	1RB	/	/	/	/	/	/
	707.5	10	50%RB	19.17	22.2	2.009	0.189	0.38	/
Body Left (10 mm)	704	10	1RB	/	/	/	/	/	/
	707.5	10	1RB	20.39	22.2	1.517	0.195	0.30	/
	711	10	1RB	/	/	/	/	/	/
	707.5	10	50%RB	19.17	22.2	2.009	0.158	0.32	/
Body Right (10 mm)	704	10	1RB	20.14	22.2	1.607	0.258	0.42	/
	707.5	10	1RB	20.39	22.2	1.517	0.272	0.42	/
	711	10	1RB	20.41	22.2	1.510	0.268	0.41	/
	707.5	10	50%RB	19.17	22.2	2.009	0.214	0.43	14#
Body Bottom (10 mm)	704	10	1RB	/	/	/	/	/	/
	707.5	10	1RB	20.39	22.2	1.517	0.070	0.11	/
	711	10	1RB	/	/	/	/	/	/
	707.5	10	50%RB	19.17	22.2	2.009	0.055	0.12	/

The data above was performed on 2024/11/10.

Worst case for 3MHz bandwidth

EUT Position	Frequency (MHz)	Bandwidth (MHz)	Test Mode	Max. Meas. Power (dBm)	Max. Rated Power (dBm)	1g SAR (W/kg)			
						Scaled Factor	Meas. SAR	Scaled SAR	Plot
Head Right Cheek	700.5	3	1RB	22.13	22.2	1.016	0.027	0.03	/
Body Back (10mm)	700.5	3	1RB	22.13	22.2	1.016	0.107	0.11	/

The data above was performed on 2024/11/10.

LTE Band 13:

EUT Position	Frequency (MHz)	Bandwidth (MHz)	Test Mode	Max. Meas. Power (dBm)	Max. Rated Power (dBm)	1g SAR (W/kg)			
						Scaled Factor	Meas. SAR	Scaled SAR	Plot
Head Left Cheek	782	10	1RB	23.08	23.5	1.102	0.024	0.03	/
	782	10	50%RB	23.05	23.5	1.109	0.014	0.02	/
Head Left Tilt	782	10	1RB	23.08	23.5	1.102	0.009	0.02	/
	782	10	50%RB	23.05	23.5	1.109	0.005	0.01	/
Head Right Cheek	782	10	1RB	23.08	23.5	1.102	0.028	0.04	15#
	782	10	50%RB	23.05	23.5	1.109	0.021	0.03	/
Head Right Tilt	782	10	1RB	23.08	23.5	1.102	0.010	0.02	/
	782	10	50%RB	23.05	23.5	1.109	0.008	0.01	/
Body Front (10 mm)	782	10	1RB	23.08	23.5	1.102	0.097	0.11	/
	782	10	50%RB	23.05	23.5	1.109	0.074	0.09	/
Body Back (10 mm)	782	10	1RB	23.08	23.5	1.102	0.132	0.15	/
	782	10	50%RB	23.05	23.5	1.109	0.099	0.11	/
Body Left (10 mm)	782	10	1RB	23.08	23.5	1.102	0.095	0.11	/
	782	10	50%RB	23.05	23.5	1.109	0.071	0.08	/
Body Right (10 mm)	782	10	1RB	23.08	23.5	1.102	0.166	0.19	16#
	782	10	50%RB	23.05	23.5	1.109	0.127	0.15	/
Body Bottom (10 mm)	782	10	1RB	23.08	23.5	1.102	0.081	0.09	/
	782	10	50%RB	23.05	23.5	1.109	0.064	0.08	/

The data above was performed on 2024/11/10.

LTE Band 41:

EUT Position	Frequency (MHz)	Bandwidth (MHz)	Test Mode	Max. Meas. Power (dBm)	Max. Rated Power (dBm)	1g SAR (W/kg)			
						Scaled Factor	Meas. SAR	Scaled SAR	Plot
Head Left Cheek	2506	20	1RB	/	/	/	/	/	/
	2549.5	20	1RB	/	/	/	/	/	/
	2593	20	1RB	20.85	21.3	1.109	0.591	0.66	/
	2636.5	20	1RB	/	/	/	/	/	/
	2680	20	1RB	/	/	/	/	/	/
	2593	20	50%RB	20.78	21.3	1.127	0.574	0.65	/
Head Left Tilt	2506	20	1RB	/	/	/	/	/	/
	2549.5	20	1RB	/	/	/	/	/	/
	2593	20	1RB	20.85	21.3	1.109	0.585	0.65	/
	2636.5	20	1RB	/	/	/	/	/	/
	2680	20	1RB	/	/	/	/	/	/
	2593	20	50%RB	20.78	21.3	1.127	0.496	0.56	/
Head Right Cheek	2506	20	1RB	/	/	/	/	/	/
	2549.5	20	1RB	/	/	/	/	/	/
	2593	20	1RB	20.85	21.3	1.109	0.614	0.69	/
	2636.5	20	1RB	/	/	/	/	/	/
	2680	20	1RB	/	/	/	/	/	/
	2593	20	50%RB	20.78	21.3	1.127	0.606	0.69	/
Head Right Tilt	2506	20	1RB	20.65	21.3	1.161	0.630	0.74	/
	2549.5	20	1RB	20.69	21.3	1.151	0.552	0.64	/
	2593	20	1RB	20.85	21.3	1.109	0.677	0.76	/
	2636.5	20	1RB	20.06	21.3	1.330	0.644	0.86	/
	2680	20	1RB	20.08	21.3	1.324	0.708	0.94	17#
	2593	20	50%RB	20.78	21.3	1.127	0.670	0.76	/
Body Front (10 mm)	2506	20	1RB	/	/	/	/	/	/
	2549.5	20	1RB	/	/	/	/	/	/
	2593	20	1RB	20.85	21.3	1.109	0.074	0.09	/
	2636.5	20	1RB	/	/	/	/	/	/
	2680	20	1RB	/	/	/	/	/	/
	2593	20	50%RB	20.78	21.3	1.127	0.059	0.07	/
Body Back (10 mm)	2506	20	1RB	/	/	/	/	/	/
	2549.5	20	1RB	/	/	/	/	/	/
	2593	20	1RB	20.85	21.3	1.109	0.209	0.24	/
	2636.5	20	1RB	/	/	/	/	/	/
	2680	20	1RB	/	/	/	/	/	/
	2593	20	50%RB	20.78	21.3	1.127	0.169	0.20	/
Body Left (10 mm)	2506	20	1RB	/	/	/	/	/	/
	2549.5	20	1RB	/	/	/	/	/	/
	2593	20	1RB	20.85	21.3	1.109	0.096	0.11	/
	2636.5	20	1RB	/	/	/	/	/	/
	2680	20	1RB	/	/	/	/	/	/
	2593	20	50%RB	20.78	21.3	1.127	0.076	0.09	/

Body Top (10 mm)	2506	20	1RB	20.65	21.3	1.161	0.317	0.37	/
	2549.5	20	1RB	20.69	21.3	1.151	0.245	0.29	/
	2593	20	1RB	20.85	21.3	1.109	0.364	0.41	/
	2636.5	20	1RB	20.06	21.3	1.330	0.283	0.38	/
	2680	20	1RB	20.08	21.3	1.324	0.434	0.58	18#
	2593	20	50%RB	20.78	21.3	1.127	0.320	0.37	/

The data above was performed on 2024/11/15.

Note:

1. The frequency range of LTE Band 41 is 2496~ 2690MHz. Per KDB 447498 D01, according to the following formula calculate N_c is 5.

KDB procedures, the following should be applied to determine the number of required test channels. The test channels should be evenly spread across the transmission frequency band of each wireless mode.¹⁴

$$N_c = \text{Round} \left\{ \left[100 \left(\frac{f_{\text{high}} - f_{\text{low}}}{f_c} \right) \right]^{0.5} \times \left(\frac{f_c}{100} \right)^{0.2} \right\},$$

where

- N_c is the number of test channels, rounded to the nearest integer,
- f_{high} and f_{low} are the highest and lowest channel frequencies within the transmission band,
- f_c is the mid-band channel frequency,
- all frequencies are in MHz.

2. The power class 3 used for LTE Band 41 SAR testing.

Note:

1. When the 1-g SAR is ≤ 0.8 W/Kg, testing for other channels are optional.
2. SAR for LTE band exposure configurations is measured according to the procedures of KDB 941225 D05 SAR for LTE Devices v02.
3. KDB 941225 D05-SAR for higher order modulation is required only when the highest maximum output power for the configuration in the higher order modulation is > 0.5 dB higher than the same configuration in QPSK or when the reported SAR for the QPSK configuration is > 1.45 W/kg
4. KDB 941225 D05-For QPSK with 100% RB allocation, when the reported SAR measured for the Highest output power channel is < 1.45 W/kg, tests for the remaining required test channels are optional.
5. KDB 941225 D05- For QPSK with 100% RB allocation, SAR is not required when the highest maximum output power for 100 % RB allocation is less than the highest maximum output power in 50% and 1 RB allocations and the highest reported SAR for 1 RB and 50% RB allocation are ≤ 0.8 W/kg.
6. KDB 941225 D05- Start with the largest channel bandwidth and measure SAR for QPSK with 1 RB allocation, using the RB offset and required test channel combination with the highest maximum output power among RB offset the upper edge, middle and lower edge of each required test channel.
7. KDB 941225 D05- other channel bandwidths SAR test is required when the highest maximum output power of a configuration requiring testing in the smaller channel bandwidth is > 0.5 dB higher than the equivalent channel configurations in the largest channel bandwidth configuration or the reported SAR of a configuration for the largest channel bandwidth is > 1.45 W/kg.

WLAN 2.4G:

EUT Position	Frequency (MHz)	Test Mode	Max. Meas. Power (dBm)	Max. Rated Power (dBm)	1g SAR (W/kg)				
					Scaled Factor	Duty cycle Factor	Meas. SAR	Scaled SAR	Plot
Head Left Check	2412	802.11b	/	/	/	/	/	/	/
	2437	802.11b	7.20	7.5	1.072	1.00	0.252	0.28	/
	2462	802.11b	/	/	/	/	/	/	/
Head Left Tilt	2412	802.11b	5.85	7.5	1.462	1.00	0.233	0.35	19#
	2437	802.11b	7.20	7.5	1.072	1.00	0.255	0.28	/
	2462	802.11b	6.25	7.5	1.334	1.00	0.160	0.22	/
Head Right Check	2412	802.11b	/	/	/	/	/	/	/
	2437	802.11b	7.20	7.5	1.072	1.00	0.058	0.07	/
	2462	802.11b	/	/	/	/	/	/	/
Head Right Tilt	2412	802.11b	/	/	/	/	/	/	/
	2437	802.11b	7.20	7.5	1.072	1.00	0.088	0.10	/
	2462	802.11b	/	/	/	/	/	/	/
Body Front (10mm)	2412	802.11b	/	/	/	/	/	/	/
	2437	802.11b	7.20	7.5	1.072	1.00	0.058	0.07	/
	2462	802.11b	/	/	/	/	/	/	/
Body Back (10mm)	2412	802.11b	/	/	/	/	/	/	/
	2437	802.11b	7.20	7.5	1.072	1.00	0.095	0.11	/
	2462	802.11b	/	/	/	/	/	/	/
Body Right (10mm)	2412	802.11b	/	/	/	/	/	/	/
	2437	802.11b	7.20	7.5	1.072	1.00	0.035	0.04	/
	2462	802.11b	/	/	/	/	/	/	/
Body Top (10mm)	2412	802.11b	5.85	7.5	1.462	1.00	0.129	0.19	20#
	2437	802.11b	7.20	7.5	1.072	1.00	0.124	0.14	/
	2462	802.11b	6.25	7.5	1.334	1.00	0.095	0.13	/

The data above was performed on 2024/11/15.

Modulation Mode	Power (dBm)	Power (mW)	Scaled SAR (W/kg)	Adjusted SAR (W/kg)	Limit(W/kg)	SAR Test Exclusion
802.11b(DSSS)	7.5	5.62	0.35	/	/	/
802.11g(OFDM)	8.4	6.92	/	0.43	1.2	Yes
802.11n HT20(OFDM)	8.4	6.92	/	0.43	1.2	Yes
802.11n HT40(OFDM)	7.5	5.62	/	0.35	1.2	Yes

Note:

1. When the 1-g SAR is ≤ 0.8 W/kg, testing for other channels are optional.
2. When SAR or MPE is not measured at the maximum power level allowed for production units, the results must be scaled to the maximum tune-up tolerance limit according to the power applied to the individual channels tested to determine compliance.

WLAN 5.2G:

EUT Position	Frequency (MHz)	Test Mode	Max. Meas. Power (dBm)	Max. Rated Power (dBm)	1g SAR (W/kg)				
					Scaled Factor	Duty cycle Factor	Meas. SAR	Scaled SAR	Plot
Head Left Cheek	5180	802.11a	/	/	/	/	/	/	/
	5200	802.11a	8.31	8.8	1.119	1.00	0.237	0.27	/
	5240	802.11a	/	/	/	/	/	/	/
Head Left Tilt	5180	802.11a	8.37	8.8	1.104	1.00	0.271	0.30	21#
	5200	802.11a	8.31	8.8	1.119	1.00	0.258	0.29	/
	5240	802.11a	8.60	8.8	1.047	1.00	0.242	0.26	/
Head Right Cheek	5180	802.11a	/	/	/	/	/	/	/
	5200	802.11a	8.31	8.8	1.119	1.00	0.194	0.22	/
	5240	802.11a	/	/	/	/	/	/	/
Head Right Tilt	5180	802.11a	/	/	/	/	/	/	/
	5200	802.11a	8.31	8.8	1.119	1.00	0.206	0.24	/
	5240	802.11a	/	/	/	/	/	/	/
Body Front (10mm)	5180	802.11a	/	/	/	/	/	/	/
	5200	802.11a	8.31	8.8	1.119	1.00	0.038	0.05	/
	5240	802.11a	/	/	/	/	/	/	/
Body Back (10mm)	5180	802.11a	/	/	/	/	/	/	/
	5200	802.11a	8.31	8.8	1.119	1.00	0.058	0.07	/
	5240	802.11a	/	/	/	/	/	/	/
Body Right (10mm)	5180	802.11a	/	/	/	/	/	/	/
	5200	802.11a	8.31	8.8	1.119	1.00	0.037	0.05	/
	5240	802.11a	/	/	/	/	/	/	/
Body Top (10mm)	5180	802.11a	8.37	8.8	1.104	1.00	0.097	0.11	/
	5200	802.11a	8.31	8.8	1.119	1.00	0.102	0.12	22#
	5240	802.11a	8.60	8.8	1.047	1.00	0.092	0.10	/

The data above was performed on 2024/11/16.

Note:

1. When the 1-g SAR is ≤ 0.8W/kg, testing for other channels are optional.
2. When SAR or MPE is not measured at the maximum power level allowed for production units, the results must be scaled to the maximum tune-up tolerance limit according to the power applied to the individual channels tested to determine compliance.
3. For 802.11a mode power is the largest among 802.11a/n20/n40/ac20/ac40, 802.11a mode as initial test configuration is selected to test.

WLAN 5.8G:

EUT Position	Frequency (MHz)	Test Mode	Max. Meas. Power (dBm)	Max. Rated Power (dBm)	1g SAR (W/kg)				
					Scaled Factor	Duty cycle Factor	Meas. SAR	Scaled SAR	Plot
Head Left Cheek	5745	802.11a	9.02	9.3	1.067	1.00	0.206	0.22	/
	5785	802.11a	/	/	/	/	/	/	/
	5825	802.11a	/	/	/	/	/	/	/
Head Left Tilt	5745	802.11a	9.02	9.3	1.067	1.00	0.291	0.32	/
	5785	802.11a	8.24	9.3	1.276	1.00	0.308	0.40	/
	5825	802.11a	7.64	9.3	1.466	1.00	0.287	0.43	23#
Head Right Cheek	5745	802.11a	9.02	9.3	1.067	1.00	0.163	0.18	/
	5785	802.11a	/	/	/	/	/	/	/
	5825	802.11a	/	/	/	/	/	/	/
Head Right Tilt	5745	802.11a	9.02	9.3	1.067	1.00	0.169	0.19	/
	5785	802.11a	/	/	/	/	/	/	/
	5825	802.11a	/	/	/	/	/	/	/
Body Front (10mm)	5745	802.11a	9.02	9.3	1.067	1.00	0.059	0.07	/
	5785	802.11a	/	/	/	/	/	/	/
	5825	802.11a	/	/	/	/	/	/	/
Body Back (10mm)	5745	802.11a	9.02	9.3	1.067	1.00	0.103	0.11	/
	5785	802.11a	/	/	/	/	/	/	/
	5825	802.11a	/	/	/	/	/	/	/
Body Right (10mm)	5745	802.11a	9.02	9.3	1.067	1.00	0.038	0.05	/
	5785	802.11a	/	/	/	/	/	/	/
	5825	802.11a	/	/	/	/	/	/	/
Body Top (10mm)	5745	802.11a	9.02	9.3	1.067	1.00	0.096	0.11	/
	5785	802.11a	8.24	9.3	1.276	1.00	0.143	0.19	24#
	5825	802.11a	7.64	9.3	1.466	1.00	0.092	0.14	/

The data above was performed on 2024/11/16.

Note:

1. When the 1-g SAR is ≤ 0.8W/kg, testing for other channels are optional.
2. When SAR or MPE is not measured at the maximum power level allowed for production units, the results must be scaled to the maximum tune-up tolerance limit according to the power applied to the individual channels tested to determine compliance.
3. For 802.11a mode power is the largest among 802.11a/n20/n40/ac20/ac40, 802.11a mode as initial test configuration is selected to test.

SAR Measurement Variability

In accordance with published RF Exposure KDB procedure 865664 D01 SAR measurement 100 MHz to 6 GHz v01. These additional measurements are repeated after the completion of all measurements requiring the same head or body tissue-equivalent medium in a frequency band. The test device should be returned to ambient conditions (normal room temperature) with the battery fully charged before it is re-mounted on the device holder for the repeated measurement(s) to minimize any unexpected variations in the repeated results:

- 1) Repeated measurement is not required when the original highest measured SAR is < 0.80 W/kg; steps 2) through 4) do not apply.
- 2) When the original highest measured SAR is ≥ 0.80 W/kg, repeat that measurement once.
- 3) Perform a second repeated measurement only if the ratio of largest to smallest SAR for the original and first repeated measurements is > 1.20 or when the original or repeated measurement is ≥ 1.45 W/kg ($\sim 10\%$ from the 1-g SAR limit).
- 4) Perform a third repeated measurement only if the original, first or second repeated measurement is ≥ 1.5 W/kg and the ratio of largest to smallest SAR for the original, first and second repeated measurements is > 1.20 .

The Highest Measured SAR Configuration in Each Frequency Band

Head

SAR probe calibration point	Frequency Band	Freq.(MHz)	EUT Position	Meas. SAR (W/kg)		Largest to Smallest SAR Ratio
				Original	Repeated	
1900MHz	PCS 1900	1850.2	Head Right Cheek	0.874	0.856	1.02
1900MHz	WCDMA Band 2	1852.4	Head Right Cheek	0.905	0.879	1.03

Body

SAR probe calibration point	Frequency Band	Freq.(MHz)	EUT Position	Meas. SAR (W/kg)		Largest to Smallest SAR Ratio
				Original	Repeated	
/	/	/	/	/	/	/

Note:

1. Second Repeated Measurement is not required since the ratio of the largest to smallest SAR for the original and first repeated measurement is not > 1.20 .
2. The measured SAR results **do not** have to be scaled to the maximum tune-up tolerance to determine if repeated measurements are required.
3. SAR measurement variability must be assessed for each frequency band, which is determined by the **SAR probe calibration point and tissue-equivalent medium** used for the device measurements.

SAR SIMULTANEOUS TRANSMISSION DESCRIPTION

Simultaneous Transmission:

Description of Simultaneous Transmit Capabilities		
Transmitter Combination	Simultaneous?	Hotspot?
WWAN(GSM/WCDMA/LTE)Antenna + WLAN 2.4G + NFC	√	√
WWAN(GSM/WCDMA/LTE)Antenna + WLAN 5G + NFC	√	√
WWAN(GSM/WCDMA/LTE) Antenna + Bluetooth + NFC	√	×
WLAN2.4G+Bluetooth + NFC	×	×
WLAN 5G + Bluetooth + NFC	×	×
WLAN2.4G +WLAN 5G + NFC	×	×

Simultaneous SAR test exclusion considerations:

Mode(SAR1+SAR2)	Position	Reported SAR(W/kg)		ΣSAR < 1.6W/kg
		SAR1	SAR2	
MAX.WWAN(GSM/WCDMA/LTE) +WLAN 2.4G	Head	0.96	0.35	1.31
	Body	0.58	0.19	0.77
	Body (Hotspot)	0.58	0.19	0.77
MAX.WWAN(GSM/WCDMA/LTE) +WLAN 5.2G	Head	0.96	0.30	1.26
	Body	0.58	0.12	0.70
	Body (Hotspot)	0.58	0.12	0.70
MAX.WWAN(GSM/WCDMA/LTE) +WLAN 5.8G	Head	0.96	0.43	1.39
	Body	0.58	0.19	0.77
	Body (Hotspot)	0.58	0.19	0.77

Mode(SAR1+SAR2)	Position	Reported SAR(W/kg)		ΣSAR < 1.6W/kg
		SAR1	SAR2	
MAX.WWAN(GSM/WCDMA/LTE) + Bluetooth	Head	0.96	0.06	1.02
	Body	0.58	0.03	0.61

Note:

For the EIRP of NFC is 0.003mW, per KDB447498 D01 clause 4.3, the estimated SAR is so lower, so the NFC almost have no influence on the results of simultaneous transmission.

Conclusion:

Sum of SAR:ΣSAR ≤1.6 W/kg therefore simultaneous transmission SAR with Volume Scans is **not required**.

SAR Plots

Please Refer to the Attachment.

APPENDIX A MEASUREMENT UNCERTAINTY

The uncertainty budget has been determined for the measurement system and is given in the following Table.

Measurement uncertainty evaluation for IEEE1528-2013 SAR test

Source of uncertainty	Tolerance/uncertainty ± %	Probability distribution	Divisor	ci (1 g)	ci (10 g)	Standard uncertainty ± %, (1 g)	Standard uncertainty ± %, (10 g)
Measurement system							
Probe calibration	13.9	N	1	1	1	13.9	13.9
Axial Isotropy	4.7	R	√3	1	1	2.7	2.7
Hemispherical Isotropy	9.6	R	√3	0	0	0.0	0.0
Boundary effect	1.0	R	√3	1	1	0.6	0.6
Linearity	4.7	R	√3	1	1	2.7	2.7
Detection limits	1.0	R	√3	1	1	0.6	0.6
Modulation response	4.0	R	√3	1	1	2.3	2.3
Readout electronics	0.3	N	1	1	1	0.3	0.3
Response time	0.0	R	√3	1	1	0.0	0.0
Integration time	0.0	R	√3	1	1	0.0	0.0
RF ambient conditions – noise	1.0	R	√3	1	1	0.6	0.6
RF ambient conditions–reflections	1.0	R	√3	1	1	0.6	0.6
Probe positioner mech. Restrictions	0.8	R	√3	1	1	0.5	0.5
Probe positioning with respect to phantom shell	6.7	R	√3	1	1	3.9	3.9
Extrapolation, interpolation, and integrations algorithms for max. SAR evaluation	3.9	R	√3	1	1	2.3	2.3
Test sample related							
Test sample positioning	2.8	N	1	1	1	2.8	2.8
Device holder uncertainty	6.3	N	1	1	1	6.3	6.3
Drift of output power	5.0	R	√3	1	1	2.9	2.9
SAR scaling	2.0	R	√3	1	1	1.2	1.2
Phantom and tissue parameters							
Phantom uncertainty (shape and thickness tolerances)	4.0	R	√3	1	1	2.3	2.3
Uncertainty in SAR correction for deviations in permittivity and conductivity	1.9	N	1	1	0.84	1.9	1.6
Liquid conductivity measurement	5.5	N	1	0.78	0.71	4.3	3.9
Liquid permittivity measurement	2.9	N	1	0.23	0.26	0.7	0.8
Liquid conductivity—temperature uncertainty	1.7	R	√3	0.78	0.71	0.8	0.7
Liquid permittivity—temperature uncertainty	2.7	R	√3	0.23	0.26	0.4	0.4
Combined standard uncertainty		RSS				12.2	12.0
Expanded uncertainty 95 % confidence interval)						24.3	23.9

APPENDIX B EUT TEST POSITION PHOTOS

Please Refer to the Attachment.

APPENDIX C CALIBRATION CERTIFICATES

Please Refer to the Attachment.

APPENDIX D RETURN LOSS&IMPEDANCE MEASUREMENT

Please Refer to the Attachment.

******* END OF REPORT *******