



# TEST REPORT

Report No..... : CHTEW19070052 Report verification : 

Project No..... : SHT1906073903EW

FCC ID..... : 2ATV2-WMBR-1

Applicant's name..... : Walmart, Inc. on behalf of its affiliate Project Franklin, LLC

Address..... : 74 Kent St #2, Brooklyn, NY 11222

Manufacturer..... : Shenzhen ChampOn Technology Co. Ltd

Address..... : 628 Yi Ben BLDG, No.1063 Cha Guang rd, Xili, Nanshan, Shenzhen

Test item description ..... : Walmart WiFi Bridge

Trade Mark ..... : Walmart

Model/Type reference..... : WMBR-1

Listed Model(s) ..... : -

Standard ..... : FCC CFR Title 47 Part 15 Subpart C Section 15.247

Date of receipt of test sample..... : Jul.05, 2019

Date of testing..... : Jul.05, 2019- Jul.15, 2019

Date of issue..... : Jul.16, 2019

Result..... : PASS

Compiled by  
( Position+Printed name+Signature) : File administrators Echo Wei

*Echo Wei*

Supervised by  
( Position+Printed name+Signature) : Project Engineer Edward Pan

*Edward Pan*

Approved by  
( Position+Printed name+Signature) : RF Manager Hans Hu

*Hans Hu*

Testing Laboratory Name ..... : Shenzhen Huatongwei International Inspection Co., Ltd.

Address..... : 1/F, Bldg 3, Hongfa Hi-tech Industrial Park, Genyu Road, Tianliao, Gongming, Shenzhen, China

**Shenzhen Huatongwei International Inspection Co., Ltd. All rights reserved.**

This publication may be reproduced in whole or in part for non-commercial purposes as long as the Shenzhen Huatongwei International Inspection Co., Ltd. is acknowledged as copyright owner and source of the material. Shenzhen Huatongwei International Inspection Co., Ltd. takes no responsibility for and will not assume liability for damages resulting from the reader's interpretation of the reproduced material due to its placement and context.

The test report merely correspond to the test sample.

## Contents

<b>1.</b>	<b><u>TEST STANDARDS AND REPORT VERSION</u></b>	<b>3</b>
1.1.	Test Standards	3
1.2.	Report version	3
<b>2.</b>	<b><u>TEST DESCRIPTION</u></b>	<b>4</b>
<b>3.</b>	<b><u>SUMMARY</u></b>	<b>5</b>
3.1.	Client Information	5
3.2.	Product Description	5
3.3.	Operation state	6
3.4.	EUT configuration	6
3.5.	Modifications	6
<b>4.</b>	<b><u>TEST ENVIRONMENT</u></b>	<b>7</b>
4.1.	Address of the test laboratory	7
4.2.	Test Facility	7
4.3.	Environmental conditions	8
4.4.	Statement of the measurement uncertainty	8
4.5.	Equipments Used during the Test	9
<b>5.</b>	<b><u>TEST CONDITIONS AND RESULTS</u></b>	<b>11</b>
5.1.	Antenna Requirement	11
5.2.	Conducted Emissions (AC Main)	12
5.3.	Conducted Peak Output Power	15
5.4.	Power Spectral Density	16
5.5.	6dB bandwidth	18
5.6.	Restricted band	20
5.7.	Band edge and Spurious Emissions (conducted)	22
5.8.	Spurious Emissions (radiated)	27
<b>6.</b>	<b><u>TEST SETUP PHOTOS</u></b>	<b>31</b>
<b>7.</b>	<b><u>EXTERANAL AND INTERNAL PHOTOS</u></b>	<b>33</b>

# **1. TEST STANDARDS AND REPORT VERSION**

## **1.1. Test Standards**

The tests were performed according to following standards:

[FCC Rules Part 15.247](#): Frequency Hopping, Direct Spread Spectrum and Hybrid Systems that are in operation within the bands of 902-928 MHz, 2400-2483.5 MHz, and 5725-5850 MHz

[ANSI C63.10:2013](#): American National Standard for Testing Unlicensed Wireless Devices

[KDB 558074 D01 15.247 Meas Guidance v05r02](#): Guidance for Compliance Measurements on Digital Transmission System, Frequency Hopping Spread Spectrum System, and Hybrid System Devices Operating under Section 15.247 of The FCC Rules

## **1.2. Report version**

Revision No.	Date of issue	Description
N/A	2019-07-16	Original

## **2. TEST DESCRIPTION**

<b>Test Item</b>	<b>FCC Rule</b>	<b>Result</b>	<b>Test Engineer</b>
Antenna requirement	15.203/15.247(c)	PASS	JiongSheng.Feng
Line Conducted Emissions (AC Main)	15.207	PASS	Zhiwei Liu
Conducted Peak Output Power	15.247(b)(3)	PASS	JiongSheng.Feng
Power Spectral Density	15.247(e)	PASS	JiongSheng.Feng
6dB Bandwidth	15.247(a)(2)	PASS	JiongSheng.Feng
Restricted band	15.247(d)/15.205	PASS	JiongSheng.Feng
Spurious Emissions	15.247(d)/15.209	PASS	Xu Yang

Note: The measurement uncertainty is not included in the test result.

### 3. SUMMARY

#### 3.1. Client Information

Applicant:	Walmart, Inc. on behalf of its affiliate Project Franklin, LLC
Address:	74 Kent St #2, Brooklyn, NY 11222
Manufacturer:	Shenzhen ChampOn Technology Co. Ltd
Address:	628 Yi Ben BLDG, No.1063 Cha Guang rd, Xili, Nanshan, Shenzhen

#### 3.2. Product Description

Name of EUT:	Walmart WiFi Bridge
Trade Mark:	Walmart
Model No.:	WMBR-1
Listed Model(s):	-
Power supply:	DC 5V
Hardware version:	V2
Software version:	V1
<b>Bluetooth</b>	
Version:	Supported BT5.0+BLE
Modulation:	GFSK
Operation frequency:	2402MHz~2480MHz
Channel number:	40
Channel separation:	2MHz
Antenna type:	FPC
Antenna gain:	2dBi

### 3.3. Operation state

#### ➤ Test frequency list

According to section 15.31(m), regards to the operating frequency range over 10 MHz, must select three channel which were tested. the Lowest frequency, the middle frequency, and the highest frequency of channel were selected to perform the test, please see the above gray bottom.

Channel	Frequency (MHz)
00	2402
01	2404
⋮	⋮
19	2440
⋮	⋮
38	2478
39	2480

#### ➤ Test mode

For RF test items
The engineering test program was provided and enabled to make EUT continuous transmit (duty cycle>98%).
For AC power line conducted emissions:
The EUT was set to connect with the Bluetooth instrument under large package sizes transmission.
For Radiated suprious emissions test item:
The engineering test program was provided and enabled to make EUT continuous transmit(duty cycle>98%). The EUT in each of three orthogonal axis emissions had been tested ,but only the worst case (X axis) data Recorded in the report.

### 3.4. EUT configuration

The following peripheral devices and interface cables were connected during the measurement:

- - supplied by the manufacturer
- - supplied by the lab

	/	Manufacturer:	/
		Model No.:	/
○	Notebook	Manufacturer:	TOSHIBA
		Model No.:	Satellite M800

### 3.5. Modifications

No modifications were implemented to meet testing criteria.

## **4. TEST ENVIRONMENT**

### **4.1. Address of the test laboratory**

Laboratory: Shenzhen Huatongwei International Inspection Co., Ltd.

Address: 1/F, Bldg 3, Hongfa Hi-tech Industrial Park, Genyu Road, Tianliao, Gongming, Shenzhen, China

### **4.2. Test Facility**

#### **CNAS-Lab Code: L1225**

Shenzhen Huatongwei International Inspection Co., Ltd. has been assessed and proved to be in compliance with CNAS-CL01 Accreditation Criteria for Testing and Calibration Laboratories (identical to ISO/IEC17025: 2005 General Requirements) for the Competence of Testing and Calibration Laboratories.

#### **A2LA-Lab Cert. No.: 3902.01**

Shenzhen Huatongwei International Inspection Co., Ltd. EMC Laboratory has been accredited by A2LA for technical competence in the field of electrical testing, and proved to be in compliance with ISO/IEC 17025: 2005 General Requirements for the Competence of Testing and Calibration Laboratories and any additional program requirements in the identified field of testing.

#### **FCC-Registration No.: 762235**

Shenzhen Huatongwei International Inspection Co., Ltd. EMC Laboratory has been registered and fully described in a report filed with the FCC (Federal Communications Commission). The acceptance letter from the FCC is maintained in our files.

#### **IC-Registration No.:5377A**

Two 3m Alternate Test Site of Shenzhen Huatongwei International Inspection Co., Ltd. has been registered by Certification and Engineering Bureau of Industry Canada for the performance of radiated measurements with Registration No.: 5377A.

#### **ACA**

Shenzhen Huatongwei International Inspection Co., Ltd. EMC Laboratory can also perform testing for the Australian C-Tick mark as a result of our A2LA accreditation.

### 4.3. Environmental conditions

During the measurement the environmental conditions were within the listed ranges:

Temperature:	15~35°C
Relative Humidity:	30~60 %
Air Pressure:	950~1050mba

### 4.4. Statement of the measurement uncertainty

The data and results referenced in this document are true and accurate. The reader is cautioned that there may be errors in calibration limits of the equipment and facilities. The measurement uncertainty was calculated for all measurements listed in this test report according to TR-100028-01 "Electromagnetic compatibility and Radio spectrum Matters (ERM); Uncertainties in the measurement of mobile radio equipment characteristics; Part 1" and TR-100028-02 "Electromagnetic compatibility and Radio spectrum Matters (ERM); Uncertainties in the measurement of mobile radio equipment characteristics; Part 2" and is documented in the Shenzhen Huatongwei International Inspection Co., Ltd. quality system according to ISO/IEC 17025. Furthermore, component and process variability of devices similar to that tested may result in additional deviation. The manufacturer has the sole responsibility of continued compliance of the device.

Here after the best measurement capability for Shenzhen Huatongwei International Inspection Co., Ltd. is reported:

Test Items	Measurement Uncertainty	Notes
Transmitter power conducted	0.51 dB	(1)
Conducted spurious emissions 9kHz~40GHz	0.51 dB	(1)
Conducted Disturbance 150kHz~30MHz	3.02 dB	(1)
Radiated Emissions below 1GHz	4.90 dB	(1)
Radiated Emissions above 1GHz	4.96 dB	(1)
Occupied Bandwidth	70 Hz	(1)

(1) This uncertainty represents an expanded uncertainty expressed at approximately the 95% confidence level using a coverage factor of k=1.96.



#### 4.5. Equipments Used during the Test

● Conducted Emission						
Used	Test Equipment	Manufacturer	Model No.	Serial No.	Last Cal. Date (YY-MM-DD)	Next Cal. Date (YY-MM-DD)
●	Shielded Room	Albatross projects	N/A	N/A	2018/09/28	2023/09/27
●	EMI Test Receiver	R&S	ESCI	101247	2018/10/27	2019/10/26
●	Artificial Mains	SCHWARZBECK	NNLK 8121	573	2018/10/27	2019/10/26
●	Pulse Limiter	R&S	ESH3-Z2	100499	2018/10/27	2019/10/26
●	RF Connection Cable	HUBER+SUHNER	EF400	N/A	2018/11/15	2019/11/14
●	Test Software	R&S	ES-K1	N/A	N/A	N/A
○	Single Balanced Telecom Pair ISN	FCC	FCC-TLISN-T2-02	20371	2018/10/28	2019/10/27
○	Two Balanced Telecom Pairs ISN	FCC	FCC-TLISN-T4-02	20373	2018/10/28	2019/10/27
○	Four Balanced Telecom Pairs ISN	FCC	FCC-TLISN-T8-02	20375	2018/10/28	2019/10/27
○	V-Network	R&S	ESH3-Z6	100211	2018/10/27	2019/10/26
○	V-Network	R&S	ESH3-Z6	100210	2018/10/27	2019/10/26
○	2-Line V-Network	R&S	ESH3-Z5	100049	2018/10/27	2019/10/26
● Radiated Emission-6th test site						
Used	Test Equipment	Manufacturer	Model No.	Serial No.	Last Cal. Date (YY-MM-DD)	Next Cal. Date (YY-MM-DD)
●	Semi-Anechoic Chamber	Albatross projects	SAC-3m-02	N/A	2018/09/30	2021/09/29
●	EMI Test Receiver	R&S	ESCI	100900	2018/10/28	2019/10/27
●	Loop Antenna	R&S	HFH2-Z2	100020	2017/11/20	2020/11/19
●	Ultra-Broadband Antenna	SCHWARZBECK	VULB9163	546	2017/04/05	2020/04/04
●	Pre-Amplifier	SCHWARZBECK	BBV 9742	N/A	2018/11/15	2019/11/14
●	RF Connection Cable	HUBER+SUHNER	N/A	N/A	2018/09/28	2019/09/27
●	RF Connection Cable	HUBER+SUHNER	SUCOFLEX104	501184/4	2018/09/28	2019/09/27
●	Test Software	R&S	ES-K1	N/A	N/A	N/A
●	Turntable	Maturo Germany	TT2.0-1T	N/A	N/A	N/A
●	Antenna Mast	Maturo Germany	CAM-4.0-P-12	N/A	N/A	N/A
● Radiated emission-7th test site						
Used	Test Equipment	Manufacturer	Model No.	Serial No.	Last Cal. Date (YY-MM-DD)	Next Cal. Date (YY-MM-DD)
●	Semi-Anechoic Chamber	Albatross projects	SAC-3m-01	N/A	2018/09/30	2021/09/29
●	Spectrum Analyzer	R&S	FSP40	100597	2018/10/27	2019/10/26
●	Horn Antenna	SCHWARZBECK	9120D	1011	2017/03/27	2020/03/26
●	Pre-amplifier	BONN	BLWA0160-2M	1811887	2018/11/14	2019/11/13
●	Pre-amplifier	CD	PAP-0102	12004	2018/11/14	2019/11/13
●	Broadband Pre-amplifier	SCHWARZBECK	BBV 9718	9718-248	2019/04/26	2020/04/25
●	RF Connection Cable	HUBER+SUHNER	RE-7-FH	N/A	2018/11/15	2019/11/14
●	RF Connection Cable	HUBER+SUHNER	RE-7-FL	N/A	2018/11/15	2019/11/14
●	Test Software	Audix	E3	N/A	N/A	N/A
●	Turntable	Maturo Germany	TT2.0-1T	N/A	N/A	N/A
●	Antenna Mast	Maturo Germany	CAM-4.0-P-12	N/A	N/A	N/A

● RF Conducted Method						
Used	Test Equipment	Manufacturer	Model No.	Serial No.	Last Cal. Date (YY-MM-DD)	Next Cal. Date (YY-MM-DD)
●	Signal and spectrum Analyzer	R&S	FSV40	100048	2018/10/28	2019/10/27
●	Spectrum Analyzer	Agilent	N9020A	MY50510187	2018/09/29	2019/09/28
○	Radio communication tester	R&S	CMW500	137688-Lv	2018/09/29	2019/09/28
○	Test software	Tonscend	JS1120-1(LTE)	N/A	N/A	N/A
○	Test software	Tonscend	JS1120-2(WIFI)	N/A	N/A	N/A
○	Test software	Tonscend	JS1120-3(WCDMA)	N/A	N/A	N/A
○	Test software	Tonscend	JS1120-4(GSM)	N/A	N/A	N/A

## 5. TEST CONDITIONS AND RESULTS

### 5.1. Antenna Requirement

#### Requirement

##### **FCC CFR Title 47 Part 15 Subpart C Section 15.203:**

An intentional radiator shall be designed to ensure that no antenna other than that furnished by the responsible party shall be used with the device. The use of a permanently attached antenna or of an antenna that uses a unique coupling to the intentional radiator, the manufacturer may design the unit so that a broken antenna can be replaced by the user, but the use of a standard antenna jack or electrical connector is prohibited.

##### **FCC CFR Title 47 Part 15 Subpart C Section 15.247(c) (1)(i):**

(i) Systems operating in the 2400-2483.5 MHz band that is used exclusively for fixed. Point-to-point operations may employ transmitting antennas with directional gain greater than 6 dBi provided the maximum conducted output power of the intentional radiator is reduced by 1 dB for every 3 dB that the directional gain of the antenna exceeds 6 dBi.

#### TEST RESULTS

**Passed**       **Not Applicable**

The directional gain of the antenna less than 6 dBi, please refer to the below antenna photo.

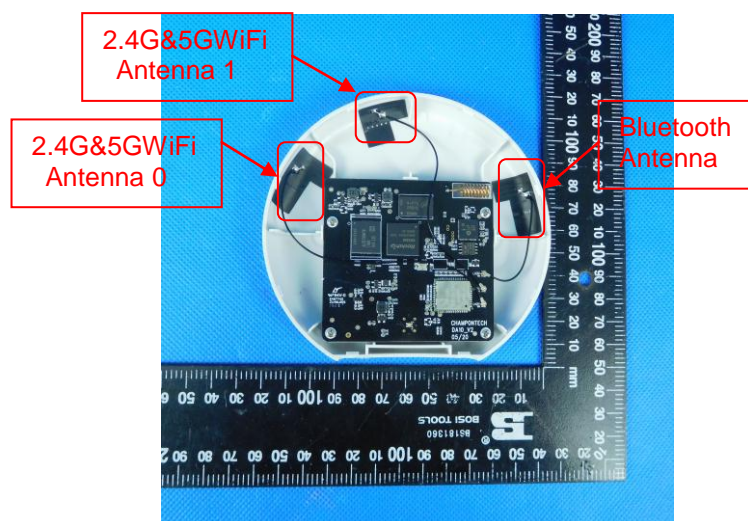

## 5.2. Conducted Emissions (AC Main)

### LIMIT

#### FCC CFR Title 47 Part 15 Subpart C Section 15.207

Frequency range (MHz)	Limit (dBuV)	
	Quasi-peak	Average
0.15-0.5	66 to 56*	56 to 46*
0.5-5	56	46
5-30	60	50

\* Decreases with the logarithm of the frequency.

### TEST CONFIGURATION

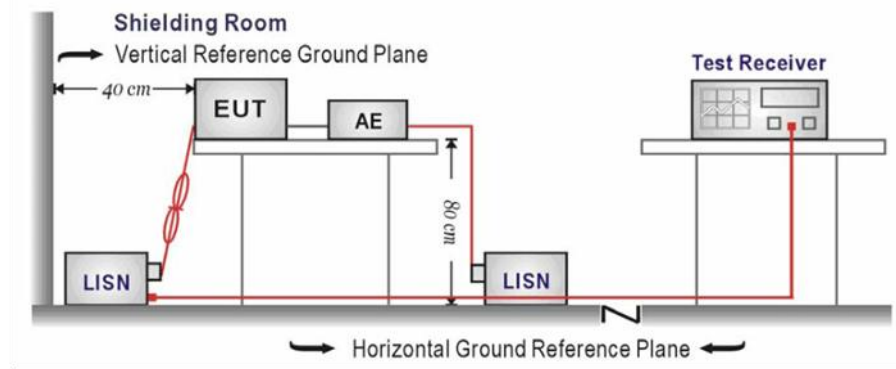

### TEST PROCEDURE

1. The EUT was setup according to ANSI C63.10:2013 requirements.
2. The EUT was placed on a platform of nominal size, 1 m by 1.5 m, raised 80 cm above the conducting ground plane. The vertical conducting plane was located 40 cm to the rear of the EUT. All other surfaces of EUT were at least 80 cm from any other grounded conducting surface.
3. The EUT and simulators are connected to the main power through a line impedances stabilization network (LISN). The LISN provides a 50 ohm /50uH coupling impedance for the measuring equipment.
4. The peripheral devices are also connected to the main power through a LISN. (Please refer to the block diagram of the test setup and photographs)
5. Each current-carrying conductor of the EUT power cord, except the ground (safety) conductor, was individually connected through a LISN to the input power source.
6. The excess length of the power cord between the EUT and the LISN receptacle were folded back and forth at the center of the lead to form a bundle not exceeding 40 cm in length.
7. Conducted emissions were investigated over the frequency range from 0.15MHz to 30MHz using a receiver bandwidth of 9 kHz.
8. During the above scans, the emissions were maximized by cable manipulation.

### TEST MODE:

Please refer to the clause 3.3

### TEST RESULTS

Passed       Not Applicable

Note:

- 1) Transd = Cable lose + Pulse Limiter Factor + Artificial Mains Factor
- 2) Margin = Limit - Level

Test Line:

L

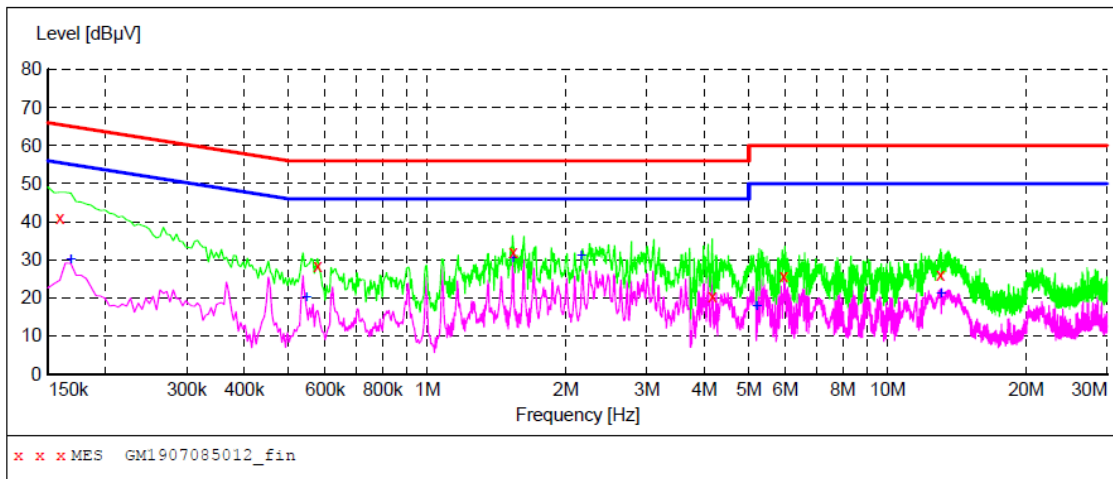

Frequency MHz	Level dBµV	Transd dB	Limit dBµV	Margin dB	Detector	Line	PE
0.159000	41.00	9.9	66	24.5	QP	L1	GND
0.577500	28.50	9.9	56	27.5	QP	L1	GND
1.536000	32.20	9.9	56	23.8	QP	L1	GND
4.164000	20.40	9.9	56	35.6	QP	L1	GND
5.941500	25.80	10.0	60	34.2	QP	L1	GND
13.033500	25.90	10.1	60	34.1	QP	L1	GND
Frequency MHz	Level dBµV	Transd dB	Limit dBµV	Margin dB	Detector	Line	PE
0.168000	30.10	9.9	55	25.0	AV	L1	GND
0.546000	20.00	9.9	46	26.0	AV	L1	GND
1.536000	30.30	9.9	46	15.7	AV	L1	GND
2.161500	31.00	9.9	46	15.0	AV	L1	GND
5.199000	17.90	10.0	50	32.1	AV	L1	GND
13.060500	21.10	10.1	50	28.9	AV	L1	GND

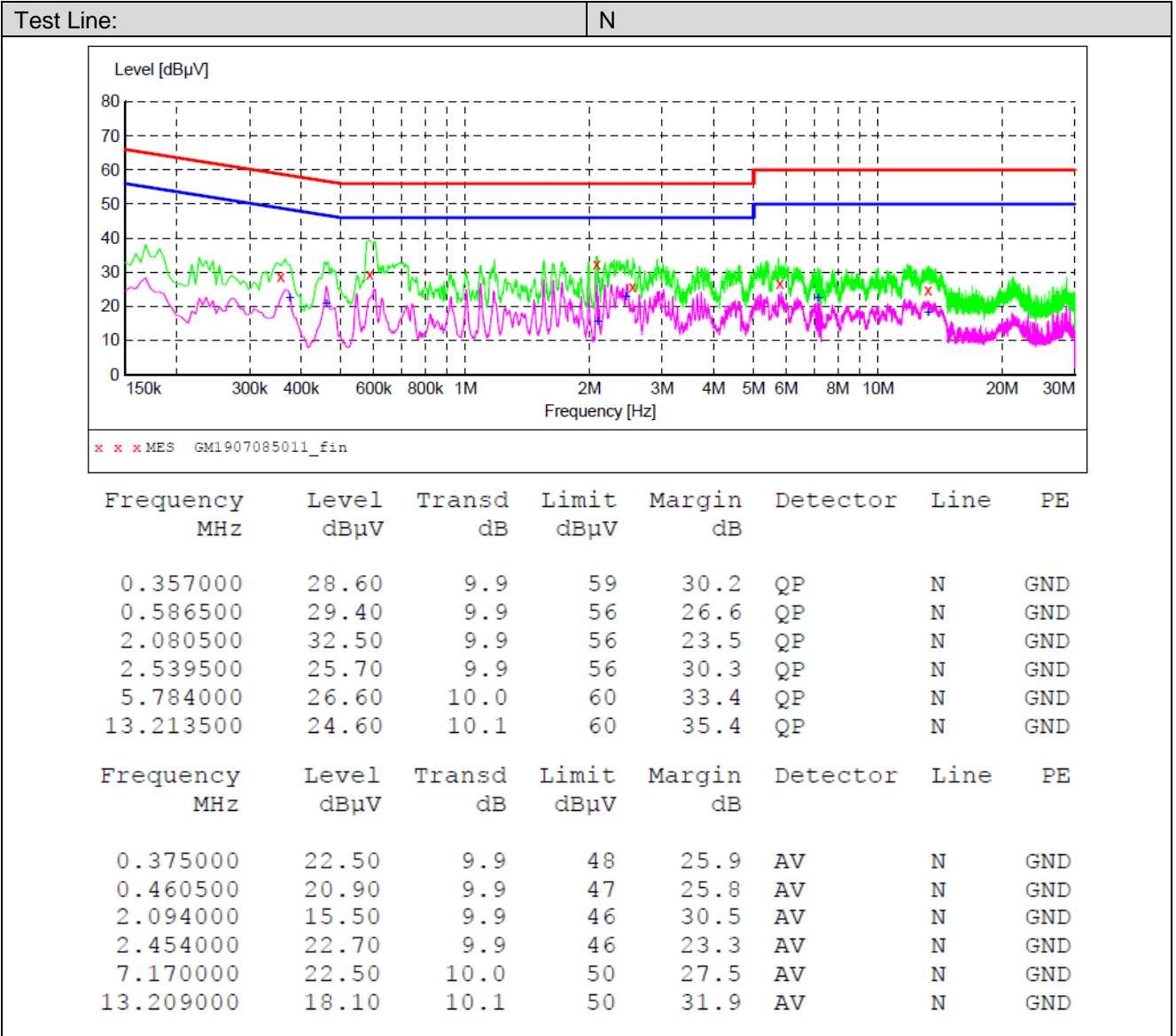

### 5.3. Conducted Peak Output Power

#### LIMIT

FCC CFR Title 47 Part 15 Subpart C Section 15.247 (b)(3): 30 dBm

#### TEST CONFIGURATION

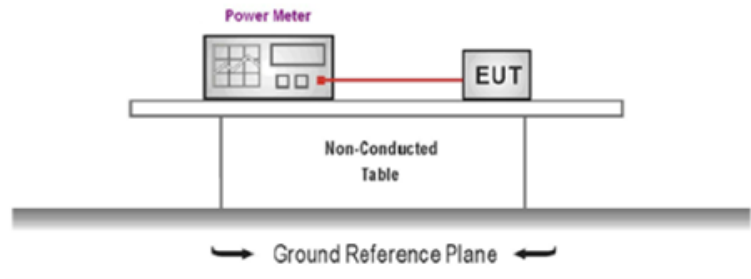

#### TEST PROCEDURE

1. The EUT was tested according to ANSI C63.10: 2013 and KDB 558074 D01 for compliance to FCC 47 CFR 15.247 requirements.
2. The maximum peak conducted output power may be measured using a broadband peak RF power meter.
3. The power meter shall have a video bandwidth that is greater than or equal to the DTS bandwidth and shall utilize a fast-responding diode detector.
4. Record the measurement data.

#### TEST MODE:

Please refer to the clause 3.3

#### TEST RESULTS

Passed       Not Applicable

Type	Channel	Output power (dBm)	Limit (dBm)	Result
BT-BLE	00	12.28	≤30.00	Pass
	19	12.79		
	39	12.44		

### 5.4. Power Spectral Density

#### LIMIT

#### FCC CFR Title 47 Part 15 Subpart C Section 15.247 (e):

For digitally modulated systems, the power spectral density conducted from the intentional radiator to the antenna shall not be greater than 8 dBm in any 3 kHz band during any time interval of continuous transmission.

#### TEST CONFIGURATION

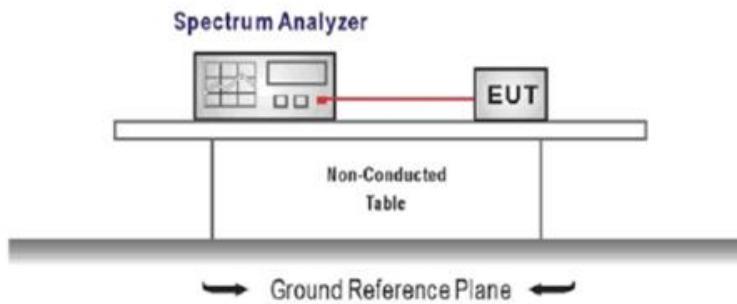

#### TEST PROCEDURE

1. Connect the antenna port(s) to the spectrum analyzer input,
2. Configure the spectrum analyzer as shown below:  
 Center frequency=DTS channel center frequency  
 Span =1.5 times the DTS bandwidth  
 RBW = 3 kHz ≤ RBW ≤ 100 kHz, VBW ≥ 3 × RBW  
 Sweep time = auto couple  
 Detector = peak  
 Trace mode = max hold
3. Place the radio in continuous transmit mode, allow the trace to stabilize, view the transmitter wave form on the spectrum analyzer.
4. Use the peak marker function to determine the maximum amplitude level within the RBW.
5. If measured value exceeds limit, reduce RBW (no less than 3 kHz) and repeat.

#### TEST MODE:

Please refer to the clause 3.3

#### TEST RESULTS

Passed       Not Applicable

Type	Channel	Power Spectral Density(dBm/3KHz)	Limit (dBm/3KHz)	Result
BT-BLE	00	-2.81	≤8.00	Pass
	19	-3.36		
	39	-2.11		

Test plot as follows:



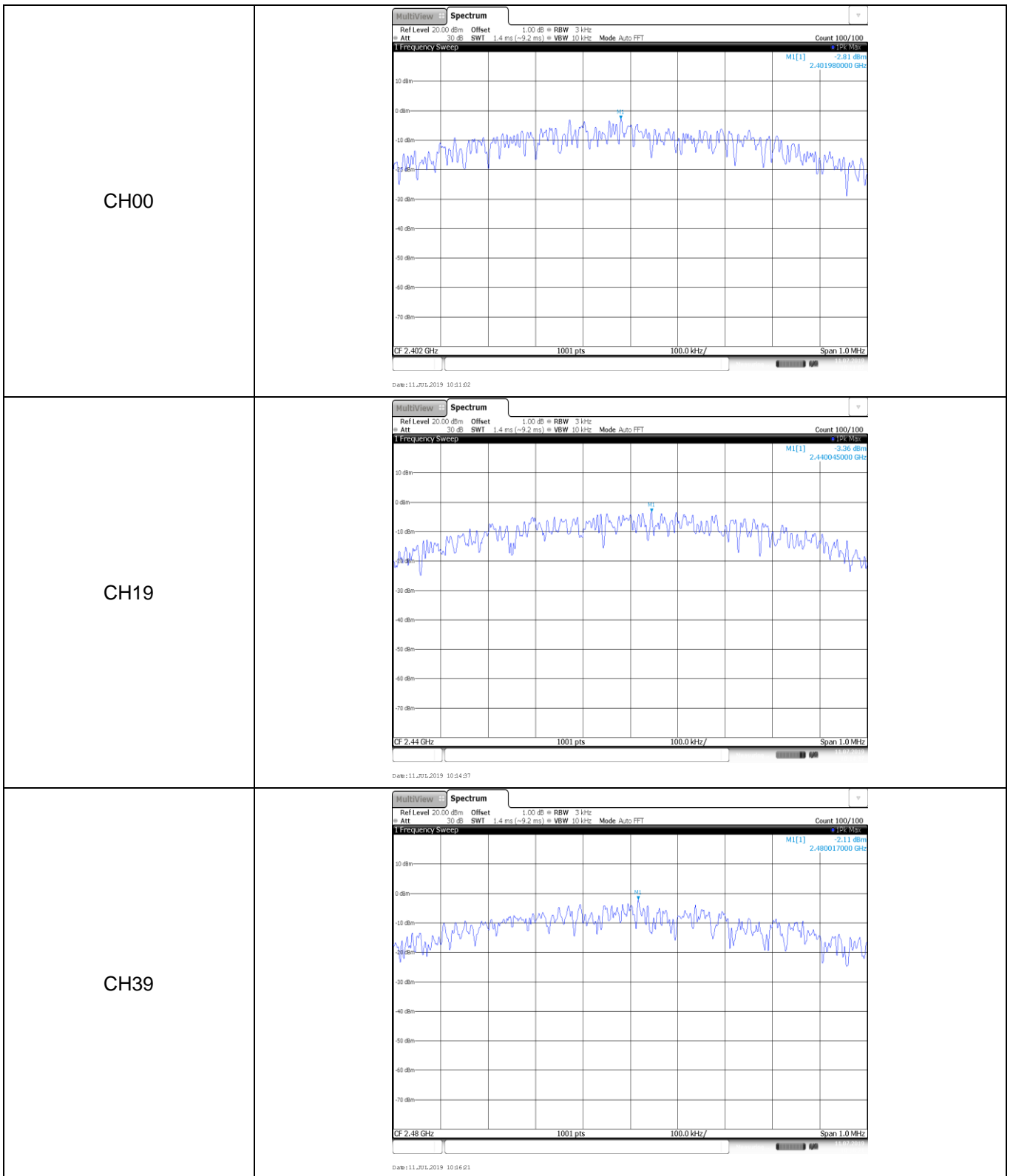

**5.5. 6dB bandwidth**

**LIMIT**

**FCC CFR Title 47 Part 15 Subpart C Section 15.247 (a)(2):**

For digital modulation systems, the minimum 6 dB bandwidth shall be at least 500 kHz.

**TEST CONFIGURATION**

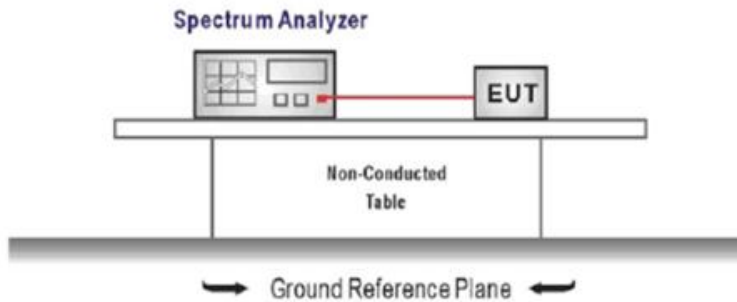

**TEST PROCEDURE**

1. Connect the antenna port(s) to the spectrum analyzer input.
2. Configure the spectrum analyzer as shown below (enter all losses between the transmitter output and the spectrum analyzer).  
 Center Frequency =DTS channel center frequency  
 Span=2 x DTS bandwidth  
 RBW = 100 kHz, VBW ≥ 3 × RBW  
 Sweep time= auto couple  
 Detector = Peak  
 Trace mode = max hold
3. Place the radio in continuous transmit mode, allow the trace to stabilize, view the transmitter waveform on the spectrum analyzer.
4. Measure the maximum width of the emission that is constrained by the frequencies associated with the two outermost amplitude points (upper and lower frequencies) that are attenuated by 6 dB relative to the maximum level measured in the fundamental emission, and record the pertinent measurements.

**TEST MODE:**

Please refer to the clause 3.3

**TEST RESULTS**

Passed       Not Applicable

Type	Channel	6dB Bandwidth(MHz)	Limit (kHz)	Result
BT-BLE	00	0.75	≥500	Pass
	19	0.75		
	39	0.75		

Test plot as follows:

CH00

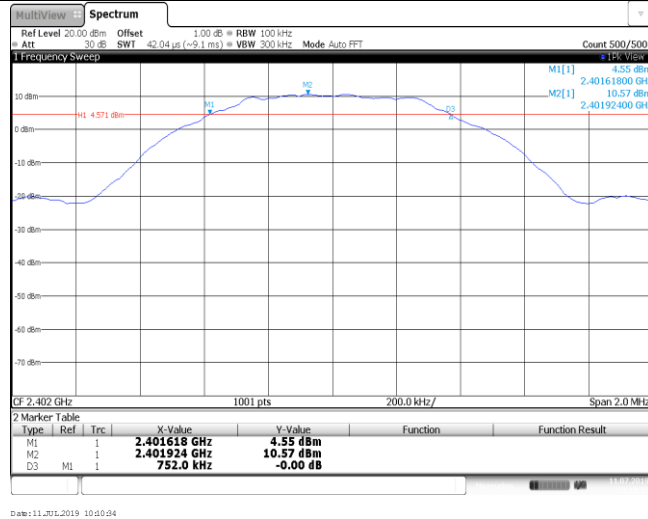

CH19

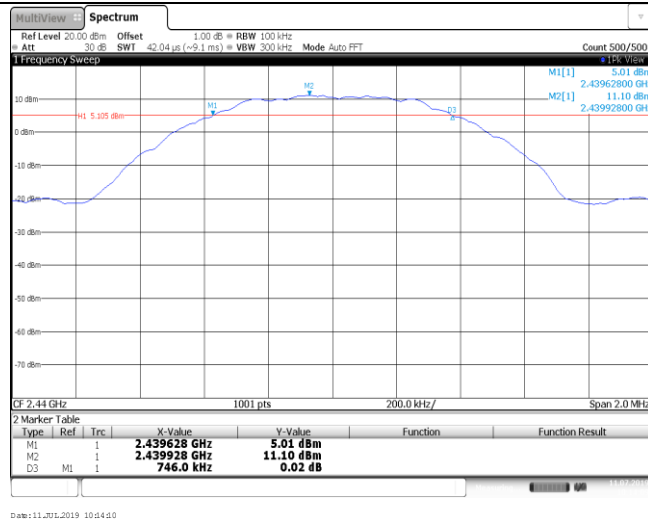

CH39

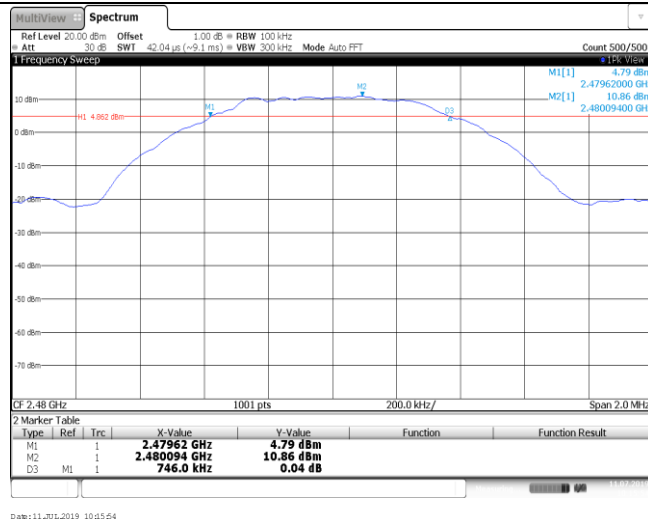

## 5.6. Restricted band

### LIMIT

#### **FCC CFR Title 47 Part 15 Subpart C Section 15.247 (d):**

In any 100 kHz bandwidth outside the frequency band in which the spread spectrum or digitally modulated intentional radiator is operating, Radiated Emissions which fall in the restricted bands, as defined in §15.205(a), must also comply with the Radiated Emissions limits specified in §15.209(a) (see §15.205(c)).

### TEST CONFIGURATION

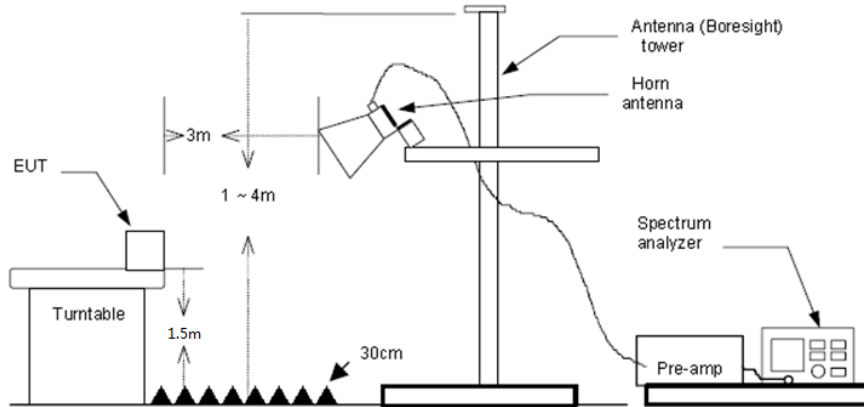

### TEST PROCEDURE

1. The EUT was setup and tested according to ANSI C63.10:2013 for compliance to FCC 47CFR 15.247 requirements.
2. The EUT is placed on a turn table which is 1.5 meter above ground. The turn table is rotated 360 degrees to determine the position of the maximum emission level.
3. The EUT was positioned such that the distance from antenna to the EUT was 3 meters.
4. The antenna is scanned from 1 meter to 4 meters to find out the maximum emission level. This is repeated for both horizontal and vertical polarization of the antenna. In order to find the maximum emission, all of the interface cables were manipulated according to ANSI C63.10:2013 on radiated measurement.
5. The receiver set as follow:  
 RBW=1MHz, VBW=3MHz Peak detector for Peak value.  
 RBW=1MHz, VBW=3MHz RMS detector for Average value.

### TEST MODE:

Please refer to the clause 3.3

### TEST RESULTS

Passed       Not Applicable

#### Note:

- 1) Final level= Read level + Antenna Factor+ Cable Loss- Preamp Factor
- 2) The peak level is lower than average limit(54 dBuV/m), this data is the too weak instrument of signal is unable to test.

Test channel				CH00			
Freq. [MHz]	Reading [dB $\mu$ V/m]	Factor [dB]	Level [dB $\mu$ V/m]	Limit [dB $\mu$ V/m]	Margin [dB]	Polarity	Detector
2310.0045	52.59	-2.34	50.25	74.00	23.75	Vertical	Peak
2390.0004	51.39	-2.41	48.98	74.00	25.02	Vertical	Peak
2310.0045	45.35	-2.34	43.01	54.00	10.99	Vertical	Average
2390.0004	44.68	-2.41	42.27	54.00	11.73	Vertical	Average
2310.0045	52.85	-2.34	50.51	74.00	23.49	Horizontal	Peak
2390.0138	52.39	-2.41	49.98	74.00	24.02	Horizontal	Peak
2310.0045	46.27	-2.34	43.93	54.00	10.07	Horizontal	Average
2390.0138	45.57	-2.41	43.16	54.00	10.84	Horizontal	Average

Test channel				CH39			
Freq. [MHz]	Reading [dB $\mu$ V/m]	Factor [dB]	Level [dB $\mu$ V/m]	Limit [dB $\mu$ V/m]	Margin [dB]	Polarity	Detector
2483.5000	61.83	-2.15	59.68	74.00	14.32	Horizontal	Peak
2500.0000	58.46	-2.10	56.36	74.00	17.64	Horizontal	Peak
2483.5000	54.72	-2.15	52.57	54.00	1.43	Horizontal	Average
2500.0000	45.26	-2.10	43.16	54.00	10.84	Horizontal	Average
2483.5000	58.35	-2.15	56.20	74.00	17.80	Vertical	Peak
2500.0000	57.15	-2.10	55.05	74.00	18.95	Vertical	Peak
2483.5000	55.12	-2.15	52.97	54.00	1.03	Vertical	Average
2500.0000	46.27	-2.10	44.17	54.00	9.83	Vertical	Average

## 5.7. Band edge and Spurious Emissions (conducted)

### LIMIT

**FCC CFR Title 47 Part 15 Subpart C Section 15.247 (d):** In any 100 kHz bandwidth outside the frequency band in which the spread spectrum intentional radiator is operating, the radio frequency power that is produced by the intentional radiator shall be at least 20 dB below that in the 100 kHz bandwidth within the band that contains the highest level of the desired power, based on either an RF conducted or a radiated measurement.

### TEST CONFIGURATION

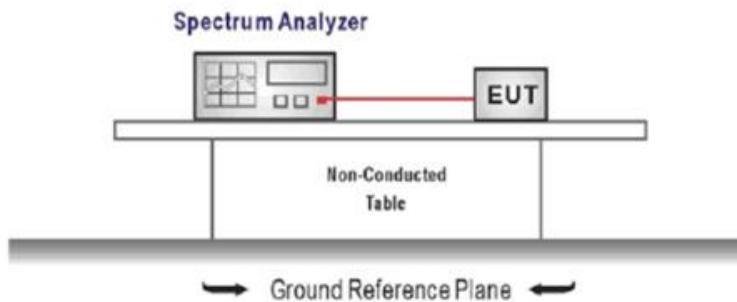

### TEST PROCEDURE

1. Connect the antenna port(s) to the spectrum analyzer input.
2. Establish a reference level by using the following procedure  
Center frequency=DTS channel center frequency  
The span = 1.5 times the DTS bandwidth.  
RBW = 100 kHz, VBW  $\geq$  3 x RBW  
Detector = peak, Sweep time = auto couple, Trace mode = max hold  
Allow trace to fully stabilize  
Use the peak marker function to determine the maximum PSD level

Note that the channel found to contain the maximum PSD level can be used to establish the reference level.

3. Emission level measurement  
Set the center frequency and span to encompass frequency range to be measured  
RBW = 100 kHz, VBW  $\geq$  3 x RBW  
Detector = peak, Sweep time = auto couple, Trace mode = max hold  
Allow trace to fully stabilize  
Use the peak marker function to determine the maximum amplitude level.
4. Place the radio in continuous transmit mode, allow the trace to stabilize, view the transmitter waveform on the spectrum analyzer.
5. Ensure that the amplitude of all unwanted emission outside of the authorized frequency band excluding restricted frequency bands) are attenuated by at least the minimum requirements specified (at least 20 dB relative to the maximum in-band peak PSD level in 100 kHz). Report the three highest emission relative to the limit.

### TEST MODE:

Please refer to the clause 3.3

### TEST RESULTS

Passed       Not Applicable

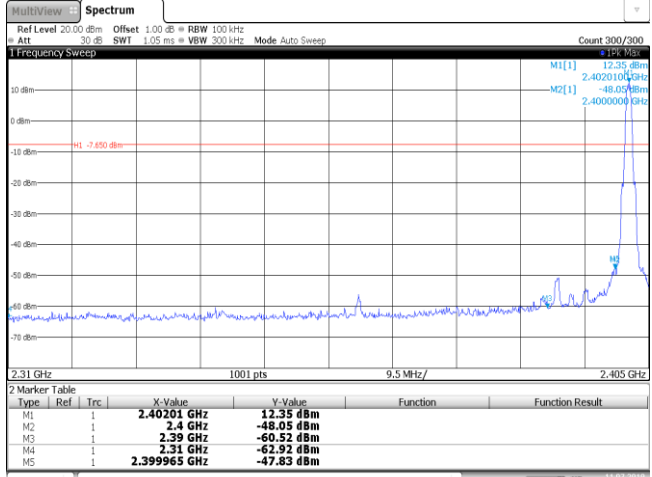
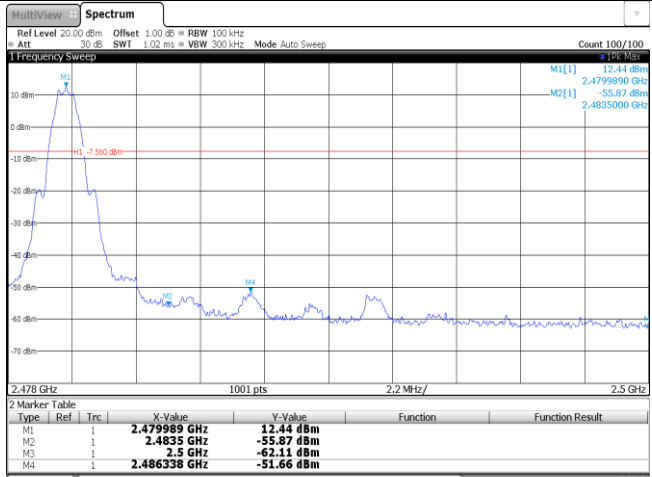
Test Item:	Band edge																																										
<p>CH00</p>	 <p>2 Marker Table</p> <table border="1"> <thead> <tr> <th>Type</th> <th>Ref</th> <th>Trc</th> <th>X-Value</th> <th>Y-Value</th> <th>Function</th> <th>Function Result</th> </tr> </thead> <tbody> <tr> <td>M1</td> <td>1</td> <td></td> <td>2.40201 GHz</td> <td>12.35 dBm</td> <td></td> <td></td> </tr> <tr> <td>M2</td> <td>1</td> <td></td> <td>2.4 GHz</td> <td>-48.05 dBm</td> <td></td> <td></td> </tr> <tr> <td>M3</td> <td>1</td> <td></td> <td>2.39 GHz</td> <td>-60.52 dBm</td> <td></td> <td></td> </tr> <tr> <td>M4</td> <td>1</td> <td></td> <td>2.31 GHz</td> <td>-62.92 dBm</td> <td></td> <td></td> </tr> <tr> <td>M5</td> <td>1</td> <td></td> <td>2.399965 GHz</td> <td>-47.83 dBm</td> <td></td> <td></td> </tr> </tbody> </table> <p>Date: 11 JUL 2019 10:11:13</p>	Type	Ref	Trc	X-Value	Y-Value	Function	Function Result	M1	1		2.40201 GHz	12.35 dBm			M2	1		2.4 GHz	-48.05 dBm			M3	1		2.39 GHz	-60.52 dBm			M4	1		2.31 GHz	-62.92 dBm			M5	1		2.399965 GHz	-47.83 dBm		
Type	Ref	Trc	X-Value	Y-Value	Function	Function Result																																					
M1	1		2.40201 GHz	12.35 dBm																																							
M2	1		2.4 GHz	-48.05 dBm																																							
M3	1		2.39 GHz	-60.52 dBm																																							
M4	1		2.31 GHz	-62.92 dBm																																							
M5	1		2.399965 GHz	-47.83 dBm																																							
<p>CH39</p>	 <p>2 Marker Table</p> <table border="1"> <thead> <tr> <th>Type</th> <th>Ref</th> <th>Trc</th> <th>X-Value</th> <th>Y-Value</th> <th>Function</th> <th>Function Result</th> </tr> </thead> <tbody> <tr> <td>M1</td> <td>1</td> <td></td> <td>2.479989 GHz</td> <td>12.44 dBm</td> <td></td> <td></td> </tr> <tr> <td>M2</td> <td>1</td> <td></td> <td>2.4835 GHz</td> <td>-55.87 dBm</td> <td></td> <td></td> </tr> <tr> <td>M3</td> <td>1</td> <td></td> <td>2.5 GHz</td> <td>-62.11 dBm</td> <td></td> <td></td> </tr> <tr> <td>M4</td> <td>1</td> <td></td> <td>2.486338 GHz</td> <td>-51.66 dBm</td> <td></td> <td></td> </tr> </tbody> </table> <p>Date: 11 JUL 2019 10:16:32</p>	Type	Ref	Trc	X-Value	Y-Value	Function	Function Result	M1	1		2.479989 GHz	12.44 dBm			M2	1		2.4835 GHz	-55.87 dBm			M3	1		2.5 GHz	-62.11 dBm			M4	1		2.486338 GHz	-51.66 dBm									
Type	Ref	Trc	X-Value	Y-Value	Function	Function Result																																					
M1	1		2.479989 GHz	12.44 dBm																																							
M2	1		2.4835 GHz	-55.87 dBm																																							
M3	1		2.5 GHz	-62.11 dBm																																							
M4	1		2.486338 GHz	-51.66 dBm																																							

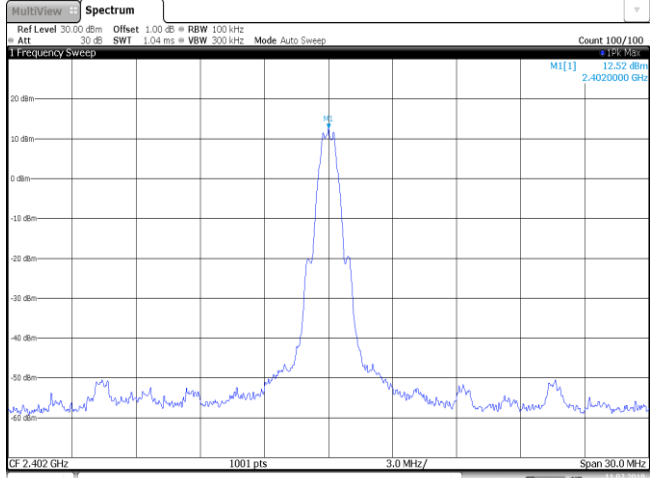
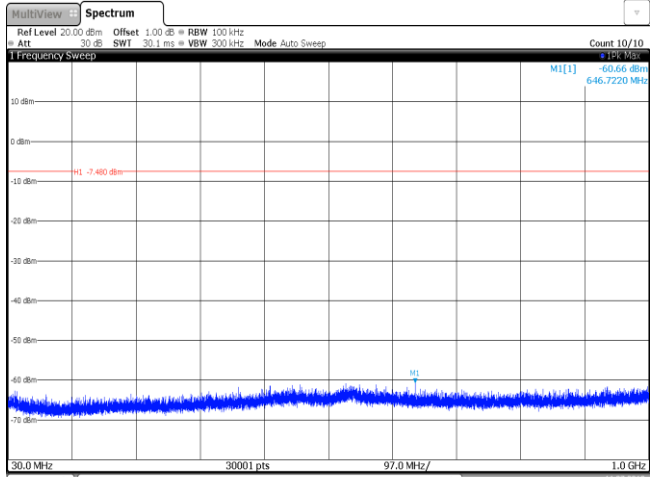
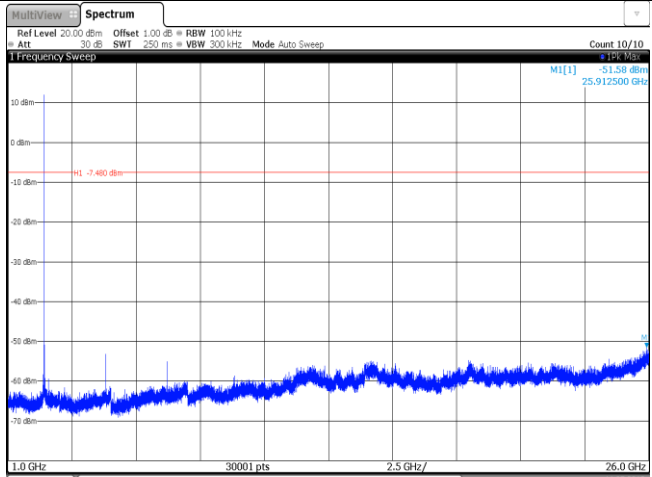
Test Item:	SE
CH00 Reference level	 <p>MultiView Spectrum Ref Level 30.00 dBm Offset 1.00 dB RBW 100 kHz Att 30 dB SWI 1.04 ms VBW 300 kHz Mode Auto Sweep Count 100/100 1 Frequency Sweep M1[1] 12.52 dBm 2.402000 GHz CF 2.402 GHz 1001 pts 3.0 MHz/ Span 30.0 MHz Date: 11.201.2019 10:11:22</p>
CH00 30MHz~1000MHz	 <p>MultiView Spectrum Ref Level 20.00 dBm Offset 1.00 dB RBW 100 kHz Att 30 dB SWI 30.1 ms VBW 300 kHz Mode Auto Sweep Count 10/10 1 Frequency Sweep M1[1] -60.66 dBm 646.7220 MHz M1 -7.480 dBm 30.0 MHz 30001 pts 97.0 MHz/ 1.0 GHz Date: 11.201.2019 10:11:40</p>
CH00 1GHz~26GHz	 <p>MultiView Spectrum Ref Level 20.00 dBm Offset 1.00 dB RBW 100 kHz Att 30 dB SWI 250 ms VBW 300 kHz Mode Auto Sweep Count 10/10 1 Frequency Sweep M1[1] -51.58 dBm 25.912500 GHz M1 -7.480 dBm 1.0 GHz 30001 pts 2.5 GHz/ 26.0 GHz Date: 11.201.2019 10:11:57</p>



CH19  
Reference level

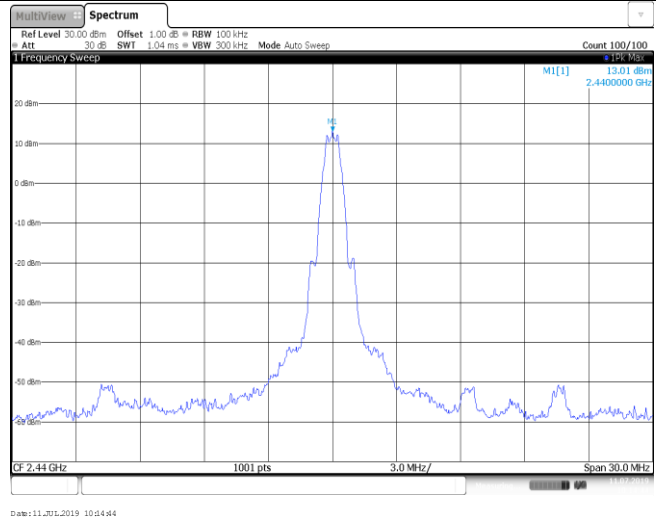

CH19  
30MHz~1000MHz

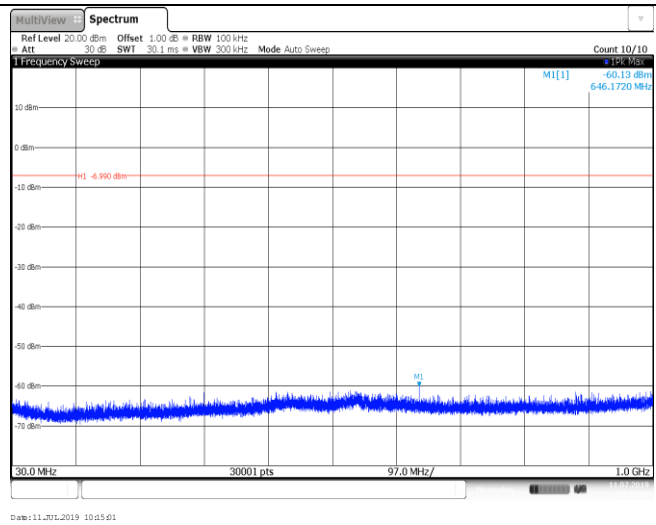

CH19  
1GHz~26GHz

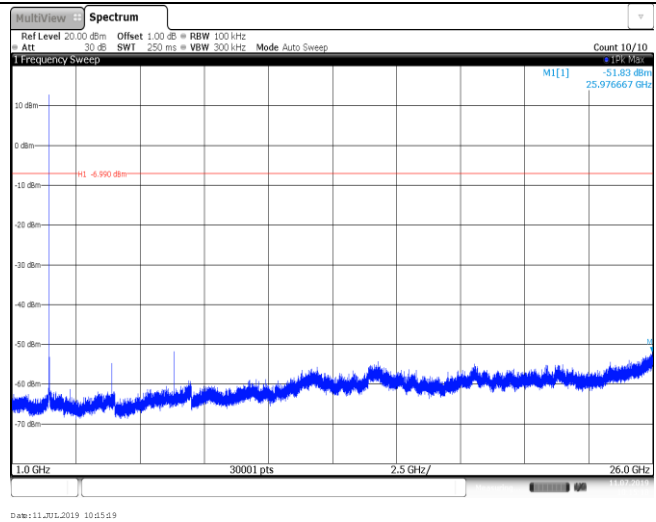

CH39  
Reference level

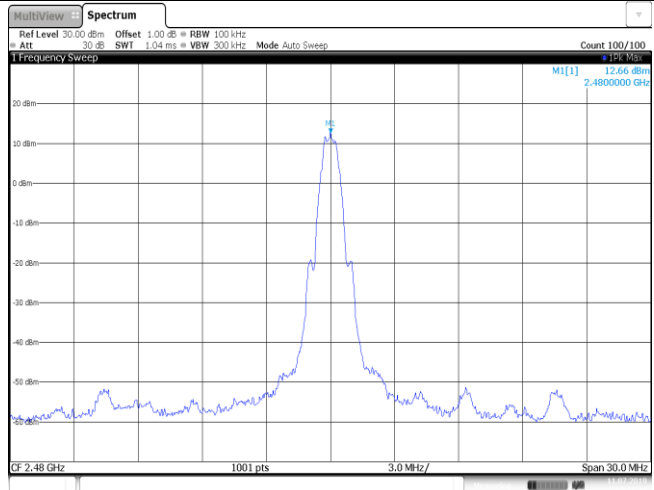

CH39  
30MHz~1000MHz

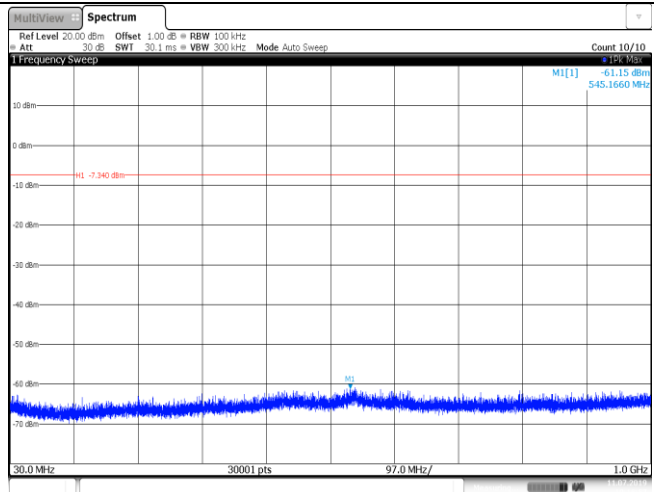

CH39  
1GHz~26GHz

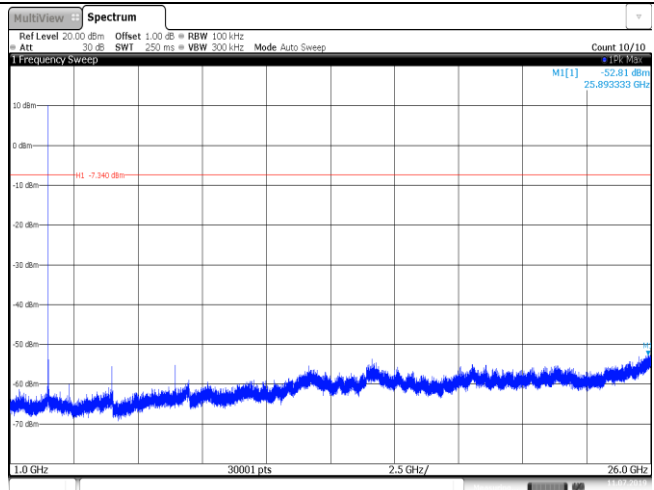

### 5.8. Spurious Emissions (radiated)

#### LIMIT

#### FCC CFR Title 47 Part 15 Subpart C Section 15.209

Frequency	Limit (dBuV/m @3m)	Value
30MHz~88MHz	40.00	Quasi-peak
88MHz~216MHz	43.50	Quasi-peak
216MHz~960MHz	46.00	Quasi-peak
960MHz~1GHz	54.00	Quasi-peak
Above 1GHz	54.00	Average
	74.00	Peak

#### TEST CONFIGURATION

- 9 kHz ~ 30 MHz

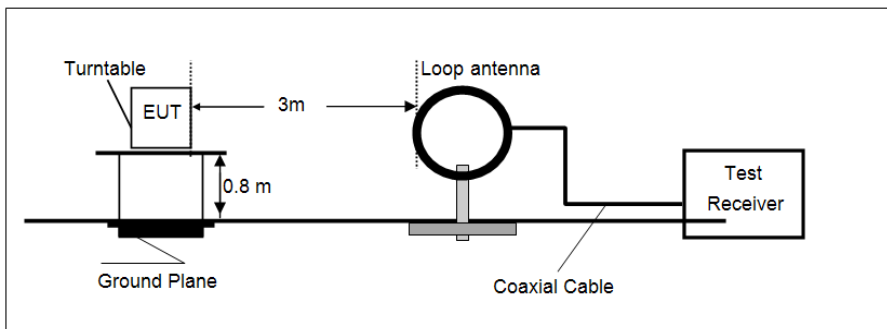

- 30 MHz ~ 1 GHz

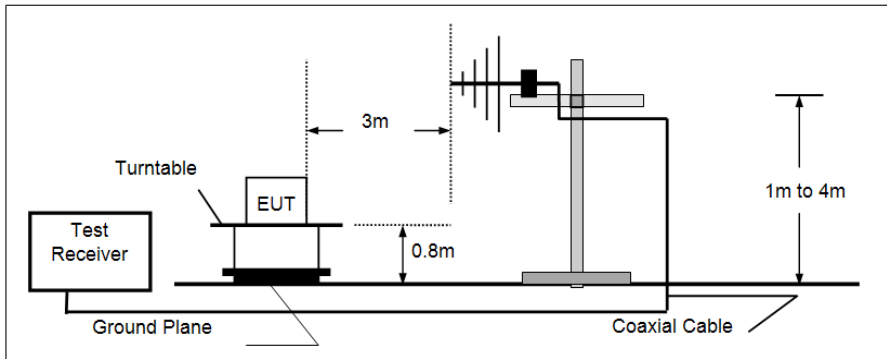

- Above 1 GHz

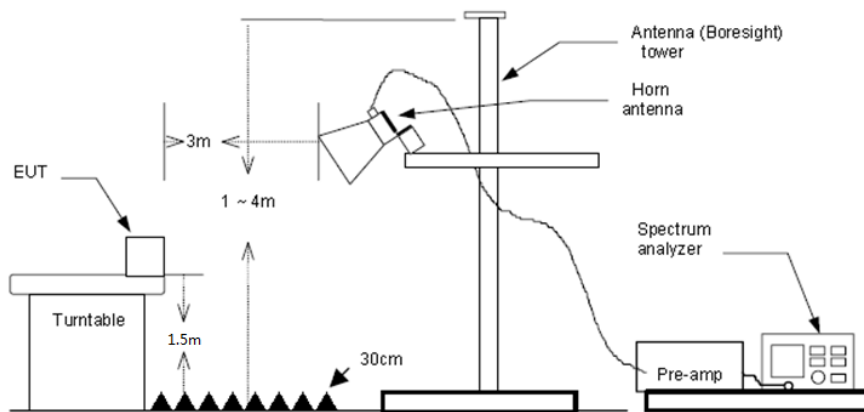

**TEST PROCEDURE**

1. The EUT was setup and tested according to ANSI C63.10:2013 for compliance to FCC 47CFR 15.247 requirements.
2. The EUT is placed on a turn table which is 0.8 meter above ground for below 1 GHz, and 1.5 m for above 1 GHz. The turn table is rotated 360 degrees to determine the position of the maximum emission level.
3. The EUT was set 3 meters from the receiving antenna, which was mounted on the top of a variable height antenna tower.
4. For each suspected emission, the EUT was arranged to its worst case and then tune the Antenna tower (from 1 m to 4 m) and turntable (from 0 degree to 360 degrees) to find the maximum reading. A pre-amp and a high pass filter are used for the test in order to get better signal level to comply with the guidelines.
5. Set to the maximum power setting and enable the EUT transmit continuously.
6. Use the following spectrum analyzer settings
  - (1) Span shall wide enough to fully capture the emission being measured;
  - (2) Below 1 GHz:  
RBW=120 kHz, VBW=300 kHz, Sweep=auto, Detector function=peak, Trace=max hold;  
If the emission level of the EUT measured by the peak detector is 3 dB lower than the applicable limit, the peak emission level will be reported. Otherwise, the emission measurement will be repeated using the quasi-peak detector and reported.
  - (3) From 1 GHz to 10<sup>th</sup> harmonic:  
RBW=1MHz, VBW=3MHz Peak detector for Peak value.  
RBW=1MHz, VBW=3MHz RMS detector for Average value.

**TEST MODE:**

Please refer to the clause 3.3

**TEST RESULTS**

**Passed**       **Not Applicable**

Note:

- 1) Above 1GHz Final Level =Receiver Read level + Antenna Factor + Cable Loss – Preamplifier Factor
  - 2) The emission levels of other frequencies are very lower than the limit and not show in test report.
- **9 kHz ~ 30 MHz**  
The EUT was pre-scanned the frequency band (9 kHz ~ 30 MHz), found the radiated level lower than the limit, so don't show on the report.
- **30 MHz ~ 1000 MHz**  
Have pre-scan all modulation mode, found the BT-BLE mode CH39 which it was worst case, so only the worst case's data on the test report.

➤ 30 MHz ~ 1 GHz

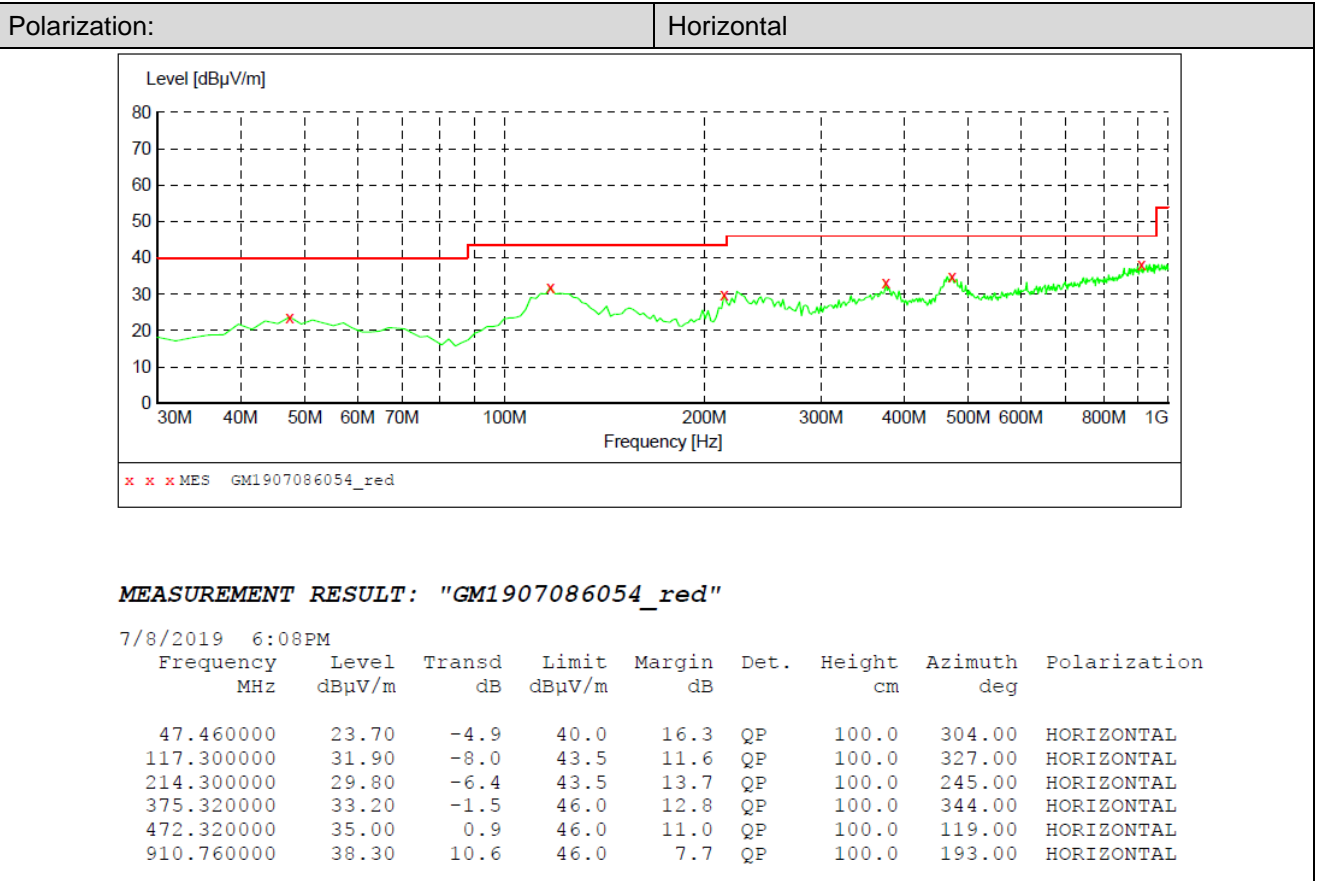
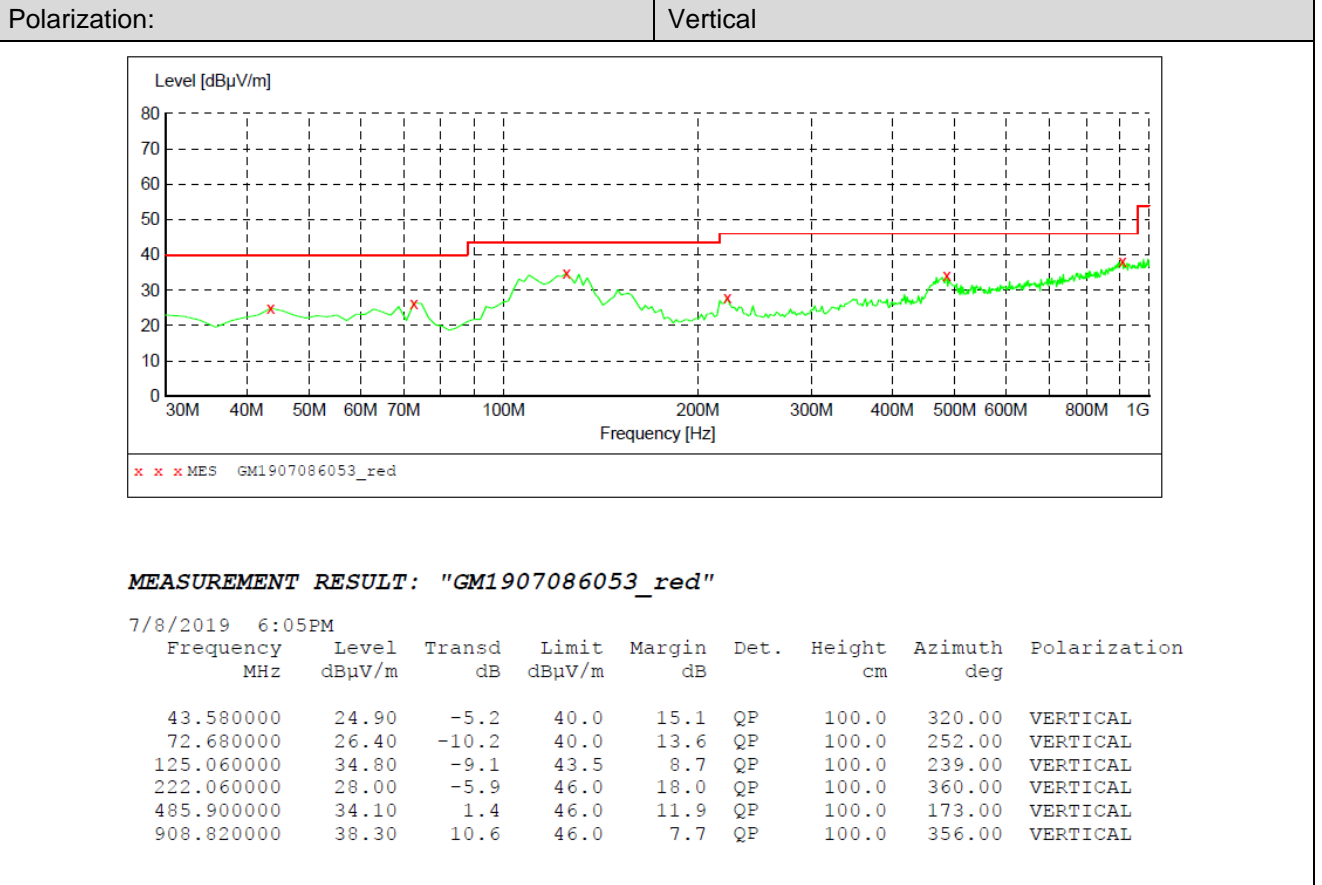

## ➤ 1 GHz ~ 25 GHz

Test channel				CH00			
Freq. [MHz]	Reading [dB $\mu$ V/m]	Factor [dB]	Level [dB $\mu$ V/m]	Limit [dB $\mu$ V/m]	Margin [dB]	Polarity	Detector
1583.0938	34.50	-6.17	28.33	74.00	45.67	Vertical	Peak
3157.5938	40.50	0.62	41.12	74.00	32.88	Vertical	Peak
5074.3125	31.40	8.56	39.96	74.00	34.04	Vertical	Peak
5796.9375	32.16	9.53	41.69	74.00	32.31	Vertical	Peak
1712.3438	34.04	-6.06	27.98	74.00	46.02	Horizontal	Peak
3050.3750	33.52	0.10	33.62	74.00	40.38	Horizontal	Peak
3880.2188	32.36	2.54	34.90	74.00	39.10	Horizontal	Peak
5190.3438	30.98	8.96	39.94	74.00	34.06	Horizontal	Peak

Test channel				CH19			
Freq. [MHz]	Reading [dB $\mu$ V/m]	Factor [dB]	Level [dB $\mu$ V/m]	Limit [dB $\mu$ V/m]	Margin [dB]	Polarity	Detector
1659.4688	33.78	-6.17	27.61	74.00	46.39	Horizontal	Peak
3194.3125	34.26	0.81	35.07	74.00	38.93	Horizontal	Peak
5883.5938	32.11	9.91	42.02	74.00	31.98	Horizontal	Peak
6667.9063	32.49	13.37	45.86	74.00	28.14	Horizontal	Peak
1199.7500	35.55	-5.83	29.72	74.00	44.28	Vertical	Peak
3448.4063	36.21	0.43	36.64	74.00	37.36	Vertical	Peak
4784.9688	36.02	6.95	42.97	74.00	31.03	Vertical	Peak
7321.5000	34.45	16.12	50.57	74.00	23.43	Vertical	Peak

Test channel				CH39			
Freq. [MHz]	Reading [dB $\mu$ V/m]	Factor [dB]	Level [dB $\mu$ V/m]	Limit [dB $\mu$ V/m]	Margin [dB]	Polarity	Detector
1637.4375	34.24	-6.21	28.03	74.00	45.97	Vertical	Peak
3104.7188	39.03	0.34	39.37	74.00	34.63	Vertical	Peak
3703.9688	33.64	1.61	35.25	74.00	38.75	Vertical	Peak
4780.5625	35.92	6.92	42.84	74.00	31.16	Vertical	Peak
1403.9063	33.24	-5.58	27.66	74.00	46.34	Horizontal	Peak
3189.9063	35.10	0.79	35.89	74.00	38.11	Horizontal	Peak
4157.8125	32.06	3.58	35.64	74.00	38.36	Horizontal	Peak
5128.6563	31.81	8.85	40.66	74.00	33.34	Horizontal	Peak

Remark:

1. Final Level = Receiver Read level + Antenna Factor + Cable Loss – Preamplifier Factor
2. The peak level is lower than average limit(54dB $\mu$ V/m), this data is the too weak instrument of signal is unable to test.
3. The emission levels of other frequencies are very lower than the limit and not show in test report.