

QooCam EGO



KANDA 

Quick Start Guide • 快速入门指南 • 快速入門指南

# 1

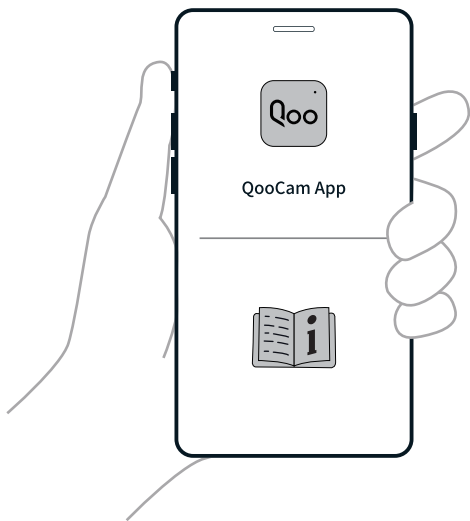

# 2

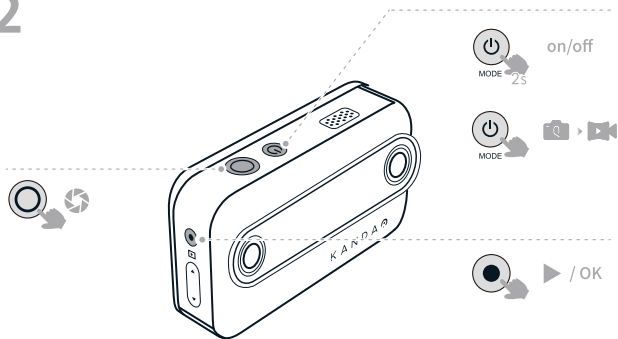

# 3

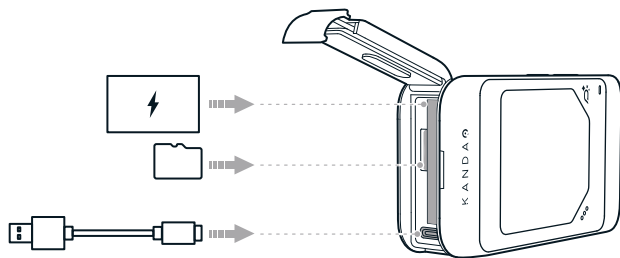

# 4

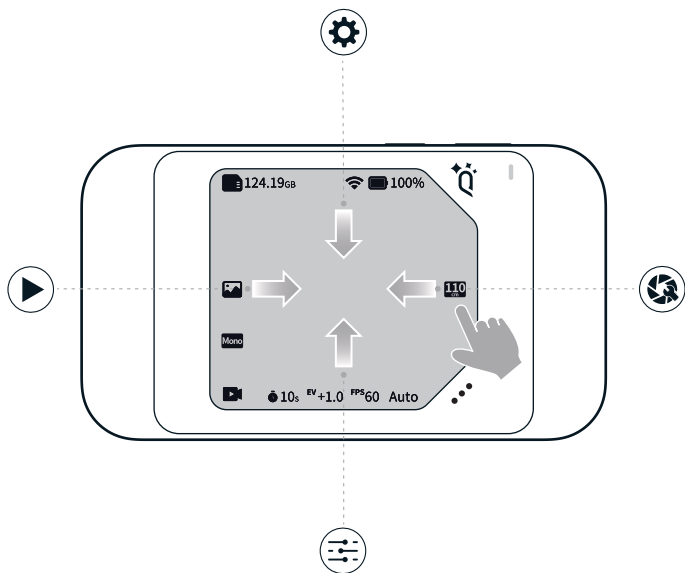

5

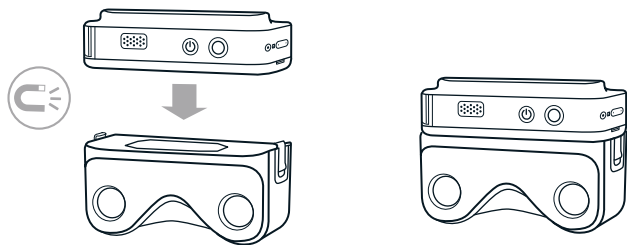

6

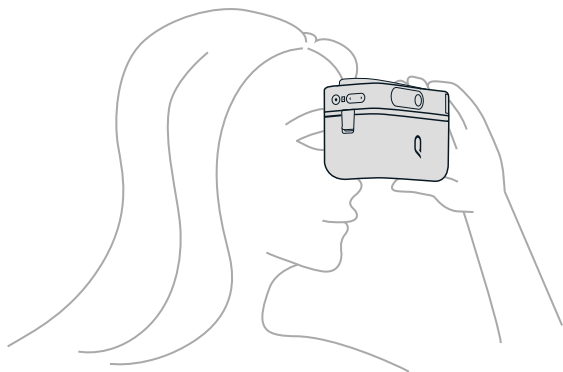

7

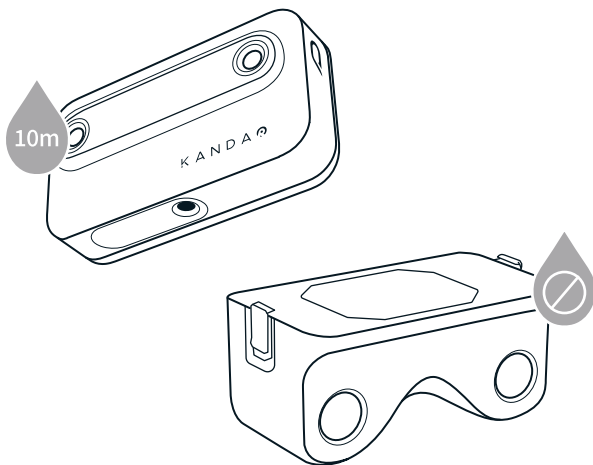

**Instructions for automatic shutdown at high temperature:**

High temperature mode: the internal temperature of the battery reaches 78°C

Standard mode: Case temperature reaches 48°, battery internal temperature reaches 64°

## FCC compliance statement

This device complies with Part 15 of the FCC Rules. Operation is subject to the following two conditions: (1) this device may not cause harmful interference, and (2) this device must accept any interference received, including interference that may cause undesired operation.

changes or modifications not expressly approved by the party responsible for compliance could void the user's authority to operate the equipment.

This equipment has been tested and found to comply with the limits for a Class B digital device, pursuant to Part 15 of the FCC Rules. These limits are designed to provide reasonable protection against harmful interference in a residential installation. This equipment generates, uses and can radiate radio frequency energy and, if not installed and used in accordance with the instructions, may cause harmful interference to radio communications. However, there is no guarantee that interference will not occur in a particular installation.

If this equipment does cause harmful interference to radio or television reception, which can be determined by turning the equipment off and on, the user is encouraged to try to correct the interference by one or more of the following measures:

- Reorient or relocate the receiving antenna.
- Increase the separation between the equipment and receiver.
- Connect the equipment into an outlet on a circuit different from that to which the receiver is connected.
- Consult the dealer or an experienced radio/TV technician for help.

# How to Check Regulatory Information

Step ① :Swipe Down from Top

Step ② :Go to "Settings" Page

Step ③ :Click "About" and Choose "Regulatory Info"

K A N D A O

www.kandaovr.com

Product Name: QooCam EGO

Model: QG7018

Manufacturer: KanDao Technology Co.,Ltd.

Address: 503, Building 1, Dayun Soft Parts Town, No. 8288, Longgang Avenue, Heao Community, Yuanshan Street, Longgang District, Shenzhen

产品名称: QooCam EGO

型号: QG7018

制造商: 深圳看到科技有限公司

地址: 深圳市龙岗区园山街道荷坳社区龙岗大道8288号大运软件小镇1栋503

產品名稱: QooCam EGO

型號: QG7018

製造商: 深圳看到科技有限公司

地址: 深圳市龍崗區園山街道荷坳社區龍崗大道8288號大運軟件小鎮1棟503



FCC ID:2ATPV-KDEG  
CMIIT ID:XXXXXXXXXX

