

Dates of Tests: April 15, 2019 ~ Jun 13, 2019
Test Report S/N: LR50011905S
Test Site : LTA CO., LTD.

CERTIFICATION OF COMPLIANCE

FCC ID.

2ATJKEM100-DEVICE

APPLICANT

Kuls co., Ltd.

Equipment Class	:	Digital Transmission System (DTS)
Manufacturing Description	:	Data Gathering Terminal
Manufacturer	:	Kuls co., Ltd.
Model name	:	EM100-DEVEICE
Test Device Serial No.:	:	Identical prototype
Rule Part(s)	:	FCC Part 15.247 Subpart C ; ANSI C63.10 - 2013
Frequency Range	:	917.09 ~ 923.30 MHz
Max. Output Power	:	Max 12.57 dBm - Conducted
Data of issue	:	Jun 13, 2019

This test report is issued under the authority of:

The test was supervised by:



Ja-Beom, Koo / Director

Hee-Cheon, Kwon, Test Engineer

This test result only responds to the tested sample. It is not allowed to copy this report even partly without the allowance of the test laboratory. The report must not be used by the client to claim product certification, approval, or endorsement by NVLAP, NIST, or any agency of the Federal Government.



NVLAP LAB Code.: 200723-0

TABLE OF CONTENTS

1. GENERAL INFORMATION	-----	3
2. INFORMATION ABOUT TEST ITEM	-----	4
3. TEST REPORT	-----	5
3.1 SUMMARY OF TESTS	-----	5
3.2 TECHNICAL CHARACTERISTICS TEST	-----	6
3.2.1 6 dB BANDWIDTH	-----	6
3.2.2 PEAK OUTPUT POWER	-----	10
3.2.3 POWER SPECTRAL DENSITY	-----	13
3.2.4 BAND EDGE	-----	16
3.2.5 CONDUCTED SPURIOUS EMISSIONS	-----	18
3.2.6 RADIATED SPURIOUS EMISSIONS	-----	21
3.2.7 AC CONDUCTED EMISSION	-----	31
APPENDIX		
APPENDIX TEST EQUIPMENT USED FOR TESTS	-----	34

1. General information

1-1 Test Performed

Company name : LTA Co., Ltd.
 Address : 243, Jubug-ri, Yangji-Myeon, Youngin-Si, Kyunggi-Do, Korea. 17159
 Web site : <http://www.ltalab.com>
 E-mail : chahn@ltalab.com
 Telephone : +82-31-323-6008
 Facsimile : +82-31-323-6010

Quality control in the testing laboratory is implemented as per ISO/IEC 17025 which is the “General requirements for the competents of calibration and testing laboratory”.

1-2 Accredited agencies

LTA Co., Ltd. is approved to perform EMC testing by the following agencies:

Agency	Country	Accreditation No.	Validity	Reference
NVLAP	U.S.A	200723-0	2019-09-30	ECT accredited Lab.
RRA	KOREA	KR0049	-	EMC accredited Lab.
FCC	U.S.A	649054	Updating	FCC CAB
VCCI	JAPAN	C-4948, T-2416, R-4483(10 m), G-847	2020-09-10 2020-09-10 2020-10-15 2022-06-13	VCCI registration
IC	CANADA	5799A-1	2019-11-07	IC filing
KOLAS	KOREA	NO.551	2021-08-20	KOLAS accredited Lab.

2. Information about test item

2-1 Client & Manufacturer

Company name : Kuls co., Ltd.
 Address : 16, Noksansandan 232-ro, gangseo-gu, Busan, Korea
 Tel / Fax : +82-51-941-2339

2-2 Equipment Under Test (EUT)

Model name : EM100-DEVICE
 Serial number : Identical prototype
 Date of receipt : April 15, 2019
 EUT condition : Pre-production, not damaged
 Antenna type : Dipole Antenna (Max Gain : 2.27 dBi)
 Frequency Range : 917.09 ~ 923.30 MHz
 RF output power : Max 12.57 dBm – Conducted
 Type of Modulation : FSK
 Power Source : 12 Vdc

2-3 Tested frequency

	LOW	MID	HIGH
Frequency (MHz) - LoRa	917.09	920.09	923.30

2-4 Ancillary Equipment

Equipment	Model No.	Serial No.	Manufacturer
Notebook	CR720	MS-1736	MSI

3. Test Report

3.1 Summary of tests

FCC Part Section(s)	Parameter	Test Condition	Status (note 1)
15.247(a)	6 dB Bandwidth	Conducted	C
15.247(b)	Transmitter Peak Output Power		C
15.247(e)	Transmitter Power Spectral Density		C
15.247(d)	Unwanted emission		C
15.209	Transmitter emission	Radiated	C
15.207	AC Conducted Emissions	Conducted	C
15.203	Antenna requirement	-	C

The above equipment was tested by LTA Co., Ltd. The test data, data evaluation, test procedures, and equipment configurations shown in this report were made in accordance with the procedures given in ANSI C63.10-2013 and the energy emitted by the sample EUT tested as described in this report is in compliance with the requirements of FCC Rules Part 2 and Part 15.247 The test results of this report relate only to the tested sample identified in this report.

The tests were performed according to the method of measurements prescribed in KDB No.558074.

→ Antenna Requirement

Kuls co., Ltd. FCC ID: 2ATJKEM100-DEVICE unit complies with the requirement of §15.203.

The antenna type is Dipole Antenna

3.2 Technical Characteristics Test

3.2.1 6 dB Bandwidth

Procedure:

The bandwidth at 6 dB below the highest in-band spectral density was measured with a spectrum analyzer connected to the antenna terminal, while EUT is operating in transmission mode at the appropriate frequencies.

After the trace being stable, Use the marker-to-peak function to set the marker to the peak of the emission. Use the marker-delta function to measure 6 dB down one side of the emission. Reset the marker-delta function, and move the marker to the other side of the emission, until it is (as close as possible to) even with the reference marker level. The marker-delta reading at this point is the 6 dB bandwidth of the emission.

The spectrum analyzer is set to:

Center frequency = the highest, middle and the lowest channels

RBW = 100 kHz

Span = 3 X RBW

VBW = 3 X RBW

Sweep = auto

Trace = max hold

Detector function = peak

Measurement Data : Complies

LoRa Mode

Frequency (MHz)	Test Results	
	Measured Bandwidth (kHz)	Result
917.09	260.5	Complies
920.09	260.5	Complies
923.30	260.5	Complies

- See next pages for actual measured spectrum plots.

Minimum Standard:

6 dB Bandwidth > 500 kHz

Measurement Setup

Figure 1: Measurement setup for the carrier frequency separation

Low Channel

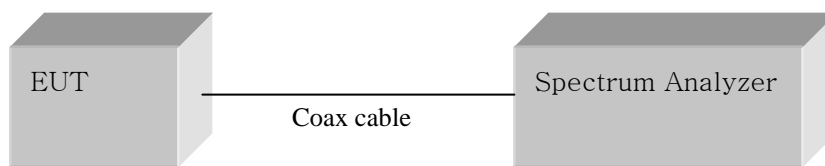
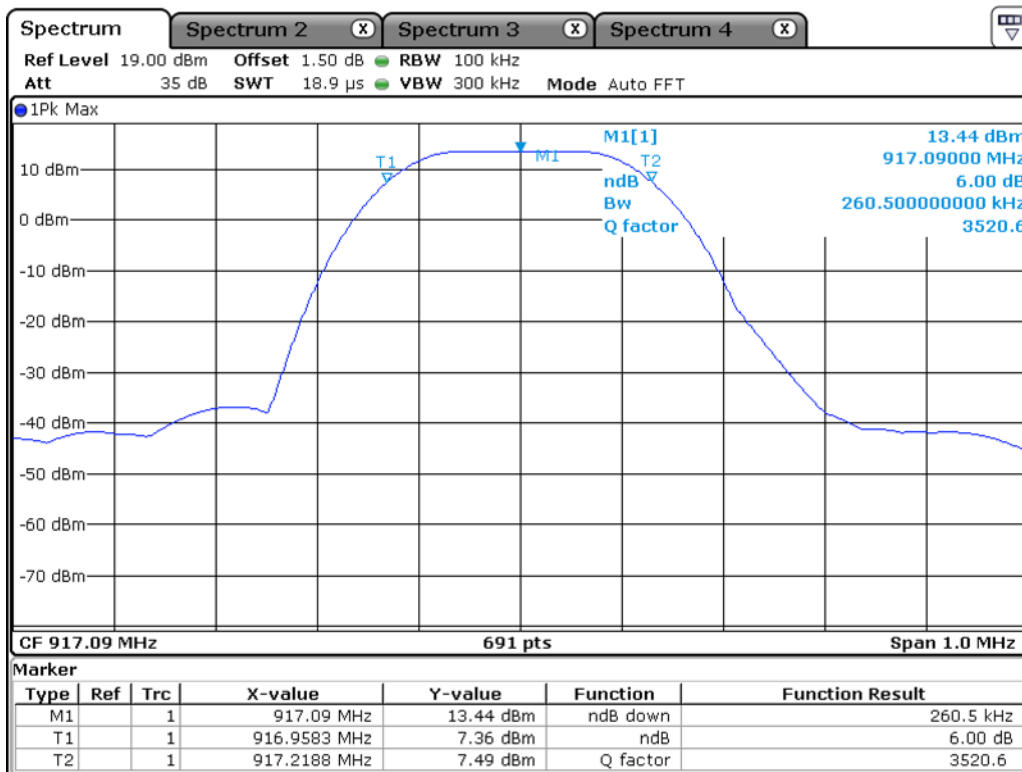

Date: 12.JUN.2019 18:10:24

Middle Channel

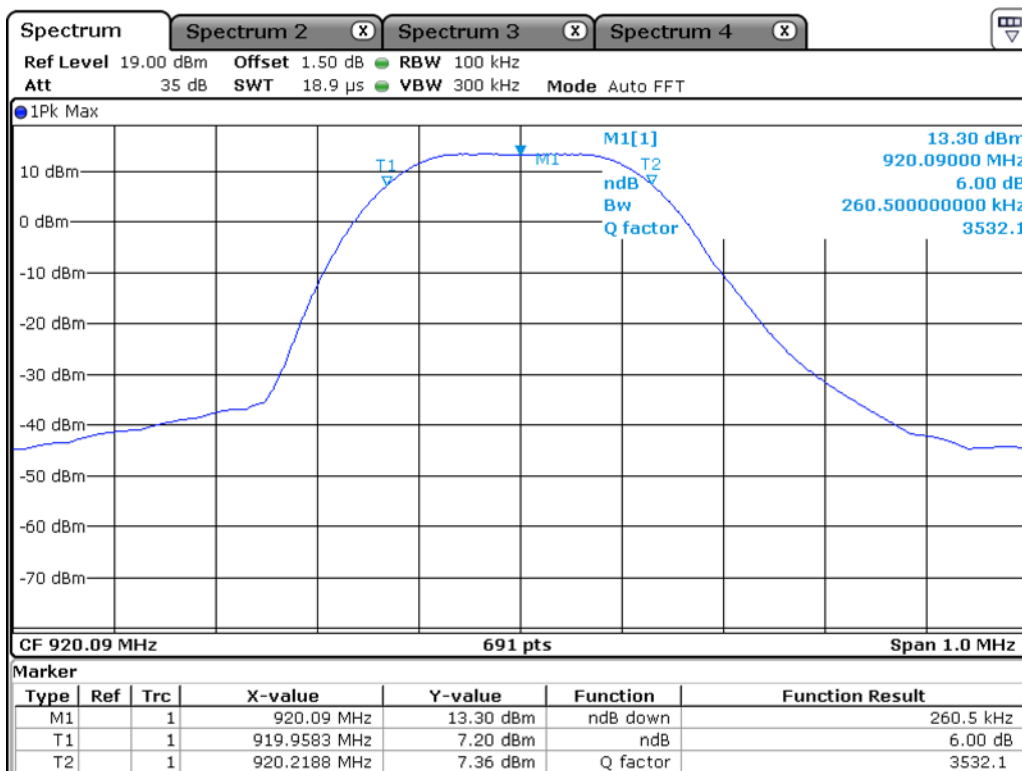

Date: 12.JUN.2019 18:11:32

High Channel

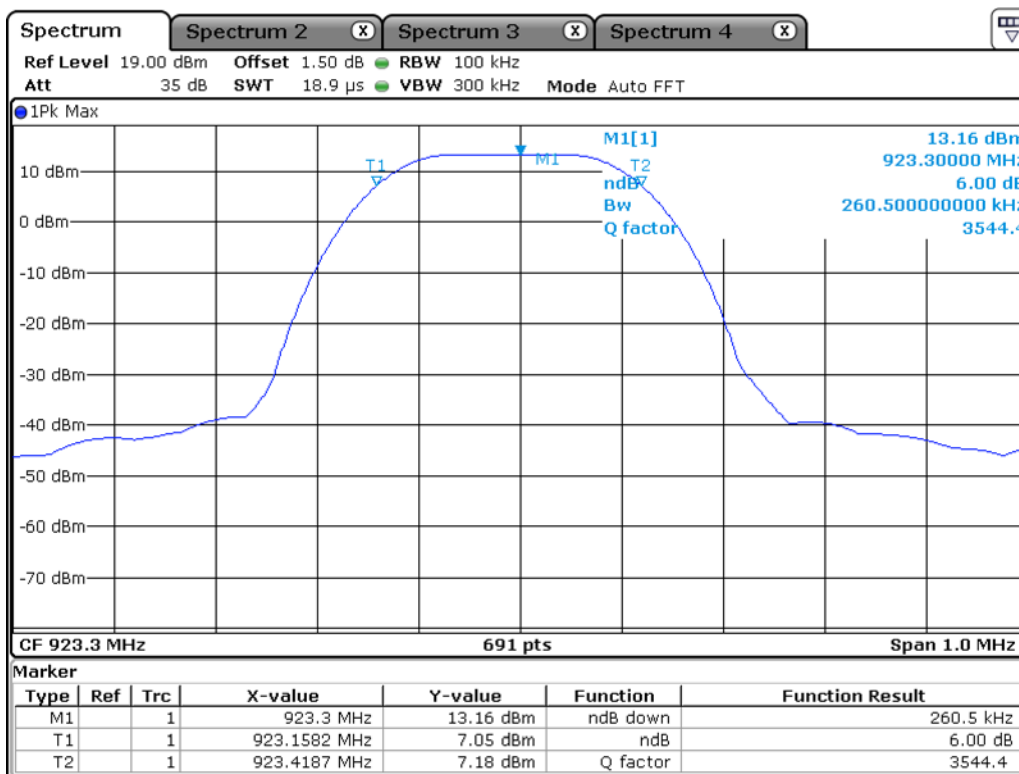

Date: 12.JUN.2019 18:14:38

3.2.2 Peak Output Power Measurement

Procedure:

The following procedure can be used when the maximum available RBW of the instrument is less than the DTS bandwidth :

The spectrum analyzer is set to:

Center frequency = the highest, middle and the lowest channels

RBW \geq DTS Bandwidth

Span \geq 3 X RBW

VBW = 3 X RBW

Sweep = auto

Detector function = peak

Measurement Data : Complies

LoRa Mode

Frequency (MHz)	Test Results	
	Measured data (dBm)	Result
917.09	12.57	Complies
920.09	12.42	Complies
923.30	12.29	Complies

- See next pages for actual measured spectrum plots.

Minimum Standard:

Peak output power	< 1 W(30 dBm)
-------------------	---------------

Measurement Setup

Same as the Chapter 3.2.1 (Figure 1)

Low Channel

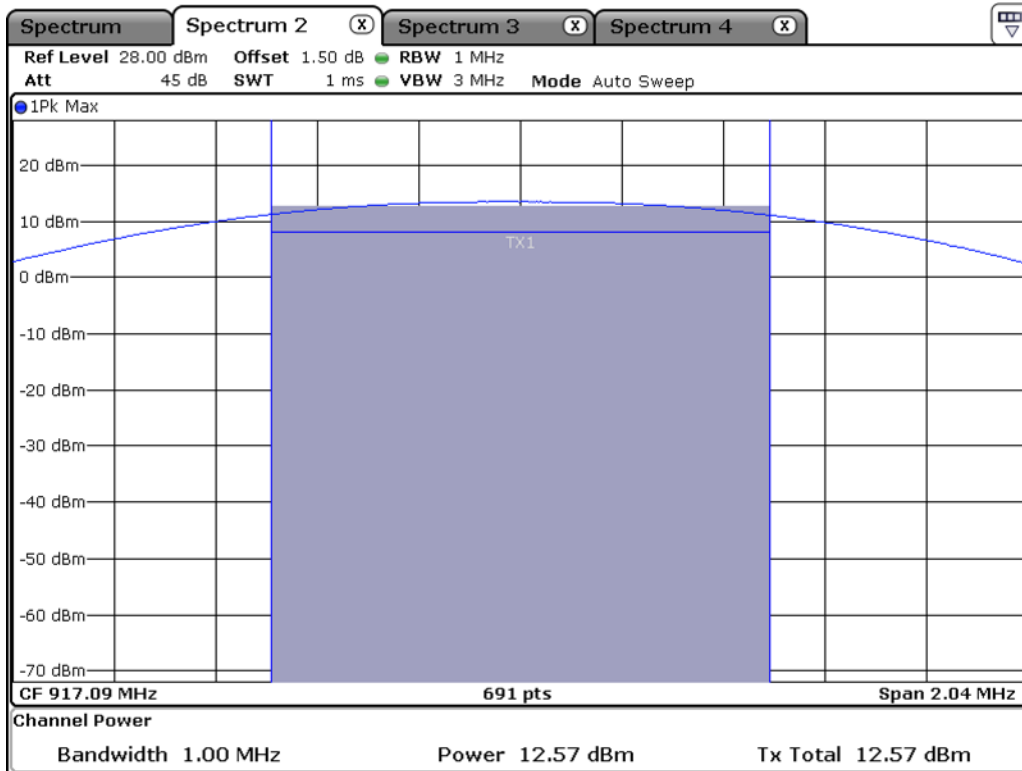

Date: 12.JUN.2019 18:18:38

Middle Channel

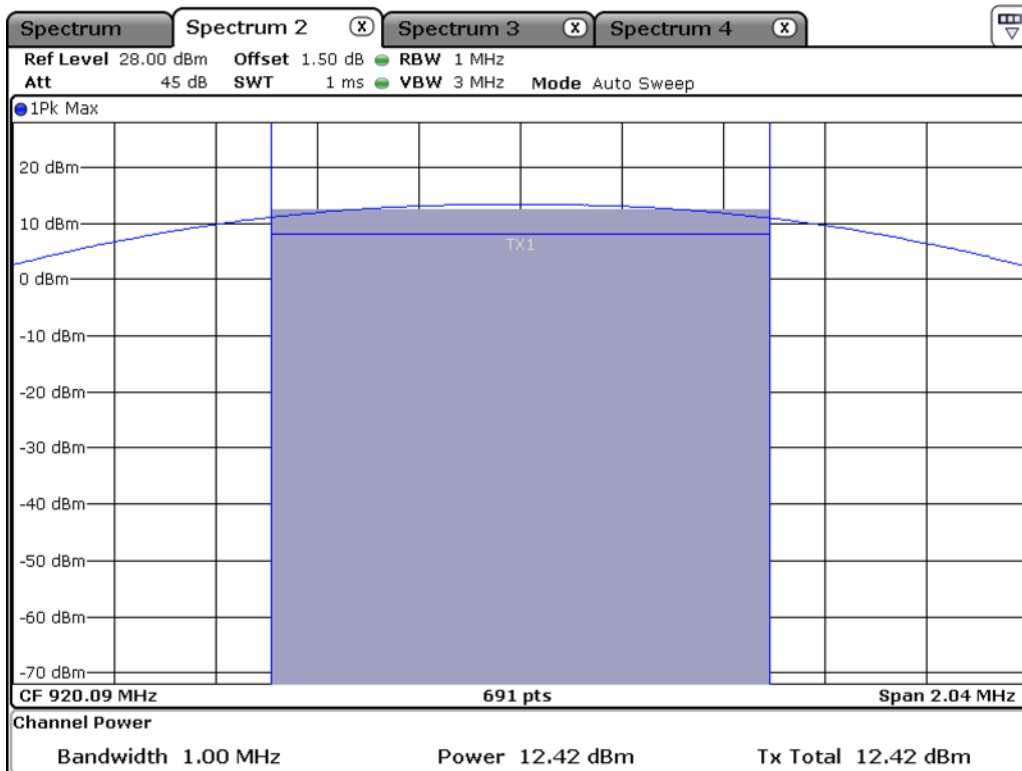

Date: 12.JUN.2019 18:16:38

High Channel

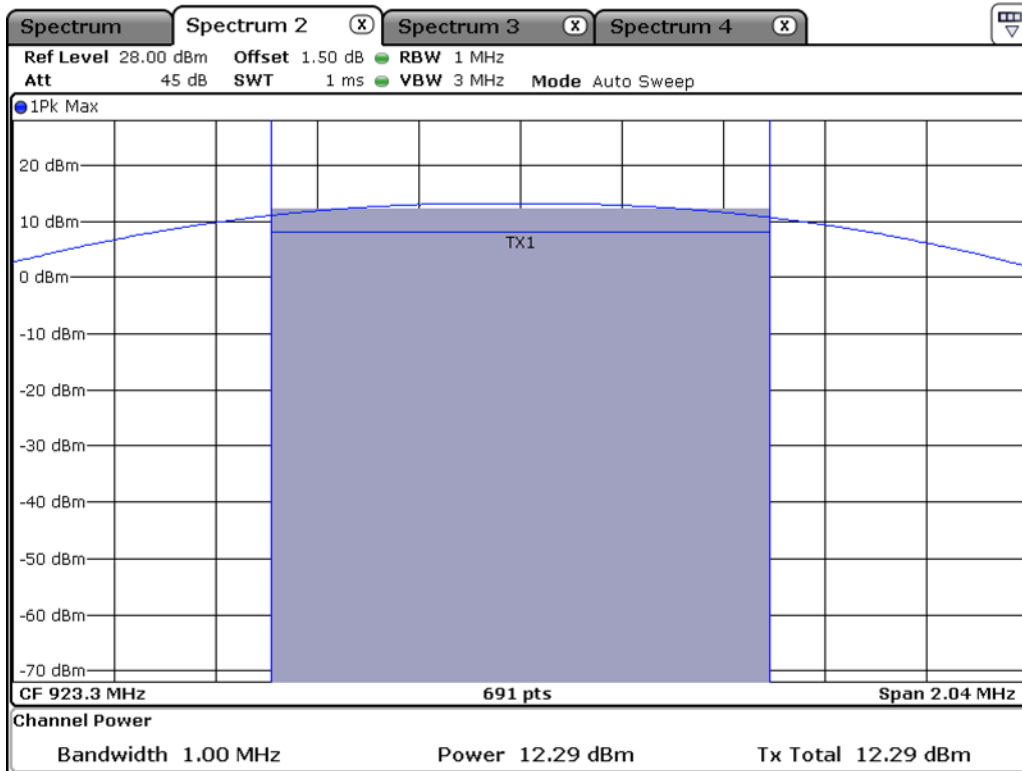

Date: 12.JUN.2019 18:14:59

3.2.3 Power Spectral Density

Procedure:

This procedure shall be used if maximum peak conducted output power was used to demonstrate compliance.

The spectrum analyzer is set to:

RBW = 3 kHz ($3 \text{ kHz} \leq \text{RBW} \leq 100 \text{ kHz}$)

Span ≥ 1.5 times the DTS bandwidth

VBW = 3 X RBW

Sweep = auto

Detector function = peak

Trace = max hold

Measurement Data : Complies

BLE Mode

Frequency (MHz)	Test Results	
	dBm / 3 kHz BW	Result
917.09	6.98	Complies
920.09	7.28	Complies
923.30	7.78	Complies

- See next pages for actual measured spectrum plots.

Minimum Standard:

Power Spectral Density	< 8 dBm @ 3 kHz BW
------------------------	--------------------

Measurement Setup

Same as the Chapter 3.2.1 (Figure 1)

Power Density Measurement Low Channel

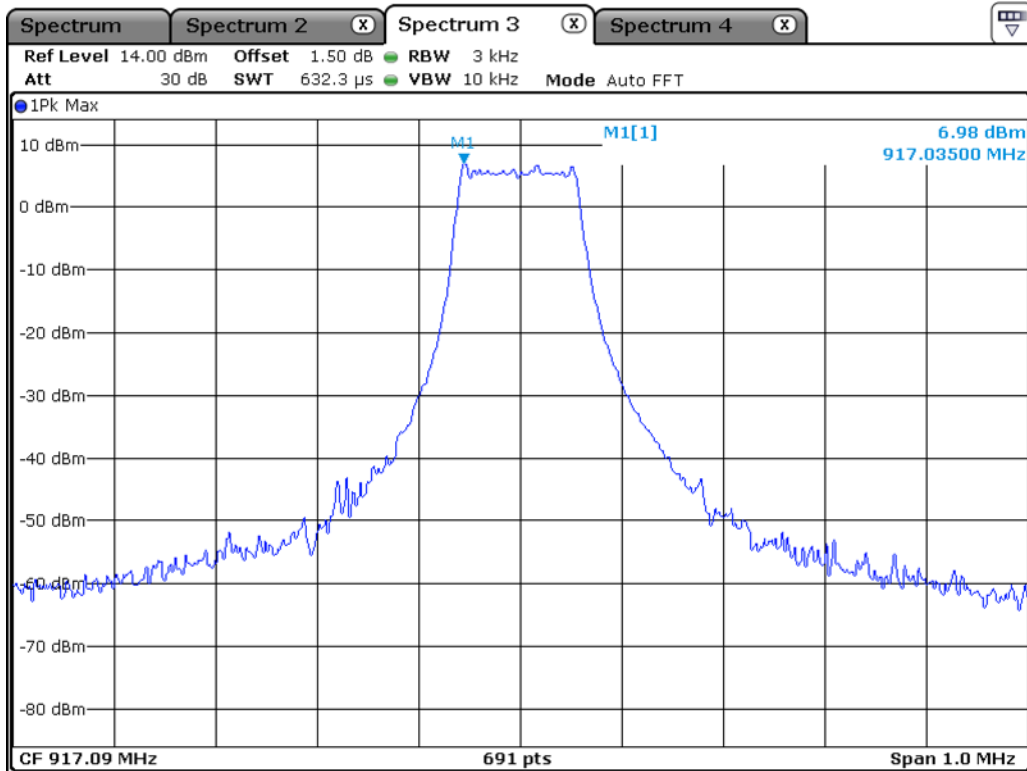

Date: 12.JUN.2019 18:19:07

Middle Channel

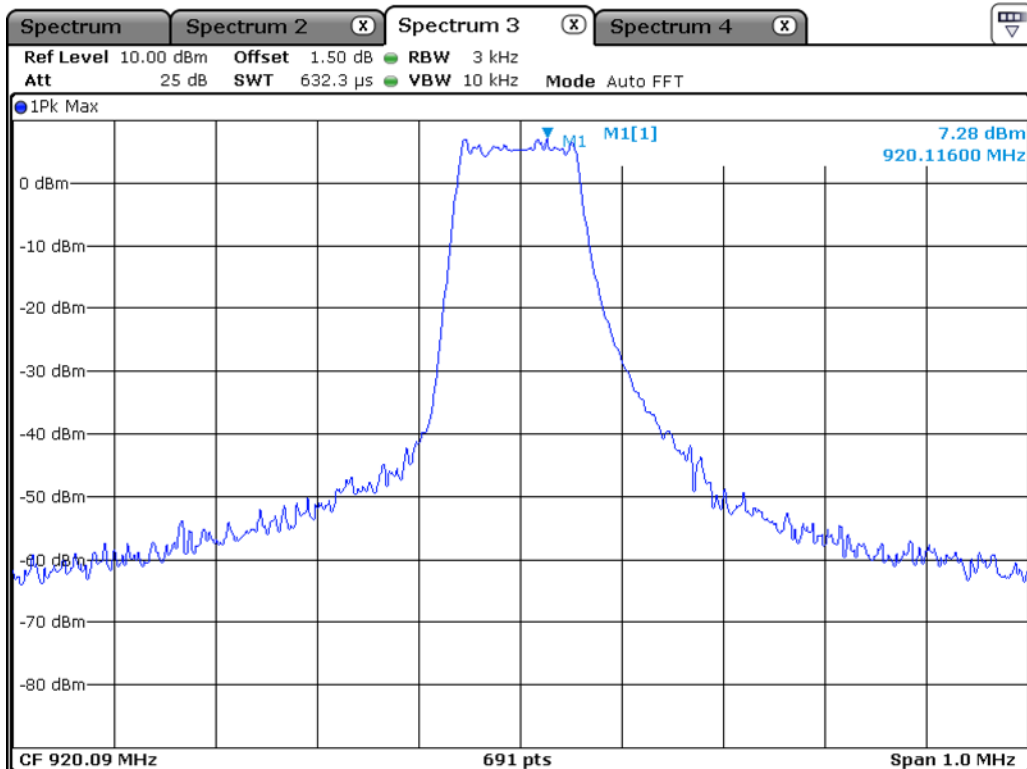

Date: 12.JUN.2019 18:21:04

High Channel

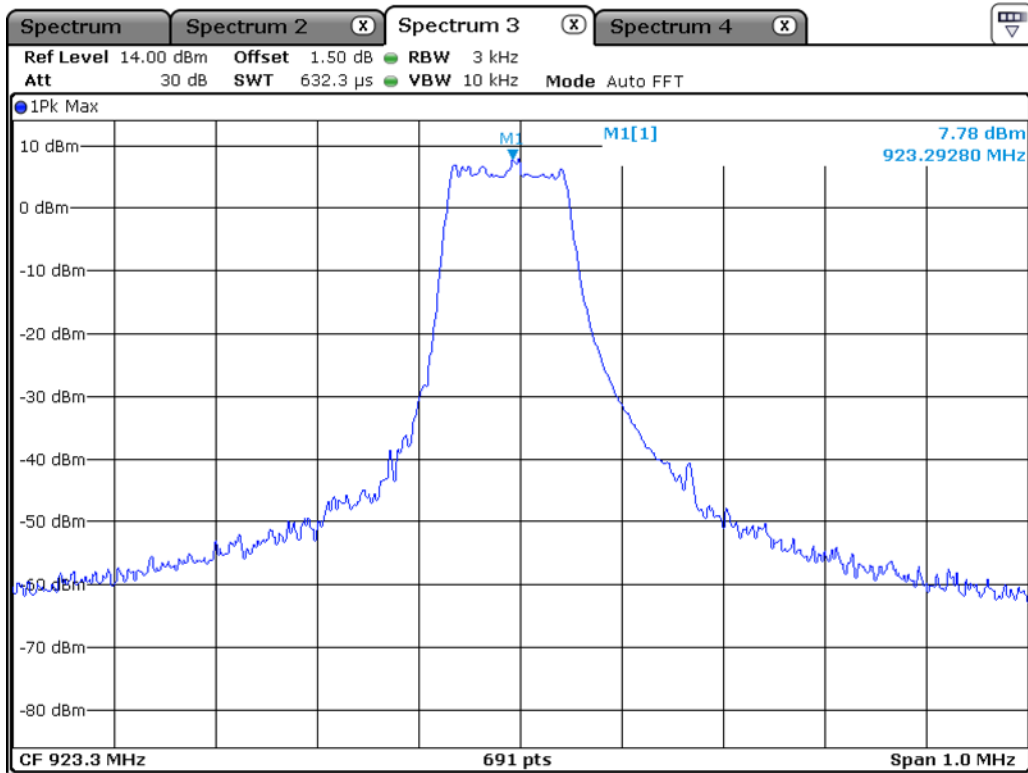

Date: 12.JUN.2019 18:22:56

3.2.4 Band Edge & Conducted Spurious emission

Procedure:

The Unwanted emission from the EUT were measured according to the dictates PKPSD measurement procedure in section 11.11 of ANSI C63.10-2013.

In any 100 kHz bandwidth outside the frequency band in which the spread spectrum or digitally modulated device is operating, the RF power that is produced shall be at least 20 dB below that in the 100 kHz bandwidth within the band that contains the highest level of the desired power, based on either an RF conducted or a radiated measurement, provided that the transmitter demonstrates compliance with the peak conducted power limits.

If the transmitter complies with the conducted power limits based on the use of root-mean-square averaging over a time interval, as permitted under Section 5.4(4), the attenuation required shall be 30 dB instead of 20 dB. Attenuation below the general field strength limits specified in RSS-Gen is not required.

The spectrum analyzer is set to:

Center frequency = the highest, middle and the lowest channels

RBW = 100 kHz

VBW \geq 3 X RBW

Detector function = peak

Trace = max hold

Sweep = auto

Measurement Data: Complies

- All conducted emission in any 100 kHz bandwidth outside of the spread spectrum band was at least 20 dB lower than the highest inband spectral density. Therefore the applying equipment meets the requirement.
- See next pages for actual measured spectrum plots.

Minimum Standard:	< 20 dBc
--------------------------	----------

Lower edge

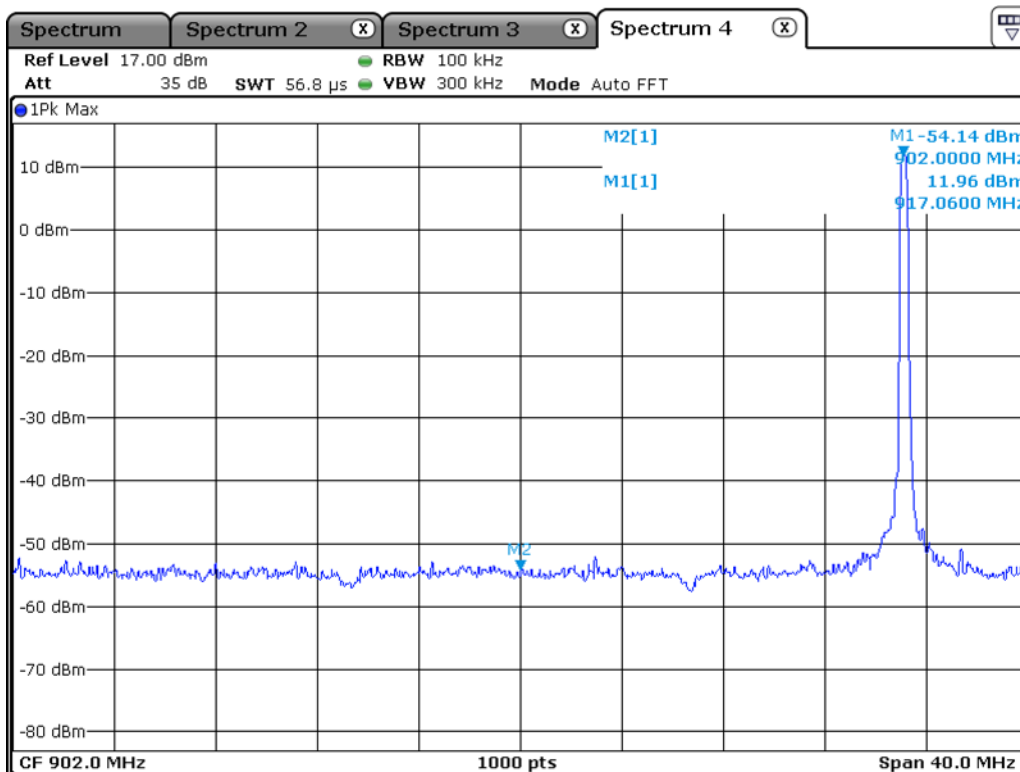

Date: 12.JUN.2019 19:27:56

Upper edge

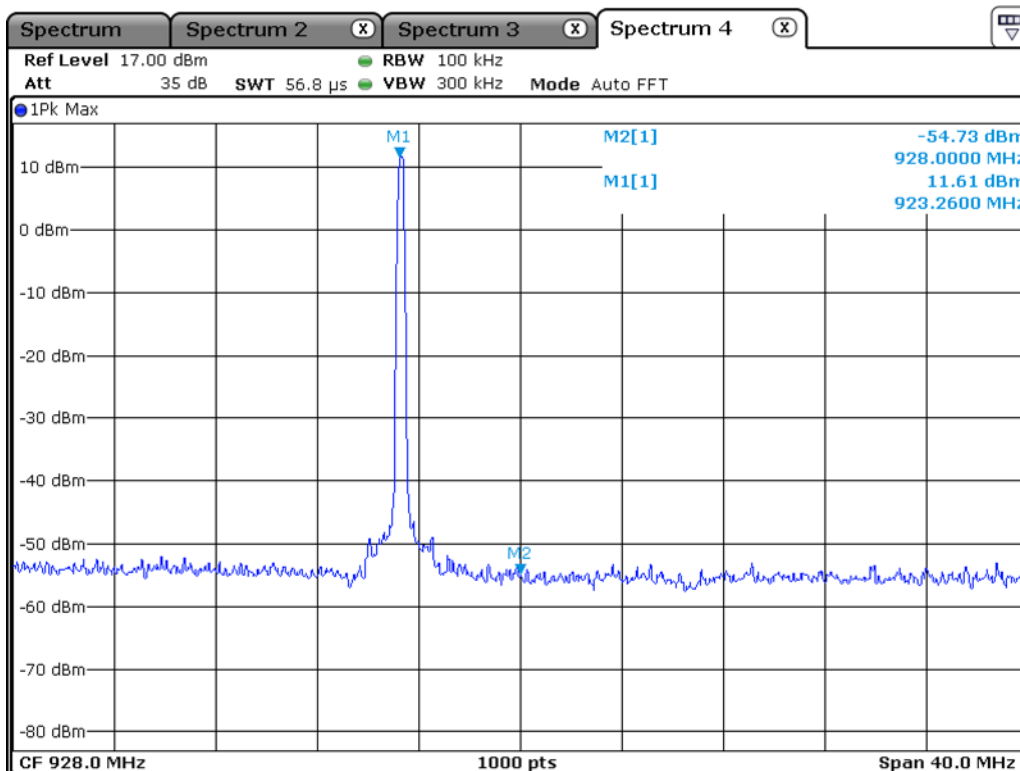

Date: 12.JUN.2019 19:29:51

3.2.5 Conducted Spurious Emissions

Procedure:

The test follows KDB558074. The conducted spurious emissions were measured with a spectrum analyzer connected to the antenna terminal, while EUT had its hopping function disabled at the highest, middle and the lowest available channels.

After the trace being stable, set the marker on the peak of any spurious emission recorded.

The spectrum analyzer is set to:

Span = wide enough to capture the peak level of the in-band emission and all spurious emissions

RBW = 100 kHz

Sweep = auto

VBW = 100 kHz

Detector function = peak

Trace = max hold

Measurement Data: **Complies**

- All conducted emission in any 100 kHz bandwidth outside of the spread spectrum band was at least 20 dB lower than the highest inband spectral density. Therefore the applying equipment meets the requirement.
- See next pages for actual measured spectrum plots.

Minimum Standard:	> 20 dBc
--------------------------	----------

Measurement Setup

Same as the Chapter 3.2.1 (Figure 1)

Unwanted Emission – Low Channel
Frequency Range = 30 MHz ~ 15 GHz

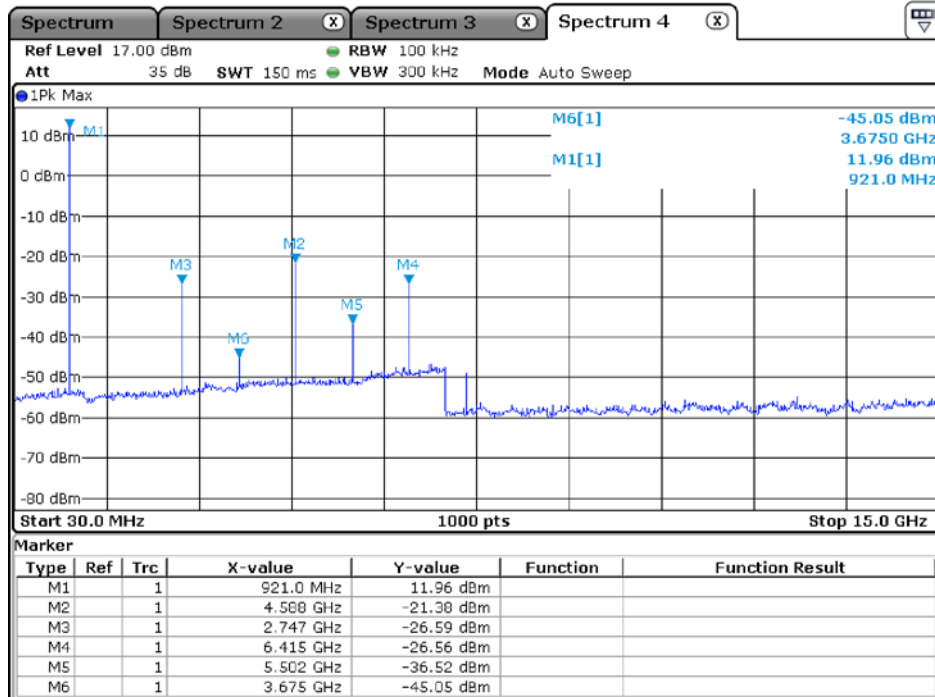

Date: 12.JUN.2019 19:24:52

Unwanted Emission – Middle Channel
Frequency Range = 30 MHz ~ 15 GHz

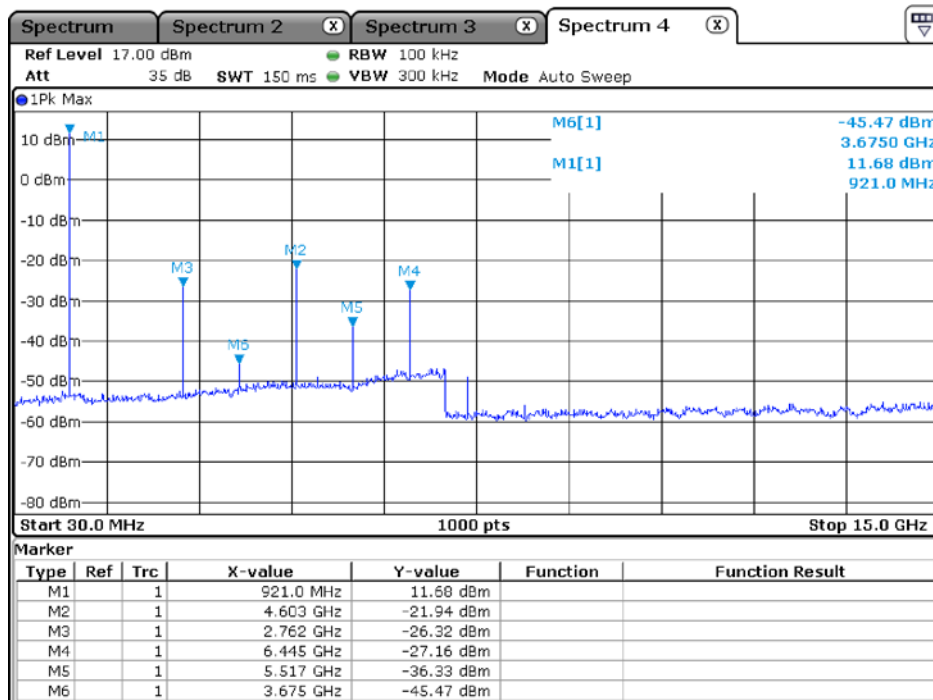

Date: 12.JUN.2019 19:22:26

Unwanted Emission – High Channel
Frequency Range = 30 MHz ~ 15 GHz

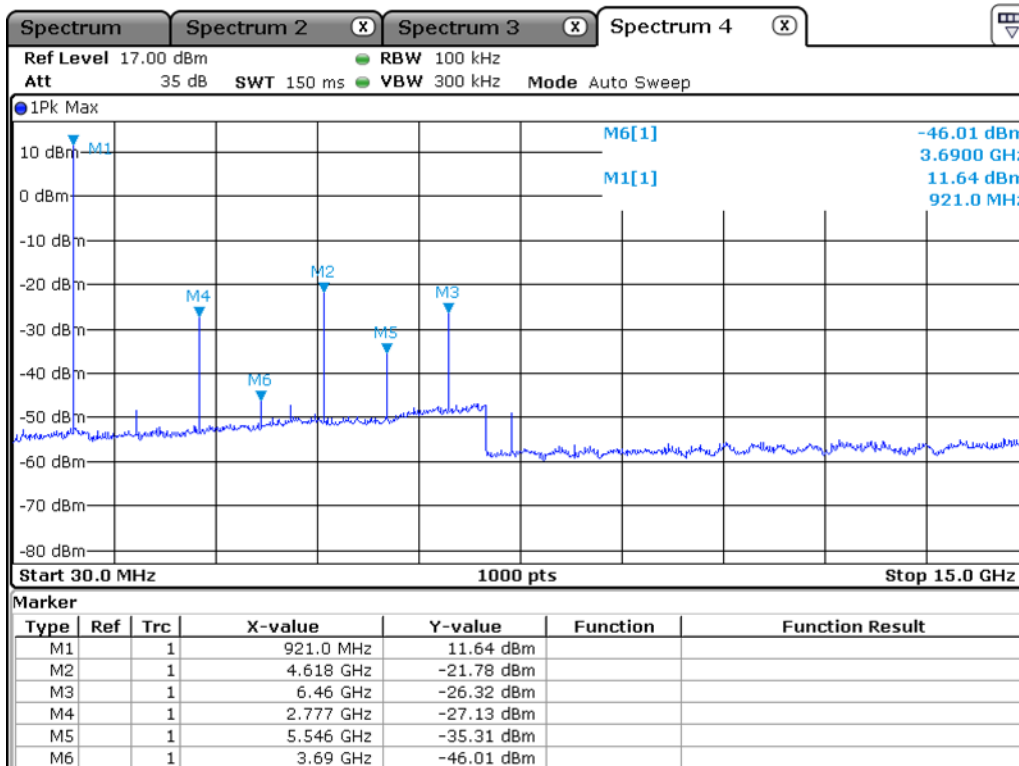

Date: 12.JUN.2019 19:19:03

3.2.6 Radiated Spurious Emissions

Procedure:

Radiated emissions from 30 MHz to 25 GHz were measured according to the methods defines in ANSI C63.10-2013.

The EUT is a placed on as turn table. For emissions testing at or below 1 GHz, the table height shall be 0.8 m above the reference ground plane. For emission measurements above 1 GHz, the table height shall be 1.5 m. The turn table shall rotate 360 degrees to determine the position of maximum emission level. EUT is set 3m away from the receiving antenna which varied from 1m to 4m to find out the highest emission. And also, each emission was to be maximized by changing the polarization of receiving antenna both horizontal and vertical. In order to find out the max. emission, the relative positions of this hand-held transmitter (EUT) was rotated through three orthogonal axes and measurement procedures for electric field radiated emissions above 1 GHz the EUT measurement is to be made “while keeping the antenna in the ‘cone of radiation’ from that area and pointed at the area both in azimuth and elevation, with polarization oriented for maximum response.” is still within the 3dB illumination BW of the measurement antenna.

The spectrum analyzer is set to:

Center frequency = the worst channel

Frequency Range = 9 kHz ~ 10th harmonic.

RBW = 120 kHz (30 MHz ~ 1 GHz)

= 1 MHz (1 GHz ~ 10th harmonic)

Trace = max hold

Sweep = auto

VBW \geq RBW

Detector function = peak

below 30 MHz

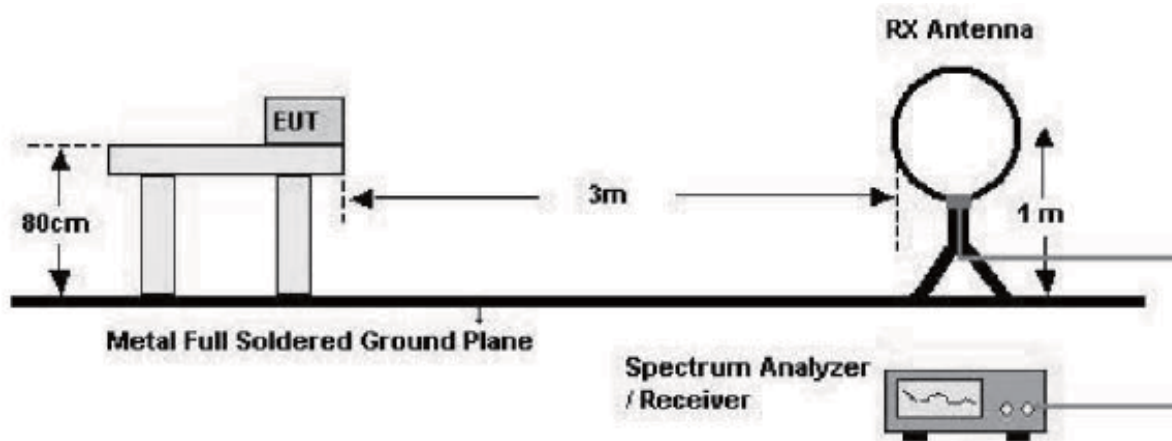

below 1 GHz (30 MHz to 1 GHz)

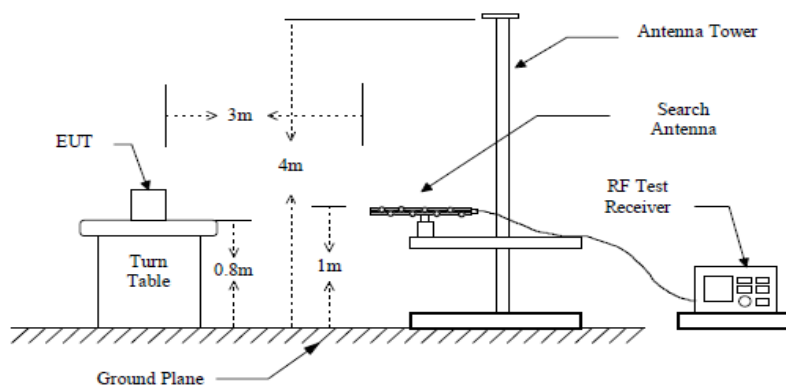

above 1 GHz

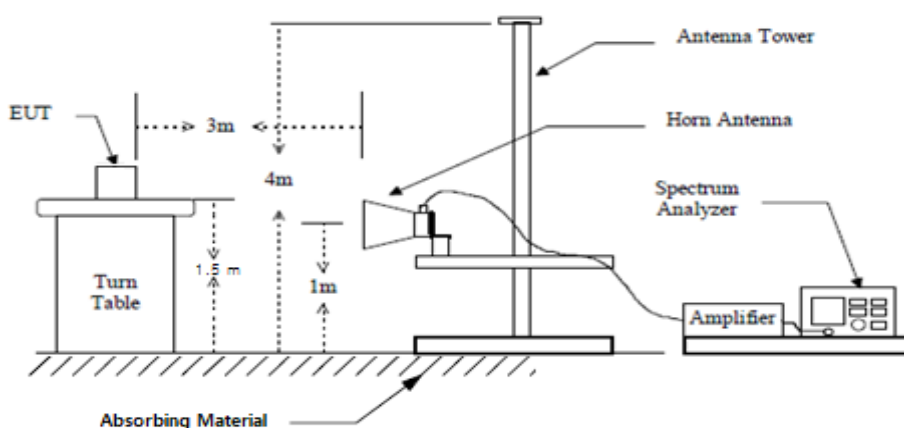

Measurement Data: **Complies**

- See next pages for actual measured data.
- No other emissions were detected at a level greater than 20 dB below limit include from 9 kHz to 30MHz.

Minimum Standard: FCC Part 15.209(a)

Frequency (MHz)	Limit (uV/m) @ 3 m
0.009 ~ 0.490	2400/F(kHz) (@ 300 m)
0.490 ~ 1.705	24000/F(kHz) (@ 30 m)
1.705 ~ 30	30(@ 30 m)
30 ~ 88	100 **
88 ~ 216	150 **
216 ~ 960	200 **
Above 960	500

** Except as provided in 15.209(g), fundamental emissions from intentional radiators operating under this Section shall not be located in the frequency bands 54-72 MHz, 76-88 MHz, 174-216 MHz or 470-806 MHz. However, operation within these frequency bands is permitted under other sections of this Part, e.g. 15.231 and 15.241.

Radiated Emissions (Below 1 GHz) – Operating mode



4, Songjuro 236Beon-gil, yanggi-myeon,
Yongin-si, Gyeonggi-do, Korea
Tel : +82-31-3236008,9
Fax : +82-31-3236010
www.ltalab.com

EUT/Model No.: EM100 (DEVICE) Temp/Humi: 23 / 31

 Test Mode : Operating mode Tested by: KWON H C

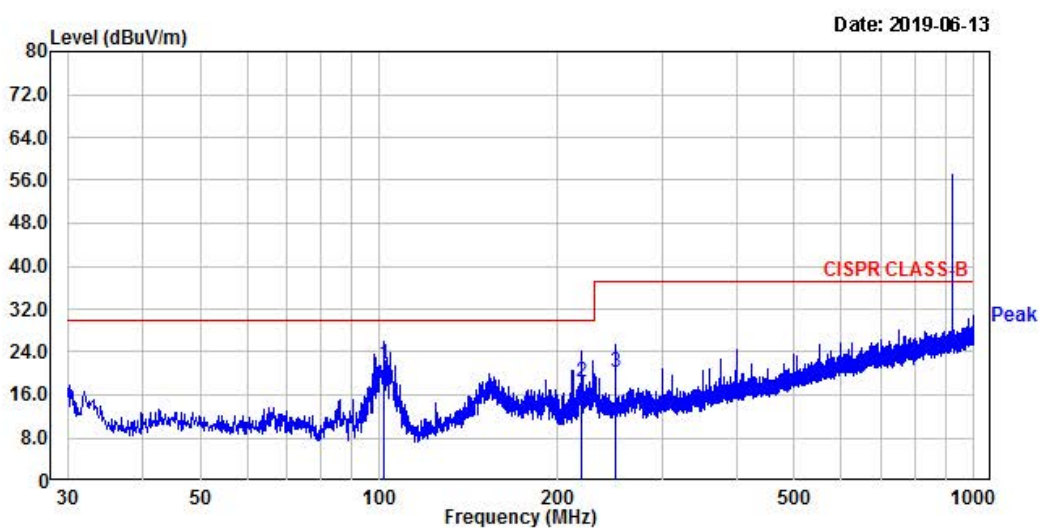

Freq	Reading	C.F	Result	Limit	Margin	Height	Angle	Polarity
MHz	dBuV	dB	QP dBuV/m	dBuV/m	dB	cm	deg	
101.78	39.24	-17.42	21.82	30.00	8.18	400	132	horizontal
219.51	32.65	-14.36	18.29	30.00	11.71	400	265	horizontal
249.95	33.15	-12.91	20.24	37.00	16.76	372	360	horizontal

Remarks: C.F (Correction Factor) = Antenna factor + Cable loss - Preamp gain



4, Songjuro 236Beon-gil, yanggi-myeon,
 Yongin-si, Gyeonggi-do, Korea
 Tel : +82-31-3236008,9
 Fax : +82-31-3236010
 www.ltalab.com

EUT/Model No.: EM100 (DEVICE) Temp/Humi: 23 / 31

 Test Mode : Operating mode Tested by: KWON H C

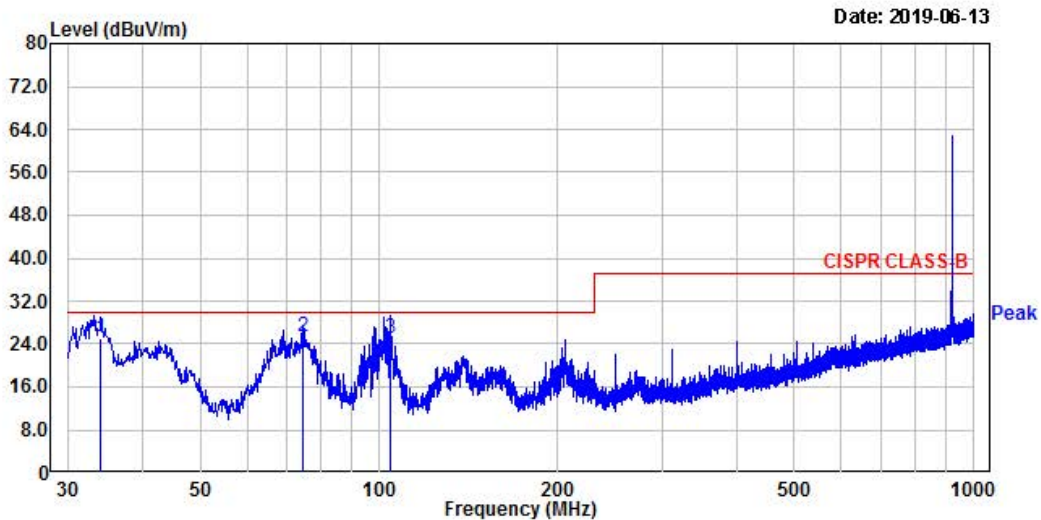

Freq MHz	Reading dBuV	C.F dB	Result QP dBuV/m	Limit dBuV/m	Margin dB	Height cm	Angle deg	Polarity
34.00	40.09	-15.14	24.95	30.00	5.05	100	197	vertical
74.62	42.19	-16.83	25.36	30.00	4.64	100	360	vertical
104.69	42.31	-17.11	25.20	30.00	4.80	100	45	vertical

Remarks: C.F (Correction Factor) = Antenna factor + Cable loss - Preamp gain

Radiated Emissions (Above 1 GHz) – LOW mode



4, Songjuro 236Beon-gil, yanggi-myeon,
Yongin-si, Gyeonggi-do, Korea
Tel : +82-31-3236008,9
Fax : +82-31-3236010
www.ltalab.com

EUT/Model No.: EM100 (DEVICE)

Temp/Humi: 23 / 31

Test Mode : LOW mode

Tested by: KWON H C

Date: 2019-06-13

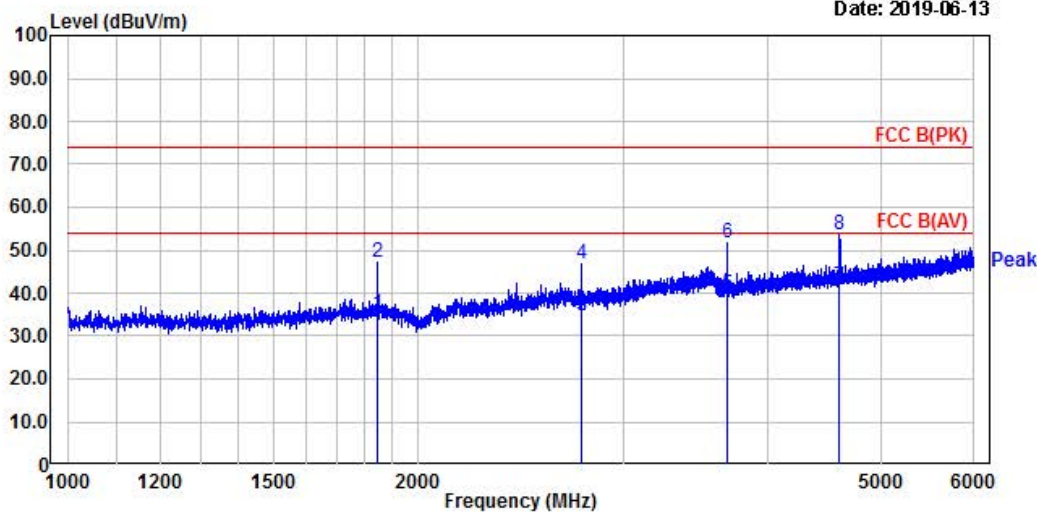

Freq MHz	Reading dBuV	C.F dB	Result QP dBuV/m	Limit dBuV/m	Margin dB	Height cm	Angle deg	Polarity
1843.13	36.00	-0.95	35.05	54.00	18.95	100	120	horizontal
1843.13	48.00	-0.95	47.05	74.00	26.95	100	120	horizontal
2764.38	31.31	3.51	34.82	54.00	19.18	100	301	horizontal
2764.38	43.31	3.51	46.82	74.00	27.18	100	301	horizontal
3685.63	31.27	8.47	39.74	54.00	14.26	100	154	horizontal
3685.63	43.27	8.47	51.74	74.00	22.26	100	154	horizontal
4606.88	29.74	11.80	41.54	54.00	12.46	100	24	horizontal
4606.88	41.74	11.80	53.54	74.00	20.46	100	24	horizontal

Remarks: C.F (Correction Factor) = Antenna factor + Cable loss - Preamp gain



4, Songjuro 236Beon-gil, yanggi-myeon,
 Yongin-si, Gyeonggi-do, Korea
 Tel : +82-31-3236008,9
 Fax : +82-31-3236010
 www.ltalab.com

EUT/Model No.: EM100 (DEVICE)

Temp/Humi: 23 / 31

Test Mode : LOW mode

Tested by: KWON H C

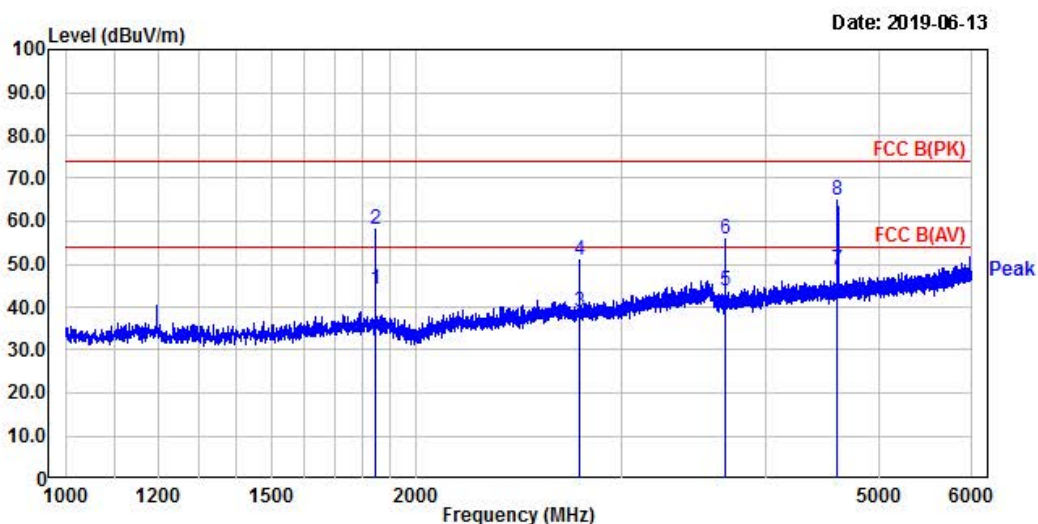

Freq	Reading	C.F	Result	Limit	Margin	Height	Angle	Polarity
MHz	dBuV	dB	QP dBuV/m	dBuV/m	dB	cm	deg	
1842.50	45.06	-0.95	44.11	54.00	9.89	100	218	vertical
1842.50	59.06	-0.95	58.11	74.00	15.89	100	218	vertical
2764.38	35.37	3.51	38.88	54.00	15.12	100	218	vertical
2764.38	47.37	3.51	50.88	74.00	23.12	100	218	vertical
3685.63	35.37	8.47	43.84	54.00	10.16	100	127	vertical
3685.63	47.37	8.47	55.84	74.00	18.16	100	127	vertical
4607.50	36.94	11.81	48.75	54.00	5.25	100	127	vertical
4607.50	52.94	11.81	64.75	74.00	9.25	100	127	vertical

Remarks: C.F (Correction Factor) = Antenna factor + Cable loss - Preamp gain



4, Songjuro 236Beon-gil, yanggi-myeon,
 Yongin-si, Gyeonggi-do, Korea
 Tel : +82-31-3236008,9
 Fax : +82-31-3236010
 www.ltalab.com

EUT/Model No.: EM100 (DEVICE)

Temp/Humi: 24 / 39

Test Mode : LOW

Tested by: KWON H C

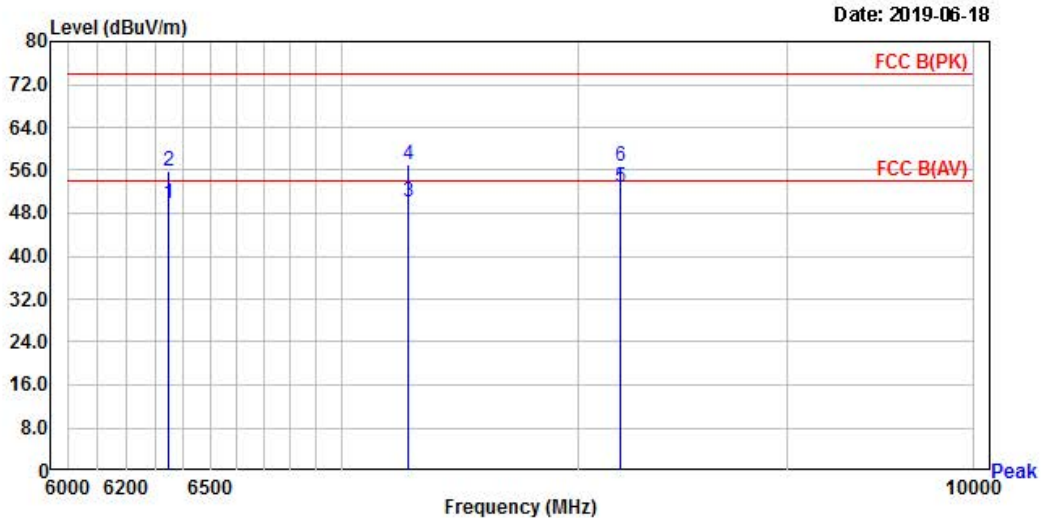

Date: 2019-06-18

Freq MHz	Reading dBUV	C.F dB	Result QP dBUV/m	Limit dBUV/m	Margin dB	Height cm	Angle deg	Polarity
6351.00	42.21	7.51	49.72	54.00	4.28	100	123	Horizontal
6351.00	48.21	7.51	55.72	74.00	18.28	100	123	Horizontal
7272.00	41.31	8.85	50.16	54.00	3.84	100	136	Horizontal
7272.00	48.31	8.85	57.16	74.00	16.84	100	136	Horizontal
8193.00	44.34	8.55	52.89	54.00	1.11	100	159	Horizontal
8193.00	48.34	8.55	56.89	74.00	17.11	100	159	Horizontal

Remarks: C.F (Correction Factor) = Antenna factor + Cable loss - Preamp gain



4, Songjuro 236Beon-gil, yanggi-myeon,
 Yongin-si, Gyeonggi-do, Korea
 Tel : +82-31-3236008,9
 Fax : +82-31-3236010
 www.ltalab.com

EUT/Model No.: EM100 (DEVICE)

Temp/Humi: 24 / 39

Test Mode : LOW

Tested by: KWON H C

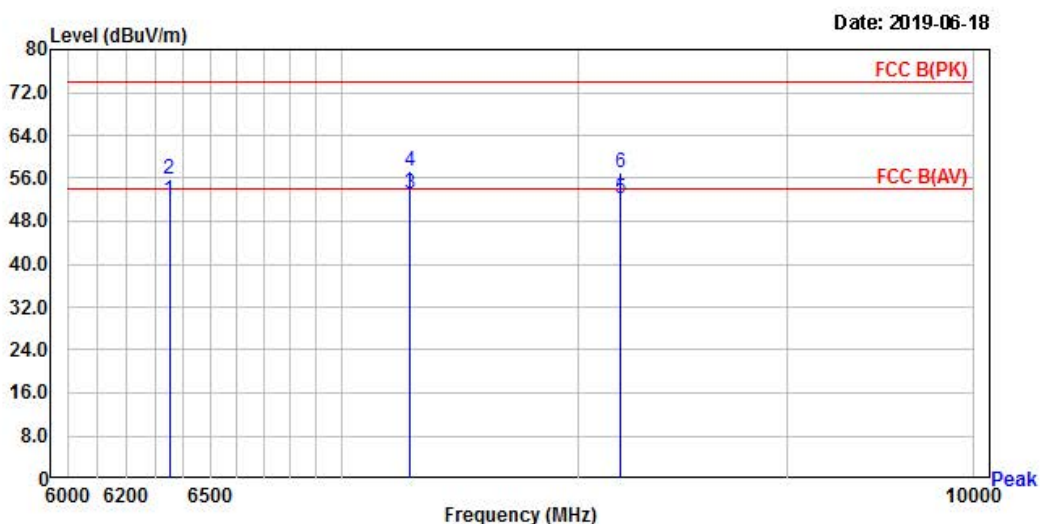

Freq	Reading	C.F	Result	Limit	Margin	Height	Angle	Polarity
MHz	dBuV	dB	QP dBuV/m	dBuV/m	dB	cm	deg	
6352.00	44.32	7.51	51.83	54.00	2.17	100	144	Vertical
6352.00	48.32	7.51	55.83	74.00	18.17	100	144	Vertical
7273.00	44.41	8.85	53.26	54.00	0.74	100	169	Vertical
7273.00	48.41	8.85	57.26	74.00	16.74	100	169	Vertical
8191.00	43.53	8.55	52.08	54.00	1.92	100	177	Vertical
8191.00	48.53	8.55	57.08	74.00	16.92	100	177	Vertical

Remarks: C.F (Correction Factor) = Antenna factor + Cable loss - Preamp gain

MID mode



4, Songjuro 236Beon-gil, yanggi-myeon,
Yongin-si, Gyeonggi-do, Korea
Tel : +82-31-3236008,9
Fax : +82-31-3236010
www.ltalab.com

EUT/Model No.: EM100 (DEVICE)

Temp/Humi: 23 / 31

Test Mode : MID mode

Tested by: KWON H C

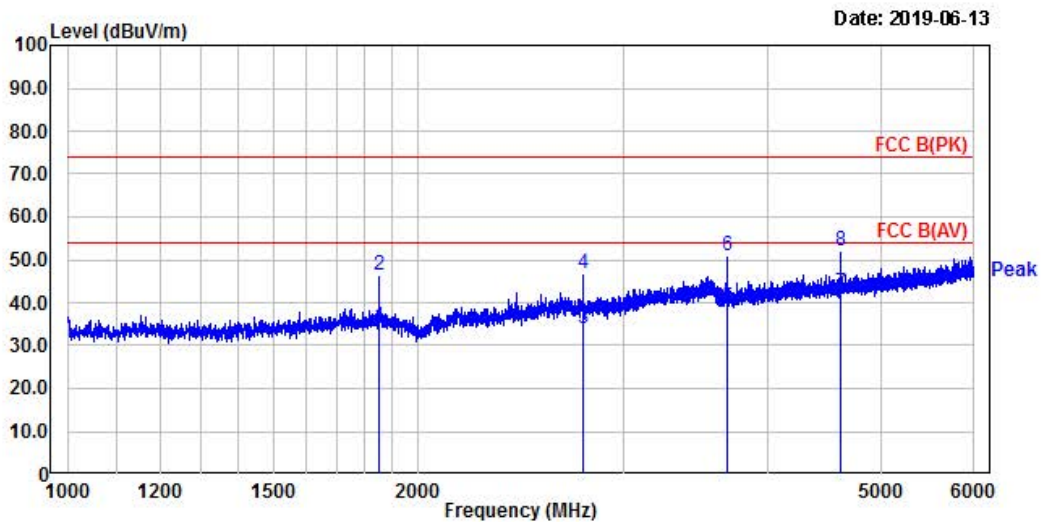

Freq	Reading	C.F	Result	Limit	Margin	Height	Angle	Polarity
MHz	dBuV	dB	QP dBUV/m	dBUV/m	dB	cm	deg	
1848.13	35.11	-0.90	34.21	54.00	19.79	100	120	horizontal
1848.13	47.43	-0.90	46.53	74.00	27.47	100	120	horizontal
2769.38	30.44	3.53	33.97	54.00	20.03	100	301	horizontal
2769.38	43.29	3.53	46.82	74.00	27.18	100	301	horizontal
3690.63	30.23	8.50	38.73	54.00	15.27	100	154	horizontal
3690.63	42.46	8.50	50.96	74.00	23.04	100	154	horizontal
4611.88	30.34	11.83	42.17	54.00	11.83	100	24	horizontal
4611.88	40.23	11.83	52.06	74.00	21.94	100	24	horizontal

Remarks: C.F (Correction Factor) = Antenna factor + Cable loss - Preamp gain



4, Songjuro 236Beon-gil, yanggi-myeon,
 Yongin-si, Gyeonggi-do, Korea
 Tel : +82-31-3236008,9
 Fax : +82-31-3236010
 www.ltalab.com

EUT/Model No.: EM100 (DEVICE)

Temp/Humi: 23 / 31

Test Mode : MID mode

Tested by: KWON H C

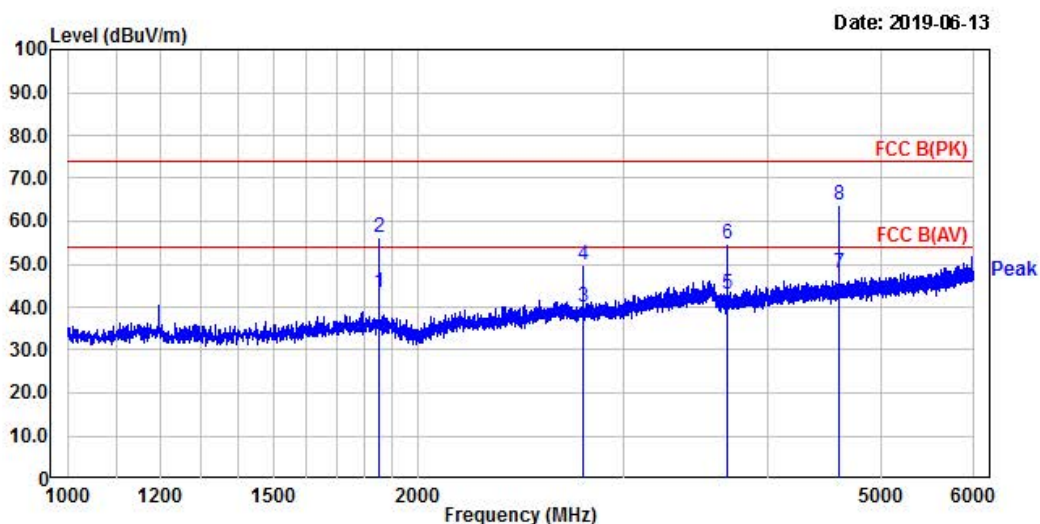

Freq	Reading	C.F	Result	Limit	Margin	Height	Angle	Polarity
MHz	dBuV	dB	QP dBuV/m	dBuV/m	dB	cm	deg	
1847.50	44.47	-0.91	43.56	54.00	10.44	100	218	vertical
1847.50	57.07	-0.91	56.16	74.00	17.84	100	218	vertical
2769.38	36.38	3.53	39.91	54.00	14.09	100	218	vertical
2769.38	46.38	3.53	49.91	74.00	24.09	100	218	vertical
3685.63	34.37	8.47	42.84	54.00	11.16	100	127	vertical
3685.63	46.37	8.47	54.84	74.00	19.16	100	127	vertical
4607.50	35.94	11.81	47.75	54.00	6.25	100	127	vertical
4607.50	51.94	11.81	63.75	74.00	10.25	100	127	vertical

Remarks: C.F (Correction Factor) = Antenna factor + Cable loss - Preamp gain



4, Songjuro 236Beon-gil, yanggi-myeon,
 Yongin-si, Gyeonggi-do, Korea
 Tel : +82-31-3236008,9
 Fax : +82-31-3236010
 www.ltalab.com

EUT/Model No.: EM100 (DEVICE)

Temp/Humi: 24 / 39

Test Mode : MID

Tested by: KWON H C

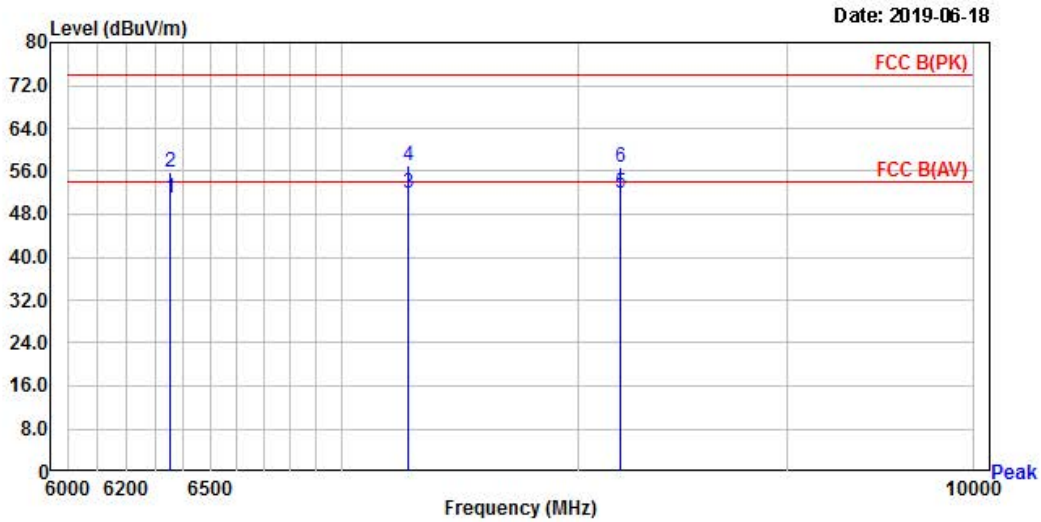

Freq	Reading	C.F	Result	Limit	Margin	Height	Angle	Polarity
MHz	dBuV	dB	QP dBuV/m	dBuV/m	dB	cm	deg	
6355.00	43.47	7.51	50.98	54.00	3.02	100	166	Horizontal
6355.00	48.47	7.51	55.98	74.00	18.02	100	166	Horizontal
7270.00	43.20	8.85	52.05	54.00	1.95	100	155	Horizontal
7270.00	48.20	8.85	57.05	74.00	16.95	100	155	Horizontal
8193.00	43.34	8.55	51.89	54.00	2.11	100	155	Horizontal
8193.00	48.34	8.55	56.89	74.00	17.11	100	155	Horizontal

Remarks: C.F (Correction Factor) = Antenna factor + Cable loss - Preamp gain



4, Songjuro 236Beon-gil, yanggi-myeon,
 Yongin-si, Gyeonggi-do, Korea
 Tel : +82-31-3236008,9
 Fax : +82-31-3236010
 www.ltalab.com

EUT/Model No.: EM100 (DEVICE)

Temp/Humi: 24 / 39

Test Mode : MID

Tested by: KWON H C

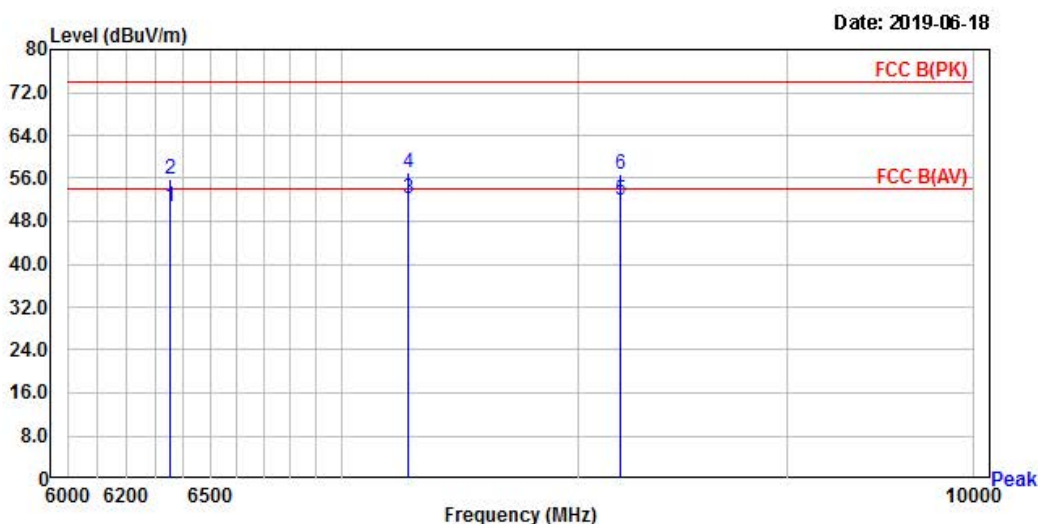

Freq	Reading	C.F	Result	Limit	Margin	Height	Angle	Polarity
MHz	dBuV	dB	QP dBuV/m	dBuV/m	dB	cm	deg	
6354.00	43.21	7.51	50.72	54.00	3.28	100	197	Vertical
6354.00	48.21	7.51	55.72	74.00	18.28	100	197	Vertical
7271.00	43.26	8.85	52.11	54.00	1.89	100	254	Vertical
7271.00	48.26	8.85	57.11	74.00	16.89	100	254	Vertical
8193.00	43.34	8.55	51.89	54.00	2.11	100	258	Vertical
8193.00	48.34	8.55	56.89	74.00	17.11	100	258	Vertical

Remarks: C.F (Correction Factor) = Antenna factor + Cable loss - Preamp gain

HIGH mode



4, Songjuro 236Beon-gil, yanggi-myeon,
Yongin-si, Gyeonggi-do, Korea
Tel : +82-31-3236008,9
Fax : +82-31-3236010
www.ltalab.com

EUT/Model No.: EM100 (DEVICE)

Temp/Humi: 23 / 31

Test Mode : HIGH mode

Tested by: KWON H C

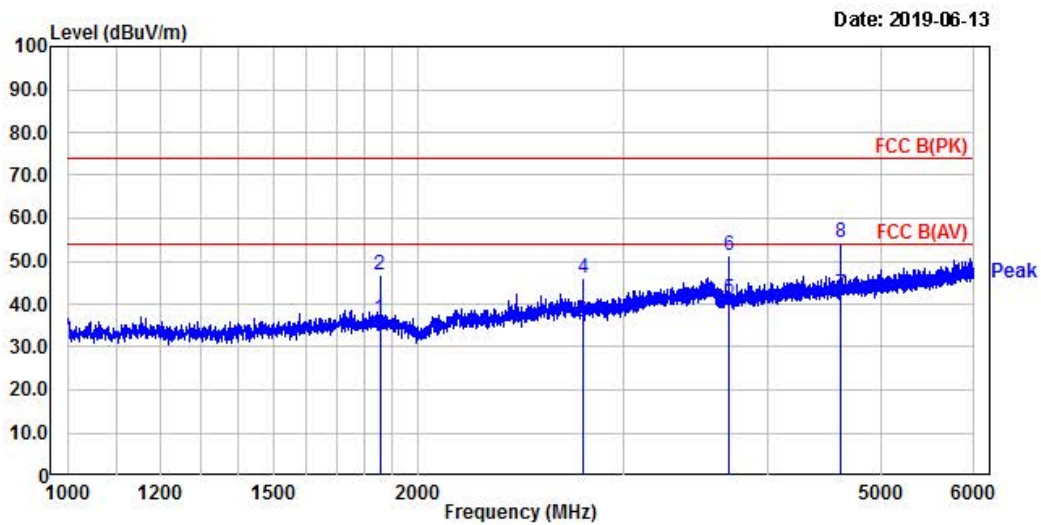

Freq MHz	Reading dBuV	C.F dB	Result QP dBuV/m	Limit dBuV/m	Margin dB	Height cm	Angle deg	Polarity
1853.13	37.46	-0.86	36.60	54.00	17.40	100	120	horizontal
1853.13	47.59	-0.86	46.73	74.00	27.27	100	120	horizontal
2774.38	32.42	3.55	35.97	54.00	18.03	100	301	horizontal
2774.38	42.32	3.55	45.87	74.00	28.13	100	301	horizontal
3695.63	32.58	8.52	41.10	54.00	12.90	100	154	horizontal
3695.63	42.69	8.52	51.21	74.00	22.79	100	154	horizontal
4616.88	30.46	11.85	42.31	54.00	11.69	100	24	horizontal
4616.88	42.58	11.85	54.43	74.00	19.57	100	24	horizontal

Remarks: C.F (Correction Factor) = Antenna factor + Cable loss - Preamp gain



4, Songjuro 236Beon-gil, yanggi-myeon,
 Yongin-si, Gyeonggi-do, Korea
 Tel : +82-31-3236008,9
 Fax : +82-31-3236010
 www.ltalab.com

EUT/Model No.: EM100 (DEVICE)

Temp/Humi: 23 / 31

Test Mode : HIGH mode

Tested by: KWON H C

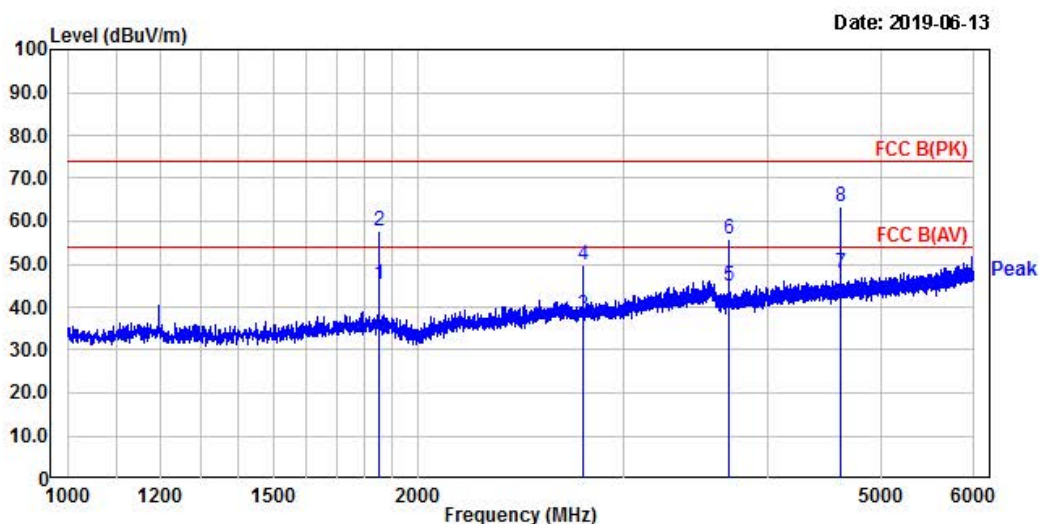

Freq	Reading	C.F	Result	Limit	Margin	Height	Angle	Polarity
MHz	dBuV	dB	QP dBuV/m	dBuV/m	dB	cm	deg	
1852.50	46.02	-0.86	45.16	54.00	8.84	100	218	vertical
1852.50	58.45	-0.86	57.59	74.00	16.41	100	218	vertical
2774.38	34.38	3.55	37.93	54.00	16.07	100	218	vertical
2774.38	46.38	3.55	49.93	74.00	24.07	100	218	vertical
3695.63	36.32	8.52	44.84	54.00	9.16	100	127	vertical
3695.63	47.32	8.52	55.84	74.00	18.16	100	127	vertical
4617.50	35.94	11.85	47.79	54.00	6.21	100	127	vertical
4617.50	51.47	11.85	63.32	74.00	10.68	100	127	vertical

Remarks: C.F (Correction Factor) = Antenna factor + Cable loss - Preamp gain



4, Songjuro 236Beon-gil, yanggi-myeon,
 Yongin-si, Gyeonggi-do, Korea
 Tel : +82-31-3236008,9
 Fax : +82-31-3236010
 www.ltalab.com

EUT/Model No.: EM100 (DEVICE)

Temp/Humi: 24 / 39

Test Mode : HIGH

Tested by: KWON H C

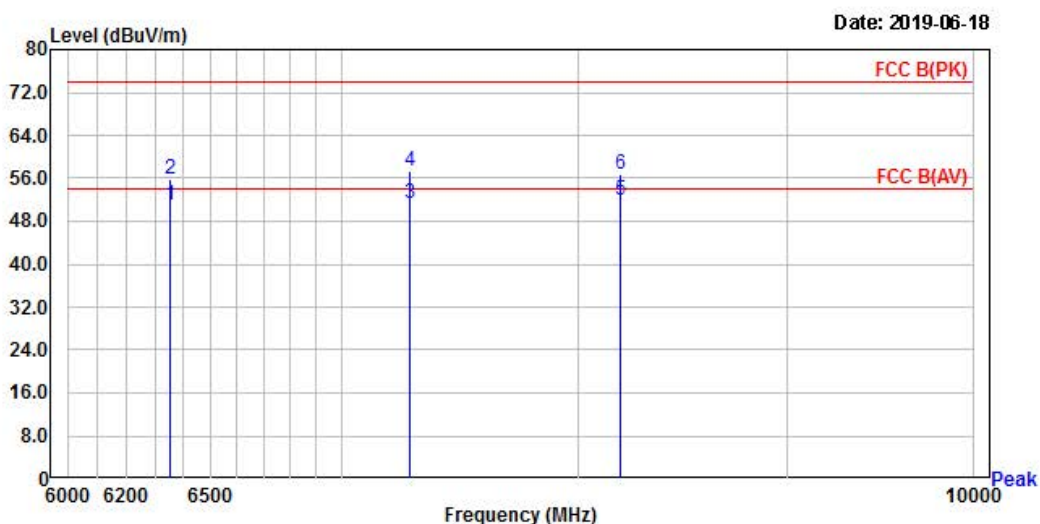

Freq	Reading	C.F	Result	Limit	Margin	Height	Angle	Polarity
MHz	dBuV	dB	QP dBuV/m	dBuV/m	dB	cm	deg	
6354.00	43.43	7.51	50.94	54.00	3.06	100	122	Horizontal
6354.00	48.43	7.51	55.94	74.00	18.06	100	122	Horizontal
7276.00	42.55	8.84	51.39	54.00	2.61	100	169	Horizontal
7276.00	48.55	8.84	57.39	74.00	16.61	100	169	Horizontal
8192.00	43.22	8.55	51.77	54.00	2.23	100	222	Horizontal
8192.00	48.22	8.55	56.77	74.00	17.23	100	222	Horizontal

Remarks: C.F (Correction Factor) = Antenna factor + Cable loss - Preamp gain



4, Songjuro 236Beon-gil, yanggi-myeon,
 Yongin-si, Gyeonggi-do, Korea
 Tel : +82-31-3236008,9
 Fax : +82-31-3236010
 www.ltalab.com

EUT/Model No.: EM100 (DEVICE)

Temp/Humi: 24 / 39

Test Mode : HIGH

Tested by: KWON H C

Date: 2019-06-18

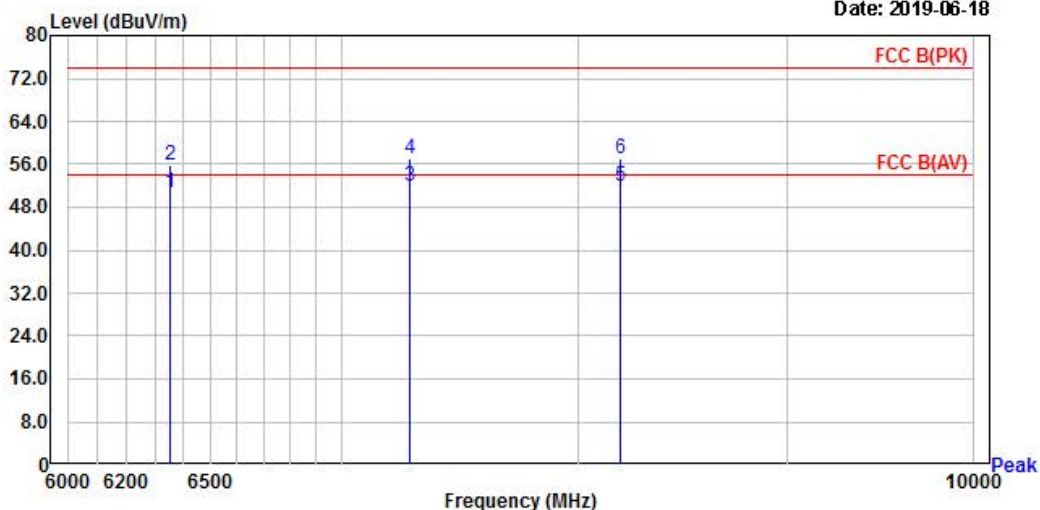

Freq	Reading	C.F	Result	Limit	Margin	Height	Angle	Polarity
MHz	dBuV	dB	QP dBuV/m	dBuV/m	dB	cm	deg	
6356.00	43.20	7.51	50.71	54.00	3.29	100	187	Vertical
6356.00	48.20	7.51	55.71	74.00	18.29	100	187	Vertical
7279.00	43.21	8.84	52.05	54.00	1.95	100	154	Vertical
7279.00	48.21	8.84	57.05	74.00	16.95	100	154	Vertical
8196.00	43.45	8.56	52.01	54.00	1.99	100	287	Vertical
8196.00	48.45	8.56	57.01	74.00	16.99	100	287	Vertical

Remarks: C.F (Correction Factor) = Antenna factor + Cable loss - Preamp gain

3.2.7 AC Conducted Emissions

Procedure:

The conducted emissions are measured in the shielded room with a spectrum analyzer in peak hold. While the measurement, EUT had its hopping function disabled at the middle channels in line with Section 15.31(m). Emissions closest to the limit are measured in the quasi-peak mode (QP) with the tuned receiver using a bandwidth of 9 kHz. The emissions are maximized further by cable manipulation and Exerciser operation. The highest emissions relative to the limit are listed.

Minimum Standard: FCC Part 15.207(a) / EN 55022

Measurement Data: Complies

Class B

Frequency Range	quasi-peak	Average
0.15 ~ 0.5	66 to 56 *	56 to 46 *
0.5 ~ 5	56	46
5 ~ 30	60	50

* Decreases with the logarithm of the frequency



4, Songjuro 236 Beon-gil, Yangji-myeon
 Cheoin-gu, Youngin-si, Gyeonggi-do
 449-822 Korea
 Tel:+82-31-3236008,9
 Fax:+82-31-3236010

EUT /Model No. : EM100(DEVICE)	Phase : LINE
Test Mode : Operating mode	Test Power : 220 / 60
Temp. / Humi. : 23'C / 37% R.H.	Test Engineer : Kwon H C

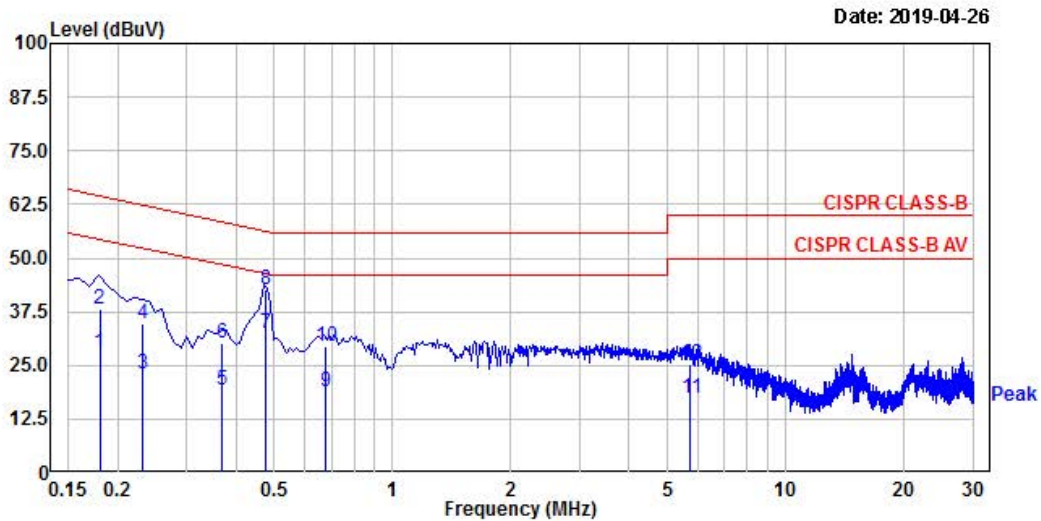

Freq MHz	RD QP dBuV	RD AV dBuV	C.F dB	Result QP dBuV	Result AV dBuV	Limit QP dBuV	Limit AV dBuV	Margin QP dB	Margin AV dB
0.180	18.50	8.57	19.43	37.93	28.00	64.47	54.47	26.54	26.47
0.231	15.44	3.50	19.44	34.88	22.94	62.42	52.42	27.54	29.48
0.369	10.85	-0.33	19.46	30.31	19.13	58.53	48.53	28.22	29.40
0.476	22.99	12.99	19.47	42.46	32.46	56.41	46.41	13.95	13.95
0.676	9.82	-0.69	19.47	29.29	18.78	56.00	46.00	26.71	27.22
5.724	5.47	-2.29	19.63	25.10	17.34	60.00	50.00	34.90	32.66

Remarks: C.F (Correction Factor) = Insertion loss + Cable loss + Pulse Limiter



4, Songjuro 236 Beon-gil, Yangji-myeon
 Cheoin-gu, Youngin-si, Gyeonggi-do
 449-822 Korea
 Tel:+82-31-3236008,9
 Fax:+82-31-3236010

EUT /Model No. : EM100(DEVICE)	Phase : NEUTRAL
Test Mode : Operating mode	Test Power : 220 / 60
Temp./ Humi. : 23'C / 37% R.H.	Test Engineer : Kwon H C

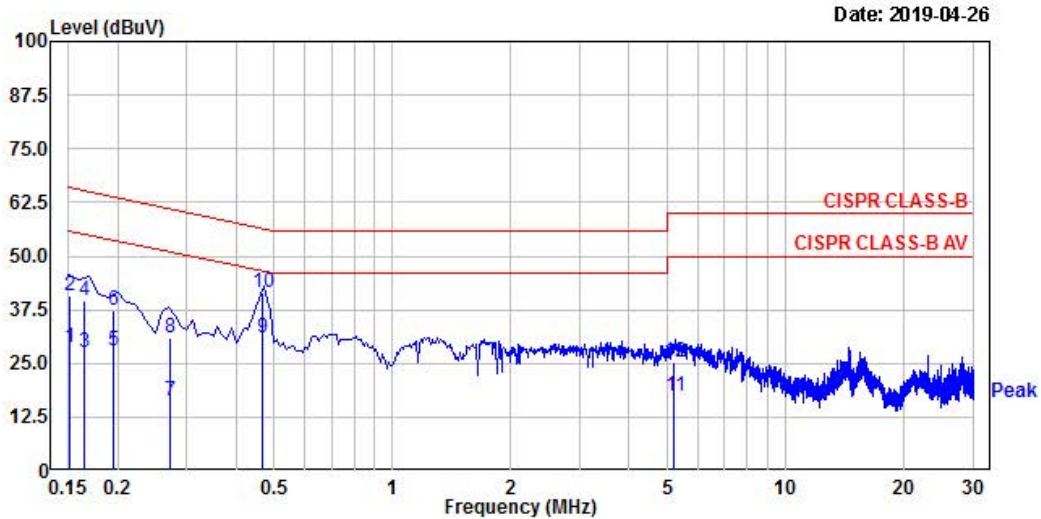

Freq MHz	RD QP dBuV	RD AV dBuV	C.F dB	Result QP dBuV	Result AV dBuV	Limit QP dBuV	Limit AV dBuV	Margin QP dB	Margin AV dB
0.151	21.38	9.31	19.44	40.82	28.75	65.94	55.94	25.12	27.19
0.165	20.09	8.03	19.44	39.53	27.47	65.21	55.21	25.68	27.74
0.195	18.03	8.49	19.44	37.47	27.93	63.81	53.81	26.34	25.88
0.271	11.32	-3.10	19.46	30.78	16.36	61.08	51.08	30.30	34.72
0.470	21.87	11.46	19.47	41.34	30.93	56.52	46.52	15.18	15.59
5.207	5.63	-2.08	19.62	25.25	17.54	60.00	50.00	34.75	32.46

Remarks: C.F (Correction Factor) = Insertion loss + Cable loss + Pulse Limiter

APPENDIX
TEST EQUIPMENT USED FOR TESTS

	Use	Description	Model No.	Serial No.	Manufacturer	Interval	Last Cal. Date
1	■	Signal Analyzer (9 kHz ~ 30 GHz)	FSV30	100757	R&S	1 year	2018-09-06
2		SYNTHESIZED CW GENERATOR	83711B	US34490456	HP	1 year	2019-03-16
3		Attenuator (3 dB)	8491A	37822	HP	1 year	2018-09-06
4		Attenuator (10 dB)	8491A	63196	HP	1 year	2018-09-06
5	■	EMI Test Receiver (~7 GHz)	ESCI7	100722	R&S	1 year	2018-09-06
6	■	RF Amplifier (~1.3 GHz)	8447D OPT 010	2944A07684	HP	1 year	2018-09-06
7	■	RF Amplifier (1~26.5 GHz)	8449B	3008A02126	HP	1 year	2019-03-16
8	■	Horn Antenna (1~18 GHz)	3115	00114105	ETS	2 year	2018-08-04
9		DRG Horn (Small)	3116B	81109	ETS-Lindgren	2 year	2018-05-03
10	■	DRG Horn (Small)	3116B	133350	ETS-Lindgren	2 year	2018-05-03
11	■	TRILOG Antenna	VULB 9160	9160-3237	SCHWARZBECK	2 year	2019-03-16
12		DC Power Supply	6674A	3637A01657	Agilent	-	-
13	■	Power Meter	EPM-441A	GB32481702	HP	1 year	2019-03-16
14	■	Power Sensor	8481A	3318A94972	HP	1 year	2018-09-06
15		Audio Analyzer	8903B	3729A18901	HP	1 year	2018-09-06
16		Modulation Analyzer	8901B	3749A05878	HP	1 year	2018-09-06
17		TEMP & HUMIDITY Chamber	YJ-500	LTAS06041	JinYoung Tech	1 year	2018-09-06
18		Stop Watch	HS-3	812Q08R	CASIO	2 year	2018-03-21
19	■	LISN	KNW-407	8-1430-1	Kyoritsu	1 year	2018-09-06
20		Two-Lime V-Network	ESH3-Z5	893045/017	R&S	1 year	2019-03-16
21		Highpass Filter	WHKX1.5/15G-10SS	74	Wainwright Instruments	1 year	2019-03-16
22		Highpass Filter	WHKX3.0/18G-10SS	118	Wainwright Instruments	1 year	2019-03-16
23		OSP120 BASE UNIT	OSP120	101230	R&S	1 year	2019-03-16
24	■	Signal Generator(100 kHz ~ 40 GHz)	SMB100A	177621	R&S	1 year	2019-03-16
25		Vector Signal Generator(9kHz ~ 6 GHz)	SMBV100A	255081	R&S	1 year	2019-03-16
26		Signal Analyzer (10 Hz ~ 40 GHz)	FSV40	101367	R&S	1 year	2019-03-16
27	■	RF Cable	SUCOFLEX	-	Huber+suhner	-	-