

View of Product-7

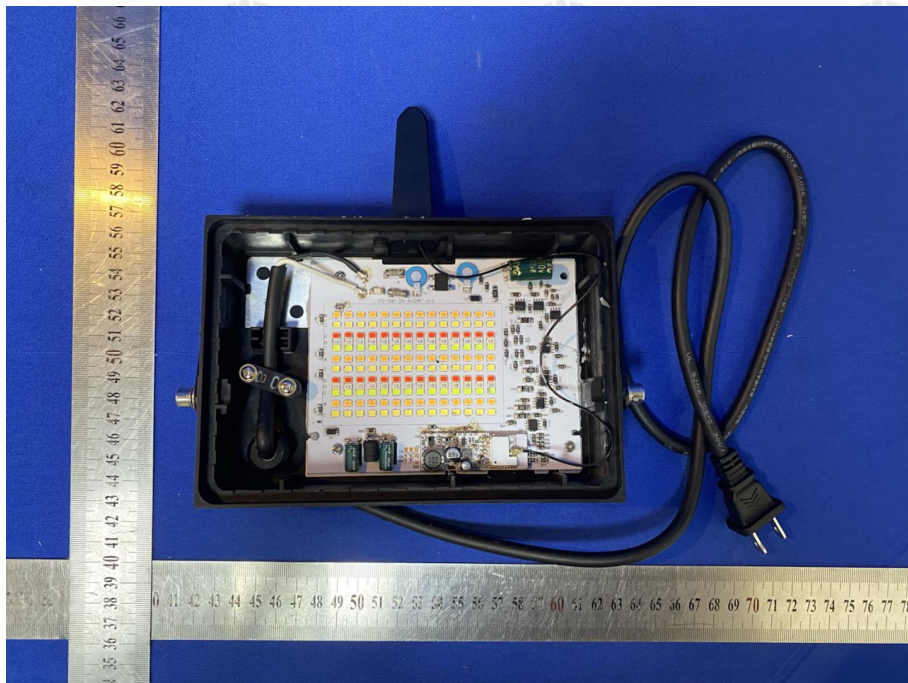

View of Product-8

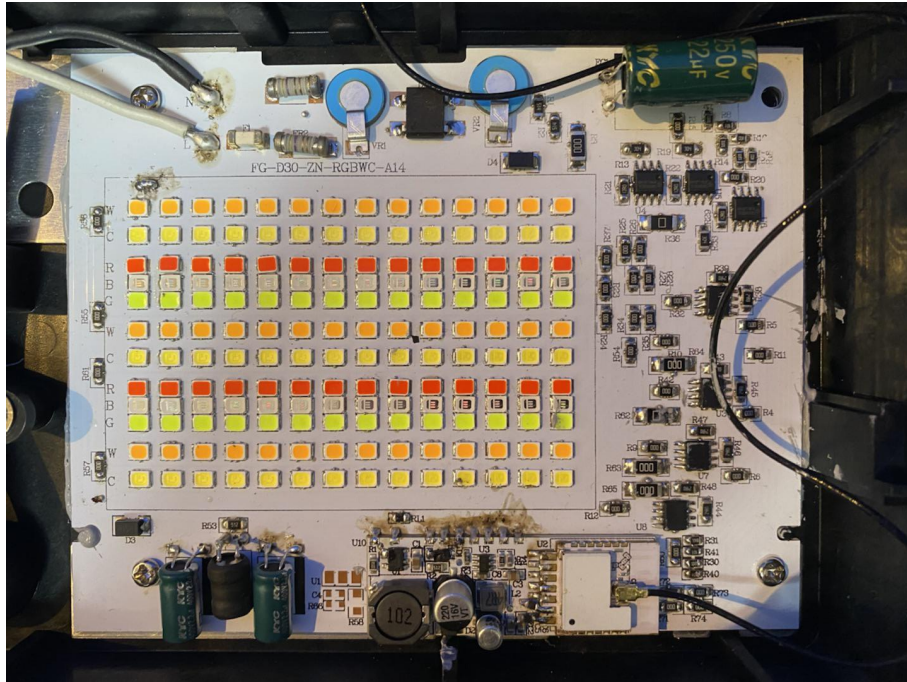

View of Product-9

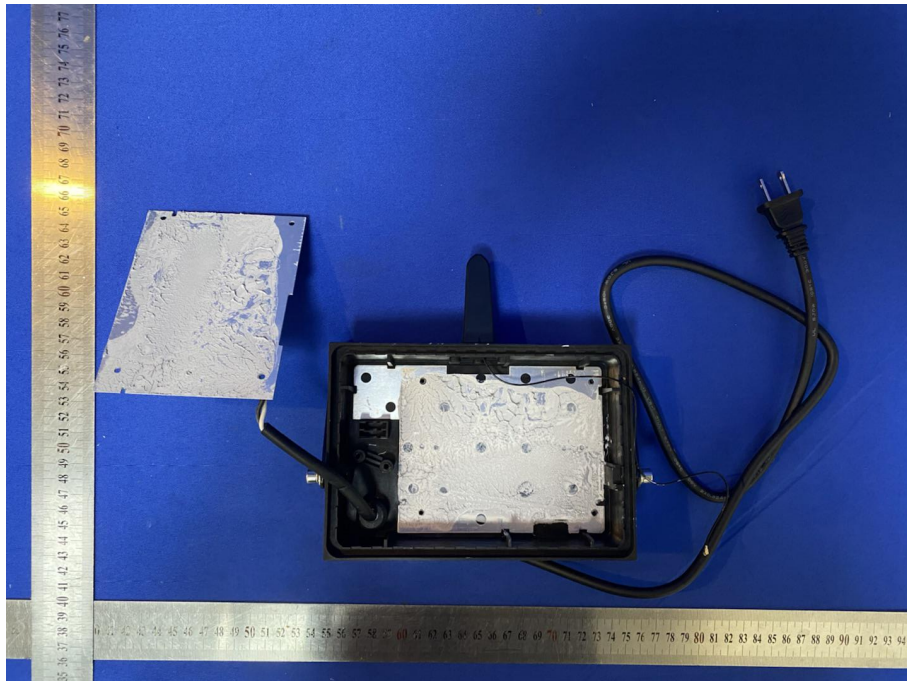

View of Product-10

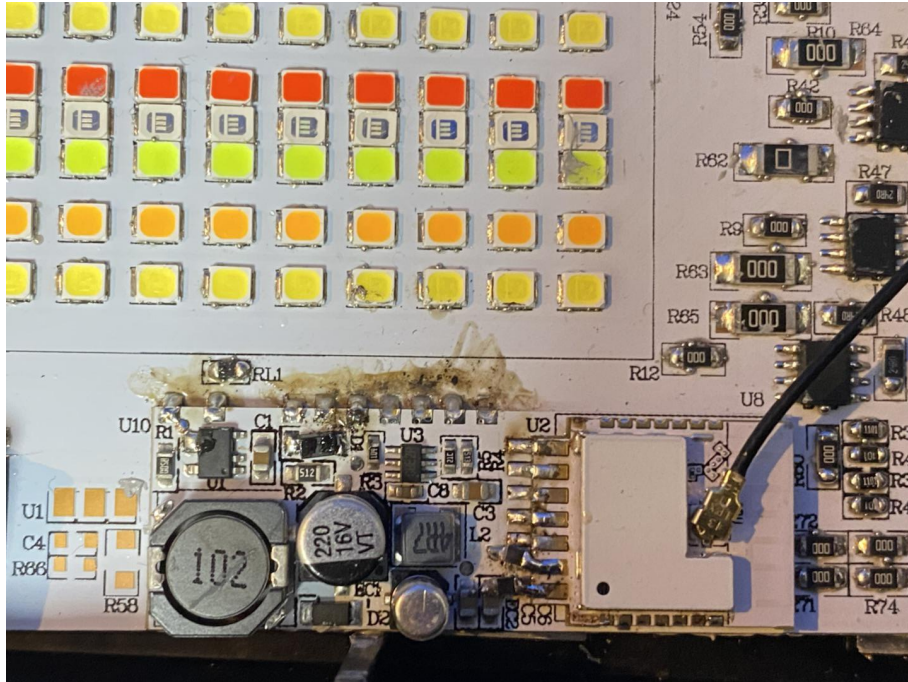

View of Product-11

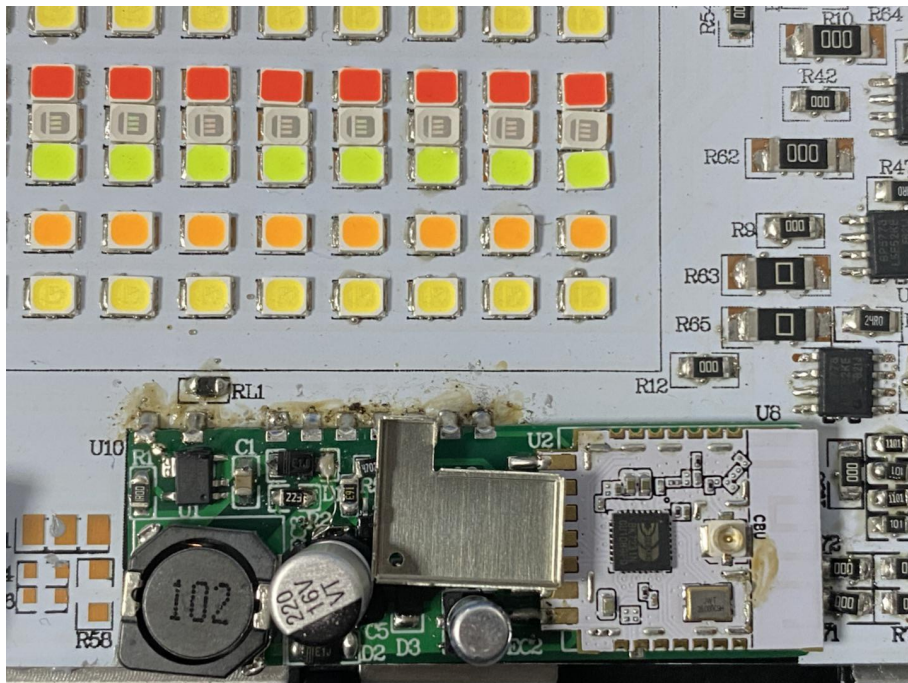

View of Product-12

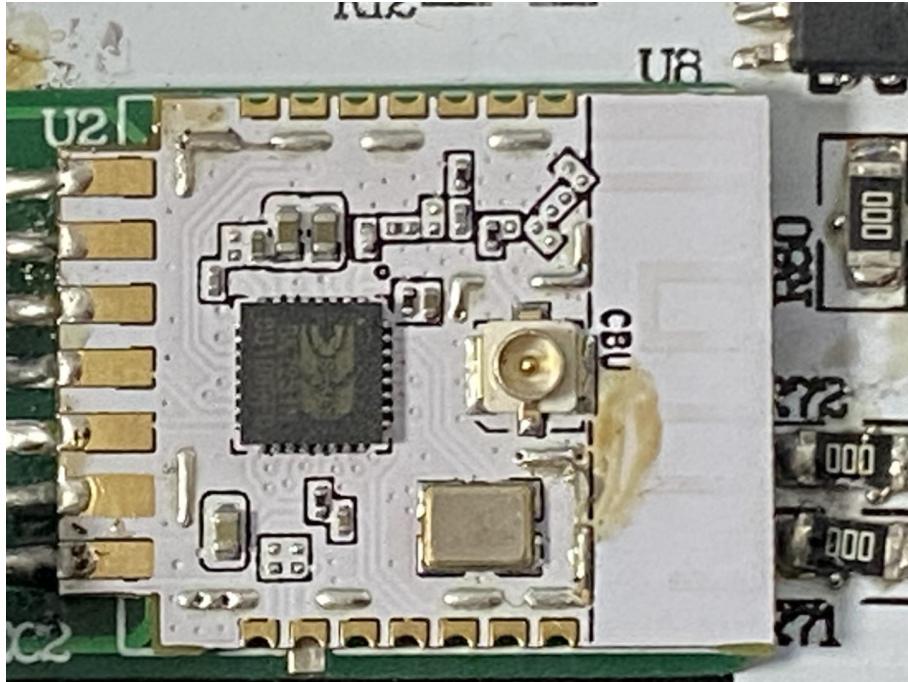

View of Product-13

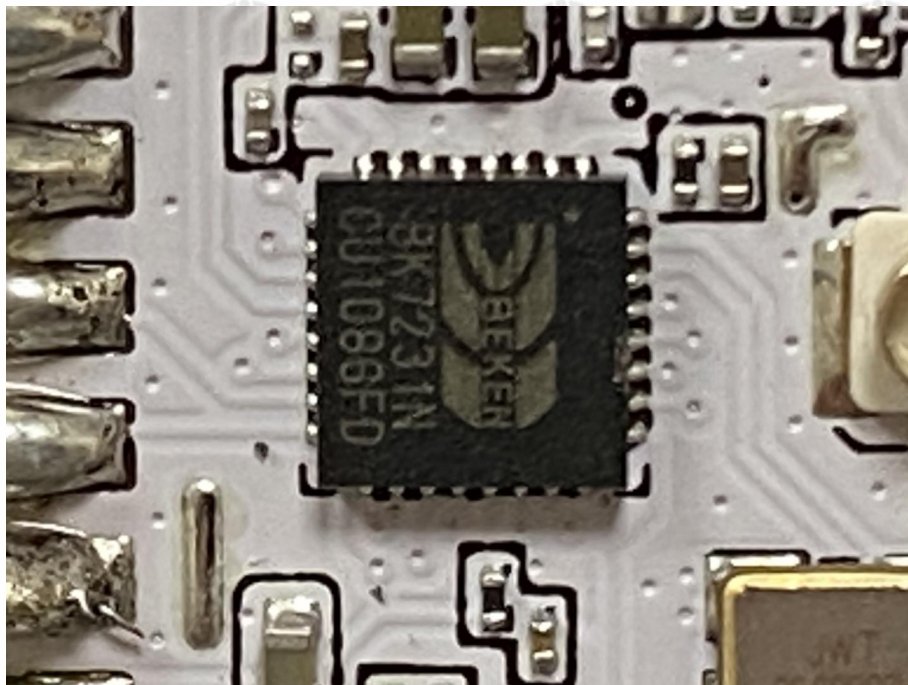

View of Product-14

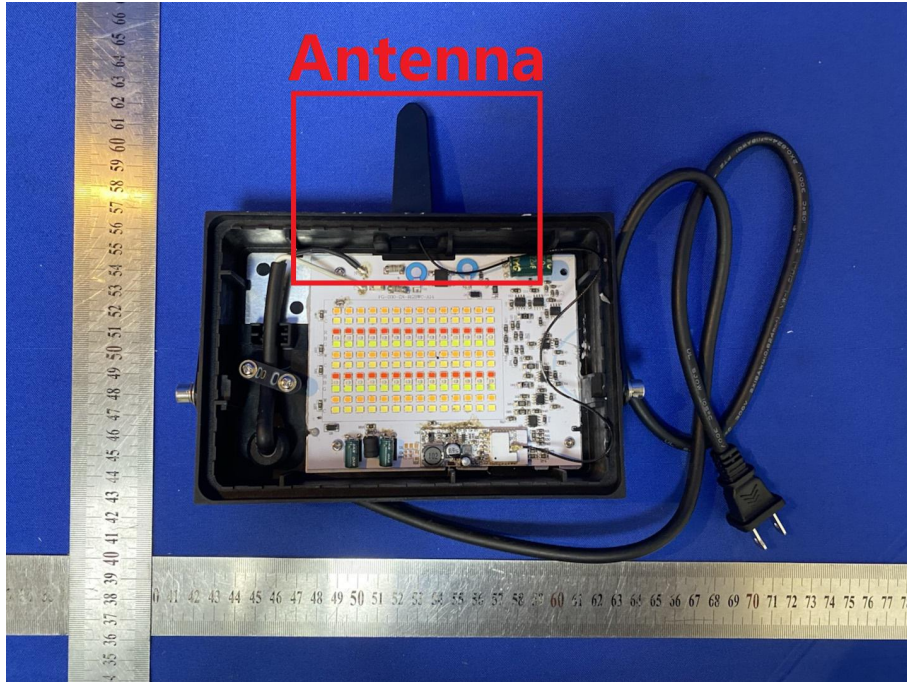

View of Product-15

The test report is effective only with both signature and specialized stamp, The result(s) shown in this report refer only to the sample(s) tested. Without written approval of CTI, this report can't be reproduced except in full.

\*\*\* End of Report \*\*\*