



FCC RADIO TEST REPORT

FCC ID:2AT5P-XXAT010

Product: Commercial Coordinator

Trade Name: X²intelli

Model Name: XXAT010

XXAT011, XXAT012, XXAT013, XXAT014,

Serial Model: XXAT015, XXAT016, XXAT017, XXAT018,
XXAT019

Report No.: UNIA19082112FR-01

Prepared for

Xiuxiang Smart(Shenzhen) Co., Ltd.

401-411,Building 5A, Tusincere Park, No. 333, Longfei Rd., Huanggekeng
Community Longcheng Street, Longgang District, Shenzhen China

Prepared by

Shenzhen United Testing Technology Co., Ltd.

2F, Annex Bldg, Jiahuangyuan Tech Park, #365 Baotian 1 Rd, Tiegang
Community, Xixiang Str, Bao'an District, Shenzhen, China



TEST RESULT CERTIFICATION

Applicant's name..... : Xiuxiang Smart(Shenzhen) Co., Ltd.
 Address..... : 401-411, Building 5A, Tusincere Park, No. 333, Longfei Rd.,
 Huanggekeng Community Longcheng Street, Longgang District,
 Shenzhen China

Manufacture's Name..... : Xiuxiang Smart(Shenzhen) Co., Ltd.
 Address..... : 401-411, Building 5A, Tusincere Park, No. 333, Longfei Rd.,
 Huanggekeng Community Longcheng Street, Longgang District,
 Shenzhen China

Product description

Product name..... : Commercial Coordinator

Trade Mark..... :

Model and/or type reference .. : XXAT010, XXAT011, XXAT012, XXAT013, XXAT014,
 XXAT015, XXAT016, XXAT017, XXAT018, XXAT019

Standards..... : FCC Rules and Regulations Part 15 Subpart C Section 15.249,
 ANSI C63.10: 2013

This device described above has been tested by Shenzhen United Testing Technology Co., Ltd., and the test results show that the equipment under test (EUT) is in compliance with the FCC requirements. And it is applicable only to the tested sample identified in the report.

This report shall not be reproduced except in full, without the written approval of UNI, this document may be altered or revised by Shenzhen United Testing Technology Co., Ltd., personnel only, and shall be noted in the revision of the document.

Date of Test..... :
 Date (s) of performance of tests..... : Aug. 21, 2019 ~ Sep. 27, 2019
 Date of Issue..... : Sep. 27, 2019
 Test Result..... : Pass

Prepared by:

Kahn Yang

Kahn yang/Editor

Reviewer:

Sherwin Qian

Sherwin Qian/Supervisor

Approved & Authorized Signer:

Liuzze

Liuzze/Manager

Table of Contents

Page

1 . TEST SUMMARY	4
2 . GENERAL INFORMATION	5
2.1 GENERAL DESCRIPTION OF EUT	5
2.2 Carrier Frequency of Channels	6
2.3 Operation of EUT during testing	6
2.4 DESCRIPTION OF TEST SETUP	6
2.5 MEASUREMENT INSTRUMENTS LIST	7
3 . CONDUCTED EMISSIONS TEST	8
3.1 Conducted Power Line Emission Limit	8
3.2 Test Setup	8
3.3 Test Procedure	8
3.4 Test Result	8
4 RADIATED EMISSION TEST	11
4.1 Radiation Limit	11
4.2 Test Setup	11
4.3 Test Procedure	12
4.4 Test Result	12
5 BAND EDGE	18
5.1 Limits	18
5.2 Test Procedure	18
5.3 Test Result	18
6 OCCUPIED BANDWIDTH MEASUREMENT	20
6.1 Test Setup	20
6.2 Test Procedure	20
6.3 Measurement Equipment Used	20
6.4 Test Result	20
7 ANTENNA REQUIREMENT	22
8 PHOTOGRAPH OF TEST	23
8.1 Radiated Emission	23

1. TEST SUMMARY

TEST PROCEDURES AND RESULTS

DESCRIPTION OF TEST	RESULT	STANGARD
CONDUCTED EMISSIONS TEST	COMPLIANT	FCC Part 15.207
RADIATED EMISSION TEST	COMPLIANT	FCC Part 15.209(a)15.207(a)
BAND EDGE	COMPLIANT	FCC Part 15.247(d)
OCCUPIED BANDWIDTH MEASUREMENT	COMPLIANT	FCC Part 15.247(a)(1)
ANTENNA REQUIREMENT	COMPLIANT	FCC Part 15.203

TEST FACILITY

Test Firm : Shenzhen United Testing Technology Co., Ltd.

Address : 2F, Annex Bldg, Jiahuangyuan Tech Park, #365 Baotian 1 Rd, Tiegang Community, Xixiang Str, Bao'an District, Shenzhen, China

The testing quality ability of our laboratory meet with "Quality Law of People's Republic of China" Clause 19. The testing quality system of our laboratory meets with ISO/IEC-17025 requirements. This approval result is accepted by MRA of APLAC.

Our test facility is recognized, certified, or accredited by the following organizations:

A2LA Certificate Number: 4747.01

The EMC Laboratory has been accredited by A2LA, and in compliance with ISO/IEC 17025:2017 General Requirements for testing Laboratories.

FCC Registration Number: 674885

The EMC Laboratory has been registered and fully described in a report filed with the (FCC) Federal Communications commission.

IC Registration Number: 21947

The EMC Laboratory has been registered and fully described in a report filed with the (IC) Industry Canada.

MEASUREMENT UNCERTAINTY

Measurement Uncertainty

Conducted Emission Expanded Uncertainty	=	2.23dB, k=2
Radiated emission expanded uncertainty(9kHz-30MHz)	=	3.08dB, k=2
Radiated emission expanded uncertainty(30MHz-1000MHz)	=	4.42dB, k=2
Radiated emission expanded uncertainty(Above 1GHz)	=	4.06dB, k=2

2. GENERAL INFORMATION

2.1 GENERAL DESCRIPTION OF EUT

Equipment	Commercial Coordinator
Trade Mark	
Model Name	XXAT010
Serial No.	XXAT011, XXAT012, XXAT013, XXAT014, XXAT015, XXAT016, XXAT017, XXAT018, XXAT019
Model Difference	All model's the function, software and electric circuit are the same, only with a product color and model named different. Test sample model: XXAT010.
FCC ID	2AT5P-XXAT010
Antenna Type	External Antenna
Antenna Gain	1dBi
Frequency Range	2402~2480MHz
Number of Channels	79CH
Modulation Type	GFSK
Battery	3.7V 4000mAh
Power Source	AC 100-240V~50/60Hz

2.2 Carrier Frequency of Channels

Channel List							
Channel	Frequency (MHz)	Channel	Frequency (MHz)	Channel	Frequency (MHz)	Channel	Frequency (MHz)
00	2402	21	2423	42	2444	63	2465
01	2403	22	2424	43	2445	64	2466
02	2404	23	2425	44	2446	65	2467
03	2405	24	2426	45	2447	66	2468
04	2406	25	2427	46	2448	67	2469
05	2407	26	2428	47	2449	68	2470
06	2408	27	2429	48	2450	69	2471
07	2409	28	2430	49	2451	70	2472
08	2410	29	2431	50	2452	71	2473
09	2411	30	2432	51	2453	72	2474
10	2412	31	2433	52	2454	73	2475
11	2413	32	2434	53	2455	74	2476
12	2414	33	2435	54	2456	75	2477
13	2415	34	2436	55	2457	76	2478
14	2416	35	2437	56	2458	77	2479
15	2417	36	2438	57	2459	78	2480
16	2418	37	2439	58	2460		
17	2419	38	2440	59	2461		
18	2420	39	2441	60	2462		
19	2421	40	2442	61	2463		
20	2422	41	2443	62	2464		

2.3 Operation of EUT during testing

Operating Mode

The mode is used: Transmitting simultaneously mode

Low Channel: 2402MHz

Middle Channel: 2440MHz

High Channel: 2480MHz

2.4 DESCRIPTION OF TEST SETUP

Operation of EUT during Conducted testing:

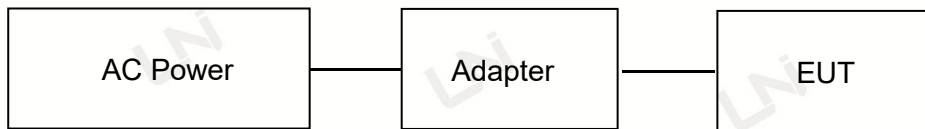

Operation of EUT during Radiation testing:



Table for auxiliary equipment:

Equipment Description	Manufacturer	Model	Calibration Due Date
N/A	N/A	N/A	N/A

2.5 MEASUREMENT INSTRUMENTS LIST

Item	Equipment	Manufacturer	Model No.	Serial No.	Calibrated until
CONDUCTED EMISSIONS TEST					
1	AMN	Schwarzbeck	NNLK8121	8121370	2020.9.6
2	AMN	ETS	3810/2	00020199	2020.9.6
3	EMI TEST RECEIVER	Rohde&Schwarz	ESCI	101210	2020.9.6
4	AAN	TESEQ	T8-Cat6	38888	2020.9.6
RADIATED EMISSION TEST					
1	Horn Antenna	Sunol	DRH-118	A101415	2020.9.6
2	BicoNLog Antenna	Sunol	JB1 Antenna	A090215	2020.9.6
3	PREAMP	HP	8449B	3008A00160	2020.9.6
4	PREAMP	HP	8447D	2944A07999	2020.9.6
5	EMI TEST RECEIVER	Rohde&Schwarz	ESR3	101891	2020.9.6
6	VECTOR Signal Generator	Rohde&Schwarz	SMU200A	101521	2020.9.6
7	Signal Generator	Agilent	E4421B	MY4335105	2020.9.6
8	MXA Signal Analyzer	Agilent	N9020A	MY50510140	2020.9.6
9	MXA Signal Analyzer	Agilent	N9020A	MY51110104	2020.9.6
10	ANT Tower&Turn table Controller	Champro	EM 1000	60764	2020.9.6
11	Anechoic Chamber	Taihe Maorui	9m*6m*6m	966A0001	2020.9.6
12	Shielding Room	Taihe Maorui	6.4m*4m*3m	643A0001	2020.9.6
13	RF Power sensor	DARE	RPR3006W	15I00041SNO88	2020.3.14
14	RF Power sensor	DARE	RPR3006W	15I00041SNO89	2020.3.14
15	RF power divider	Anritsu	K241B	992289	2019.9.28
16	Wideband radio communication tester	Rohde&Schwarz	CMW500	154987	2020.9.6
17	Biconical antenna	Schwarzbeck	VHA 9103	91032360	2020.9.6
18	Biconical antenna	Schwarzbeck	VHA 9103	91032361	2020.9.6
19	Broadband Hybrid Antennas	Schwarzbeck	VULB9163	VULB9163#958	2020.9.6
20	Horn Antenna	Schwarzbeck	BBHA9120D	9120D-1680	2020.1.12
21	Active Receive Loop Antenna	Schwarzbeck	FMZB 1919B	00023	2019.11.02
22	Horn Antenna	A-INFOMW	LB-180400-KF	J211060660	2020.03.14
23	Microwave Broadband Pre-amplifier	Schwarzbeck	BBV 9721	100472	2019.10.24
24	Active Loop Antenna	Com-Power	AL-130R	10160009	2020.05.10
25	Power Meter	KEYSIGHT	N1911A	MY50520168	2020.05.10
26	Frequency Meter	VICTOR	VC2000	997406086	2020.05.10
27	DC Power Source	HYELEC	HY5020E	055161818	2020.05.10

3. CONDUCTED EMISSIONS TEST

3.1 Conducted Power Line Emission Limit

For unintentional device, according to § 15.107(a) Line Conducted Emission Limits is as following

Frequency (MHz)	Maximum RF Line Voltage(dBμV)			
	CLASS A		CLASS B	
	Q.P.	Ave.	Q.P.	Ave.
0.15~0.50	79	66	66~56*	56~46*
0.50~5.00	73	60	56	46
5.00~30.0	73	60	60	50

* Decreasing linearly with the logarithm of the frequency

For intentional device, according to §15.207(a) Line Conducted Emission Limit is same as above table.

3.2 Test Setup

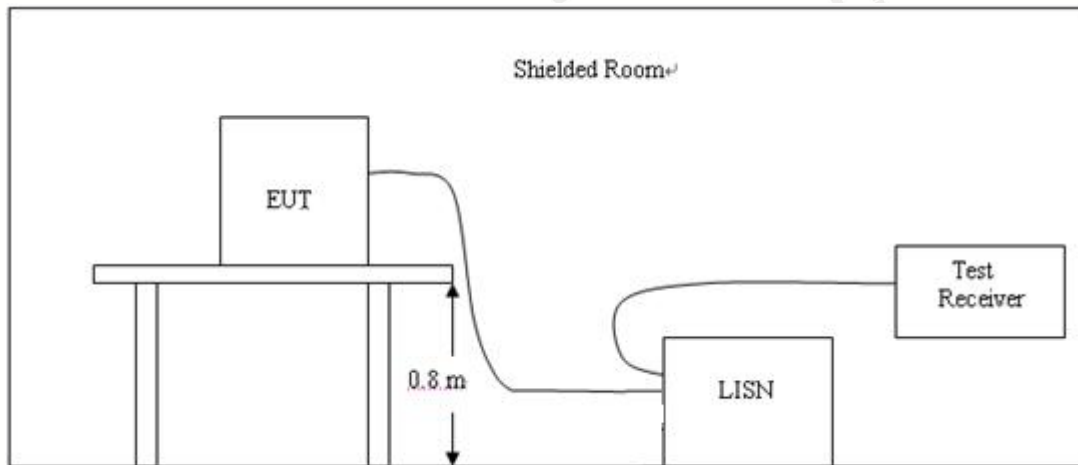

3.3 Test Procedure

- 1, The equipment was set up as per the test configuration to simulate typical actual usage per the user's manual. The EUT is a tabletop system, a wooden table with a height of 0.8 meters is used and is placed on the ground plane as per ANSI C63.10.
- 2, Support equipment, if needed, was placed as per ANSI C63.10.
- 3, All I/O cables were positioned to simulate typical actual usage as per ANSI C63.10.
- 4, If a EUT received DC power from the USB Port of Notebook PC, the PC's adapter received AC 120V/60Hz power through a Line Impedance Stabilization Network (LISN) which supplied power source and was grounded to the ground plane.
- 5, All support equipments received AC power from a second LISN, if any.
- 6, The EUT test program was started. Emissions were measured on each current carrying line of the EUT using a spectrum Analyzer / Receiver connected to the LISN powering the EUT. The LISN has two monitoring points: Line 1 (Hot Side) and Line 2 (Neutral Side). Two scans were taken: one with Line 1 connected to Analyzer / Receiver and Line 2 connected to a 50 ohm load; the second scan had Line 1 connected to a 50 ohm load and Line 2 connected to the Analyzer / Receiver.
- 7, Analyzer / Receiver scanned from 150 KHz to 30MHz for emissions in each of the test modes.

3.4 Test Result

PASS

Remark:

1. All modes were tested at AC 120V, only the worst result of AC 120V 60Hz was reported. When the prototype is in test, the wireless module transmits at the same time.
2. All modes of Low, Middle, and High channel were tested, only the worst result of High Channel was reported as below:

Temperature:	24°C	Relative Humidity:	45%
Test Date:	Sep. 10, 2019	Pressure:	1010hPa
Test Voltage:	AC 120V	Phase:	Line
Test Mode:	Transmitting mode of GFSK 2480MHz		

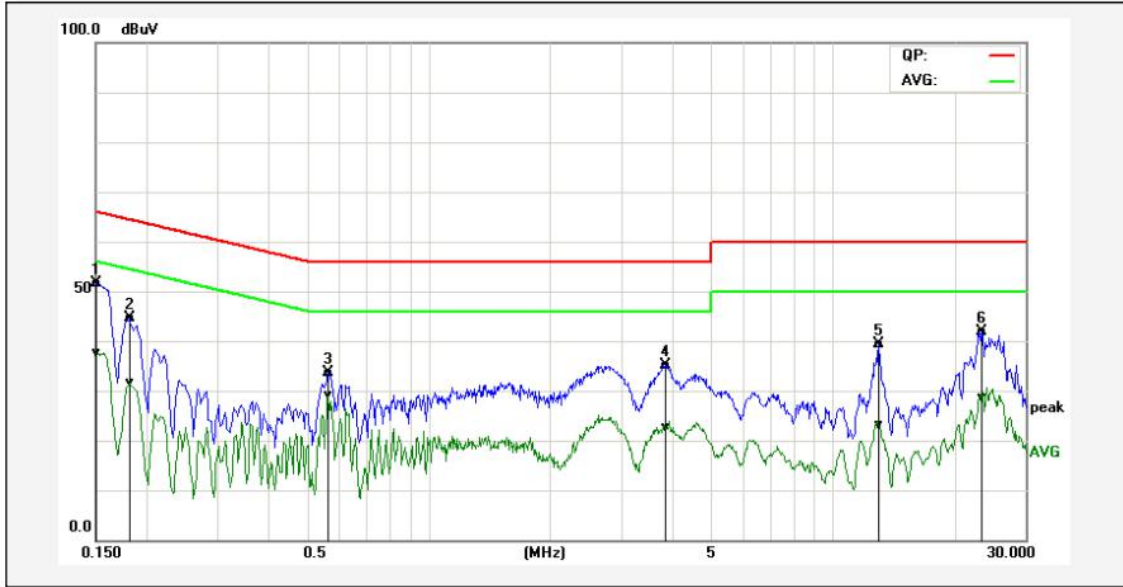

No.	Frequency (MHz)	QuasiPeak reading (dBuV)	Average reading (dBuV)	Correction factor (dB)	QuasiPeak result (dBuV)	Average result (dBuV)	QuasiPeak limit (dBuV)	Average limit (dBuV)	QuasiPeak margin (dB)	Average margin (dB)	Remark
1*	0.1500	42.13	28.15	9.53	51.66	37.68	65.99	56.00	-14.33	-18.32	Pass
2P	0.1819	35.06	21.97	9.58	44.64	31.55	64.39	54.40	-19.75	-22.85	Pass
3P	0.5660	24.04	19.38	9.69	33.73	29.07	56.00	46.00	-22.27	-16.93	Pass
4P	3.8620	25.33	12.68	9.83	35.16	22.51	56.00	46.00	-20.84	-23.49	Pass
5P	13.0140	39.16	22.99	0.24	39.40	23.23	60.00	50.00	-20.60	-26.77	Pass
6P	23.3860	41.23	28.08	0.58	41.81	28.66	60.00	50.00	-18.19	-21.34	Pass

Remark: Factor = Insertion Loss + Cable Loss, Result=Reading + Factor, Margin=Result – Limit.



Temperature:	24°C	Relative Humidity:	45%
Test Date:	Sep. 10, 2019	Pressure:	1010hPa
Test Voltage:	AC 120V	Phase:	Neutral
Test Mode:	Transmitting mode of GFSK 2480MHz		

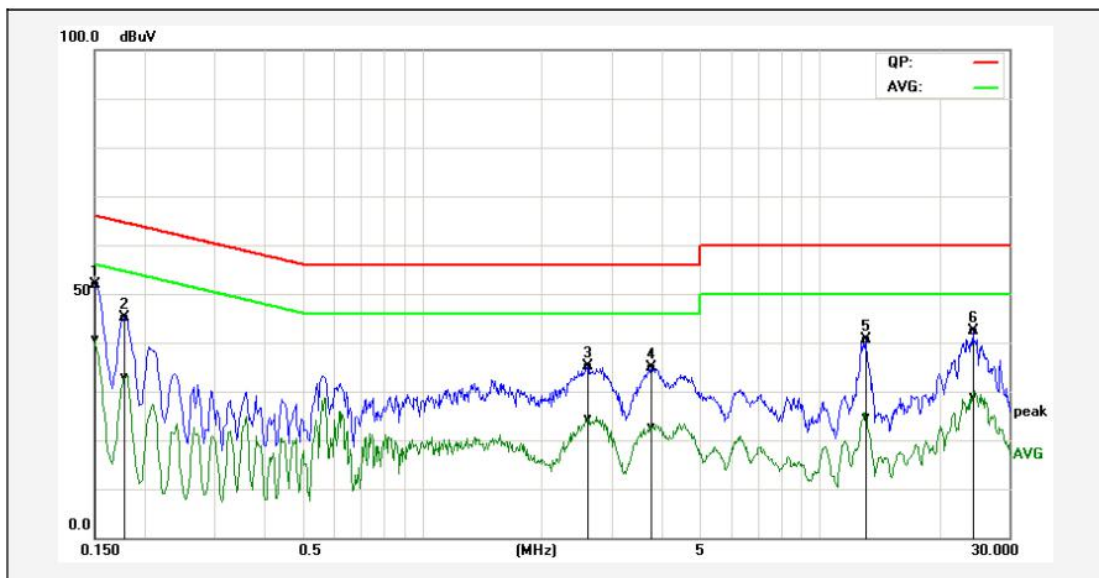

No.	Frequency (MHz)	QuasiPeak reading (dBuV)	Average reading (dBuV)	Correction factor (dB)	QuasiPeak result (dBuV)	Average result (dBuV)	QuasiPeak limit (dBuV)	Average limit (dBuV)	QuasiPeak margin (dB)	Average margin (dB)	Remark
1*	0.1500	42.38	31.11	9.53	51.91	40.64	65.99	56.00	-14.08	-15.36	Pass
2P	0.1780	35.58	23.34	9.58	45.16	32.92	64.57	54.58	-19.41	-21.66	Pass
3P	2.6140	25.30	14.50	9.82	35.12	24.32	56.00	46.00	-20.88	-21.68	Pass
4P	3.7740	25.10	12.83	9.85	34.95	22.68	56.00	46.00	-21.05	-23.32	Pass
5P	13.0580	40.39	24.48	0.24	40.63	24.72	60.00	50.00	-19.37	-25.28	Pass
6P	24.3819	41.73	28.38	0.62	42.35	29.00	60.00	50.00	-17.65	-21.00	Pass

Remark: Factor = Insertion Loss + Cable Loss, Result=Reading + Factor, Margin=Result – Limit.

4 RADIATED EMISSION TEST

4.1 Radiation Limit

For unintentional device, according to § 15.249(a), except for Class B digital devices, the field strength of radiated emissions from unintentional radiators at a distance of 3 meters shall not exceed the following values:

Frequency (MHz)	Distance (Meters)	Radiated (dB μ V/m)	Radiated (μ V/m)
30-88	3	40	100
88-216	3	43.5	150
216-960	3	46	200
Above 960	3	54	500

For intentional device, according to § 15.209(a), the general requirement of field strength of radiated emissions from intentional radiators at a distance of 3 meters shall not exceed the above table.

4.2 Test Setup

1. Radiated Emission Test-Up Frequency Below 30MHz

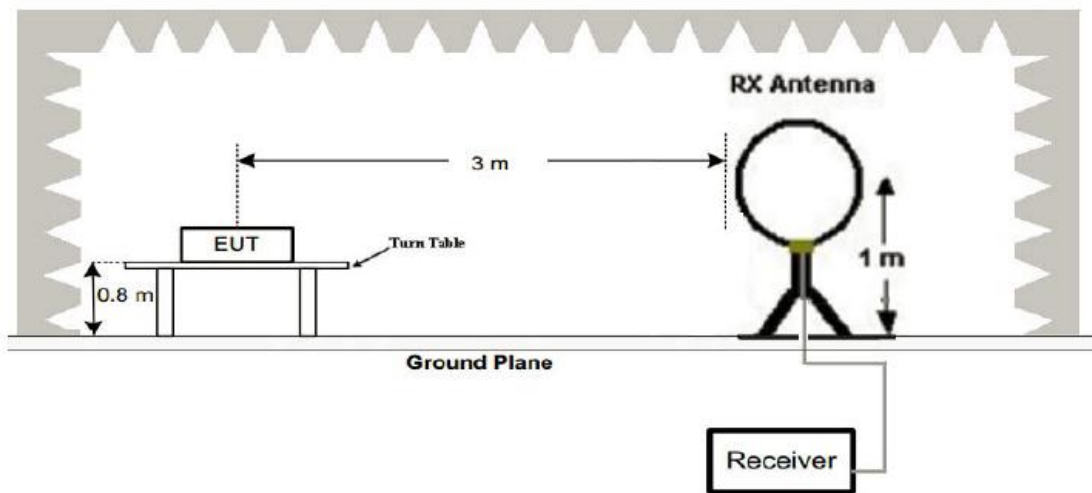

2. Radiated Emission Test-Up Frequency 30MHz~1GHz

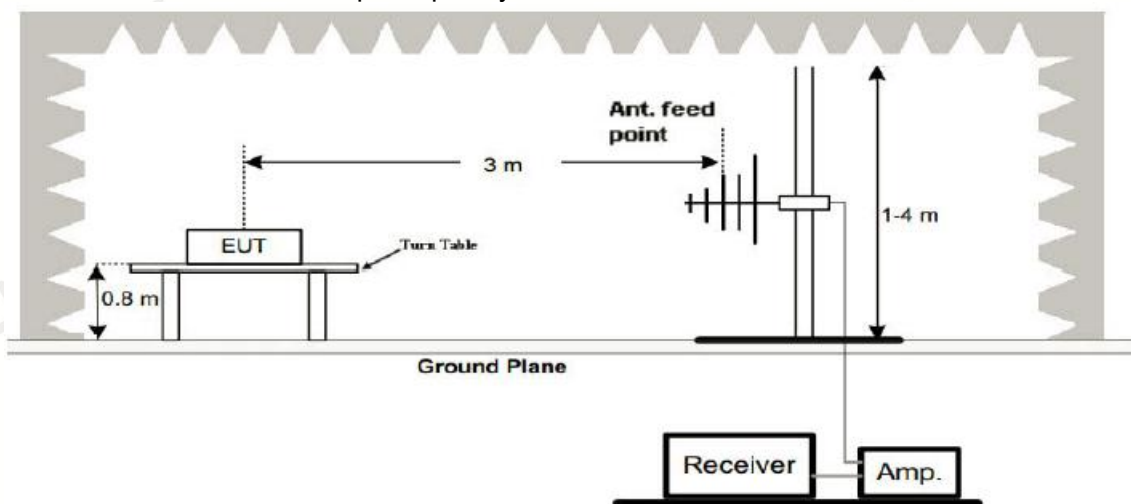

3. Radiated Emission Test-Up Frequency Above 1GHz

For unintentional device, according to § 15.249(a), except for Class B digital devices, the field strength of radiated emissions from unintentional radiators at a distance of 3 meters shall not exceed the following values:

Frequency (MHz)	Distance (Meters)	Radiated (dBµV/m)	Detection method
2400-2483.5	3	114	PK
2400-2483.5	3	94	AV

For intentional device, according to § 15.209(a), the general requirement of field strength of radiated emissions from intentional radiators at a distance of 3 meters shall not exceed the above table.

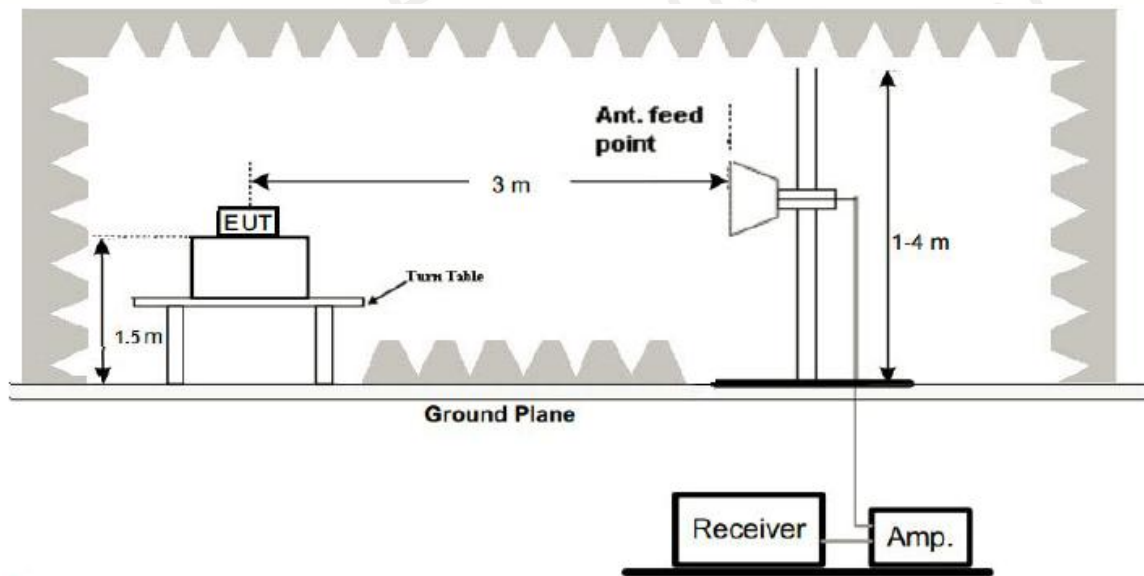

4.3 Test Procedure

1. Below 1GHz measurement the EUT is placed on turntable which is 0.8m above ground plane. And above 1GHz measurement EUT was placed on low permittivity and low tangent turn table which is 1.5m above ground plane.
2. The turntable shall be rotated for 360 degrees to determine the position of maximum emission level.
3. EUT is set 3m away from the receiving antenna, which is varied from 1m to 4m to find out the highest emissions.
4. Maximum procedure was performed on the six highest emissions to ensure EUT compliance.
5. And also, each emission was to be maximized by changing the polarization of receiving antenna both horizontal and vertical.
6. Repeat above procedures until the measurements for all frequencies are complete.
7. The test frequency range from 9KHz to 25GHz per FCC PART 15.33(a).

4.4 Test Result

PASS

Remark:

1. All the test modes completed for test. The worst case of Radiated Emission is High channel, the test data of this mode was reported.
2. By preliminary testing and verifying three axis (X, Y and Z) position of EUT transmitted status, it was found that "Z axis" position was the worst, and test data recorded in this report.
3. Radiated emission test from 9KHz to 10th harmonic of fundamental was verified, and no emission found except system noise floor in 9KHz to 30MHz and not recorded in this report.
4. When the prototype is in test, the wireless module transmits at the same time.



Below 1GHz Test Results:

Temperature:	24°C	Relative Humidity:	45%
Test Date:	Sep. 10, 2019	Pressure:	1010hPa
Test Voltage:	AC 120V	Polarization:	Horizontal
Test Mode:	Transmitting mode of GFSK2480MHz		

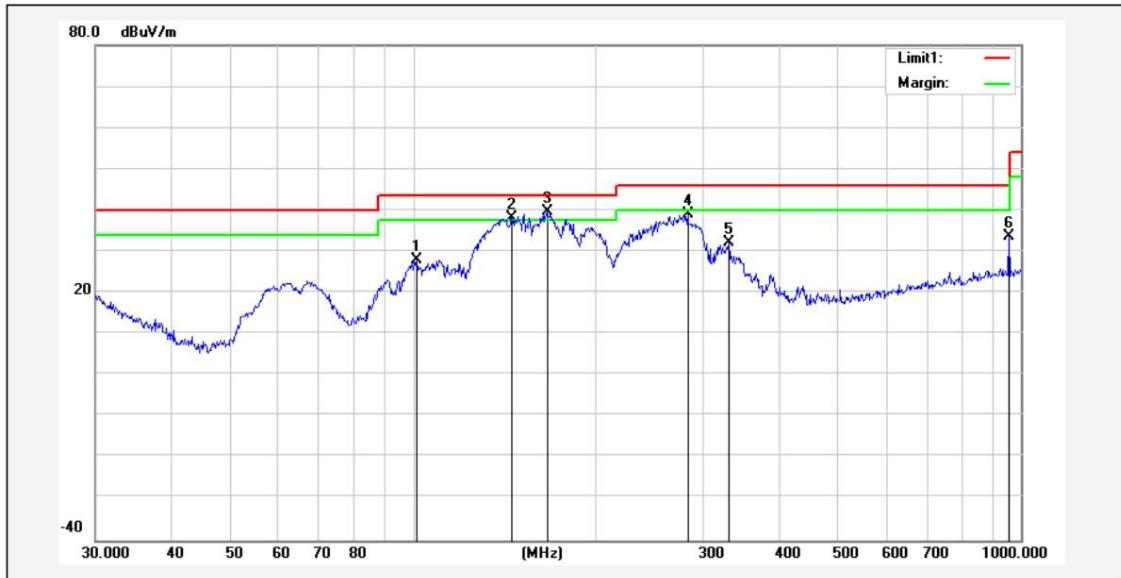

No.	Frequency (MHz)	Reading (dBuV)	Correction factor(dB/m)	Result (dBuV/m)	Limit (dBuV/m)	Margin (dB)	Degree (deg.)	Height (cm)	Remark
1	101.2885	44.35	-16.52	27.83	43.50	-15.67			peak
2!	145.3506	51.79	-13.53	38.26	43.50	-5.24			peak
3*	166.0680	51.07	-11.46	39.61	43.50	-3.89			peak
4	282.9852	51.45	-12.44	39.01	46.00	-6.99			peak
5	330.1949	44.27	-12.08	32.19	46.00	-13.81			peak
6	955.4381	35.11	-1.48	33.63	46.00	-12.37			peak

Remark: Absolute Level= Reading Level+ Factor, Margin= Absolute Level – Limit
 Factor=Ant. Factor + Cable Loss – Pre-amplifier



Temperature:	24°C	Relative Humidity:	45%
Test Date:	Sep. 10, 2019	Pressure:	1010hPa
Test Voltage:	AC 120V	Polarization:	Vertical
Test Mode:	Transmitting mode of GFSK2480MHz		

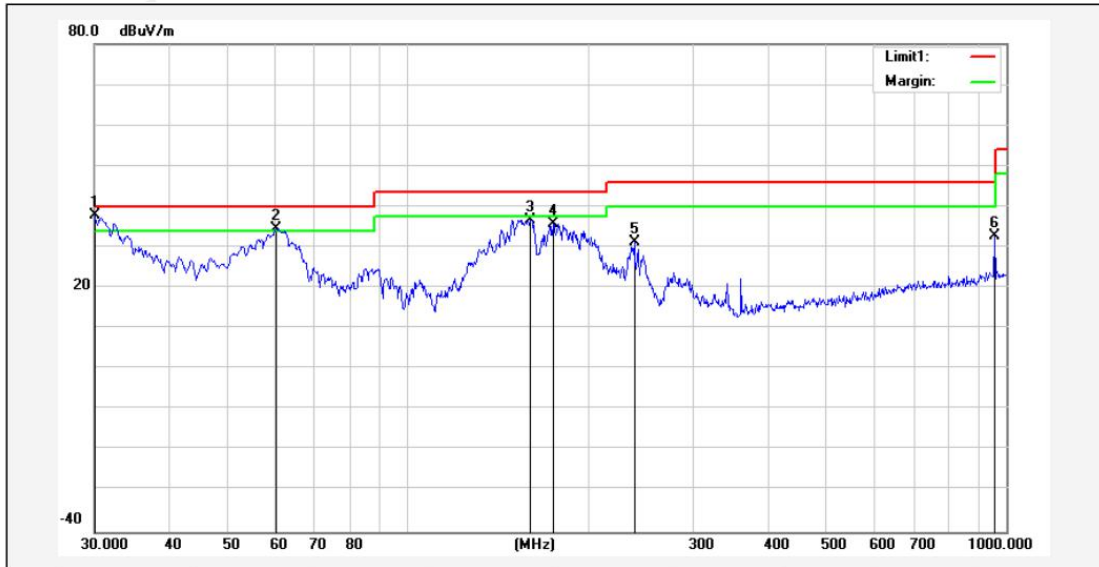

No.	Frequency (MHz)	Reading (dBuV)	Correction factor(dB/m)	Result (dBuV/m)	Limit (dBuV/m)	Margin (dB)	Degree (deg.)	Height (cm)	Remark
1*	30.0000	44.53	-6.65	37.88	40.00	-2.12			peak
2!	60.2801	55.47	-20.99	34.48	40.00	-5.52			peak
3	160.3457	51.24	-14.57	36.67	43.50	-6.83			peak
4	175.0368	51.63	-15.83	35.80	43.50	-7.70			peak
5	239.1473	46.65	-15.27	31.38	46.00	-14.62			peak
6	955.4381	35.24	-2.35	32.89	46.00	-13.11			peak

Remark: Absolute Level= Reading Level+ Factor, Margin= Absolute Level – Limit
 Factor=Ant. Factor + Cable Loss – Pre-amplifier

Remark:

- (1) Measuring frequencies from 9 KHz to the 1 GHz, Radiated emission test from 9KHz to 30MHz was verified, and no any emission was found except system noise floor.
- (2) * denotes emission frequency which appearing within the Restricted Bands specified in provision of 15.205, then the general radiated emission limits in 15.209 apply.
- (3) The IF bandwidth of EMI Test Receiver between 30MHz to 1GHz was 120KHz, 1 MHz for measuring above 1 GHz, below 30MHz was 10KHz.



Above 1 GHz Test Results:
CH Low (2402MHz)

Horizontal:

Frequency (MHz)	Reading Result (dB μ V)	Factor (dB)	Emission Level (dB μ V/m)	Limits (dB μ V/m)	Margin (dB)	Detector Type
2402	107.64	-5.84	101.8	114	-12.2	PK
2402	80.24	-5.84	74.4	94	-19.6	AV
4804	61.33	-3.64	57.69	74	-16.31	PK
4804	48.36	-3.64	44.72	54	-9.28	AV
7206	58.61	-0.95	57.66	74	-16.34	PK
7206	47.21	-0.95	46.26	54	-7.74	AV

Remark: Factor = Antenna Factor + Cable Loss – Pre-amplifier. Margin= Absolute Level – Limit

Vertical:

Frequency (MHz)	Reading Result (dB μ V)	Factor (dB)	Emission Level (dB μ V/m)	Limits (dB μ V/m)	Margin (dB)	Detector Type
2402	107.29	-5.84	101.45	114	-12.55	PK
2402	81.26	-5.84	75.42	94	-18.58	AV
4804	61.38	-3.64	57.74	74	-16.26	PK
4804	50.11	-3.64	46.47	54	-7.53	AV
7206	57.99	-0.95	57.04	74	-16.96	PK
7206	47.61	-0.95	46.66	54	-7.34	AV

Remark: Factor = Antenna Factor + Cable Loss – Pre-amplifier. Margin= Absolute Level – Limit



CH Middle (2440MHz)

Horizontal:

Frequency (MHz)	Reading Result (dB μ V)	Factor (dB)	Emission Level (dB μ V/m)	Limits (dB μ V/m)	Margin (dB)	Detector Type
2440	109.61	-5.71	103.9	114	-10.1	PK
2440	80.36	-5.71	74.65	94	-19.35	AV
4880	62.11	-3.51	58.6	74	-15.4	PK
4880	50.68	-3.51	47.17	54	-6.83	AV
7320	56.39	-0.82	55.57	74	-18.43	PK
7320	45.85	-0.82	45.03	54	-8.97	AV

Remark: Factor = Antenna Factor + Cable Loss – Pre-amplifier. Margin = Absolute Level – Limit

Vertical:

Frequency (MHz)	Reading Result (dB μ V)	Factor (dB)	Emission Level (dB μ V/m)	Limits (dB μ V/m)	Margin (dB)	Detector Type
2440	110.36	-5.71	104.65	114	-9.35	PK
2440	81.62	-5.71	75.91	94	-18.09	AV
4880	61.23	-3.51	57.72	74	-16.28	PK
4880	50.37	-3.51	46.86	54	-7.14	AV
7320	56.33	-0.82	55.51	74	-18.49	PK
7320	46.28	-0.82	45.46	54	-8.54	AV

Remark: Factor = Antenna Factor + Cable Loss – Pre-amplifier. Margin = Absolute Level – Limit



CH High (2480MHz)
Horizontal:

Frequency (MHz)	Reading Result (dB μ V)	Factor (dB)	Emission Level (dB μ V/m)	Limits (dB μ V/m)	Margin (dB)	Detector Type
2480	110.36	-5.65	104.71	114	-9.29	PK
2480	82.16	-5.65	76.51	94	-17.49	AV
4960	62.34	-3.43	58.91	74	-15.09	PK
4960	50.39	-3.43	46.96	54	-7.04	AV
7440	56.87	-0.75	56.12	74	-17.88	PK
7440	47.36	-0.75	46.61	54	-7.39	AV

Remark: Factor = Antenna Factor + Cable Loss – Pre-amplifier. Margin= Absolute Level – Limit

Vertical:

Frequency (MHz)	Reading Result (dB μ V)	Factor (dB)	Emission Level (dB μ V/m)	Limits (dB μ V/m)	Margin (dB)	Detector Type
2480	110.49	-5.65	104.84	114	-9.16	PK
2480	81.36	-5.65	75.71	94	-18.29	AV
4960	59.89	-3.43	56.46	74	-17.54	PK
4960	49.68	-3.43	46.25	54	-7.75	AV
7440	56.38	-0.75	55.63	74	-18.37	PK
7440	47.39	-0.75	46.64	54	-7.36	AV

Remark: Factor = Antenna Factor + Cable Loss – Pre-amplifier. Margin= Absolute Level – Limit

Remark:

- (1) Measuring frequencies from 1 GHz to the 25 GHz.
- (2) "F" denotes fundamental frequency; "H" denotes spurious frequency. "E" denotes band edge frequency.
- (3) * denotes emission frequency which appearing within the Restricted Bands specified in provision of 15.205, then the general radiated emission limits in 15.209 apply.
- (4) Data of measurement within this frequency range shown "---" in the table above means the reading of emissions are attenuated more than 20dB below the permissible limits or the field strength is too small to be measured.
- (5) The IF bandwidth of EMI Test Receiver between 30MHz to 1GHz was 120KHz, 1 MHz for measuring above 1 GHz, below 30MHz was 10KHz. The resolution bandwidth of test receiver/spectrum analyzer is 1MHz and video bandwidth is 3MHz for peak measurement with peak detector at frequency above 1GHz. The resolution bandwidth of test receiver/spectrum analyzer is 1MHz and video bandwidth is 10Hz for Average measurement with peak detection at frequency above 1GHz.
- (6) For fundamental frequency, $RBW > 20dB BW$, $VBW \geq 3 \times RBW$, PK detector is for PK value, RMS detector is for AV value.
- (7) All modes of operation were investigated and the worst-case emissions are reported.

5.1 Limits

FCC PART 15.249(d) Emissions radiated outside of the specified frequency bands, except for harmonics, shall be attenuated by at least 50 dB below the level of the fundamental or to the general radiated emission limits in §15.209, whichever is the lesser attenuation.

5.2 Test Procedure

The band edge compliance of RF radiated emission should be measured by following the guidance in ANSIC63.10 with respect to maximizing the emission by rotating the EUT, measuring the emission while the EUT is situated in three orthogonal planes (if appropriate), adjusting the measurement antenna height and polarization etc. Set RBW to 1MHz and VBM to 3MHz to measure the peak field strength and set RMS detector to measure the average radiated field strength.

5.3 Test Result

PASS

When the prototype is in test, the wireless module transmits at the same time.

Radiated Band Edge Test:

Operation Mode: TX CH Low (2402MHz)

Horizontal:

Frequency (MHz)	Reading Result (dBµV)	Factor (dB)	Emission Level (dBµV/m)	Limits (dBµV/m)	Margin (dB)	Detector Type
2310	55.63	-5.81	49.82	74	-24.18	PK
2310	/	-5.81	/	54	/	AV
2390	56.09	-5.84	50.25	74	-23.75	PK
2390	/	-5.84	/	54	/	AV
2400	57.39	-5.84	51.55	74	-22.45	PK
2400	/	-5.84	/	54	/	AV

Remark: Factor = Antenna Factor + Cable Loss – Pre-amplifier.

Vertical:

Frequency (MHz)	Reading Result (dBµV)	Factor (dB)	Emission Level (dBµV/m)	Limits (dBµV/m)	Margin (dB)	Detector Type
2310	55.36	-5.81	49.55	74	-24.45	PK
2310	/	-5.81	/	54	/	AV
2390	55.34	-5.84	49.5	74	-24.5	PK
2390	/	-5.84	/	54	/	AV
2400	56.82	-5.84	50.98	74	-23.02	PK
2400	/	-5.84	/	54	/	AV

Remark: Factor = Antenna Factor + Cable Loss – Pre-amplifier.



Operation Mode: TX CH High (2480MHz)

Horizontal:

Frequency (MHz)	Reading Result (dB μ V)	Factor (dB)	Emission Level (dB μ V/m)	Limits (dB μ V/m)	Margin (dB)	Detector Type
2483.5	57.69	-5.65	52.04	74	-22.42	PK
2483.5	/	-5.65	/	54	/	AV
2500	56.36	-5.72	50.64	74	-20.42	PK
2500	/	-5.72	/	54	/	AV

Remark: Factor = Antenna Factor + Cable Loss – Pre-amplifier.

Vertical:

Frequency (MHz)	Reading Result (dB μ V)	Factor (dB)	Emission Level (dB μ V/m)	Limits (dB μ V/m)	Margin (dB)	Detector Type
2483.5	56.87	-5.65	51.22	74	-22.78	PK
2483.5	/	-5.65	/	54	/	AV
2500	56.86	-5.72	51.14	74	-22.86	PK
2500	/	-5.72	/	54	/	AV

Remark: Factor = Antenna Factor + Cable Loss – Pre-amplifier.



6 OCCUPIED BANDWIDTH MEASUREMENT

6.1 Test Setup

Same as Radiated Emission Measurement

6.2 Test Procedure

1. The EUT was placed on a turn table which is 0.8m above ground plane.
2. Set EUT as normal operation.
3. Based on ANSI C63.10 section 6.9.2: RBW=30KHz. VBW=100KHz, Span=3MHz.
4. The useful radiated emission from the EUT was detected by the spectrum analyzer with peak detector.

6.3 Measurement Equipment Used

When the prototype is in test, the wireless module transmits at the same time.
Same as Radiated Emission Measurement

6.4 Test Result

PASS

Frequency (MHz)	20dB Bandwidth (MHz)	Result
2402	1.296	PASS
2440	1.338	PASS
2480	1.562	PASS

CH:2402MHz

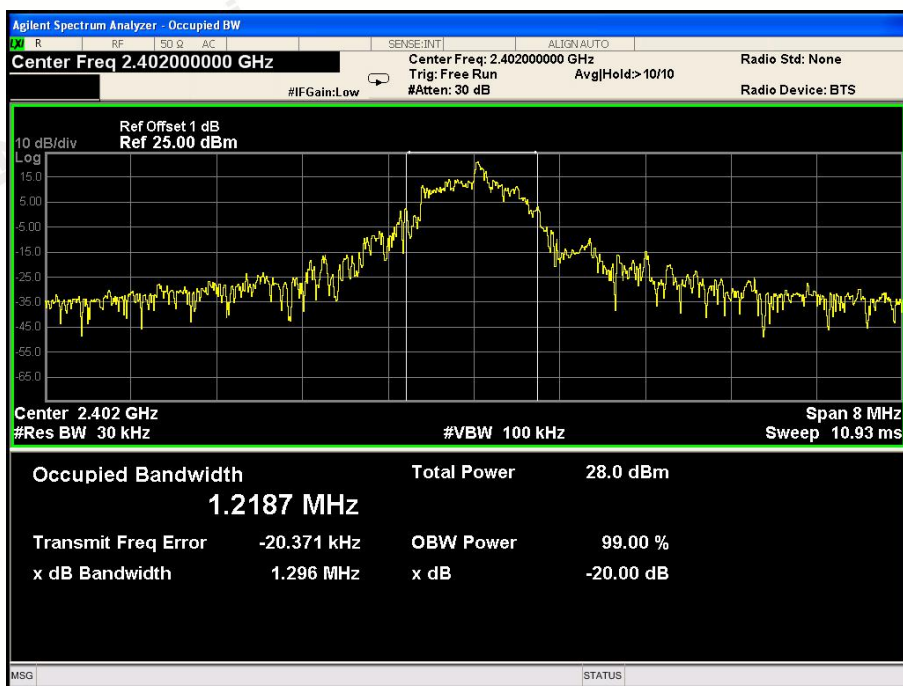



CH:2440MHz

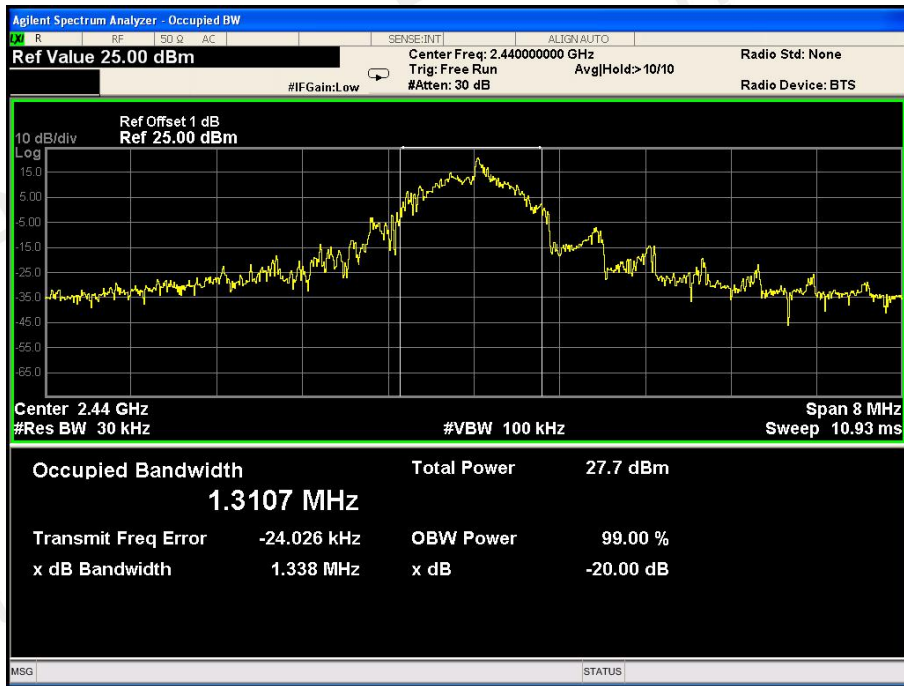

CH:2480MHz



7 ANTENNA REQUIREMENT

Standard Applicable:

For intentional device, according to FCC 47 CFR Section 15.203, an intentional radiator shall be designed to ensure that no antenna other than that furnished by the responsible party shall be used with the device.

Antenna Connected Construction

The antenna used in this product is a EXT Antenna, The directional gains of antenna used for transmitting is 1dBi.

ANTENNA1

ANTENNA2

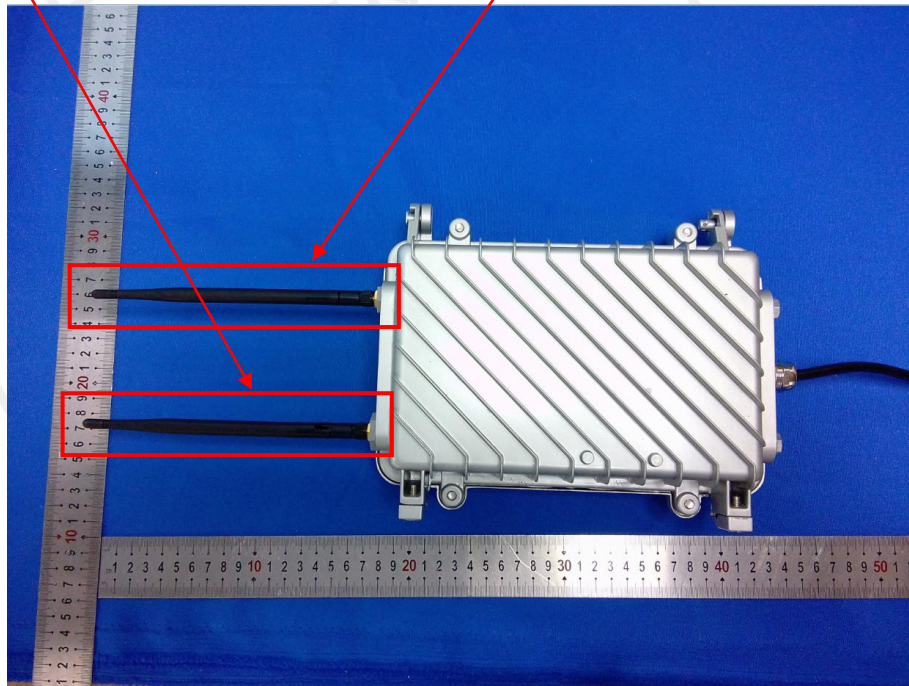

8 PHOTOGRAPH OF TEST

8.1 Radiated Emission



8.2 Conducted Emission



End of Report