



FCC RADIO TEST REPORT

Applicant : Sperry Corporation
Address : 8F-7, No. 369, Fuxing N. Rd., Songshan Dist.,
Taipei City 105, Taiwan (R.O.C.)
Equipment : DUOMON EGG
Model No. : DM-1299
Trade Name : MEGACOM
FCC ID : 2ASCN-DM1299

I HEREBY CERTIFY THAT :

The sample was received on Dec. 30, 2021 and the testing was completed on Feb. 05, 2022 at CerpPASS Technology Corp. The test result refers exclusively to the test presented test model / sample. Without written approval of CerpPASS Technology Corp., the test report shall not be reproduced except in full.

Approved by:

Mark Liao / Supervisor

Laboratory Accreditation:

CerpPASS Technology Corporation Test Laboratory





Contents

1. Summary of Test Procedure and Test Results.....	4
1.1 Applicable Standards	4
2. Test Configuration of Equipment under Test.....	5
2.1 Feature of Equipment under Test.....	5
2.2 Test Mode and Test Software	6
2.3 Description of Test System.....	7
2.4 General Information of Test.....	8
2.5 Measurement Uncertainty	9
3. Test Equipment and Ancillaries Used for Tests	10
4. Test of AC Power Line Conducted Emission	11
4.1 Test Limit	11
4.2 Test Procedures	11
4.3 Typical Test Setup	12
4.4 Test Result and Data	13
5. Test of Spurious Emission (Radiated)	14
5.1 Test Limit	14
5.2 Test Procedures	15
5.3 Typical Test Setup	15
5.4 Test Result and Data (9kHz ~ 30MHz).....	17
5.5 Test Result and Data (30MHz ~ 1GHz).....	17
5.6 Test Result and Data (1GHz ~ 25GHz).....	19
5.7 Restricted Bands of Operation	21
5.8 Test Photographs (30MHz ~ 1GHz).....	22
5.9 Test Photographs (1GHz ~ 25GHz).....	23



History of this test report

Report No.	Issued Date	Description
21120284-TRFCC02	Feb. 18, 2022	Original



1. Summary of Test Procedure and Test Results

1.1 Applicable Standards

ANSI C63.10:2013

Description of Test	Result
CO-LOCATION	PASS

*The lab has reduced the uncertainty risk factor from test equipment, environment and staff technicians which according to the standard on contract. Therefore, the test result will only be determined by standard requirement.

*This EUT has been also tested and compiled with the requirement of FCC Part 15, Subpart B, recorded in a separate test report(21120284-TEFV01).



2. Test Configuration of Equipment under Test

2.1 Feature of Equipment under Test

Operation Frequency Range	2400-2483.5MHz
Center Frequency Range	2402-2480MHz
Modulation Type	GFSK
Modulation Technology	DTS
Data Rate	GFSK: 1Mbps
Antenna Type	PCB Antenna
Antenna Gain	ANT A/B 2400-2483.5MHz:-6.72dBi

Note: For more details, please refer to the User's manual of the EUT.



2.2 Test Mode and Test Software

- a. During testing, the interface cables and equipment positions were varied according to ANSI C63.4.
- b. The complete test system included Notebook and EUT for RF test.
- c. An executive program, " SmartSnippets Toolbox ver. 5.0.16.3720" under Windows OS system was executed to transmit and receive data via Bluetooth
- d. The following test modes were performed for the test:

Radiation Emissions (30MHz ~ 1GHz)	
Test Mode	Operating Description
1	ANT A :BLE 1TX GFSK CH00+ ANT B :BLE 1TX GFSK CH00
caused "Test Mode 1" generated the worst case, it was reported as the final data.	
Radiation Emissions (1GHz ~ 25GHz)	
Test Mode	Operating Description
1	ANT A :BLE 1TX GFSK CH00+ ANT B :BLE 1TX GFSK CH00
caused "Test Mode 1" generated the worst case, it was reported as the final data.	



2.3 Description of Test System

Radiated Emissions				
Equipment	Brand	Model	Length/Type	Power cord/Length/Type
Notebook	ASUS	P2430U	N/A	Adapter / 1.8m / NS
Notebook	ASUS	P2430U	N/A	Adapter / 1.8m / NS
USB Cable	iMAX	A-B	1.5m / NS	N/A
USB Cable	BENEVO	BUSB3100AMF	1m / NS	N/A
DC Power Supply	Gwinstek	SPD-3606	N/A	N/A
testfixture*2	Waveshare	FT232	N/A	N/A



2.4 General Information of Test

Test Site	CerpPASS Technology Corporation Test Laboratory Address: No.10, Ln. 2, Lianfu St., Luzhu Dist., Taoyuan City 33848, Taiwan (R.O.C.) Tel:+886-3-3226-888 Fax:+886-3-3226-881	
	FCC	TW1439, TW1079
	IC	4934E-1, 4934E-2
	VCCI	T-2205 for Telecommunication test C-4663 for Conducted emission test R-4218 for Radiated emission test G-10812, G-10813 for radiated disturbance above 1GHz
Frequency Range Investigated:	Conducted: from 150kHz to 30 MHz Radiation: from 30 MHz to 25000MHz	
Test Distance:	The test distance of radiated emission from antenna to EUT is 3 M.	

Test Item	Test Site	Test Period	Environmental Conditions	Tested By
Radiated Emissions	3M02-NK	2022/02/05	19°C / 50%	Dian Chen



2.5 Measurement Uncertainty

ISO/IEC 17025 requires that an estimate of the measurement uncertainties associated with the emissions test results be included in the report. The measurement uncertainties given below are based on a 95% confidence level (based on a coverage factor (k=2))

Measurement Item	Uncertainty
AC Power Line Conduction(150K~30MHz)	±3.12dB
Radiated Spurious Emission(9KHz~30MHz)	±3.4dB
Radiated Spurious Emission(30MHz~1GHz)	±5.6dB
Radiated Spurious Emission(1GHz~25GHz)	±6.6dB
Conducted Spurious Emission	±1.8dB



3. Test Equipment and Ancillaries Used for Tests

Test Item	Radiated Emissions				
Test Site	Semi Anechoic Room(3M02-NK)				
Instrument	Manufacturer	Model No	Serial No	Calibration Date	Valid Date
Bilog Antenna	Schwarzbeck	VULB9168	275	2021/11/05	2022/11/04
Active Loop Antenna	EMCO	6507	40855	2021/06/10	2022/06/09
Horn Antenna	EMCO	3115	31601	2021/10/14	2022/10/13
Horn Antenna	EMCO	3116	31970	2021/03/29	2022/03/28
EMI Receiver	ROHDE & SCHWARZ	ESCI	101423	2021/06/30	2022/06/29
Spectrum Analyzer	ROHDE & SCHWARZ	FSV 40-N	102151	2021/08/06	2022/08/05
Preamplifier	EM Electronics corp.	EM330	60658	2021/10/13	2022/10/12
Preamplifier	Agilent	8449B	3008A01954	2021/03/22	2022/03/21
Preamplifier	EMC INSTRUMENTS	EMC184045	980065	2021/11/16	2022/11/15
Bluetooth Tester	ROHDE & SCHWARZ	CBT	101133	2021/04/19	2022/04/18
Cable-3in1(30M-1G)	HARBOUR INDUSTRIES	LL142	CCE1315	2021/04/12	2022/04/11
Cable-0.5m(1G-18G)	EMEC	EM104-SMSM-0.5M	CCE1354	2021/05/06	2022/05/05
Cable-3m(1G-18G)	EMEC	EM104-SMSM-3M	CCE1355	2021/05/06	2022/05/05
Cable-8m(1G-18G)	EMEC	EM104-SMSM-8M	CCE1356	2021/05/06	2022/05/05
Cable-0.5m(30M-40G)	HUBER SUHNER	SUCOFLEX 102	28420/2	2021/04/03	2022/04/02
Cable-3m(30M-40G)	HUBER SUHNER	SUCOFLEX 102	MY2608/2	2021/04/09	2022/04/08
Cable-0.5m(1G-40G)	Rapidtek	40GHZ 50CM	38MS-38MS50 314	2021/04/08	2022/04/07
Cable-6m(9k~300M)	NA	EMC5D-BM-BM-6	130605	2021/09/22	2022/09/21
E3	AUDIX	v8.2014-8-6	RK-000529	NA	NA



4. Test of AC Power Line Conducted Emission

4.1 Test Limit

Conducted Emissions were measured from 150 kHz to 30 MHz with a bandwidth of 9 KHz, according to the methods defined in ANSI C63.10-2013. The EUT was placed on a nonmetallic stand in a shielded room 0.8 meters above the ground plane. The interface cables and equipment positioning were varied within limits of reasonable applications to determine the position produced maximum conducted emissions.

Frequency (MHz)	Quasi Peak (dB μ V)	Average (dB μ V)
0.15 – 0.5	66-56*	56-46*
0.5 – 5.0	56	46
5.0 – 30.0	60	50

*Decreases with the logarithm of the frequency.

4.2 Test Procedures

- a. The EUT was placed 0.4 meter from the conducting wall of the shielding room was kept at least 80 centimeters from any other grounded conducting surface.
- b. Connect EUT to the power mains through a line impedance stabilization network (LISN).
- c. All the support units are connecting to the other LISN.
- d. The LISN provides 50 ohm coupling impedance for the measuring instrument.
- e. The FCC states that a 50 ohm, 50 micro-Henry LISN should be used.
- f. Both sides of AC line were checked for maximum conducted interference.
- g. The frequency range from 150 kHz to 30 MHz was searched.
- h. Set the test-receiver system to Peak Detect Function and Specified Bandwidth with Maximum Hold Mode.



4.3 Typical Test Setup

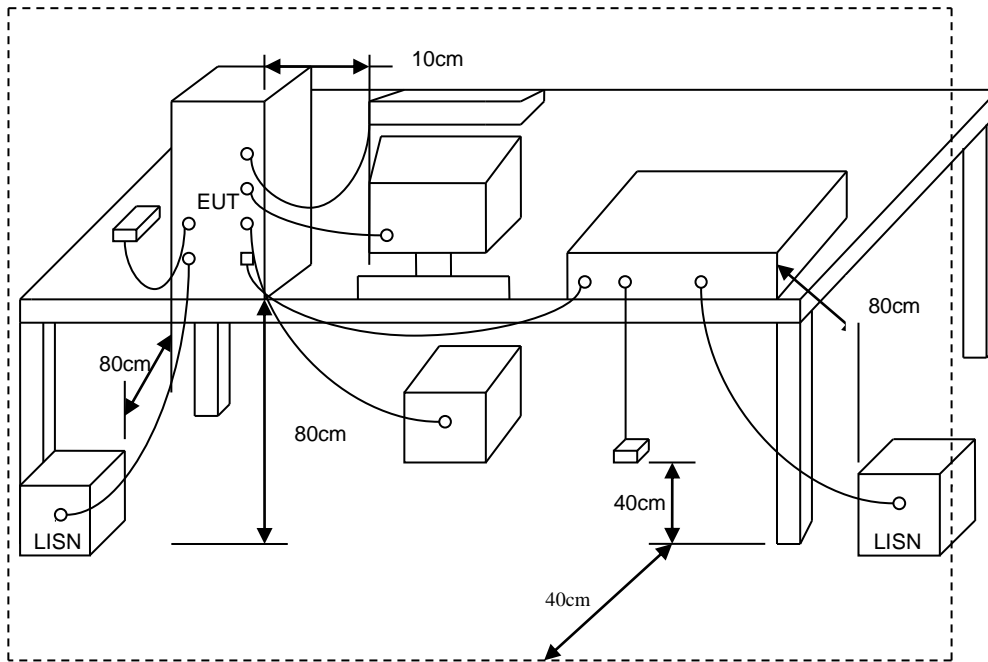



4.4 Test Result and Data

The power supply is DC source, so this item doesn't require testing.



5. Test of Spurious Emission (Radiated)

5.1 Test Limit

In any 100kHz bandwidth outside the frequency band in which the spread spectrum or digitally modulated intentional radiator is operating, the radio frequency power that is produced by the intentional radiator shall be at least 20dB below that in the 100kHz bandwidth within the band that contains the highest level of the desired power, based on either an RF conducted or a radiated measurement. If the transmitter measurement is based on the maximum conducted output power, the attenuation required under this paragraph shall be 30dB instead of 20dB. In addition, radiated emissions which fall in section 15.205(a) the restricted bands must also comply with the radiated emission limit specified in section 15.209(a).

Frequency (MHz)	Field Strength (microvolt/meter)	Measurement Distance (meters)
0.009 ~ 0.490	2400/F(kHz)	300
0.490 ~ 1.705	24000/F(kHz)	30
1.705 ~ 30.0	30	30
30 ~ 88	100	3
88 ~ 216	150	3
216 ~ 960	200	3
Above 960	500	3



5.2 Test Procedures

- a. The EUT was placed on a rotatable table top 0.8 meter above ground.
- b. The EUT was set 3 meters from the interference receiving antenna which was mounted on the top of a variable height antenna tower.
- c. The table was rotated 360 degrees to determine the position of the highest radiation.
- d. The antenna is a broadband antenna and its height is varied between one meter and four meters above ground to find the maximum value of the field strength both horizontal polarization and vertical polarization of the antenna are set to make the measurement.
- e. For each suspected emission the EUT was arranged to its worst case and then tune the antenna tower (from 1 M to 4 M) and turn table (from 0 degree to 360 degrees) to find the maximum reading.
- f. Set the test-receiver system to Peak or CISPR quasi-peak Detect Function and specified bandwidth with Maximum Hold Mode.
- g. If the emission level of the EUT in peak mode was 3 dB lower than the limit specified, then testing will be stopped and peak values of EUT will be reported, otherwise, the emissions which do not have 3 dB margin will be repeated one by one using the quasi-peak method and reported.
- h. For testing above 1GHz, the emission level of the EUT in peak mode was 20dB lower than average limit (that means the emission level in peak mode also complies with the limit in average mode), then testing will be stopped and peak values of EUT will be reported, otherwise, the emissions will be measured in average mode again and reported.
- i. "Cone of radiation" has been considered to be 3dB bandwidth of the measurement antenna.

Note: The supporting fixture shall permit orientation of the EUT in each of three orthogonal axis positions such that emissions from the EUT are maximized.
(Z-AXIS is the worst.)

5.3 Typical Test Setup

Below 30MHz test setup

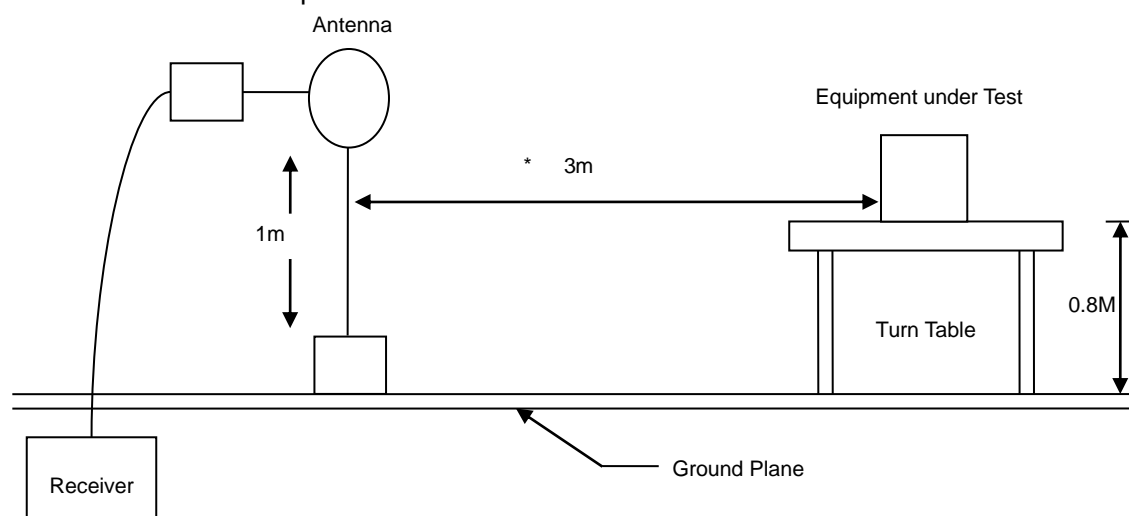



30MHz- 1GHz Test Setup

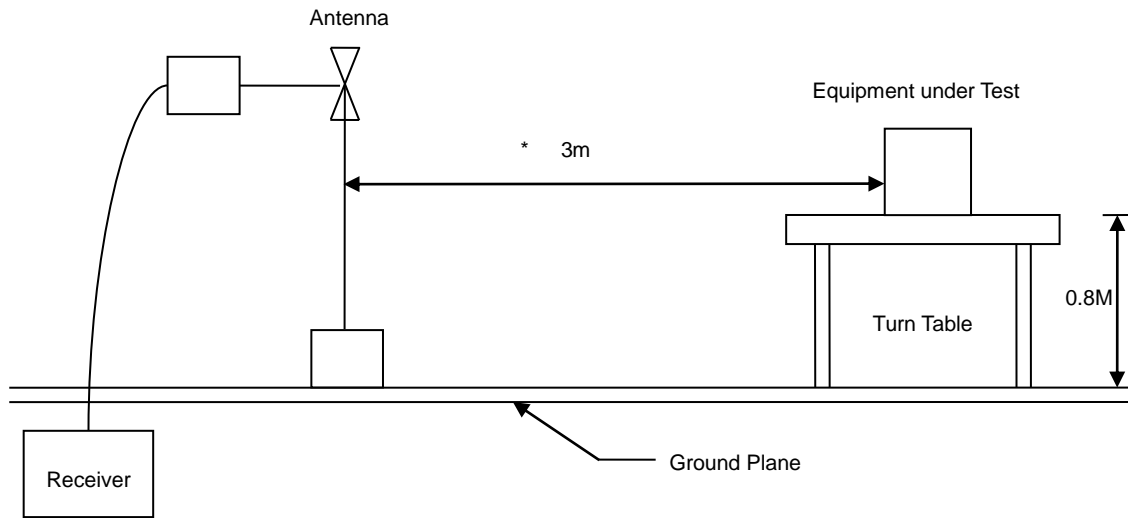

Above 1GHz Test Setup

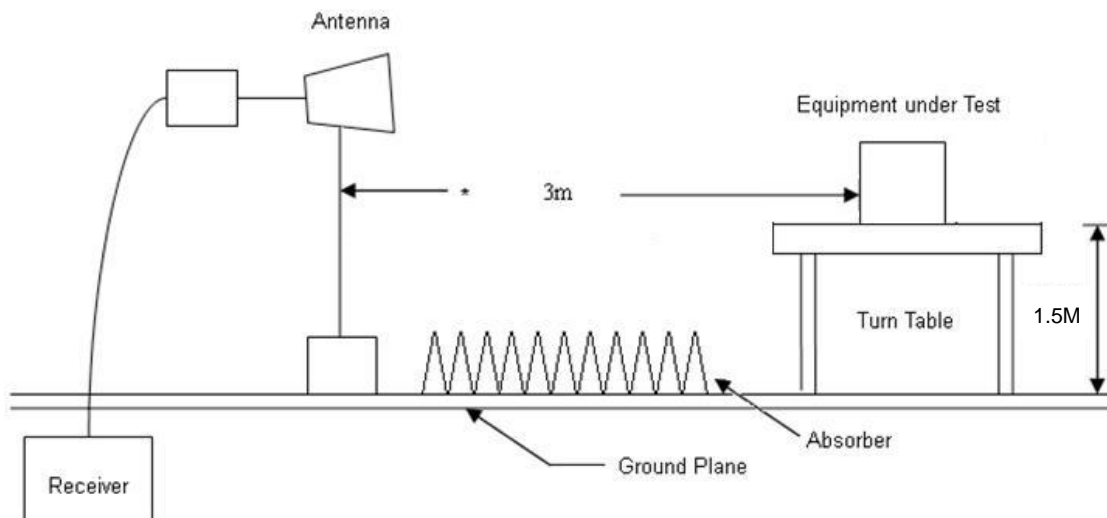



5.4 Test Result and Data (9kHz ~ 30MHz)

The 9kHz - 30MHz spurious emission is under limit 20dB more.

5.5 Test Result and Data (30MHz ~ 1GHz)

Power	:	DC 3V From DC Source (120V/60Hz)	Pol/Phase	:	VERTICAL
Test Mode	:	Mode 1		:	

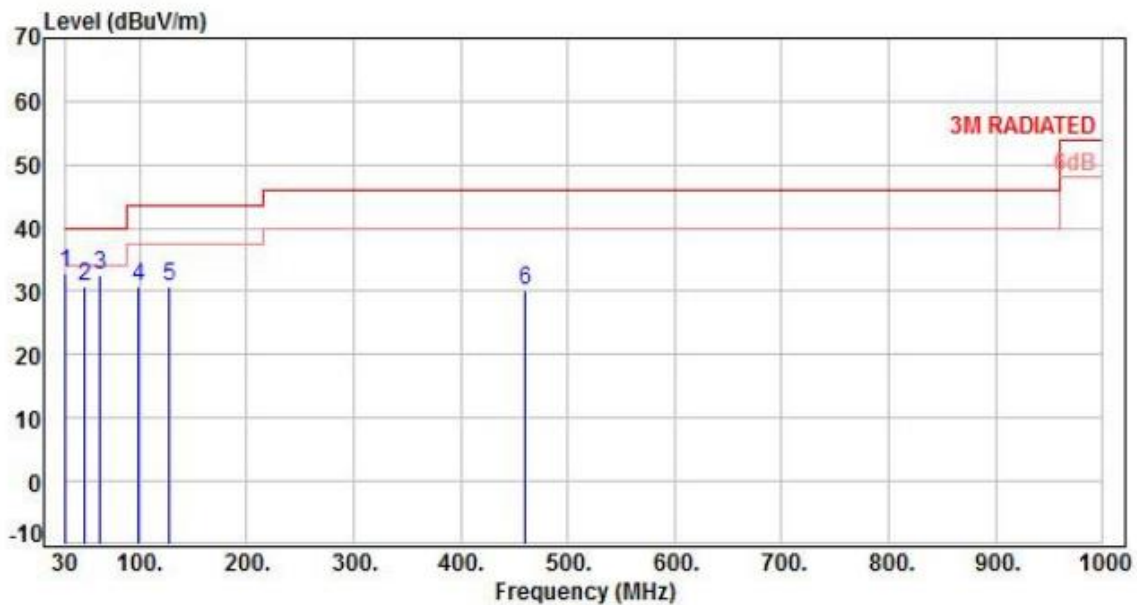

No.	Frequency (MHz)	Factor (dB)	Reading (dBuV)	Level (dBuV/m)	Limit (dBuV/m)	Margin (dB)	Detector	Height (cm)	Azimuth (deg)	P/F
1	30.97	-12.61	45.38	32.77	40.00	-7.23	Peak	200	360	P
2	48.43	-10.81	41.45	30.64	40.00	-9.36	Peak	200	360	P
3	62.98	-12.22	44.94	32.72	40.00	-7.28	Peak	200	360	P
4	98.87	-15.83	46.45	30.62	43.50	-12.88	Peak	200	360	P
5	127.97	-13.07	43.74	30.67	43.50	-12.83	Peak	200	360	P
6	460.68	-6.15	36.30	30.15	46.00	-15.85	Peak	200	360	P

Note: Level=Reading+Factor
Margin=Level-Limit
Factor=Antenna Factor + cable loss - Amplifier Factor



Power	: DC 3V From DC Source (120V/60Hz)	Pol/Phase	: HORIZONTAL
Test Mode	: Mode 1		:

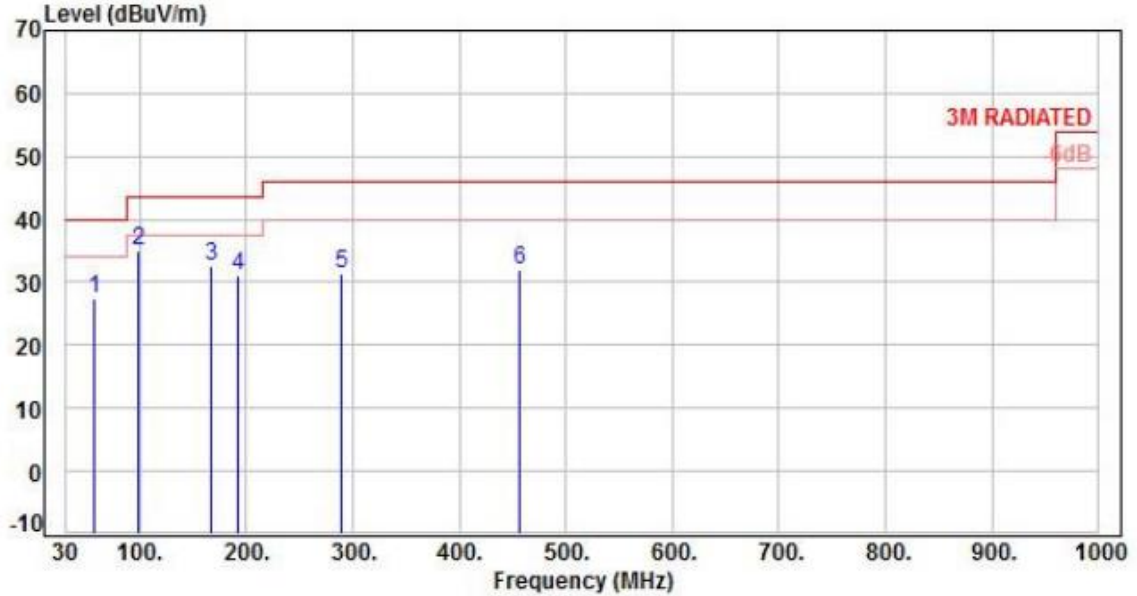

No.	Frequency (MHz)	Factor (dB)	Reading (dBuV)	Level (dBuV/m)	Limit (dBuV/m)	Margin (dB)	Detector	Height (cm)	Azimuth (deg)	P/F
1	58.13	-11.53	38.90	27.37	40.00	-12.63	Peak	200	360	P
2	97.90	-15.92	50.81	34.89	43.50	-8.61	Peak	200	360	P
3	166.77	-11.75	44.23	32.48	43.50	-11.02	Peak	200	360	P
4	191.99	-13.21	44.36	31.15	43.50	-12.35	Peak	200	360	P
5	288.99	-10.48	41.72	31.24	46.00	-14.76	Peak	200	360	P
6	456.80	-6.16	38.15	31.99	46.00	-14.01	Peak	200	360	P

Note: Level=Reading+Factor
Margin=Level-Limit
Factor=Antenna Factor + cable loss - Amplifier Factor



5.6 Test Result and Data (1GHz ~ 25GHz)

Power	: DC 3V From DC Source (120V/60Hz)	Pol/Phase	: VERTICAL
Test Mode	: Mode 1		:

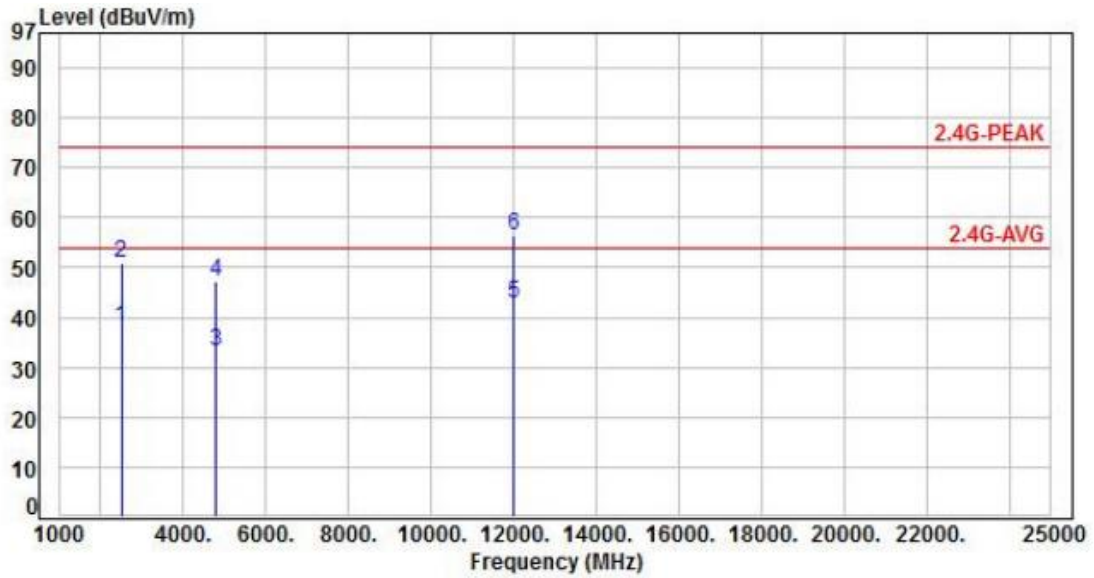

No.	Frequency (MHz)	Factor (dB)	Reading (dBuV)	Level (dBuV/m)	Limit (dBuV/m)	Margin (dB)	Detector	Height (cm)	Azimuth (deg)	P/F
1	2500.00	-3.21	41.03	37.82	54.00	-16.18	Average	100	244	P
2	2500.00	-3.21	54.17	50.96	74.00	-23.04	Peak	100	244	P
3	4804.00	3.76	29.58	33.34	54.00	-20.66	Average	100	165	P
4	4804.00	3.76	43.26	47.02	74.00	-26.98	Peak	100	165	P
5	12010.00	13.57	29.22	42.79	54.00	-11.21	Average	100	224	P
6	12010.00	13.57	42.83	56.40	74.00	-17.60	Peak	100	224	P

Note: Level=Reading+Factor
Margin=Level-Limit
Factor=Antenna Factor + cable loss - Amplifier Factor



Power	: DC 3V From DC Source (120V/60Hz)	Pol/Phase	: HORIZONTAL
Test Mode	: Mode 1		:

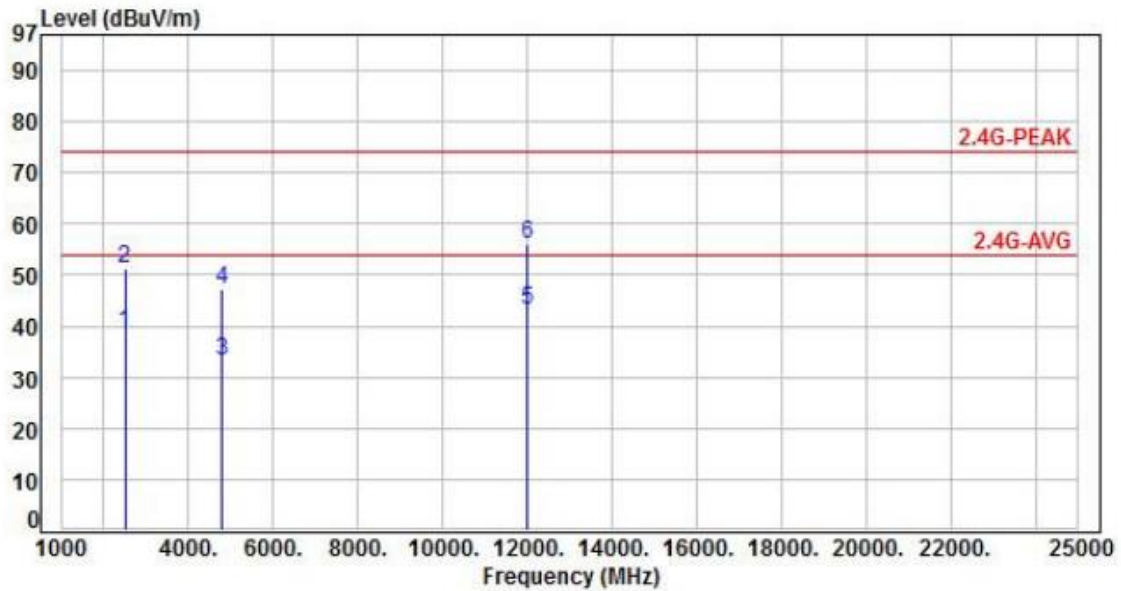

No.	Frequency (MHz)	Factor (dB)	Reading (dBuV)	Level (dBuV/m)	Limit (dBuV/m)	Margin (dB)	Detector	Height (cm)	Azimuth (deg)	P/F
1	2500.00	-3.21	41.94	38.73	54.00	-15.27	Average	100	211	P
2	2500.00	-3.21	54.55	51.34	74.00	-22.66	Peak	100	211	P
3	4804.00	3.76	29.49	33.25	54.00	-20.75	Average	100	239	P
4	4804.00	3.76	43.41	47.17	74.00	-26.83	Peak	100	239	P
5	12010.00	13.57	29.48	43.05	54.00	-10.95	Average	100	177	P
6	12010.00	13.57	42.34	55.91	74.00	-18.09	Peak	100	177	P

Note: Level=Reading+Factor
 Margin=Level-Limit
 Factor=Antenna Factor + cable loss - Amplifier Factor



5.7 Restricted Bands of Operation

Only spurious emissions are permitted in any of the frequency bands listed below:

MHz	MHz	MHz	GHz
0.09000 – 0.11000	16.42000 – 16.42300	399.9 – 410.0	4.500 – 5.250
0.49500 – 0.505**	16.69475 – 16.69525	608.0 – 614.0	5.350 – 5.460
2.17350 – 2.19050	16.80425 – 16.80475	960.0 – 1240.0	7.250 – 7.750
4.12500 – 4.12800	25.50000 – 25.67000	1300.0 – 1427.0	8.025 – 8.500
4.17725 – 4.17775	37.50000 – 38.25000	1435.0 – 1626.5	9.000 – 9.200
4.20725 – 4.20775	73.00000 – 74.60000	1645.5 – 1646.5	9.300 – 9.500
6.21500 – 6.21800	74.80000 – 75.20000	1660.0 – 1710.0	10.600 – 12.700
6.26775 – 6.26825	108.00000 – 121.94000	1718.8 – 1722.2	13.250 – 13.400
6.31175 – 6.31225	123.00000 – 138.00000	2200.0 – 2300.0	14.470 – 14.500
8.29100 – 8.29400	149.90000 – 150.05000	2310.0 – 2390.0	15.350 – 16.200
8.36200 – 8.36600	156.52475 – 156.52525	2483.5 – 2500.0	17.700 – 21.400
8.37625 – 8.38675	156.70000 – 156.90000	2655.0 – 2900.0	22.010 – 23.120
8.41425 – 8.41475	162.01250 – 167.17000	3260.0 – 3267.0	23.600 – 24.000
12.29000 – 12.29300	167.72000 – 173.20000	3332.0 – 3339.0	31.200 – 31.800
12.51975 – 12.52025	240.00000 – 285.00000	3345.8 – 3358.0	36.430 – 36.500
12.57675 – 12.57725	322.00000 – 335.40000	3600.0 – 4400.0	Above 38.6
13.36000 – 13.41000			

** : Until February 1, 1999, this restricted band shall be 0.490-0.510 MHz