

MC3100

Mynita

3D SL-Track Massage Chair

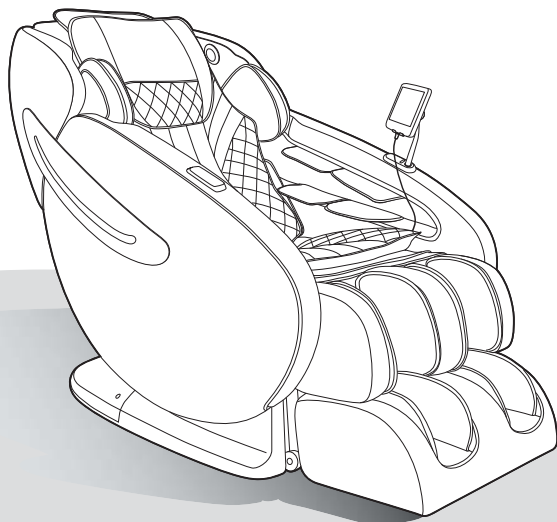

OPERATION MANUAL
AND WARRANTY BOOKLET

CONTENTS

1. LIMITED WARRANTY GUIDELINES	3
• ONE YEAR LABOR WARRANTY & THREE YEARS PARTS WARRANTY	3
• NON-WARRANTY SUPPORT	3
• SERVICE AND TECHNICAL SUPPORT	3
• WARRANTY FAQs	4
2. IMPORTANT SAFETY INSTRUCTIONS	5
• DANGER	5
• FORBIDDEN	6
• WARNING	7
• CAUTION	9
3. INSTALLATION GUIDE	10
• FOOT MASSAGER INSTALLATION	10
• TABLET CONTROL PANEL INSTALLATION	12
4. AT A GLANCE	13
• EXTERNAL STRUCTURE	13
• INTERNAL STRUCTURE	14
• POWER BOX	15
• CAUTION	15
5. PREPARATION BEFORE USING	16
• ENVIRONMENT CHECKING	16
• MOVE THE CHAIR	16
• CAUTION	18
• MESSAGE CHAIR COMMISSIONING	19
• FLOOR PROTECTION	20

6. OPERATIONS	21
• CONTROLLER MENU	21
• QUICK ACCESS CONTROL PANEL	22
• TABLET CONTROLLER INSTRUCTIONS	23
• BLUETOOTH INSTRUCTIONS	36
• AI VOICE ORDERS	36
• GROUNDING INSTRUCTIONS	39
• ON/OFF INSTRUCTIONS	40
7. CARE AND MAINTENANCE	45
• STORAGE	45
• MAINTENANCE	45
8. TROUBLESHOOTING GUIDE	47
9. PRODUCT SPECIFICATIONS	50
10. FCC STATEMENT	51

1 LIMITED WARRANTY GUIDELINES

Mynta sells Extended SL Track Massage Chair Model MC3100 with the intention that they are free of defects in manufacture and workmanship for a period of one year from the date of original purchase, except as noted below. Mynta warrants that the MC3100 will be free of defects in material and workmanship under normal use and service. This warranty extends only to consumers and does not extend to retailers and resellers.

ONE YEAR LABOR WARRANTY & THREE YEARS PARTS WARRANTY

MC3100 has a one-year labor warranty and a three-year parts warranty. Mynta customer service will not issue Return Material Authorizations (RMAs) for non-defective products. Extended SL Track Massage Chair Model MC3100 will be either repaired by the consumer or by an in-home technician. Mynta will not issue Return Material Authorizations (RMAs) for buyer's remorse.

For warranty repairs, please contact Mynta customer service at Support@MyntaChair.com.

NON-WARRANTY SUPPORT

Non-warranty repair is provided on a *per incident* basis. Mynta customer service will verify if the unit has failed and provide instructions for repairing a unit. All applicable repairs, parts, shipping, handling, local tax and a *per incident* fee will be charged for labor and non-warranty repairs.

SERVICE AND TECHNICAL SUPPORT

Mynta customer service representative will attend to most

consumer inquiries, but in some cases a technical service specialist will provide advanced support over the phone.

Get help at Support@MyntaChair.com.

WARRANTY FAQs

1. What isn't covered by the warranty?

- Purchases made through unauthorized resellers
- Improperly operated devices
- Lost or stolen products
- Purchases made over limited warranty time (unless otherwise stated)
- Non quality-related issues
- Free products
- Damage due to misuse, improper treatment and unauthorized modification and repair are not covered by this warranty
- Warranty does not cover accessories and attachments which don't belong to the massage unit

2. When does the warranty begin?

Warranty begins from the day you place your order.

3. How do I claim the warranty?

Send an email to Support@MyntaChair.com with your unit Serial Number and Proof of Purchase (original receipt) for all repairs or services.

Note:

If you made your purchase through an authorized Mynta Reseller, contact the Reseller to obtain warranty.

If the product was a gift, you may ask the giver to provide you with a copy of the receipt or claim the warranty on your behalf.

2 IMPORTANT SAFETY INSTRUCTIONS

The following Safety Instructions are of great help to your correct use of this massage chair.

- **READ ALL THE INSTRUCTIONS** and cautionary markings in this manual. Follow the instructions and keep the owner's manual for future reference.
- **NOT FOR CHILDREN.** This device can only be used by individuals over 16 years old and people with reduced physical, sensory or mental capabilities or lack of experience and knowledge if they have been given supervision or instruction concerning use of the appliance in a safe way and understand the hazards involved. Don't allow the device to be used as a toy. Close attention is necessary when used by or near children. Children should be supervised to ensure that they don't play with any devices or cords.
- **USE ONLY AS INSTRUCTED.** Use this device only as described in this manual. Any misuse excludes any liability for damage, incorrect use may cause electric shocks, fires, burns, or other unexpected hazards. To clearly indicate the degrees of danger and damage, the classes of accidents caused by incorrect use are classified into DANGER, FORBIDDEN, WARNING and CAUTION. Instructions marked as followings should be strictly followed.

DANGER

To reduce the risk of electric shock,

- A massage chair should never be left unattended when plugged in. Always switch off the power and remove the plug from the mains socket immediately after use and before cleaning.
- To avoid fire disaster or damage to the massage chair,

please don't use the power supply that is beyond the specified electric voltage.

- Close supervision is necessary when this massage chair is used by, on, or near children, invalids, or disabled people. Keep children and pets away from reclining backrest and legrest.

FORBIDDEN

- Don't allow children and pets to play near the chair especially during operation.
- Don't leave mobility impaired or speech impaired people alone in the chair.
- Don't place or stock this machine near damp places such as swimming pools or bathrooms.
- Don't use it in an environment which is dusty, greasy or lacking oxygen.
- Don't place it near a steam oven, open fire, or heat.
- Don't place it directly in the sun.
- Don't use outdoors.
- Don't press by force on the massage rollers.
- Don't stand on or in the chair, never store heavy items on the chair. Use only while seated.
- Don't sit on the backrest, legrest, or armrest to avoid accidental injury or machine damage.
- Don't use an electric blanket while using the massage chair.
- Don't operate with more than one user.
- Don't massage when your body is wet, moist or with bare skin, wear suitable clothing.
- Don't use it while smoking.
- Don't use it immediately after meals or after drinking alcohol.
- Don't use head ornamentation.
- Don't stumble over electrical wires or connections.

⚠ WARNING

To reduce the risk of burns, fire, electric shock, or injury to the users,

- Don't operate any equipment with damaged parts.
- Don't use attachments not recommended by the manufacturer. Any other use not recommended by the manufacturer may cause electrical shock or injury.
- Before using, please uncover the back cushion to check whether backrest or fabric is damaged, if damaged, please stop using this massage chair immediately, and contact Mynta Customer Support Team.
- Never operate this massage chair if it has a damaged cord or plug, if it is not working properly, if it has been dropped or damaged, contact Mynta Customer Support Team.
- Operate the massage chair on flat ground only.
- Connect this appliance to a properly grounded outlet only. See Grounding Instructions.
- To disconnect, turn all controls to the off position, then remove the plug from the outlet.
- Keep the cord away from heated surfaces.
- Keep the cord out of heavy traffic areas.
- Don't carry this massage chair by the supply cord or use the cord as a handle.
- Don't unplug the power plug or operate the controller with damp hands, and don't put heavy objects on the tablet —controller.
- When removing the power plug, please hold the insulation plug, don't pull the power cord.
- Don't put your hands or head under the chair.
- Only users less than 260 lbs are acceptable.
- Empty pockets and remove all your arm jewelry and watch before using.

- Don't operate under a blanket or pillow. Excessive heating can occur and cause fire, electric shock or injury.
- Don't operate the massage chair with the air openings blocked. Keep the air openings free of lint, hair, and the like.
- Don't drop or insert any object into any openings.
- Don't operate where aerosol (spray) products are being used.
- Don't remove the back cushion and play with the roller mechanism.
- Don't remove the bottom seat and play with actuators.
- Don't touch or re-wire the wires connected to the master-box.
- Don't attempt to repair or adjust any electrical or mechanical functions on this unit. Doing so will void the warranty.
- When using the massage chair, ascertain that the legrest is in the lowest position.
- When adjusting the legrest or backrest, please don't exert excessive force on it; in addition, keep children and pets well clear.
- Don't use other therapeutic equipment together with this massage chair.
- Don't use over insentive skin areas or in the presence of poor circulation. The unattended use of heat by children or incapacitated persons may be dangerous.
- The massage chair is equipped with a heating function, so people who are insentive to heat must use it carefully to avoid causing serious burns.
- Don't continuously use the massage chair over 30 minutes, and it is limited to massage a particular part of the body in 5 minutes.
- Don't sleep on the massage chair when the massage chair is working.

- During use, if you feel uncomfortable, please stop using immediately and consult your doctor.

⚠ CAUTION

- The massage chair is designed as a non-clinical device, to soothe tired and aching muscles. It is not intended to be a substitute for medical attention.
- Each massage - even a hand massage - must be refrained from during pregnancy or if one or more of the following complaints are present in the massage area:
 - Blood stasis
 - Tumor site
 - Heart disease, with a pacemaker or defibrillator
 - Sensitive areas: head, face, cervical vertebrae, spine vertebral body
 - Positions close to the bone with less muscle coverage, the humerus, the back of the foot, the back of the hand.
- Not recommended for the following people,
 - Patients with serious hyperostosis
 - Swollen lump and patient thrombosis
 - Patients with serious heart conditions
 - Pregnant women
 - People that consume large amount of alcohol
 - People with diabetes
 - People suffering from high fever
 - Patients with malignant tumors or malignant abscesses
 - People with distorted joints
 - People with serious skin conditions
 - People with spinal injuries
 - Minors under 16 years or people unable to control his/her behavior, i.e. mental patients, people with paralysis, etc. should not be allowed to operate the massage chair.

- It is recommended to consult a doctor before having a massage for the treatment of ailments and illnesses.
- If you are dependent on electrical aids e.g. pacemakers, **MUST** consult your doctor for medical advice before taking a massage.
- If your ailments and symptoms persist or worsen after use, contact your doctor immediately.
- Don't use the chair after taking painkillers, sedatives or alcohol. Consult your doctor if you are taking medications.

3 INSTALLATION GUIDE

FOOT MASSAGER INSTALLATION

Tool needed - A screwdriver or A magnetic screwdriver

1. Unscrew four screws with a screwdriver or a magnetic screwdriver, keep all the parts.

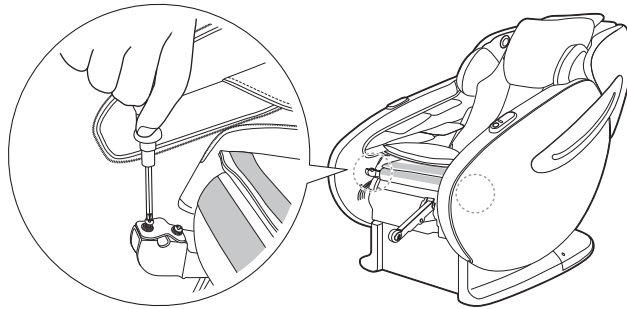

2. Plug two air pipe connectors into the same color air pipes with force. Plug two cables into the same color sockets.

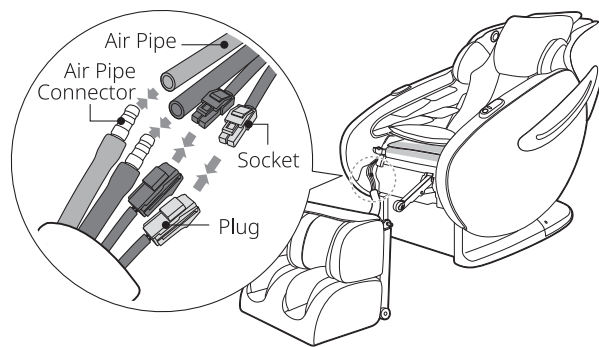

3. Lift up the foot massager, fit the metal pieces into the grooves on the surface.

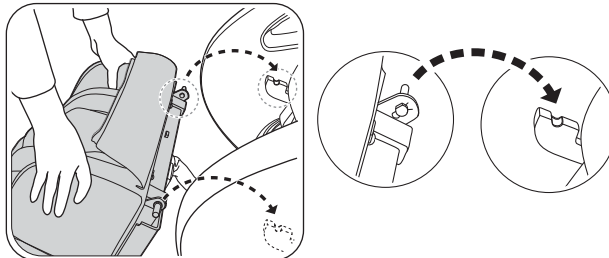

4. Apply the metal gaskets, tighten four screws. Done.

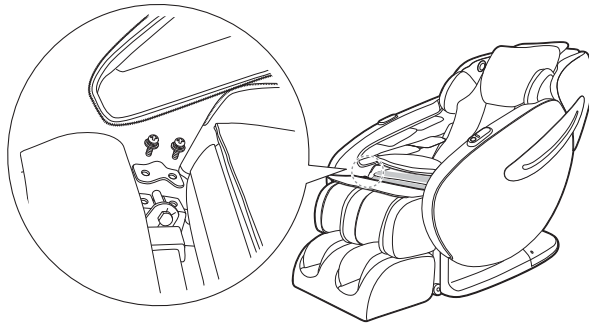

TABLET CONTROL PANEL INSTALLATION

Plug in the tablet stand, rotate to have it locked.

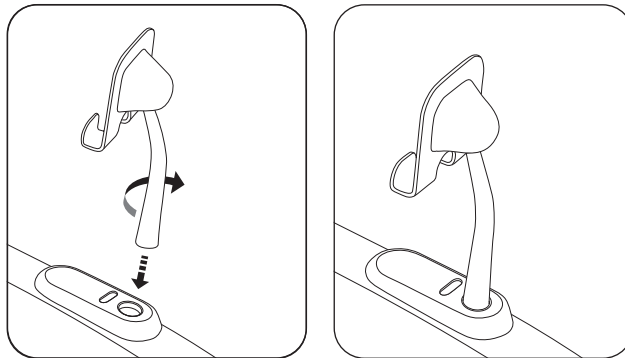

4 AT A GLANCE

EXTERNAL STRUCTURE

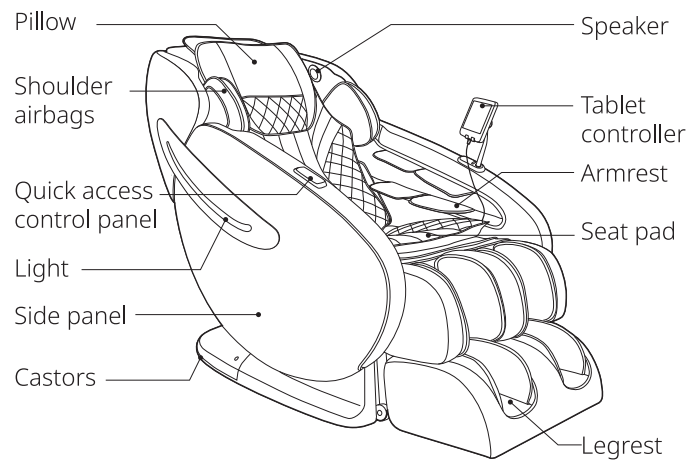

INTERNAL STRUCTURE

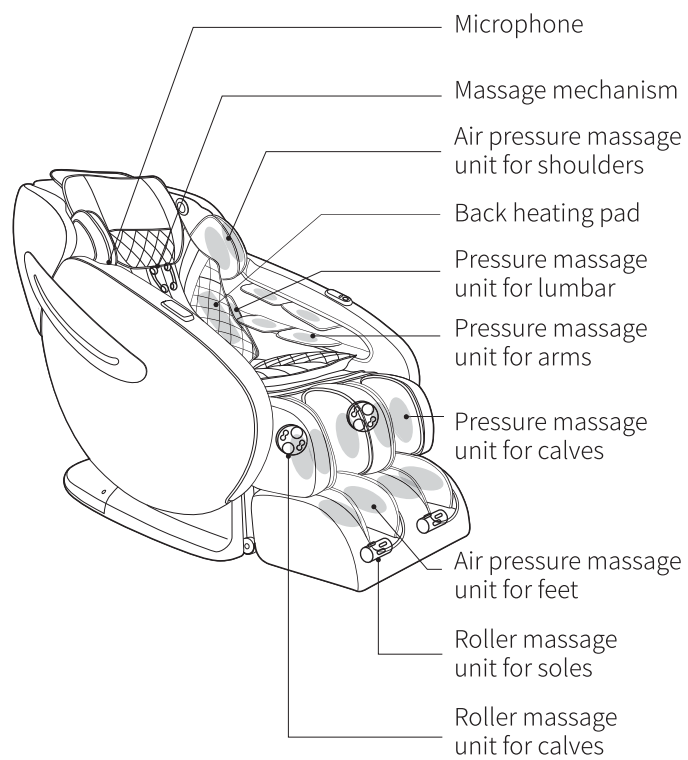

POWER BOX

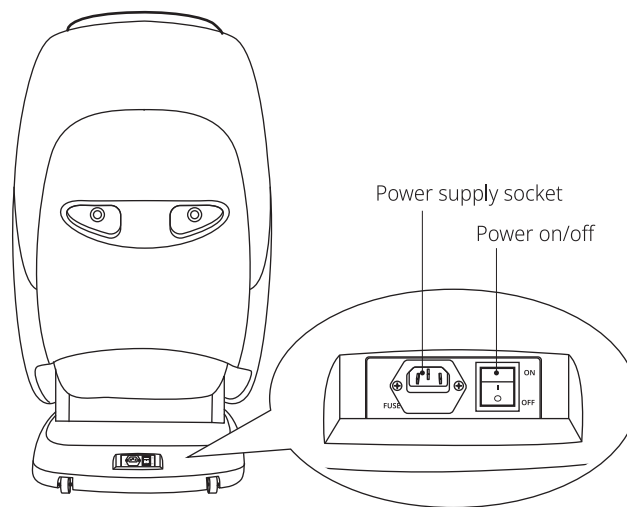

Don't allow children to play on the chair in case accident happens.



CAUTION

Always power off the chair and unplug the chair from the power supply socket after use and when the chair is not in use, so children won't get the chair started accidentally.

5 PREPARATION BEFORE USING

ENVIRONMENT CHECKING



Don't use the chair in wet places like near a swimming pool, bath room to avoid leakage or electric shock.



Don't use the chair under sunlight or near a stove or other heating device to avoid fire or damage to leather material.



Please use chair in flat place to avoid chair falling or noise or other unexpected trouble.

Must be sure there are no children, pets or any other objects under or close to the product while using.

MOVE THE CHAIR

There are moving rollers at the bottom of the chair.

Press down the backrest as below, recline the chair to approximately 45°, hold the moving holder in the back and front to move the chair around the house with a slight pull or push.

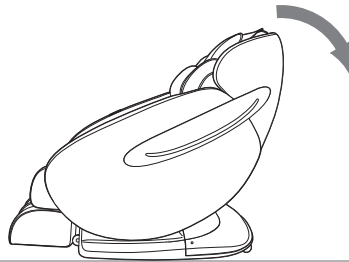

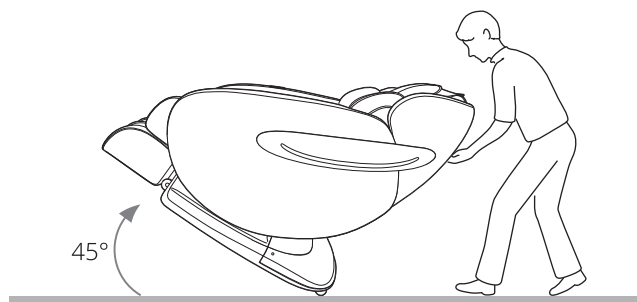

Always hold the side panels, not the base to lift up the chair.

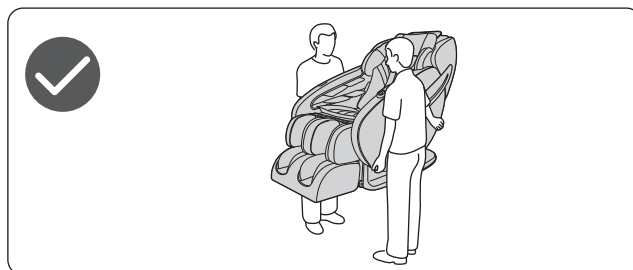
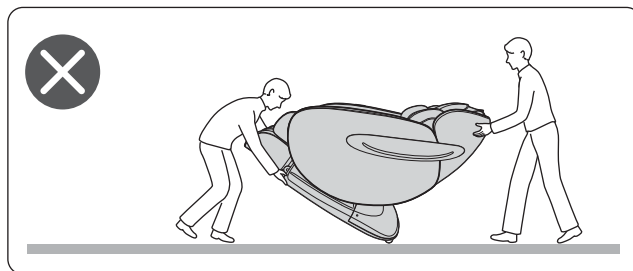



CAUTION

- Don't move the chair when there are people in it.
- Don't pull the armrest or any airbags to move the chair.
- Don't put fingers or any other objects into the gap between the seat and legrest.
- When adjusting up and down angles of the backrest and legrest, make sure there are no obstacles around the massage chair.
- During use, please make sure the power cord is not enlarged or clamped but laid orderly.
- Before sitting in the chair, make sure the chair is in its original position. If any part is not in its initial position, please power on/off again to make the whole chair go back to its original position.
- If the legrest rises up, please don't try to sit in the chair.
- Don't make the legrest suffer from heavy loading suddenly, or it may damage the legrest mechanism.

MASSAGE CHAIR COMMISSIONING

Before commissioning, please make sure there is enough space around the chair.

Back: minimum 6 inches from the wall or any other blocks

Front: allow 20 inches from any blocks for the legrest to extend.

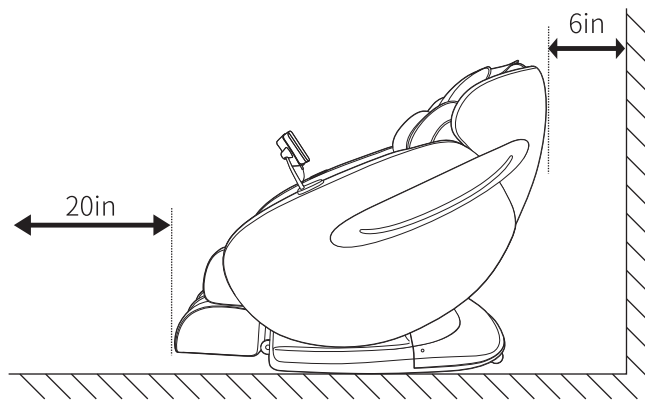

FLOOR PROTECTION

Put carpet or other pad under the massage chair, to avoid any unpredictable impression on the floor.

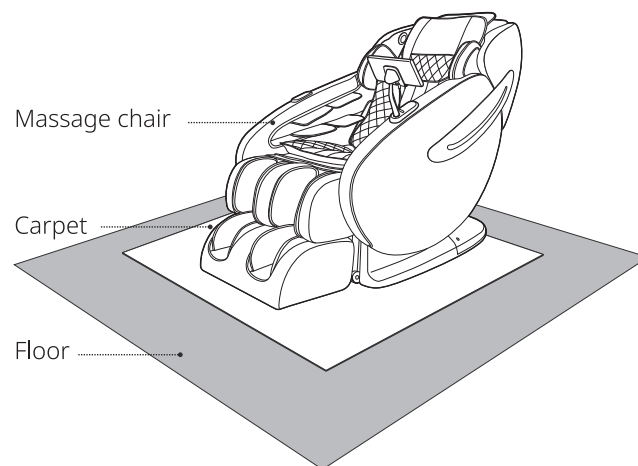

6 OPERATIONS

CONTROLLER MENU

Always press the Power Button to start massage.

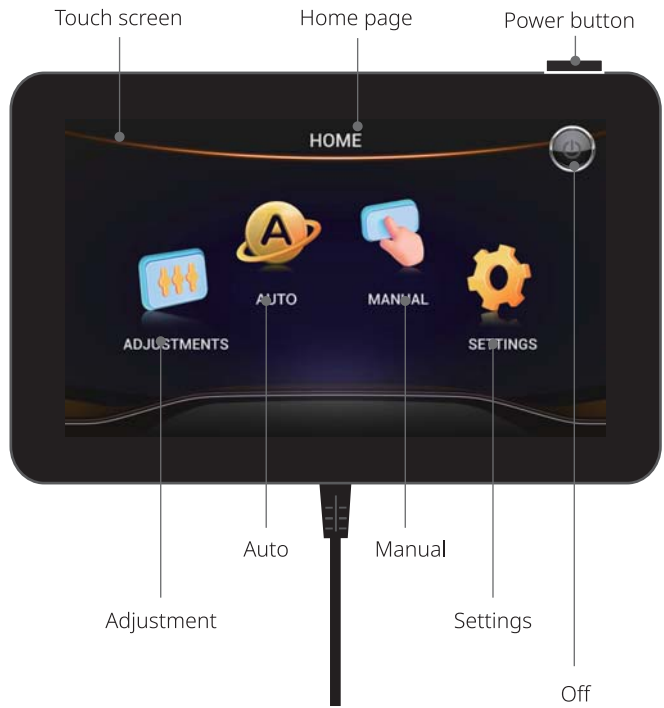



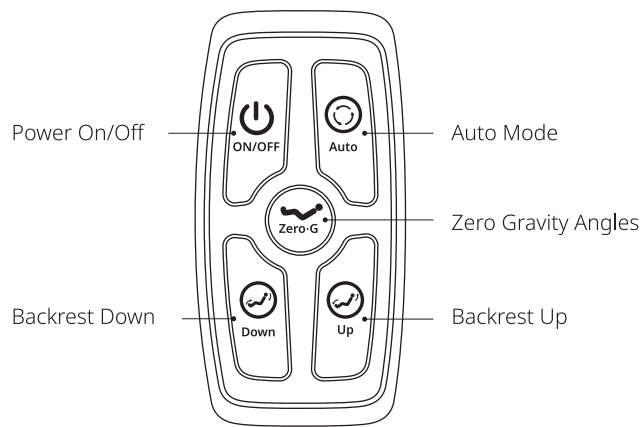



QUICK ACCESS CONTROL PANEL





On/Off	Long press to turn the chair ON/OFF.
Auto Mode	Short press to choose an Auto Mode. Every time this button is pressed, the auto massage mode will change in the sequence of Work Relief > Recovery > Deep Tissue > Rest&Sleep > Thai > Gentle > Athletic > Vertebral > For Her > For Him > Neck & Shoulders > Waist&Hip
Zero-G	Short press to choose a Zero Gravity angle.
Backrest Up/ BackrestDown	Long press to adjust backrest.

TABLET CONTROLLER INSTRUCTIONS

1. BASIC KEYS



KEYS	DESCRIPTION	GUIDELINES
	Off	Touch to stop massage and shut off the screen.
	Home	Touch to return to the home page.
	PAUSE	Touch once to halt current massage and countdown timer.
	RESTART	Touch to resume previous massage functions, as well as countdown timer.
	BACK	Touch to return to the previous page.
	ADJUSTMENTS	Touch to ADJUSTMENTS page.
	Air Massager	Touch to AIR MASSAGER page.

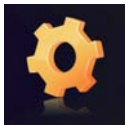

2. HOME PAGE MENU

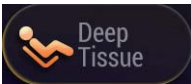

KEYS	DESCRIPTION	GUIDELINES
 AUTO	Auto	Touch to choose from 12 AUTO massage programs. Work Relief, Recovery, Deep Tissue, Rest&Sleep, Thai, Gentle, Athletic, Vertebral, For Her, For Him, Neck & Shoulders, Waist&Hip.
 MANUAL	Manual	Touch to go to the MANUAL massage programs page, choose your preferred massage functions at desired intensities, fully customize your massage.
 ADJUSTMENTS	Adjustments	Touch to go to the ADJUSTMENTS page for zero gravity and massage intensities.
 SETTINGS	Settings	Touch to go to the system SETTINGS page for timer and other preferences.

3. AUTO MASSAGE PROGRAMS

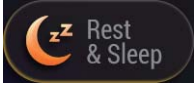
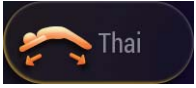

KEYS		GUIDELINES
	Work Relief	This is an exclusive massage program for the workplace walks, according to the features of long time desk work and business trip, it can ease muscles and recuperate body.
	Recovery	A full body deep massage includes Shiatsu, Knocking and Tapping to ease and relax muscles after surgeries.
	Deep Massage	A full body deep massage includes Shiatsu, Knocking and Tapping to ease and relax muscles after intense exercise, especially promote the body circulation system to improve the muscle recovery after exercise.

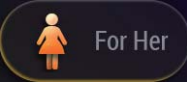
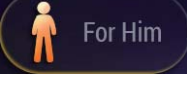
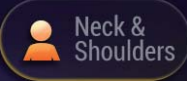

	<p>Rest & Sleep</p>	<p>A program designed to provide a mild massage that is great for deep relaxation. This is the caring program to help improve the quality of lunch break and sleep. The mild massage kneads body parts from heavy strength to light one, from light to no strength to help soothe tired body gradually. Product features front and rear swing function that takes you into the fantasy space swinging state and a thorough relaxation, best used before going to sleep.</p>
	<p>Thai Stretch</p>	<p>This massage will stretch your calf muscles and hamstrings with a combination of gentle tapping, kneading, rolling, and air compression. This massage is inspired from Thai Massage, the strong kneading and stretch of the body can effectively stretch legs, it's the best choice to relax tired muscles and increase physical vigor.</p>
	<p>Gentle</p>	<p>A full body gentle massage includes Kneading and Heating, designed for daily use.</p>

	<p>For Athletics</p>	<p>An auto programme generated by the system, focus on the tension points collected from athletics, especially promote the body circulation system to improve the muscle recovery after exercise.</p>
	<p>Full Back Massage</p>	<p>A full body massage, mainly focus on your full back with a deep massage that includes air compression to relieve the symptoms of lumbar spine pain.</p>
	<p>For Her</p>	<p>A full body gentle massage includes Kneading and Heating, specially designed for female.</p>
	<p>For Him</p>	<p>A full body strong massage includes Kneading, specially designed for the male.</p>
	<p>Neck & Shoulders</p>	<p>A full body massage, mainly focus on your neck and shoulders with a slow massage that incorporates soothing heat to relieve neck and back pain symptom. The curve design of the chair backrest makes the massage rollers completely fit the shoulders and the neck, which can effectively relieve fatigue and stiffness.</p>

	<p>Lower Back, Waist and Hips</p>	<p>A full body massage, mainly focus on your lower back, waist and hips with a deep massage that includes air compression to relieve full body pain.</p>
---	-----------------------------------	--

Backrest Scanning Instructions

A body scan is performed every time the power is on and the user selects an Auto Mode, it is designed to ensure an accurate and personalized massage for every individual. After the power is on, sit on the chair slowly with your back clings to the chair back, your head clings to the pillow so the massage sensors can detect your Shoulder Height and the whole back position.

The Tablet Control gives beep sounds when completing a body scan. When micro-adjustment is needed, just touch Roller up/down   , then  to start massage. Make sure the body scan is finished correctly for the best massage.

Once body scan is completed, it will skip to massage status page without further actions.



Note:

Heating, foot rollers and calf rollers can be turned on/off manually during any auto mode, see below.









4. MANUAL MASSAGE PROGRAMS

6*2 massage functions on demand.

Kneading, Shiatsu, Swedish, Knocking, Tapping, Rolling.

- Touch to choose a manual massage function for a full back massage at medium strength.
- Manual setting modes could not be combined with other modes.
- The default setting is spot-specific massage with medium width.
- Speed and width are adjustable by touching relative keys.



KEYS	DESCRIPTION	GUIDELINES
 	Roller Spot/ Partial Massage	<p>Touch Spot to activate localized Spot Massage while the original massage mode continues to run at the latest position.</p> <p>Touch Partial to activate Partial Massage, rollers take the latest massage spot position as the center, and will travel approximately 3 inches up or down. Only effective under manual massage mode.</p>
	Full Back Roller	Full Back Massage.
	Roller Width	Every touch will change the massage width interval in the sequence of WIDE>MEDIUM>NARROW. Only effective under manual massage mode.
 	Roller Up or Down	Up or down adjustment.

5. ADJUSTMENTS

Legrest Angle Adjustment

Backrest Angle Adjustment





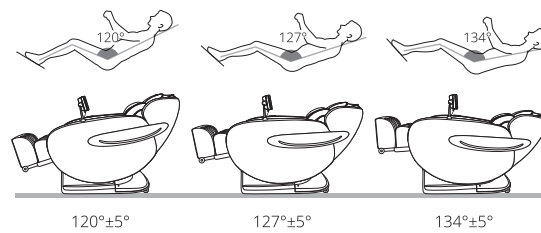

Zero-gravity is based on the NASA space capsule relaxation theory. Using the back, seat, and the leg rest, the chair puts the heart and knee at the same level, reducing the blood circulation pressure. Not only that, but all the gravitational forces can be dispersed to the massage chair, reducing heart and spine pressure.

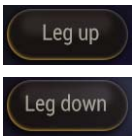
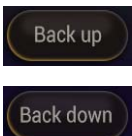
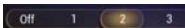

Zero Gravity Angle Adjustment

KEYS	DESCRIPTION	GUIDELINES
	Angle Adjustment Key for Legrest	<p>Leg Up Long-press this button, the legrest will be moved up to the top position, release this button, legrest stops moving.</p> <p>Leg Down Long-press this button, the legrest will move down to the lowest position, release this button, legrest stops moving.</p>
	Angle Adjustment Button for Backrest	<p>Back Up Long-press this button, the backrest will be moved up to the original position, release this button, backrest stops moving.</p> <p>Back down Long-press this button, the backrest will be moved down to the lowest position, release this button, backrest stops moving.</p>
	Zero Gravity Function Control	Touch this button to activate the zero gravity position, and choose from Zero Gravity mode1, Zero Gravity mode 2 and Zero Gravity mode 3.

Other Adjustments

KEYS	DESCRIPTION	GUIDELINES
	Roller Intensity	SLOW / MEDIUM / FAST Only effective under manual massage mode. 
	Kneading Speed	5 levels kneading speed adjustments.
	Tapping Speed	5 levels tapping speed adjustments.
	Air Intensity	5 levels tapping air intensity adjustments.

6. SETTINGS

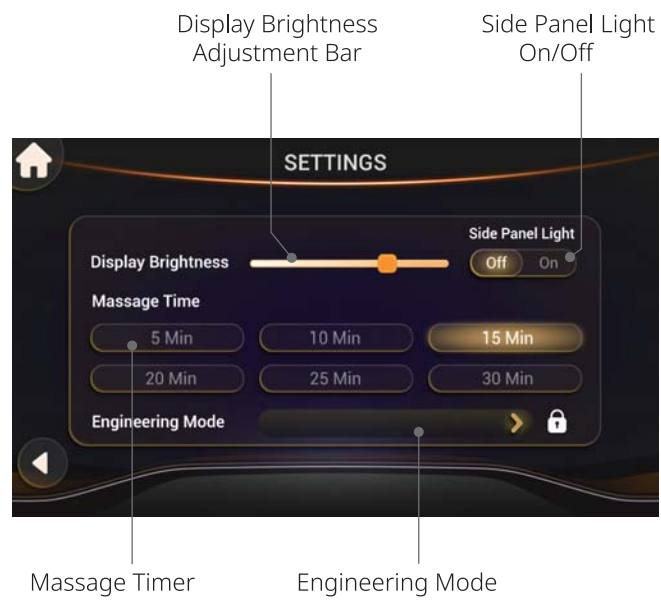

Note:
Engineering Mode is for Mynta home service team use only.

BLUETOOTH INSTRUCTIONS

Play Mobile Music/Bluetooth speaker:

Turn on Bluetooth of mobile, then select Bluetooth device of massage chair (MC3100). Once paired, it can act as speaker when mobile phone is playing music. (Remarks: No Password)

AI VOICE ORDERS

Items	Function	Order	Response
1	ON/OFF	Hello, Massage	I am here
2		Power on	Massage starts
3		Shut down	Massage ends
4	Pause	Pause massage	Massage paused
5		Resume massage	Massage resumed
6		Continue massage	
7	Heat	Heating on	Heating on
8		Heating off	Heating off
9	Timer	5 Minutes	Massage will stop in 5 minutes
10		10 Minutes	Massage will stop in 10 minutes
11		15 Minutes	Massage will stop in 15 minutes

12	Timer	20 Minutes	Massage will stop in 20 minutes
13		25 Minutes	Massage will stop in 25 minutes
14		30 Minutes	Massage will stop in 30 minutes
15	Zero Gravity	Zero gravity 1	Zero gravity 1
16		Zero gravity 2	Zero gravity 2
17		Zero gravity 3	Zero gravity 3
18		Zero gravity	Zero Gravity mode 2
19		Back up	Back up
20		Back down	Back down
21		Back stop	Back stop
22		Leg up	Leg up
23		Leg down	Leg down
24		Leg stop	Leg stop
25	Foot Roller	Foot rolling	Foot rolling is on
26		Calf rolling	
27		Stop rolling	Foot rolling stop
28	Work Relief	Work relief mode	Work relief mode is on
29	Deep tissue	Deep tissue mode	Deep tissue mode is on
30	Thai	Thai mode	Thai stretch mode is on
31		Stretch mode	

Items	Function	Order	Response
32	Athletic	Athletic mode	Athletic mode is on
33	Vertebral	Vertebral mode	Vertebral mode is on
34	Neck and Shoulder	Neck and Shoulder mode	Neck and Shoulder mode is on
35	Recovery	Recovery mode	Recovery mode is on
36	Rest and sleep	Rest and sleep mode	Rest and sleep mode is on
37	Gental	Gental mode	Gental mode is on
38	For Her	For Her mode	For her mode is on
39		Beauty mode	
40	For Him	For Him mode	For him mode is on
41	Waist and Hip	Waist and Hip mode	Waist and hip mode is on
42	Manual	Manual mode	Manual mode is on
43		More roller strength	Strength increased
44		Less roller strength	Strength decreased
45		More air intensity	Air intensity increased
46		Less air intensity	Air intensity decreased

GROUNDING INSTRUCTIONS

This product must be grounded. If it should malfunction or breakdown, grounding provides a path of least resistance for electric current to reduce the risk of electric shock. This product is equipped with a cord having an equipment-grounding conductor and a grounding plug. The plug must be plugged into an appropriate outlet that is properly installed and grounded in accordance with all local codes and ordinances.

DANGER - Improper connection of the equipment-grounding conductor can result in a risk of electric shock. Check with a qualified electrician or serviceman if you are in doubt as to whether the product is properly grounded.

Don't modify the plug provided with the product - if it does not fit the outlet; have a proper outlet installed by a qualified electrician.

This product is for use on a nominal 120-volt circuit and has a grounding plug that looks like the plug illustrated in sketch A in the following figure. Make sure that the product is

connected to an outlet having the same configuration as the plug. No adapter should be used with this product.

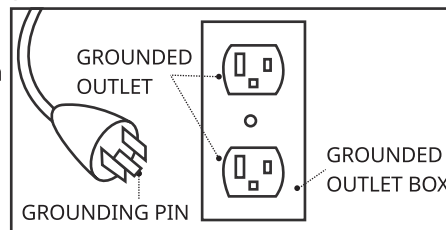

Earthing

This massage chair belongs to Level One electrical appliance, make sure to use three-core power supply socket and to guarantee the ground wire connected to the power supply socket has obtained good ground connection to avoid electric leakage, electric shock and some other negative effects during use.

ON/OFF INSTRUCTIONS

- Make sure that the chair is in its original position before using.
- Before sitting down, make sure there is nothing pinched between the armrest, rest, backrest and the seat of the chair.
- Make sure there are no children, pets or anything else within the range of the backrest to avoid unexpected injury or property loss.
- When adjusting the backrest, be careful of the gap between the backrest and armrest.
- Empty pockets and remove all your arm jewelry and watch before using this chair.
- When the footrest is moving, please do not stand up or leave from the seat, don't stop the legrest from moving to avoid damage to the chair.

ON

- Plug the cord into the power supply socket.

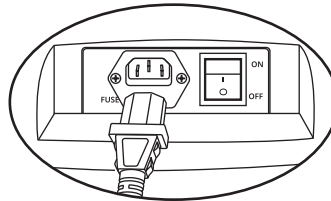

- Plug the other end of the cord into a wall outlet.

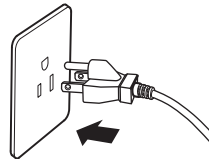

- Press the power button, you will see red light.

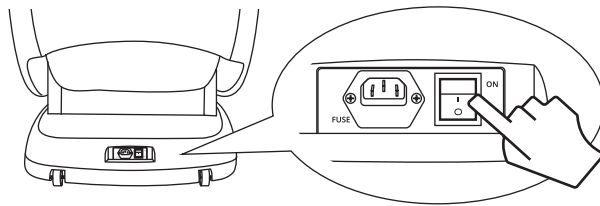

- Start massage according to controller instructions.

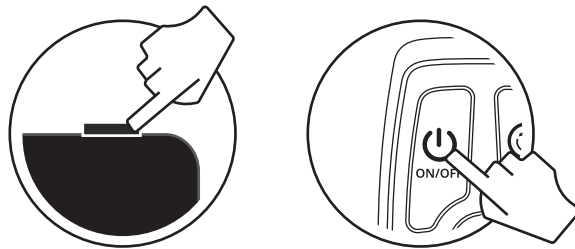



Note:

Before switching on the chair, please make sure there is no damage on the power cord and other exposed wires. Make sure the power switch is off before the chair is connected to electricity.

OFF

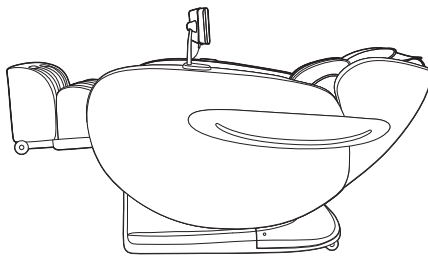
- Double check to make sure there are no people, pets or anything within the range of backrest and footrest.



- Press  on the controller to stop massage, wait until the backrest and legrest restore to the original position.

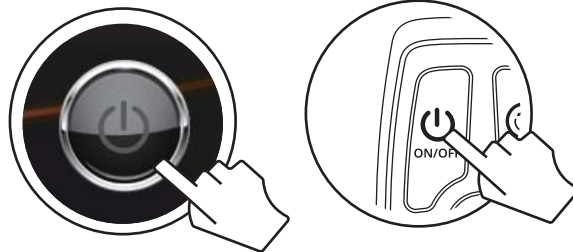

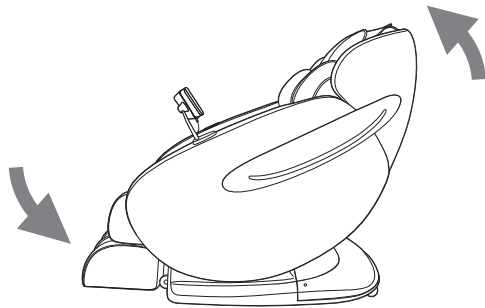

• Wait until the chair returns to the upright position.

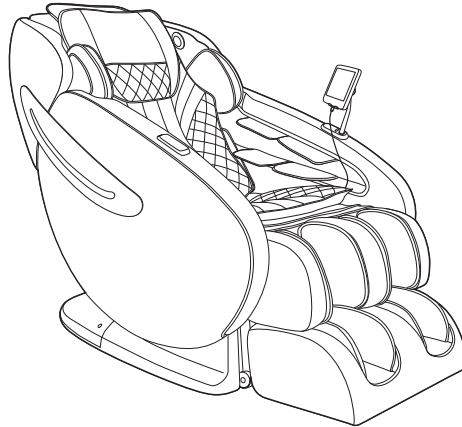

- Switch off the power.

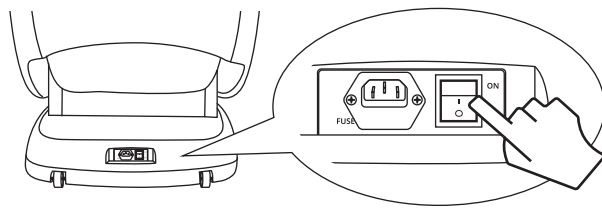

- Unplug the electricity from the socket to avoid any unexpected hurt to children or pets.

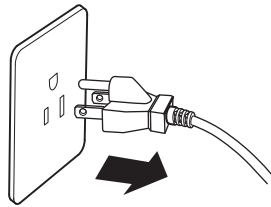

- Clean the chair if necessary.

7 CARE AND MAINTENANCE

STORAGE

- Please power off the chair and unplug the chair from the power supply socket when the chair is not in use, to avoid children to start the chair accidentally.
- Please disconnect the controller, store the chair carefully if it is not in use for a long time.
- Do not dismount the hock of the chain.
- Keep the massage chair free of dust.
- Cover the chair with dust-free cloth to prevent dust from collecting. Do not store in a hot, humid, damp place or in direct sunlight or heat. Do not store in an overly cold places.

MAINTENANCE

Before cleaning, unplug from electrical source to avoid shock.

Synthetic leather

General cleaning

Clean with tidy, soft and dry cloth. (Chemical or medical cleaning products are forbidden)



If Synthetic leather is dirty

- Dip soft cloth into 3-5% neutral detergent solution, squeeze it then clean the stain on the surface gently.
- Wash cloth, squeeze it and wipe with detergent.
- Clean it softly with dry cloth.
- Allow to dry, do not blow dry.



Fabric material

- Dip cloth into weak neutral detergent, squeeze it and clean the material surface. (Diluent, gas, alcohol are prohibited)
- Brush the dirty parts tm with weak neutral detergent. (avoid excessive brushing)
- Excessive cleaning may cause damage to cloth material.
- Wipe with water-dipped but squeezed cloth.
- Allow to dry.



Plastic parts

- Dip cloth into neutral detergent, squeeze it and clean.
- Wipe with water-dipped but squeezed cloth.
- Allow to dry.



Clean the controller

- Wipe with soft cloth after squeezing.
- Allow to dry.
- Propellant, diluent or alcohol are prohibited.



About cleaning

- Before cleaning, unplug the electricity, don' t touch the plug with wet hands.
- Make sure hands are dry when plugging to the socket.
- Fail to follow these instructions may cause user to experience electric shock.

8 TROUBLESHOOTING GUIDE

KIND REMINDER

Please always check if the following phenomenons exist:

- If there is scorched smell
- If the power supply cord gets hot
- When touch the wire, the power is on, but sometimes off
- Other abnormal phenomenons
- If any of the above happens, please turn off power supply and contact the distributor or manufacturer for assistance.

TROUBLESHOOTING GUIDE

Problems/Issues	Possible Cause	Troubleshooting
Sounds like tapping or hum sounds	Sounds from air pump, motor or other mechanical parts.	Normal phenomenon.
Sound suddenly becomes much louder while working	Check if it is due to long time working.	Turn off the power to have the massager rest for over half an hour before next turn working.
	Inner parts worn out from long use.	Please contact professional technician.
Abnormal sounds suddenly while working	Overworking the massage chair.	Cut down usage.
		Contact professional technician.

Problems/Issues	Possible Cause	Troubleshooting
Suddenly stops working	Bad power connection	Unplug and reinsert power cord to the chair.
	Auto program timers is up	Normal. Turn off the power to have the massager rest for over half an hour before next turn working.
Does not work after power up	Power switch is not turned on.	Turn power switch on.
	Bad connection between plug and socket.	Connection power cord again.
	Massage remote is not turned on.	Press power button on the remote.
	Have broken power wire plug.	Contact professional technician.
	Bad fuse.	Replace fuse.
	Control unit for functioning properly.	Contact professional technician.
Roller height changes	Rollers work alternately.	Normal phenomenon.
Cannot recline the chair	Obstruction-be sure that the chair is allowed enough room to fully recline.	Stop chair operation, and move obstruction.
		Contact professional technician.

Problems/Issues	Possible Cause	Troubleshooting
Neither the backrest nor the legrest can move	Check if there are any obstacles; the chair has safety functions that will shut it down if there is an object blocking normal function.	Remove the obstacles; turn off the power to have the massager rest for over half an hour before next turn working.
		Contact professional technician.
Cannot restore position after reclined	Excessive operation; Problem on electric motion pole or plug under bad connection.	Contact professional technician.
Does not work after power up	It may have overload.	Turn off the power to have the massager rest for over half an hour before next round working.
	Other abnormal case.	Contact professional technician.
<p>For other issues, please turn off power supply and contact the professional technician for assistance.</p> <p>Note: Do not dismantle the produce by yourself, Mynta shall hold no responsibility to the damage of the product or the inquiry of people caused by improper use.</p>		

9 PRODUCT SPECIFICATION

Description	Massage Chair
Model	MC3100
Rated Input	120V~ 60Hz
Rated Power	150W
Rated Working Time	Approx. 15 minutes (automatic power-off)
Dimension(HxWxL)	Upright 57 x 30 x 48 inches
	Reclined 68.1 x 30 x 40.2 inches
Dimensions of packing box(HxWxL)	58.3 x 32 x 35 inches
Net Weight	198.4 lbs
Gross Weight	227.1 lbs
Operating Conditions	Ambient temperature: Approx. 0°C-35°C
	Relative humidity: Approx. 20%-80%
Storage Conditions	Ambient temperature: Approx. -5°C-35°C
	Relative humidity: Approx. 20%-80%
Maximum body weight of user	Approx. 260lb For a user heavier than 260lb, the product may have bigger noise and its fabric may be worn quicker.

Mynta
www.hellomynt.com

Note:

This equipment has been tested and found to comply with the limits for a Class B digital device pursuant to part 15 of the FCC Rules. These limits are designed to provide reasonable protection against harmful interference in a residential installation. This equipment generates, uses and can radiate radio frequency energy and, if not installed and used in accordance with the instructions, may cause harmful interference to radio communications.

However, there is no guarantee that interference will not occur in a particular installation. If this equipment does cause harmful interference to radio or television reception, which can be determined by turning the equipment off and on, the user is encouraged to try to correct the interference by one or more of the following measures:

- Reorient or relocate the receiving antenna.
- Increase the separation between the equipment and receiver.
- Connect the equipment into an outlet on a circuit different from that to which the receiver is connected.
- Consult the dealer or an experienced radio/TV technician for help.

10 FCC STATEMENT

FCC STATEMENT

Any changes or modifications not expressly approved by the party responsible for compliance could void the user's authority to operate the equipment. This device complies with part 15 of the FCC Rules. Operation is subject to the following two conditions:

- This device may not cause harmful interference, and
- This device must accept any interference received, including interference that may cause undesired operation.

EXPOSE STATEMENT

FCC Radiation Exposure Statement:

This equipment complies with FCC radiation exposure limits set forth for an uncontrolled environment. This equipment should be installed and operated with minimum distance 20cm between the radiator& your body.