

DK2.0 UWB Antenna Measurement

| | |
|--------------------|---------------------|
| <i>Application</i> | <i>UWB</i> |
| <i>Date</i> | <i>2022. 06. 02</i> |

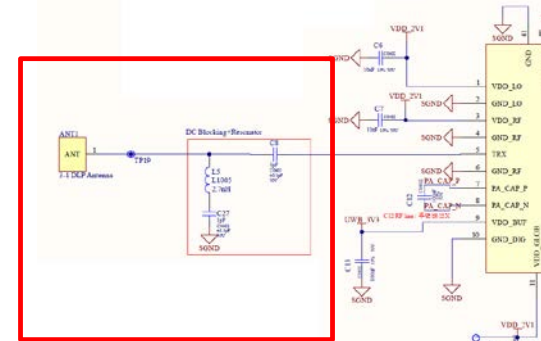

| Frequency Range | Ant. Gain | |
|-----------------|--------------|-------------|
| | Avg. Gain | Peak Gain |
| 1GHz | -28.70 | -22.10 |
| 2GHz | -15.00 | -10.10 |
| 3GHz | -13.50 | -8.66 |
| 4GHz | -11.30 | -5.57 |
| 5GHz | -10.80 | -5.13 |
| 6GHz | -4.82 | -1.96 |
| 6.5GHz | -1.39 | 3.17 |
| 7GHz | -1.79 | 3.06 |
| 8GHz | -1.38 | 3.30 |
| 9GHz | -7.49 | -2.91 |
| 10GHz | -12.10 | -7.58 |
| 11GHz | -16.30 | -9.42 |
| 15.975GHz | - | -11.31 |

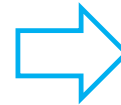
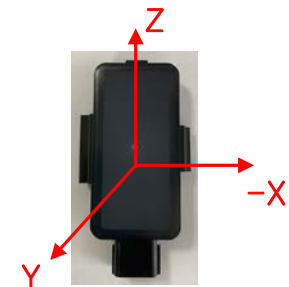

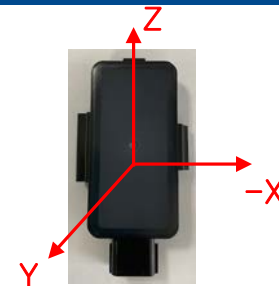

1GHz

2GHz

3GHz

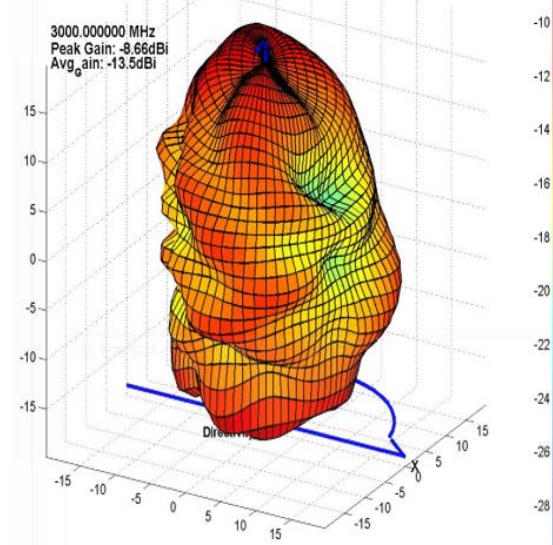
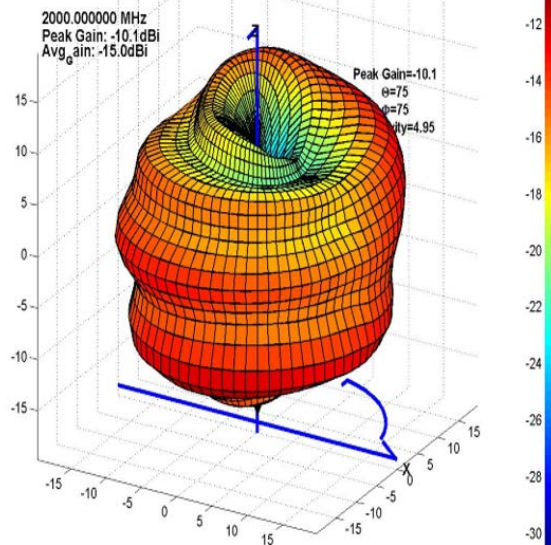
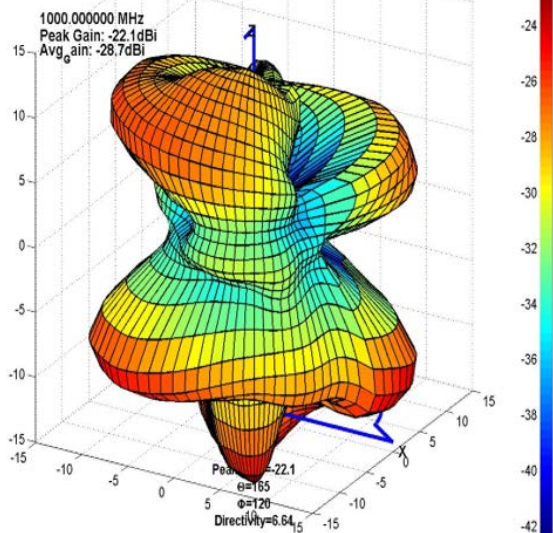

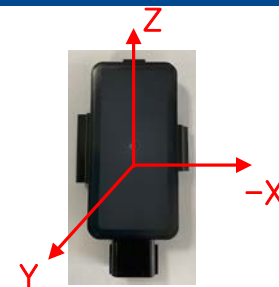

4GHz

5GHz

6GHz

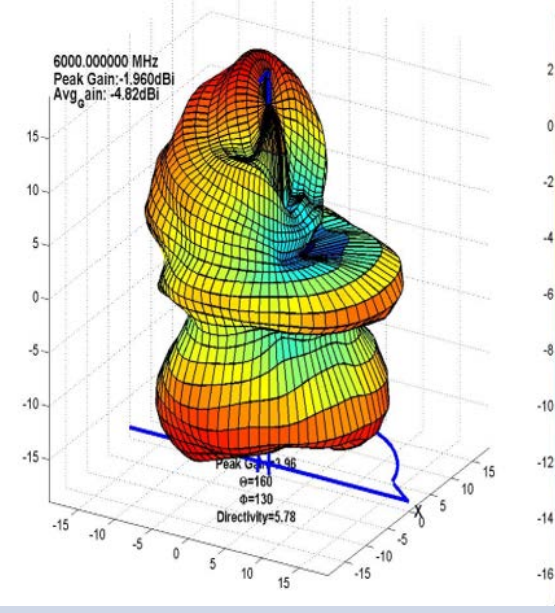
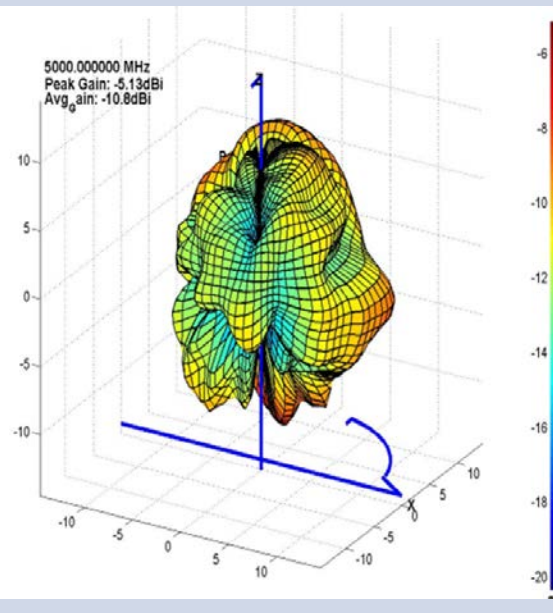
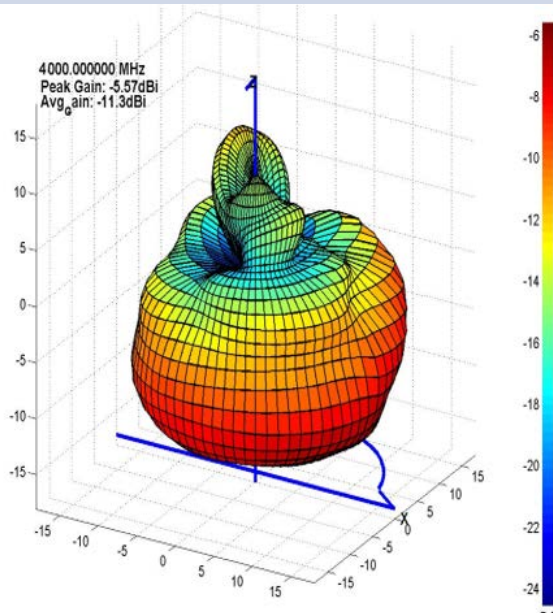

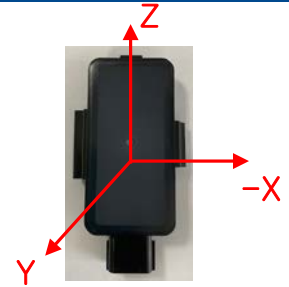

6.5GHz

7GHz

8GHz

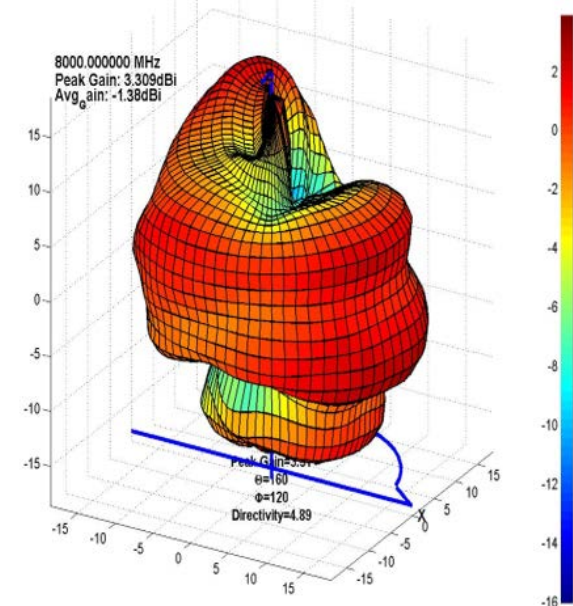
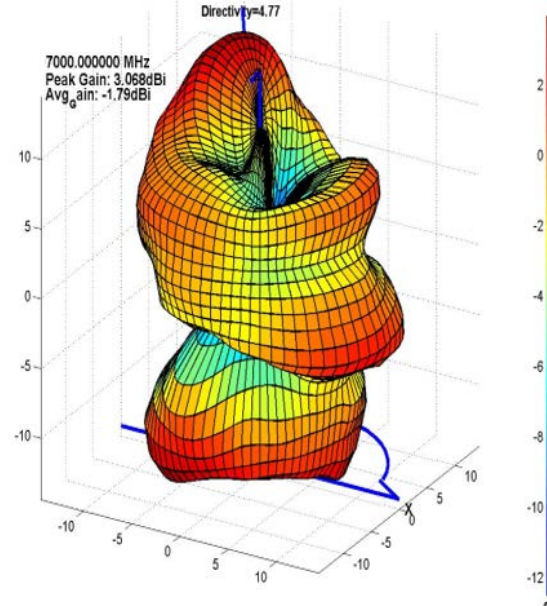
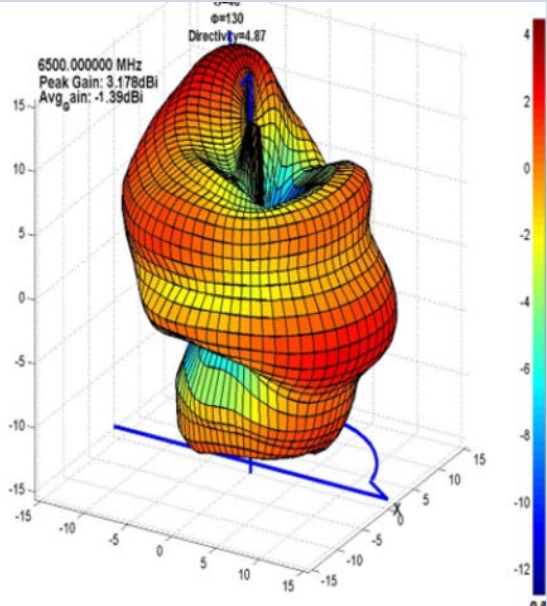

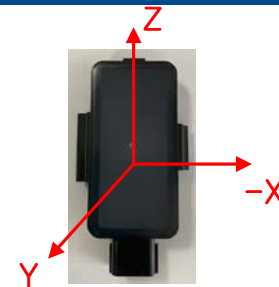

9GHz

10GHz

11GHz

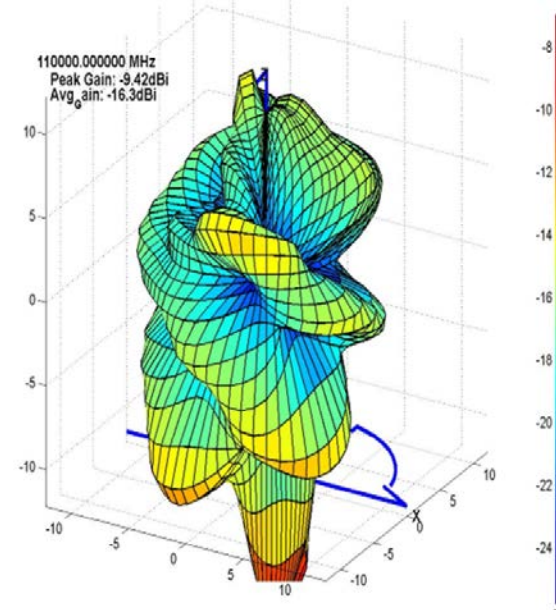
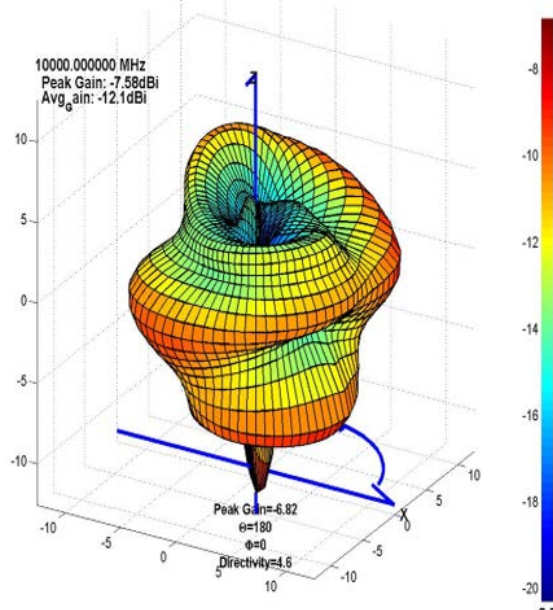
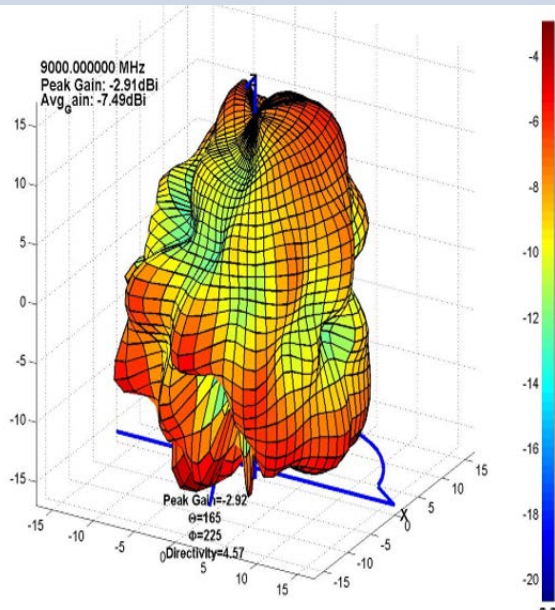

15.975GHz

ZX-Plane

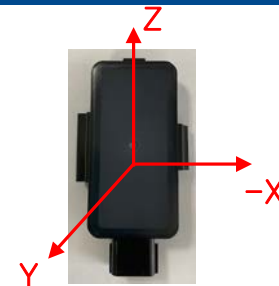

Frequency : Gain_15.975GHz

| | | |
|----------|--------|-----|
| Max Gain | -15.02 | dBi |
|----------|--------|-----|

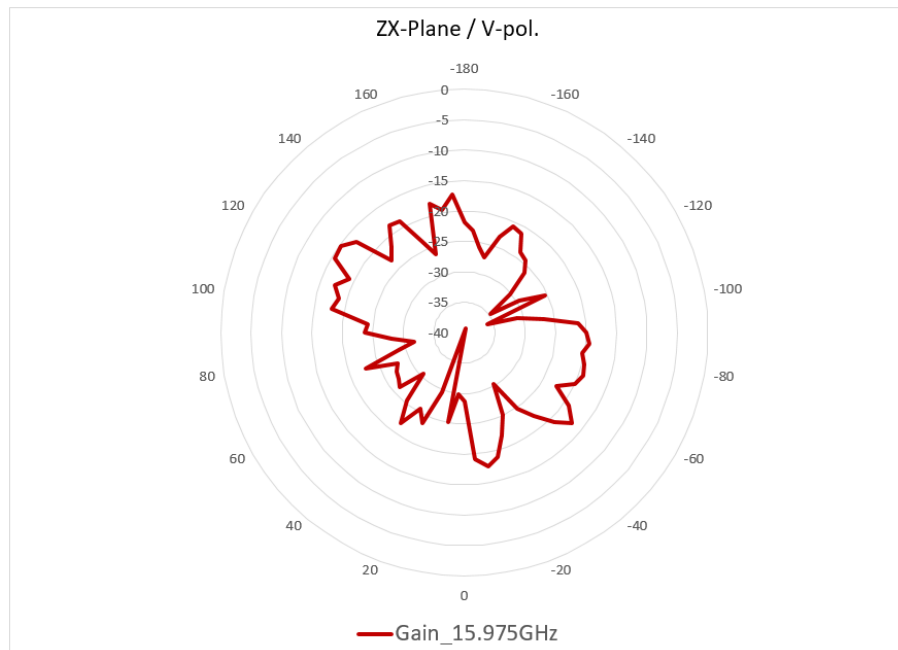

Frequency : Gain_15.975GHz

| | | |
|----------|--------|-----|
| Max Gain | -13.24 | dBi |
|----------|--------|-----|

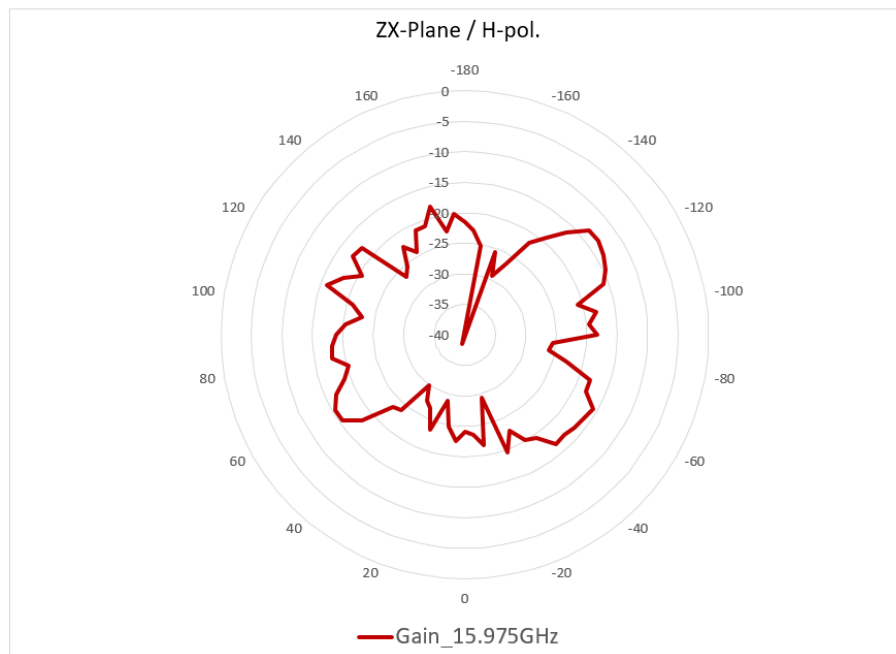

15.975GHz

ZY-Plane

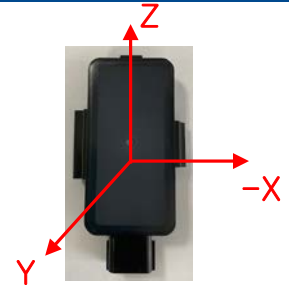

Frequency : Gain_15.975GHz

| | | |
|----------|--------|-----|
| Max Gain | -11.31 | dBi |
|----------|--------|-----|

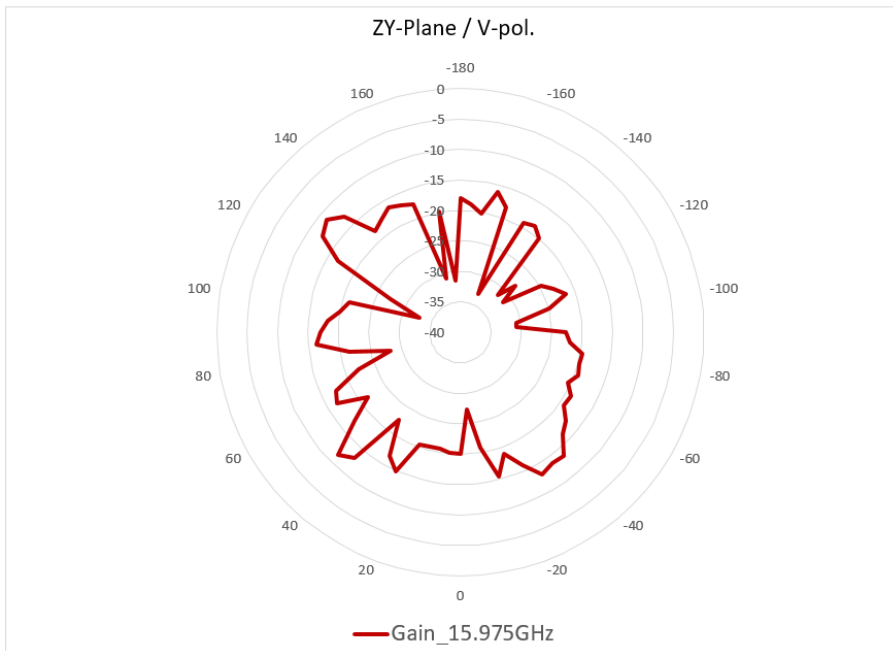

Frequency : Gain_15.975GHz

| | | |
|----------|--------|-----|
| Max Gain | -13.58 | dBi |
|----------|--------|-----|

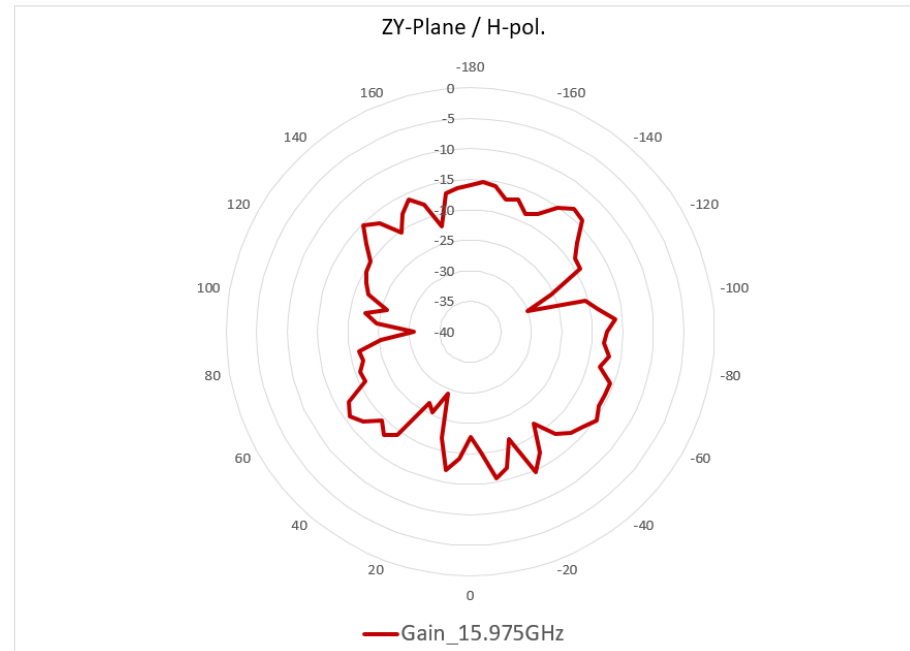

15.975GHz

ZX-Plane

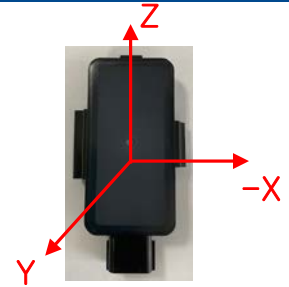

Frequency : Gain_15.975GHz

| | | |
|----------|--------|-----|
| Max Gain | -15.02 | dBi |
|----------|--------|-----|

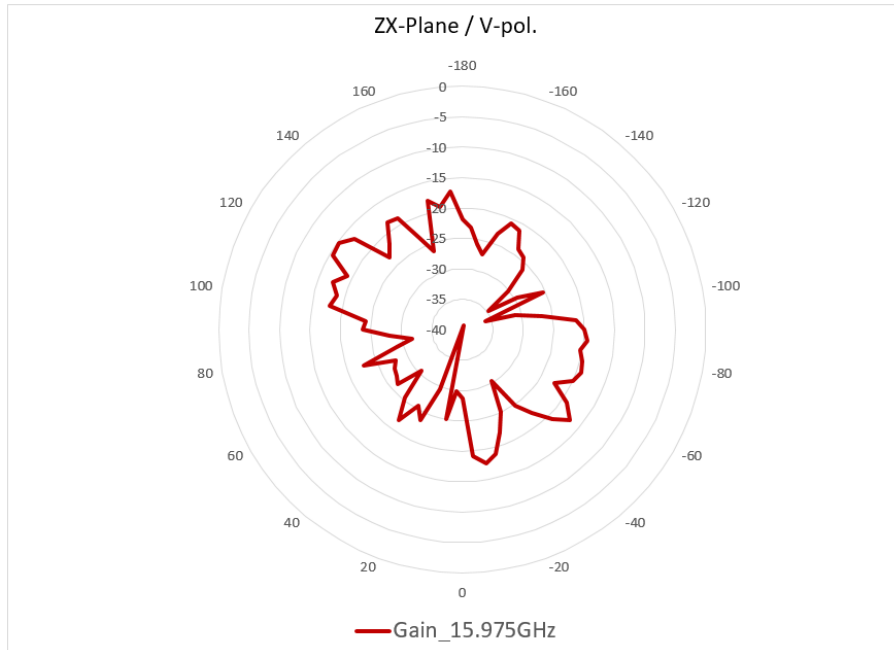

Frequency : Gain_15.975GHz

| | | |
|----------|--------|-----|
| Max Gain | -13.24 | dBi |
|----------|--------|-----|

